

WOOD PROJECTS

FOR ILLINOIS WILDLIFE

Homes and Feeders
for Birds and Mammals

Illinois Department of Natural Resources
Division of Natural Heritage

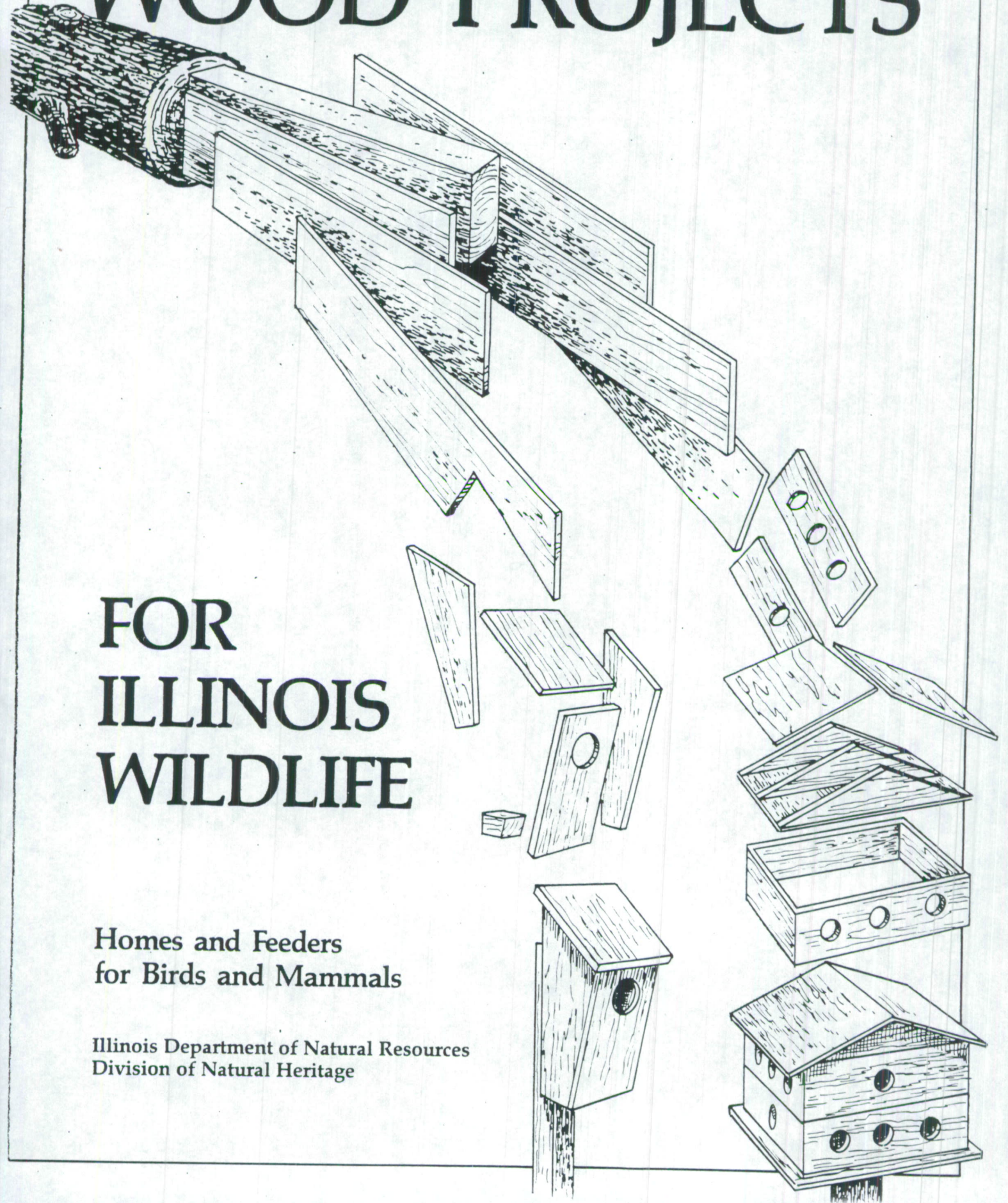

WOOD PROJECTS FOR ILLINOIS WILDLIFE

Homes and Feeders for Birds and Mammals

Houses, Platforms, and Artwork reprinted from
Woodworking for Wildlife, Minnesota DNR.

Drawings, Feeders, and Feeding Guide provided by the
Illinois Department of Natural Resources and
U.S. Fish and Wildlife Service.

This publication was made possible by donations to the
Illinois Wildlife Preservation Fund.

DISCLAIMER: The use of trade names or references to specific companies or products in this publication does not imply endorsement by the Department of Natural Resources. They are included only as an aid to the reader.

TABLE OF CONTENTS

	Page
Introduction	1
General Building Instructions	2
Part 1 — Nest Boxes and Platforms for Use in Backyards and Small Deciduous Woodlots	
House Wren	4
White-breasted Nuthatch	4
Black-capped Chickadee	4
Carolina Chickadee	4
Prairie Deer Mouse	4
White-footed Mouse	4
Tree Swallow	7
Eastern Bluebird	7-9
American Robin	10
Barn Swallow	10
Eastern Phoebe	10
Purple Martin	12
Northern Flicker	14
Bat House	16
American Kestrel	18
Part 2 — Nest Boxes and Platforms for Use in Deciduous Forests and Bottomlands	
Prothonotary Warbler	4
Great Crested Flycatcher	8
Eastern Screech-owl	18
Southern Flying Squirrel	18
Barred Owl	20
Pileated Woodpecker	22
Fox and Gray Squirrel	22
Raccoon	22
Wood Duck	22
Hooded Merganser	22
Entrance Hole Guide for Songbirds, Woodpecker and Squirrel Nest Boxes	26
Entrance Hole Guide for Duck, Merganser and Raccoon Nest Boxes	25
Part 3 — Guide to Backyard Bird Feeding and Bird Feeders	
Guide to Attracting and Feeding Wildlife	27
Revolving Feeder	29
Hanging Feeder	31
Squirrel Guards	32
Additional Readings	33

INTRODUCTION

Wood Projects for Illinois Wildlife is designed for the person who enjoys making things that will enhance wildlife in his/her backyard or back forty.

As Illinois' natural areas are lost to competing interests such as urban development, agricultural and industrial uses, and as exotic species continue to invade, the role of individual landowners becomes increasingly important to wildlife managers. By providing nest boxes, especially in areas that lack large, old, hollow trees for nesting, wildlife enthusiasts can provide animals with safe, suitable homes and help reduce competition with exotic species such as the house sparrow and the European starling.

Each nest box in this booklet may attract and support a variety of animals; however, many of the structures simulate a hole in a tree and will most likely be inhabited by cavity dwellers such as the bluebird, chickadee, squirrel, etc. Also the boxes are designed to help lessen competition with exotic species by specifying smaller holes suitable only for native wildlife.

Please remember that building to specifications, proper placement, and continuous maintenance are necessary to insure healthy and safe conditions. If they are not, the boxes may turn into sparrow slums, remain unused, or actually become death traps to nesting birds and mammals.

To use this booklet, review the General Building Instructions and three main parts. The first two parts provide instructions for nest boxes. The third part contains information about wildlife feeders. Part One includes

houses and platforms that are appropriate in backyards, farmsteads, shelterbelts, pastures, and small woodlots of deciduous forests (hardwoods). Part Two includes houses for use in more extensive upland and bottomland forests. To simplify matters, a brief description of possible nest box inhabitants may be found opposite of the instructions. This will help you to be more accurate in determining the specific needs of the animal(s) you wish to attract.

Part Three of the booklet is concerned with feeding birds and mammals and is intended to help you attract many species, particularly in the winter. Depending on your surrounding environment, chickadees, grosbeaks, goldfinch, quail, deer, squirrels, and many others may appear at your feeder. BUT, if you choose to make feeders, it is MOST IMPORTANT that you remember, once winter feeding starts, BIRDS BECOME DEPENDENT on that supply for the ENTIRE winter. A feeder should NEVER remain empty for more than a few hours, especially during severe weather.

The houses, platforms, and feeders have been simplified to the greatest extent possible. Right-angle cuts are often used and many patterns require only one board. Therefore, building nest boxes and feeders can be wonderful activities for scouts, sportsmen, 4-H clubs, school shop classes, and anyone who enjoys wood projects and wildlife.

We hope you enjoy this booklet and are able to spend many hours watching Illinois birds and mammals. Thank you for helping to restore Illinois' Natural Heritage!

General House and Platform Instructions

Birds and mammals need different kinds of houses or platforms in different habitats. These general instructions will help you build and place houses and platforms for the most popular occupants of wildlife homes in Illinois.

These general instructions apply to all plans:

1. The instructions point out that one box may be used by many animals, but **DO NOT** make a box for "birds" or "mammals." Build it for a *specific* kind of bird or mammal. Different species have different house size, entrance hole, and habitat requirements.

2. Provide a hinged side or roof so houses can easily be checked and cleaned out each year. Hinges should be rustproof. Duck and owl box roofs kept shut with a hook and eye can be opened by raccoons. It is much better to use several paired roofing nails with large heads on the side of the roof and on the upper edge of the side. Wire these paired nails together.

3. At least four 1/4-inch diameter drain holes should be drilled in the bottom of every house, except the Peterson bluebird house. The sloping floor and space that allows the swing-door front to open provide for drainage on that house.

4. Although wren houses can be suspended from an anchor point **under an eave or tree limb**, all other houses should be firmly attached to a support post, building, or tree. When you attach a nest box to a live tree use lag screws and washers. Then, as years pass, gradually unscrew them to allow for growth of the tree. Or, use a tree guard as shown on page 32. Do not place bluebird houses on trees because that invites competition from too many other species.

5. **Don't put perches on any bird houses.** Only house sparrows and European starlings prefer perches. If you have a house with a perch, remove the perch. A slab of wood with the bark attached may be placed horizontally under the entrance of a wood duck or hooded merganser entrance hole to make it easier for landing at the entrance.

6. The top-front edge of a bird house should overhang at least two inches to help protect the entrance hole from wind-driven rain and to keep cats from reaching in from above.

7. At least two 1/4-inch holes should be drilled near the top of the right and left sides of all bird houses — except duck boxes — to provide ventilation. Providing adequate ventilation is very important for small bird houses.

8. Use galvanized nails to build houses if necessary, but remember that they loosen up as wood expands and contracts in Illinois' extreme weather conditions. Cedar and red-

wood nest boxes should probably be made with concrete coated or ring shank nails. They won't allow the boards to loosen up.

9. The sides of a bird house should enclose the floorboard — don't nail them to the top of the floorboard. This keeps rain from seeping into the crack between sides and floor and then into the nest. Recess the floorboard 1/4 inch up from the bottom of the sides to help prevent deterioration caused by moisture. This prevents rain from seeping across the bottom of the floor and then seeping up from below.

10. **Do not use tin cans, milk cartons, or metal for nests.** Metals heat up in direct sun, overheat the eggs, and kill the young. However, commercial martin houses made from aluminum are acceptable. Commercial plastic wood duck houses are also acceptable but should be placed in shady locations.

11. Wood is the best all-around material for houses. Three-quarter-inch thick boards are the easiest to work with. Softwood such as pine is fine for smaller nests, but cedar, redwood, or cypress may be used for larger boxes. Pine or plywood can be used for duck boxes if they are treated on the outside of the box with wood preservative. **Do not use wood treated with green preservative.** The green copper-based preservative, when exposed to water, can produce poisonous vapors. A well-constructed house should last 10 to 15 years. Large boxes like duck boxes can be painted with wood preservative on the outside to extend their usefulness. The back should be coated several times because it is most prone to rotting. **Do not paint, stain, or treat a box with creosote.**

12. Purple martins, mergansers, and wood ducks do not defend territories around their nests. Therefore, martins should be provided with "apartment type" houses. Duck and merganser boxes can be clustered in groups of two or four. Houses for other bird species should be spaced apart to reduce territorial conflicts. Bluebird houses need 100-yard spacing.

13. Small animals may take up residence in bird houses, including mice, squirrels, bees, and wasps. If not acceptable, remove the nests. Otherwise, you will probably need to put up additional houses to accommodate both the unexpected tenants and the desired wildlife species.

14. If wasps take over a house, remove the wasp nest and spray the interior with a disinfectant like Lysol. Use extreme caution to avoid being stung. A can of aerosol insecticide may be necessary during this process for "self-defense." If an ant colony becomes established, place a commercial ant killer like Terro in an upside down pop bottle cap under the nest.

15. Blowfly eggs and larvae will sometimes

become established in a bluebird nest. The larvae will suck blood from the young birds. If this occurs, lift up the nest with your fingers and gently tap the nest. The larvae will fall through the nest and can be removed from the bottom of the box.

16. Whenever house sparrows or European starlings begin nesting in a bird house, tear out the nest and eggs as they are not protected by state or federal law. Nests may need to be removed five or six times before the birds finally abandon the house. Sparrow nests are typically characterized by a messy structure of grass, assorted litter, and garbage, and their eggs are white speckled with brown. Some people prefer to minimize sparrow problems by catching and removing adult sparrows in the nest boxes. Starling nests are an untidy structure of stems and leaves, and their eggs are 30mm long, slightly glossy, and pale blue. Sparrows can be effectively controlled by using a Havahart elevator-type sparrow trap to catch them.

17. When the nesting season is over, open the front or side of a songbird house and leave it that way during the winter to prevent deer mice from nesting. **Otherwise** these mice may "defend" their box from returning songbirds in the spring by killing and eating songbirds which enter "their" box.

18. Be sure to allow for the width of the saw blade when marking a board.

19. Remember that the width and depth of lumber purchased at lumber yards is smaller than its standard description. For example, a 1" x 6" board is actually 3/4" x 5 1/2". A 2" x 4" is actually 1 1/2" x 3 1/2". The plans in this booklet utilize the actual dimension of boards to make the most efficient use of wood.

20. Sawdust may not be the best material for lining a nest box for birds of prey or waterfowl (eastern screech-owl, barred owl, American kestrel, wood duck, hooded merganser)! It tends to pack down when wetted, and tends to retain moisture. Wood chips from a chain saw seem to be a better lining. They allow for better drainage and less water retention.

21. Any birdhouse entrance hole 1 3/8 inches in diameter or larger will admit house sparrows and any entrance hole larger than 1 1/2 inches in diameter will admit European starlings. Whenever possible, the entrance hole dimensions for songbirds in this booklet are designed to exclude these pest species.

22. The actual size of entrance holes for all duck, merganser, and raccoon nest boxes are shown on page 25. The entrance holes for songbirds, woodpeckers, and squirrels are on page 26. These holes can be traced onto wood using carbon paper.

Part 1 —

Nest boxes and platforms generally for use in backyards, urban areas, farmsteads, orchards, pastures, shelterbelts, and small deciduous woodlots under five acres.



Nest Box 1

- HOUSE WREN
- BLACK-CAPPED CHICKADEE
- CAROLINA CHICKADEE
- WHITE-BREASTED NUTHATCH
- PROTHONOTARY WARBLER
- PRAIRIE DEER MOUSE
- WHITE-FOOTED MOUSE

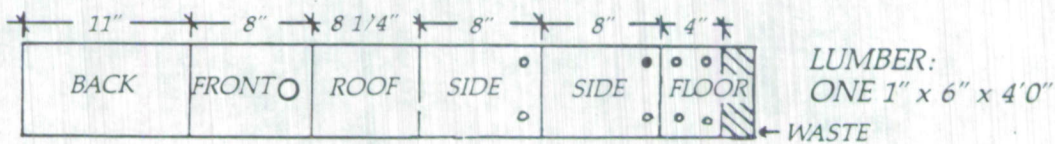
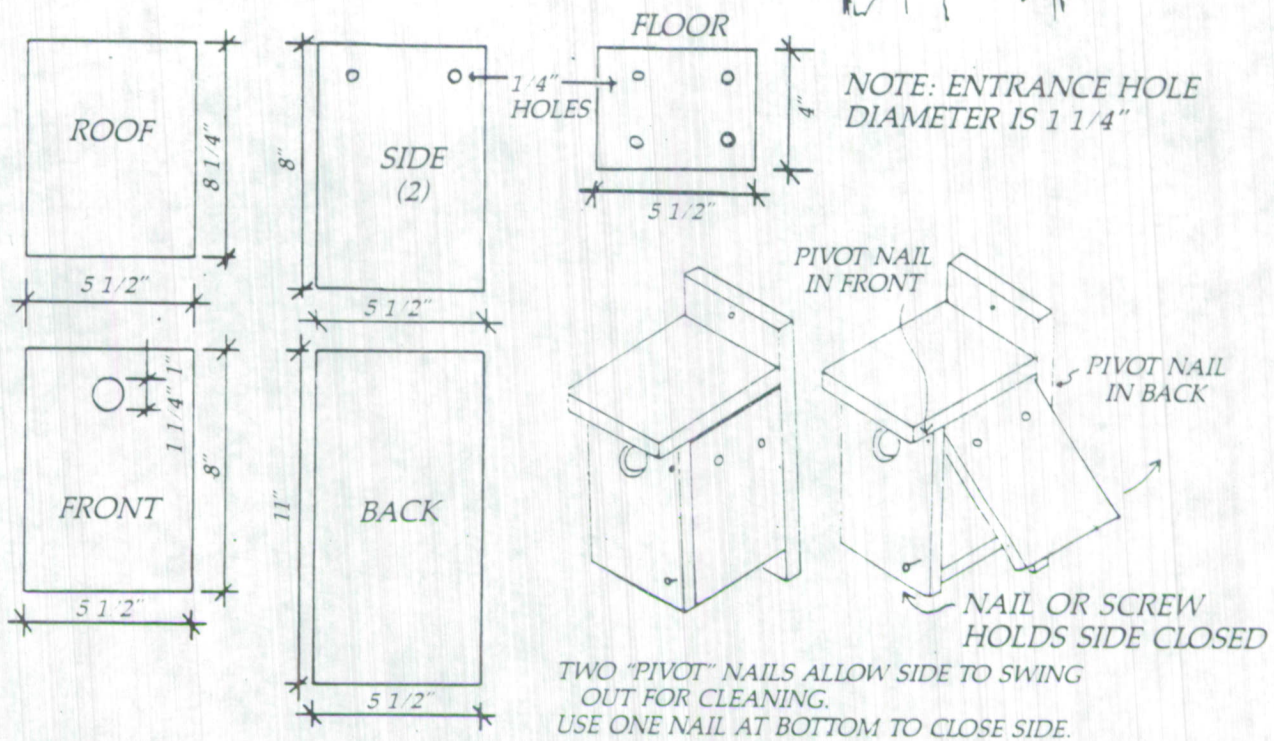

Black-capped Chickadee and Carolina Chickadee

Illinois has two species of chickadees: the black-capped, occupying the northern two-thirds of the state and the carolina, occupying the southern one-third. Many people enjoy these delightful birds at their feeders every winter but don't realize they will also nest in yards and woodlots with mature hardwood trees.

The house shown will be used by chickadees if placed in the proper habitat: either mature hardwood shelterbelts and woodlots in agricultural areas or mature hardwood forests in other parts of the state. The house should be mounted 5 to 15 feet high with 40 to 60 percent sunlight. About an inch of sawdust should be placed in the bottom of the nest box. The chickadee needs an entrance hole 1 1/8 inches in diameter. The 1 1/4-inch diameter hole shown on page 4 also allows use by wrens and nuthatches, but not house sparrows.

Prairie Deer Mouse and White-footed Mouse

The prairie deer mouse and white-footed mouse are frequent occupants of nest boxes placed for house wrens, chickadees and bluebirds. They are distinctively marked by brown or grayish backs, white bellies, long tails and very prominent eyes. While they may occasionally be a nuisance if they take up residence in a house, they are both rather appealing and interesting native mammal species found throughout Illinois.

They can be a fascinating occupant of nest boxes in their own right. Some people intentionally place nest boxes for these two native mouse species on fenceposts along fencelines near their cabins or at nature centers. A wren house as shown on page 4 is appropriate for use by these two mice. Nest boxes should be on posts about 3 or 4 feet above the ground.

As the mice raise their families they can provide a constant source of enjoyment and fascination for children who may occasionally open the side of the box and peek at the bug-eyed occupants within. Mice will winter in these boxes, so the entry hole should face the east or southeast to avoid prevailing northwest winds.



The only problem with mouse use in nest boxes is that if birds return to a songbird nest box in the spring and enter a box occupied by deer mice or white-footed mice, the mice might kill and eat the birds in order to defend "their" box. Nest boxes for house wrens, chickadees, nuthatches, tree swallows, bluebirds and other small songbirds should therefore be left open in the winter to prevent their use by wintering deer mice and white-footed mice. Boxes intended for these mice should be left closed in winter.

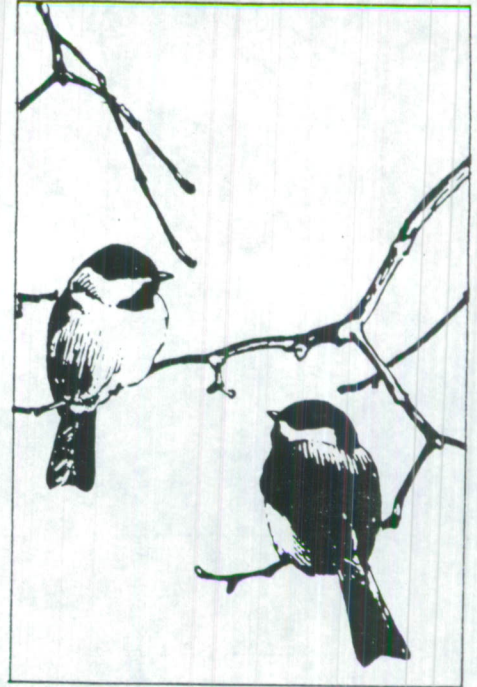

Prothonotary Warbler

The prothonotary warbler, also referred to as the golden swamp warbler, is orange-yellow with wings and tail that are slate blue. This beautiful songbird is found in bottomland hardwood forests, cypress swamps and in flooded backwater habitats that are characterized by woodland pools and oxbow ponds. Its nest is typically an abandoned downy woodpecker hole in a dead willow snag in standing water. Often the nest will be no more than 3 to 5 feet above the water level.

Most people don't realize that this beautiful woodland warbler is rather adaptable and will also use bird houses.

If you live in lowland hardwood forest habitat within the range of this warbler, try using the bird house plan on page 4. Use a 1 1/4-inch diameter hole. This will exclude use by house sparrows. Place the house on a snag or post in shallow woodland pools or in oxbow ponds of river bottom habitat, 3 to 5 feet above water level. If predator guards are used on free standing posts, nests can also be placed on adjacent shoreline habitat with the hole facing the open water. Prothonotary warblers will also nest in these bird houses if they are placed on the sides of homes or outbuildings that are near water.

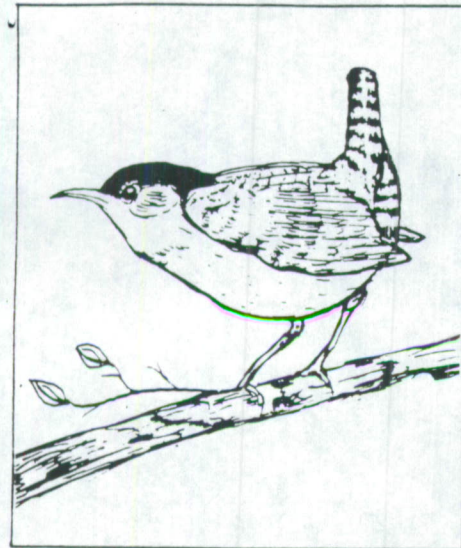

House Wren

The house wren is one of our most common and enjoyable backyard birds. Its beautiful bubbling calls are a joy to hear during the summer.

House wren boxes are likely to be used if they are 5 to 10 feet above the ground and located under the eave of a building or in a tree. This is the only kind of bird house which can be free-hanging from an eye-screw. All other bird houses need to be firmly anchored. House wren holes are too small for house sparrows or European starlings to use. Don't put a perch on the nest box. Perches invite sparrows to try using the nest. If you have a perch on a wren house, take it off.

The entrance hole for a wren house should be 1-inch in diameter. The 1 1/4-inch hole size shown on page 4 also allows use by chickadees and nuthatches, but not house sparrows.

House wrens generally nest in wooded, shrubby habitats. Their nests are characterized by twigs and the six to eight eggs are finely speckled with reddish spots. Sometimes wrens will take over the nest of a tree swallow or eastern bluebird after puncturing the eggs of the other birds with their bills.

As soon as one family of wrens leaves a house, clean it out so another brood of young ones can be raised.

White-breasted Nuthatch

The white-breasted nuthatch is also well-known at winter bird feeders as it hangs upside down to eat suet and probe for insect larvae under the bark of trees. It will also nest in mature hardwood forests in habitat similar to that used for chickadees.

As soon as each brood of young leaves the nest box, clean it out so more birds can use it. Nuthatches need an entrance hole 1 1/4 inches in diameter. This allows use by house wrens and black-capped chickadees, but not house sparrows. Houses should be about 12 to 20 feet above the ground.



Nest Box 2

TREE SWALLOW

EASTERN BLUEBIRD

GREAT CRESTED FLYCATHCER

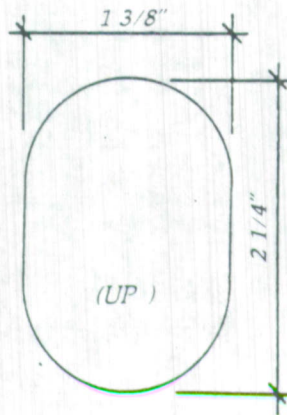

NOTE: ENTRANCE HOLE FOR GREAT CRESTED FLYCATHCER SHOULD BE A ROUND HOLE 1 3/4" IN DIAMETER.

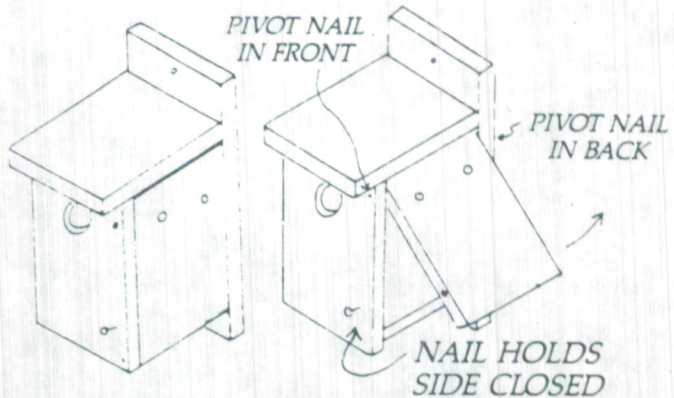
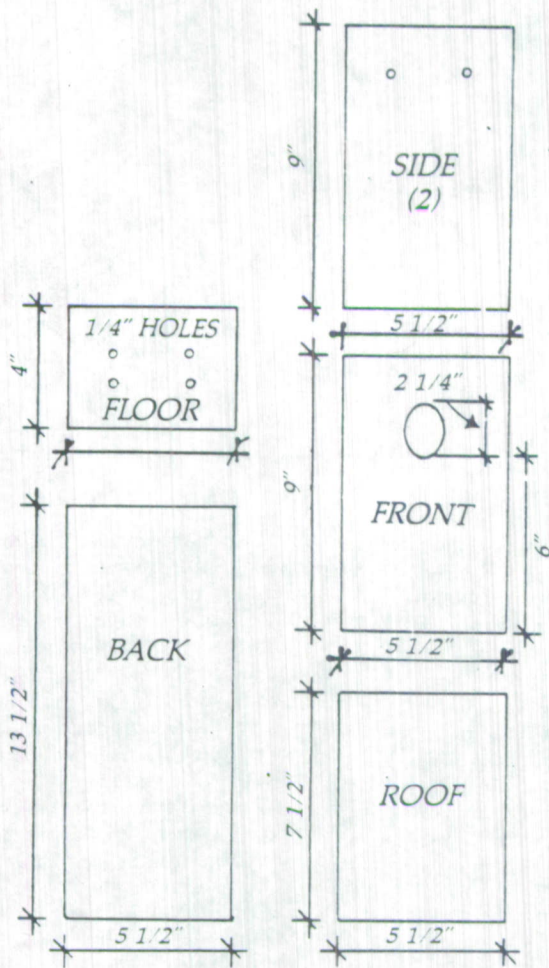

TWO "PIVOT" NAILS ALLOW SIDE TO SWING OUT FOR CLEANING. USE ONE NAIL AT BOTTOM TO CLOSE SIDE.

LUMBER:
ONE 1" x 6" x 6"

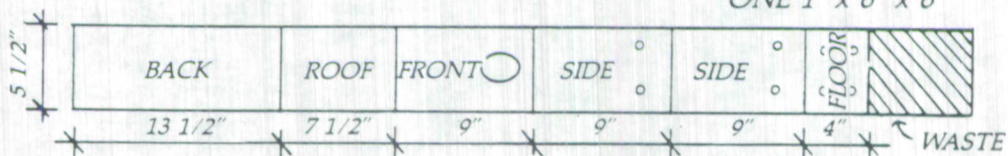

Tree Swallow

The tree swallow has a snow white breast and beautiful iridescent greenish-black back. It eats flying insects, and nests in all three types of bluebird houses described in the following accounts.

Tree swallows and eastern bluebirds often nest in the same areas. Quite often, however, tree swallows can be attracted to nest boxes in very open farm country that is unsuitable for bluebirds. Nest boxes can be spaced 25 yards apart and they have a definite preference for east facing entrance holes. The nest boxes should be about 4 feet above the ground. Tree swallows are especially abundant near water.

Their nests are often characterized by a feather lining. The eggs are white. The houses should be ready by May 1 and should be cleaned out as soon as the young leave. They generally nest only once each year, but cleaning out the box helps make room for a second brood of bluebirds.



Great Crested Flycatcher

This fascinating songbird of our hardwood forests, orchards and parks is grayish above with a yellowish breast. It is more often heard than seen. The call is an ascending loud whistle "Wheeeep!" The nests are often characterized by the presence of shed snakeskins which have been placed there by the flycatchers. The bulky nest also includes twigs, leaves, hair, feathers and bark fibers.

Great crested flycatchers will use the one-board bluebird house on page 6, except that the entrance hole should be 1 3/4 inches in diameter. Chances of use are best if house is placed from 10 to 20 feet high.

Newly-fledged flycatchers are a real treat to see. They cling to the side of trees like fuzzy little woodpeckers.

EASTERN BLUEBIRD NESTING POST

Eastern bluebirds are described extensively on page 9, but one additional nest structure for bluebirds is the nesting post shown here.

It consists of a 9-inch deep cavity drilled into 6-inch diameter fence posts. The hole is 3 5/8 inches in diameter. A Milwaukee drill bit and extension shaft are used on a heavy duty Milwaukee drill to make the cavity. Electricity in the field is provided by a gasoline-powered generator and extension cord, or posts can be drilled in a shop before installation. This type of house is especially desirable in county parks, wildlife management areas and roadside rights-of-way where traditional box type houses are sometimes vandalized. The nesting posts are very inconspicuous. They can be free standing with predator guards or they can be part of functional sign posts or fence lines. The posts may be treated or untreated cedar.

Nesting posts are constructed in five steps. First, an entrance hole is drilled which is 1 3/8 inches wide and 2 1/4 inches high. This is done by drilling two overlapping holes with a 1 3/8-inch bit. Second, the main cavity is drilled to a depth of 9 inches. Don't straddle the barbed-wire fence when drilling this hole. Third, four 1/4-inch diameter holes are drilled for ventilation. Fourth, four 1/4-inch diameter holes are drilled into the base of the cavity from the outside to allow for water drainage. Fifth, an 8" x 8" piece of plywood or treated pine board is screwed onto the top of the post. Hardware cloth can be used to cover the top of the post if sparrow use is a problem. The open top may discourage sparrow use. The nests are checked by removing the top and old nests are easily removed from above.

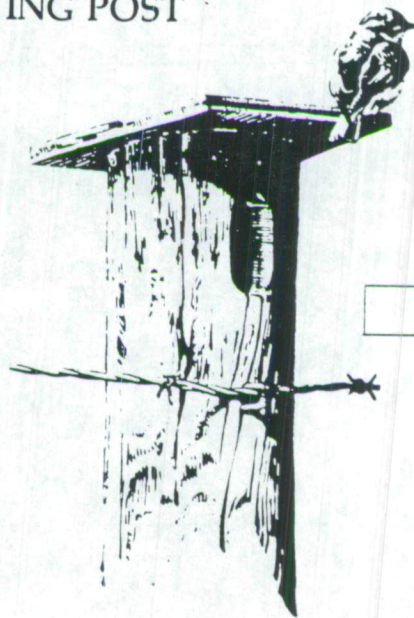

1. USE A 6" DIAMETER POST; NO BIG KNOTS.
2. DRILL ENTRY HOLE (TWO 1 3/8" HOLES).
3. BORE MAIN POST CAVITY 3 5/8" DIAMETER, 9" DEEP.
4. BORE FOUR 1/4" DRAINAGE HOLES AND FOUR 1/4" VENTILATION HOLES.
5. SCREW TOP ONTO POST.

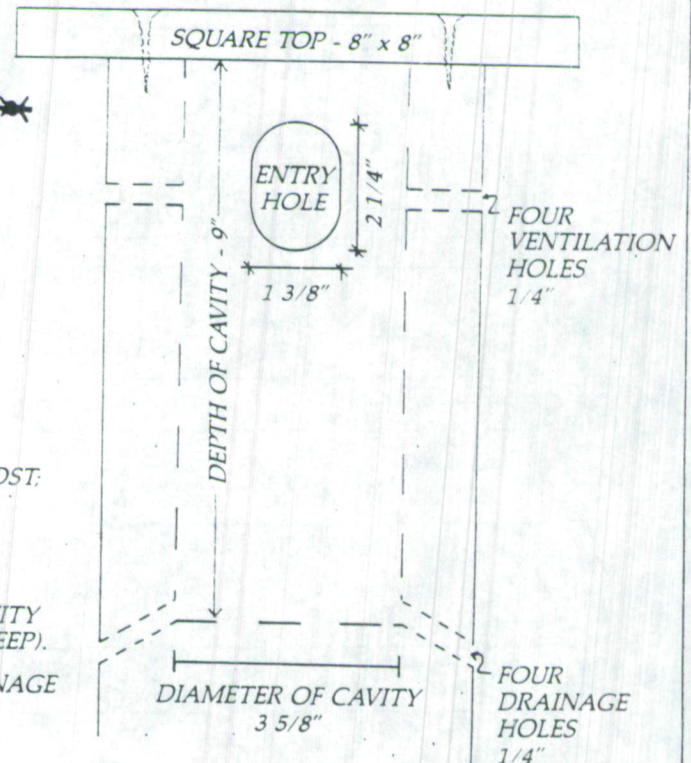

Nest Box 3

Peterson Bluebird House

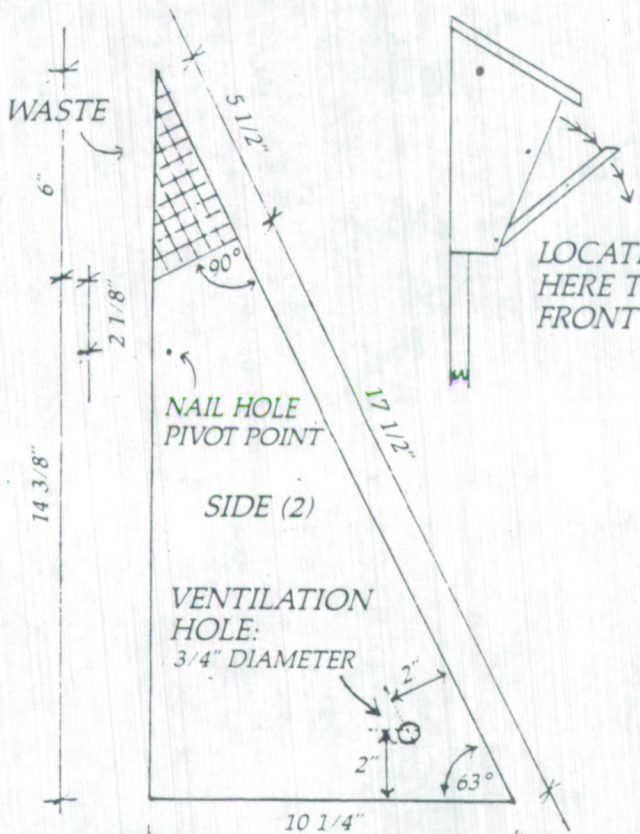

LOCATE ONE NAIL
HERE TO HOLD
FRONT UP

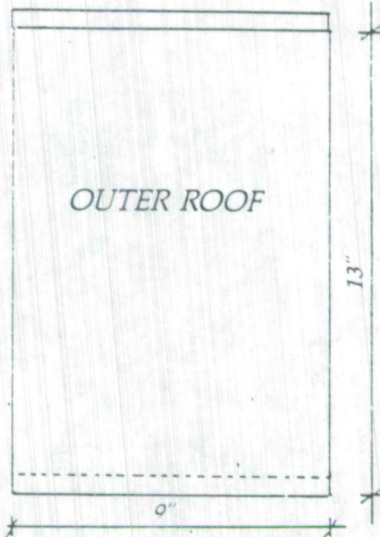
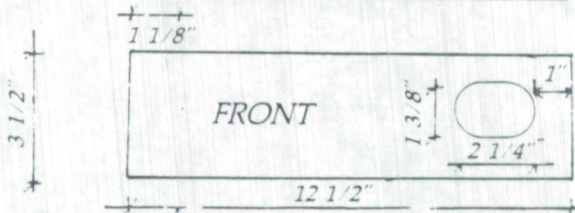
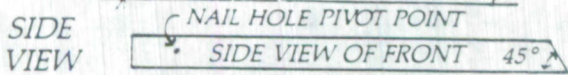
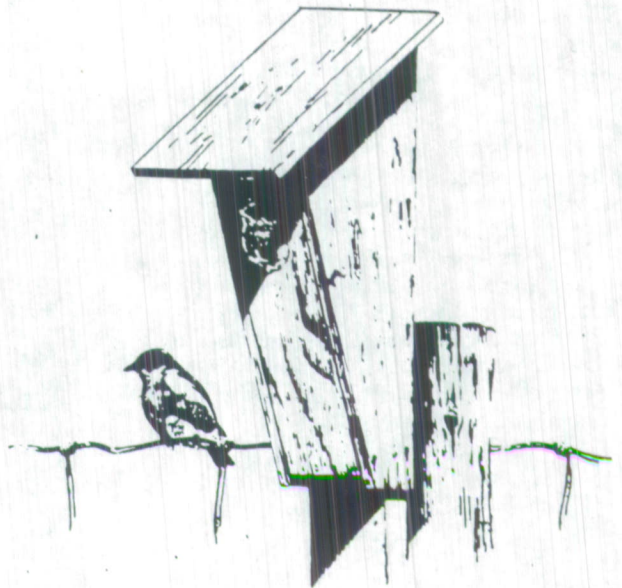

EXPANDED
VIEW

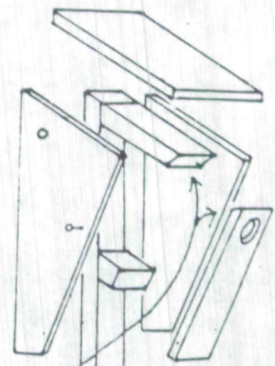

ALLOW A 5/8" GAP
BETWEEN THE TOP OF
THE FRONT AND THE
INNER ROOF

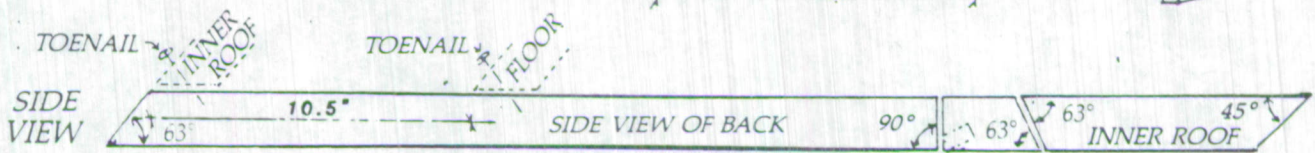

BOTH OF THESE EDGES ARE TO-NAILED TO BACK

HOLE FOR ANT KILLER: 3/8" DIAMETER X 1 INCH DEEP

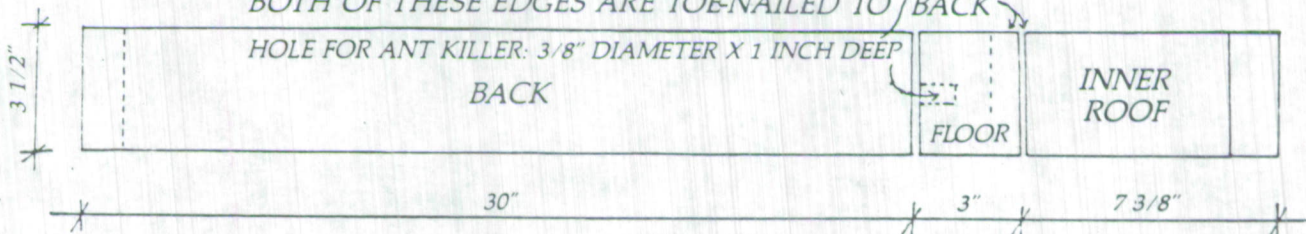

Eastern Bluebird

Eastern bluebirds are one of the most popular songbirds in Illinois. Their brilliant blue colors, delightful calls, clean habits and family devotion have long provided happiness and inspiration to people.

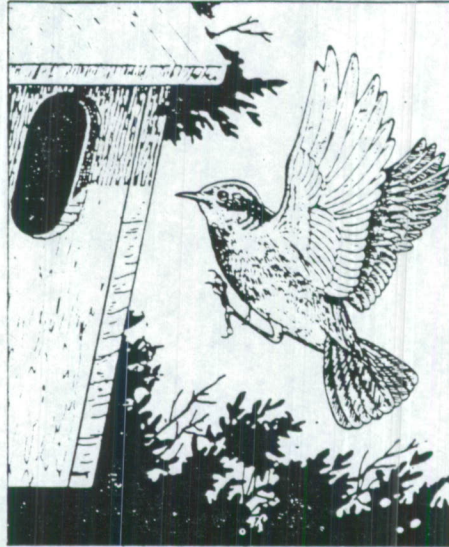

Ideal bluebird habitat is comprised of mixed hardwood forests and grasslands. The grassy areas may be either meadows, pastures, yards, cemeteries, highway rights-of-way or prairies. It is best if the grass is short or sparse. Mowed or grazed areas provide good habitat. There should be either power lines, fenceposts or scattered trees in grassy areas to provide feeding perches. Bluebirds will sometimes nest in the backyards of homes in rural areas or on the fringe of urban areas. Normally they nest in rural areas away from farmstead sites, however, because competition with house sparrows is usually too great near farmsteads.

Bluebird nests are neat, cup-shaped structures made of fine grass. Usually there are five pale blue eggs in a clutch.

The Peterson bluebird house is the best type of bluebird house. It is relatively safe for bluebirds and is easily checked and cleaned.

The seven parts of this house are assembled in this order: First, the inner roof is toe-nailed to the top of the back. Second, the floor is toe-nailed to the back 10 1/2 inches below the top. Third, one side is nailed to the resulting frame. Next the swing-down front is fastened by nailing one nail to each side of the base. A third nail is pounded part-way into the side near the entrance hole. This is pulled out each time the house is checked. This top serves primarily as a cat guard. A one-board bluebird house (Box 2) is much easier to build than the Peterson house and is included here for the benefit of young people or for adults who do not have access to table saws or radial arm saws.

This type of house is more vulnerable to predation by house cats so it is best used on free-standing posts which have tin or aluminum sheets stapled around the support post. Some people feel that sparrow use in the one-board house can be diminished by cutting a 3-inch diameter hole in the roof and covering the hole with 1/4- or 1/2-inch hardware cloth mesh. Bluebirds don't seem to mind the "sun-roof" but sparrows may be discouraged by it.

Either the Peterson or one-board bluebird houses should be placed four to six feet above the ground and spaced about 100 yards apart. The entrance hole should face north, east or northeast to prevent sunlight from shining into the hole and overheating the box interior. A bluebird trail consists of five or more houses placed along a road or fenceline. The houses should be ready by late March and should be checked every week to ten days from late March until mid-August. A nest should be removed as soon as a brood leaves its nest box. This allows a second brood to be raised.

Bluebirds have responded positively to helping human hands and if you're interested in attending a workshop contact the Division of Natural Heritage in early January.

Additional nesting bluebirds structures are shown on pages 6 and 7.

Materials needed to build 10 Peterson bluebird houses

Sides

One (1) - 7/16" x 12" x 16' hardboard lap siding primed or one (1) - 1" x 12" x 16' pine

Cut into 18" pieces

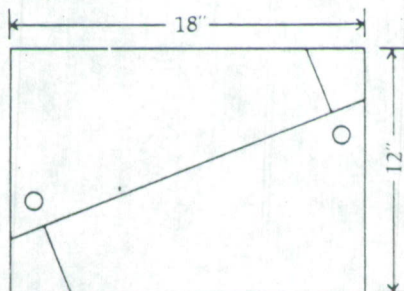

Front

One (1) - 1" x 4" 12' pine

Back, Floor & Inner Roof

34' x 2" x 4" pine

Outer Roof

One (1) - 1" x 10" x 12' pine

Nest Box 4

AMERICAN ROBIN
 BARN SWALLOW
 EASTERN PHOEBE
 NEST SHELF

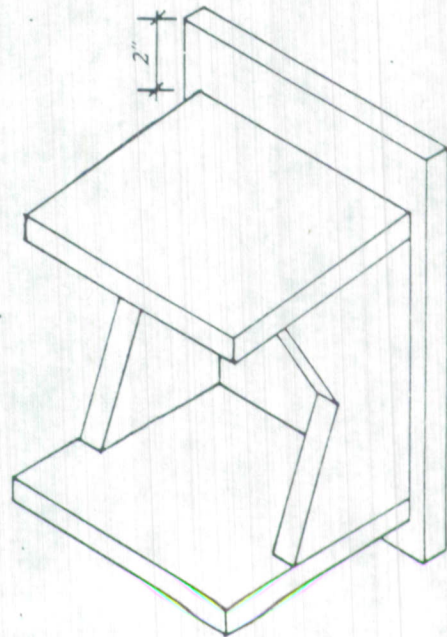
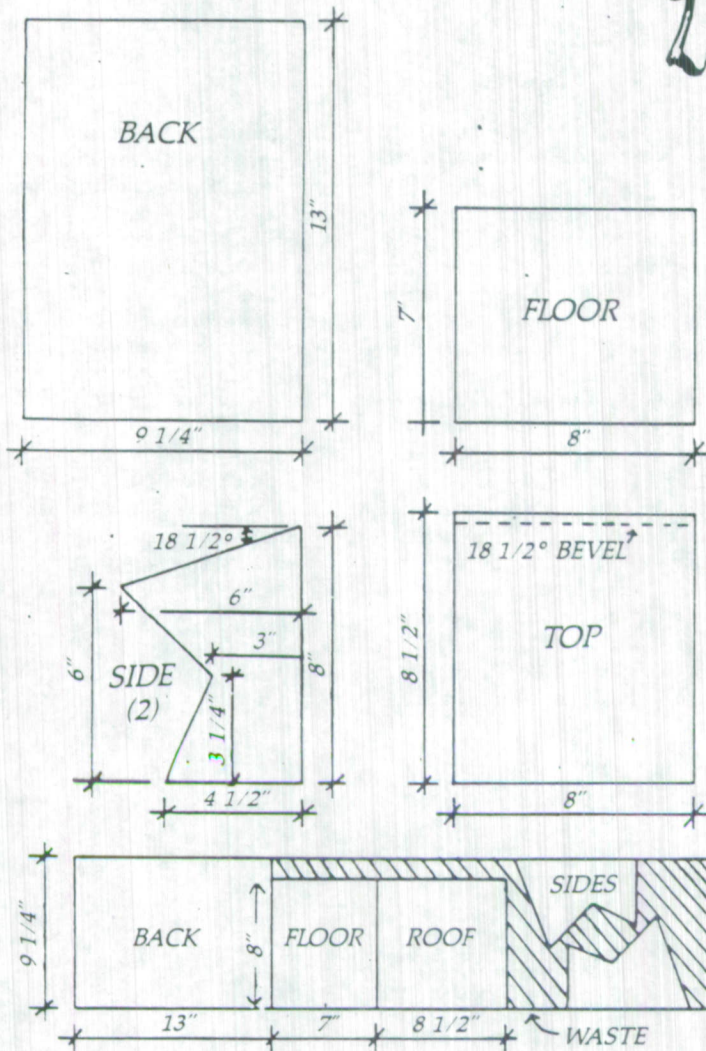
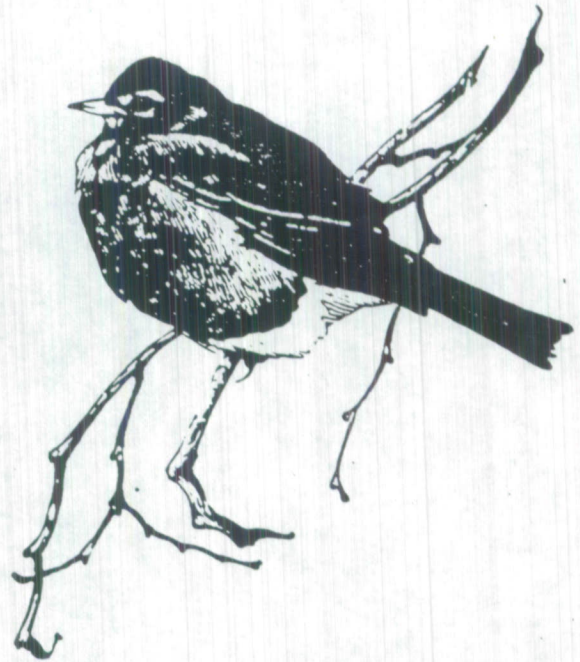

LUMBER:
 ONE 1" x 10" x 6'0"

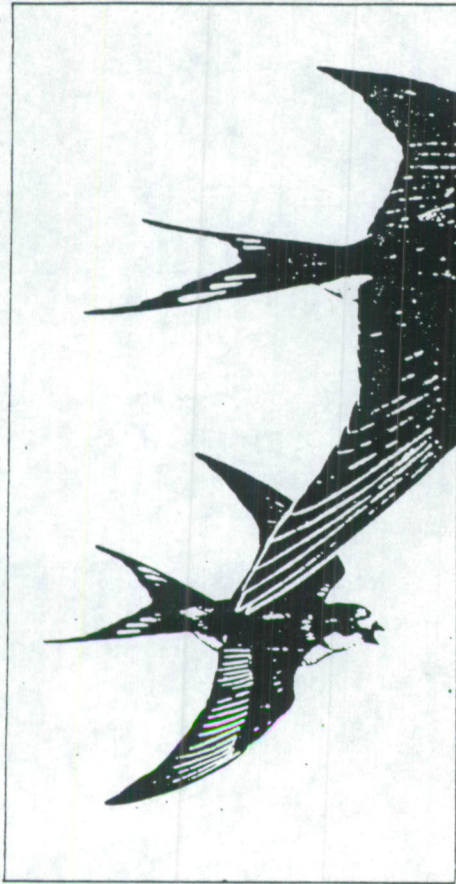

Barn Swallow

Barn swallows are a common inhabitant of farmsteads where they frequently nest on the rafters of barns and other outbuildings. Their mud nests are usually stuck onto the sides of rough-sawn rafters. These beautiful birds eat flying insects and are characterized by iridescent bluish-black backs, reddish breasts and deeply forked tails.

Barn swallows will also use the nesting shelf illustrated on page 10. Sometimes barn swallows are a nuisance because they nest over light fixtures in doorways. Then they "defend" their territory against people trying to pass through the doorway. To solve this problem, staple a small piece of clear plastic above the light fixture after knocking down the nest. The plastic will prevent mud from sticking to the wall. The nest should only be removed after the young have fledged. Then place a nesting shelf nearby on the house or garage wall so it is at least 10 or 20 feet from the doorway.

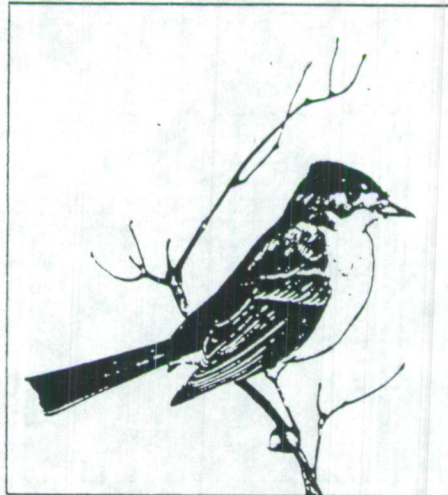

Eastern Phoebe

The eastern phoebe is a small gray songbird which usually feeds on insects while flying over water. Phoebes sit on low branches overhanging the water of a pond or creek, then make a short abrupt flight out over the water to catch insects.

Phoebes often build their nests on nesting shelves under the eaves of lake homes or cabins. The delicate nest is a beautiful cup-shaped structure made of mosses and lichens. The phoebe's call is a distinctive buzz-like "free-bee."

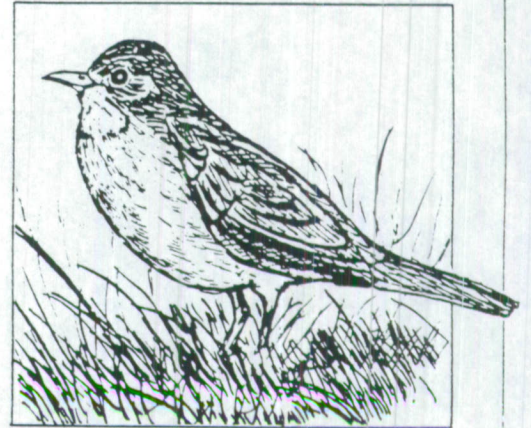

American Robin

One of Illinois' most enjoyable backyard bird species is the American robin. It is a welcome sight in the spring, its song is beautiful, and it provides great enjoyment for people as it raises its young each summer. Their grassy nest is lined inside with mud, and the eggs are bright blue.

A robin nesting shelf can be placed on a wall by a window where the robin family can be easily seen. Or the nesting shelf can be placed on the trunk of a tree about 6 to 10 feet above the ground. The nesting shelf can be left unpainted, or it can be painted an earth tone.

Remove the robin's nest after the young leave as robins build a new nest each year.

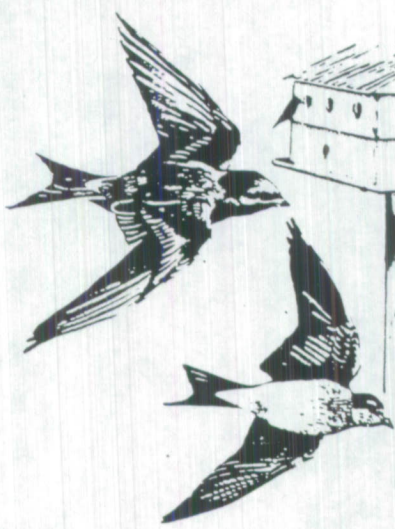

Nest Box 5

PURPLE MARTIN HOUSE

MATERIALS:
 4' x 8' x 1/4" PLYWOOD
 2" x 2" x 6" FOR CHIMNEY
 1" x 2" x 14" (BASE)
 1" x 1" x 8" (CORNER BLOCKS)
 4" x 8" METAL WINDOW SCREEN
 4" x 4" x 14" CEDAR POST

(NOT SHOWN)
 PLACE 1/2" DOWEL
 RAILING AROUND
 BALCONY TO KEEP
 YOUNG FROM FALLING

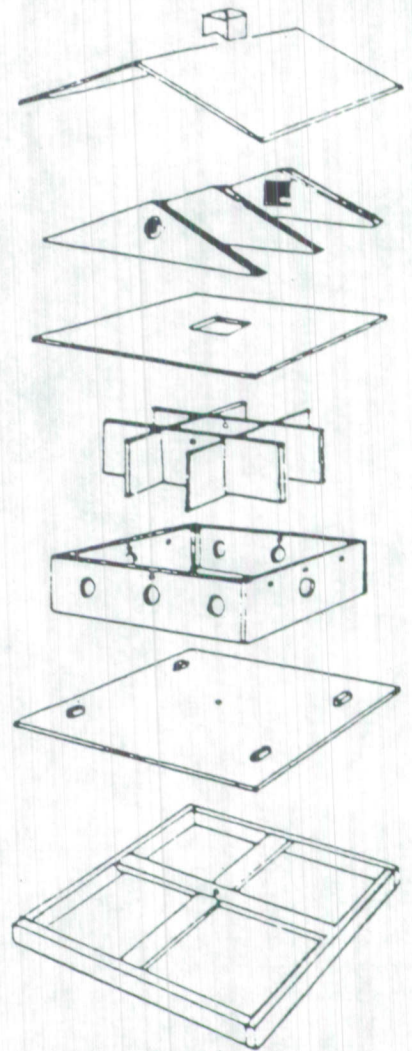
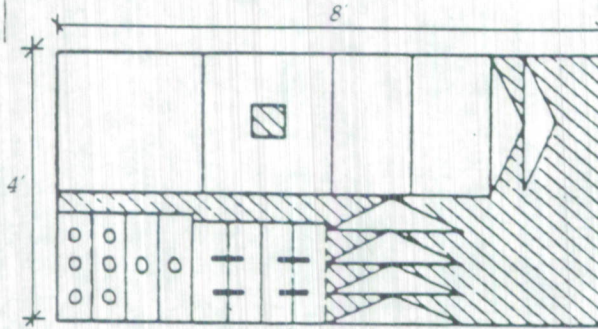

EXPANDED VIEW OF MARTIN HOUSE. A THREADED ROD INSERTS THROUGH THE BASE AND UP THROUGH THE CHIMNEY

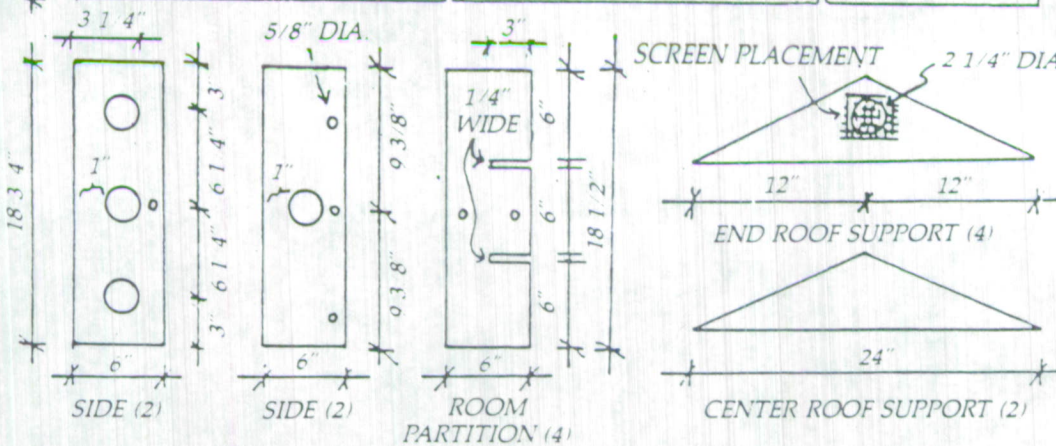
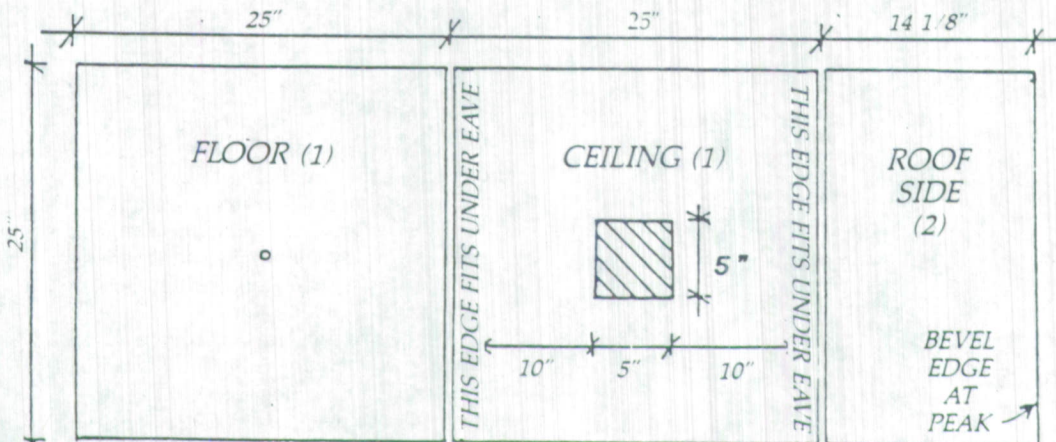

ENTRANCE HOLE
 DIAMETER
 2 1/4"

LOCATE 5/8"
 VENTILATION HOLES
 1" BELOW TOP
 EDGE OF SIDES

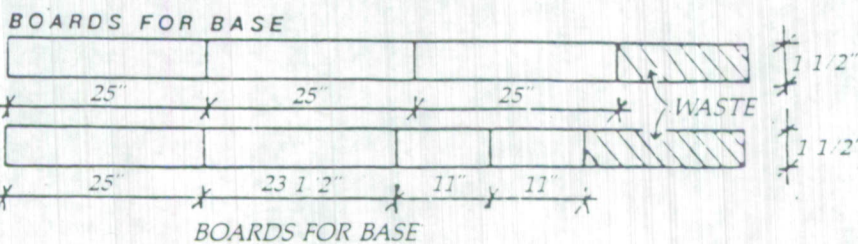

NOTE: THIS PLAN IS FOR A ONE STORY HOUSE. TO ADD A SECOND STORY, MAKE ONE MORE CEILING UNIT (25" x 25"), FOUR MORE SIDES, AND FOUR MORE ROOM PARTITIONS.

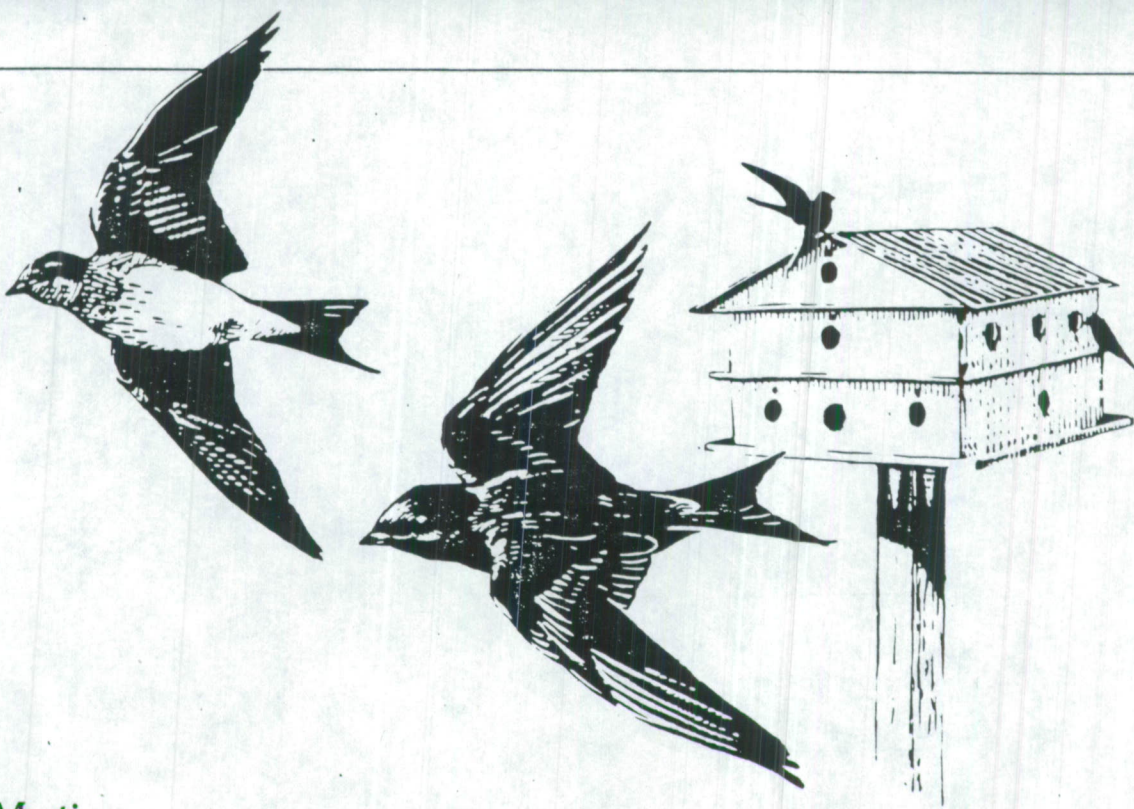

Purple Martin

Attracting purple martins is the ultimate challenge to a backyard bird enthusiast. Some people will put up a martin house in the spring and attract martins with relative ease. Other persons may maintain martin houses for years in apparently good habitat — with no luck in attracting them.

The purple martin is the largest member of the swallow family. It eats flying insects. Males are glossy black with purple iridescence. The markings of the female are somewhat duller.

The wooden purple martin house design should be modified to add a 1/2-inch diameter maple dowel "fence" around each balcony to prevent baby martins from falling off the balcony. If they fall to the ground, they will not be fed by their parents.

Following is an itemized list of instructions for making this purple martin house.

CONSTRUCTION

NOTE: This unit is held together by a threaded rod extending from the underside of the 1" x 2" base frame through the center of the chimney.

1. Mark all pieces on plywood sheet, then cut them out. Make four 1" x 1" x 5 7/8" corner blocks and eight 1" x 1" x 2" blocks to position the parts.
2. Cut out and assemble base from 1" x 2". Use 7d galvanized siding nails. Attach floor piece to base with glue and 1" or 1 1/4" nails.
3. Assemble the sides, alternating three hole and one hole pieces. Use glue and 1" nails or 3/4" #6 flat head wood screws. Place completed sides in position on floor. Insert partitions. Position ceiling and mark for the location of 1" x 1" x 2" blocks near corners on the underside. Attach the blocks.
5. Place ceiling in position.

6. Glue pairs of end roof supports together to form gable ends 1/2" thick. Attach screen. Position and mark. Glue the two center roof supports together to make it 1/2" thick. It will be positioned adjacent to the threaded rod going up through the exact center of the house. Attach these pieces to the ceiling with glue and nails or flat head wood screws from the underside. Attach roof sides with glue and nails or screws.
7. Make chimney from a piece of 2 x 2. Cut V-notch on end to fit roof. Have it extend 2 1/2" above roof peak. Drill 1/4" hole in chimney and roof for rod. Nail chimney in place. Insert rod and tighten up.
8. Drill hole in top of pole to accommodate nut on lower end of threaded rod.
9. Use 1/2" diameter maple dowels to make a fence about 2" high on each balcony. Pieces of wood 1" x 1" x 3" may be used as the corner posts of this railing.

MOUNTING

Use four 4" x 5" shelf brackets with 1/4" or 3/16" x 1 1/2" round head stove bolts and 1" #8 flat head wood screws to attach to pole.

NOTE: Additional stories may be added if desired. One ceiling unit, four-sides, four-room partitions, eight 1" x 1" x 2" blocks and four 1" x 1" x 5 7/8" corner blocks will be needed for each additional story.

Do not paint the interior of the house. Lightweight roofing paper makes an efficient roof covering. When painting the house, use aluminum paint on the roofing paper before painting it white. This seals in the black tar of the paper.

Commercially-made aluminum houses are acceptable if they are well-ventilated, have at least six compartments, with each compart-

ment at least 6" x 6" x 6" in size. The entrance holes should be 2 1/4 inches in diameter and the bottom of the holes should be 1 inch above the floor.

Purple martins will arrive in southern Illinois in late March. As soon as the first martins, or "scouts," are seen, remove entrance covers from the martin house. The covers are used to keep sparrows and starlings out during the winter. If a cold spell hits after martins arrive, insects will die and martins can starve. To help, place crushed egg shells on a flat, elevated surface near the martin house. Another special inducement for the martins is a 1' x 2' area of soaked, sodded earth which provides them with a "mud puddle" for a water supply.

Purple martin houses should be placed in an open area where the birds have clear access from all sides. The house should be at least 30 feet away from trees. Martins seem to prefer sites where utility wires are nearby for perching. Houses near open water like lakes may have added appeal but this is not essential. Martin houses should be painted white or a light color to reflect the sun's heat.

Some people suggest placing purple martin houses very high — from 12 to 18 feet. However, other people suggest placing the house on a 4" x 4" cedar post no more than 8 to 10 feet high so it is easier to maintain during the summer with a step ladder. If in doubt, try using a 14" x 4" x 4" cedar post. Set it 4 feet deep in the ground and secure the base by pouring a small batch of concrete in the post hole before filling the post hole.

A martin house can be taken down, cleaned and stored at the end of the summer, or the entrances should be covered as soon as the martins leave in late August to early September. If a martin house is left up, the nesting cavities still need to be cleaned out.

Nest Box 6

NORTHERN FLICKER

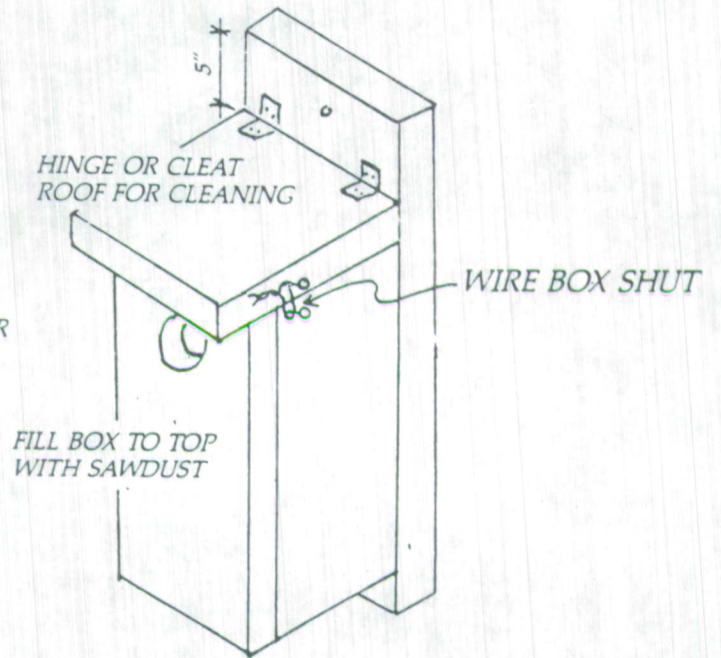
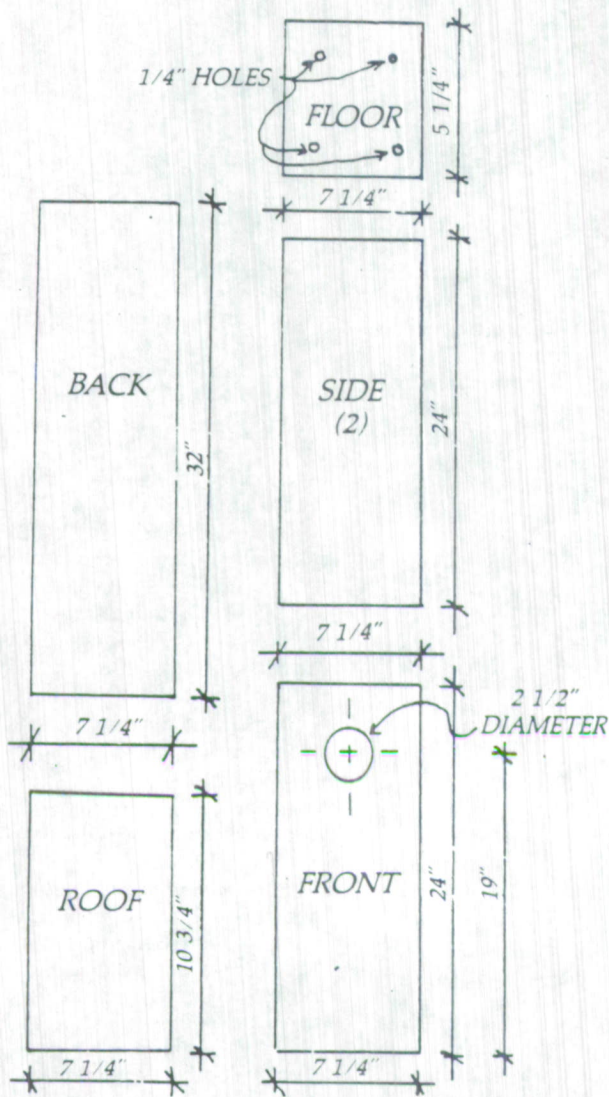

LUMBER: ONE 1" x 8" 10'0"

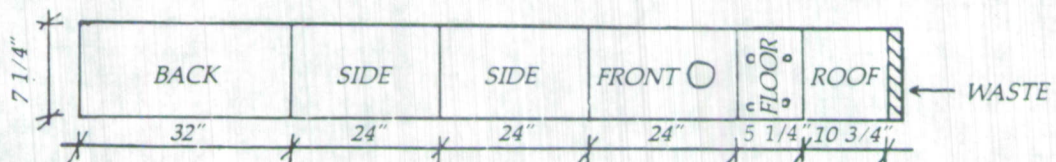

Northern Flicker

Northern flickers are a very common woodpecker throughout much of Illinois. They frequently nest in farm groves, orchards, woodlots and in urban areas. Unlike most other woodpeckers, flickers usually forage for ants and grubs on the ground in crop fields and in grassy meadows and yards.

The "secret" of success in attracting flickers is to use 1 1/2" cedar boards for nest boxes and to fill the interior of the box all the way to the top with sawdust. Tamp in the sawdust before April first so the box is ready when the flickers arrive. This house should have a hinged roof to facilitate filling it with sawdust. The filled box simulates a dead tree with soft heartwood. Since the northern flicker is a "primary excavator," it will start at the entrance hole which is provided and throw out sawdust until a suitable cavity is created. Since this box remains filled with sawdust if not used, sparrows and starlings are not a problem. The entrance hole should be 2 1/2" in diameter.

This brilliant nest box idea was developed by Mr. A.J. Boersma of Sioux Center, Iowa.

Flicker boxes should be placed 4 to 6 feet high along fence rows that border crop fields or pastures. Or they may be placed in orchards and woodlots. Flicker boxes can be attached to existing fenceposts or attached to free-standing posts with cedar guards.

Other common woodpeckers in Illinois include hairy woodpecker, downey woodpecker, red-headed woodpecker, red-bellied woodpecker and yellow-bellied sapsucker. They are all cavity nesters but prefer dead trees over nest boxes.

A box for pileated woodpeckers, the largest woodpecker in Illinois, may be found on page 22.



Nest Box 7

BAT HOUSE

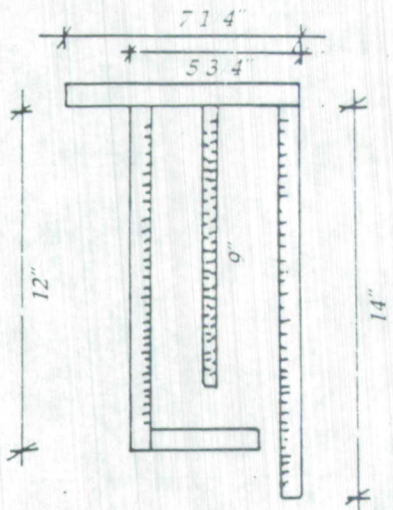

SIDE VIEW
(cut-away)

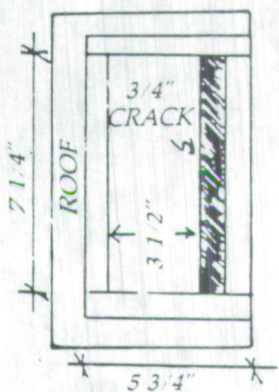

BOTTOM VIEW

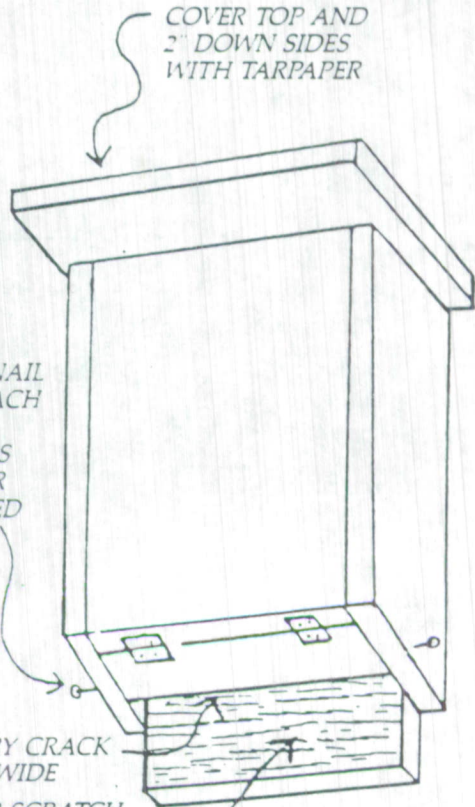

ONE NAIL
ON EACH
SIDE
HOLDS
FLOOR
CLOSED

ENTRY CRACK
3/4" WIDE
SCORE OR SCRATCH
ENTRYWAY AND ALL
INNER SURFACES TO
ROUGHEN

FRONT VIEW
as mounted
on building

LUMBER: ONE 1" x 8" x 8'0"

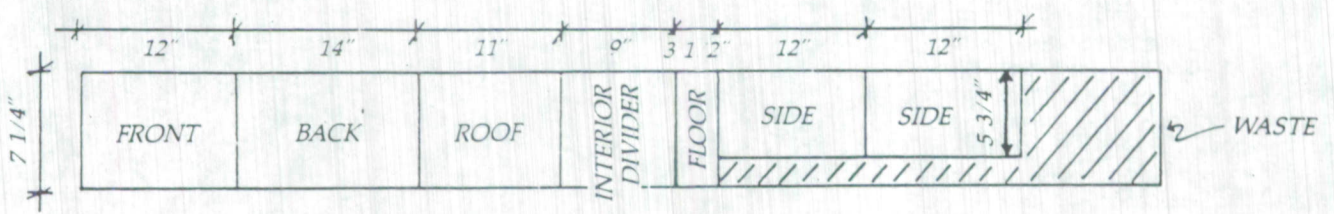

Bats

Who in the world would think of building a house for bats? The idea sounds farfetched. Once bats are understood, however, their desirable qualities exceed even those of the popular purple martin. For example, some people claim that purple martins eat up to a thousand mosquitoes per day. Other persons dispute that total, saying that the daily total of mosquitoes is much lower because martins don't actively feed when mosquitoes are most active. In contrast, bats do. A single, big, brown bat can eat 3,000 to 7,000 mosquitoes each night! And a big brown bat can live up to 19 years. Bats are also devoted parents.

Expectant mother bats join together in "nursery" colonies where hundreds or thousands congregate to raise their young. Mother bats help each other with rearing young, and each female recognizes her own young. The big brown bat raises just one young per year. Males cooperate during this reproductive phase by either bringing food to their mates or leaving the maternity cave to reduce competition for limited food supplies — depending on the species.

Since bats are such an important form of natural control for insect pests like mosquitoes, it is in our own best interest to perpetuate them. This is already being done in much of Europe where bats are totally protected and where people build "bat houses" much like we build martin houses. Figure 9 shows a European-style bat house.

The most likely occupants of bat houses in Illinois are the big brown bat and little brown bat. The most critical dimension is the three-fourth-inch width of the entry space. All inner surfaces must be roughened with a chisel or saw cuts to permit bats to climb on them with ease. Rough outer surfaces are also preferred.



Daytime temperatures in the bat house must be very hot — about 80° to 90°F. One way to achieve this is to cover the bat house on top and extending a couple inches down the sides with two or more layers of tarpaper. The dark color of the tarpaper absorbs heat from the sun and helps protect bats from the rain. The tarpaper may be hard to attach and may weather badly. Another alternative would be to paint the bat house black so it would absorb heat from the sunlight.

Bat houses should be securely fastened to a tree trunk or the side of a building roughly 12 to 15 feet above the ground. Preferably they should be on the east side of the house or tree where they will receive the morning sun but will be shaded during the afternoon. Bats also seem to prefer sites that are protected from the wind.

The best habitat for bat houses is relatively near rivers, lakes, bogs or marshes where insect populations are high. The closer bat houses are to such places the greater the probability of being used. Those located more than a half mile from these habitats have a low probability of being used.

Bat houses should be placed by early April, but it may take a year or two for bats to find the house. Once used, it does not need to be cleaned. Chances of occupancy are better if bats already live in nearby buildings.

Another technique that may work to attract bats is to nail a 2-foot wide piece of tarpaper around a tree trunk. Nail the tarpaper around the top edge, like a tight-fitting skirt. This will prevent water from leaking under the tarpaper from above. The bats will enter from below and can cling to the bark of the tree. To regu-

late their body temperature they can move laterally around the tree trunk as the sun moves during the day.

Sometimes bats create severe problems for people by establishing huge colonies in the attics of homes. The best way to solve this problem is to hire a carpenter in the winter to exclude bats at the holes where they enter the house. Since most bats migrate, it is possible to exclude the bats while they are not present.

Sometimes it is possible or desirable to set up an alternative bat house so they don't take up residence in someone else's house.

A Missouri-style bat roost structure may be desirable for large bat concentrations. Such structures may be useful at state parks or on other public park and wildlife lands where bats are causing problems in residences or out-buildings. These structures are expensive to build and difficult to erect. A successful colony relocation into one of these structures is dependent upon several factors. The Department of Natural Resources will provide technical advice and assistance to those who wish to erect this type of structure.

Citizens who erect bat houses or roost structures are asked to send the results of their efforts to: Illinois Department of Natural Resources

Division of Natural Heritage
524 South Second Street
Lincoln Tower Plaza
Springfield, IL 62701-1787
ATTN: Mammal Ecology Program

This information on bats and bat houses has been provided by Dr. Merlin D. Tuttle at the Milwaukee Public Museum in Milwaukee, Wisconsin.

Nest Box 8

AMERICAN KESTREL
 EASTERN SCREECH-OWL
 SOUTHERN FLYING SQUIRREL*

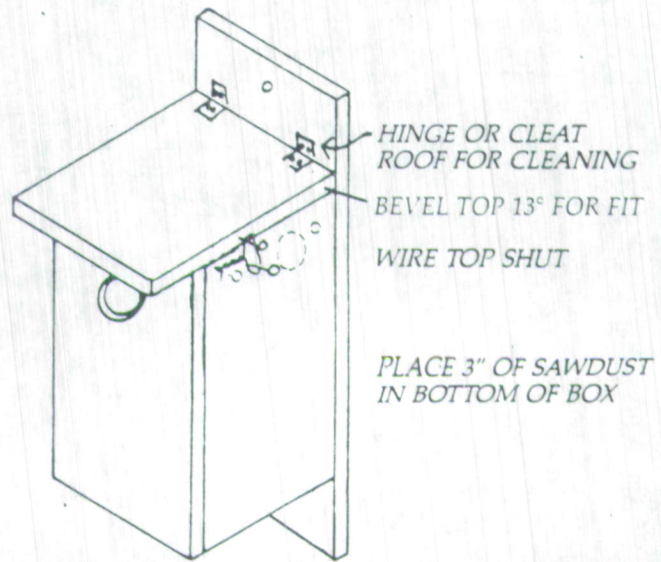
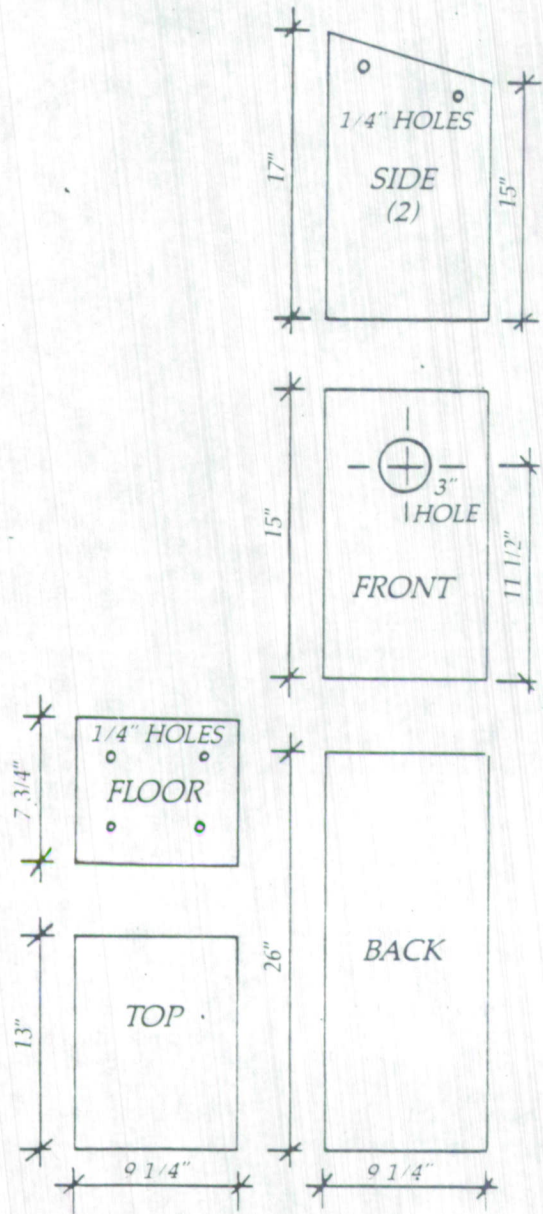

*Note: Hole size and placement are different for flying squirrel boxes.
 Hole size = 1 1/2"; Placement as indicated on diagram above (⊙)

LUMBER:
 ONE 1" x 10" x 8'0" (# 2 white pine recommended). Staining or painting box will increase its useful life.

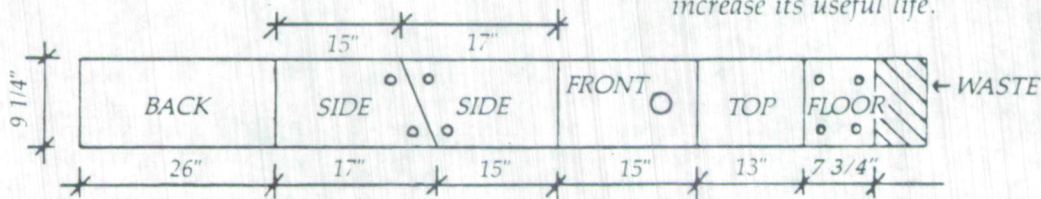

(Not to scale)

American Kestrel

The American kestrel is our smallest falcon and is abundant in agricultural areas which are characterized by scattered woodlots, scattered trees, shelterbelts, meadows, highway rights-of-way, pastures and hay fields. This species is valuable because of the large numbers of rodents and insects eaten. Kestrels are frequently seen sitting on powerlines along highways or hovering above the grassy roadside ditches in search of their prey. An adult kestrel is about the size of a grackle.

Illinois has a program in which kestrel nest boxes are placed on the back of information signs along Interstate Highways. The boxes are predator proof because the steel posts supporting the signs can't be climbed by cats or raccoons. The grassy interstate right-of-way is ideal habitat for kestrels. The boxes are strapped to the vertical sign posts with steel bands by using a steel banding tool that is normally used for strapping steel bands around freight.

The nest box shown on page 18 is ideal for kestrels. Place the box in orchards or relatively open country on a tree or a free-standing post that is 10 to 30 feet high. The tree or post should have a sheet of tin or aluminum nailed or stapled around it, under the box, to prevent squirrels and predators from using the box. Used aluminum offset printing plates can be purchased very cheaply from newspaper offices and used for this purpose. The nest hole should be 3 inches in diameter and preferably face south or west. About 2 to 3 inches of wood chips should be placed in the bottom of the box. Grassy habitat should be in the vicinity to provide hunting habitat for the kestrels.

Starlings may be a persistent problem in a kestrel box. The boxes will need to be checked regularly — every week or 10 days — to remove starling eggs and nests. Starlings are an unprotected species.

Kestrels normally lay five eggs that are white, pinkish-white or cinnamon, and they are evenly covered with small spots of brown. Occasional checking of the nest will not cause the kestrels to abandon the nest.

Southern Flying Squirrel

The spritely flying squirrel is nocturnal and is seldom seen even where it is a common resident. They may come out at night to feed in backyard bird feeders. Flying squirrels are found in a wide variety of habitats ranging from deciduous forests to groves and woodlots. It is probably not necessary to put out nest boxes specifically for flying squirrels because they readily use boxes that are put out for other species, including wood duck and screech-owl boxes. The screech-owl box on page 18 is an especially good size for flying squirrels when the indicated changes are made.

Eastern Screech-Owl

Eastern screech-owls are small gray or reddish owls with ear tufts which live in our hardwood forests. They are only about 8 inches high and resemble a miniature version of the more common great horned owl. The nest box for screech-owls shown on page 18 should be placed at least 10 feet high in a hardwood forest. Preferred habitat seems to be on the edge of woods adjacent to fields or wetlands. To prevent use by squirrels, the box could be placed on a pole with a predator guard. Since the entrance hole is 3 inches in diameter, persistent starling control may be necessary. About 2 to 3 inches of wood chips should be placed in the bottom of the nesting box.

Part 2 —

Nest boxes and platforms for use in deciduous forests and bottomlands.

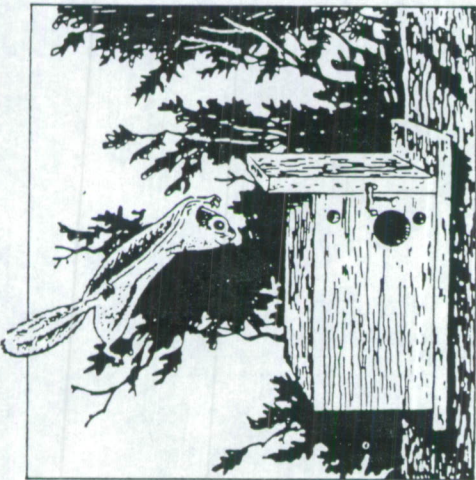

Nest Box 9

BARRED OWL

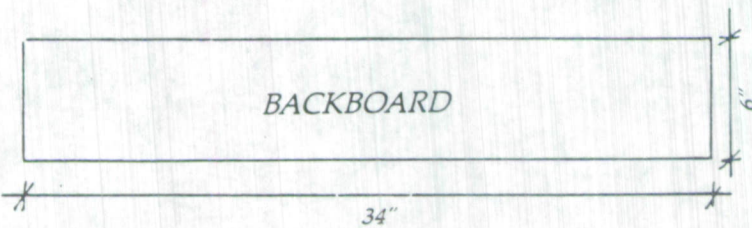
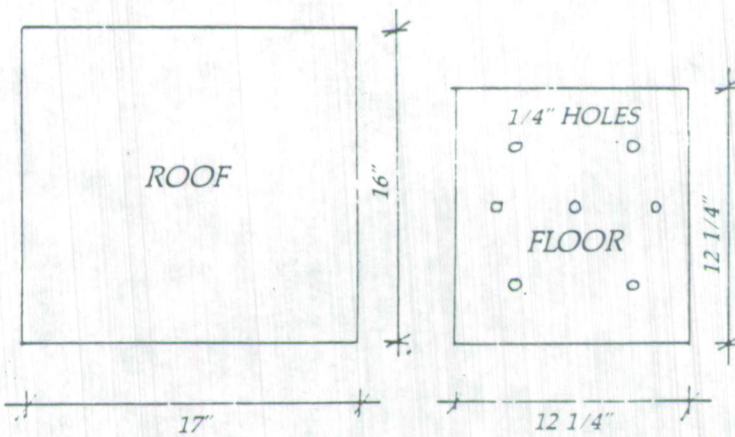
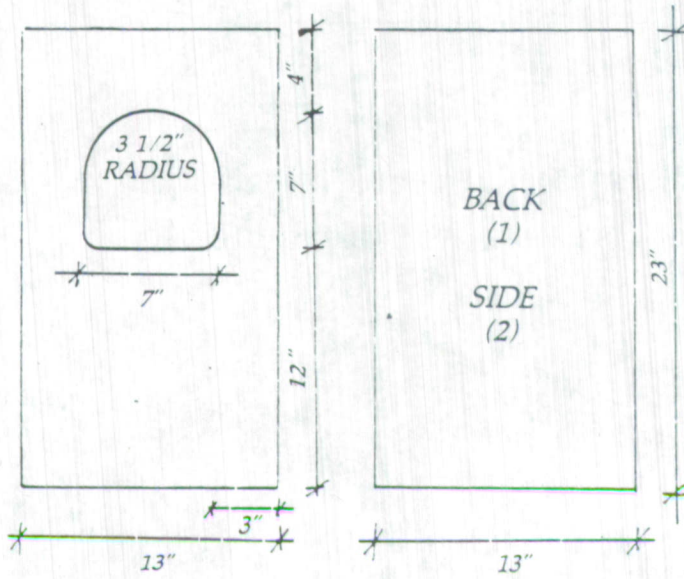
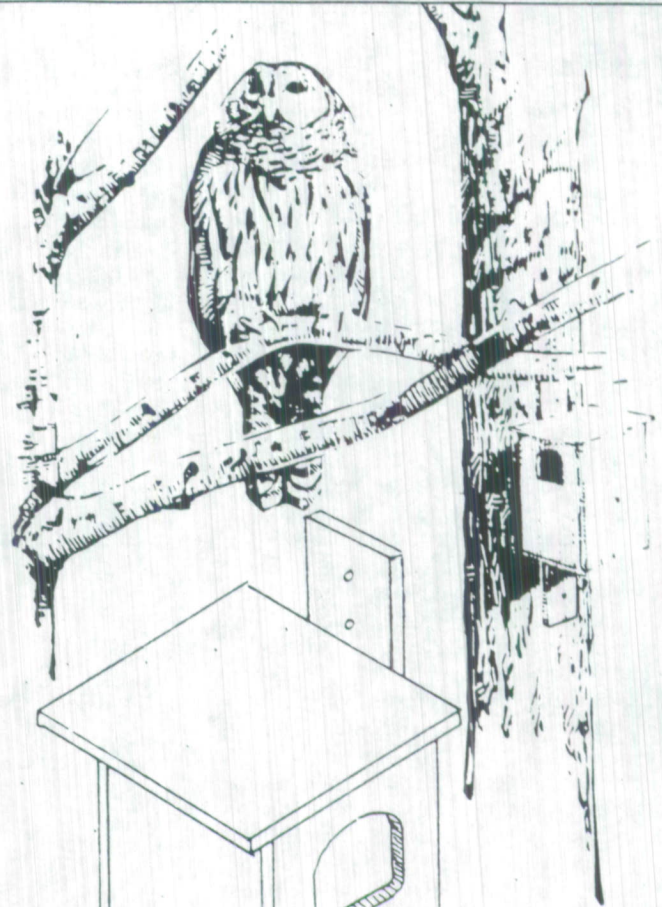

NOTE: NO HINGED DOOR NEEDED.
CLEAN THROUGH ENTRANCE HOLE.

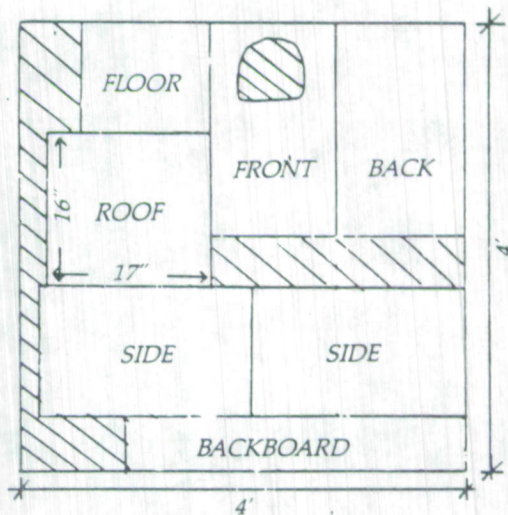
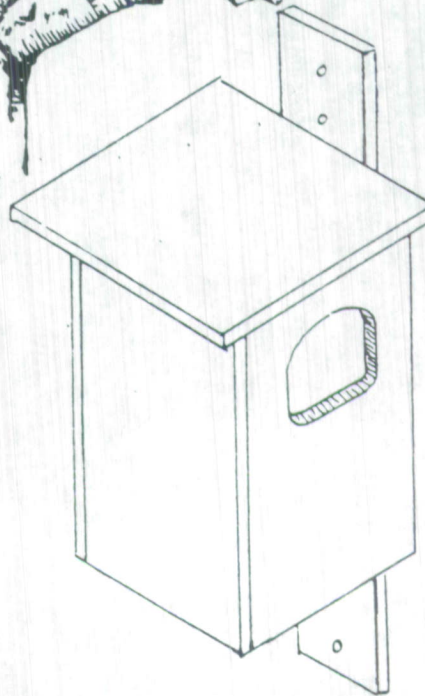

LUMBER: ONE 4' x 4' x 3/4"
SHEET EXTERIOR PLYWOOD

Barred Owl

The barred owl is one of our more common owls in hardwood forests. Its distinctive "Who-cooks-for-you" call and brown eyes identify it among Illinois owls. The barred owl nest box is made of 3/4-inch thick exterior grade plywood. Do not paint, stain or treat the box with creosote. Put a 2 to 3 inch layer of small wood chips in the bottom of the box. No cleaning is needed except to remove leaves and other litter that squirrels put into the box. The entrance hole is 7 inches wide and 7 inches high with a rounded top and rounded corners at the bottom. The hole can be either on the front or on a side, but if it is on the side the box is easier to clean. This box can be cleaned out through the hole, so the roof does not need to be hinged.

The box should be cleaned out or placed in January. The box should be located 20 to 30 feet high in a mature lowland hardwood area, and preferably within 200 feet of water. Do not place the box on the edge of a clearing or within 150 feet of a residence. The entrance hole should not be obscured by branches or leaves, but a perch near the nest box is desirable. This perch should be near enough to the box so that the young can "branch" out onto it as they leave the nest. Otherwise they may fall to the ground and be eaten by predators. The box should be placed on a living tree which is at least 12 inches in diameter. There may be a slight preference for west-facing entrance holes.

This design has been developed by David H. (DJ) Johnson of Minnesota.



Nest Box 10

WOOD DUCK
 HOODED MERGANSER
 RACCOON
 FOX and GRAY SQUIRREL
 PILEATED WOODPECKER (?)



HOLE SIZE:
 (UP)

WOOD DUCK and HOODED MERGANSER:
 3" HIGH AND 4" WIDE OVAL

RACCOON:
 5" HIGH AND 9" WIDE OVAL

FOX and GRAY SQUIRREL:
 3" DIAMETER ROUND

PILEATED WOODPECKER:
 4" DIAMETER ROUND

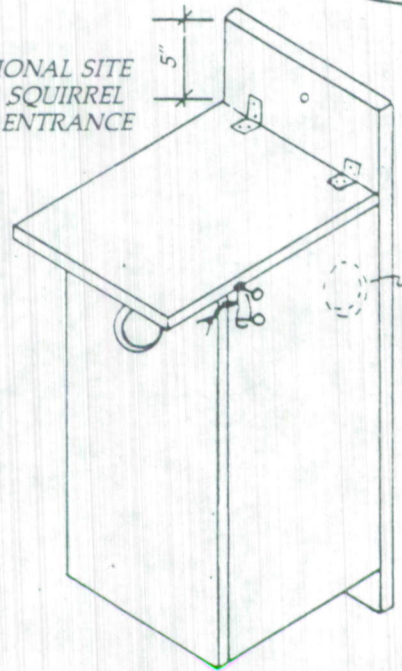
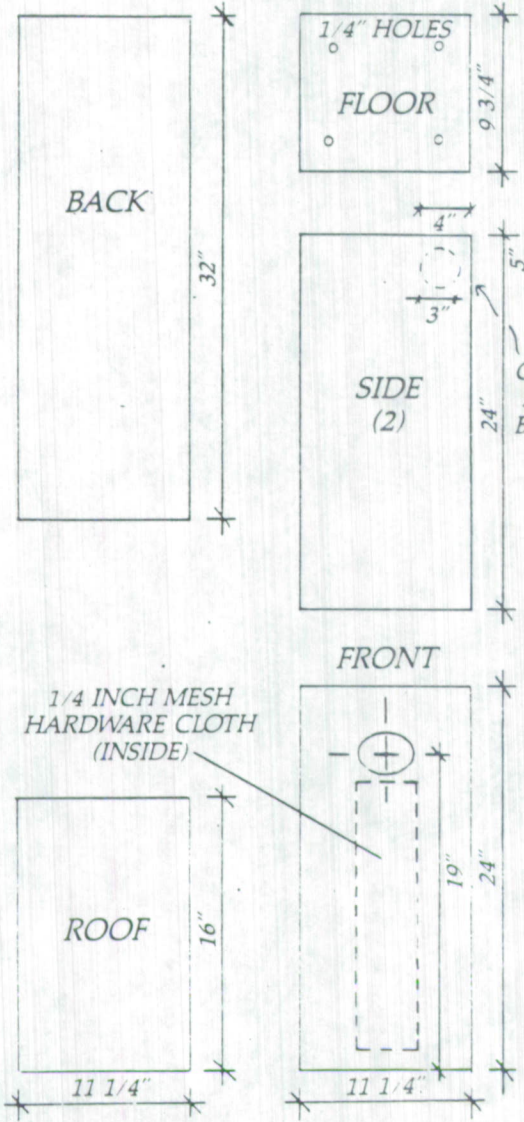

HINGE OR CLEAT
 ROOF FOR CLEANING

OPTIONAL:
 LOCATE 3" DIAMETER
 ENTRANCE HOLE HERE
 FOR SQUIRREL BOX

FOR WOOD DUCK HOUSE -
 PLACE 3-4" OF SAWDUST
 IN BOTTOM OF BOX

FOR PILEATED
 WOODPECKER HOUSE -
 FILL BOX TO TOP
 WITH SAWDUST

LUMBER: ONE 1" x 12" x 12'0"

NOTE: PILEATED WOODPECKER BOX SHOULD BE
 CONSTRUCTED FROM ONE 2" x 12" x 12'0" CEDAR, AND
 FLOOR MUST BE 8 1/4" LONG INSTEAD OF 9 3/4"
 FOR USE OF 1 1/2" THICK LUMBER

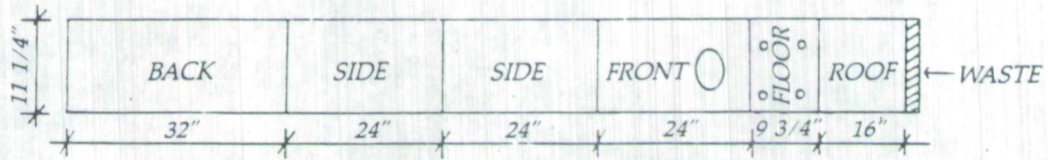

Wood Duck

The traditional wood duck box has helped the beautiful wood duck make a remarkable recovery during the past 20 years. Early in this century some people believed the wood duck was becoming extinct. Now it is one of Illinois most abundant waterfowl species.

As shown on page 22, the entrance hole should be an oval 3 inches high and 4 inches wide. This hole excludes most raccoons. The hole should be centered 19 inches above the floor. An 18" x 3" strip of 1/4-inch mesh hardware cloth should be cut out and the cut edges folded back. This should be attached inside the box under the entrance to function as a ladder for the newly hatched ducklings. Sometimes squirrels will tear this ladder loose so it will need to be checked annually. Or the wood under the entrance hole should be roughened with a chisel to give the ducklings the toeholds they need. The roughened area should extend below the entrance hole for 1 foot. At least 3 inches of mixed sawdust and chain saw wood chips should be placed in the nest to serve as nesting material. The roof should be wired so the box can be opened for maintenance. Paired roofing nails with large heads should be used around the top of the box to wire it shut so raccoons can't open the box.

The house should be constructed of wood that is strong and can be made weather resistant. It can be painted, stained or treated — on the outside only. The floor should be recessed 1/4 inch up from the lower edge of the sides to prevent rotting.

Houses can be erected on an isolated tree or on a 16-foot long, 4" x 4" post that is cypress, cedar or preservative-treated wood. An aluminum or tin sheet should be nailed around the post under the house to prevent squirrels and raccoons from entering. Used aluminum print-

ing plates from newspaper offices can be purchased very cheaply and stapled lengthwise to the 4" x 4" post under the nest box. Since wood ducks are not territorial, two or more houses can be placed on the same post.

Vigilant starling control will be necessary in wood duck boxes. Remove their nests and eggs whenever they occur. The top of a wood duck box should be fastened to its support so that it leans forward a couple inches. This facilitates the drainage of rainwater. To strengthen the box, nail a 9 3/4 inch long, 1" x 2" along the inside top edge of the front. Nail a similar size piece onto the back just under where the roof rests.

Biologists recommend placing a horizontal piece of slab wood with the bark attached on the front of the box immediately below the entrance hole. This aids the hen in landing and entering the entrance hole.

Boxes placed on posts in water should be about 6 to 8 feet above the water's surface. Wood duck boxes should be placed over water or in woodland habitat up to half-a-mile from lakes, ponds, marshes and rivers. Wood ducks nest regularly in most of Illinois. Since the hen must lead her ducklings to water after they hatch, the habitat between the house location and the water's edge should be free of major obstacles like highways, fences with small mesh wire and street curbing.

Heights above 20 feet seem to be preferred in trees. Aspens should be avoided. Box entrances near water should face the water. Otherwise, there seems to be a slight preference for south and west facing entrance holes. Ideally, boxes on land should be 30 to 100 feet from the water's edge. The chance of predation by raccoons is higher along the water's edge.

Annual maintenance on wood duck boxes should be completed by March 1.



Gray and Fox Squirrels

Gray and fox squirrels readily adapt to nest boxes in backyards, woodlots and farm groves. Gray squirrels tend to be found more in urban areas and in larger stands of hardwood forest. Fox squirrels are found more commonly in farmsteads, river bottoms and woodlots.

A squirrel nest box is identical to the wood duck box shown on page 22 except for the location of the entrance hole and the ventilation holes. A 3-inch diameter entrance hole is placed to the upper rear portion of one side. It is centered 3 1/2 inches from the top and 2 1/2 inches from the back edge. Ventilation holes are drilled into the side opposite the entrance.

Houses should be placed in trees that are at least 10 inches in diameter. They should be at least 30 feet above the ground. The entrance hole should face either east or south to be downwind from prevailing winter winds. A squirrel nest box can be made more enticing to squirrels by filling it half full of dry leaves. To attach the box to the tree, use a lag screw and washer at both the top and bottom of the back piece. Lag screws must be loosened annually to allow for tree growth. Wire should not be used because it can girdle the tree. Boxes are most heavily used in the winter, so new boxes should be set out in the fall. It is not necessary to clean out squirrel nest boxes.

One or two squirrel boxes per acre in a woodland are usually sufficient to maintain a maximum squirrel population.

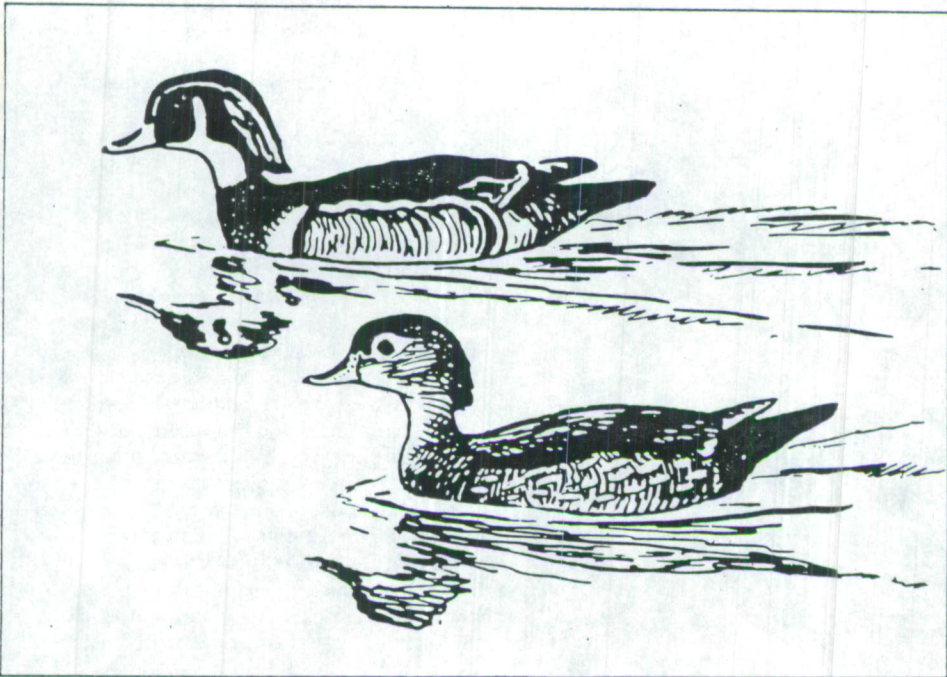

Hooded Merganser

The beautiful hooded merganser nests primarily in the forests of Illinois in habitat adjacent to lakes, beaver ponds, swamps and rivers. It nests in the same type of nest box that wood ducks use. The desired entry hole

is the same size, and all nest box management considerations are the same as for the wood duck. Heights above 20 to 25 feet seem to be preferred. There seems to be a preference for west-facing entrance holes.

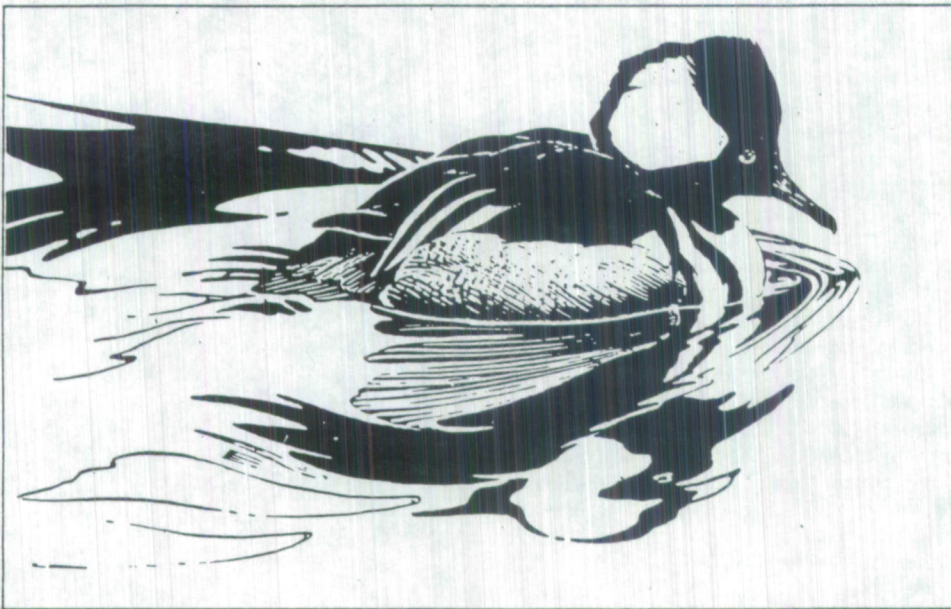

Raccoon

The raccoon is a common mammal throughout Illinois. Most nest box projects are designed to exclude use or predation by raccoons. However, if someone wishes to provide a box which can be used by raccoons, the design on page 22 is appropriate. The entrance hole

should be 5 inches high and 9 inches wide and face east or south so it is sheltered from prevailing winter winds. The box should be placed on live or dead trees at a height of 10 to 20 feet. The tree should be at least 12 inches in diameter.

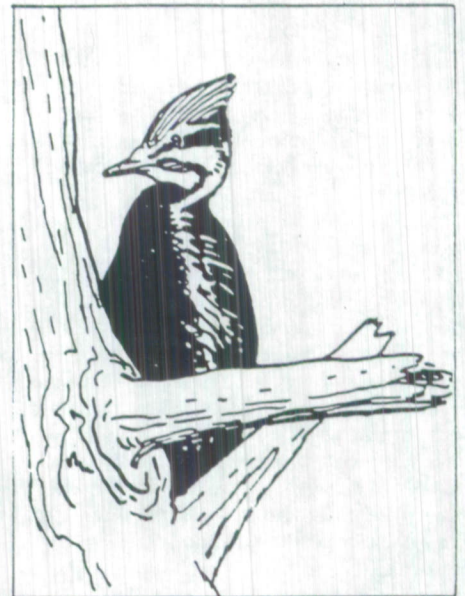

Pileated Woodpecker

The distinctive pileated woodpecker occurs in large forested areas and forested stream corridors in Illinois. It is the largest woodpecker in the state — about the size of a crow.

It has not been known to nest in nesting boxes because it is a primary excavator and must excavate its own nesting cavity. However, the breakthrough in attracting flickers developed by Mr. A.J. Boersma of Sioux Center, Iowa, may apply to pileated woodpeckers also. The "trick" is to fill the nest box with sawdust all the way to the top and tamp it in. Then the woodpecker can fulfill its instinct to make its own nest cavity.

This nest box design is proposed as an experiment for woodland owners, naturalists and biologists to try. Use the one-board wood duck box design shown on page 22, but use 1 1/2-inch thick cedar instead of a 3/4-inch thick board as you would for a wood duck house. A 12-foot long, 2" x 12" board will be necessary to make this box.

Remember that the floor section must be 8 1/4 inches long instead of 9 3/4 inches as shown on page 22.

The entrance hole should be 4 inches in diameter and centered 19 inches above the floor. The top should be hinged to allow filling with sawdust. The entrance should probably face south or east. Sawdust should be tamped into the box all the way to the top.

The box should be placed about 20 to 30 feet high in a live or dead hardwood tree in the interior of a stand of mature hardwoods where pileated woodpeckers are known to occur. Lag screws and washers can be used to attach the house to the tree so it can be loosened as the tree grows — if a live tree is used. Caution: Dead trees are often unsafe to climb and may frequently be undesirable to use for that reason. Please report any nest box use by pileated woodpeckers to the Division of Natural Heritage.

ENTRANCE HOLE GUIDE FOR DUCK, MERGANSER AND RACCOON NEST BOXES

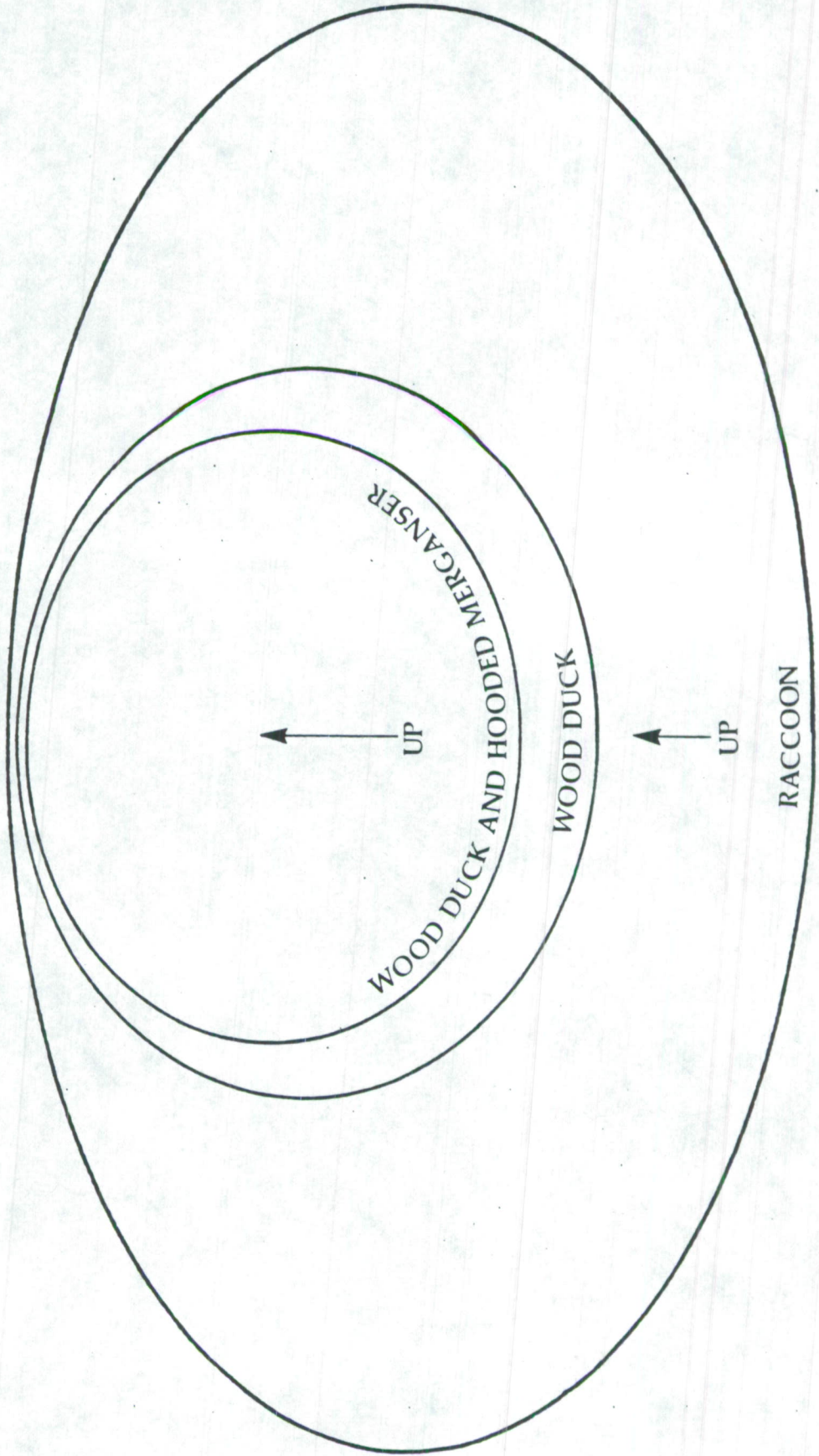

TRACE ONTO WOOD WITH CARBON PAPER

ENTRANCE HOLE GUIDE FOR SONGBIRD, WOODPECKER AND SQUIRREL NEST BOXES

TRACE ONTO WOOD WITH CARBON PAPER

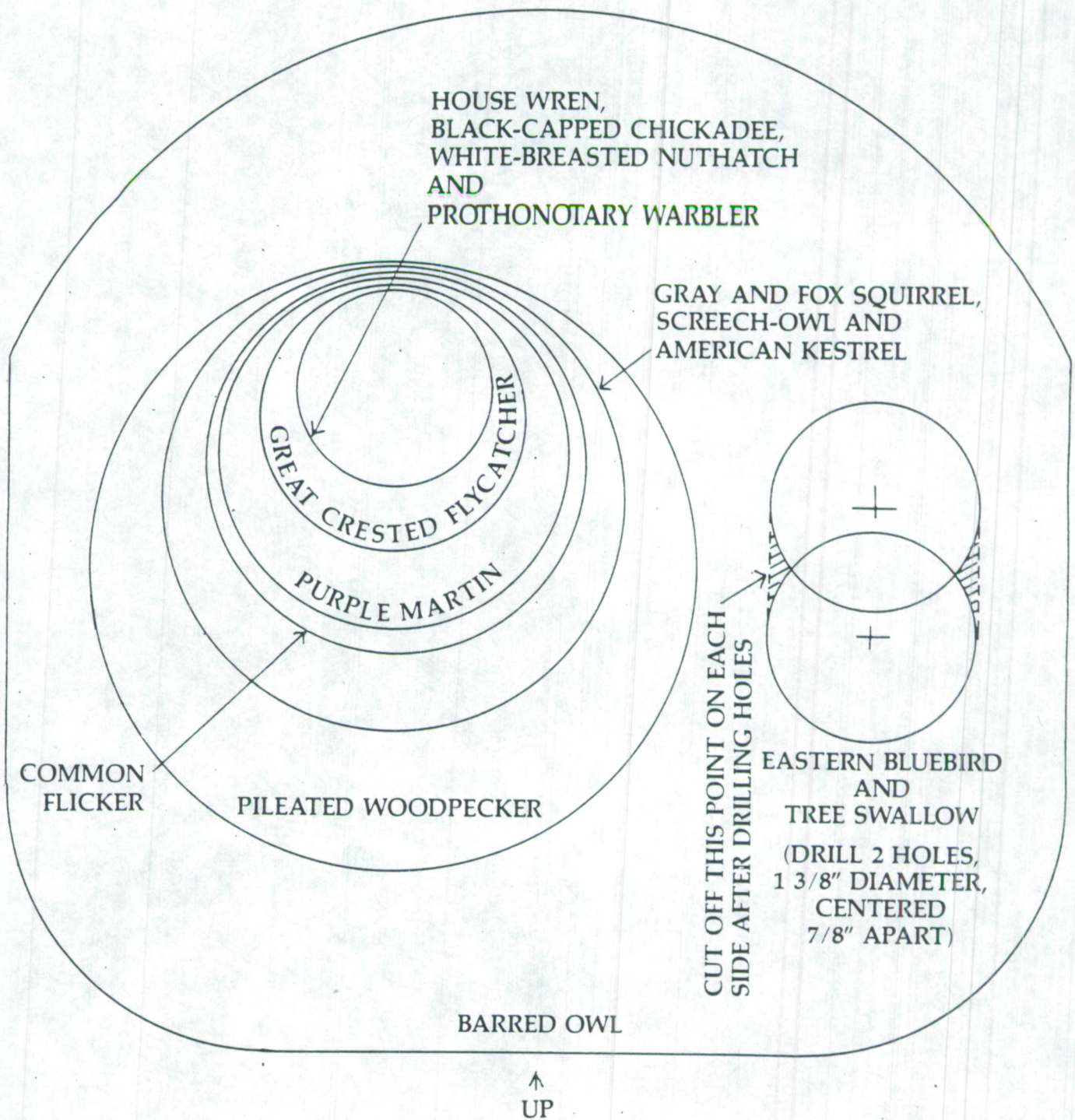

Part 3 —

Guide to Attracting and Feeding Wildlife



During the past 30 years, feeding wildlife, especially birds, has escalated from a hobby practiced by few, to a service performed by millions.

In Illinois, the backyard feeder boom is apparent in a variety of settings. Whether evidenced by a small feeder adorning the brow of a highrise, a suet feeder hanging in a quiet garden or a rural food patch, Illinoisans are taking to feeding wildlife at a greater rate than ever before. And with the consistent loss of natural habitat, individuals of nearly every Illinois wintering species are turning to feeders to help carry them through the cold months in good shape for the upcoming breeding season.

Nature enthusiasts familiar with winter feeding know it's a reward for people, as well. For those who live in urban settings, the birds and mammals attracted to the backyard represent a link to the natural environment, providing an opportunity to observe the animals closely and to take photographs. Watching certain species come and go is an enjoyable way to mark the passage of the seasons and it is exciting to spy a rare or less common species stopping in for a visit. The day to day activities of wildlife at the feeder also can provide a colorful and endless supply of entertainment for everyone.

There is no single way to set up and maintain a successful feeding station. However, the following information can be used as a guide to help establish and operate a feeder. Backyard feeding often is a practice shared by many persons in the same area, and it never hurts to share tips about an activity as universally satisfying as backyard feeding.

TYPES OF FEEDERS

Feeders can be purchased or constructed to meet the needs of a variety of species. Four basic kinds generally are used.

The two feeders shown on pages 29 and 31 are gravity feeders that allow for continuous feeding and usually have a roof and either glass or plastic sides so the animals can see the food and operators know when it needs to be refilled.

Other feeders such as open shelf feeders may or may not have roofs and usually do not have sides except for a small rim which keeps the seeds from falling or blowing away. Uncovered feeders allow the animals to see danger and are popular because the birds and squirrels are very visible.

Ground feeders may or may not be elaborate. Food scattered over a clear plot of ground

constitutes a ground feeder; however, any platform, with or without a roof, placed on the ground is considered a ground feeder. One advantage of a ground feeder is that it attracts several species of birds that rarely visit feeders hung from trees, placed on poles or attached to a building.

Suet feeders commonly consist of either a small wire basket or a large mesh bag in which suet is placed. These feeders either are suspended or permanently affixed to the side of a tree, building or other feeder.

In addition to the four basic types of feeders, an endless variety of specialty feeders have been developed. Examples include pine cones dipped in fat, birdseed logs, strings of peanuts, berries or other tidbits, or open coconut shells stuffed with an assortment of delectables.

PLACEMENT OF FEEDERS

Protection from predators and weather should be the major objective in placing the feeder. Birds and squirrels always should be in easy reach of a perching or resting spot which affords protection, a placement near vegetation away from the house being a good choice. If time permits, let the birds pick a spot of their choice by moving the feeder and monitoring the use in each location.

Visual access to the feeder from the house is desirable for those who enjoy watching wildlife, and practical for those who are concerned with the maintenance of the feeders.

To attract a diversity of species, place the feeders where the animals feel at ease in visiting them. For instance, juncos and cardinals come to feeders near hedgerows, titmice and chickadees visit those in trees, and quail will be found only at those on the ground, squirrels will attempt to feed at all of these feeders.



FOOD

Following is a list of the most common food types and the wildlife they attract:

Sunflower seeds: grosbeaks, cardinals, titmice, chickadees, nuthatches, woodpeckers, finches, squirrels, mice.

Millets and small seed mixtures: cardinals, chickadees, titmice, nuthatches, woodpeckers, native sparrows, finches, juncos, towhees, blackbirds, mice.

Cracked corn: doves, jays, cardinals, towhees, juncos, native sparrows, woodpeckers, house sparrows, blackbirds, quail, mice, deer.

Thistle (niger) seed: goldfinches, siskings, redpolls, other finches.

Shelled peanuts: jays, woodpeckers, cardinals, grosbeaks, titmice, chickadees, nuthatches.

Suet: woodpeckers, titmice, chickadees, nuthatches, starlings, creepers, mockingbirds, wrens, jays, squirrels.

Assorted pieces of fruit (including raisins): mockingbirds, waxwings, robins, orioles, starlings.

Other foods that certain species relish include: worms, some vegetables, bakery products, cheese, chopped hard-boiled eggs, coconut meat, hominy, peppers, pumpkin and squash seeds.

A single food type usually does not provide an adequate nutritive variety. Therefore, a thoughtful blend developed for the specialized needs of the local wildlife should be available. An experimental feeder with several trays of different foods is one way of letting the animals select their own menu preferences. Bakery products may be popular with some birds, but provide little nutritive value. At best, they do a good job of attracting birds to the feeder where the conscientious operator will offer a range of nutritionally rich foods.

Careful planners can save money by buying each food type separately and in bulk quantities. Bags up to fifty pounds usually are available at feed and grain stores and often through various environmental organizations. Premixed packages may attract some buyers as they usually provide a blend of millets, milo, wheat, sunflowers and sometimes other ingredients. The cheapest packages usually are of poor quality, attracting the fewest number of birds and containing many materials that are not eaten.

Persons living in the country have access to nuts, seeds, berries and fruits that can be readily gathered and used in the feeder. If expense is a problem, some of the most expensive items — such as thistle seed (niger) — can be substituted with less costly alternatives, such as crushed sunflower seeds.

One thing in addition to food that seed-eating birds need is grit. Coarse sand is an excellent source of grit and it can be mixed directly in with the food or made available at a separate location. Crushed egg shells act as a grinding agent and also provide a needed source of calcium, which is in great demand during the spring months as birds are preparing to lay their eggs.

Don't assume that freezing temperatures curtail the birds' need for fresh water. Water is especially needed in the winter to keep feathers clean and in prime condition for body insulation. An electrical immersion water heater can be obtained rather inexpensively and placed in the water to keep it from freezing.

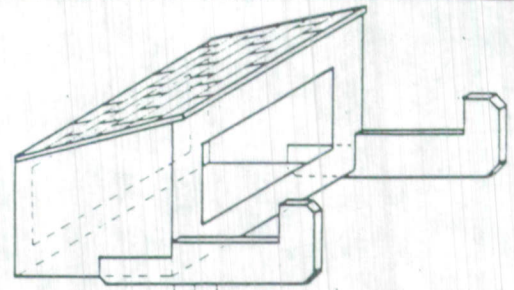

REVOLVING FEEDER

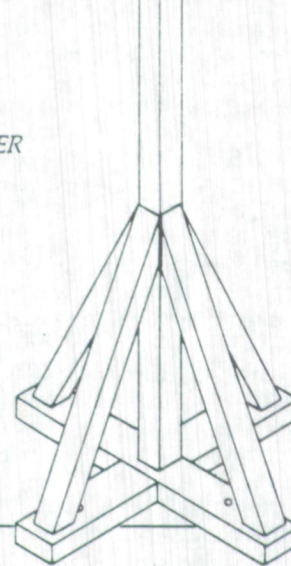

REVOLVING BIRDFEEDER

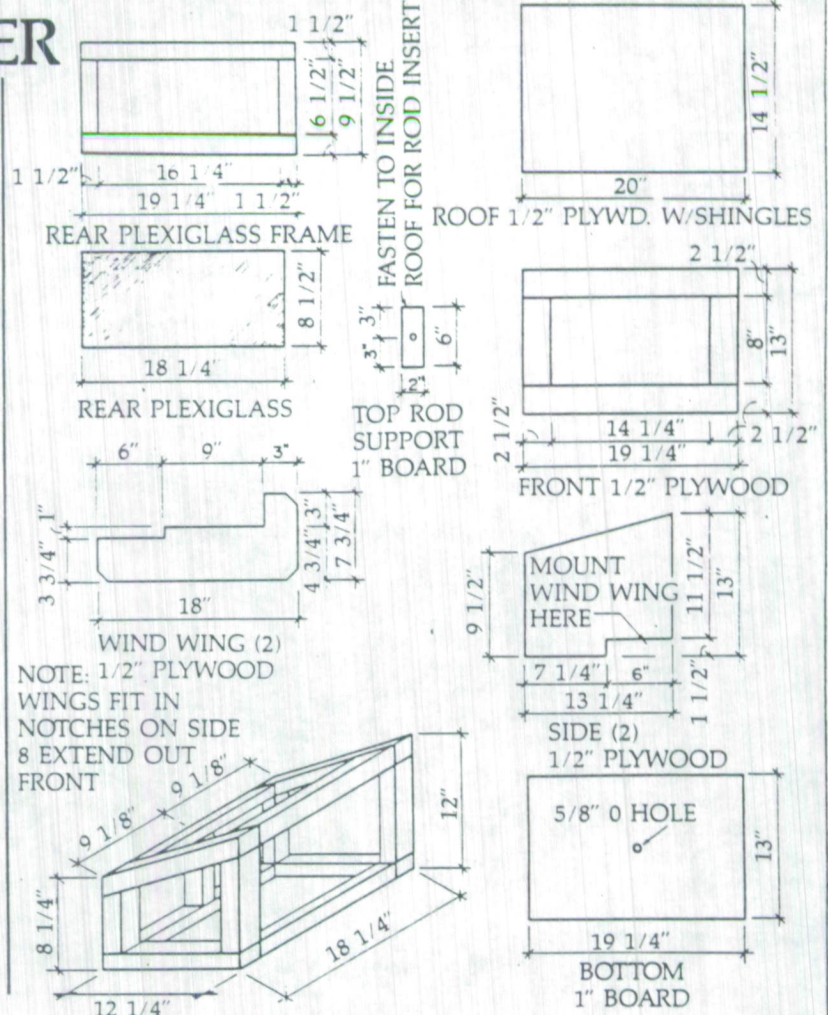
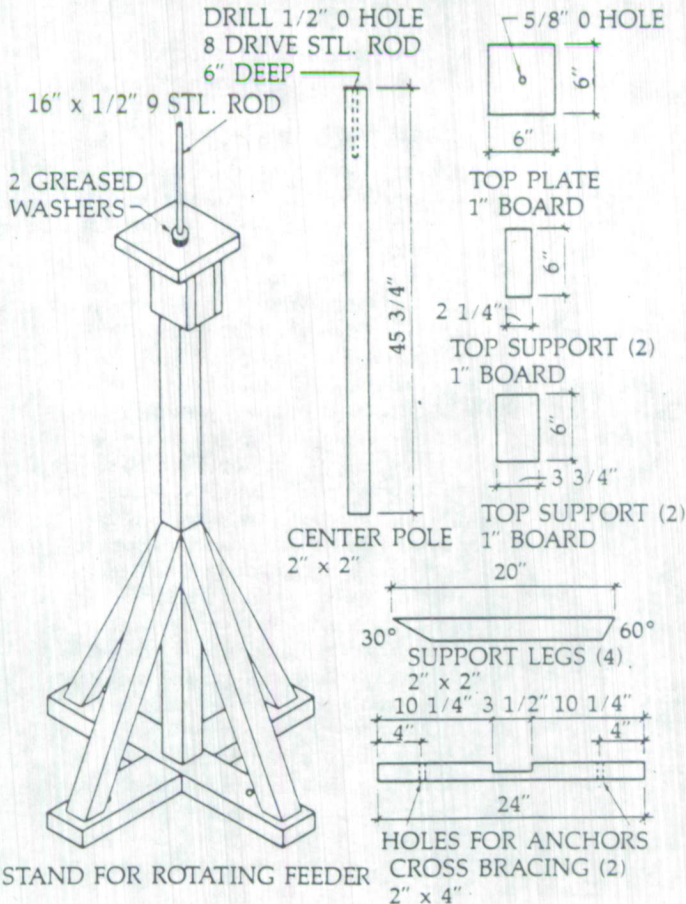

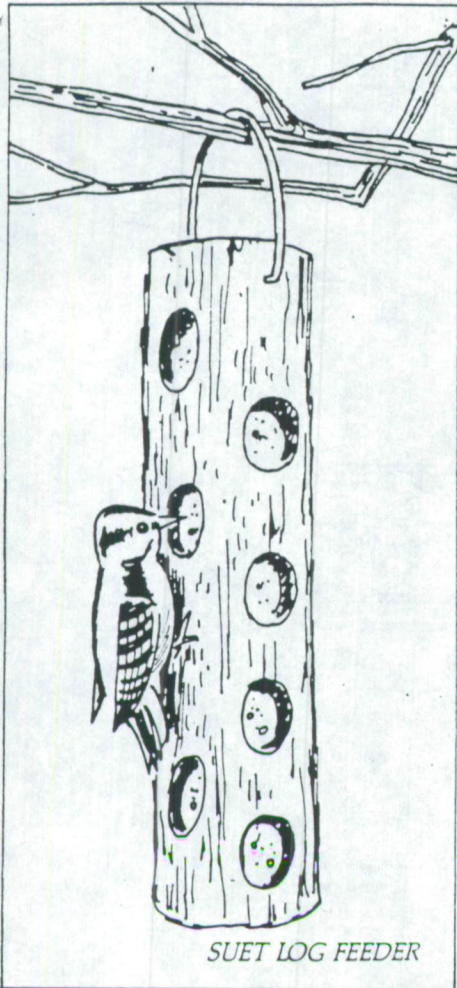

SUET LOG FEEDER

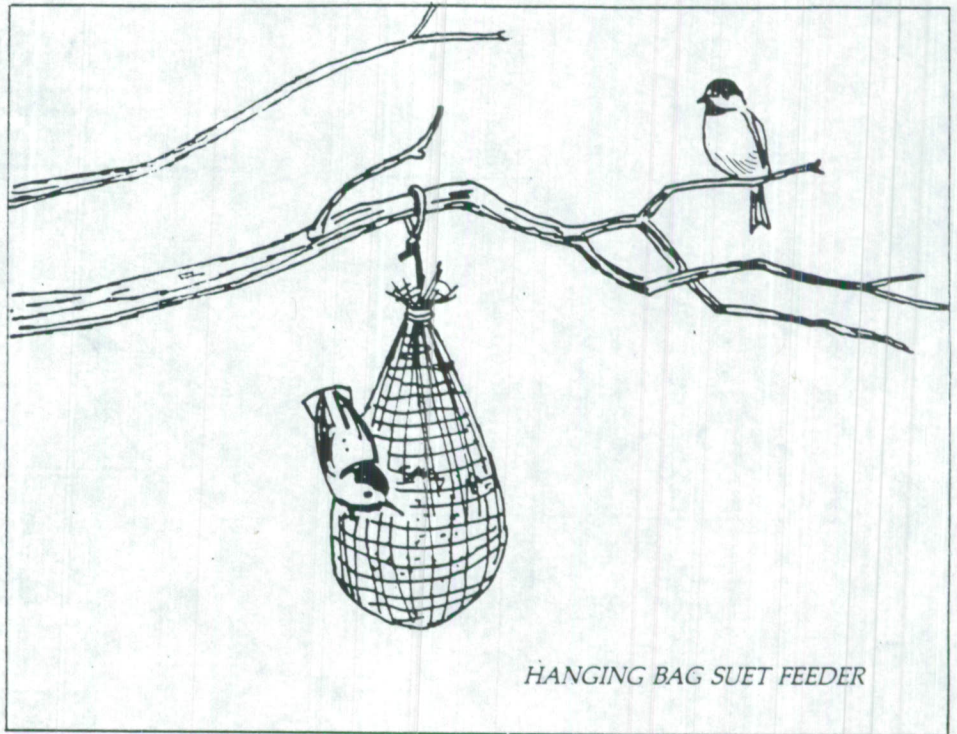

HANGING BAG SUET FEEDER

squirrels, an ear of corn on a stick, or a special feeder in a different area will work.

One common problem is birds flying into house windows during their approach to the feeder. A simple solution is to make the window or something directly behind the window visible so the birds won't fly in that direction. Venetian blinds or drapes are the best answers. A novel idea is to decorate the outside of the window with Christmas decorations or various silhouettes — including predators.

PERMANENT FEEDERS

The most attractive and longest lasting feeder is a plant which provides both food and shelter. A list of such plants that attracts a variety of species includes:

Trees: beech, black cherry, flowering dogwood, huckleberry, holly, junberry, mountain ash, mulberry, oaks, pine, red cedar, sassafras, sour gum, alder, ash, birch and elm.

Shrubs: blackberry, elderberry, pokeberry, sumac, viburnum, Virginia creeper, greenbrier, trumpet vine, high bush cranberry and wild grapes.

WHEN TO FEED

Plan to initiate the operation of your feeding station when the first snows or extreme cold temperatures are expected. Remember that the feeding station may attract more birds than the area naturally supports. Therefore, once feeding begins, food should be available continuously until at least April.

CARE AND MAINTENANCE

Initially, only a small amount of bird seed should be placed in the feeders since few birds will know that it is there. However, as the season advances, more and more birds will find and utilize the feeders, and more food can be dispensed. Eager operators often overstock their feeders and thereby allow excess food to spill, spoil or freeze. Naturally, much of the food that spills onto the ground is eaten by ground feeding birds or other animals, but if an excessive amount of food is spilled, you may wish to modify the feeders or your feeding rate.

When storing feed, keep it in a galvanized metal trash can, or a container that is both weather and rodent proof.

A squirrel guard or a metal circle placed below a bird feeder — folding out and down — is useful in discouraging squirrels and other small animals. However, if you wish to feed

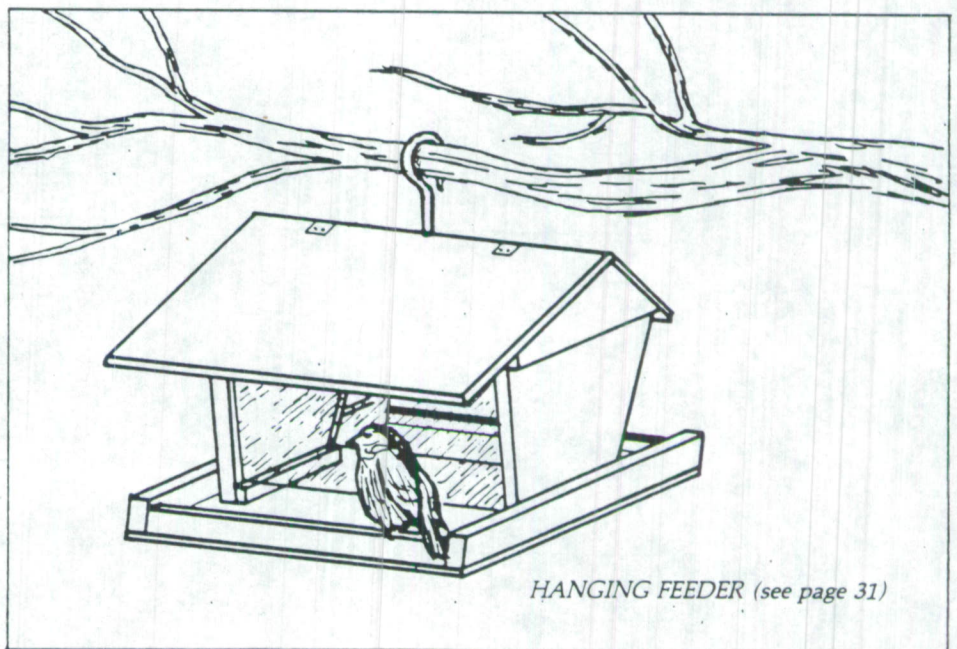

HANGING FEEDER (see page 31)

HANGING BIRDFEEDER

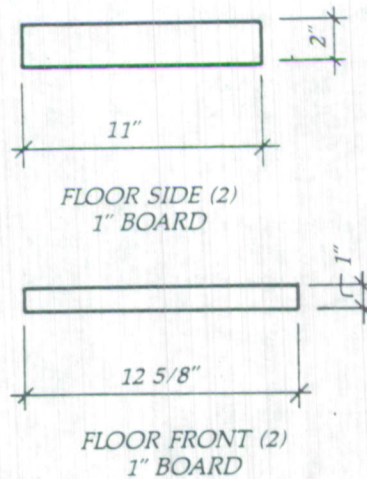
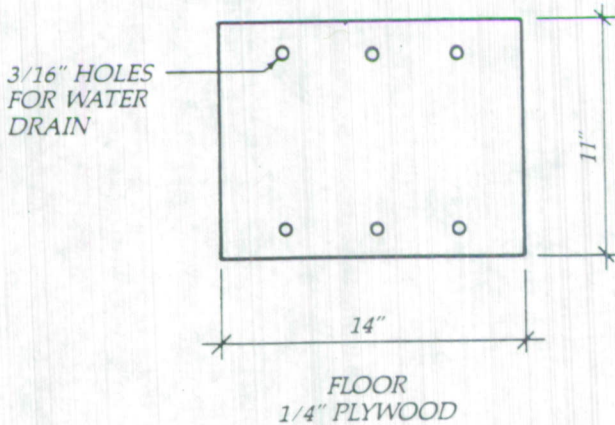
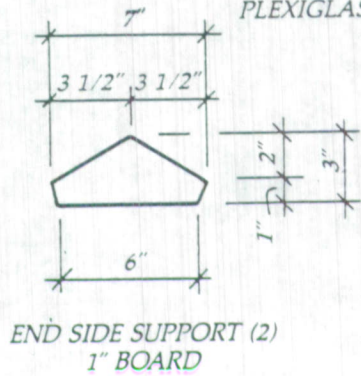
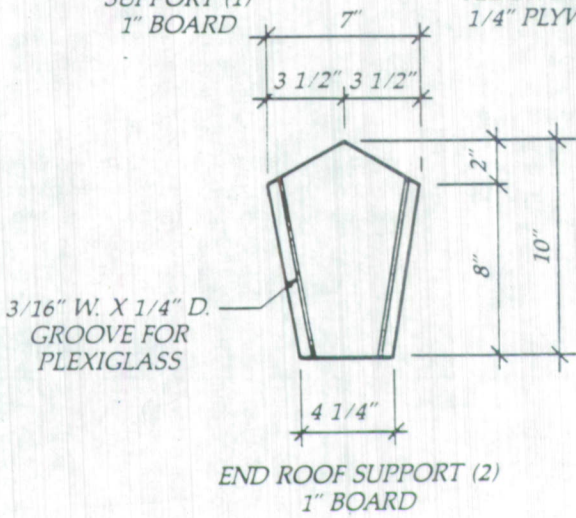
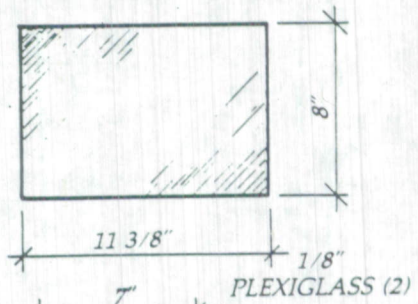
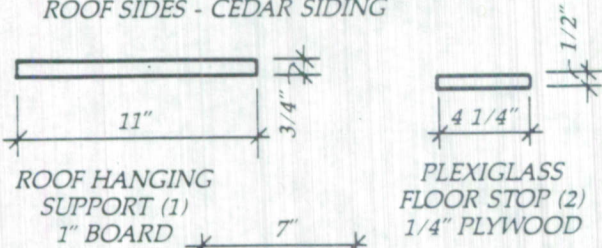
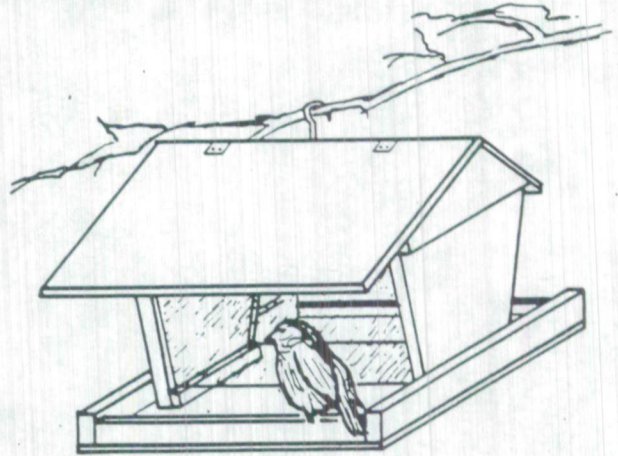
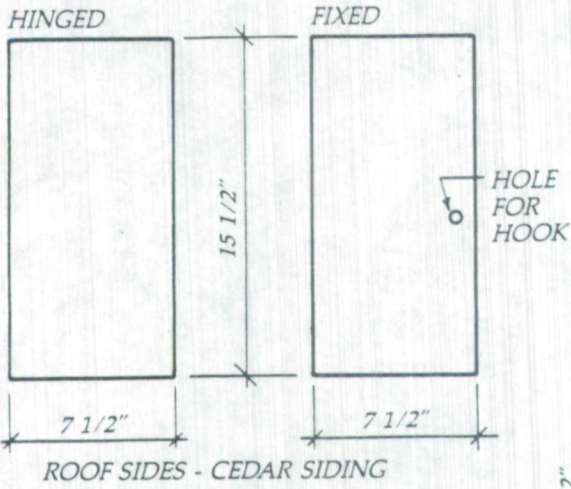

Squirrel Guard

A galvanized-iron funnel will keep climbing animals from getting into your feeders.

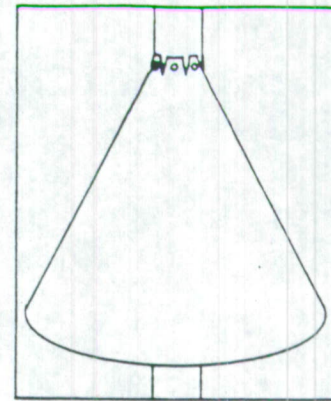
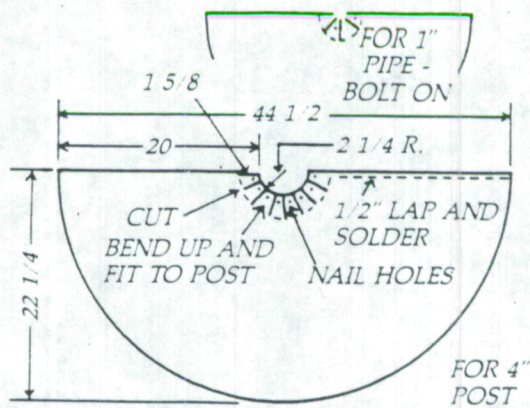

Tipping Guard

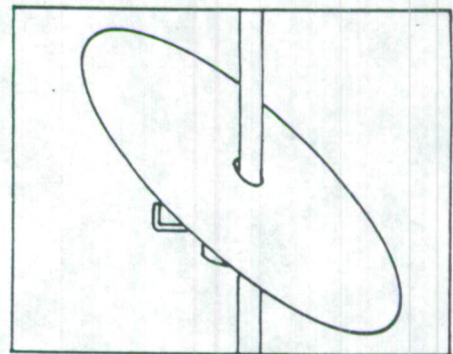
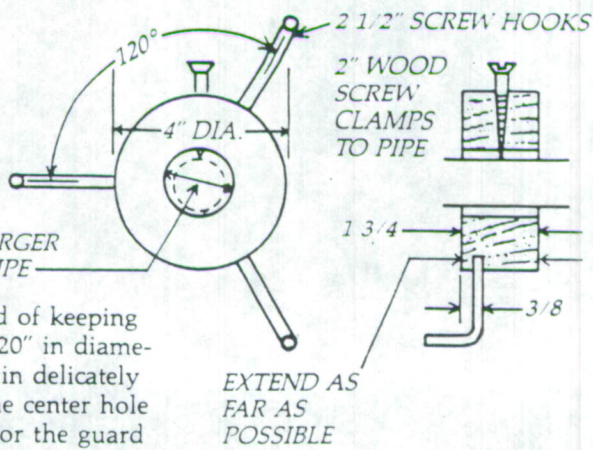
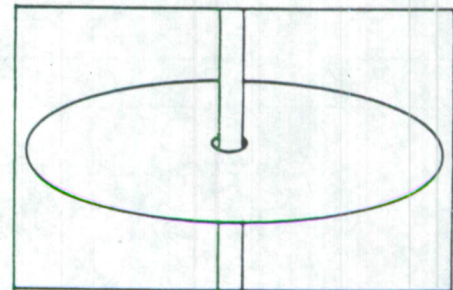
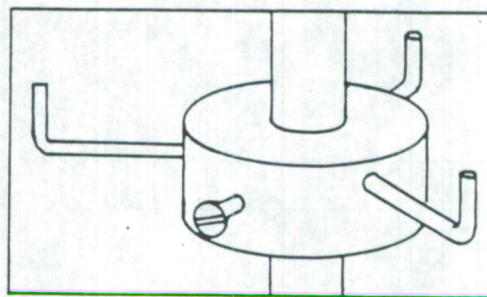

1/16" LARGER THAN PIPE

Another effective method of keeping squirrels off feeders is a 20" in diameter, *lightweight* piece of tin delicately balanced on the pole. The center hole should be large enough for the guard to tip a full 45° angle.

EXTEND AS FAR AS POSSIBLE

Tree Guard

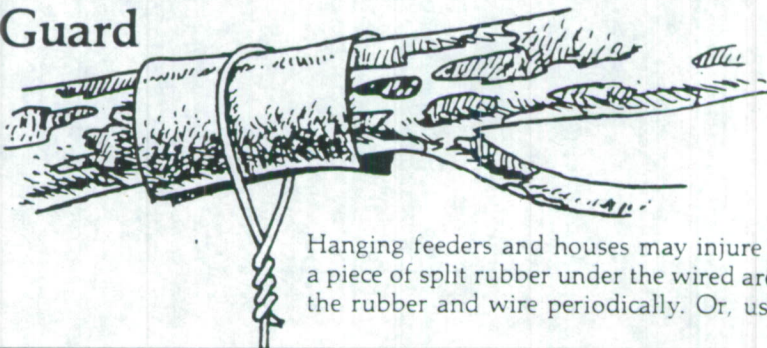

Hanging feeders and houses may injure bark unless the branch is protected. Try a piece of split rubber under the wired areas. Make sure you loosen and reposition the rubber and wire periodically. Or, use cotton rope to hang the feeder.

Additional Reading

Baldwin, Ed and Stevie Baldwin. *Building Bird Houses and Bird Feeders*. New York: Garden City, 1985.

Dawson, Verne E. *Attracting Birds: From the Prairies to the Atlantic*. New York: Thomas Y. Crowell Company, 1967.

Dennis, John V. *A Complete Guide to Bird Feeding*. New York: Alfred A. Knopf, Inc., 1976.

Schutz, Walter E. *Watching, Housing and Feeding*. Milwaukee, WI: Bruce Publishing Company, 1963.

Webber, William J. *Attracting Birds and Other Wildlife to Your Yard*. New York: Holt, Rinehart and Winston, 1982.

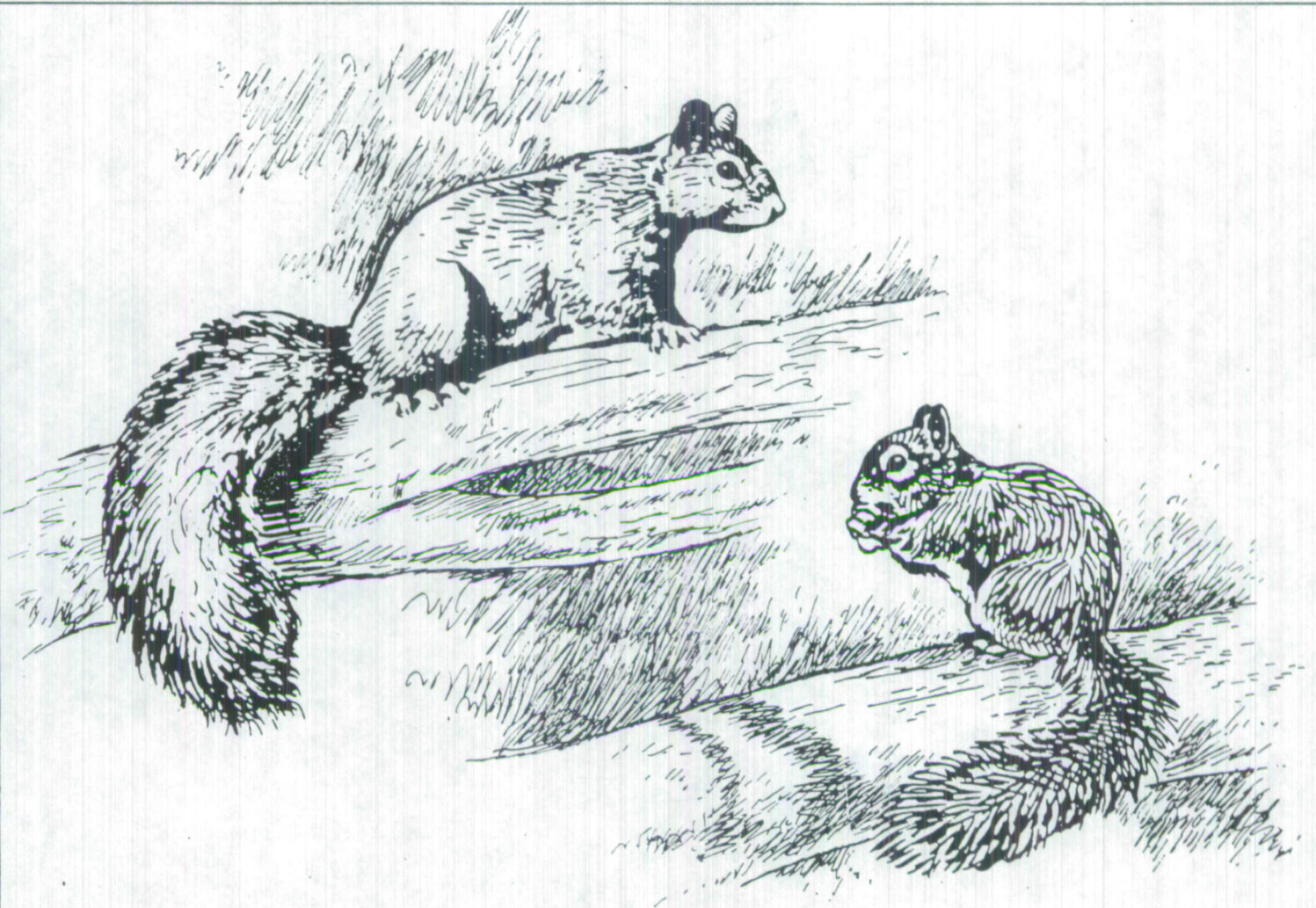

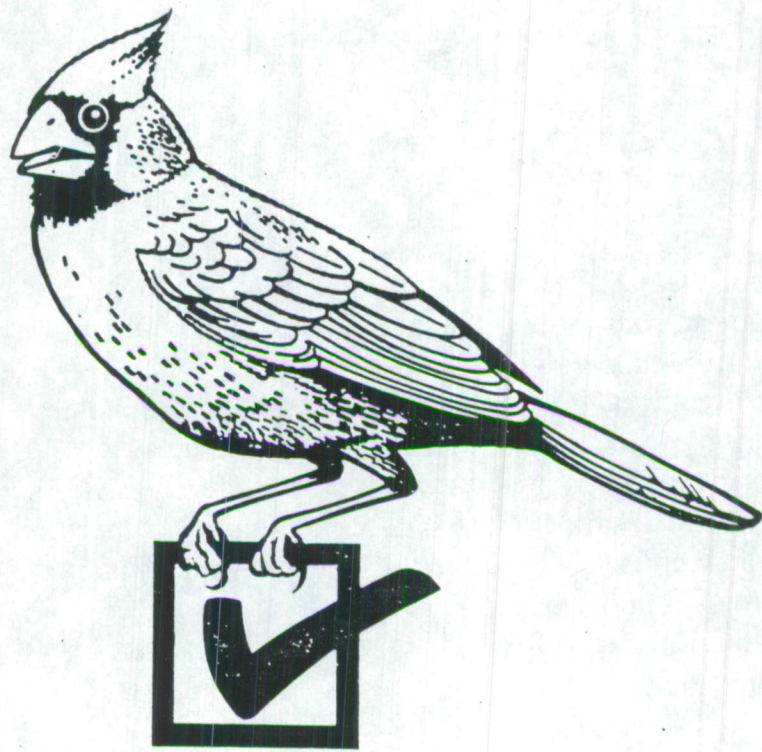

You can help save Illinois wildlife by giving a donation to the Illinois Wildlife Preservation Fund

ON YOUR ILLINOIS INCOME TAX RETURN

- You can contribute any amount over \$1.00 on your return to help wildlife.
- Your contribution will decrease your refund or increase your balance due. Your refund will not be delayed.
- After tax season, you can make a tax deductible donation to save Illinois Wildlife by sending a check or money order to: Illinois Wildlife Preservation Fund in care of: Illinois Department of Natural Resources, Natural Heritage Division, One Natural Resources Way, Springfield, IL 62702-1271

Thank you.

FOR MORE INFORMATION
CALL 217/785-8774

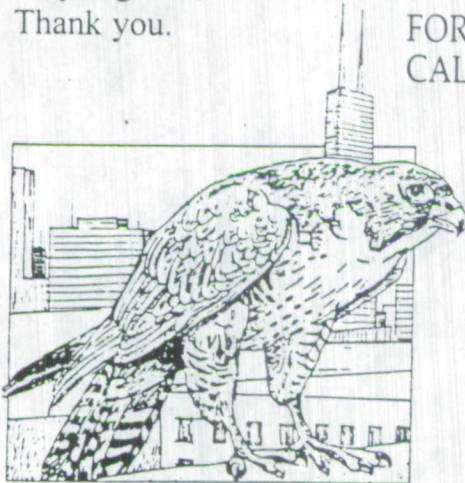

(Printed by the Authority of the
State of Illinois)

#R298350006-5M-12-2001

Equal opportunity to participate in programs of the Illinois Department of Natural Resources (IDNR) and those funded by the U.S. Fish and Wildlife Service and other agencies is available to all individuals regardless of race, sex, national origin, disability, age, religion or other non-merit factors. If you believe you have been discriminated against, contact the funding source's civil rights office and/or the Equal Employment Opportunity Officer, IDNR, One Natural Resources Way, Springfield, IL 62702-1271; 217/785-0067; TTY 217/782-9175.

