

# **Evaluation of Physical Separation Alternatives**

**for the Great Lakes  
and Mississippi River Basins in  
the Chicago Area Waterway System**

## **TECHNICAL REPORT APPENDIX**

**TO THE GREAT LAKES COMMISSION  
AND THE GREAT LAKES AND  
ST. LAWRENCE CITIES INITIATIVE**







## **APPENDIX A. TECHNICAL INFORMATION**

### **A1. LITERATURE REVIEWED**

### **A2. US SUPREME COURT CONSENT DECREE**

### **A3. FLOOD MANAGEMENT DATA AND ANALYSIS**

- FLOOD MANAGEMENT IMPROVEMENTS METHODOLOGY
- HYDRAULIC SUPPLEMENTAL DATA

### **A4. WASTEWATER IMPROVEMENTS TECHNICAL MEMO**

### **A5. ECOLOGICAL HEALTH TECHNICAL MEMO**

### **A6. TRANSPORTATION MARKET ASSESSMENT-EXECUTIVE SUMMARY**

### **A7. TRANSPORTATION MARKET ASSESSMENT-FULL REPORT**

### **A8. TRANSPORTATION TECHNICAL MEMO**



**A1. LITERATURE REVIEWED**





## **WORK CITED AND LITERATURE REVIEWED**

- AECOM Reservoir Design Partners, JV. 2010. Chicago Downtown Flooding Study Final Report. Contract Number W912EK-09-D-0008. Task Order 0016. Chicago, Illinois.
- Alexander, Ann. 2011. Notice of Filing. Water Quality Standards and Effluent Limitations for the Chicago Area Waterway System and the Lower Des Plaines River: Proposed Amendment to 35 Ill. Adm. Code Parts 301, 302, 303, and 304. Comments of Environmental Groups on the Proposed Rules Establishing Recreational Use Designations for the Chicago Area Waterway System and Lower Des Plaines River. Natural Resources Defense. Chicago, Illinois.
- Alp, E., Melching, C.S., Zhang, H. and Lanyon, R. 2007. Effectiveness of combined sewer overflow treatment for dissolved oxygen improvement in the Chicago Waterways. *Water Science & Technology*, Vol. 56, No. 1, pages 215–222.
- Alp, Emre and Melching, Charles. 2008. Institute for Urban Environmental Risk Management Technical Report #19. Evaluation of Procedures to Prevent Flow Reversals to Lake Michigan from the Chicago Waterway System. Milwaukee, Wisconsin.
- Andes, Fredric and Ballard, David. 2010. Notice of Filing. Water Quality Standards and Effluent Limitations for the Chicago Area Waterway System and the Lower Des Plaines River: Proposed Amendment to 35 Ill. Adm. Code Parts 301, 302, 303, and 304. Metropolitan Water Reclamation District of Greater Chicago's Comments on the First Notice of Proposed Rules Establishing Recreational Use Designations for the CAWS and LDPR. Barnes and Thornburg LLP. Chicago, Illinois.
- Asian Carp Regional Coordinating Committee. 2010. Asian Carp Regional Coordinating Committee Announces Three-Month Monitoring and Sampling Plan.
- Asian Carp Regional Coordinating Committee Website. [www.AsianCarp.us](http://www.AsianCarp.us). Accessed 2011.
- Bolen, Bill. 2012. Personal communication regarding the expense of Asian carp control. USEPA.
- Boyle, Kevin. 2008. Evidence of Kevin Boyle on behalf of the Illinois Pollution Control Board.
- Bretthauer, Vicki W. and Martland, Carl D. Cambridge Systematics, Inc. 2007. Regional Freight System Planning Recommendations Study. Prepared for CMAP. Chicago, Illinois.
- Brammeier, J., Polls, I. and Mackey, S. 2008. Preliminary Feasibility of Ecological Separation of the Mississippi River and the Great Lakes to Prevent the Transfer of Aquatic Invasive Species. Great Lakes Fisheries Commission.
- Austin, J.C., Andersen, S. and Litan, R.E. 2007. *Healthy Waters, Strong Economy: The Benefits of Restoring the Great Lakes Ecosystem*. The Brookings Institute.
- Buck, E., Upton, H.F., Stern, C.V. and Nichols, J.E. 2010. Asian Carp and the Great Lakes Region. Congressional Research Service.
- Burch, Stephen. 1991. The Chicago Model: A Reassessment of the Impacts of Lake Michigan Allocations on the Cambrian-Ordovician Aquifer System in Northeastern Illinois. Illinois State Water Survey Department of Energy and Natural Resources. Chicago, Illinois.

- Burlington Northern Santa Fe, LLC. 2010. Financial Information Performance Summary. [www.bnsf.com/about-bnsf/financial-information/](http://www.bnsf.com/about-bnsf/financial-information/) Accessed April 7, 2011.
- Canadian National Railroad. 2010. Quarterly Releases and Dividends. [www.cn.ca/en/investors-financial-quarterly-releases-dividends-2010.htm](http://www.cn.ca/en/investors-financial-quarterly-releases-dividends-2010.htm). Accessed April 7, 2011.
- Canadian Pacific Railway. 2010. CPRS Investor Relations. [www8.cpr.ca/cms/English/Investors/Financial/Annual+Report.htm](http://www8.cpr.ca/cms/English/Investors/Financial/Annual+Report.htm). Accessed April 7, 2011.
- CenterPoint Properties. CenterPoint Intermodal Center, Joliet, Illinois. [www.centerpoint-prop.com](http://www.centerpoint-prop.com). Accessed September 2011.
- Changnon, Stanley A. 2010. Journal of Contemporary Water and Research Education. Stormwater Management for a Record Rainstorm at Chicago. Issue 146. Pages 103 – 109. Universities Council on Water Resources. Chicago, Illinois.
- Chicago Architecture Foundation/Park Friends. 2006. Chicago Park District – District-Wide Harbor Study. Chicago, Illinois.
- Chicago Metropolis 2020. 2007a. Building a Great Transit System for the Chicago Region. Chicago, Illinois.
- Chicago Metropolis 2020. 2007b. Time is Money. The Economic Benefits of Transit Investment. Chicago, Illinois.
- Chicago Park District. JJR. 2007. Chicago Lakefront Harbor Framework Plan.
- Chicago Southland Economic Development Corporation. 2007. Calumet River Corridor Economic Development Vision and Strategy.
- Chicago Wilderness. No Date. Chicago Wilderness Climate Action Plan for Nature.
- Christopher B. Burke Engineering, Ltd. 2011. Metropolitan Water Reclamation District of Greater Chicago. Draft Water Management Ordinance. Economic Impact Study Engineering Analysis Report. Chicago, Illinois.
- Circuit Clerk’s Office. Notice of Filing. Water Quality Standards and Effluent Limitations for the Chicago Area Waterway System and the Lower Des Plaines River: Proposed Amendment to 35 Ill. Adm. Code Parts 301, 302, 303, and 304. Exhibit E. Attachment 3 to Pre-filed Testimony of Adrienne D. Nemura. Chicago, Illinois.
- City of Chicago, Department of Housing and Economic Development. 2011. Chicago Sustainable Industries. Phase One: A Manufacturing Work Plan for the 21st Century. Chicago, Illinois.
- City of Chicago, Department of Planning. 2002. Calumet Area Land Use Plan. Chicago, Illinois.
- City of Chicago, Department of Planning. 2005. Calumet Open Space Reserve Plan. Chicago, Illinois.
- City of Chicago, Department of Planning and Development. 1999. Chicago River Corridor Development Plan.

- City of Chicago, Department of Water Management. 2011. Data collected by the City of Chicago for Stormwater Management Ordinance from 2008 to 2011.
- City of Chicago, Office of the Mayor. 2011. Press Release: Mayor Rahm Emanuel Announces Plans to Make the Chicago River the City's Next Recreational Frontier.
- CMAP. Congestion Management Program. 2008. Waterborne Commerce on the Illinois Waterway and the Port of Chicago Flow of Commerce in Tons. Chicago, Illinois.
- CMAP. 2010a. GO TO 2040 Regional Comprehensive Plan. Chicago, Illinois.
- CMAP. 2010b. Water 2050 Northeastern Illinois Regional Water Supply/Demand Plan. Chicago, Illinois.
- CMAP. 2011. Transportation Improvement Program, 2010-2015.
- Cole, Richard. 2006. Freshwater Aquatic Nuisance Species Impacts and Management Costs and Benefits at Federal Water Resources Projects. Aquatic Nuisance Species Research Program.
- Collier, D. and Cieniawski, S. 2003. October 2000 and August 2002 Survey of Sediment Contamination in the Chicago River, Chicago, Illinois. Chicago, Illinois.
- Corn, L., Buck, E., Rawson, J., Segarra, and Fishcher, E. 2002. Invasive Non-Native Species: Background and Issues for Congress. Report RL30123. Congressional Research Service, The Library of Congress.
- CREATE. 2011. Chicago Region Environmental and Transportation Efficiency Program. Final Feasibility Plan Amendment 1. Chicago, Illinois.
- Croke, K., Fabian, R., and Brenniman, G. 1986. Estimating the value of improved water quality in an urban river system. *Journal of Environmental Systems* 16 (1), 13–23.
- CSXT. 2010. Financial Reports and Filings. [investors.csx.com/phoenix.zhtml?c=92932&p=irol-reportsannual](http://investors.csx.com/phoenix.zhtml?c=92932&p=irol-reportsannual). Accessed April 7, 2011.
- CTE | AECOM. 2006. Technical Memorandum 3 WQ Study of End-of-Pipe Combined Sewer Overflow (CSO) Treatment. Master Plan. Metropolitan Reclamation District of Greater Chicago. North Side Water Reclamation Plant. Chicago, Illinois.
- Daley, Richard M. 2005. Chicago River Agenda. Chicago, Illinois.
- Daniels, Steve. 2011. Madigan Rejects Emanuel Deal to Close Chicago Coal Plants. *Crain's Chicago Business*.
- Dorevitch, MD, MPH, Samuel and the CHEERS Research Group. 2010. CHEERS Research Update. An Interim Technical Report Prepared for Submission to the Illinois Pollution Control Board. University of Illinois at Chicago School of Public Health.

- Durgunoglu, Ali, Singh, K., Butts, Thomas A. and Shackleford, Dana. 1992. Office of Surface Water Resources and Systems Analysis. Volume 1: Hydraulics and Hydrology. Volume 2: Water Quality. Reduction in Peak Flows and Improvements in Water Quality in the Illinois Waterway Downstream of Lockport Due to Implementation of Phases I and II of TARP. Champaign, Illinois.
- Dziegielewski, B. and Chowdhury, F.J. 2008. Regional Water Demand Scenarios for Northern Illinois 2005–2050. Project Completion Report. Southern Illinois University at Carbondale.
- EA Engineering, Science, and Technology. The Upper Illinois Waterway Study Interim Report. 1994 Ichthyoplankton Investigation RM 276.2-321.7. Deerfield, Illinois.
- Energy Ventures Analysis, Inc. 2006. Economics for Alternative Coal Delivery for the Will County, Fisk, and Crawford Generating Systems.
- Ettinger, Albert. 2008. Notice of Filing. Water Quality Standards and Effluent Limitations for the Chicago Area Waterway System and the Lower Des Plaines River: Proposed Amendment to 35 Ill. Adm. Code Parts 301, 302, 303, and 304. Testimony of Laura Barghusen Openlands. Chicago, Illinois.
- FISHPRO. 2004. Feasibility Study to Limit the Invasion of Asian Carp into the Upper Mississippi River Basin. Springfield, Illinois.
- Fitzpatrick, Kevin. 2010. Welcome to the May Edition of the 2010 M&R Seminar Series. The Metropolitan Water Reclamation District of Greater Chicago.
- Friends of the Chicago River. 2000a. Waterways for Our Future. A collaborative study of the water, land, and governance/organizational structure of the Metropolitan Water Reclamation District and their impact on the Chicago River waterways.
- Friends of the Chicago River. 2000b. Waterways for Our Future. Land Management Policies, Land Holdings, and Regional Open Space Opportunities. A collaborative study of the water, land, and governance/organizational structure of the Metropolitan Water Reclamation District and their impact on the Chicago River waterways.
- Friends of the Chicago River. 2007. Action Plan for the Chicago River: Getting Specific. Strategies for a Cleaner, Healthier, More Vibrant Chicago River. Cook County, Illinois.
- Emerton, L. and Howard, G. 2008. A Toolkit for the Economic Analysis of Invasive Species, Global Invasive Species Programme.
- Gaden, Marc. 2012. Personal communication regarding the annual costs of sea lamprey control. Great Lakes Fishery Commission.
- GLC. 2011. GLC CAWS Barge Background Brief. HDR Chicago Charrette. Chicago, Illinois.
- Grant Application Package. 2011. U.S. EPA Great Lakes Restoration Initiative 2011 Request. CFDA No. 66.469. Opportunity No. EPA-R5-GL2011-1. Chicago, Illinois.



- Harley, Keith. 2010. Notice of Filing. Water Quality Standards and Effluent Limitations for the Chicago Area Waterway System and the Lower Des Plaines River: Proposed Amendment to 35 Ill. Adm. Code Parts 301, 302, 303, and 304. The Southeast Environmental Task Force's Final Comments on Recreational Uses. Chicago, Illinois. Chicago Legal Clinic, Inc.
- HDR. 2010. A Radar-based Rainfall Reconstruction Analysis of the September 13<sup>th</sup>, 2008 Rainfall Event. Northern Cook County and Lake County, Illinois. Chicago, Illinois.
- Hill, Charles Shattuck. 1896. The Chicago Main Drainage Channel. A Description of Machinery Used and Methods of Work Adopted in Excavating the 28-Mile Drainage Canal from Chicago to Lockport, Illinois. Chicago, Illinois.
- Huff, F. A., and J. R. Angel. 1989. Rainfall Distributions and Hydroclimatic Characteristics of Heavy Rainstorms in Illinois (Bulletin 70), Illinois State Water Survey.
- Hughes, S. Chicago Park District. 2012. Personal conversation with D. Ullrich. Jan 8, 2012.
- Illinois DNR and USACE. 2007. Illinois River Basin Restoration Comprehensive Plan with Integrated Environmental Assessment Final.
- Illinois DOT. 2003. Final Environmental Impact Statement for the Chicago to St. Louis High Speed Rail Project.
- Illinois EPA. 2007. Midwest Generation Presentation to UAA Stockholders Group. Appropriate Thermal Water Quality Standards for the Chicago Sanitary and Ship Canal and Lower Des Plaines River, Attachment SS. Chicago, Illinois.
- Illinois EPA. 2010. Illinois Integrated Water Quality Report and Section 303(d) List.
- Illinois International Port District. 2002. Economic Impact Study Executive Summary.
- Illinois International Port District. [www.theportofchicago.com./port](http://www.theportofchicago.com./port) facilities. Accessed 9/26/2011.
- Inland ENC Harmonization Group. 2008. Inland Electronic Navigational Chart Encoding Guide.
- International Joint Commission. 2006. A Guide to the Great Lakes Water Quality Agreement, Background for the 2006 Governmental Review.
- Iowa Department of Transportation. 2008. Barge Capacity Comparisons. Ames, Iowa.
- Jerde, Christopher L., Mahon, Andrew R., Chadderton, W. Lindsay, and Lodge, David M. 2010. "Sight-unseen" detection of rear aquatic species using environmental DNA. Conservation Letters 00 (2011) 1–8. Correspondence.
- Kapos, Shia. Crain's Chicago Business. August 8, 2011. Sailing Slump Leaves Chicago Scrambling to Fill Empty Boat Slips.
- Kollias, Louis. 2010. Report No. 10-28. Tunnel and Reservoir Plan Des Plains Tunnel System 2009 Annual Groundwater Monitoring Report. Monitoring and Research Department. Chicago, Illinois.

- Kruger, David, P. Eng., MCIP. 2005. Presentation to the 2005 Great Lakes Conference and Biennial Meeting of the IJC. Freight Flows in the Great Lakes Region. iTRANS Consulting, Inc. Kingston, Ontario.
- Kruse, C. James, Protopapas, Annie, Olson, Leslie E. and Bierling, David H. Center for Ports and Waterways Texas Transportation Institute. 2009. A Modal Comparison of Domestic Freight Transportation Effects on the General Public. Houston, Texas.
- Lanyon, Richard. 2010. Appendix. Affidavit of Richard Lanyon.
- Lanyon, Richard. Metropolitan Water Reclamation District of Greater Chicago. 2006. Transmittal Letter for Board Meeting. Endocrine Disrupting Compounds, Antibiotics, and Other Pharmaceuticals in the Water Environment.
- Lanyon, Richard. October 2010. Metropolitan Water Reclamation District of Greater Chicago. Separation of the Great Lakes and Mississippi River Watersheds. Presentation.
- Lanyon, Richard. 2011. Personal communication with Richard Lanyon, former director of Metropolitan Water Reclamation District of Greater Chicago.
- Tetra Tech EM Inc. 2010. Little Calumet River Rapid Response Fish Identification and Enumeration Branch Summary Report. Prepared for U.S. Environmental Protection Agency Great Lakes National Program Office, Illinois Department of Natural Resources. Chicago, Illinois.
- Lodge, David. 2008. Economic Impact of Ballast-Mediated Invasive Species in the Great Lakes.
- Lovell, S. and Stone, S. 2005. The Economic Impacts of Aquatic Invasive Species: A Review of the Literature. National Center for Environmental Economics.
- Lubin, Donald G. and Ranney, Jr., George A. 2004. Chicago Metropolis 2020: The Metropolis Freight Plan: Delivering the Goods. Chicago, Illinois.
- MacDonald, D. D., C.G. Ingersoll, and T.A. Berger. 2000. Development and evaluation of consensus-based sediment quality guidelines for freshwater ecosystems. Archives of Environmental Contamination and Toxicology, 39:20-31.
- Martin Associates. 2010. Economic Impacts of Waterborne Shipping on the Indiana Lakeshore. Lancaster, Pennsylvania.
- Melching, Charles. 2011. GLC Hydraulics Presentation. Background on the Hydraulics of Chicago Area Waterway System. Evaluation of Procedures to Prevent Backflows to Lake Michigan from the Chicago Waterway System. Milwaukee, Wisconsin.
- Metropolitan Planning Council. 2008. Moving at the Speed of Congestion: The True Cost of Traffic in the Chicago Metropolitan Area. Chicago, Illinois.
- MWRDGC. 1996. Description of the Metropolitan Water Reclamation District of Greater Chicago Regional Open Space Entities' Letters of Intent. City of Blue Island. App. D.
- MWRDGC. 2000. Description of the Metropolitan Water Reclamation District of Greater Chicago Aerial Descriptions. Channel Atlas Lands. Appendix A.

- MWRDGC. 2009a. Calumet Water Reclamation Plant Facility Improvements Master Plan for the Future. Chicago, Illinois.
- MWRDGC. 2009b. Report No. 09-25: Microbiological Report of Bypass Samples in 2008, Chicago, Illinois. Report to the Metropolitan Water Reclamation District of Greater Chicago.
- MWRDGC. 2009c. Stickney Water Reclamation Plant. Facility Improvements. Master Plan for the Future. Chicago, Illinois.
- MWRDGC. 2009d. TARP Status Report as of December 1, 2009.
- MWRDGC. 2009e. Description of the Metropolitan Water Reclamation District of Greater Chicago Regional Open Space Plans. Regional Greenways and Trails Plan Draft. App. C.
- MWRDGC. 2010. Report No. 10-28: Tunnel and Reservoir Plan Des Plaines Tunnel System, 209 Annual Groundwater Monitoring Report, Chicago, Illinois. Report to the Metropolitan Water Reclamation District of Greater Chicago.
- MWRDGC. M&O Facilities Handbook. 2002.
- MWRDGC. No Date. Monitoring Stations along the Illinois Waterway from Lockport Lock to Peoria Lock. Chicago, Illinois.
- MWRDGC. Research and Development Department. 2008. Description of the Chicago Waterway System for the Use Attainability Analysis. Report No. 08-15R. Chicago, Illinois.
- MWRDGC. M&O Facilities Handbook. 2011.
- Meyers-Glen, Stacy. 2010. Notice of Filing. Water Quality Standards and Effluent Limitations for the Chicago Area Waterway System and the Lower Des Plaines River: Proposed Amendment to 35 Ill. Adm. Code Parts 301, 302, 303, and 304. Environmental Groups' Final Comments Supporting Recreational Use Designations for the CAWS and Lower Des Plaines River. Chicago, Illinois.
- Holeck, K.T., Mills, E., MacIsaac, H.J., Dochoda, M., Coluatti, R., and Ricciardi, A. 2004. Building Troubled Waters: Biological Invasions, Transoceanic Shipping, and the Laurentian Great Lakes. *Bioscience*, 54 (10): 919-929.
- Missouri vs. Illinois SCOTUS\_1900.
- Missouri vs. Illinois SCOTUS\_1906. Westlaw Delivery Summary Report for McCahan, Graham.
- Missouri vs. Illinois SCOTUS\_1925.
- Mitchell, Timothy. General Superintendent and CEO, Chicago Park District. 2009. Rule Making R-08-009 Letter. Chicago, Illinois.
- National Research Council of the National Academies. 2008. Transportation Research Board Special Report 291. Great Lakes Shipping, Trade, and Aquatic Invasion Species.
- Norfolk Southern Corporation. 2010. Annual Financial Report.  
[www.nscorp.com/nscportal/nscorp/Investors/Financial\\_Reports/Annual%20Report/](http://www.nscorp.com/nscportal/nscorp/Investors/Financial_Reports/Annual%20Report/). Accessed April 8, 2011.

- Northwestern Indiana Regional Planning Commission. 2007. Connections 2030 Regional Transportation Plan.
- Northern Illinois Hydropower, LLC. 2009. Northern Illinois Hydropower, LLC, Brandon Road Hydropower Project (FERC No. 12717) Application for License for Major Project – Existing Dam. Exhibit B. Project Operation and Resource Utilization. Chicago, Illinois.
- NRDC. 2010a. Hydrological Separation Meeting Notes.
- NRDC. 2010b. Rebuilding Chicago’s Stormwater and Wastewater Systems for the 21<sup>st</sup> Century: Understanding Hydrologic Conditions in the Region Technical Report.
- NRDC. 2010c. Re-Envisioning the Chicago River: Adopting Comprehensive Regional Solutions to the Invasive Species Crisis. Chicago, Illinois.
- Office of the Federal Register, National Archives and Records Administration (NARA). 1999. Executive Order 13112 Federal Register: Volume 64, Number 25. Feb 8, 1999.
- Office of Management and Budget (OMB). 1992. Circular No. A-94 Revised. Executive Office of the President.
- Office of Ocean and Coastal Resources Management National Oceanic and Atmospheric Administration, U.S. Department of Commerce and Illinois DNR. 2011. U.S. Department of Commerce: Draft Environmental Impact Statement for the Illinois Coastal Management Program. Silver Springs, Maryland and Chicago, Illinois.
- Ports of Indiana. 2011a. Major Cargoes Handled. [www.portsofindiana.com](http://www.portsofindiana.com). Accessed 9/26/2011.
- Ports of Indiana. 2011b. Burns, Jeffersonville, and Mount Vernon data. [www.portsofindiana.com](http://www.portsofindiana.com). Accessed 9/26/2011.
- Ricciardi, Anthony. 2001. Invasional Meltdown in the Great Lakes, Past, Present & Future Species Introductions. Redpath Museum & McGill School of Environment. McGill University.
- Ross, Philippe E., Henebry, Michael S., Risatti, J. Bruno, Murphy, Thomas J., Demissie, Misganaw, Burnett, and LouAnn C. 1988. A Preliminary Environmental Assessment of the Contamination Associated with Lake Calumet, Cook County, Illinois. Lake Calumet, Cook County, Illinois. WMRC (Waste Management and Research Center) Reports.
- Schwieterman, PhD, Dr. Joseph P. DePaul University. 2010. An Analysis of the Economic Effects of Terminating Operations at the Chicago River Controlling Works and O’Brien Locks on the Chicago Area Waterway System. Chicago, Illinois.
- Sharoff, Robert. 2010. Chicago to Redevelop U.S. Steel Site on Lakefront. New York Times. New York.
- Sloan, Patrick and Kozicki, Sharon. 2010. 35% Design Report Calumet-Sag Channel. Cook County, Illinois. Project I.D. 09U050.03. USACE Rock Island District. Contract Number W912EK-09-D-0008. Foth Infrastructure and Environment, LLC. Green Bay, Wisconsin.
- SSMMA. 2010. Lake Riverdale Sustainable Master Plan.



- State of Illinois. 2011. [www.Millennium Reserve.illinois.gov](http://www.Millennium Reserve.illinois.gov). Press Release 12/9/2011.
- Taylor, Dr. John C. and Roach, James L. 2005a. Ocean Shipping in the Great Lakes: Transportation Cost Increases that would Result from A Cessation of Ocean Vessel Shipping. East Lansing, Michigan and Grand Rapids, Michigan.
- Taylor, Dr. John C. and Roach, James L. 2005b. The Great Lakes St. Lawrence Seaway System: Transportation Cost Penalties Related to Potential Elimination of Ocean Cargo Vessel Passages into the Lakes. International Joint Commission Biennial Meeting AIS Workshop. East Lansing, Michigan and Grand Rapids, Michigan.
- Taylor, Dr. John C. and Roach, James L. 2007. Ocean Shipping in the Great Lakes: An Analysis of Issues. Phase II. East Lansing, Michigan and Grand Rapids, Michigan.
- Texas Transportation Institute. 2011. 2011 Urban Mobility Report.
- The Louis Berger Group, Inc. 2007. USACE Humphrey Engineering Support Center. NESP Economic Evaluation Upper Mississippi and Illinois Waterway Traffic Forecast for Non-Grain Commodities.
- Union Pacific Railroad. 2010. UP: Annual Reports and Proxy Statements. [www.up.com/investors/annuals/index.shtml](http://www.up.com/investors/annuals/index.shtml). Accessed April 8, 2011.
- USACE. 1998. Illinois Waterway Navigation Charts. Regulations Prescribed by the Secretary of the Army for Ohio River, Mississippi River, Above Cairo, Illinois Waterway, and their Tributaries; Use, Administration, and Navigation.
- USACE. 2003. Upper Mississippi River System Flow Frequency Study. Hydrology and Hydraulics Appendix C Illinois River.
- USACE. 2007a. Project Factsheet for: Lockport Lock and Dam, Upper Pool, Illinois. Upper Pool, Illinois.
- USACE. 2007b. Project Factsheet for: T.J. O'Brien Lock and Dam Lock and Controlling Works, Illinois Waterway (Major Rehabilitation). Chicago, Illinois.
- USACE. 2007c. Transportation Demands for the Movement of Non-Agricultural Commodities Pertinent to the Upper Mississippi and Illinois River Basin. IWR Report 07-NETS-R-1. The Navigation Economic Technologies Program.
- USACE. 2010a. Other Pathways Preliminary Risk Characterization. Great Lakes Mississippi River Interbasin Study (GLMRIS).
- USACE. 2010b. Report 01a – T.J. O'Brien Lock and Dam, Summary Tons and Hours Report Version 1.24. Chicago, Illinois.
- USACE. 2010c. Report 06 – Chicago Lock. Waterway Traffic Report (v3.5.5).
- USACE. 2010d. Report 14 – Boats and Lockages on the Chicago River. Chicago, Illinois.
- USACE. 2010e. Report 14 – T.J. O'Brien Lock and Dam, Boats and Lockages on the Illinois Waterway. Chicago, Illinois.

- USACE. 2011a. Baseline Assessment of Cargo Traffic on the Chicago Area Waterway System. Great Lakes Mississippi River Interbasin Study (GLMRIS).
- USACE. 2011b. Baseline Assessment of Non-Cargo CAWS Traffic. Great Lakes Mississippi River Interbasin Study (GLMRIS).
- USACE. 2011c. Inventory of Available Controls for Aquatic Nuisance Species of Concern Chicago Area Waterway System. Great Lakes Mississippi River Interbasin Study (GLMRIS).
- USACE. 2011d. Non-Native Species of Concern and Dispersal Risk for the Great Lakes and Mississippi River Interbasin Study. Great Lakes Mississippi River Interbasin Study (GLMRIS).
- USACE. 2011e. Summary of Select CAWS Milepost Data, 2001–2009.
- USACE, Chicago District. No Date. eDNA Surveillance Fact Sheet. Chicago Sanitary and Ship Canal – Aquatic Nuisance Dispersal Barrier.
- USACE, Chicago District. 2006. Lake Michigan Diversion Accounting. Water Year 2006 Report.
- USACE, Chicago District. 2007. Lake Michigan Diversion Accounting. Water Year 2007 Report.
- USACE, Rock Island District. 2008. Lockport (Lockport, Illinois) Chicago Sanitary and Ship Canal.
- USACE, Rock Island District. 2009a. Existing Sediment Characterization Summary Report. Calumet-Sag Channel. Cook County, Illinois.
- USACE, Rock Island District. 2009b. The Impact of Urban Areas on Great Lakes Water Quality. A Report of the Great Lakes Science Advisory Board, Great Lakes Water Quality Board, International Air Quality Advisory Board and Health Professionals Task Force to the International Joint Commission United States and Canada.
- U.S. Coast Guard. 2008a. Federal Register. Volume 73, No. 114. June 12, 2008. Proposed Rules.
- U.S. Coast Guard. 2008b. Federal Register. Volume 73, No. 128. July 2, 2008. Rules and Regulations.
- U.S. Coast Guard. 2008c. Federal Register. Volume 73, No. 153. August 7, 2008. Rules and Regulations.
- U.S. Coast Guard. 2008d. Federal Register. Volume 73, No. 208. October 27, 2008. Rules and Regulations.
- U.S. Coast Guard. 2009a. Federal Register. Volume 74, No. 169. September 02, 2009. Rules and Regulations.
- U.S. Coast Guard. 2009b. Federal Register. Volume 74, No. 164. August 26, 2009. Rules and Regulations.
- U.S. Coast Guard. 2009c. Federal Register. Volume 74, No. 187. September 29, 2009. Rules and Regulations.
- U.S. Coast Guard. 2009d. Federal Register. Volume 74, No. 218. November 03, 2009. Rules and Regulations.

- U.S. Coast Guard. 2009e. Federal Register. Volume 74, No. 236. December 10, 2009. Rules and Regulations.
- U.S. Coast Guard. 2009f. Federal Register. Volume 74, No. 25. February 09, 2009. Rules and Regulations.
- U.S. Coast Guard. 2009g. Federal Register. Volume 74, No. 99. May 26, 2009. Proposed Rules.
- U.S. Coast Guard. 2010a. Federal Register. Volume 75, No. 122. June 25, 2010. Rules and Regulations.
- U.S. Coast Guard. 2010b. Federal Register. Volume 75, No. 3. January 06, 2010. Rules and Regulations.
- U.S. Coast Guard. 2010c. Federal Register. Volume 75, No. 90. May 11, 2010. Rules and Regulations.
- U.S. Department of the Interior. 2011. America's Great Outdoors, 50 State Report.
- USDOT, Maritime Administration. January 2007. Great Lakes-St. Lawrence Seaway New Cargoes/New Vessels Market Assessment Report.
- USDOT, Maritime Administration. September 2010. America's Marine Highway Corridors Project Descriptions.
- USDOT, Maritime Administration website. Accessed 1/5/2011.  
[http://www.marad.dot.gov/ships\\_shipping\\_landing\\_page/mhi\\_home/mhi\\_home.htm](http://www.marad.dot.gov/ships_shipping_landing_page/mhi_home/mhi_home.htm)
- USDOT, Maritime Administration. April 2011. America's Marine Highways Report to Congress.
- United States Department of the Treasury with the Council of Economic Advisors (USDOT and CEA). 2010. An Economic Analysis of Infrastructure Investment.
- USGS Website. 2011. CAWS Flow Data. [water.usgs.gov/data/](http://water.usgs.gov/data/) Accessed 2011.
- U.S. Geological Survey and University of Illinois at Urbana-Champaign. 2006. Chicago Waterway System (CWS) Three-Dimensional Hydraulic Computational Modeling using the EPA Environmental Fluid Dynamics Code (EFDC).
- U.S. Geological Survey, U.S. Department of the Interior. 2010. Water-Data Report 2010. 05532500 Des Plaines River at Riverside, Illinois. Upper Illinois Basin. Des Plaines Subbasin.
- U.S. Government. Title 33 of the Code of Federal Regulations (CFR), Parts 207.420 and 207.425.
- United States Securities and Exchange Commission. 2011. Form 10-2. Dominion Resources, Inc.
- University of Illinois at Chicago School of Public Health. 2010. Frequently Asked Questions about CHEERS. Environmental Occupancy Health Sciences.
- U.S. EPA. 2011. Gulf Coast Ecosystem Restoration Strategy.
- U.S. EPA. 2000. A Benefits Assessment of Water Pollution Control Programs Since 1972: Part 1, The Benefits of Point Source Controls for Conventional Pollutants in Rivers and Streams.
- V3 Companies. 2004. Ariel View of Calumet Area EMA Locations Maps. Chicago, Illinois.

- V3 Companies. 2006. Calumet Hydrologic Master Plan (HMP). Chicago, Illinois.
- Visocky, Adrian P., Sherrill, Marvin G., and Cartwright, Keros. 1985. Geology, Hydrology, and Water Quality of the Cambrian and Ordovician Systems in Northern Illinois. Cooperative Groundwater Report 10, Illinois State Geological Survey, Illinois State Water Survey. Champaign, Illinois.
- Vickerman and Associates. 2011. Ecosystem Separation Study -- Envisioning a Chicago Area Waterway System for the 21st Century; Task 2.1 Identification of Key Chicago Shipping and Logistics Market Drivers.
- Wasik, Jennifer and Minarik, Jr., Thomas A. 2010. Water and Sediment Quality Along the Illinois Waterway from the Lockport Lock to the Peoria Lock During 2009. Report 10-50. Report to the Metropolitan Water Reclamation District of Greater Chicago, Chicago, Illinois.
- Wasik, Jennifer, Minarik, Jr., Thomas A., Sopcak, Michael, and Dennison, Samuel G. 2008a. Ambient Water Quality Monitoring in the Chicago Metro Area Waterway System: A Summary of Biological, Habitat, and Sediment Quality Data Between 2001 and 2004. Report to the Metropolitan Water Reclamation District of Greater Chicago, Chicago, Illinois.
- Wasik, Jennifer and O'Connor, Catherine. 2008b. Description of the Chicago Waterway System for Use Attainability Analysis. Report No. 08-15R. Metropolitan Water Reclamation District of Greater Chicago. Monitoring and Research Department. Chicago, Illinois.
- Wasik, Jennifer and O'Connor, Catherine. 2009. Effects of Potential Lemont Water Reclamation Plant Expansion on Phosphorus Levels in the Chicago Sanitary and Ship Canal. Report No. 09-44. Monitoring and Research Department. Metropolitan Water Reclamation District of Greater Chicago. Chicago, Illinois.
- Waterways Council, Inc. 2010. Lockport Lock and Dam Report. Arlington, VA.
- Wethington, David. 2012. Personal communication regarding the cost of operating the electric barrier. USACE
- White, PhD. Gwen, Murray, PhD. Michael and Jackson, Sara E. 2004. Ecosystem Shock: The Devastating Impacts of Invasive Species on the Great Lakes Food Web. National Wildlife Federation.



**A2. US SUPREME COURT CONSENT DECREE**



# U.S. Supreme Court

---

**WISCONSIN v. ILLINOIS, 449 U.S. 48 (1980)**

**449 U.S. 48**

**WISCONSIN ET AL. v. ILLINOIS ET AL.  
ON BILL IN EQUITY**

**No. 1. Orig. Decree April 21, 1930 Decree enlarged May 22, 1933 Decree entered June 12,  
1967 Decree amended December 1, 1980 \***

[ Footnote \* ] Together with No. 2, Orig., Michigan v. Illinois et al., and No. 3, Orig., New York v. Illinois et al.

## **Decree amended.**

Decree reported: 281 U.S. 696 ; decree enlarged: 289 U.S. 395 ; decree entered: 388 U.S. 426 .

### **ORDERED:**

A. Paragraph 3 of the Decree entered by the Court herein on June 12, 1967, is amended to read as follows:

3. For the purpose of determining whether the total amount of water diverted from Lake Michigan by the State of Illinois and its municipalities, political sub-divisions, agencies and instrumentalities is not in excess of the maximum amount permitted by this decree, the amounts of domestic pumpage from the lake by the State and its municipalities, political sub-divisions, agencies and instrumentalities the sewage and sewage effluent derived from which reaches the Illinois waterway, either above or below Lockport, shall be added to the amount of direct diversion into the canal from the lake and storm runoff reaching the canal from the Lake Michigan watershed computed as provided in Paragraph 2 of this decree. The annual accounting period shall consist of twelve months terminating on the last day of September. A period of forty (40) years, consisting of the current annual accounting period and the previous thirty-nine (39) such periods (all after the effective date of this decree), shall be permitted, when necessary, for achieving an average diversion which is not in excess of the maximum permitted amount; provided, however, that the average diversion in any annual accounting [449 U.S. 48, 49] period shall not exceed 3680 cubic feet per second, except that in any two (2) annual accounting periods within a forty (40) year period, the average annual diversion may not exceed 3840 cubic feet per second as a result of extreme hydrologic conditions; and, that for the first thirty-nine (39) years the cumulative algebraic sum of each annual accounting period's average diversion minus 3200 cubic feet per second shall not exceed 2000 cubic feet per second-years. All measurements and computations required by this decree shall be made by the appropriate officers, agencies or instrumentalities of the State of Illinois, or the Corps of Engineers of the United States Army subject to agreement with and cost-sharing by the State of Illinois for all reasonable costs including equipment, using the best current engineering practice and scientific knowledge. If made by the State of Illinois, the measurements and computations shall be conducted under the continuous supervision and direction of the Corps of Engineers of the United States Army in cooperation and consultation with the United States Geological Survey, including but not limited to periodic field investigation of measuring device calibration and data gathering. All measurements and computations made by the State of Illinois shall be subject to periodic audit by the Corps of Engineers. An annual report on the measurements and computations required by this decree shall be issued by the Corps of Engineers. Best current engineering practice and scientific knowledge shall be determined within six (6) months after implementation of the decree based upon a recommendation from a majority of the members of a three-member committee. The members of this committee shall be appointed by the Chief of Engineers of the United States Army Corps of Engineers. The members shall be selected on the basis of recognized experience and technical expertise in flow measurement or hydrology. None of the committee members shall be employees of the Corps of Engineers or employees or paid consultants of any of the parties to

these proceedings other than [449 U.S. 48, 50] the United States. The Corps of Engineers shall convene such a committee upon implementation of this decree and at least each five (5) years after implementation of this decree to review and report to the Corps of Engineers and the parties on the method of accounting and the operation of the accounting procedure. Reasonable notice of these meetings must be given to each of the parties. Each party to these proceedings shall have the right to attend committee meetings, inspect any and all measurement facilities and structures, have access to any data and reports and be permitted to take its own measurements.

B. Paragraph 5 of the said Decree entered by the Court herein is amended by adding thereto an additional sentence to read as follows:

The amendment to Paragraph 3 of this decree shall take effect on the first day of October following the passage into law by the General Assembly of the State of Illinois of an amendment to the Level of Lake Michigan Act providing that the amount used for dilution in the Sanitary and Ship Canal for water quality purposes shall not be increased above three hundred twenty (320) cubic feet per second, and that in allocations to new users of Lake Michigan water, allocations for domestic purposes be given priority and to the extent practicable allocations to new users of Lake Michigan water shall be made with the goal of reducing withdrawals from the Cambrian-Ordovician aquifer.

C. A certified copy of the above legislation shall be served upon the parties and filed with the Clerk of the Supreme Court by the State of Illinois. If no party raises an objection to the adequacy of the legislation within 30 days of service, Illinois will have complied with the requirements of the amendment made by this Order to paragraph 5 of the Decree entered by the Court herein on June 12, 1967. Any such objection shall be raised in the manner set forth in Paragraph 7 of said Decree. [449 U.S. 48, 51]

IT IS FURTHER ORDERED THAT:

Each of the parties to this proceeding shall bear its own costs. The expenses of the Special Master shall be borne by the State of Illinois and the Metropolitan Sanitary District of Greater Chicago, three-fifths thereof by the State of Illinois and two-fifths thereof by the Metropolitan Sanitary District of Greater Chicago.

JUSTICE MARSHALL took no part in the consideration or decision of this order.

#### STATEMENT OF INTENT AND TECHNICAL BASIS FOR PROPOSED AMENDMENTS TO 1967 DECREE

This statement sets forth the intent of the parties and the technical basis for the revisions to certain of the provisions of paragraphs 3 and 5 of the 1967 Decree.

The proposed change in the 1967 Decree has been designed to alter in part the provisions of the existing Decree that prevent Illinois from effectively utilizing and managing the 3200 cubic feet per second (cfs) of Lake Michigan water which Illinois was allocated.

Under the existing system, increasing amounts of impervious areas and increasing demand by domestic users elevate the risk that the language of the decree will be violated in any one or five year period if additional allocations are made by the State to domestic users for a period of years consistent with good management practice.

The proposed change accomplishes the following:

1. Increases the period for determining compliance with the 3200 cfs limit from a five year running average to a forty year running average;

2. During the first thirty-nine years of the decree, allows Illinois to exceed the 3200 cfs limit by 2000 cfs-years in the aggregate (one cfs-year is the volume of water resulting from an average flow of one cfs for a period of one year); [449 U.S. 48, 52]
3. Limits the average diversion in any one accounting period to 115% of 3200 cfs, but in two years of any forty year period permits the average diversion to reach 120% of 3200 cfs, to allow for extreme hydrologic conditions.

The lengthening of the averaging period from five to forty years reduces the variability of the averaged figure, thus decreasing the amount of water that needs to be held in reserve for storm water runoff and increasing the amount of water that may be allocated for domestic purposes to reduce in part the pumpage from the Cambrian-Ordovician aquifer.

The lengthening of the averaging period also allows an increase in the planning period to a period of time that is more compatible with the life of certain types of water supply facilities, thus permitting more efficient use of the available diversion without increasing the total allowable diversion, and permitting better management of all the water resources of the region.

In establishing the limits of paragraph three of the amended decree, the available data and uncertainties as to the behavior of and interactions between the various elements of the hydrologic regime under current and future conditions were limiting factors.

To estimate maximum hydrologic variations that must be considered in the allocation accounting process, the forty-four year precipitation and runoff data contained in "Water Yield, Urbanization, and the North Branch of the Chicago River," a report by the Northeastern Illinois Planning Commission and Hydrocomp, Inc., dated October 14, 1976, were used. These data assumed a 30% imperviousness factor and were used by the parties to approximate the conditions of the entire Lake Michigan diversion watershed at the present time.

These data indicate that the maximum departure above the mean annual stormwater flow is 59%. Assuming, therefore, [449 U.S. 48, 53] that the mean annual stormwater flow is 683 cfs, the maximum departure is 405 cfs. This could result in a diversion of 13% above the allowable 3200 cfs maximum. Given the relatively short period of record and the likelihood of increased runoff resulting from urbanization, it was agreed that a 15% exceedance, to a maximum of 3680 cfs, would be allowed in any year to accommodate high stormflows and that in any two years of the 40 year accounting period the diversion may be increased by 20%, to a maximum of 3840 cfs, to accommodate extraordinary hydrologic conditions.

Because of year-to-year variations in storm runoff there will be series of years when the average annual diversion will need to exceed 3200 cfs for best management, and some years when the diversion will be less than the 3200 cfs average. Calculations of the cumulative sum of the annual departures show that the maximum cumulative exceedance of 3200 cfs would be slightly below 1500 cfs-years as indicated by the forty-four years of data that were used. The possibility exists that in the initial forty year period the cumulative exceedance may be greater than 1500 cfs-years. Since the record used is relatively short and urbanization is likely to increase runoff, the maximum cumulative exceedance has been established at 2000 cfs-years.

The goal of this amended Decree is to maintain the longterm average annual diversion of water from Lake Michigan at or below 3200 cfs. [449 U.S. 48, 54]



### **A3. FLOOD MANAGEMENT DATA AND ANALYSIS**

- FLOOD MANAGEMENT IMPROVEMENTS METHODOLOGY
- HYDRAULIC SUPPLEMENTAL DATA





# Flood Management Improvement Methodology

## Defining the Flood Event

For many Chicagoans, the term *flooding* is associated with basement flooding and street ponding rather than overbank flooding. In Chicago, overbank flooding is a relatively rare and geographically limited event compared to basement flooding from sewer surcharges.

Although there is a relationship between the Chicago River and water in basements, a barrier within the CAWS dramatically increases the risk of overbank flooding and has marginal positive and negative impacts to the risk of basement flooding.<sup>1</sup> Furthermore, a key assumption for the analysis has been that local conveyance to TARP is resolved (through local municipality investments) before an AIS barrier is placed in the CAWS, thereby greatly improving the baseline condition for basement flooding. Consequently, the focus of this analysis has been on preventing overbank flooding while being aware of the implications for basement flooding.

Since the primary result of a barrier is hydrologic separation, there is a clear and direct need to account for the flows after a barrier is installed. The design criterion for the analysis of each alternative was to protect against overbank flooding for a 100-year storm as defined by Bulletin 70 of the Illinois State Water Survey (ISWS). This volume amounts to about 7.6 inches of rain over any given land area. Using cursory Curve Number rainfall-runoff methodology, the total volume of runoff for a 100-year storm throughout the CAWS was estimated as 88 billion gallons (BG) (refer to the tables and figures following this document for calculations). Part IV, Detailed Evaluation of Alternatives, of the main report describes the impact of each alternative on the ability of the system to manage flood waters and how each alternative would manage this volume with a combination of existing and proposed infrastructure (refer to the tables and figures following this document for calculations).

Table 1 summarizes the effect of each alternative on the total volume of stormwater from a 100-year storm (88 BG).

**Table 1. 100-year Flood Volumes Impacted and Capital Costs by Alternative**

Alternative	Volume Impacted (MG)	% of Total (% of 88 BG)	Flood Management Capital Cost (\$ Billions)
Down River	30,300	34%	\$4.0
Mid-System	8,000 <sup>a</sup>	9% <sup>a</sup>	\$2.4
Near Lake	15,500	18%	\$5.0

<sup>a</sup> Assumes that about 12,500 million gallons (MG) are addressed by existing channel capacity of the CSSC riverside of the South Branch Barrier (the barrier simulates the hydraulic dam effect that the RAPS creates under the baseline condition).

<sup>1</sup> It is acknowledged that river elevations affect combined sewer overflows, which are the outlets for the sewer system. The additional head pressures on the outlet from the higher river limit the ability of the sewer to drain and therefore adversely affect basement flooding. The more that local residents are relieved of basement flooding, the more water flows to the CAWS.

## Rainfall and Green Infrastructure

To understand the potential role of green infrastructure for this study, the rainfall characteristics of Chicago must be understood. While minimal investment was available for collecting new data, some evaluation and confirmation of publically available data was performed. For example, ISWS gage 10 was used to briefly investigate the characteristics that are commonly assumed to be true for Chicago rainfall patterns (on average, rainfall occurs every third day, and the majority of rainfall volume occurs from storms of less than 1 inch).

The investigation into rainfall characteristics in Chicago found that the assumptions mentioned above are accurate (Figure 1 and Table 2).

**Figure 1. Percent of Total Rainfall Volume by Storm Event Size, ISWS Gage 10 Rainfall – 2005–2010**

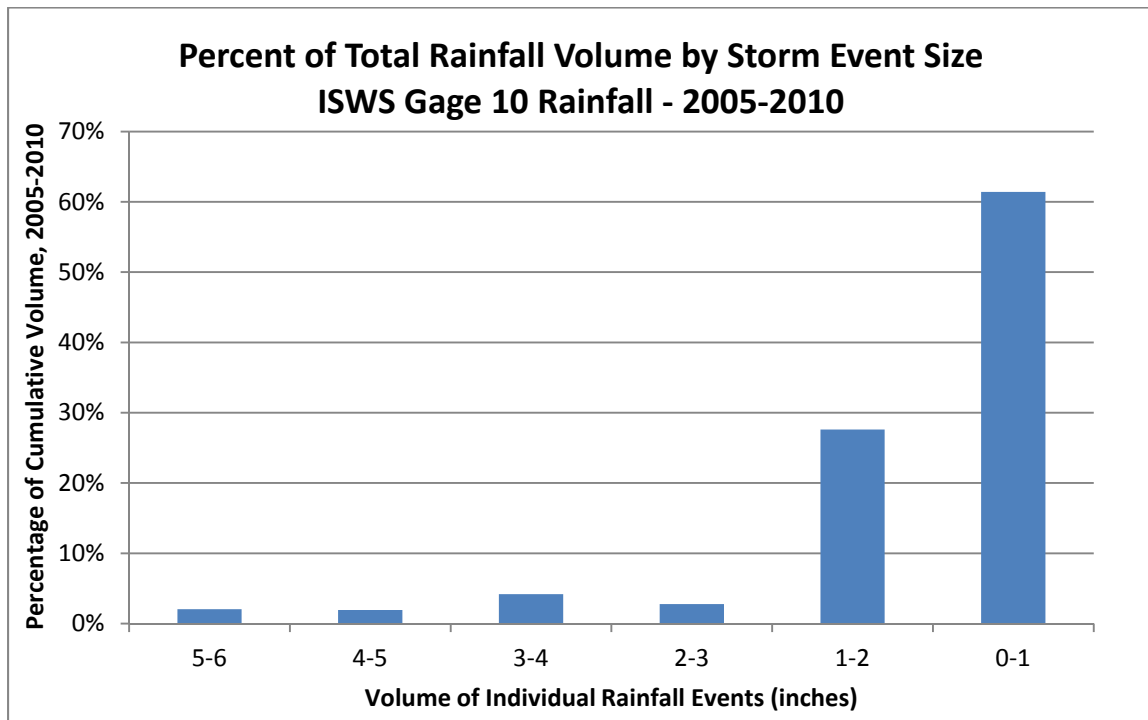

**Table 2. Storm Events by Year for ISWS Gage 10, 2005–2010**

Year	Number of Storm Events
2005	108
2006	126
2007	115
2008	128
2009	134
2010	94
<b>Average per Year</b>	<b>117</b>

# Flood Management Improvement Methodology

Figure 1 shows that rainfall events of less than 1 inch accounted for over 60% of the total rainfall volume from 2005 to 2010 at ISWS Gage 10, while rainfall events of less than 2 inches accounted for nearly 90% of the total rainfall volume. Table 2 shows that recent average rainfall for Chicago is around 117 rain events per year, with seasonal concentrations of rain in the fall and the spring and drier periods in the summer and winter. However, these historic trends could be shifting due to climatic changes. Some climate models predict a drier summer and wetter spring and fall for the Chicago area.<sup>2</sup> Climatic changes would affect the effectiveness of green infrastructure and therefore the design and management of green infrastructure.<sup>3</sup> This report does not examine the details of green infrastructure design but rather assumes a green infrastructure application strategy and a given performance criterion as described below. It is assumed that the specific designs implemented will incorporate the best thinking of the day with appropriate site and climate assumptions.

Again, as an illustration, data from rain gage 10 from the ISWS was used for investigating the character of historical storms. This is illustrated in Figure 2 with a scatter-plotting percentage of the total rainfall (X axis) shown against the volume of individual rainfall events (Y axis).

**Figure 2. Percent of Total Rainfall Events by Storm Event Size, ISWS Gage 10 Rainfall – 2005–2010**

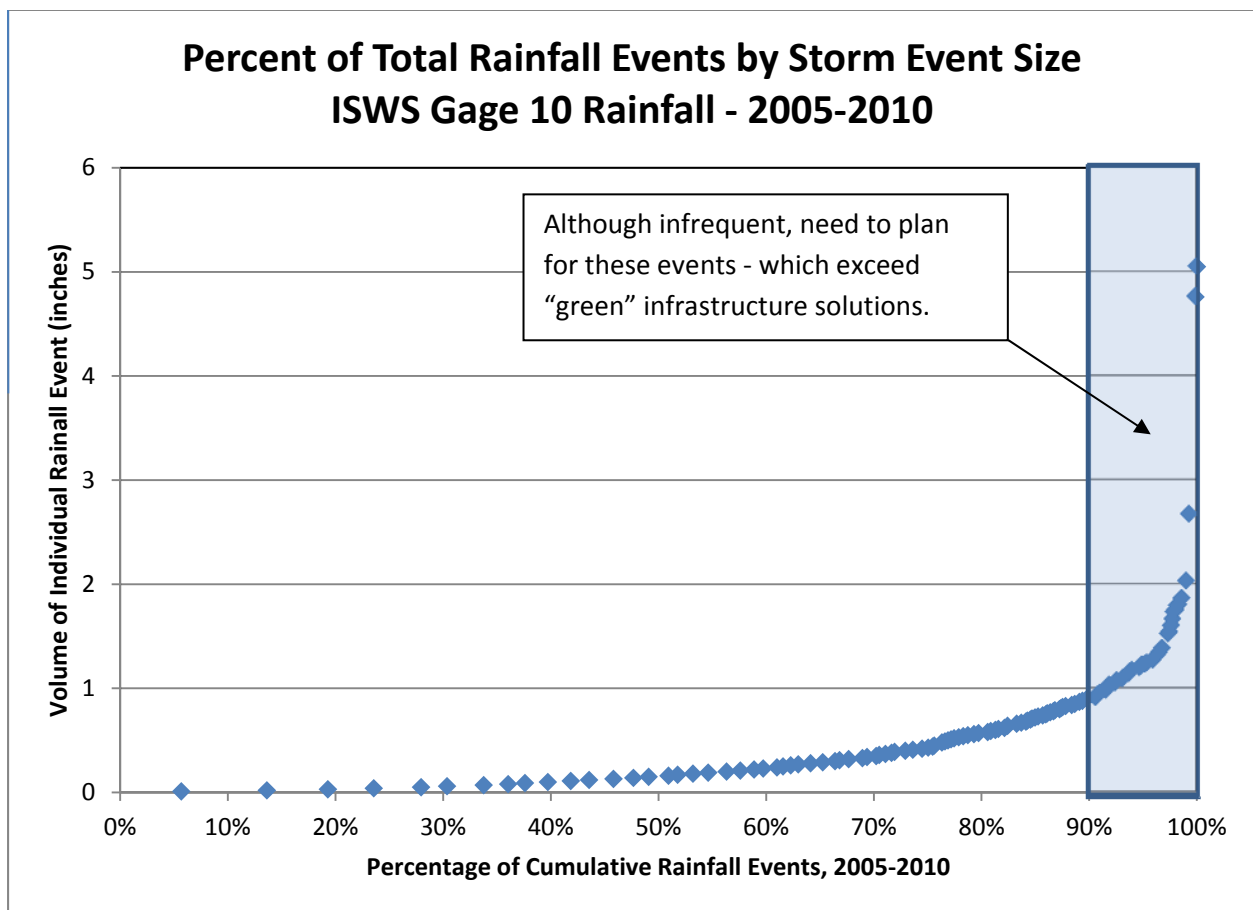

<sup>2</sup> City of Chicago – Wuebles and Kehoe, University of Illinois Climate Model – see [chicagoclimateaction.com](http://chicagoclimateaction.com)

<sup>3</sup> Frequency of rainfall can indicate how often the vegetation will have replenishing water, and seasonality indicates whether there will be drought periods and wet periods. In this case, Chicago currently has a dormant winter and a continual growing season.

# Flood Management Improvement Methodology

---

Figure 2 shows that:

- About 90% of the rainfall events were storms less than 1 inch
- About 75% of the rainfall events were storms less than 0.5 inch

This rainfall pattern is important to appreciate, since this study assumes that green infrastructure can manage 2 inches of rainfall from the public right-of-way (ROW) and 1 inch of rain from regulated non-ROW projects. From Figure 1 and Figure 2, it is clear that green infrastructure would be effective for a large percentage of storms (over 95% of the storms are less than 2 inches; over 90% of the storms are less than 1 inch) and a large percentage of the annual rainfall volume (about 90% of rainfall volume comes from storms less than 2 inches; over 60% of rainfall volume comes from storms less than 1 inch). However, green infrastructure has a relatively low value in reducing flood risk from the large storms (over 2 inches) that cause overbank flooding.

This study concludes that, in Chicago, green infrastructure has the potential to manage a large number of storms, thereby reducing the flows to the WWTP with associated reductions in energy and carbon. Green infrastructure would also reduce the risk of basement flooding by preserving capacity in local sewers. While green infrastructure manages a large percentage of the annual rainfall, it has limited value for large single storms, as indicated in the pie charts of the flood management improvement elements for potential separation alternatives (Figure 4 through Figure 6). Therefore, green infrastructure alone is not suitable without major grey infrastructure to manage the infrequent high-volume storm. In essence, green infrastructure has been paired with grey infrastructure to reduce flooding to what is perceived as an acceptable level of risk.

## Flood Management Improvement Approach

Figure 3 illustrates the approximate volume (MG) for various baseline flood management elements of the CAWS in a 100-year storm. This provides a point of comparison for comparing the potential flood management improvement elements associated with various separation alternatives.

# Flood Management Improvement Methodology

**Figure 3. Baseline Flood Management Elements by Volume (MG) for 100-year Storm**

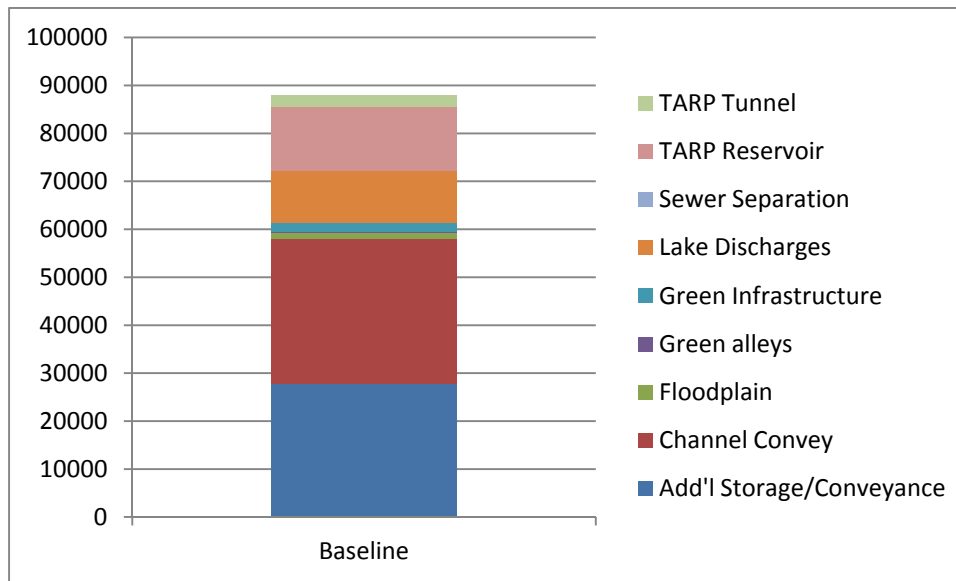

Each alternative represents a different challenge with respect to flooding, but a comparable approach was followed to building a strategy that does not increase the risk of flooding and lays a foundation for a more flexible and robust system that enables improvement.

In general, three “buckets” are associated with flood management investment strategies. The first is **inflow reduction**; while the amount of rainfall cannot be controlled, the amount of stormwater runoff that enters the sewer system can be limited in some manner. The second is **conveyance**, which includes all the techniques for moving water to another location. The third is **storage techniques** that hold flood waters and detain or retain that volume as necessary to reduce the flooding risk.

Furthermore, the locations for directing stormwater runoff were prioritized as follows:

- 1) Onsite infiltration (inflow reduction)
- 2) Receiving water body (inflow reduction to conveyance)
- 3) Sewer system
- 4) Tunnel/reservoir
- 5) CSO – river
- 6) CSO – lake

With these guidelines, a flood risk reduction strategy was developed for each alternative.

## Green Infrastructure Strategy

Each alternative includes the active use of green infrastructure. Green infrastructure is an important tool, partially because it can use all three elements of the proposed strategy: (1) inflow reduction, such as soil infiltration; (2) conveyance, such as bioswales; and (3) storage, such as cisterns.

Although the green infrastructure plans proposed for each alternative would vary geographically, they all have the following approaches.

# Flood Management Improvement Methodology

---

## Right-of-Way Flood Management

The ROW accounts for about 25% of the area that is tributary to TARP.<sup>4</sup> The ROW consists of all the land between private properties, including alleys. This landscape is considered to be an opportunity for flood management investment in conjunction with existing capital plans.<sup>5</sup> To arrive at a volume of water that could be managed within the ROW, the following conclusions were made:

1. Add green infrastructure as part of the existing roadway replacement capital improvement plans (CIP).
2. Because alleys have a robust greening program, these were included in the baseline condition and extrapolated out to 2030.
3. Estimate the roadway reconstruction rates from data provided by Chicago Department of Transportation (CDOT), the proposed miles of water main replacements, plus the proposed miles of sewer replacement.
4. It is assumed that 100% of the CIP roadway reconstruction and 50% of the water main and sewer replacement project miles are suitable for green infrastructure, and that the green infrastructure would be designed to manage 2 inches of rainfall from the effective ROW.

The volume of water estimated to be managed from green infrastructure within the ROW is about 590 MG per 100-year storm (refer to the tables and figures following this document for calculations).

## Limited Combined Sewer Separation

This study has defined limited combined sewer separation as the separation of the public ROW roadway stormwater from sanitary sewage, but the study does not include disconnecting rooftop connections. This is due to the complexity and cost of separating rooftop connections from the existing infrastructure of Chicago. Therefore, the watershed for estimating the sewer separation is the ROW connected to the separated sewer. This area was calculated based on geographic information system (GIS) information. Sewer separation is an important element to this study's strategy, since it uses the existing river as capacity to convey stormwater flows out of the system, thereby bypassing TARP and the treatment works. However, this benefit is negated after about 4.5 inches of rainfall, which is the estimated depth of a storm that would completely fill TARP (following completion of reservoirs by 2029) and therefore trigger CSOs. The benefit is negated because, once there is a CSO, the water enters the waterway, whether as a CSO discharge or as a separate storm sewer discharge (the volume of these two discharges is roughly equivalent).

To establish the watershed available for storm water separation, it was decided that a gravity system would be most desirable, and for this reason, the length of run of a storm sewer pipe would be limited to the available slope. The available slope has several constraints: (1) topography, (2) depth of river bank, (3) necessary cover over pipe, and (4) diameter of pipe. Based on these constraints, a boundary was drawn adjacent to the waterways.<sup>6</sup> It is important to note that separate storm sewer alignments

---

<sup>4</sup> Extrapolated from City of Chicago data, which is documented as about 25% based on GIS information.

<sup>5</sup> See city data associated with CDOT and Chicago Department of Water Management (CDWM).

<sup>6</sup> Refer to the tables and figures following this document for volume calculations and for a map of the river reaches, available area for sewer separation.

# Flood Management Improvement Methodology

---

were not established and potential utility conflicts were not evaluated; however, the drainage areas of the roadways were estimated by residential and arterial designations.

1. Sewer separation was considered as a means to access the conveyance capacity of the river.
2. To determine the volume that the storm system could remove, the following assumptions were made:
  - a. River elevation—the storm sewer could not be lower than the river. Cross-section data from USACE CAWS Hydraulic Model were used.
  - b. The storm system would be a gravity system.
  - c. The system would separate only stormwater in the public ROW; no disconnection of rooftop flows.
  - d. The storm sewer needs a minimum of 3 feet of cover at all points.
  - e. The minimum pipe slope was estimated based on maintaining an adequate flushing velocity.
  - f. The maximum pipe diameter was based on required cover, slope, and topography.
  - g. Drainage area was estimated from GIS ROW layers (arterial and residential streets).
  - h. Topography was captured from various data points using LiDAR 2-foot contours.
3. From this evaluation, it was determined that a storm system was limited to about 1 mile from the riverbanks.
4. The storm system value is effective only for storms less than a CSO event, which is estimated under future conditions as 4.5 inches.
5. The volume removed from the combined sewer system was then estimated to be up to 250 MG during a 100-year storm (refer to the tables and figures following this document for calculations).

## **Amended City of Chicago Stormwater Ordinance**

Among the existing City of Chicago Stormwater Management Ordinance (SMO) requirements is a reduction in runoff volume. The volume reduction is met by either reducing the impervious area of a proposed site or collecting the volume of rain equivalent to 0.5 inch of rainfall over the impervious area of the site. This effort is important because it is the assumed mechanism to apply green infrastructure outside the ROW.

1. Relevant data from the City was collected to determine the annual volume of water reduction per year since the ordinance was enforced (January 2008 to the present).
2. Data was projected outward to the year 2030 for a baseline volume reduction.
3. The additional volume was estimated that would be collected under an ordinance that was amended starting in 2017 to change from the existing 0.5 inch to 1.0 inch and to increase the impervious area reduction requirement from 15% to 25%.
4. The marginal difference between available stormwater storage volume in the existing and amended ordinances is 600 MG. This was considered an available flood management improvement strategy but was considered a non-project cost.

The projected volume of water managed for a 100-year storm based on the current SMO by the year 2030 is estimated at about 1,800 MG (refer to the tables and figures following this document for

# Flood Management Improvement Methodology

calculations). The amended ordinance is projected to add an additional 600 MG of stormwater volume storage by 2030. Only the additional 600 MG is attributed to this project, and it is not considered a capital cost to the project.

## Flood Management Elements by Separation Alternative

The pie charts below (Figure 4 through Figure 6) show the degree to which each separation alternative would affect flood management as well as the breakdown of the various flood-management elements that are proposed to manage these impacts.

**Figure 4. Down River Alternative Flood Management**

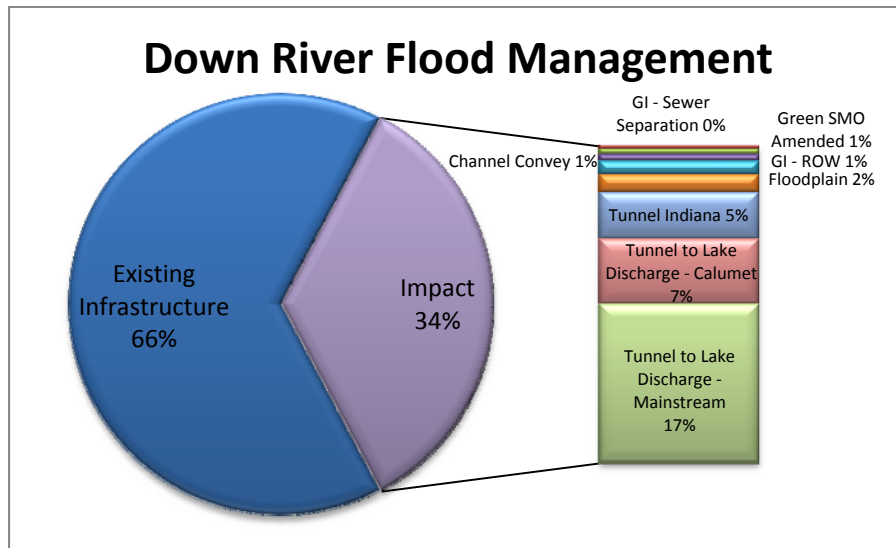

**Figure 5. Mid-System Alternative Flood Management**

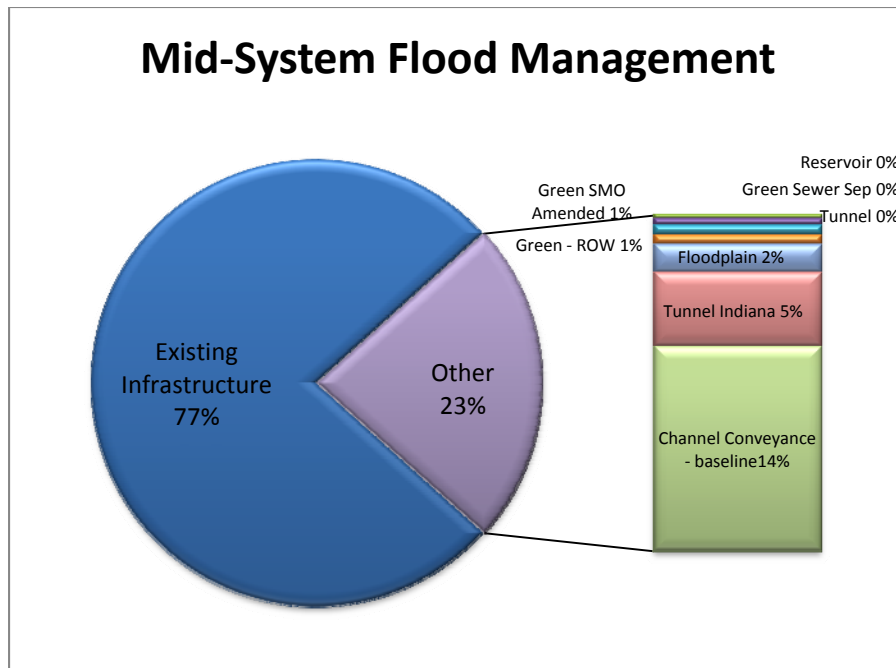



Figure 6. Near Lake Alternative Flood Management

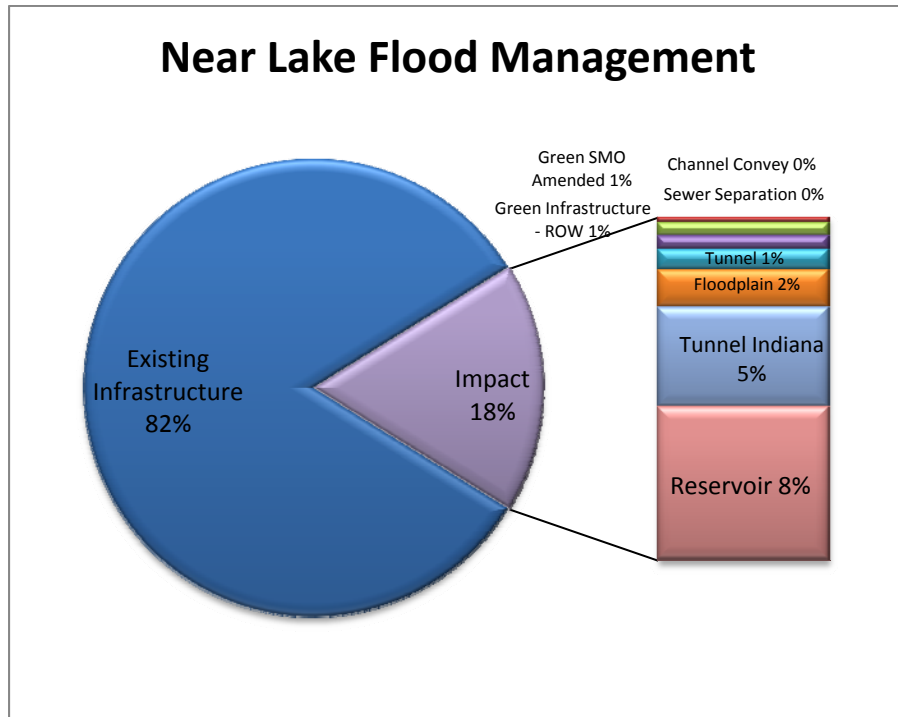
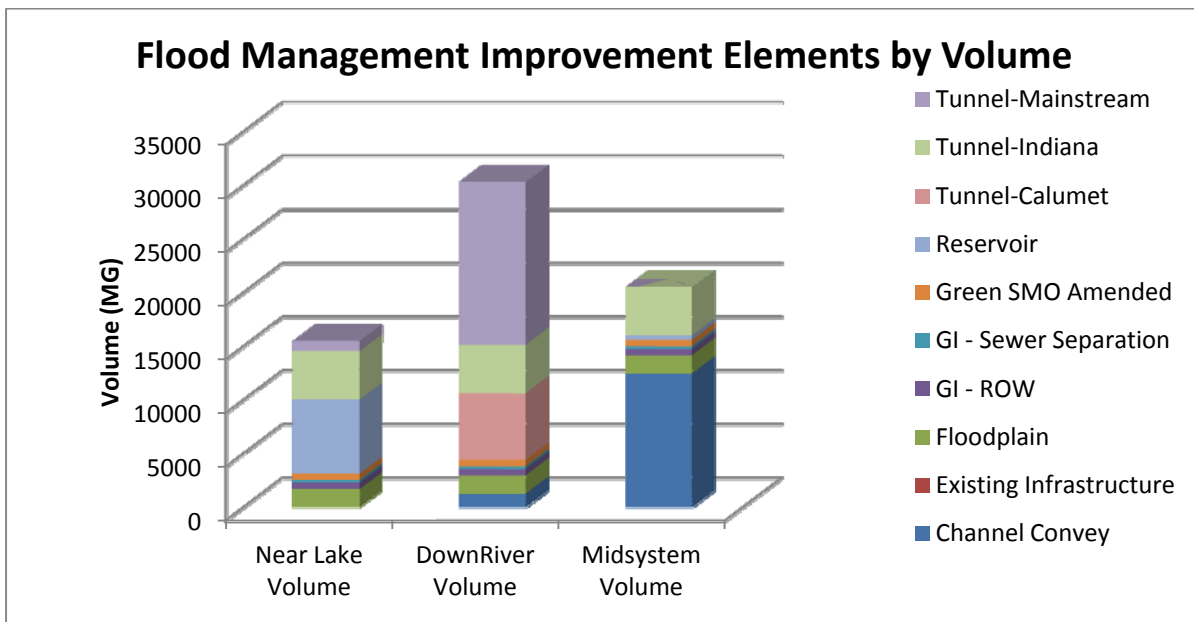

Figure 7 shows the relative volumes that each element of the strategy captures for both existing infrastructure and proposed impact solutions (refer to the tables and figures following this document for calculations).

Figure 7. Flood Management Improvement Elements by Volume





# DRAINAGE AREAS



Legend

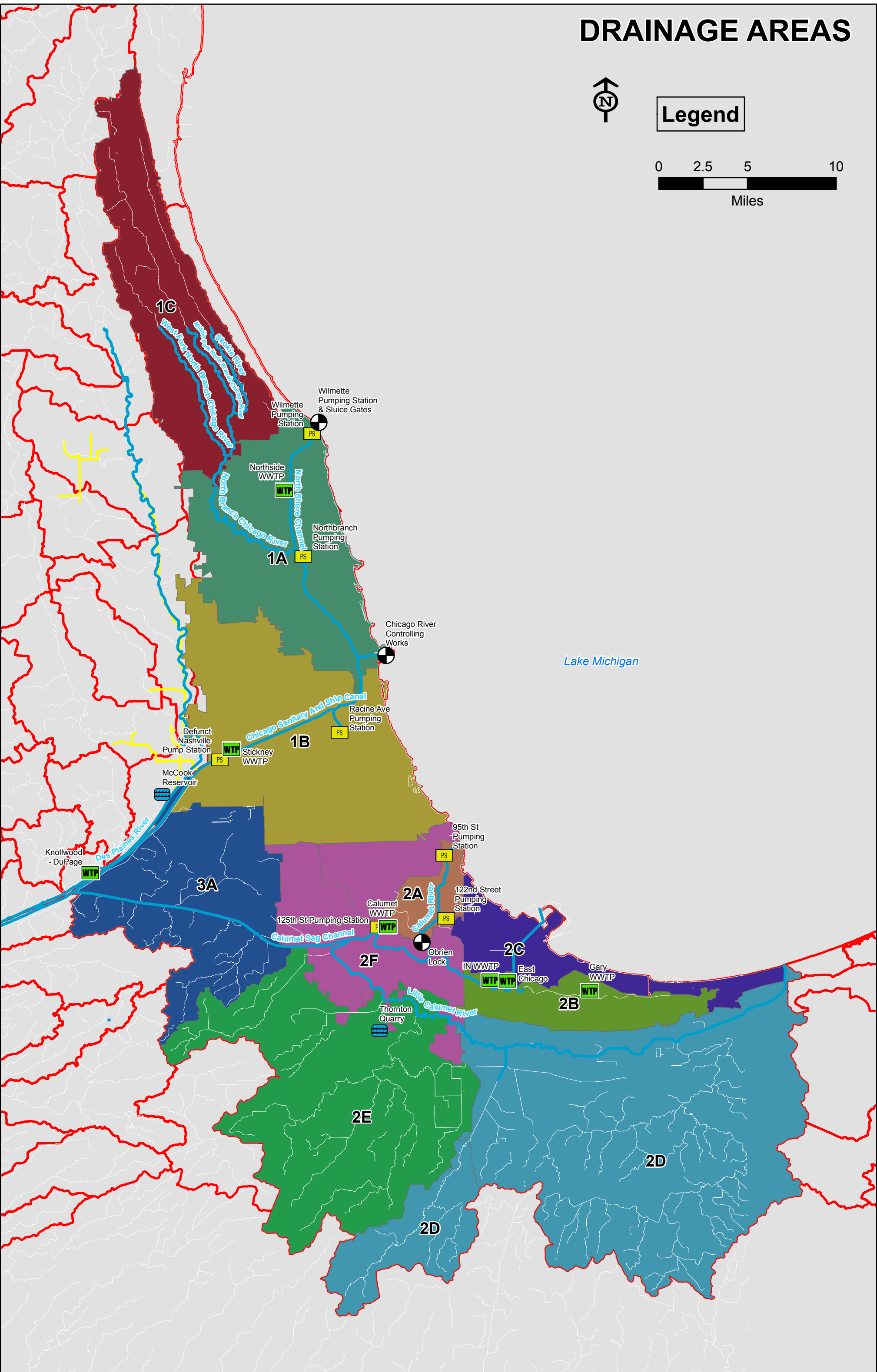



# Baseline Rainfall Runoff Volumes for 100-year Event

## Total Volume of Runoff for TARP Mainstream Drainage Area Above South Branch (1A)

ARP Mainstream Drainage Area above South Branch	98.09	sq. mi.
---	-------	---------

Volume in Million Gallons								
Drainage Area (acres)	62774.5	Rainfall (in)						
Tarp Capture (in)	0	2.5	3	3.5	7	7.5	7.6	8
CN	98	3,871	4,719	5,568	11,525	12,376	12,547	13,228
CN	90	2,610	3,382	4,173	9,926	10,763	10,930	11,601
CN	85	2,009	2,707	3,437	8,954	9,770	9,934	10,591
CN	80	1,515	2,131	2,789	8,002	8,792	8,951	9,588
CN	75	1,109	1,638	2,219	7,073	7,829	7,981	8,594

Runoff Volume in MG

## Total Volume of Runoff for TARP Mainstream Drainage Area below South Branch (1B)

ARP Mainstream Drainage Area below South Branch	127.82	sq. mi.
---	--------	---------

Volume in Million Gallons								
Drainage Area (acres)	81804.8	Rainfall (in)						
Tarp Capture (in)	0	2.5	3	3.5	7	7.5	7.6	8
CN	98	5,044	6,149	7,256	15,018	16,128	16,350	17,238
CN	90	3,401	4,407	5,438	12,935	14,025	14,244	15,118
CN	85	2,618	3,528	4,479	11,668	12,732	12,946	13,802
CN	80	1,975	2,777	3,635	10,428	11,457	11,664	12,495
CN	75	1,445	2,134	2,892	9,217	10,202	10,401	11,199

Runoff Volume in MG

## Total Volume of Runoff for TARP Calumet Drainage Area above Lake Calumet (2A)

TARP Calumet Drainage Area above Lake Calumet	14.18	sq. mi.
---	-------	---------

Volume in Million Gallons								
Drainage Area (acres)	9076.58	Rainfall (in)						
Tarp Capture (in)	0	2.5	3	3.5	7	7.5	7.6	8
CN	98	560	682	805	1,666	1,789	1,814	1,913
CN	90	377	489	603	1,435	1,556	1,580	1,677
CN	85	290	391	497	1,295	1,413	1,436	1,531
CN	80	219	308	403	1,157	1,271	1,294	1,386
CN	75	160	237	321	1,023	1,132	1,154	1,243

Runoff Volume in MG

## Total Volume of Runoff for TARP Calumet Drainage Area below Lake Calumet (2F)

TARP Calumet Drainage Area below Lake Calumet	78.16	sq. mi.
---	-------	---------

Volume in Million Gallons								
Drainage Area (acres)	50022.4	Rainfall (in)						
Tarp Capture (in)	0	2.5	3	3.5	7	7.5	7.6	8
CN	98	3,084	3,760	4,437	9,183	9,862	9,998	10,541
CN	90	2,080	2,695	3,325	7,910	8,576	8,710	9,244
CN	85	1,601	2,157	2,739	7,135	7,786	7,916	8,440
CN	80	1,207	1,698	2,223	6,377	7,006	7,133	7,641
CN	75	884	1,305	1,768	5,636	6,239	6,360	6,848

Runoff Volume in MG

## Total Volume of Runoff for North Branch outside TARP Drainage Area (1C)

Drainage Area Outside TARP (includes Lake County)	92.65	sq. mi.
---	-------	---------

Volume in Million Gallons								
Drainage Area (acres)	59298.41	Rainfall (in)						
Tarp Capture (in)	0	2.5	3	3.5	7	7.5	7.6	8
CN	85	1,898	2,557	3,247	8,458	9,229	9,384	10,005
CN	80	1,431	2,013	2,635	7,559	8,305	8,455	9,057
CN	75	1,047	1,547	2,096	6,681	7,395	7,539	8,118
CN	70	733	1,150	1,623	5,826	6,502	6,638	7,188
CN	65	479	815	1,211	4,996	5,626	5,754	6,271

Runoff Volume in MG

## Total Volume of Runoff for Little Calumet below Hart's Ditch (2E)

Little Calumet below Hart's Ditch	155.90	sq. mi.
-----------------------------------	--------	---------

Volume in Million Gallons								
Drainage Area (acres)	99776	Rainfall (in)						
Tarp Capture (in)	0	2.5	3	3.5	7	7.5	7.6	8
CN	85	3,193	4,303	5,463	14,231	15,529	15,790	16,834
CN	80	2,408	3,387	4,433	12,719	13,975	14,227	15,240
CN	75	1,763	2,603	3,527	11,242	12,444	12,686	13,660
CN	70	1,233	1,935	2,731	9,803	10,940	11,169	12,095
CN	65	806	1,371	2,037	8,406	9,466	9,681	10,551

Runoff Volume in MG

## Total Volume of Runoff for Little Calumet above Hart's Ditch (2D)

Little Calumet above Hart's Ditch	269.91	sq. mi.
-----------------------------------	--------	---------

Volume in Million Gallons								
Drainage Area (acres)	172742.4	Rainfall (in)						
Tarp Capture (in)	0	2.5	3	3.5	7	7.5	7.6	8
CN	85	5,528	7,450	9,458	24,638	26,886	27,337	29,144
CN	80	4,170	5,863	7,676	22,020	24,194	24,631	26,385
CN	75	3,051	4,507	6,106	19,464	21,544	21,963	23,649
CN	70	2,135	3,350	4,729	16,973	18,940	19,338	20,941
CN	65	1,395	2,374	3,527	14,553	16,389	16,762	18,267

Runoff Volume in MG

## Total Volume of Runoff for Grand Calumet River (2B)

Grand Calumet River (no lake runoff)	31.32	sq. mi.
--------------------------------------	-------	---------

Volume in Million Gallons								
Drainage Area (acres)	20044.99	Rainfall (in)						
Tarp Capture (in)	0	2.5	3	3.5	7	7.5	7.6	8
CN	85	641	864	1,098	2,859	3,120	3,172	3,382
CN	80	484	680	891	2,555	2,807	2,858	3,062
CN	75	354	523	709	2,259	2,500	2,549	2,744
CN	70	248	389	549	1,970	2,198	2,244	2,430
CN	65	162	275	409	1,689	1,902	1,945	2,120

Runoff Volume in MG



## Total Volume of Runoff for Grand Calumet lake runoff (2C)

Grand Calumet lake runoff	33.24	sq. mi.
---------------------------	-------	---------

Volume in Million Gallons								
Drainage Area (acres)	21275.08	Rainfall (in)						
Tarp Capture (in)	0	2.5	3	3.5	7	7.5	7.6	8
CN	90	884	1,146	1,414	3,364	3,648	3,704	3,932
CN	85	681	918	1,165	3,034	3,311	3,367	3,589
CN	80	514	722	945	2,712	2,980	3,034	3,250
CN	75	376	555	752	2,397	2,653	2,705	2,913
CN	70	263	413	582	2,090	2,333	2,382	2,579

Runoff Volume in MG

## Total Volume of Runoff for CSSC/Cal Sag (3A)

CSSC/Cal Sag	90.49	sq. mi.
--------------	-------	---------

Volume in Million Gallons								
Drainage Area (acres)	57914.21	Rainfall (in)						
Tarp Capture (in)	0	2.5	3	3.5	7	7.5	7.6	8
CN	85	1,853	2,498	3,171	8,260	9,014	9,165	9,771
CN	80	1,398	1,966	2,573	7,383	8,111	8,258	8,846
CN	75	1,023	1,511	2,047	6,525	7,223	7,363	7,929
CN	70	716	1,123	1,585	5,690	6,350	6,483	7,021
CN	65	468	796	1,183	4,879	5,495	5,620	6,124

Runoff Volume in MG

<b>Section</b>	<b>Area</b>
1A	98.09
1B	127.82
1C	92.65
2A	14.18
2B	31.32
2C	33.24
2D	269.91
2E	155.90
2F	78.16
3A	90.49

total area 991.76 sq. mi.

TARP area 318.25 sq. mi.

## Green Infrastructure Volume Storage and Costing Estimate

### Assumptions:

- 18 years (period of green infrastructure implementation)
- 6.3 miles/year of CDOT major (arterials) street reconstruction
- 4.7 miles/year of CDOT residential street reconstruction
- 11.25 miles/year of CDWM major (arterials) street water main replacements (assume reconstruction w/ green infrastructure) ==> based on 90 miles per year total and 1/4 of miles are arterial and 50% w/ enough reconstruction to implement green infrastructure
- 33.75 miles/year of CDWM residential street water main replacements (assume reconstruction w/ green infrastructure) ==> based on 90 miles per year total and 3/4 residential and 50% w/ enough reconstruction to implement green infrastructure
- 3.125 miles/year of CDWM major (arterials) street sewer replacements (assume reconstruction w/ green infrastructure) ==> based on 25 miles per year total and 50% w/ enough reconstruction to implement green infrastructure
- 9.375 miles/year of CDWM residential street sewer replacements (assume reconstruction w/ green infrastructure) ==> based on 25 miles per year total and 50% w/ enough reconstruction to implement green infrastructure
- 0 miles/year of alleys ==> included in baseline under existing green alleys program

### City of Chicago

ROW Type	Arterial	Residential	Alley	Total	
Miles of Road	372	861	0	1233 miles	
ROW Width	87	66	16		total ROW widths (not just curb to curb)
ROW Area (acres)	3924	6887	0	10811 acres	
% ROW GI applied	100%	100%	100%		
Effective ROW Area (acres)	3924.491	6886.8	0	10811 acres	
GI Capture (inches)	2	2	2		
Volume Captured (MG)	213.6	374.8	0.0	<b>588</b> MG	

**588** MG of GI storage

1233 total miles of roadway  
 1233 approx. miles of residential and arterial roadway w/ GI applied (assumes 25%)  
 0 approx. miles of alley roadway w/ GI applied (assumes 25%)

10811 acres of effective ROW area  
 470,939,832 ft<sup>2</sup> of effective ROW area  
 587 MG of GI storage - check

### GI Cost Option 1

\$1.35 \$/ft<sup>2</sup> of GI by D.A. from MMSD report  
 \$0.00 assumed cost per mile of residential and arterial road work needed w/ GI implementation (programmatic reconstruction cost for WPA from Chicago)  
 \$0.00 assumed cost per mile of alley road work needed w/ GI implementation (half of residential/arterial cost)

\$ 635,768,773 cost GI for total D.A. (approx. 25% of ROW) - does not include roadway work  
 \$0.00 cost for arterial and residential roadway work associated w/ GI  
 \$0.00 cost for alley roadway work associated w/ GI

**\$ 635,768,773** cost of GI for programmed CDOT and CDWM replacements/reconstruction  
**\$ 1,080,583** \$/MG

### GI Cost Option 2

\$3.1 \$/ft<sup>2</sup> of for GI by D.A. from CDOT, CH2M estimate from Philly and Cincinnati

**\$ 1,443,589,553** cost of GI for programmed CDOT and CDWM replacements/reconstruction  
**\$ 2,453,593** \$/MG

## Total Volume of Runoff for TARP Drainage Area (with Des Plaines)

TARP Drainage Area	348.6	sq. mi.
--------------------	-------	---------

Volume in Acre*ft								
Drainage Area (acres)	223104	Rainfall (in)						
Tarp Capture (in)	0	2.5	3	3.5	4	4.5	5	5.5
CN	90	28464	36889	45512	54274	63134	72068	81059
CN	85	21910	29528	37489	45695	54087	62619	71262
CN	80	16526	23240	30423	37959	45765	53784	61973
CN	75	12095	17863	24203	30987	38121	45537	53183
CN	70	8464	13280	18743	24721	31118	37859	44886

Runoff Volume in acre\*ft



Volume in Million Gallons								
Drainage Area (acres)	223104	Rainfall (in)						
Tarp Capture (in)	0	2.5	3	3.5	4	4.5	5	5.5
CN	90	9275	12020	14830	17685	20572	23484	26413
CN	85	7139	9622	12216	14890	17624	20404	23221
CN	80	5385	7573	9913	12369	14913	17526	20194
CN	75	3941	5821	7887	10097	12422	14838	17330
CN	70	2758	4327	6107	8055	10140	12336	14626

Runoff Volume in MG

Runoff Volume approx. equals TARP storage

# Roads within One Mile of River

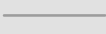
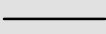
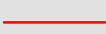
## Legend

-  Alley
-  Arterial
-  Residential
-  1 mile stream Buffer
-  TARP BOUNDARY

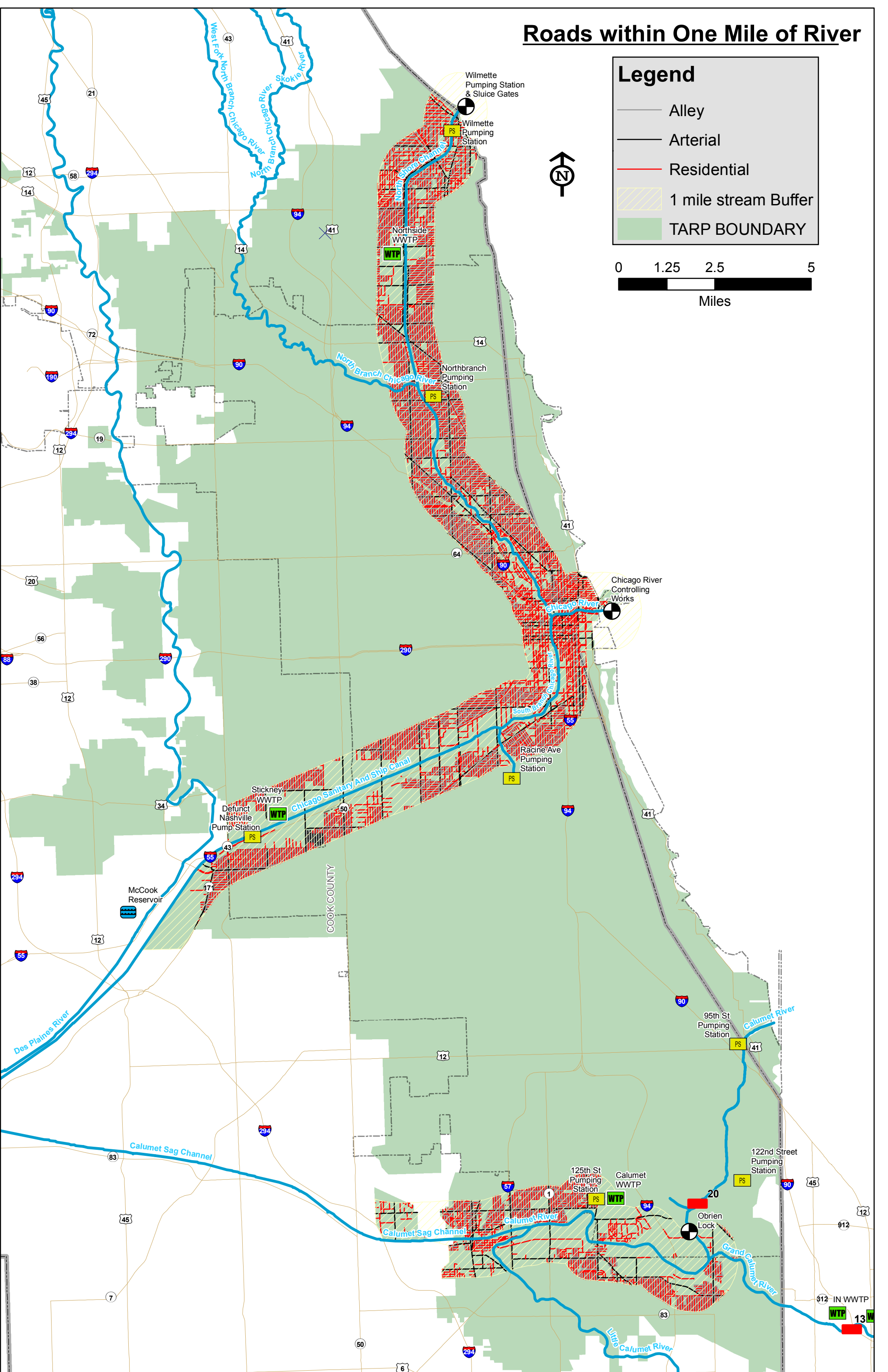
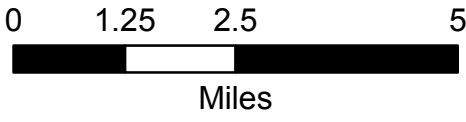



## Partial Sewer Separation Volume and Cost Estimates - Arterial Road ROW

Assumed average arterial ROW width	87	ft
ROW linear miles	62.0	miles

- 988.97 total roadway mileage in sewer separation area
- 5941 total roadway mileage within TARP areas
- 0.17 ratio of roadway mileage in sewer area vs. TARP area ==> use for % of green infrastructure mileage to apply sewer separation

Volume in Acre*ft								
Drainage Area (acres)	653.2913	Rainfall (in)						
Tarp Capture (in)	0	3	3.5	4	4.5	7.5	7.6	8
CN	98	151	178	205	232	395	401	422
CN	90	108	133	159	185	344	349	371
CN	80	68	89	111	134	281	286	306
CN	70	39	55	72	91	220	224	243
CN	60	18	29	41	56	161	165	181

### Runoff Volume in acre\*ft

Volume in Million Gallons								
Drainage Area (acres)	653.2913	Rainfall (in)						
Tarp Capture (in)	0	3	3.5	4	4.5	7.5	7.6	8
CN	98	49	58	67	76	129	131	138
CN	90	35	43	52	60	112	114	121
CN	80	22	29	36	44	91	93	100
CN	70	13	18	24	30	72	73	79
CN	60	6	9	14	18	53	54	59

### Runoff Volume in MG

Sewer Separation Costs

\$0.00 assumed cost per mile of residential and arterial road work needed w/ storm sewer construction/separation (programmatic reconstruction cost for WPA from Chicago)

\$2,250,000.00 cost per mile for sewer separation - does not include roadway work (rough estimate based on 3 x \$750,000 estimate for 8" sanitary/water line)

62.0 miles of sewer separation

**\$ 139,387,589** cost of sewer separation for 75% of arterial streets within 1 mile buffer of waterways in TARP D.A.

**\$ 1,842,718** \$/MG

## Partial Sewer Separation Volume and Cost Estimates - Residential Road ROW

Assumed average arterial ROW width	87	ft
Mainstream ROW linear miles	143.3	miles

- 988.97 total roadway mileage in sewer separation area  
 5941 total roadway mileage within TARP areas  
 0.17 ratio of roadway mileage in sewer area vs. TARP area ==> use for % of green infrastructure mileage to apply sewer separation

Volume in Acre*ft		Rainfall (in)						
Drainage Area (acres)	1511.181	Rainfall (in)						
Tarp Capture (in)	0	3	3.5	4	4.5	7.5	7.6	8
CN	98	349	411	474	537	914	927	977
CN	90	250	308	368	428	795	807	857
CN	80	157	206	257	310	650	661	708
CN	70	90	127	167	211	508	519	562
CN	60	42	67	96	128	373	382	420

### Runoff Volume in acre\*ft

Volume in Million Gallons		Rainfall (in)						
Drainage Area (acres)	1511.181	Rainfall (in)						
Tarp Capture (in)	0	3	3.5	4	4.5	7.5	7.6	8
CN	98	114	134	155	175	298	302	318
CN	90	81	100	120	139	259	263	279
CN	80	51	67	84	101	212	215	231
CN	70	29	41	55	69	166	169	183
CN	60	14	22	31	42	122	125	137

### Runoff Volume in MG

### Sewer Separation Costs

\$0.00 assumed cost per mile of residential and arterial road work needed w/ storm sewer construction/separation (programmatic reconstruction cost for WPA from Chicago)

\$2,250,000.00 cost per mile for sewer separation - does not include roadway work (rough estimate based on 3 x \$750,000 estimate for 8" sanitary/water line)

143.3 miles of sewer separation

**\$ 322,428,607** cost of sewer separation for 75% of arterial streets within 1 mile buffer of waterways in TARP D.A.

**\$ 1,842,718** \$/MG



# City of Chicago Stormwater Management Ordinance (SMO) Estimated Storage through 2030 w/ Current SMO

Year	Measure	Data	Sum of EI (Sum of PI (ac))	# events	>0.5	>0.2 & ≤0.5	≤0.2	>1yr	
				128	29.44	26.88	71.68		5%
				134	30.82	28.14	75.04		7%
				94	21.62	19.74	52.64		12%
				WY11e	118.7	27.3	24.9	66.5	

				delta	>0.5	>.2&≤.5	≤0.2		Ac Ft	MG
08	15% Imp Red	57.37933	25.2724288	32	39.4	25.2	19.2		83.7	27.29
	Capture 1/2 in	34.95453	40.1929578		49.3	31.5	24.0		104.8	34.16
	N/A	9.652815	20.5992424							
	(blank)	1	2.7							
08 Total		102.9867	88.764629						188.6	61.45
09	15% Imp Red	91.89106	81.8021789	10	13.0	8.3	6.3		27.5	8.98
	Capture 1/2 in	104.888	134.097938		172.2	110.1	83.9		366.1	119.32
	N/A	6.24348	8.66578053							
	(blank)	0	4.13							
09 Total		203.0225	228.695898						393.7	128.30
10	15% Imp Red	60.03591	33.9849563	26	23.5	15.0	18.2		56.6	18.46
	Capture 1/2 in	75.87822	104.896776		94.5	60.4	46.0		200.9	65.47
	N/A	16.011	1.82							
	(blank)									
10 Total		151.9251	140.701732						257.5	83.93
11	15% Imp Red	34.32281	16.5790184	18	20.2	12.9	4.1		37.1	12.11
	Capture 1/2 in	31.05718	31.1140138		31.1	22.6	17.2		71.0	23.13
	N/A	2.41	0.39							
	(blank)	2.577	1.027							
11 Total		70.36699	49.1100321						143.8	46.86
Grand Total		528.3013	507.272291						245.8924	80

Area (k) \* inches (L7)\*# events (M2)  
Area (PI)\*inches captured\*# events

Year	Cumulative storage (MG)
2007	0
2008	61.45
2009	189.75
2010	273.68
2011	320.55
2012	400.68
2013	480.82
2014	560.95
2015	641.09
2016	721.23
2017	801.36
2018	881.50
2019	961.64
2020	1,041.77
2021	1,121.91
2022	1,202.05
2023	1,282.18
2024	1,362.32
2025	1,442.45
2026	1,522.59
2027	1,602.73
2028	1,682.86
2029	1,763.00
2030	1,843.14

Each year we add, (from 4 yr average) 80 MG of additional storage

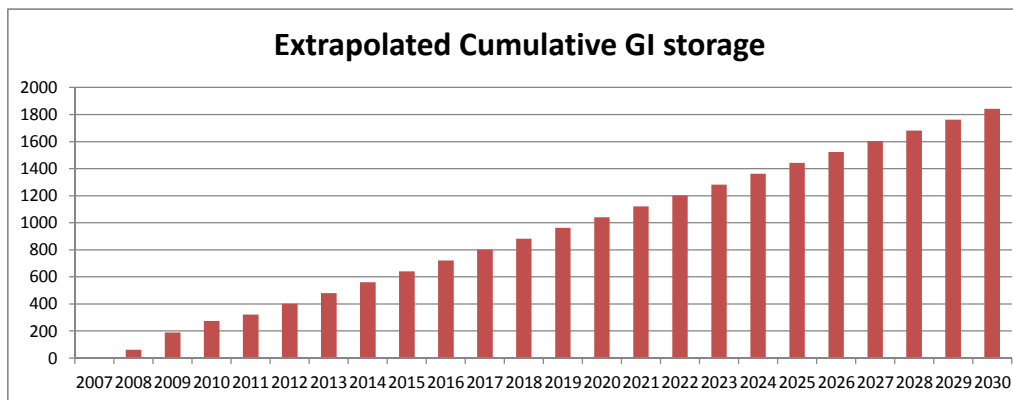

# City of Chicago Stormwater Management Ordinance (SMO) Estimated Storage through 2030 w/ Proposed SMO

Regulated	Yes		# events	>0.5	>0.2 & ≤0.5	≤0.2	>1yr	
			WY 2008	128	29.44	26.88	71.68	5%
			WY 2009	134	30.82	28.14	75.04	7%
		Data	WY 2010	94	21.62	19.74	52.64	12%
Year	Measure	Sum of EI (Sum of PI (ac))	WY11e	118.7	27.3	24.9	66.5	

			delta	>0.5	>2&≤5	≤0.2		Ac Ft	MG	
08	25% Imp Red	57.37933	25.2724288	54	65.8	42.0	32.0	139.8	45.57	Area (k) * inches (L7)*# events (M2)
	Capture 1 in	34.95453	40.1929578		98.6	31.5	24.0	154.1	50.23	Area (PI)*inches captured*# events
	N/A	9.652815	20.5992424							
	(blank)	1	2.7							
08 Total		102.9867	88.764629					294.0	95.80	
09	25% Imp Red	91.89106	81.8021789	17	21.6	13.8	10.5	46.0	14.99	
	Capture 1 in	104.888	134.097938		344.4	110.1	83.9	538.3	175.44	
	N/A	6.24348	8.66578053							
	(blank)	0	4.13							
09 Total		203.0225	228.695898					584.3	190.43	
10	25% Imp Red	60.03591	33.9849563	44	39.2	25.0	50.7	114.9	37.46	
	Capture 1 in	75.87822	104.896776		189.0	60.4	46.0	295.4	96.27	
	N/A	16.011	1.82							
	(blank)									
10 Total		151.9251	140.701732					410.3	133.73	
11	25% Imp Red	34.32281	16.5790184	30	33.7	21.5	11.4	66.6	21.70	
	Capture 1 in	31.05718	31.1140138		62.3	22.6	17.2	102.1	33.27	
	N/A	2.41	0.39							
	(blank)	2.577	1.027							
11 Total		70.36699	49.1100321					224.4	73.12	
Grand Total		528.3013	507.272291					1513.0	493.08	
								<b>378.2453</b>	<b>123</b>	annual average incremental increase

Adjusted for proposed ordinance w/ 1 inch capture and 25% impervious reduction

Year	Cumulative storage (MG)
2007	0
2008	61.45
2009	189.75
2010	273.68
2011	320.55
2012	400.68
2013	480.82
2014	560.95
2015	641.09
2016	721.23
2017	844.50
2018	967.77
2019	1,091.04
2020	1,214.31
2021	1,337.58
2022	1,460.85
2023	1,584.12
2024	1,707.39
2025	1,830.66
2026	1,953.93
2027	2,077.20
2028	2,200.47
2029	2,323.74
2030	2,447.01

Each year we add, (from 4 yr average) 80 MG of additional storage under current ordinance  
 Each year we add, (from 4 yr average) 123 MG of additional storage under proposed ordinance

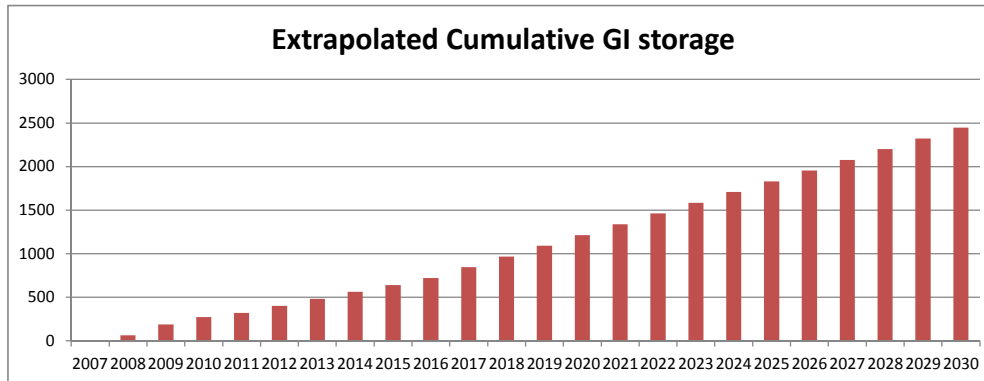

**Down River Alternative Volume Matrix and Cost Estimates**

Total Inflow Volume	88,000	MG	inflow volume for 100-yr storm based on varying CNs by basin
Alternative Target (Baseline w/ Adjustments for Project Impacts)	30,300	MG	remaining volume required for mitigation (subtracting volume impacted by alternative)
Running Total for Improvements before Tunnels/Reservoir	21,357	MG	volume mitigated prior to additional tunnels/reservoirs

Condition	Flood Management Element	Volume (MG)	Capital Cost	Notes
Baseline	Green Infrastructure - Stormwater Management Ordinance	1,800	-	existing GI from Chicago Stormwater Management Ordinance (SMO)
	Green alleys	100	-	existing green alley program
	Sewer Separation	-	-	no existing program
	Floodplain	1,300	-	existing MWRD North Branch DWP projects (cost \$340 M for Techny C and Wilmette reservoirs)
	Channel Convey	30,300	-	CSSC flow estimated from USGS Lemont gage during September 2008 storm event
	Lake Discharges	11,000	-	flow from MWRD backflows during September 2008 storm event
	Tunnel	2,300	-	storage in existing tunnels from MWRD TARP Status Report letter (2010)
	Reservoir	13,442	-	volumes for Thornton (4.8 BG) and McCook (10 BG) from MWRD TARP Status Report Letter (2010) minus proated storage for Des Plaines (35 sq. mi. of 257.8 sq mi. for McCook)
	Add'l Storage/Conveyance	27,758	-	remaining storage/volume within system not accounted for by specific programs/elements
Improvements	Green Infrastructure - ROW	588	\$1,000,000,000	GI assumed for drainage areas within programmed CDOT and CDWM areas; intent is for reserving storage in TARP; outside of TARP area, other measures (floodplain, etc.) are more effective and economical to meet specific goals for 100-yr event
	Stormwater Management Ord. Amendment	600	-	proposed ordinance revision in 2017 for 1 inch of capture (total of 2,400 MG through 2030, add'l 600 MG w/ ordinance amendment)
	Sewer Separation	251	\$500,000,000	assumed for TARP drainage only up to 4.5 inches (assumed CSO at 4.5 in w/ TARP online); intent is for reserving storage in TARP; not included outside of TARP area volume remains the same, just conveyed through different pipe
	Floodplain Storage	1,700	\$360,000,000	potential MWRD North Branch DWP projects (cost based on \$210k per MG of storage) ==> see add'l spreadsheet for volumes and costs
	Tunnel to Lake Discharge - Mainstream	15,200	\$750,000,000	remaining portion of target volume assumed in Mainstream system (remaining volume prorated based on Mainstream TARP area vs total TARP area); cost based on TARP (\$85,000/MG); assumes 15 miles in upper CAWS (Chicago River to McCook) w/ a 35 ft diameter tunnel
	Tunnel to Lake Discharge - Calumet	6,200	\$750,000,000	remaining portion of target volume assumed in Calumet system (remaining volume prorated based on Calumet TARP area vs total TARP area) ==> volume discharged to Lake MI through tunnel; assumes 15 miles in lower CAWS (Little Cal/Cal Sag confluence to Lake Calumet and Lake Calumet to Lake MI) w/ a 35 ft diameter tunnel and 4 ft of head w/ no pump station; cost (\$50M/mile) based on City of Chicago master and CIP planning
	Pump Station - Mainstream	-	\$200,000,000	pump station for 7,800 cfs ==> cost prorated based on flow from New Orleans pump station (\$500 M for 19,100 cfs)
	Tunnel to Lake Discharge - Little Calumet	4,524	\$300,000,000	assumed volume based on hydrograph for USACE Hart's ditch control structure (2000 cfs for 7 days); cost based on 30 ft diameter tunnel 7 miles long using City CIP data of \$43.5M/mile for rock (\$9,000/ft=\$47.5M/mile from North Branch DWP for 18 ft, McCormick Place \$12M/mile for 12 ft dia, City CIP data \$43.5M/mile for rock at 30 ft dia)
	Channel Conveyance	1,280	-	capacity at Wilmette, CRCW, and O'Brien lake level of approx. 3.5 ft CCD (taken from CAWS model) and an assumed 12 hour duration minus baseline backflows
	Barrier Structure/Embankment	-	\$100,000,000	assumes 1 barriers downstream of CSSC/Cal Sag confluence ==> cost for flood control elements only (siphons, piping, gates, etc.)
Total Flood Management Improvement Cost:			<b>\$4,000,000,000</b>	

**Mid System Alternative Volume Matrix and Cost Estimates**

Total Inflow Volume	88,000	MG	inflow volume for 100-yr storm based on varying CNs by basin
Alternative Target (Baseline w/ Adjustments for Project Impacts)	20,524	MG	remaining volume required for mitigation (subtracting volume impacted by alternative) ==> CSSC flow d/s of Bubbly Creek and backflows at O'brien CSSC flows: d/s of Bubbly Creek (approx. RM 320) estimated from USACE CAWS model for 100-yr event ==> flow approx. 10,000 cfs, used volume/flow calc. from USGS Lemont gage during 2008 event to prorate volume here; O'Brien: use max backflow from 2008 event
Running Total for Improvements before Tunnels/Reservoir	384	MG	volume mitigated prior to additional tunnels/reservoirs

Condition	Flood Management Element	Volume (MG)	Capital Cost	Notes
Baseline	Green Infrastructure - Stormwater Management Ordinance	1,800	-	existing GI from Chicago Stormwater Management Ordinance (SMO)
	Green alleys	100	-	existing green alley program
	Sewer Separation	-	-	no existing program
	Floodplain	1,300	-	existing MWRD North Branch DWP projects (cost \$340 M for Techny C and Wilmette reservoirs)
	Channel Convey	30,300	-	CSSC flow estimated from USGS Lemont gage during September 2008 storm event
	Lake Discharges	11,000	-	flow from MWRD backflows during September 2008 storm event
	Tunnel	2,300	-	storage in existing tunnels from MWRD TARP Status Report letter (2010)
	Reservoir	13,442	-	volumes for Thornton (4.8 BG) and McCook (10 BG) from MWRD TARP Status Report Letter (2010) minus proated storage for Des Plaines (35 sq. mi. of 257.8 sq mi. for McCook)
	Add'l Storage/Conveyance	27,758	-	remaining storage/volume within system not accounted for by specific programs/elements ==> includes conveyance capacity in CSSC and Cal Sag d/s of barriers
Improvements	Green Infrastructure - ROW	588	\$1,000,000,000	GI assumed for drainage areas within programmed CDOT and CDWM areas; intent is for reserving storage in TARP; outside of TARP area, other measures (floodplain, etc.) are more effective and economical to meet specific goals for 100-yr event
	Stormwater Management Ord. Amendment	600	-	proposed ordinance revision in 2017 for 1 inch of capture (total of 2,400 MG through 2030, add'l 600 MG w/ ordinance amendment)
	Sewer Separation	251	\$500,000,000	assumed for TARP drainage only up to 4.5 inches (assumed CSO at 4.5 in w/ TARP online); intent is for reserving storage in TARP; not included outside of TARP area volume remains the same, just conveyed through different pipe
	Floodplain	1,700	\$360,000,000	potential MWRD North Branch DWP projects (cost based on \$210k per MG of storage) ==> see add'l spreadsheet for volumes and costs
	Tunnel	-	-	no tunnels needed for storage
	Reservoir	400	-	no storage needed ==> upper CAWS mitigated w/ GI, sewer separation, floodplain; lower CAWS mitigated w/ Little Cal siphon and GI/sewer separation
	Tunnel to Lake Discharge - Little Calumet	4,524	\$300,000,000	assumed volume based on hydrograph for USACE Hart's ditch control structure (2000 cfs for 7 days); cost based on 30 ft diameter tunnel 7 miles long using City CIP data of \$43.5M/mile for rock (\$9,000/ft=\$47.5M/mile from North Branch DWP for 18 ft, McCormick Place \$12M/mile for 12 ft dia, City CIP data \$43.5M/mile for rock at 30 ft dia)
	Channel Conveyance - baseline	12,476	-	CSSC flows d/s of Bubbly Creek (approx. RM 320) estimated from USACE CAWS model for 100-yr event ==> flow approx. 7,000 cfs, used volume/flow calc. from USGS Lemont gage during 2008 event to prorate volume here; assumes RAPS provides hydraulic dam effect under baseline conditions and barrier does not adversely impact flow lakeside of barrier; assumes CSSC d/s of Bubbly Creek has capacity to handle RAPS
	Channel Conveyance - improvements	-	\$100,000,000	reorientation of Little Calumet and Bubbly Creek to enhance flow to west
	Barrier Structure/Embankment	-	\$120,000,000	assumes 1 barrier at South Branch for flood control elements (\$100 M) and 2 smaller barriers at Grand and Little Calumet (\$10M ea) ==> Calumet barrier cost included w/ transportation costs

Total Flood Management Improvement Cost: **\$2,400,000,000**

**Near Lake Alternative Volume Matrix and Cost Estimates**

Total Inflow Volume	88,000	MG	inflow volume for 100-yr storm based on varying CNs by basin
Alternative Target (Baseline w/ Adjustments for Project Impacts)	15,524	MG	remaining volume required for mitigation (subtracting volume impacted by alternative) ==> backflow volumes plus Little Calumet at Harts D
Running Total for Improvements before Tunnels/Reservoir	6,916	MG	volume mitigated prior to additional tunnels/reservoirs

Condition	Flood Management Element	Volume (MG)	Capital Cost	Notes
Baseline	Green Infrastructure - Stormwater Management Ordinance	1,800	-	existing GI from Chicago Stormwater Management Ordinance (SMO)
	Green alleys	100	-	existing green alley program
	Sewer Separation	-	-	no existing program
	Floodplain	1,300	-	existing MWRD North Branch DWP projects (cost \$340 M for Techny C and Wilmette reservoirs)
	Channel Convey	30,300	-	CSSC flow estimated from USGS Lemont gage during September 2008 storm event
	Lake Discharges	11,000	-	flow from MWRD backflows during September 2008 storm event
	Tunnel	2,300	-	storage in existing tunnels from MWRD TARP Status Report letter (2010)
	Reservoir	13,442	-	volumes for Thornton (4.8 BG) and McCook (10 BG) from MWRD TARP Status Report Letter (2010) minus proated storage for Des Plaines (35 sq. mi. of 257.8 sq mi. for McCook)
	Add'l Storage/Conveyance	27,758	-	remaining storage/volume within system not accounted for by specific programs/elements
Improvements	Green Infrastructure - ROW	588	\$1,000,000,000	GI assumed for drainage areas within programmed CDOT and CDWM areas; intent is for reserving storage in TARP; outside of TARP area, other measures (floodplain, etc.) are more effective and economical to meet specific goals for 100-yr event
	Stormwater Management Ord. Amendment	600	-	proposed ordinance revision in 2017 for 1 inch of capture (total of 2,400 MG through 2030, add'l 600 MG w/ ordinance amendment)
	Sewer Separation	251	\$500,000,000	assumed for TARP drainage only up to 4.5 inches (assumed CSO at 4.5 in w/ TARP online); intent is for reserving storage in TARP; not included outside of TARP area volume remains the same, just conveyed through different pipe
	Floodplain	1,700	\$360,000,000	potential MWRD North Branch DWP projects (cost based on \$210k per MG of storage) ==> see add'l spreadsheet for volumes and costs
	Tunnel	945	\$2,000,000,000	assumes 25 miles in upper CAWS (NB/NSC confluence to McCook) and 20 miles in lower CAWS (Little Cal/Cal Sag confluence to Calumet mouth and Lake Calumet to Thornton); tunnel storage (21 MG/mile) and average size based on TARP tunnels ==> assume average 30 ft diam. and costs based on Chicago CIP for 30 ft diam. in rock ==> \$43.5M/mile
	Reservoir	6,900	\$600,000,000	remainder of target volume assumed as tunnel and reservoir; cost based on TARP (\$85,000/MG)
	Tunnel to Lake Discharge - Little Calumet	4,524	\$300,000,000	assumed volume based on hydrograph for USACE Hart's ditch control structure (2000 cfs for 7 days); cost based on 30 ft diameter tunnel 7 miles long using City CIP data of \$43.5M/mile for rock (\$9,000/ft=\$47.5M/mile from North Branch DWP for 18 ft, McCormick Place \$12M/mile for 12 ft dia, City CIP data \$43.5M/mile for rock at 30 ft dia)
	Channel Conveyance	-	\$100,000,000	reorientation of Little Calumet and Bubbly Creek to enhance flow to west
	Barrier Structure/Embankment	-	\$120,000,000	assumes 2 barriers at Northside WWTP and CRCW structures (\$50M ea) and 2 smaller barriers at Grand and Little Calumet (\$10M ea) ==> Calumet mouth cost included in transportation costs
Total Flood Management Improvement Cost:			<b>\$5,000,000,000</b>	



# City of Chicago Master & CIP Planning Data for Tunnel Costs

Tunnels	per foot			
	Micro tunneling	TBM Soil	TBM Rock	TBM Mixed
24"	\$1,150			
36"	\$1,665			
48"	\$2,195	\$3,700	\$1,220	\$1,586
60"	\$2,725	\$3,800	\$1,490	\$1,937
72"	\$3,255	\$3,900	\$1,760	\$2,288
84"	\$3,785	\$4,000	\$2,030	\$2,639
96"	\$4,315	\$4,100	\$2,300	\$2,990
108"	\$4,845	\$4,200	\$2,570	\$3,341
120"	\$5,375	\$4,300	\$2,840	\$3,692
132"		\$4,400	\$3,110	\$4,043
144"		\$4,500	\$3,380	\$4,394
156"		\$4,600	\$3,650	\$4,745
168"		\$4,700	\$3,920	\$5,096
180"		\$4,800	\$4,190	\$5,447
192"		\$4,900	\$4,460	\$5,798
204"		\$5,000	\$4,730	\$6,149
216"		\$5,100	\$5,000	\$6,500
228"		\$5,200	\$5,270	\$6,851
240"		\$5,300	\$5,540	\$7,202
252"		\$5,400	\$5,810	\$7,553
264"		\$5,500	\$6,080	\$7,904
276"		\$5,600	\$6,350	\$8,255
288"		\$5,700	\$6,620	\$8,606
300"		\$5,800	\$6,890	\$8,957
312"		\$5,900	\$7,160	\$9,308
324"		\$6,000	\$7,430	\$9,659
336"		\$6,100	\$7,700	\$10,010
348"		\$6,200	\$7,970	\$10,361
360"		\$6,300	\$8,240	

diameter ft	per mile			
	Micro tunneling	TBM Soil	TBM Rock	TBM Mixed
	\$6,072,000	\$0	\$0	\$0
	\$8,791,200	\$0	\$0	\$0
	\$11,589,600	\$19,536,000	\$6,441,600	\$8,374,080
	\$14,388,000	\$20,064,000	\$7,867,200	\$10,227,360
	\$17,186,400	\$20,592,000	\$9,292,800	\$12,080,640
	\$19,984,800	\$21,120,000	\$10,718,400	\$13,933,920
	\$22,783,200	\$21,648,000	\$12,144,000	\$15,787,200
	\$25,581,600	\$22,176,000	\$13,569,600	\$17,640,480
	\$28,380,000	\$22,704,000	\$14,995,200	\$19,493,760
	\$0	\$23,232,000	\$16,420,800	\$21,347,040
	\$0	\$23,760,000	\$17,846,400	\$23,200,320
	\$0	\$24,288,000	\$19,272,000	\$25,053,600
	\$0	\$24,816,000	\$20,697,600	\$26,906,880
	\$0	\$25,344,000	\$22,123,200	\$28,760,160
16	\$0	\$25,872,000	\$23,548,800	\$30,613,440
17	\$0	\$26,400,000	\$24,974,400	\$32,466,720
18	\$0	\$26,928,000	\$26,400,000	\$34,320,000
	\$0	\$27,456,000	\$27,825,600	\$36,173,280
20	\$0	\$27,984,000	\$29,251,200	\$38,026,560
	\$0	\$28,512,000	\$30,676,800	\$39,879,840
22	\$0	\$29,040,000	\$32,102,400	\$41,733,120
	\$0	\$29,568,000	\$33,528,000	\$43,586,400
	\$0	\$30,096,000	\$34,953,600	\$45,439,680
25	\$0	\$30,624,000	\$36,379,200	\$47,292,960
	\$0	\$31,152,000	\$37,804,800	\$49,146,240
27	\$0	\$31,680,000	\$39,230,400	\$50,999,520
	\$0	\$32,208,000	\$40,656,000	\$52,852,800
	\$0	\$32,736,000	\$42,081,600	\$54,706,080
30	\$0	\$33,264,000	\$43,507,200	\$56,559,360

35 \$35,904,000 \$50,635,200 \$65,825,760

interpolated/extrapolated

## MWRDGC Data for TARP

Tunnel	miles	\$ (millions)	\$ million/mile
TARP Total	109.4	\$ 2,300.00	\$ 21.02
Mainstream	40.5	\$ 1,142.00	\$ 28.20
Calumet	36.7	\$ 658.00	\$ 17.93
DesPlaines	25.6	\$ 469.00	\$ 18.32

	dollar	capacity BG	\$/MG
Thornton	\$ 418,000,000	4.8	\$ 87,083
McCook	\$ 794,000,000	10	\$ 79,400





# Supplemental Data

- Model data taken from USACE CAWS model
- All elevations shown are in the NAVD 88 vertical datum
- All water surface elevations shown are based on a 100 year event with fully operational locks

# CONVERSION TABLE

City of Chicago Datum	0	NGVD 29	579.48	NAVD 88	579.18
1 CFS	0.646 MGD		1 MGD	1.55 CFS	
1 acre-ft	0.326 MG	0.000326 BG		1 MG	3.0689 acre-ft
				1 BG	3,069 acre-ft

# Wilmette Pumping Station (North Shore Channel) Lock

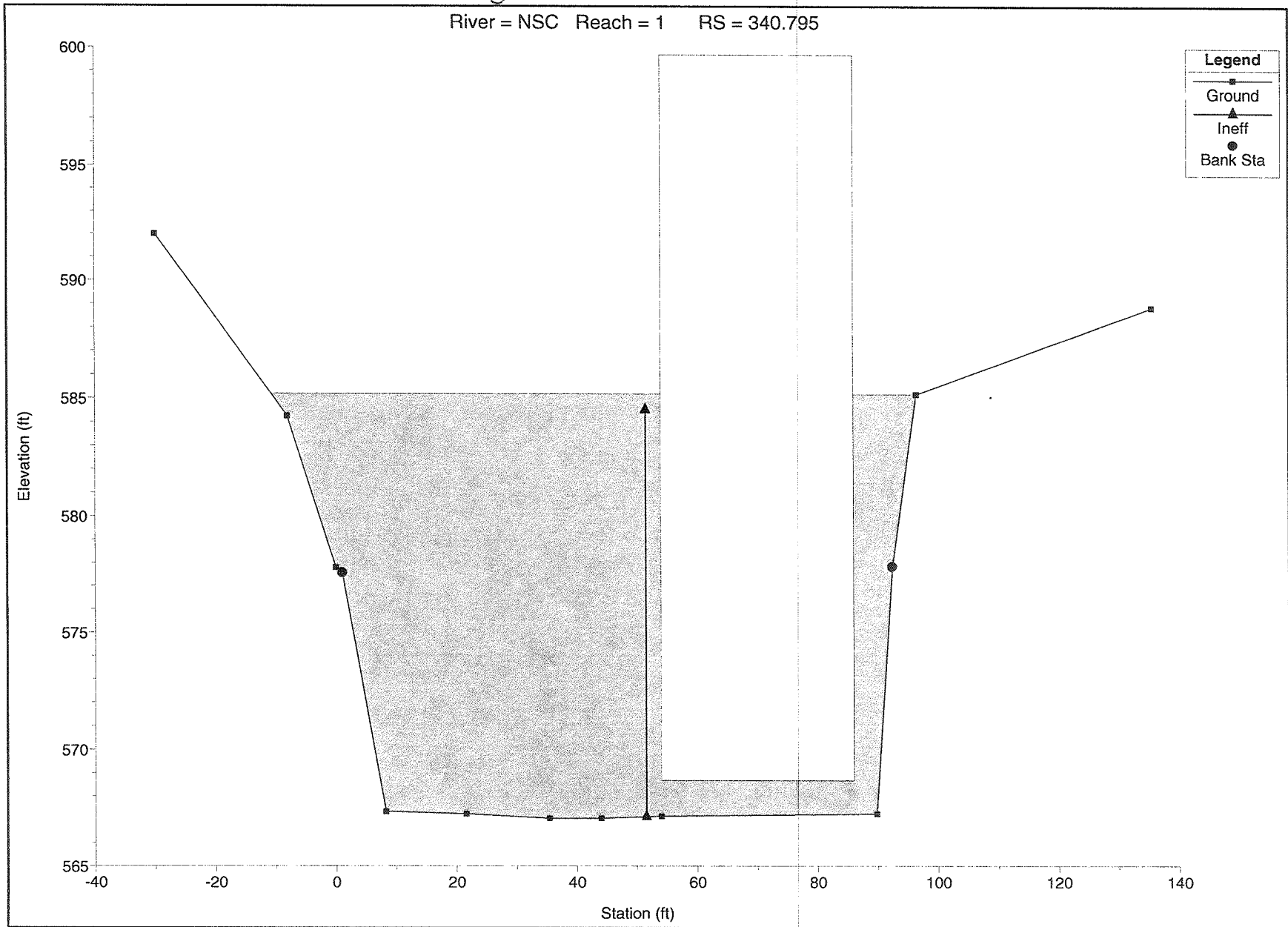

# 100 year outlet results for Wilmette Lock

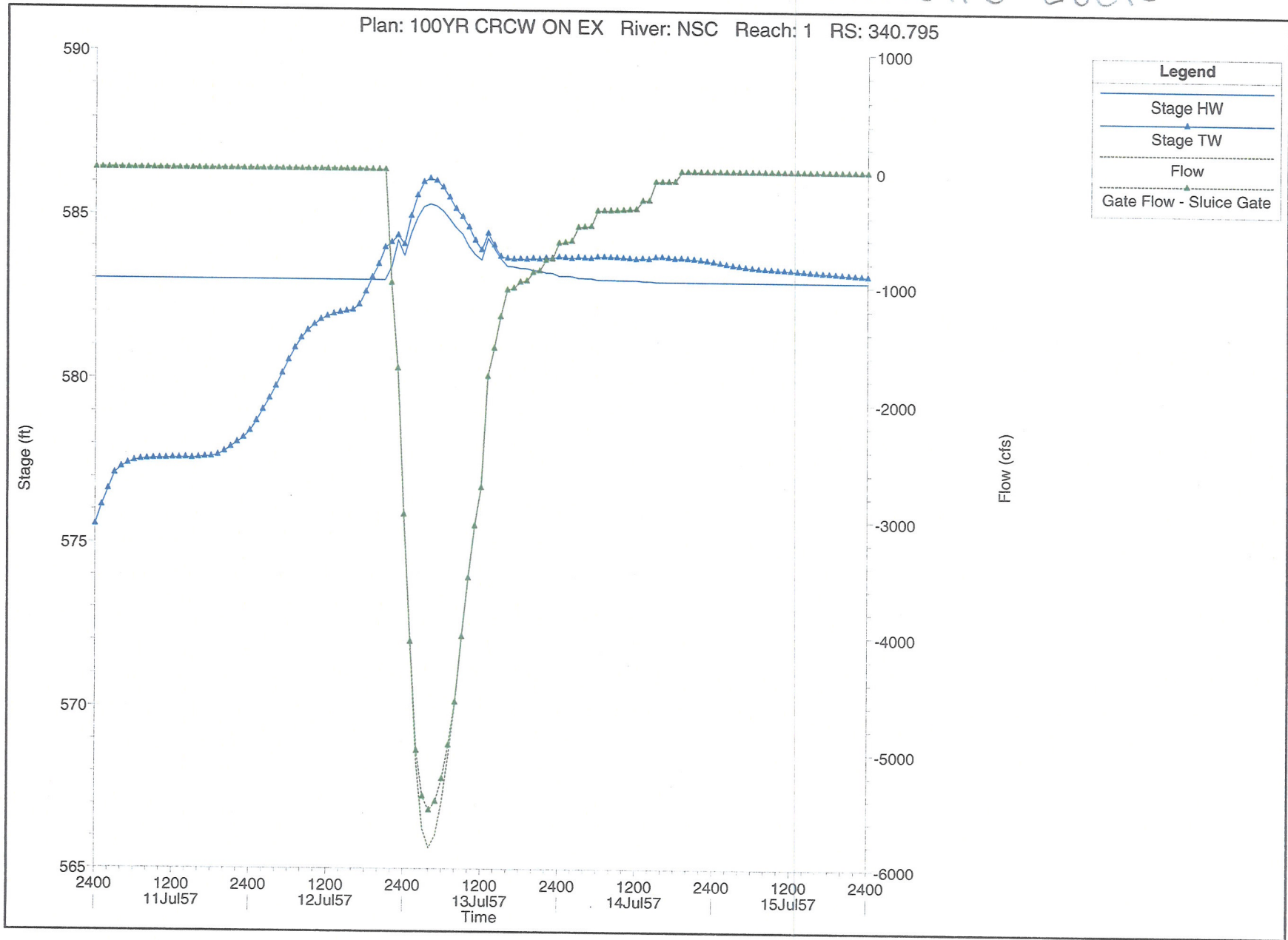

# Chicago River Controlling Works Lock (crew)

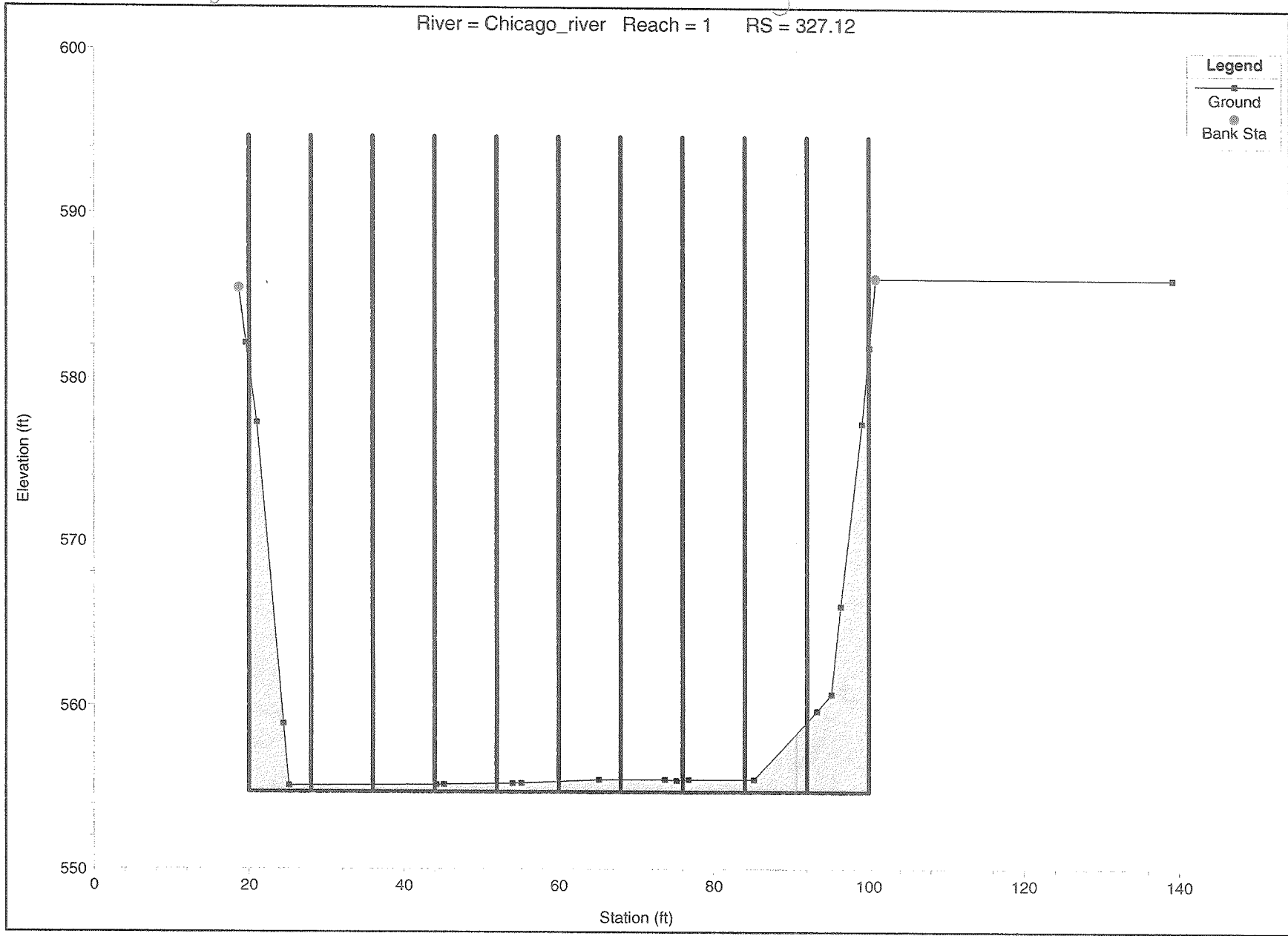

100 year outlet results for CRCW Lock

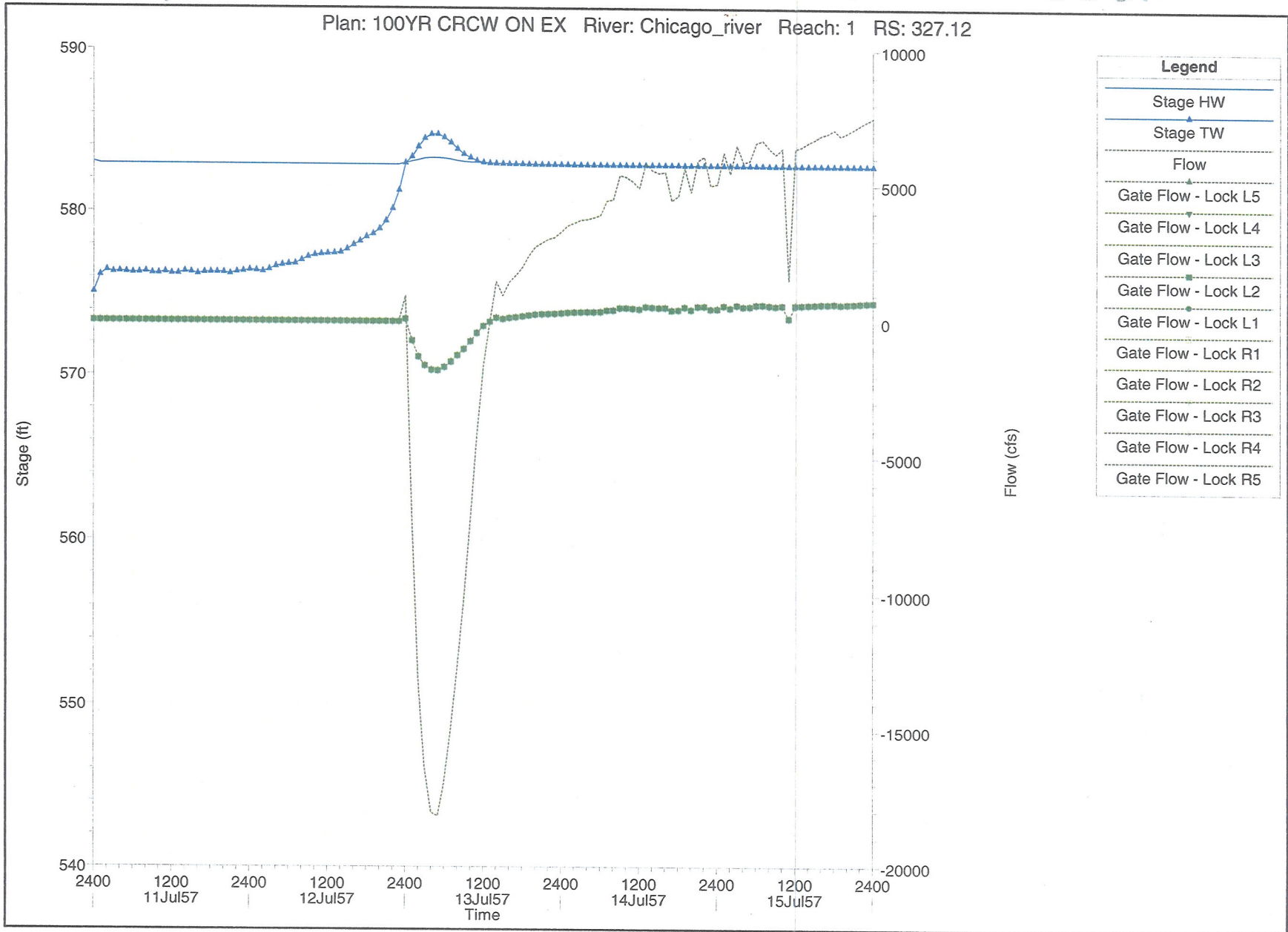



# Calumet River representative x-section 1

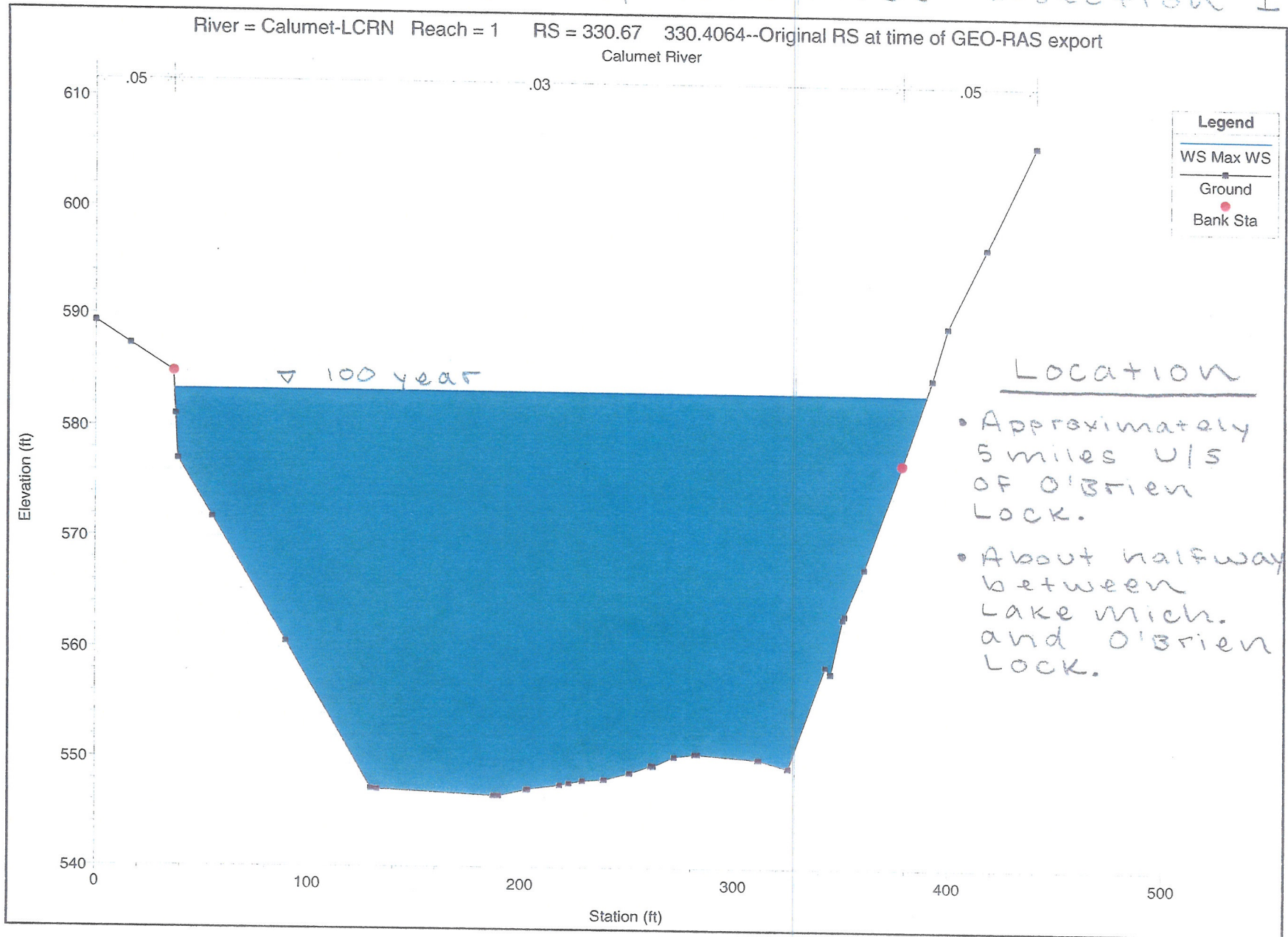

# Calumet rep x-section 1 rating curve

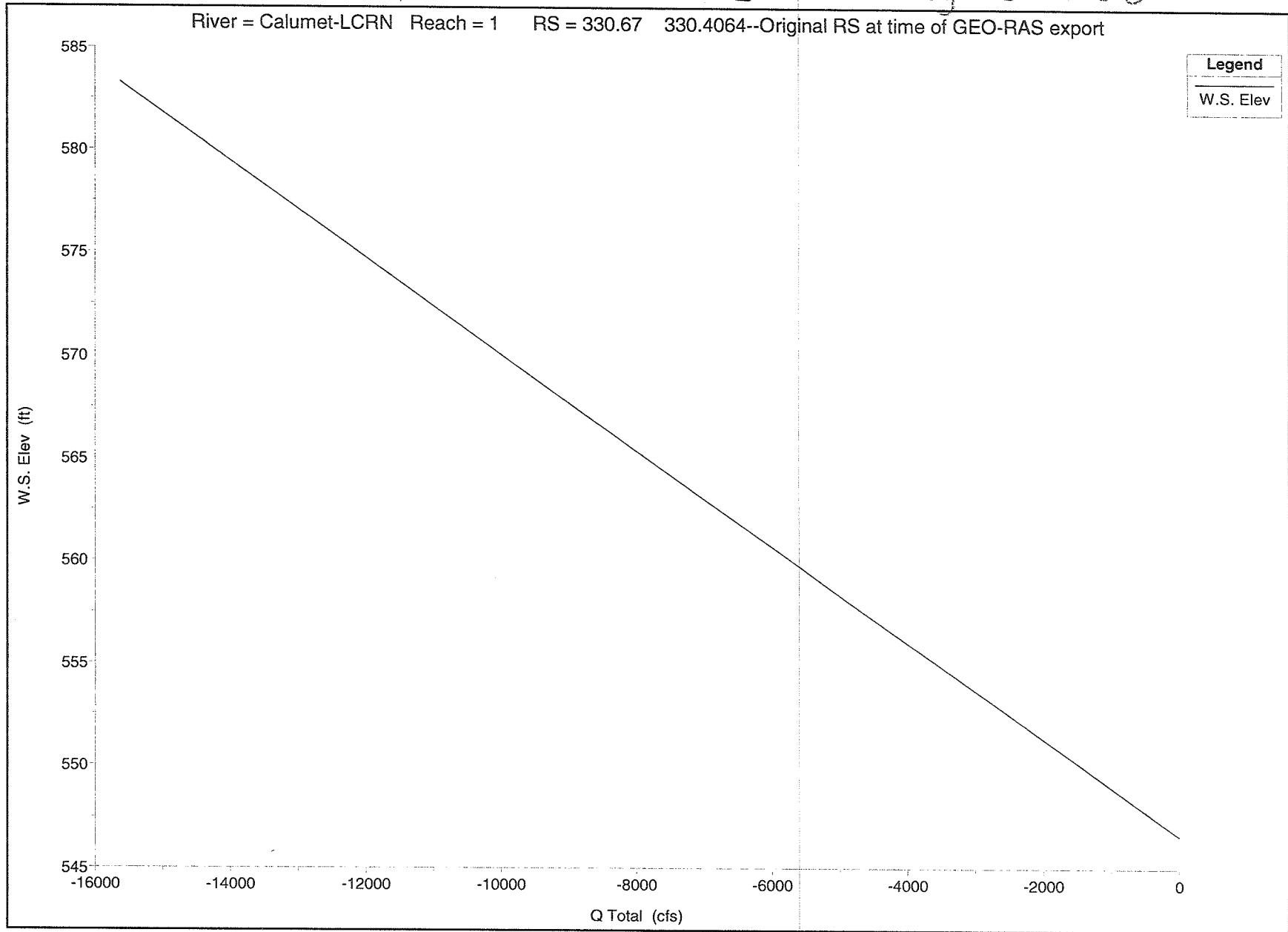



# Calumet River Representative x-section 2

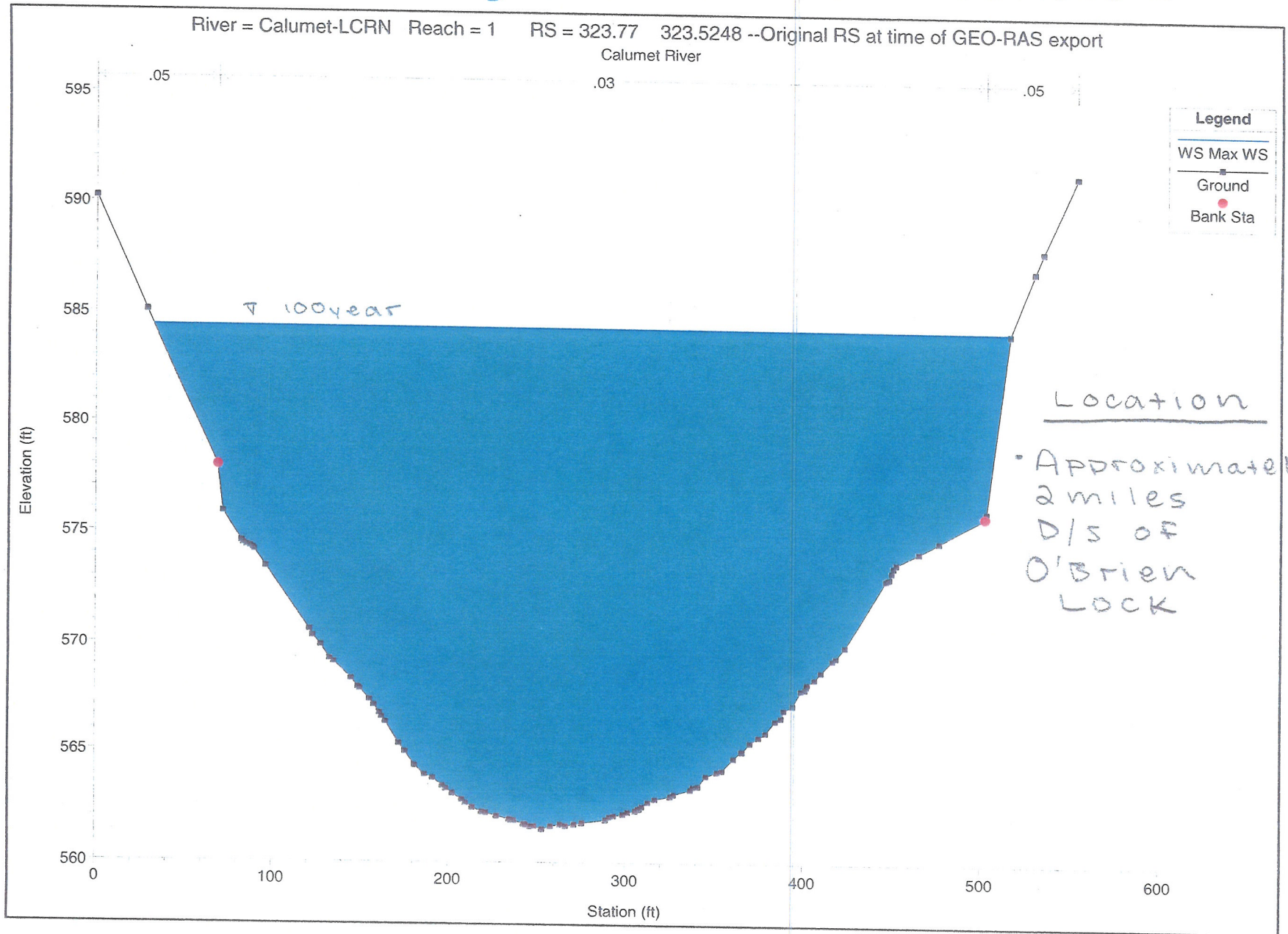

Calumet rep x-section 2 rating curve

River = Calumet-LCRN Reach = 1 RS = 323.77 323.5248 --Original RS at time of GEO-RAS export

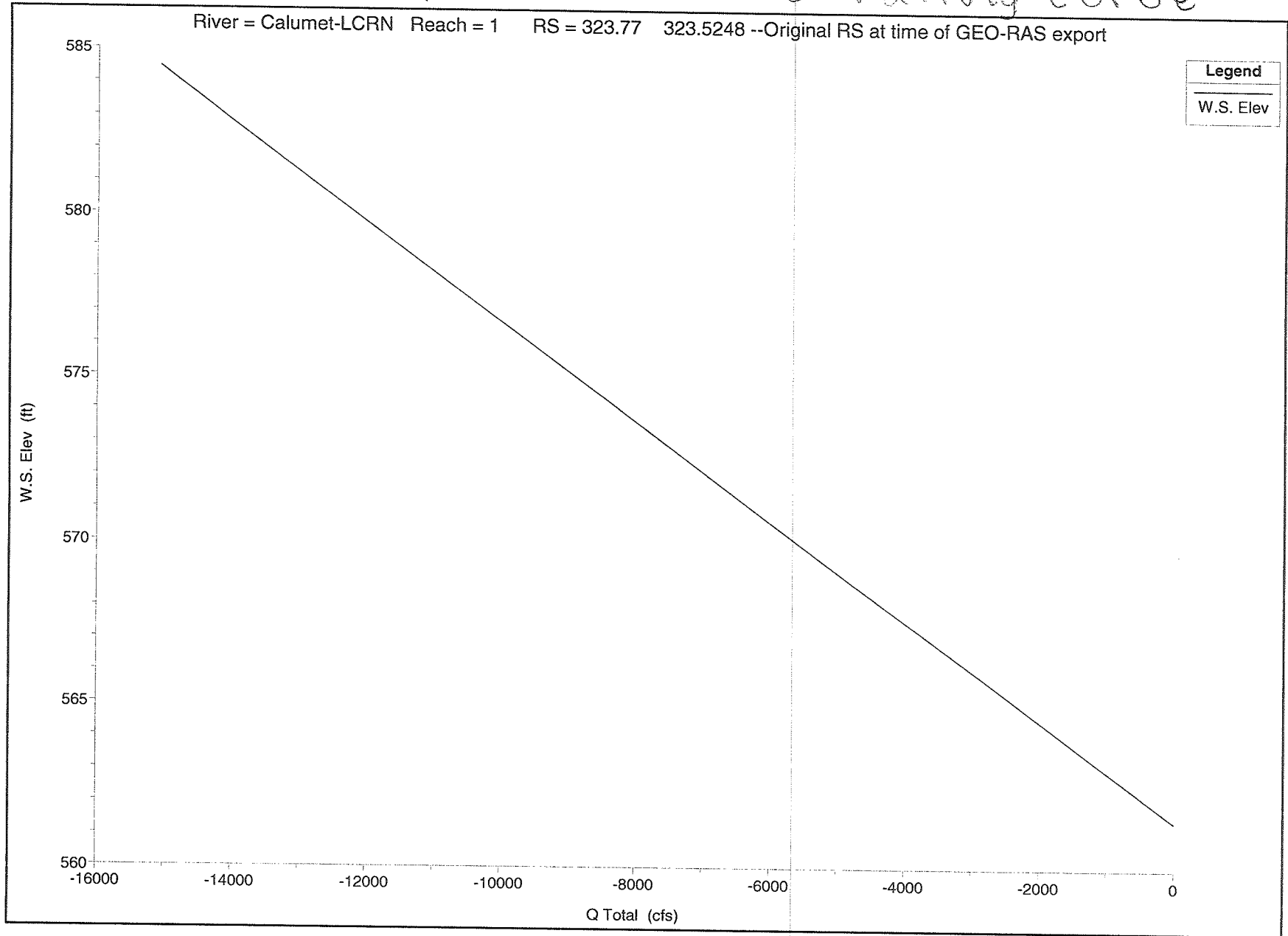

Chicago Sanitary & Ship Canal <sup>(CSSC)</sup> rep. x-section 1

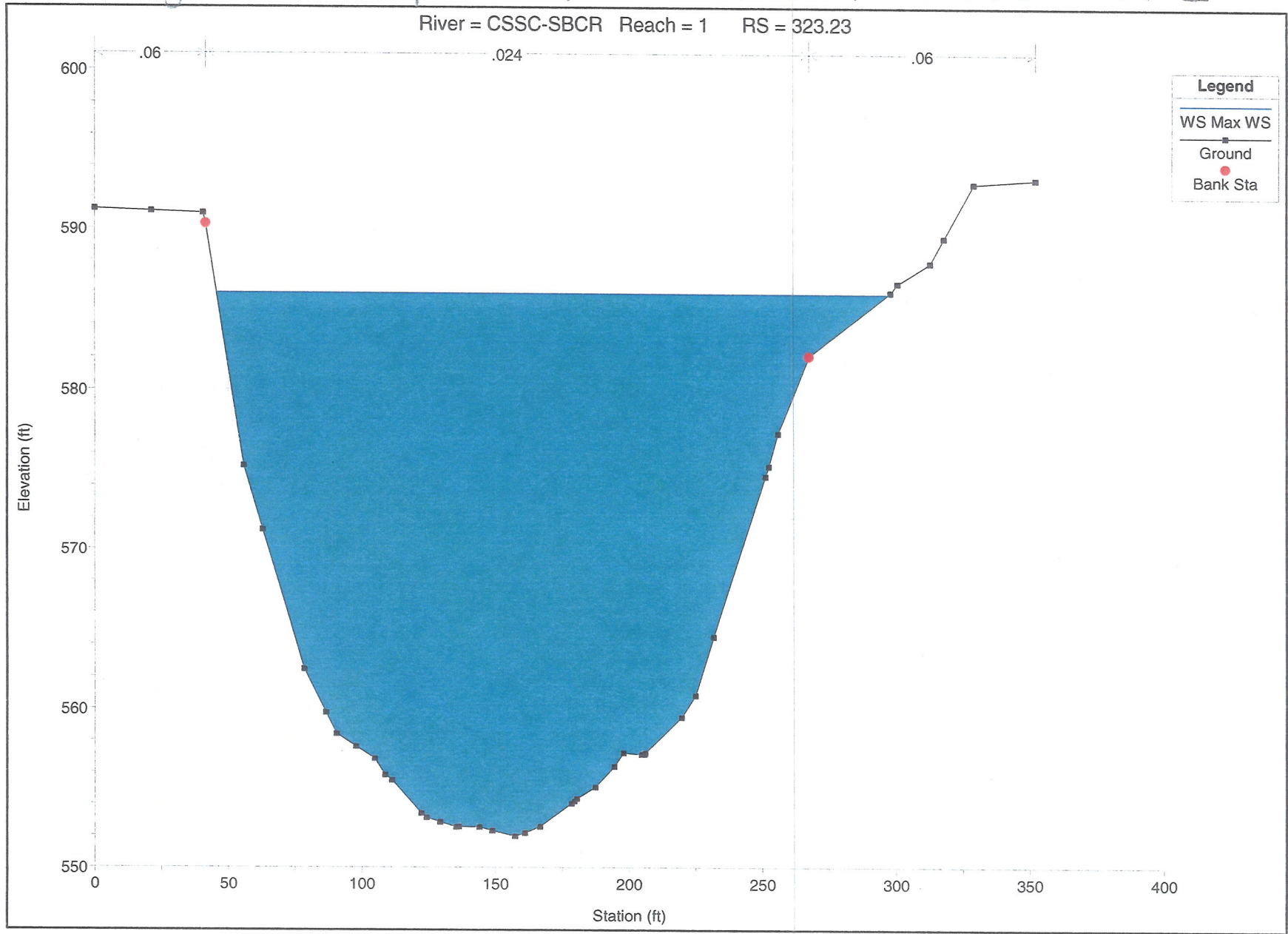

# CSSC rep x-section 1 rating curve

River = CSSC-SBCR Reach = 1 RS = 323.23

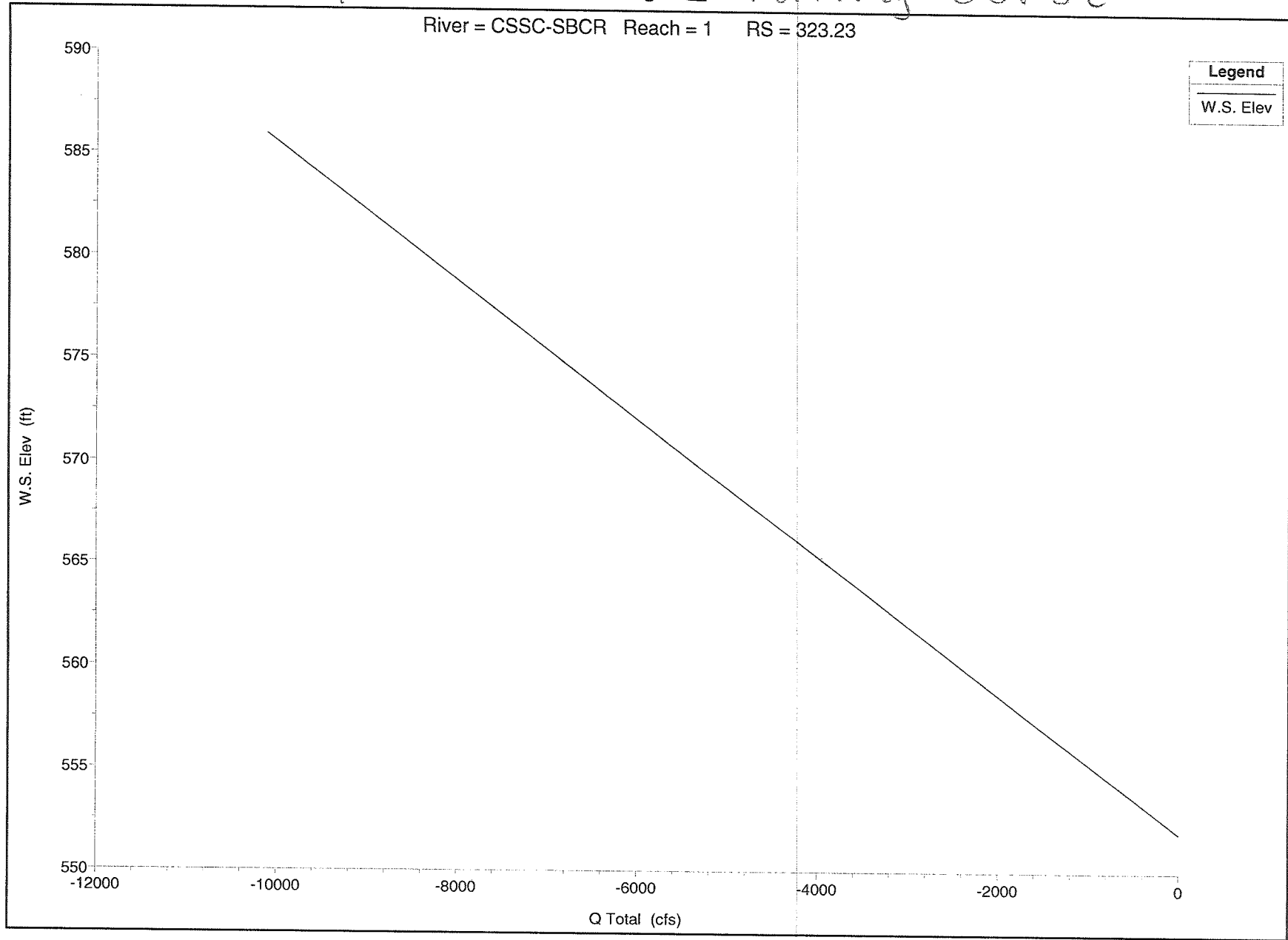

CSSC rep. x-section 2

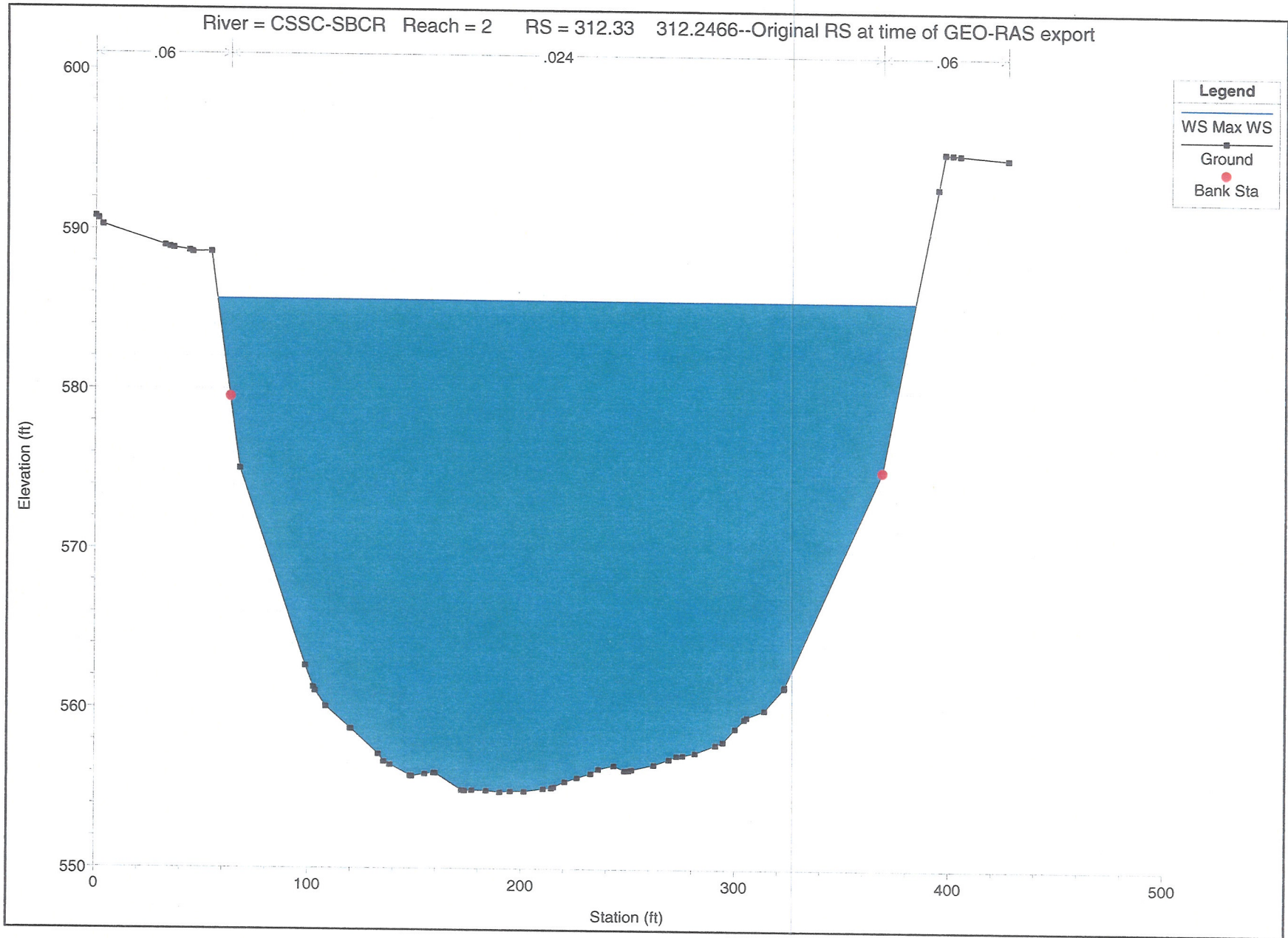



# CSSC rep x-section 2 rating curve

River = CSSC-SBCR Reach = 2 RS = 312.33 312.2466--Original RS at time of GEO-RAS export

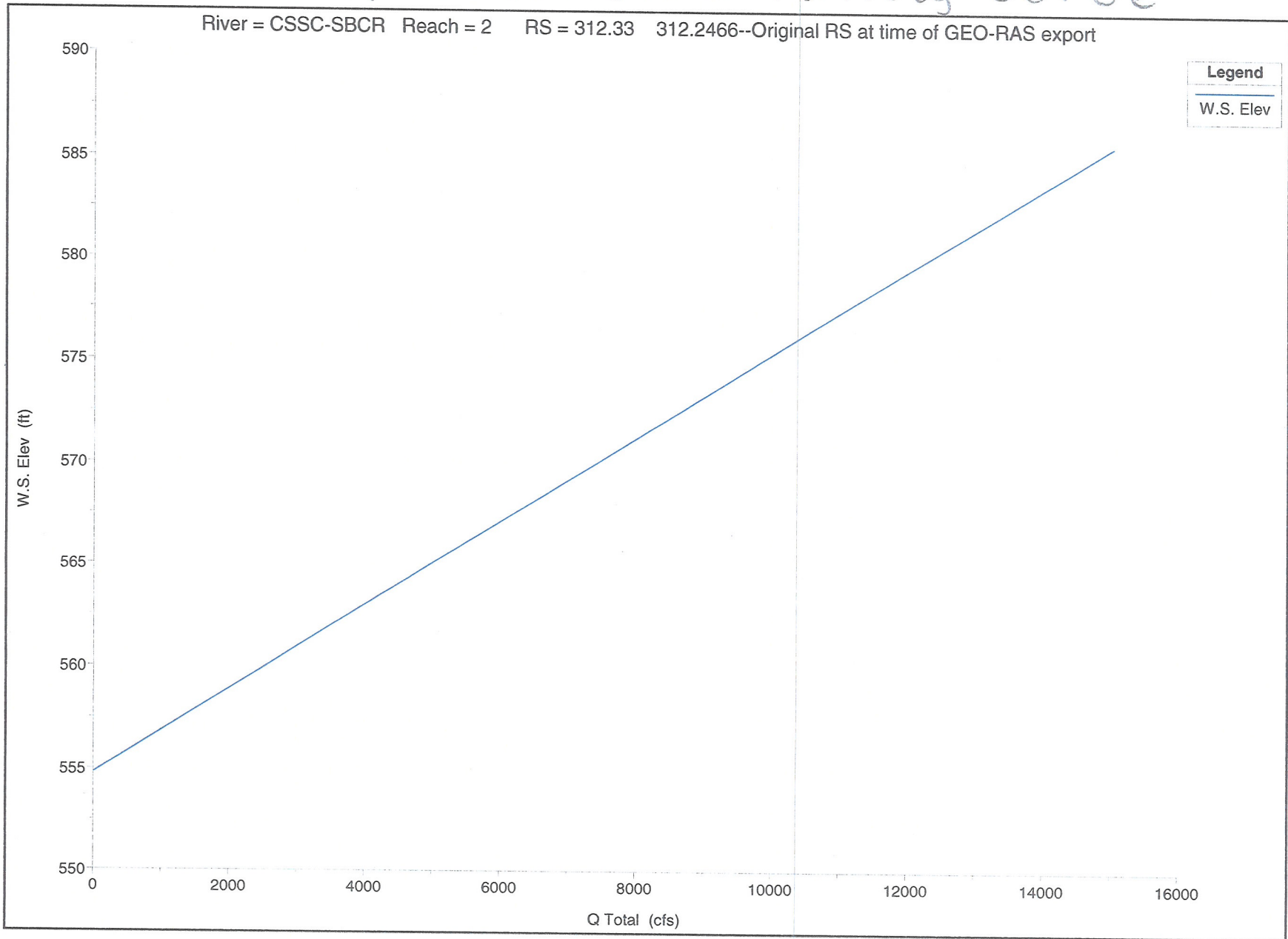

# Calumet River representative x-section 1

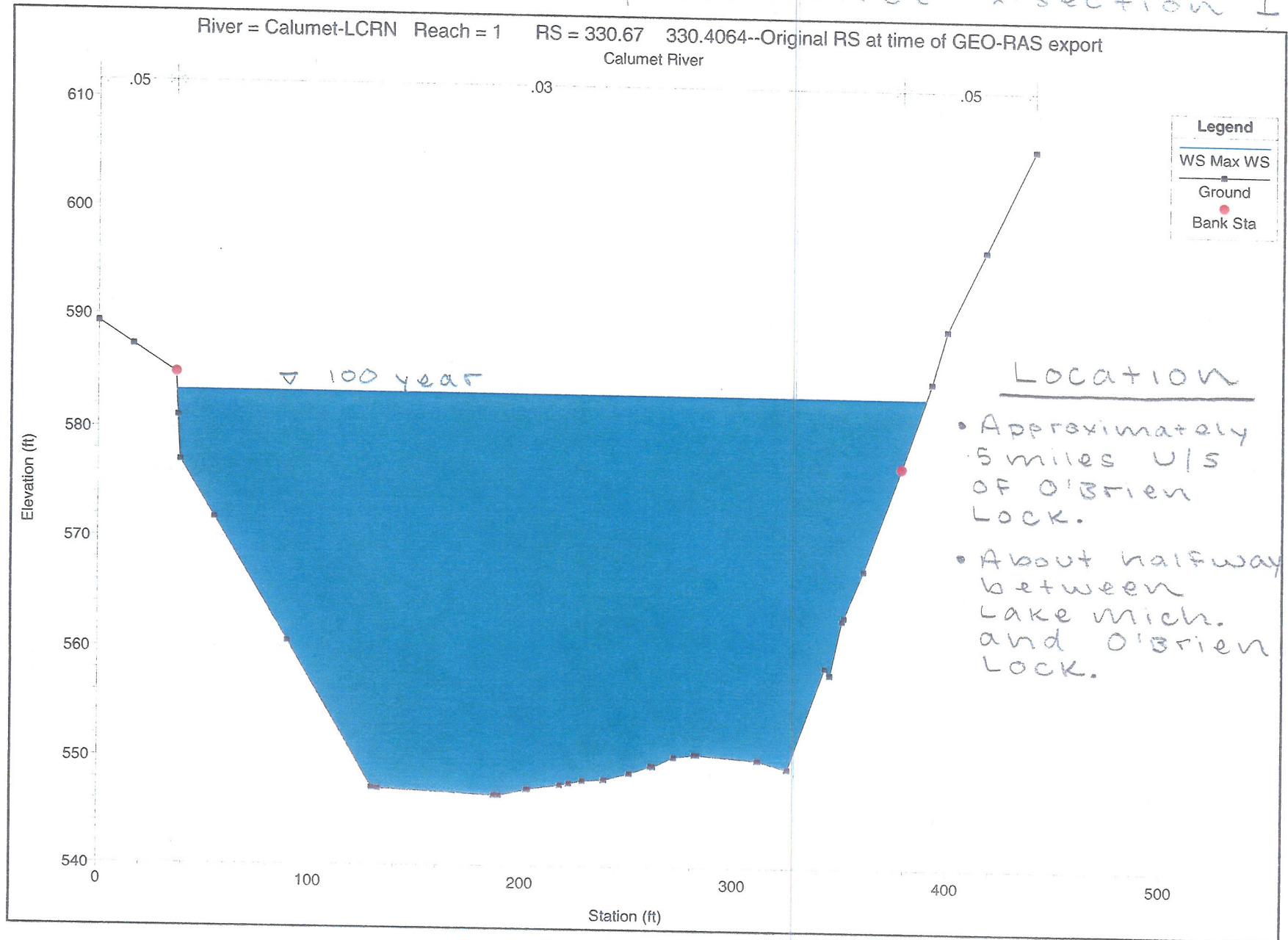

# Calumet River Representative x-section 2

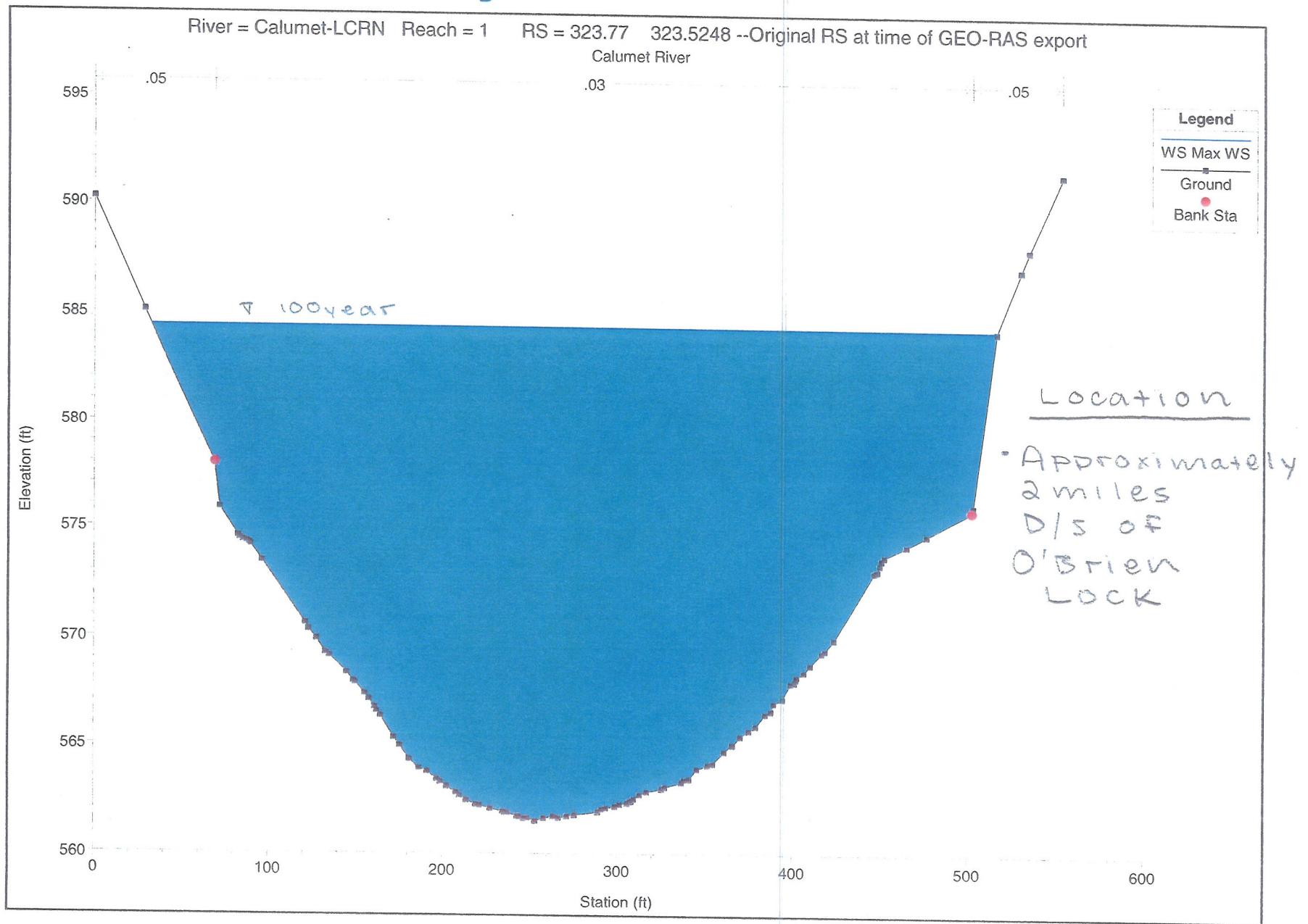



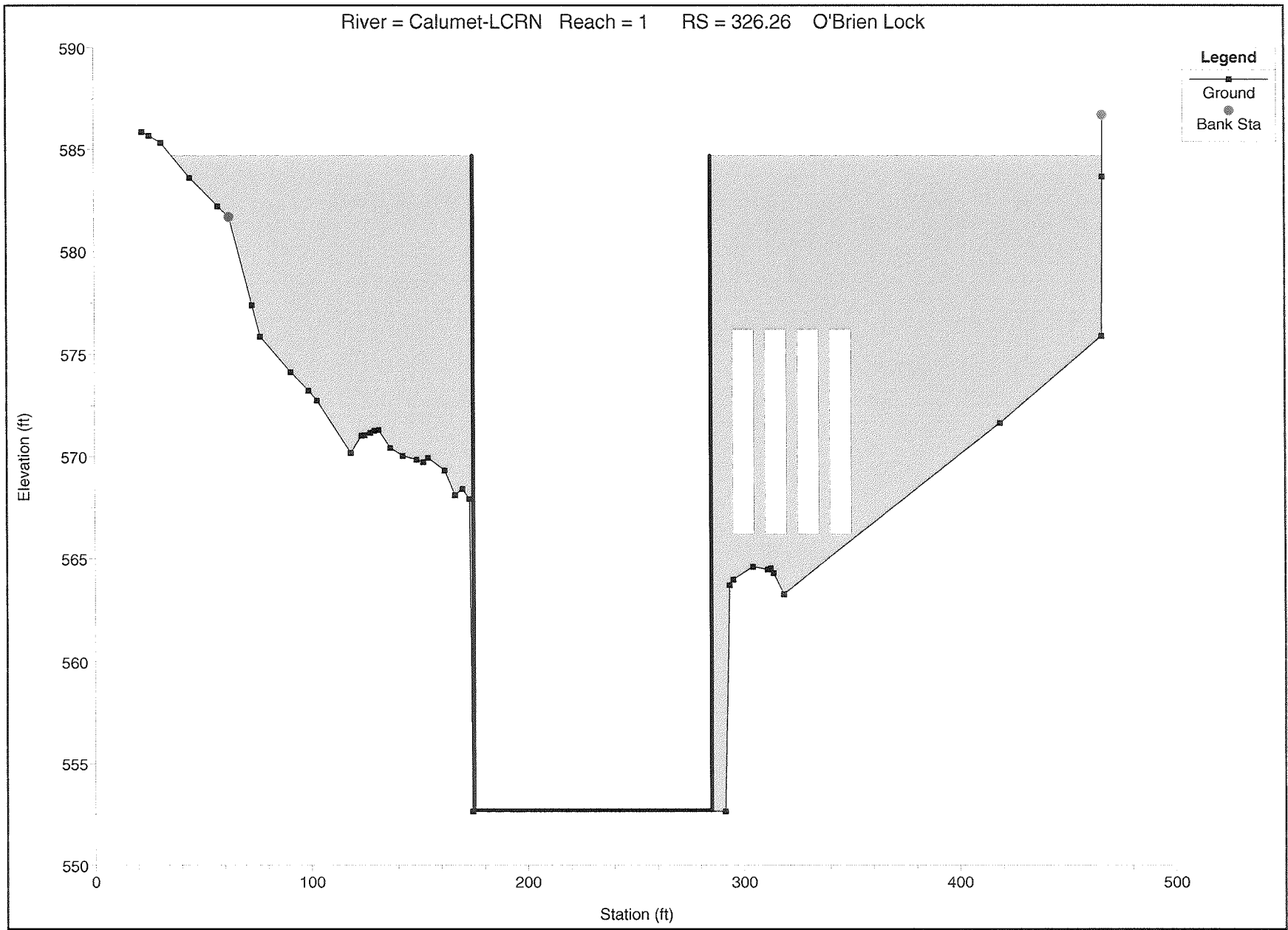

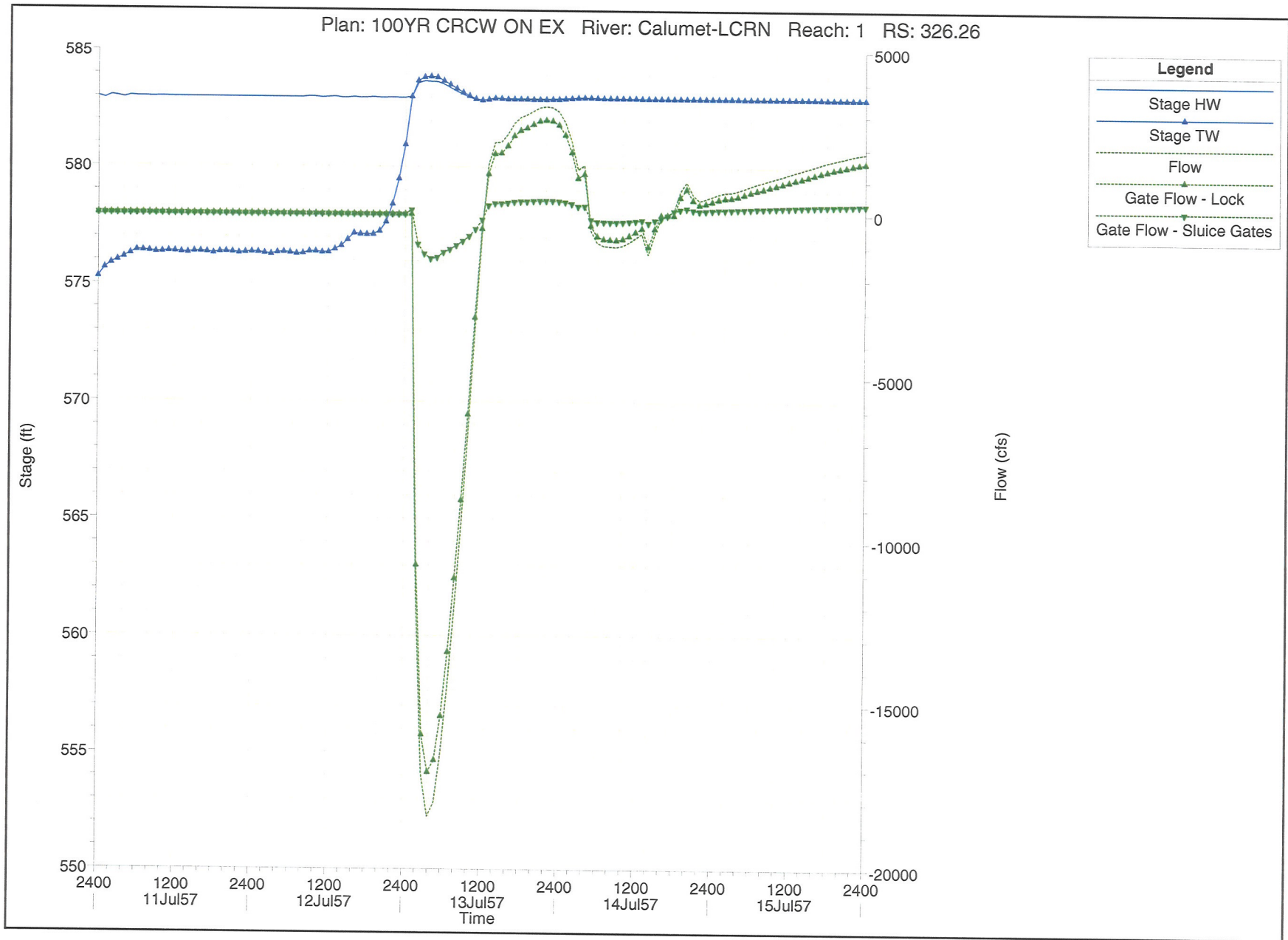



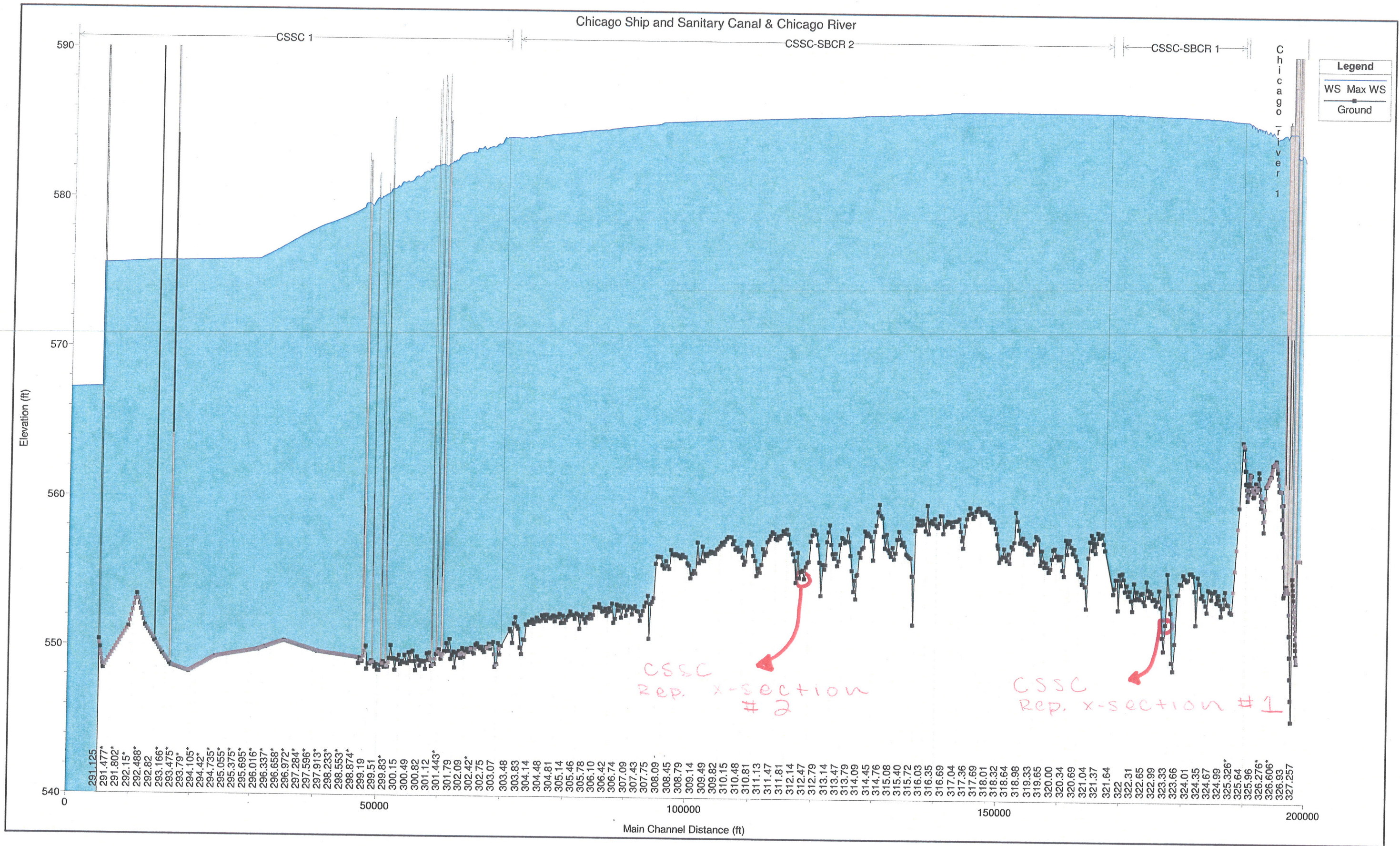



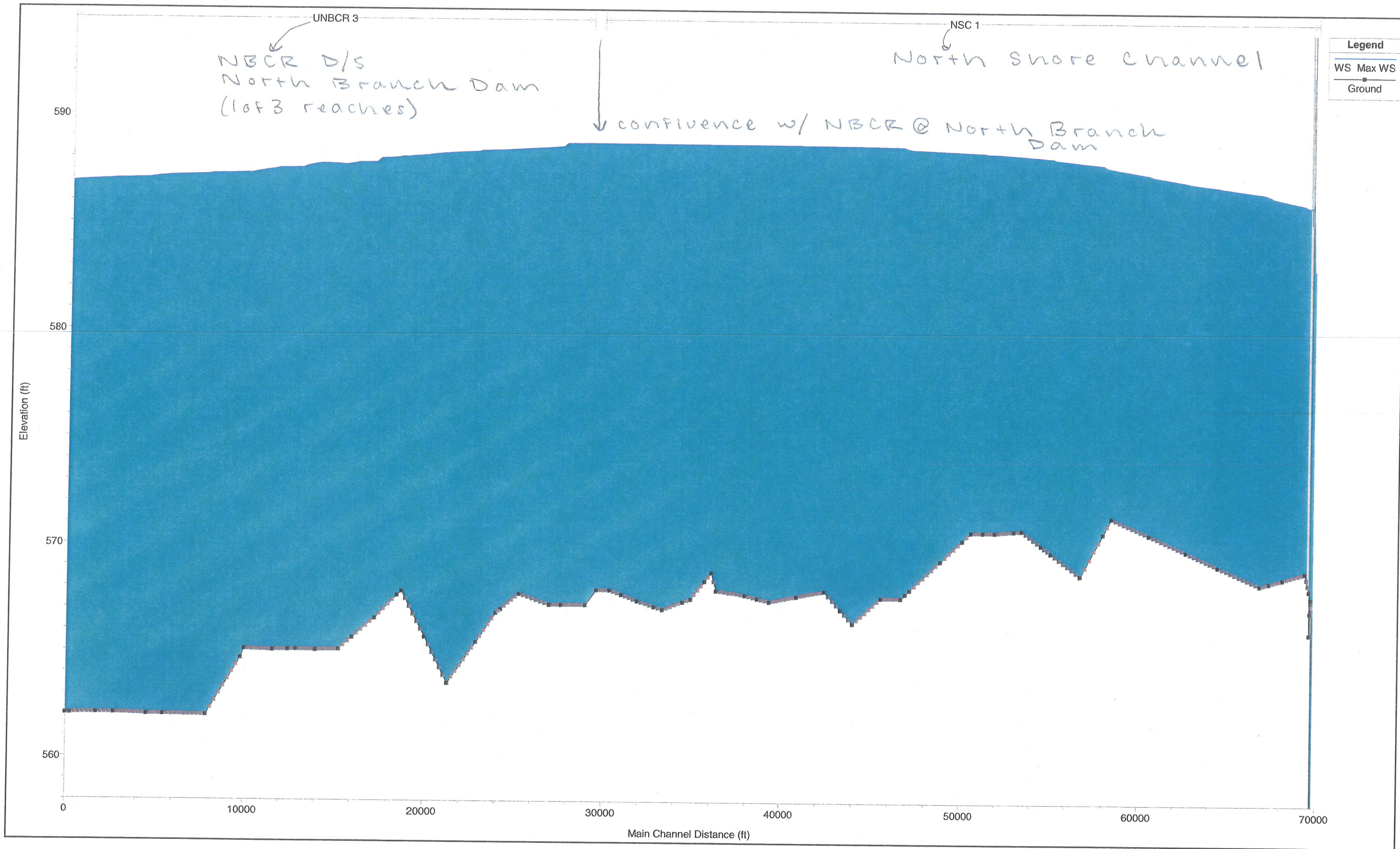



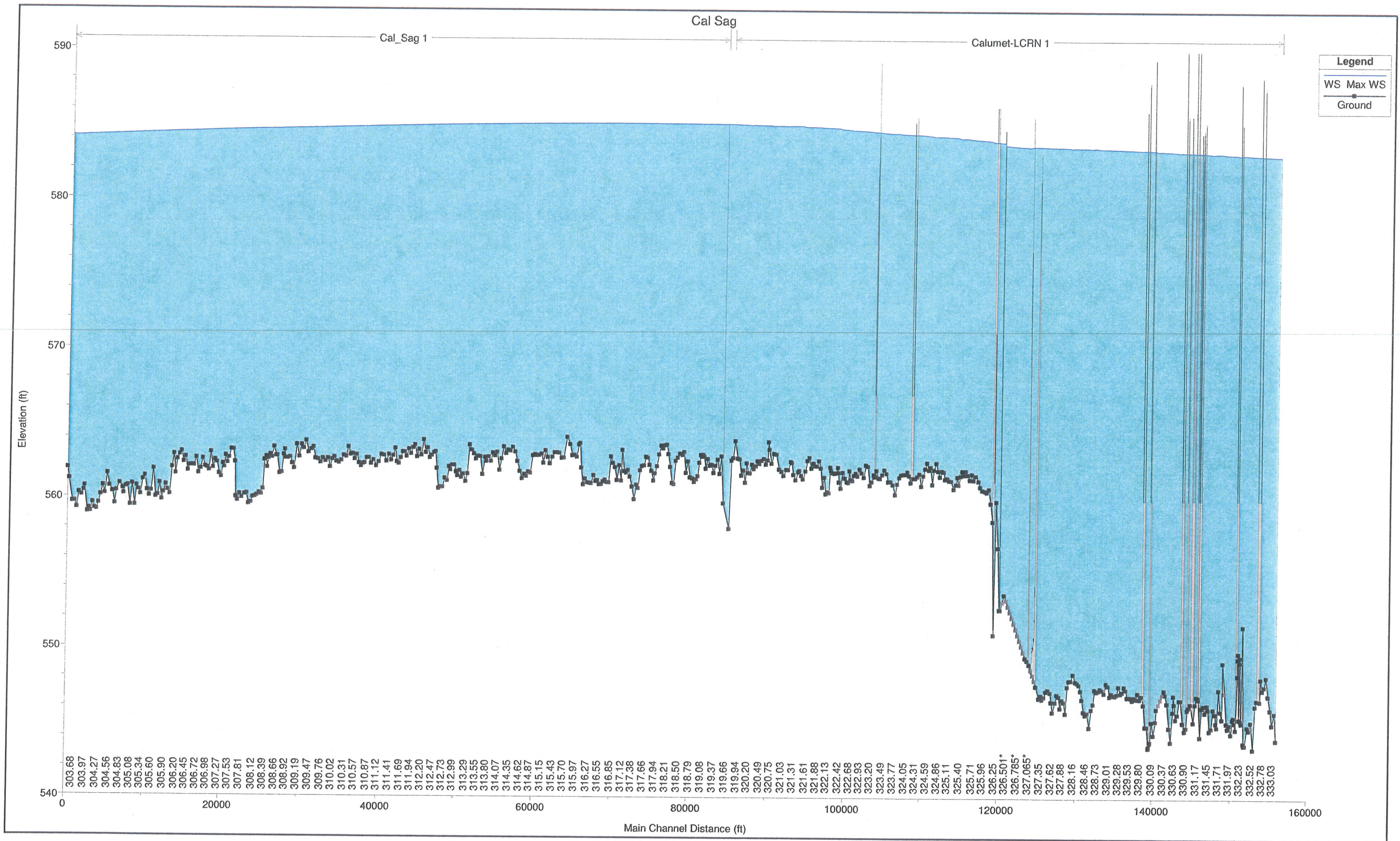



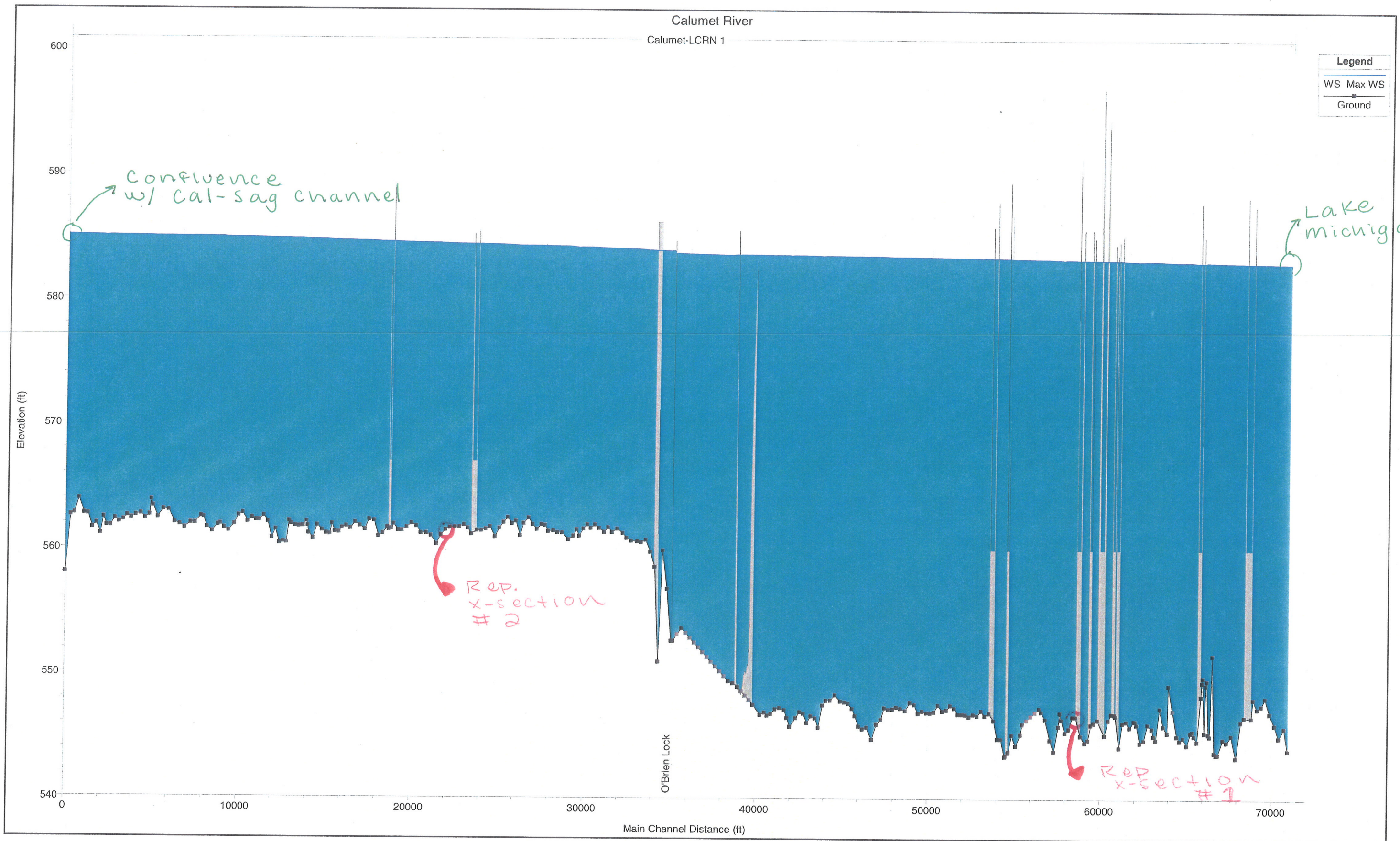

# Stage-Duration Curve for Lake Michigan from 1918 to 2009

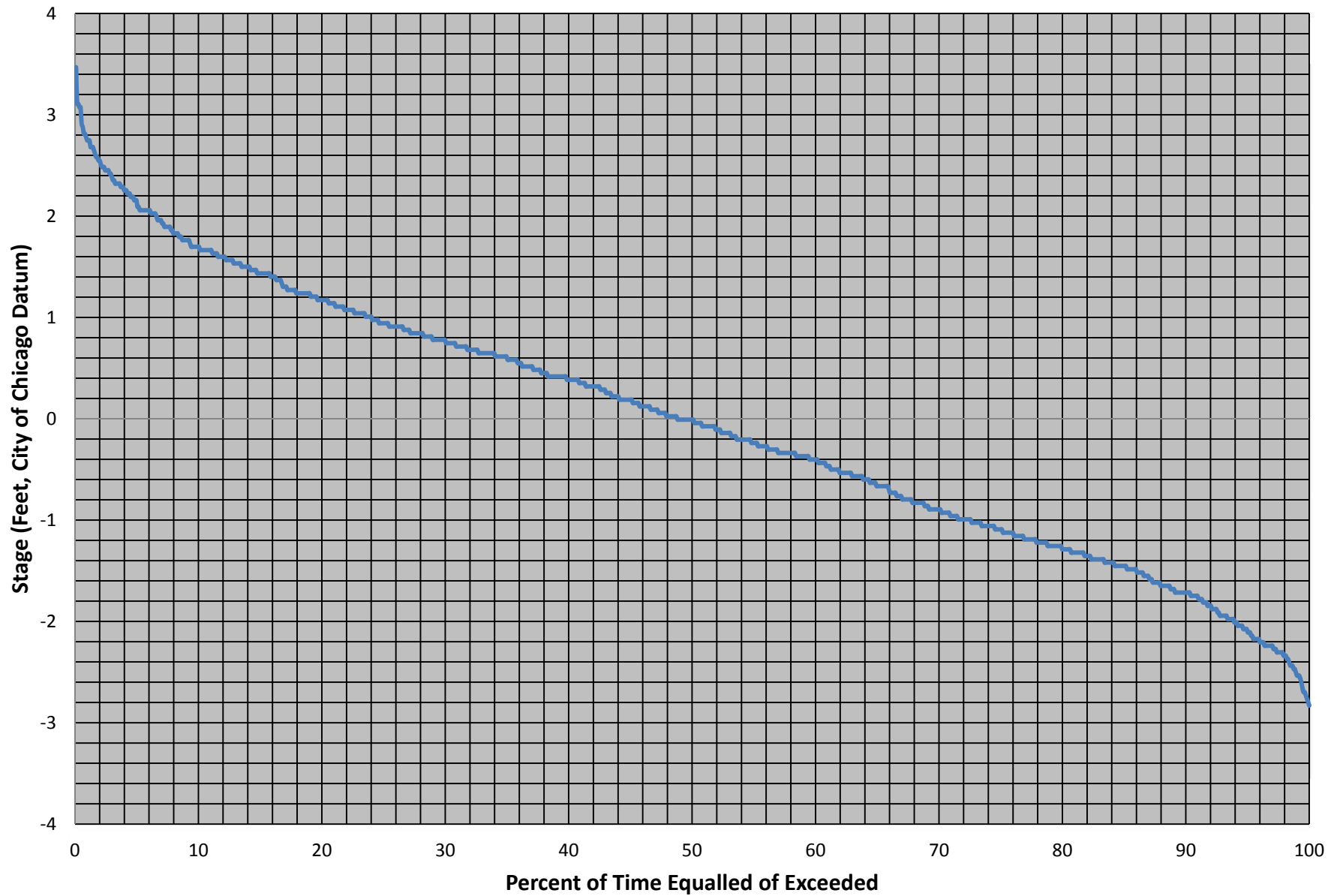



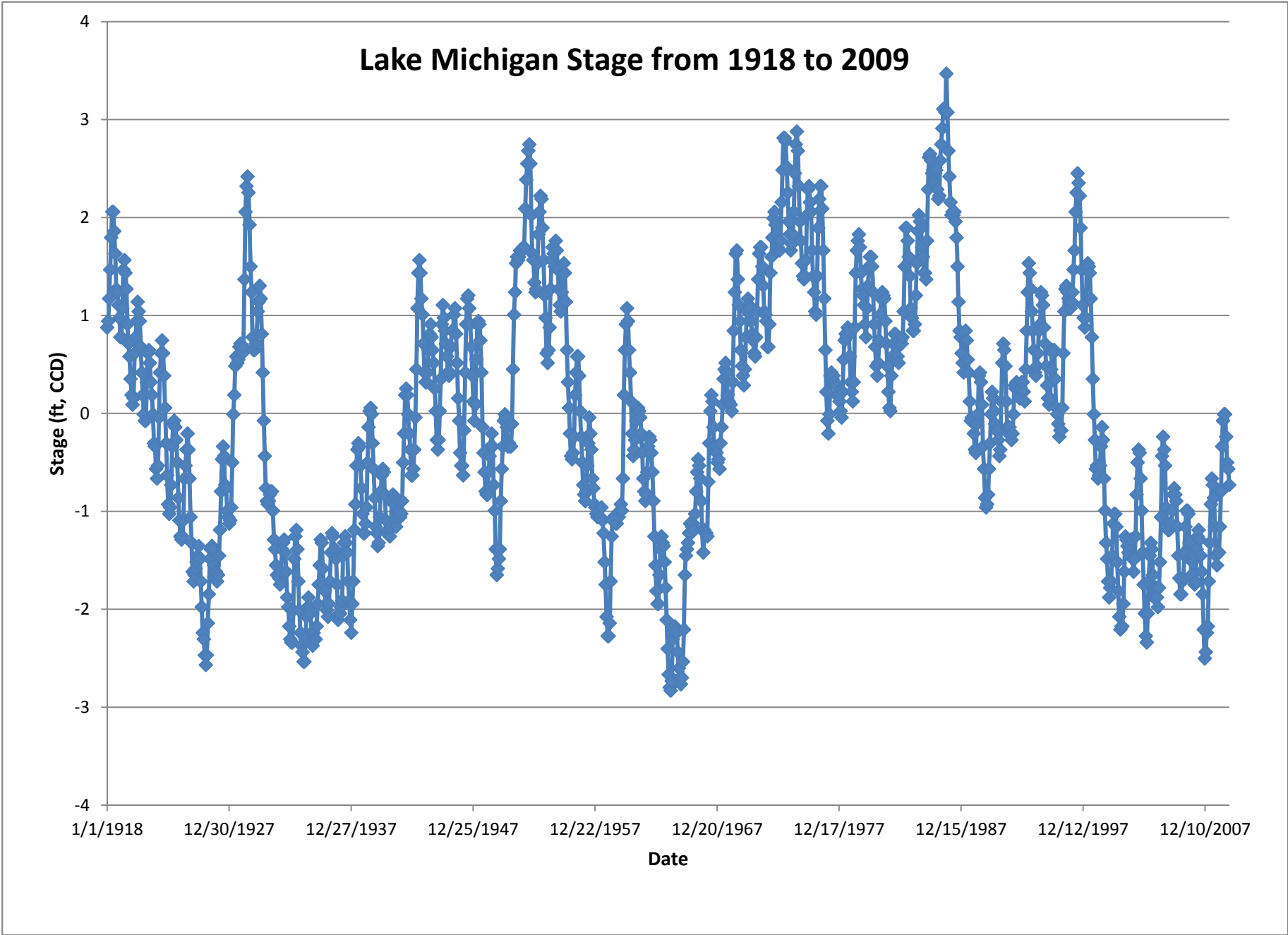



**A4. WASTEWATER IMPROVEMENTS TECHNICAL MEMO**



# Wastewater Improvements for Detailed Evaluation of Alternatives

## Purpose of Study

*Envisioning a Chicago Area Waterway System for the 21<sup>st</sup> Century* is a feasibility study authorized by the Great Lakes Commission and Great Lakes Cities Initiative (GLC/CI). The purpose of the GLC/CI study is to evaluate one aspect of AIS intervention between the Mississippi River System and the Great Lakes System: physical and ecological separation of the CAWS from Lake Michigan via a physical barrier(s). Separation of the CAWS would effectively cut off the exchange of water between Lake Michigan and the CAWS, thereby limiting the risk for transfer of AIS between the Great Lakes and Mississippi River Systems.

## Background Information

MWRDGC operates seven wastewater treatment plants (WWTPs). Three of these plants—the North Side, Calumet, and Stickney plants—discharge to the CAWS and therefore are potentially affected, in varying degrees, by the proposed physical barriers in the CAWS. These proposed barriers would separate the Mississippi River System, to which the WWTPs currently discharge, from the Great Lakes System. Characteristics of each of these plants are identified in Table 1 and Table 2 below. These three facilities are well run, produce excellent-quality effluent, and have met their permit requirements for many years.

**Table 1. Background Information on Three MWRDGC WWTPs**

Parameter	North Side WWTP	Calumet WWTP	Stickney WWTP
Design Average Flow (MGD)	330	350	1,200
Daily Maximum Flow (MGD)	450	430	1,440
Liquid Treatment Process	<ul style="list-style-type: none"><li>• Preliminary: Screening and grit removal</li><li>• Primary: Settling using primary clarifiers</li><li>• Secondary: Activated sludge process with nitrification and final clarifiers</li></ul>	<ul style="list-style-type: none"><li>• Preliminary: Screening and grit removal</li><li>• Primary: Settling using primary clarifiers</li><li>• Secondary: Activated sludge process with nitrification and final clarifiers</li></ul>	<ul style="list-style-type: none"><li>• Preliminary: Screening and grit removal</li><li>• Primary: Settling using Imhoff tanks and primary clarifiers</li><li>• Secondary: Activated sludge process with nitrification and final clarifiers</li></ul>
Solids Treatment Process	None; pumped to Stickney	<ul style="list-style-type: none"><li>• Thickening, anaerobic digestion, lagoon storage, air drying</li><li>• Various land application options</li></ul>	<ul style="list-style-type: none"><li>• Thickening, anaerobic digestion, lagoon storage, air drying</li><li>• Various land application options</li></ul>

# Wastewater Improvements for Detailed Evaluation of Alternatives

**Table 2. Selected NPDES Permit and Plant Performance Information  
for Three MWRDGC WWTPs**

WWTP – Permit Number	Monthly Average	Weekly Average	Daily Maximum	2010 Effluent <sup>a</sup>		
				Mean	Maximum	Minimum
<b>North Side – Permit IL0028088</b>						
CBOD <sup>b</sup> (mg/L)	10	12		<2	11	<2
TSS <sup>c</sup> (mg/L)	12	18		5	18	2
Ammonia – N (mg/L)						
Apr–Oct	2.5		5	<0.3 <sup>d</sup>	2.2 <sup>d</sup>	<0.1 <sup>d</sup>
Nov–Mar	4		8			
Total – P (mg/L)	No Limit			1.4	2.3	0.4
NO <sub>2</sub> – N (mg/L)	No Limit			<0.2	1.3	<0
NO <sub>3</sub> – N (mg/L)	No Limit			8.9	11.7	3.7
Fecal Coliform (count/100 mL)	No Limit			GM <sup>e</sup> : 7,986	80,000	2,700
<b>Calumet – Permit IL0028061</b>						
CBOD (mg/L)	10	20		<3	8	<2
TSS (mg/L)	15	25		6	13	2
Ammonia – N (mg/L)						
Apr–Oct	2.5		5	<0.3	2.4	<0.2
Nov–Mar	4.0		8			
Cyanide (mg/L)	0.15		0.3	<0.006	<0.005	0.014
Total - P	No Limit			3.8	9.7	1.0
NO <sub>2</sub> + NO <sub>3</sub> – N (mg/L)	No Limit			8.3	17.0	3.3
Fecal Coliform (count/100 mL)	No Limit			GM: 6,304	24,000	1,600
<b>Stickney – Permit IL0028053</b>						
CBOD (mg/L)	10	15		<3	10	<2
TSS (mg/L)	12	20		<5	12	<4
Ammonia – N (mg/L)						
Apr–Oct	2.4		5	<0.6	3.6	<0.1
Nov–Mar	4.0		8			
DO <sup>f</sup> , Minimum (mg/L)			6 (minimum)	8.3	10.3	6.4
Total – P (mg/L)	No Limit			1.3	3.4	0.2
NO <sub>2</sub> – N (mg/L)	No Limit			<0.3	2.1	<0
NO <sub>3</sub> – N (mg/L)	No Limit			8.6	16.3	3.3
Fecal Coliform (count/100 mL)	No Limit			GM: 7,363	86,000	1,400

Notes:

<sup>a</sup> Based on daily average data published by MWRDGC. See link below for data.

[www.mwrd.org/iri/portal/anonymouse?NavigationTarget=navurl://14d6b38927bee2ff03c32994983903f0](http://www.mwrd.org/iri/portal/anonymouse?NavigationTarget=navurl://14d6b38927bee2ff03c32994983903f0)

<sup>b</sup> Carbonaceous biochemical oxygen demand

<sup>c</sup> Total suspended solids

<sup>d</sup> Annual ammonia data from plant effluent are not seasonal. Typical of all ammonia plant effluent data in this table.

<sup>e</sup> Geometric mean

<sup>f</sup> Dissolved oxygen

# Wastewater Improvements for Detailed Evaluation of Alternatives

Figure 1 shows the CAWS and WWTP locations discussed above.

Figure 1. Location of WWTPs

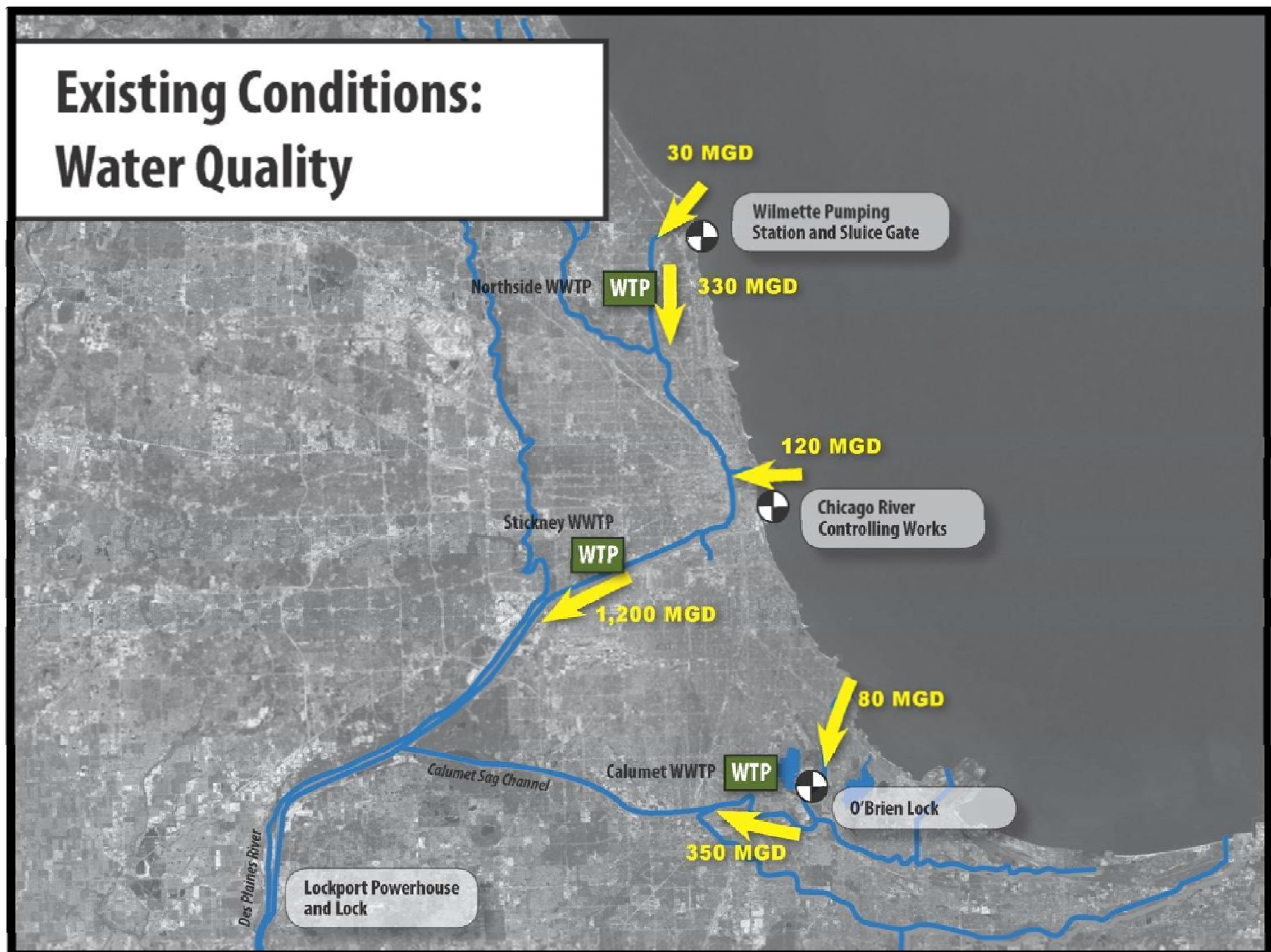

## Barrier Locations and Impacts on WWTP Discharges

Three alternatives were developed to highlight the issues and challenges for a better understanding of the CAWS separation. These alternatives are a Down River Alternative consisting of a single barrier, shown in Figure 2; a Mid-System Alternative consisting of four barriers, shown in Figure 3; and a Near Lake Alternative consisting of five barriers, shown in Figure 4.

Figure 2. Down River Alternative

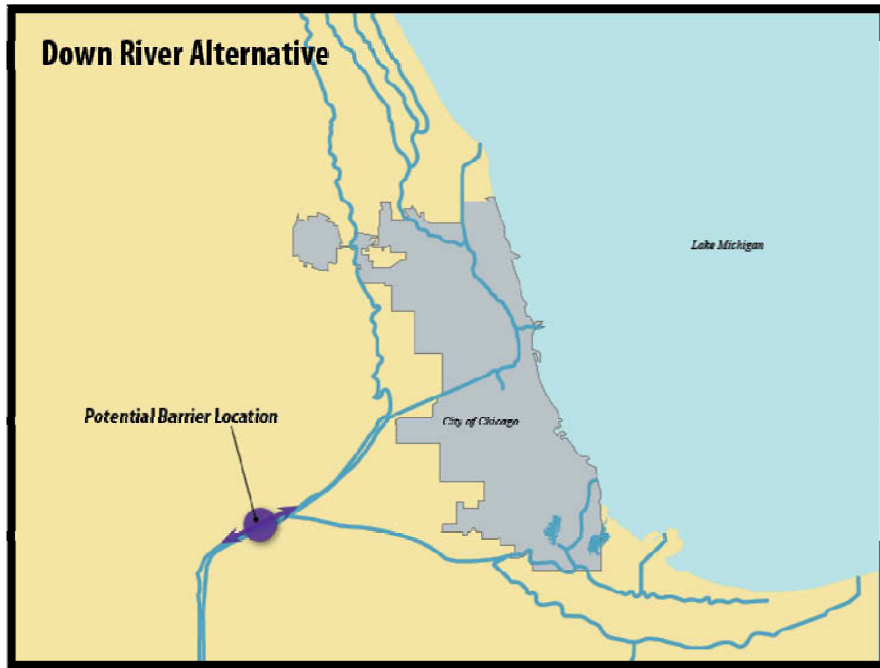
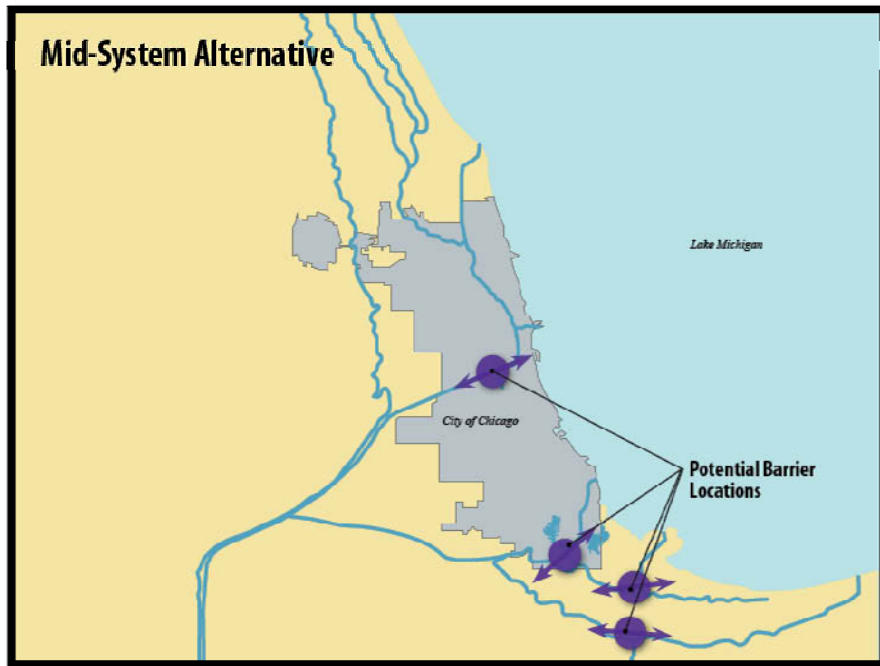
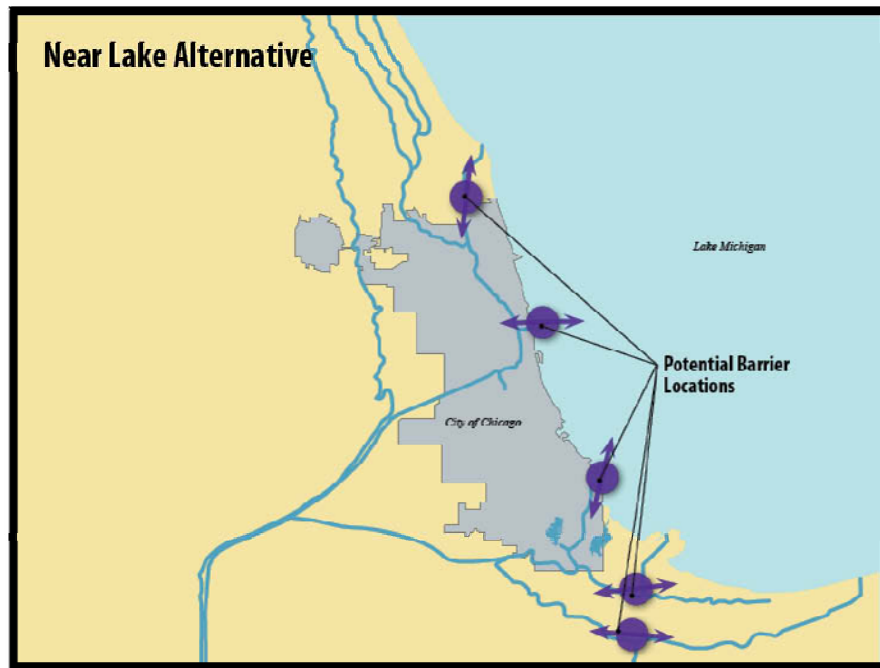

Figure 3. Mid-System Alternative



**Figure 4. Near Lake Alternative**



The proposed physical barriers would change the final discharge location for the WWTPs depending on the barrier location. Table 3 summarizes the final discharge location for the three barrier alternatives.

**Table 3. Final Discharge Location for WWTPs Based on Barrier Alternative**

WWTP	Down River	Mid-System	Near Lake
North Side	Great Lakes System	Great Lakes System	Mississippi River System
Calumet	Great Lakes System	Mississippi River System	Mississippi River System
Stickney	Great Lakes System	Mississippi River System	Mississippi River System

The effluent quality requirements for treated effluent discharged to the Great Lakes System are anticipated to be more stringent than that currently expected for treated effluent discharged to the CAWS/Mississippi River System, and therefore the cost of treating wastewater to be discharged to the Great Lakes System is expected to be higher. The effluent standards in both water bodies are likely to become more stringent over the project implementation period (through 2029). Predicting the standards and the timing of those standards is challenging and goes beyond the scope of this study. Overall, this study seeks to establish the potential range of costs and benefits associated with each of these barrier alternatives. Costs for upgraded treatment to meet potential future standards if there is no change to the CAWS (that is, the status quo is maintained and no barrier is built) must be compared to the potential costs for upgraded treatment with any of the proposed barriers and subsequently more-stringent effluent quality requirements. This allows for comparison of costs that are attributable to the barrier project, not all future upgrade costs. To accomplish this, the wastewater treatment requirements will be discussed as follows. In all cases for this analysis, it is assumed that there is sufficient social and

# Wastewater Improvements for Detailed Evaluation of Alternatives

---

political will to allow new discharges to the Great Lakes and that the anti-degradation process could influence but not stop the process.

- **Nutrients:** Potential regulatory requirements that can be met with currently practiced wastewater treatment technologies. It is anticipated that, within the project period, nutrient removal of some kind will be required, whether the effluent is discharged to the Great Lakes System or the Mississippi River System. The Great Lakes discharges will likely require more-stringent phosphorus removal.
- **Emerging:** Potential regulatory requirements that would require alternate methods of control and/or monitoring including the following:
  - **Monitoring Requirements:** Constituents that are not currently regulated, but might be regulated in the future, will require additional monitoring.
  - **Coincidental Removal:** As treatment technologies advance to remove nutrients and other more-conventional pollutants, there will be enhanced removal of certain emerging constituents as a result.
  - **Source Control:** In certain cases, the most reasonable form of control is removing the constituents from the wastewater stream at the source using pretreatment programs, product bans, and other best management practices.
  - **Advanced Treatment:** If source control and coincidental removal does not control the contaminant to acceptable levels, additional advanced treatment processes (for example, reverse osmosis or advanced oxidation) could be required.

Table 5 was compiled in order to understand the treatment process train selection for nutrient control. Regardless of discharge location (Mississippi River or Lake Michigan), the treatment process trains for similar effluent quality targets will be similar. The difference lies in whether the treatment objective is designed to meet the moderate or stringent nutrient objectives listed in Table 4.

Nitrogen is the governing parameter for selecting processes for moderate or stringent treatment objectives. Treatment process flow sheets were developed for the North Side WWTP and Calumet/Stickney WWTPs for the moderate and stringent treatment objectives and are presented in Attachment Figures A1 to A4 on pages 15 and 16.



# Wastewater Improvements for Detailed Evaluation of Alternatives

Based on the available information, the following potential permit limit scenarios are assumed as shown in Table 4.

**Table 4. Potential Range of Future Regulatory Requirements**

Parameter	Great Lakes System		Mississippi River System		
	Stringent	Moderate	Stringent	Moderate	Current
CBOD (mg/L)	4 <sup>a</sup>	4 <sup>a</sup>	10	10	10
TSS (mg/L)	5 <sup>a</sup>	5 <sup>a</sup>	12	12	12
Ammonia N (mg/L)					
Apr–Oct	0.2 <sup>b</sup>	1.5 <sup>c</sup>	0.2 <sup>b</sup>	1.5 <sup>c</sup>	2.5
Nov–Mar	0.8 <sup>b</sup>	4 <sup>c</sup>	0.8 <sup>b</sup>	4 <sup>c</sup>	4
Total – P (mg/L)	0.1 <sup>d</sup>	0.1 to 1 <sup>e</sup>	0.5 to 1 <sup>e</sup>	1 <sup>e</sup>	—
Total – N (mg/L)	3 <sup>d</sup>	6 <sup>f</sup>	3 <sup>d</sup>	6 <sup>e</sup>	—
Bacteria (ct/100 mL)	126 <sup>g</sup>	126 <sup>g</sup>	200 <sup>h</sup>	400 <sup>i</sup>	—
Mercury (ng/L)	1.3 <sup>j</sup>	12 <sup>k</sup>	12 <sup>k</sup>	—	500 <sup>l</sup>
Other BCC <sup>m</sup> and Emerging Contaminants	Advanced Treatment/Monitoring/Coincidental Treatment / Source Control	Monitoring/Coincidental Treatment / Source Control	Monitoring/Coincidental Treatment / Source Control	Monitoring	—

Notes:

<sup>a</sup> Current Lake Michigan basin effluent standards.

<sup>b</sup> Assuming toxicity to freshwater mollusks is the basis for revised federal ammonia criteria (about 20% of moderate values).

<sup>c</sup> Effluent limits based on current Lake Michigan basin tributary water quality standard for un-ionized ammonia.

<sup>d</sup> Current practical limit of technology. Treatment includes nitrification/denitrification and biological phosphorus removal via activated sludge, chemical addition, enhanced settling and fermentation, and anaerobic digestion; water quality-based requirements based on targets and ecoregional criteria.

<sup>e</sup> Treatment-based requirement; treatment includes advanced biological phosphorus removal via activated sludge and anaerobic digestion; water

quality-based requirements based on targets and ecoregional criteria.

<sup>f</sup> Current reasonable technology limit. Treatment includes advanced nitrification/denitrification via activated sludge and anaerobic digestion; water quality-based requirements based on targets and ecoregional criteria.

<sup>g</sup> *E. coli* (ambient Lake Michigan water quality standard).

<sup>h</sup> Fecal – Current ambient water quality standard for General Use Water.

<sup>i</sup> Current Illinois effluent standard.

<sup>j</sup> Current Lake Michigan ambient water quality standard.

<sup>k</sup> Current water quality standard for General Use Water.

<sup>l</sup> Current Chicago Waterway System ambient water quality standard.

<sup>m</sup> Bioaccumulative chemicals of concern.

## Wastewater Improvements for Detailed Evaluation of Alternatives

**Table 5. Wastewater Treatment Processes Selected to Meet Moderate and Stringent Nutrient Treatment Objectives**

Process	P Limit of Technology (mg P/L)	N Limit of Technology (mg N/L)	River Discharge		Great Lakes Discharge		Comment
			Moderate	Stringent	Moderate	Stringent	
5-Stage Bardenpho Nutrient Removal Process	0.3–0.5	4–8	X	X	X	X	Meeting 1 mg P/L is possible in an Anaerobic/Anoxic/Oxic (A2O) biological nutrient removal process.
Tertiary Filter for Denitrification with Carbon Source Addition and Phosphorus Removal with Coagulant Addition	0.05	2–3		X	X	X	Denitrifying filter required for N; it has been assumed that both the lowest levels of total nitrogen (TN) and total phosphorus (TP) can be achieved jointly in a tertiary denitrification filter. Tertiary filtration is assumed to reliably meet CBOD/TSS for Great Lakes discharge.
Chemical Coagulant Addition			X	X	X	X	Assumed necessary to achieve stringent effluent phosphorus.
Supplemental Carbon Addition			X	X	X	X	Assumed necessary to achieve stringent effluent nitrogen.
Fermentation	—	—	X	X	X	X	Raw solids fermented to produce a carbon source for biological phosphorus removal and denitrification.
Return Stream Equalization	—	—	—	X	—	X	By equalizing the return flows, the WWTPs have flexibility in returning this large N/P load.

# Wastewater Improvements for Detailed Evaluation of Alternatives

Preliminary planning-level construction cost estimates were developed for incrementally adding new treatment processes to the North Side, Calumet, and Stickney WWTPs to meet either moderate or stringent treatment objectives. These estimates are shown in Table 6. Costs related to emerging contaminants and mercury (source control, monitoring, coincidental treatment, and advanced treatment) are not included in Table 6; see the additional discussion following Table 6.

**Table 6. Preliminary Planning-Level Estimates of Incremental Additional Construction Costs and Additional Chemical and Energy Costs Required to Meet Moderate and Stringent Nutrient Treatment Objectives**

Scenario	Planning-Level Estimated Construction Costs (\$/gpd)	Planning-Level Estimated Chemical and Energy Costs (\$/MG treated)
Moderate River Side Discharges	\$1.90	\$270
Stringent River Side Discharges	\$3.50	\$750
Moderate Lake Side Discharges	\$2.60	\$330
Stringent Lake Side Discharges	\$3.50	\$750

Source: WERF Sustainability Report (Falk, M.W., Neethling, J.B., Reardon, D.J., 2011, Striking the balance between nutrient removal and sustainability, WERF research project NUTR1R06n)

Notes:

- <sup>a</sup> Construction cost estimates do not include allowances for contingencies and for associated costs for engineering, legal, and administrative costs. These would be necessary for total project cost estimates.
- <sup>b</sup> Operations costs include energy and chemicals; no labor, maintenance, or equipment replacement costs are included.
- <sup>c</sup> \$/gpd rounded to nearest \$0.05.
- <sup>d</sup> \$/MG treated rounded to nearest \$10.
- <sup>e</sup> These costs are planning-level estimates. Costs could range from +100% to -50%.
- <sup>f</sup> Breakdown of costs is included in the Attachment Tables A1 and A2.

## Project Construction and Operation (Chemical and Energy) Cost Impacts

The estimated project costs were developed based on the following assumptions:

- The final discharge locations based on the barrier alternatives (Table 3)
- The potential range of regulatory requirements forecasted to govern future effluent limits (Table 4)
- The unit wastewater treatment processes and preliminary planning-level estimated capital and operations costs to meet the potential range of regulatory requirements (Table 5 and Table 6)

The baseline costs—those costs that might occur regardless of any barrier—could vary widely based on the proposed range of regulatory requirements including no changes to the current effluent discharge permit limits within the project period (“no change” option). These baseline costs and the projected

## Wastewater Improvements for Detailed Evaluation of Alternatives

---

future scenarios of no change, moderate, and stringent riverside options at each WWTP are summarized in Table 7. The wastewater treatment cost estimates based on barrier alternative locations and unit processes required to meet the potential regulatory ranges are summarized in Table 8.

To calculate the total project-related costs, the net difference between base scenario costs and the treatment costs were calculated depending on barrier location alternatives. The stringent lake permit costs were assumed for all lakeside discharges based on the anti-degradation process that would be driving permit limits lower. The net project costs for the Down River and Mid-System barrier locations are included in Table 9 (no costs for Near Lake barriers are anticipated).

Project costs in this analysis do not include specific treatment steps for specific constituents such as mercury, bioaccumulative toxics, or other contaminants of emerging concern such as pharmaceuticals and personal-care products. At this time, there are no full-scale treatment processes operating at the size of the Stickney, North Side, and Calumet plants with proven performance to reliably reduce effluent mercury to the proposed stringent level. Typically, publicly owned treatment works (POTWs) can reliably achieve effluent mercury levels in the range of 0.01 µg/L to 0.1 µg/L (10 ng/L to 100 ng/L).

If additional advanced treatment beyond source control or coincidental removal is required to meet permit limits for future regulated contaminants, planning-level costs of \$8.0 billion, \$2.5 billion, and \$2.4 billion for Stickney, North Side, and Calumet, respectively, would need to be used in lieu of the capital costs presented in Table 8 for stringent lakeside discharges. Annual operations costs for advanced treatment would be \$294 million, \$82 million, and \$87 million for Stickney, North Side, and Calumet, respectively. These costs are taken from Mr. Richard Lanyon's presentation Separation of the Great Lakes and Mississippi River Watersheds (Richard Lanyon, Executive Director of MWRDGC, 2010). Cost data presented by Richard Lanyon, formerly of the MWRDGC, is based on microfiltration, reverse osmosis, ultraviolet light, and hydrogen peroxide advanced treatment for future regulated contaminants.

## Wastewater Improvements for Detailed Evaluation of Alternatives

**Table 7. Preliminary Baseline Estimates of Wastewater Treatment Construction Costs**

Base Scenarios	Capital Costs (\$)						Operation Costs (\$/Year)			
	Design Average Flow (mgd) ->		Northside	Calumet	Stickney	Total	Northside	Calumet	Stickney	Total
	Capital \$/gpd	Operation \$/MG Treated	330	350	1200		330	350	1200	
No permit changes	\$ -	\$ -	\$ -	\$ -	\$ -	\$ -	\$ -	\$ -	\$ -	\$ -
Moderate riverside discharges	\$ 1.90	\$ 270	\$ 600,000,000	\$ 700,000,000	\$ 2,300,000,000	\$ 3,600,000,000	\$33,000,000	\$34,000,000	\$ 118,000,000	\$ 185,000,000
Stringent riverside discharges	\$ 3.50	\$ 750	\$ 1,200,000,000	\$ 1,200,000,000	\$ 4,200,000,000	\$ 6,600,000,000	\$90,000,000	\$96,000,000	\$ 329,000,000	\$ 515,000,000

**Table 8. Estimated Incremental Construction Cost Estimates Per Barrier Location**

	Capital Costs (\$)						Operation Costs (\$/Year)			
	Design Average Flow (mgd) ->		Northside	Calumet	Stickney	Total	Northside	Calumet	Stickney	Total
	Capital \$/gpd	Operation \$/MG Treated	330	350	1200		330	350	1200	
<b>Down River</b>										
Moderate lakeside discharges	\$ 2.60	\$ 330	\$ 900,000,000	\$ 900,000,000	\$ 3,100,000,000	\$ 4,900,000,000	\$40,000,000	\$42,000,000	\$ 145,000,000	\$ 227,000,000
Stringent lakeside discharges	\$ 3.50	\$ 750	\$ 1,200,000,000	\$ 1,200,000,000	\$ 4,200,000,000	\$ 6,600,000,000	\$90,000,000	\$96,000,000	\$ 329,000,000	\$ 515,000,000
<b>Mid System</b>										
Moderate lakeside discharges	\$ 2.60	\$ 330	\$ 900,000,000	\$ -	\$ -	\$ 900,000,000	\$40,000,000	\$ -	\$ -	\$ 40,000,000
Stringent lakeside discharges	\$ 3.50	\$ 750	\$ 1,200,000,000	\$ -	\$ -	\$ 1,200,000,000	\$90,000,000	\$ -	\$ -	\$ 90,000,000
<b>Near Lake</b>										
Moderate lakeside discharges	\$ 2.60	\$ 330	\$ -	\$ -	\$ -	\$ -	\$ -	\$ -	\$ -	\$ -
Stringent lakeside discharges	\$ 3.50	\$ 750	\$ -	\$ -	\$ -	\$ -	\$ -	\$ -	\$ -	\$ -

## Wastewater Improvements for Detailed Evaluation of Alternatives

**Table 9. Estimated Project Construction Costs**

	Capital Costs (\$)				Operation Costs (\$/Year)				
	Northside	Calumet	Stickney	Total	Northside	Calumet	Stickney	Total	
Design Average Flow (mgd) ->	330	350	1200		330	350	1200		
<b>Project Related Costs Assuming Varying River/Lake Discharge Permit Requirements</b>									
<b>Down River</b>									
Moderate River Permit / Stringent Lake	\$ 600,000,000	\$ 500,000,000	\$ 1,900,000,000	\$ 3,000,000,000	\$ 57,000,000	\$ 62,000,000	\$ 211,000,000	\$ 330,000,000	
Stringent River Permit / Stringent Lake	\$ -	\$ -	\$ -	\$ -	\$ -	\$ -	\$ -	\$ -	
Moderate River Permit / Moderate Lake	\$ 300,000,000	\$ 200,000,000	\$ 800,000,000	\$ 1,300,000,000	\$ 7,000,000	\$ 8,000,000	\$ 27,000,000	\$ 42,000,000	
Stringent River Permit / Moderate Lake	\$ -	\$ -	\$ -	\$ -	\$ -	\$ -	\$ -	\$ -	
<b>Mid System</b>									
Moderate River Permit / Stringent Lake	\$ 600,000,000	\$ -	\$ -	\$ 600,000,000	\$ 57,000,000	\$ -	\$ -	\$ 57,000,000	
Stringent River Permit / Stringent Lake	\$ -	\$ -	\$ -	\$ -	\$ -	\$ -	\$ -	\$ -	
Moderate River Permit / Moderate Lake	\$ 300,000,000	\$ -	\$ -	\$ 300,000,000	\$ 7,000,000	\$ -	\$ -	\$ 7,000,000	
Stringent River Permit / Moderate Lake	\$ -	\$ -	\$ -	\$ -	\$ -	\$ -	\$ -	\$ -	

**Notes:**

Capital Costs Rounded to nearest 100,000,000

Operation Costs Rounded to nearest 10,000,000

# Wastewater Improvements for Detailed Evaluation of Alternatives

## ATTACHMENT

**Table A1. Unit Process Capital Cost Required to Meet Moderate and Stringent Treatment Objectives**

Description	North Side WWTP <sup>a</sup> (\$/gpd)		Calumet/Stickney WWTPs (\$/gpd)		Source
	Moderate	Stringent	Moderate	Stringent	
5-Stage Bardenpho Basins	1.60	1.60	1.60	1.60	Sacramento Regional County Sanitation District (SRCSD) HDR Report at 1.05 for Modified Ludzack-Ettinger (MLE) (Added 50% for Bardenpho)
Return Activated Sludge Pump Station (PS)	0.06	0.06	0.06	0.06	SRCSD
Blowers	0.12	0.12	0.12	0.12	SRCSD
Methanol Feed System	0.02	0.02	0.02	0.02	3X SRCSD Alum
Tertiary PS		0.04		0.04	SRCSD
Rapid Mix		0.03		0.03	SRCSD
High Rate Clarification		0.11		0.11	Central Contra Costa Sanitation District Plant of the Future (CCCSD POF) HDR Report 2011
Alum Feed		0.01		0.01	WERF Sustainability
Methanol Feed		0.02		0.02	3X SRCSD Alum
Polymer Feed		0.00		0.00	SRCSD
Denitrifying Filter		1.30		1.30	SRCSD
Clearwell		0.05		0.05	SRCSD
Filter Backwash PS		0.02		0.02	WERF Sustainability
Effluent PS	0.03	0.03	0.03	0.03	SRCSD
Unified Fermentation and Thickening	0.06	0.06	0.06	0.06	CCCSD POF
Return Stream Equalization				0.06	WERF Sustainability
Tertiary Filter	0.70 <sup>b</sup>		0.70 <sup>b</sup>		
<b>TOTAL</b>	<b>1.89 / 2.59<sup>b</sup></b>	<b>3.47</b>	<b>1.89 / 2.59<sup>b</sup></b>	<b>3.53</b>	

Source: WERF Sustainability Report (Falk, M.W., Neethling, J.B., Reardon, D.J., (2011), Striking the balance between nutrient removal and sustainability, WERF research project NUTR1R06n)

<sup>a</sup> Costs developed separately because there is no solids treatment at North Side WWTP. However, costs were similar for each and, accordingly, only one cost factor was used for the moderate and stringent treatment scenarios.

<sup>b</sup> Lakeside only for CBOD/TSS control.

<sup>c</sup> Additional notes:

1. Capital costs do not include engineering, legal, or fiscal costs.
2. Operations costs include energy and chemicals; no labor or maintenance costs are included.
3. These costs are planning-level estimates. Actual costs could range from +20% to -20%.

# Wastewater Improvements for Detailed Evaluation of Alternatives

**Table A2. Unit Operations Cost Required to Meet Moderate and Stringent Treatment Objectives**

Description	North Side WWTP <sup>a</sup> (\$/MG Treated)		Calumet/Stickney WWTPs (\$/MG Treated)		Source
	Moderate	Stringent	Moderate	Stringent	
5-Stage Bardenpho Basins	269	507	269	507	WERF Sustainability
Return Activated Sludge PS					Included w/5-Stage Bardenpho
Blowers					Included w/5-Stage Bardenpho
Methanol Feed System					Included w/5-Stage Bardenpho
Tertiary PS					Included w/Filtration
Rapid Mix					Included w/Filtration
High Rate Clarification					Included w/Filtration
Alum Feed					Included w/Filtration
Methanol Feed					Included w/Filtration
Polymer Feed					Included w/Filtration
Denitrifying Filter		239		239	WERF Sustainability
Clearwell					Included w/Filtration
Filter Backwash PS					Included w/Filtration
Effluent PS					Included w/Filtration
Unified Fermentation and Thickening	5	5	5	5	WERF Sustainability
Return Stream Equalization	—	—	—	—	WERF Sustainability
Tertiary Filter	60 <sup>b</sup>		60 <sup>b</sup>		WERF Sustainability
<b>TOTAL</b>	<b>274 / 331 <sup>b</sup></b>	<b>751</b>	<b>274 / 331 <sup>b</sup></b>	<b>751</b>	

Source: WERF Sustainability Report (Falk, M.W., Neethling, J.B., Reardon, D.J., 2011, Striking the balance between nutrient removal and sustainability, WERF research project NUTR1R06n)

<sup>a</sup> Costs developed separately because there is no solids treatment at North Side WWTP. However, costs were similar for each and, accordingly, only one cost factor was used for the moderate and stringent treatment scenarios.

<sup>b</sup> Lakeside only for CBOD/TSS control.

<sup>c</sup> Additional notes:

1. Capital costs do not include engineering, legal, or fiscal costs.
2. Operations costs include energy and chemicals; no labor or maintenance costs are included.
3. These costs are planning-level estimates. Actual costs could range from +20% to -20%.



# Wastewater Improvements for Detailed Evaluation of Alternatives

**Figure A1. Potential North Side WWTP Flowsheet to Meet Moderate Treatment Objectives (River or Lake Discharge)**

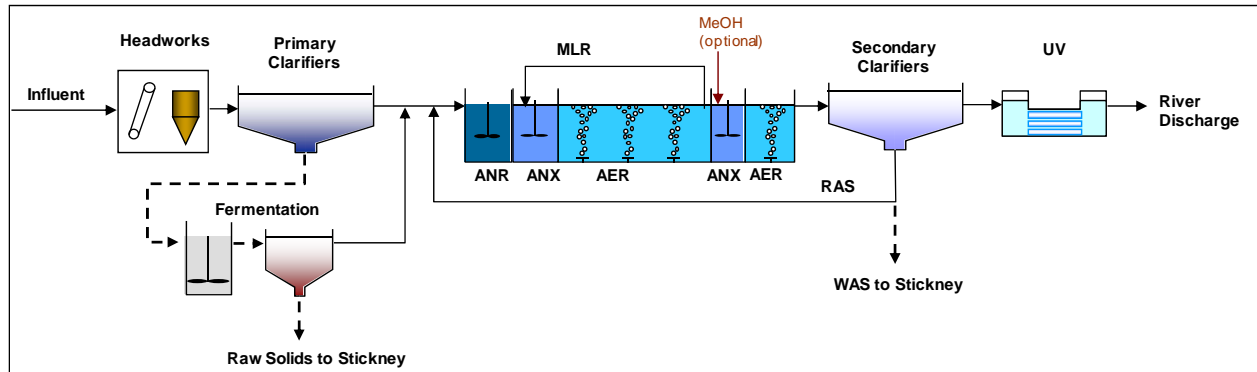

**Figure A2. Potential North Side WWTP Flowsheet to Meet Stringent Treatment Objectives (River or Lake Discharge)**

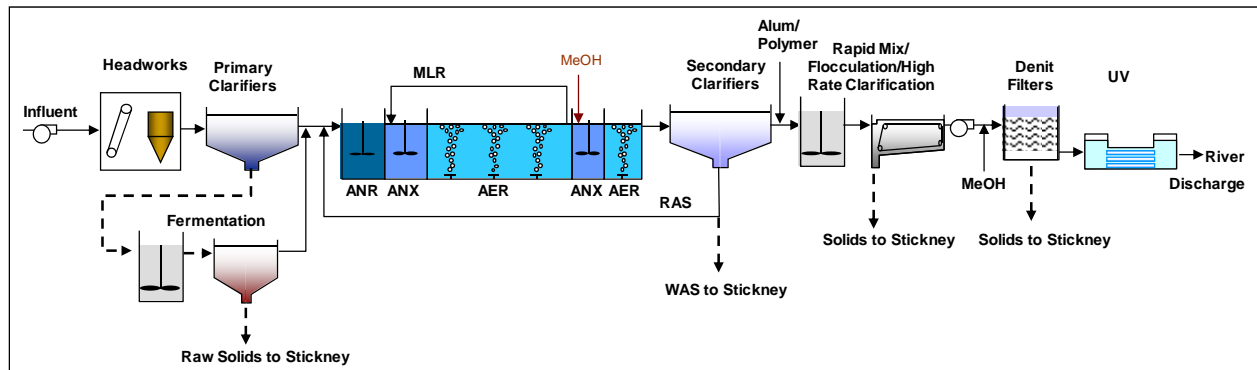

# Wastewater Improvements for Detailed Evaluation of Alternatives

Figure A3. Potential Calumet/Stickney WWTPs Flowsheets to Meet Moderate Treatment Objectives (River or Lake Discharges)

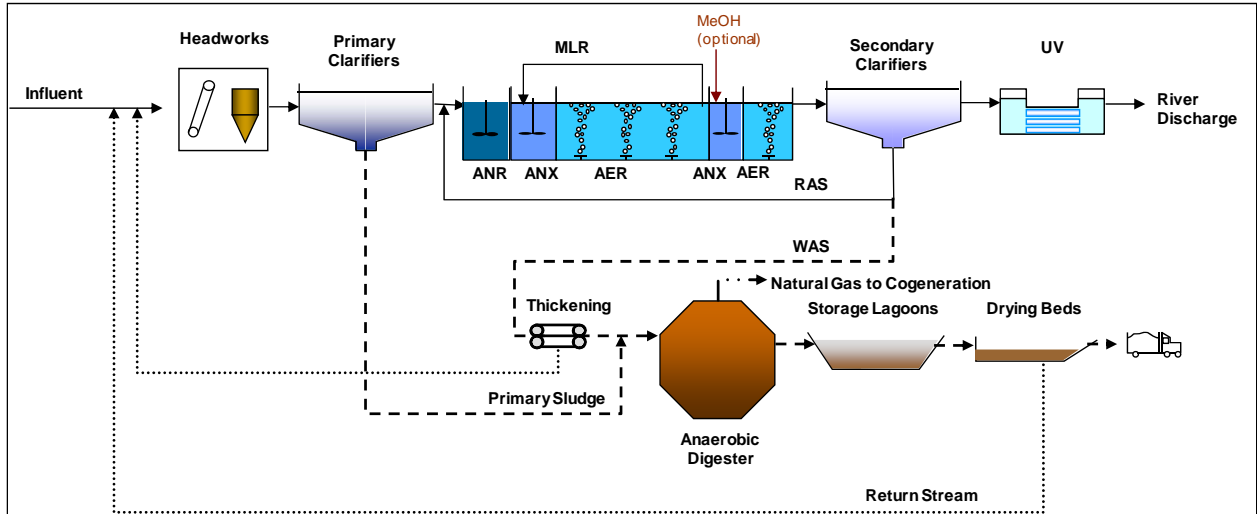
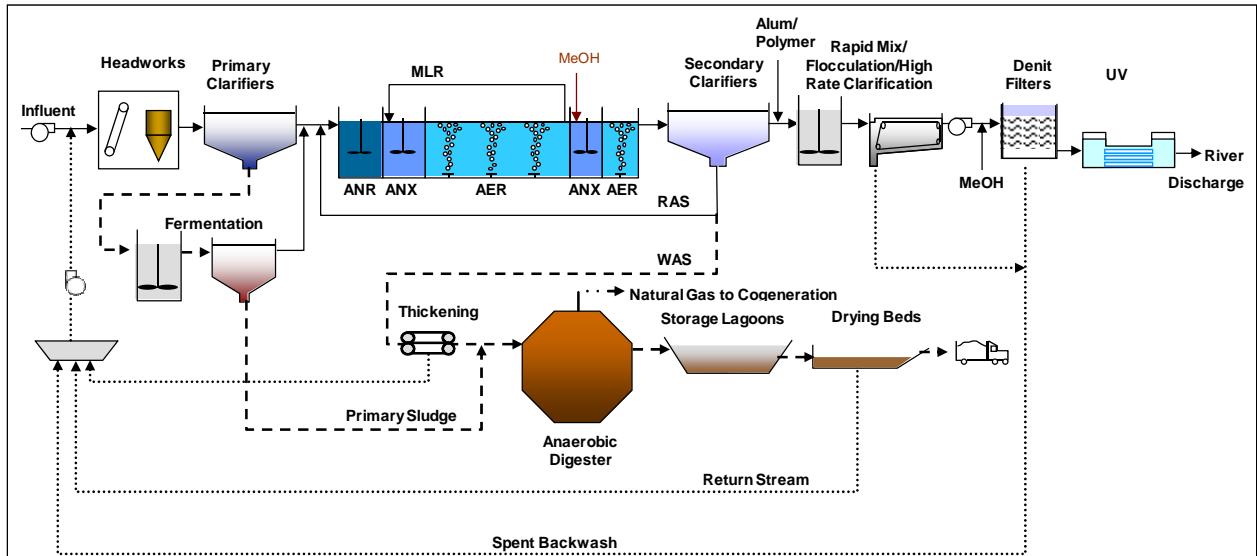

Figure A4. Potential Calumet/Stickney WWTPs Flowsheets to Meet Stringent Treatment Objectives (River or Lake Discharges)



**Estimated Costs of Wastewater Improvements for Potential Range of Regulatory Requirements**

Capital Costs Rounded to nearest 100,000,000  
 Operation Costs Rounded to nearest 10,000,000

	Design Average Flow (mgd) ->	Capital Costs (\$)				Operation Costs (\$/Year)								
		Northside	Calumet	Stickney	Total	Northside	Calumet	Stickney	Total					
		330	350	1200		330	350	1200						
<b>Base Scenarios</b>	Capital \$/gpd	Operation \$/MG Treated												
No changes in Permits	\$ -	\$ -	\$ -	\$ -	\$ -	\$ -	\$ -	\$ -	\$ -	\$ -	\$ -	\$ -	\$ -	\$ -
Moderate River Side Discharges	\$ 1.90	\$ 270	\$ 600,000,000	\$ 700,000,000	\$ 2,300,000,000	\$ 3,600,000,000	\$ 33,000,000	\$ 34,000,000	\$ 118,000,000	\$ 185,000,000				
Stringent River Side Discharges	\$ 3.50	\$ 750	\$ 1,200,000,000	\$ 1,200,000,000	\$ 4,200,000,000	\$ 6,600,000,000	\$ 90,000,000	\$ 96,000,000	\$ 329,000,000	\$ 515,000,000				
<b>Down River</b>														
Moderate Lake Side Discharges	\$ 2.60	\$ 330	\$ 900,000,000	\$ 900,000,000	\$ 3,100,000,000	\$ 4,900,000,000	\$ 40,000,000	\$ 42,000,000	\$ 145,000,000	\$ 227,000,000				
Stringent Lake Side Discharges	\$ 3.50	\$ 750	\$ 1,200,000,000	\$ 1,200,000,000	\$ 4,200,000,000	\$ 6,600,000,000	\$ 90,000,000	\$ 96,000,000	\$ 329,000,000	\$ 515,000,000				
<b>Mid System</b>														
Moderate Lake Side Discharges	\$ 2.60	\$ 330	\$ 900,000,000	\$ -	\$ -	\$ 900,000,000	\$ 40,000,000	\$ -	\$ -	\$ 40,000,000				
Stringent Lake Side Discharges	\$ 3.50	\$ 750	\$ 1,200,000,000	\$ -	\$ -	\$ 1,200,000,000	\$ 90,000,000	\$ -	\$ -	\$ 90,000,000				
<b>Near Lake</b>														
Moderate Lake Side Discharges	\$ 2.60	\$ 330	\$ -	\$ -	\$ -	\$ -	\$ -	\$ -	\$ -	\$ -				
Stringent Lake Side Discharges	\$ 3.50	\$ 750	\$ -	\$ -	\$ -	\$ -	\$ -	\$ -	\$ -	\$ -				
<b>Project Related Costs Assuming Varying River/Lake Discharge Permit Requirements</b>														
<b>Down River</b>														
Moderate River Permit / Stringent Lake			\$ 600,000,000	\$ 500,000,000	\$ 1,900,000,000	\$ 3,000,000,000	\$ 57,000,000	\$ 62,000,000	\$ 211,000,000	\$ 330,000,000				
Stringent River Permit / Stringent Lake			\$ -	\$ -	\$ -	\$ -	\$ -	\$ -	\$ -	\$ -				
Moderate River Permit / Moderate Lake			\$ 300,000,000	\$ 200,000,000	\$ 800,000,000	\$ 1,300,000,000	\$ 7,000,000	\$ 8,000,000	\$ 27,000,000	\$ 42,000,000				
Stringent River Permit / Moderate Lake			\$ -	\$ -	\$ -	\$ -	\$ -	\$ -	\$ -	\$ -				
<b>Mid System</b>														
Moderate River Permit / Stringent Lake			\$ 600,000,000	\$ -	\$ -	\$ 600,000,000	\$ 57,000,000	\$ -	\$ -	\$ 57,000,000				
Stringent River Permit / Stringent Lake			\$ -	\$ -	\$ -	\$ -	\$ -	\$ -	\$ -	\$ -				
Moderate River Permit / Moderate Lake			\$ 300,000,000	\$ -	\$ -	\$ 300,000,000	\$ 7,000,000	\$ -	\$ -	\$ 7,000,000				
Stringent River Permit / Moderate Lake			\$ -	\$ -	\$ -	\$ -	\$ -	\$ -	\$ -	\$ -				



## A5. ECOLOGICAL HEALTH TECHNICAL MEMO



**Technical Memorandum**

**Chicago Area Waterway System  
Ecological Integrity Baseline Conditions**

**Prepared by**

**Ecological Monitoring and Assessment  
Glenview, Illinois**

**For**

**HDR Engineering, Incorporated  
Chicago, Illinois**

**In support of**

**Great Lakes Commission  
and  
Great Lakes St. Lawrence Cities Initiative**

**May, 2011**

# Ecological Integrity Baseline Conditions

---

## Ecological Integrity

The five principal factors that influence and determine the ecological integrity of surface water resources include the flow regime (e.g., velocity, runoff), physical habitat structure (e.g., channel morphology, substrate), chemical attributes (e.g., dissolved oxygen, metals), energy sources (e.g., nutrients, primary and secondary production), and biotic interactions (e.g., reproduction, feeding) (Karr, 1991). Ecological integrity can be defined simply as the interaction between the physical, chemical, and biological processes.

## Study Area

The Chicago Area Waterway System (CAWS) is made up of ten modified natural waterways, one altered lake, and three artificial/man-made channels and canal (Figure 1). The ten modified natural rivers include the Skokie River, Middle Fork of the North Branch of the Chicago River, West Fork of the North Branch of the Chicago River, North Branch of the Chicago River, Chicago River, South Branch of the Chicago River, South Fork of the South Branch of the Chicago River (Bubbly Creek), Calumet River, Grand Calumet River, and the Little Calumet River. The altered lake is Lake Calumet. The three artificial/man-made channels and canal include the North Shore Channel, Chicago Sanitary and Ship Canal, and the Calumet-Sag Channel.

A drainage divide or hydrologic summit occurs in the State of Indiana on the Grand Calumet River and on the Little Calumet River (Figure 1). The drainage divide is a flat area which allows water to flow in one of two directions. On one side of the divide, the water flows west into Illinois. On the other side of the summit, the water flows east into Indiana. During wet weather, water on the east side of the divide in Indiana can flow west into Illinois.

The CAWS is located in northeastern Illinois and northwestern Indiana. The approximately 738 square mile watershed includes Cook, Du Page, Lake, and Will Counties in the State of Illinois, and Lake County in the State of Indiana. The primary land use/land cover across the watershed is urban. However, forest land cover is found throughout the region, especially along the waterways.

Before the reversals of the Chicago and Calumet waterways, waters from the North Branch of the Chicago River, South Branch of the Chicago River, the Grand Calumet River (in Illinois), and the Little Calumet River (in Illinois) were tributaries of Lake Michigan and eventually flowed into the lake. Today, the past natural waterway system is nothing more than a human relic that has resulted from the many man-made changes and alterations that have been made to the waterway system over the past 120 years.



# Ecological Integrity Baseline Conditions

FIGURE 1. MAP of the CHICAGO AREA WATERWAY SYSTEM



# Ecological Integrity Baseline Conditions

---

## Physical Habitat

Physical habitat refers to the sum of the in-stream and riparian habitat features that affect the structure and function of aquatic communities in lotic and lentic and ecosystems. Physical habitat includes geomorphology, substrate composition, in-stream cover, and bank and riparian condition. All of these physical habitat attributes may be directly or indirectly altered by human activities. Habitat assessment is an important element in the evaluation of ecological integrity. Land cover and hydrology also directly impact many of the physical habitat features of flowing water systems.

The CAWS physical habitat variables discussed in the technical memorandum include channel morphology, substrate composition, in-stream vegetation, bank composition, and overhanging canopy.

The physical habitat data summarized below were collected by staff from the Metropolitan Water Reclamation District of Greater Chicago (District) between 2002 and 2008 at 26 monitoring stations in the CAWS. The results from multiple field surveys are presented in a comprehensive technical report that assessed the physical habitat in the CAWS (LimnoTech, 2009).

### *Channel Morphology*

Channel morphology refers to the shape of the river cross-section (depth and width), and includes sinuosity, velocity, and slope. Table 1 summarizes the length, width, depth, and sinuosity of the waterways in the CAWS.

Channel morphology in the CAWS differs substantially from natural waterways. Natural flowing waters have sinuous features (meandering) that have evolved slowly over time, and continue to change, through a particular balance of the sediment and water transport mechanisms. Channelization reduces meandering and the pool-riffle sequence which lessens the sediment depositional patterns. As a consequence, the variability in physical habitat is severely reduced. Aquatic communities require variations in physical habitat for feeding, reproduction, and protection.

The man-made waterways in the CAWS, North Shore Channel, Chicago Sanitary and Ship Canal, and the Calumet-Sag Channel, were by design constructed with straight, uniform sides. During the 1900s, the natural waterways in the CAWS have also been straightened and deepened.

## Ecological Integrity Baseline Conditions

**TABLE 1. CHICAGO AREA WATERWAY SYSTEM CHANNEL MORPHOLOGY**

Waterway	Length (miles)	Width (feet)	Depth (feet)	Sinuosity
North Shore Channel	7.7	90	2 - 10	1.08
North Branch Chicago River	7.7	150 - 300	3 - 17	1.13
Chicago River	1.5	200 - 480	20 - 26	1.03
South Branch Chicago River	4.5	200 - 250	13 - 20	1.25
Bubbly Creek	1.3	100 - 200	3 - 13	1.06
Chicago Sanitary and Ship Canal	31.0	160 - 300	8 - 27	1.08
Calumet River	7.7	300 - 500	3 - 31	1.17
Grand Calumet River	2.7	135 - 250	2 - 12	1.10
Little Calumet River	6.9	250 - 350	5 - 14	1.29
Calumet-Sag Channel	16.2	300 - 450	4 - 12	1.02

A perfectly straight channel has a sinuosity value of 1.0. According to Leopold et al, 1964, natural rivers with a sinuosity of 1.5 or greater are meandering and a sinuosity value less than 1.5 is considered a straight channel. All of the sinuosity values in the CAWS are less than 1.3 (Table 1), indicating no meandering.

Except for the North Shore Channel, all of the waterways in the CAWS are over 100 foot in width (Table 1). Generally, the CAWS are deep (greater than 5 feet) by design in order to convey treated wastewater and floodwaters and support commercial navigation.

The dominant geologic feature of the CAWS is its flatness. Generally, the CAWS have a low gradient resulting in slow moving waters (Butts et al., 1974). During dry weather, water velocities range between 0.25 to 0.50 feet/second. However, it has been reported that water velocities greater than 4 feet/second have occurred in the CAWS during wet weather events (Duncker, personal communication).

### *Substrate Composition*

Substrate composition/size refers to the materials (mineral and organic) that make up the bottom of the water body. These materials may include bedrock, boulders, gravel, sand, silt, clay, and detritus. A mixture of sediment types is important in supporting and

## Ecological Integrity Baseline Conditions

---

maintaining a diverse aquatic community. An increase in the percentage of fine sediments and a decrease in the size of the sediment substrate are indicators of anthropogenic perturbations.

The substrate in the CAWS is dominated by fine sediments (inorganic silt, clay, and organic sludge) with varying amounts of sand and bedrock (Table 2). Scouring from barge traffic and high flows may well be two factors that cause an absence of substrate in selected reaches of the Chicago Sanitary and Ship Canal and the Calumet-Sag Channel. However it should be noted, that a slightly more varied substrate (some sand, gravel, cobble, and boulders) is found in the shallower areas along the margins of the North Shore Channel and the Little Calumet River.

**TABLE 2. SUBSTRATE COMPOSITION in the  
CHICAGO AREA WATERWAY SYSTEM**

Waterway	Inorganic Silt	Organic Sludge	Sand	Gravel	Bedrock
North Shore Channel	X	X	X		
North Branch Chicago River	X	X	X		
Chicago River	X				
South Branch Chicago River	X				
Bubbly Creek		X			
Chicago Sanitary and Ship Canal	X	X	X	X	X
Calumet River	X		X		
Grand Calumet River	X	X			
Little Calumet River	X		X	X	
Calumet-Sag Channel	X	X			X

### *In-Stream Cover*

In-stream cover provides habitat for fish and benthic invertebrates, shelter/protection from high flows and predators, and reproductive features for a variety of biota. The cover may include woody debris, coarse substrates, and submerged/emergent vascular plants.

## Ecological Integrity Baseline Conditions

---

In-stream vegetation is very limiting in the CAWS. However, submerged aquatic vegetation was significant throughout the North Shore Channel (LimnoTech, 2009). Woody debris and coarse substrate on the bottom of the CAWS was also limiting.

### *Bank Composition*

Riparian areas and banks are the interface between the surrounding land and a flowing surface water body. The importance of the quality and quantity of the riparian area and banks is well recognized by ecologists. A man-made vertical walled channel will provide a very different physical habitat for aquatic biota than a natural sloping earthen bank. Riparian vegetation will moderate stream bank erosion and sedimentation, reduce nonpoint surface runoff by filtering, enhance canopy cover and moderate water temperature, and provide organic material (leaf litter) as food for aquatic organisms.

Approximately 63% of the waterways in the CAWS are man-made (LimnoTech, 2009). The banks along much of the CAWS, including natural reaches that have been straightened, are vertical rather than sloping. The banks of the artificial waterways were originally designed to prevent erosion and provide direct access for commercial navigation and industrial activities. Because of the vertical nature of the banks, the riparian areas are functionally disconnected (physically separated) from the watercourse, limiting shallow littoral areas.

The bank conditions along the CAWS vary widely. The banks are a synthesis of steel sheet piling, limestone bedrock, concrete, riprap, and earthen side slopes. Table 3 shows the length of waterway that is riprap or vertical walls. Almost 62% of the banks along the CAWS are riprap or vertical walls. Vertical walls and/or riprap are common in the North Branch of the Chicago River, Chicago River, South Branch of the Chicago River, Chicago Sanitary and Ship Canal, Calumet River, and the Calumet-Sag Channel (Table 3). Riprap and man-made vertical banks impose significant limitations on aquatic habitat that directly impact aquatic life in the CAWS. The North Shore Channel and the Little Calumet River have a natural, earthen appearance, with minimal structural reinforcement.

### *Overhanging Canopy*

Riparian canopy (trees and shrubs) cover is important not only in moderating water temperature through shading, but also provides physical habitat for terrestrial wildlife, especially birds, and directly affects primary production in the water column.

## Ecological Integrity Baseline Conditions

**TABLE 3. BANK COMPOSTION of CHICAGO AREA WATERWAY SYSTEM**

Waterway	Total Length Riprap Banks (miles)	Total Length Vertical Wall Banks (miles)
North Shore Channel	1.1	0.4
North Branch Chicago River	5.2	8.0
Chicago River	0.0	3.1
South Branch Chicago River	0.4	8.0
Bubbly Creek	0.1	1.3
Chicago Sanitary and Ship Canal	3.3	35.5
Calumet River	1.0	10.0
Grand Calumet River	0.2	0.5
Little Calumet River	2.2	0.6
Calumet–Sag River	17.2	6.1

Except for the North Shore Channel, the overhanging canopy cover along the CAWS is very limiting (less than 12%) (Table 4). Most of the water surface is open to sunlight. However the majority of the margins along the banks, except for the Chicago River, have some limited overhanging canopy cover. Compared to other waterways in the CAWS, the North Shore Channel has a much higher percentage of overhanging canopies cover (30%) because the waterway is the narrowest.

### Flow Routine

Flow in the CAWS is managed by the District according to the rules and regulations set forth in the 1930, 1967, and 1980 U.S. Supreme Court Consent Decree, and the Code of Federal Regulations 33 CFR, Parts 207.420 and 207.425. The consent decree specifies that the quantity of water that can be diverted from Lake Michigan into the CAWS will be limited to 3,200 cubic feet per second over a 40-year averaging period. The diversion water includes domestic water supply, direct diversion from the Lake, and surface runoff. The CFR provides for the maintenance and operation of navigable water depths for commercial navigation throughout the CAWS.

## Ecological Integrity Baseline Conditions

**TABLE 4. OVERHANDING CANOPY COVER (%)  
in CHICAGO AREA WATERWAY SYSTEM**

Waterway	Overhanging Canopy (%)
North Shore Channel	30
North Branch Chicago River	12
Chicago River	0
South Branch Chicago River	2
Bubbly Creek	7
Chicago Sanitary and Ship Canal	6
Calumet River	2
Grand Calumet River	3
Little Calumet River	6
Calumet–Sag River	4

Velocity and water elevation in the CAWS, including major tributaries, for the period 1984-2010 were continuously recorded by the United States Geological Survey at surface water discharge monitoring gages. Information/flow data for the period 1997-2006 on Lake Michigan diversion water, District wastewater treatment plants, and combined sewer overflows were analyzed from annual reports prepared by the United States Army Corp of Engineers, Chicago District (Lake Michigan Diversion Accounting reports) and the District (annual operations reports).

### *Outlet Flows*

All outlet flow exits the CAWS at the Lockport Powerhouse and Lock. The Lockport Powerhouse and Lock are located in Lockport, Illinois one mile above the confluence of the Chicago Sanitary and Ship Canal and the Des Plaines River (Figure 1). During storm conditions, water from the CAWS is diverted downstream through nine submerged sluice gates. The maximum discharge at the Lockport Powerhouse is approximately 22,500 cubic feet/second. Periodically during wet weather when discharge above the capacity of the Lockport Powerhouse is exceeded, an outlet structure on the Chicago Sanitary and Ship Canal (Lockport Controlling Works), two miles above the Lockport Lock, will discharge to the Des Plaines River.



## Ecological Integrity Baseline Conditions

---

The total outflow of water for the CAWS is estimated at the United States Geological Survey surface water discharge monitoring gages at Romeoville and Lemont on the Chicago Sanitary and Ship Canal (Figure 1). The estimated mean annual flow in the Chicago Sanitary and Ship Canal will be reported by water year. A water year begins on October 1<sup>st</sup> of the previous year and extends 12 months through September 30<sup>th</sup> of the following year. The estimated mean annual flows reported in the technical memorandum are for the period 1984 through 2010. During the 27 year period, the estimated mean annual flow at Romeoville/Lemont on the Chicago Sanitary and Ship Canal was 3,130 cubic feet/second. The maximum instantaneous flow recorded at Romeoville/Lemont was 19,466 cubic feet/second in February of 1997. Generally, the highest mean monthly flows at Romeoville/Lemont occurred during July through September, and the lowest mean monthly discharges occurred during December and January.

### *Inlet Flows*

There are four primary sources of water that makeup the CAWS: (1) Lake Michigan direct diversion; (2) Water reclamation plants; (3) Major tributaries; and (4) Combined sewer overflows. A brief description of the four principal sources of water to the CAWS will follow.

*Lake Michigan direct diversion flows.* As previously discussed, the Lake Michigan diversion flow accountable to the State of Illinois is 3,200 cubic feet/second over a 40-year averaging period. Water directly diverted from Lake Michigan into the CAWS is apportioned as follows: (1) augmenting low flows and improving waterway water quality (discretionary diversion); (2) locking recreational and commercial boats to and from Lake Michigan (lockages); (3) water estimated to pass in an uncontrolled manner through the three lakefront controlling structures (leakages); and (4) navigational makeup water, water used to maintain regulated navigational depths following a drawdown of the waterways. Direct diversion of water from Lake Michigan into the CAWS occurs at three lakefront locations: Wilmette Pumping Station, Chicago River Lock and Controlling Works, and the T. J. O'Brien Lock (Figure 1). Discretionary diversion for improving water quality in the CAWS principally occurs during the months of May through October.

The pumping station at Wilmette includes four screw pumps and a sluice gate. Water from Lake Michigan is diverted into the North Shore Channel at the Wilmette Pumping Station by a screw pump rated at 250 cubic feet/second. The Chicago River Controlling Works includes a 600 foot long, 80 foot wide navigational lock, two sets of sluice gates, and a pumping station. Water is diverted from Lake Michigan into the Chicago River through openings in the sluice gates. The control structure at the O'Brien Lock includes a 1,000 foot long, 110 foot wide lock and four submerged sluice gates. Water is diverted from the Calumet River downstream through the sluice gates.



## Ecological Integrity Baseline Conditions

Table 5 summarizes the direct diversion flows from Lake Michigan at the Wilmette Pumping Station, Chicago River Controlling Works, and the O'Brien Lock for the period 1997-2006. The largest volume of discretionary water used for improving water quality (48.8%) is diverted through the sluice gates at the Chicago River Controlling Works. During the period 1997 through 2006, the mean lockages, leakages, navigational make-up water, and discretionary diversion flow measured at the three lakefront controlling works was 55, 27, 33, and 254 cubic feet/second, respectively. The mean annual direct diversion flow during the 10-year period into the North Shore Channel (Wilmette Pumping Station), Chicago River (Chicago River Controlling Works), and Little Calumet River (O'Brien Lock) was estimated at 40.6, 178, and 150.4 cubic feet/second, respectively. 11.8% of the water in the CAWS was attributable to direct Lake Michigan diversion flows.

**TABLE 5. DIRECT DIVERSION FLOWS from LAKE MICHIGAN  
at LAKEFRONT CONTROLLING STRUCTURES, 1997-2006**

Lakefront Controlling Structure	Mean Lockage (cfs)	Mean Leakage (cfs)	Mean Navigational Makeup (cfs)	Mean Discretionary Diversion (cfs)	Total Diversion (cfs)
Wilmette	0.0	0.6	0.0	40.0	40.6
Chicago River	22.0	17.0	15.0	124.0	178.0
O'Brien Lock	33.0	9.4	18.0	90.0	150.4
TOTAL	55.0	27.0	33.0	254.0	369.0

*Water reclamation plants.* The District manages and operates seven water reclamation plants in Cook County, Illinois ranging in size from 3.2 million gallons per day at the Lemont Plant to 1,200 million gallons per day at the Stickney Plant. The level of treatment of wastewater varies from a minimum of secondary treatment to tertiary wastewater treatment. Four of the seven plants (Calumet, Lemont, North Side, and Stickney) discharge a treated effluent to the CAWS (Figure 1). Table 6 summarizes the design and measured flows for the four plants that discharge to the CAWS (10-year annual average, 1997-2006). The annual average flow discharged to the CAWS from the Calumet, Lemont, North Side, and Stickney WRPs during the period 1997-2006 was 254, 3, 249, and 712 million gallons/day, respectively. During major storm events, the maximum flow recorded for the four treatment plants is estimated to be 2-3

## Ecological Integrity Baseline Conditions

times the dry weather flow. 12.6, >0.1, 12.3, and 35.3% of the water in the CAWS originated from the treated wastewater from the Calumet, Lemont, North Side, and Stickney plants, respectively.

**TABLE 6. WASTEWATER TREATMENT PLANT FLOWS, 1997–2006**

Water Reclamation Plant	Mean Design Flow		Mean Flow		Maximum Design Flow		Maximum Flow	
	(cfs)	(mgd)	(cfs)	(mgd)	(cfs)	(mgd)	(cfs)	(mgd)
Calumet	549	354	393	254	667	430	991	639
Lemont	5	3	3	3	6	4	9	6
North Side	516	333	386	249	698	450	783	505
Stickney	1860	1200	1104	712	2232	1440	2725	1758

*Tributary flows.* The major tributaries that discharge to the CAWS include the Grand Calumet River, Little Calumet River, and the North Branch of the Chicago River (Figure 1). The estimated minimum, maximum, and mean annual tributary flows for the period of record for the three major tributaries to the CAWS are shown in Table 7. The Little Calumet River at South Holland has the highest annual mean flow (190 cfs) compared to the Grand Calumet River and the North Branch of the Chicago River. Maximum flows during wet weather events have been reported to be 25 times the mean dry weather flow. Overall during the period of record, approximately 0.8, 6.1, and 4.6 % of the water in the CAWS originated from the Grand Calumet River, Little Calumet River, and the North Branch of the Chicago River, respectively.

*Combined sewer overflows.* Combined sewers are sewers that convey raw sewage to wastewater treatment plants during dry weather and both sanitary wastes and storm water during wet weather. A combined sewer overflow (CSO) is a combined sewer that discharges untreated wastewater and storm water to waterways during precipitation (rain or snow) events. When surface runoff causes an interceptor combined sewer to exceed capacity, the sewer will directly discharge to surface waters degrading water quality and causing overbank and/or basement flooding.

50.8% of the CAWS drainage area (375 square miles) includes combined sewers. Twenty-two municipalities, including the City of Chicago, have combined sewers and CSOs. There are 263 gravity combined sewers that discharge to the CAWS (Table 8).

## Ecological Integrity Baseline Conditions

**TABLE 7. MAJOR TRIBUTORY FLOWS to CAWS**

Station Name <sup>1</sup>	Minimum		Maximum		Mean	
	(cfs)	(mgd)	(cfs)	(mgd)	(cfs)	(mgd)
North Branch Albany <sup>2</sup>	4	3	3,580	2,310	143	92
Grand Calumet Hohman <sup>3</sup>	0	0	701	452	25	16
Little Calumet S. Holland <sup>4</sup>	8	5	4,400	2,839	190	123

<sup>1</sup>USGS discharge monitoring station

<sup>2</sup> The period of record is from 1989–present.

<sup>3</sup> The period of record is from 1991–present.

<sup>4</sup> The period of record is from 1947-present.

In 1975, the District began construction of drop shafts and underground deep rock tunnels designed to capture discharges from combined sewers and convey the untreated wastes to open surface water aerated reservoirs rather than overflowing to area waterways. Following storage in the reservoirs, the untreated water is pumped to water reclamation plants for treatment. The structural flood control and water quality improvement system is called the Tunnel and Reservoir Plan (TARP). To date, 109 miles of tunnels have been built and are fully operational. Twenty-six miles of the 109 miles of tunnels are associated with the Des Plaines River. The 109 miles of tunnels provide 2.3 billion gallons of storage. Two large open surface storage reservoirs (McCook and Thornton) are scheduled to be completed by 2029. The design storage capacity for the McCook and Thornton reservoirs is 10 and 7.9 billion gallons, respectively.

The frequency of overflow, mean overflow, and maximum overflow to the CAWS from the North Branch, Racine Avenue, 95<sup>th</sup> Street, 122<sup>nd</sup> Street, and 125<sup>th</sup> Street pump stations for the period 2000-2010 is shown in Table 9. From 2000-2010, the annual average discharge of untreated sewage and storm water to the CAWS from the North Branch, Racine Avenue, 95<sup>th</sup>, 122<sup>nd</sup>, and 125<sup>th</sup> Street Pump Stations was 130, 401, 57, 2, and 128 million gallons, respectively. During the 11-year period, there were a total of 416 overflows to the CAWS from the five pump stations (Table 9). The annual average frequency of overflows at the North Branch and Racine Avenue Pump Stations during 2000 through 2010 was 15. The maximum discharge to the CAWS from the Racine Avenue and North Branch Pump Stations were 4,019 and 1,349 million gallons, respectively (September 9-13, 2008). The total volume of discharges to the CAWS from the 5 pump stations during the 11-year period was 8,179 billion gallons (Table 9).

## Ecological Integrity Baseline Conditions

---

Since TARP became operational in 1985, more than 975 billion gallons of CSOs have been captured and conveyed to District water reclamation plants for treatment. Periodic combined sewer overflows contribute 5% of the water to the CAWS.

**TABLE 8. NUMBER OF COMINED SEWER OUTFALLS (CSOs)  
in CHICAGO AREA WATERWAY SYSTEM**

Waterway	Number of CSOs
North Shore Channel (above North Side WRP outfall)	23
North Shore Channel (below North Side WRP outfall)	22
North Branch Chicago River	64
Chicago River	18
South Branch Chicago River	47
Bubbly Creek	10
Chicago Sanitary and Ship Canal	47
Calumet River	7
Grand Calumet River	7
Little Calumet River	21
Calumet–Sag Channel	14
<b>TOTAL</b>	<b>263</b>

With the completion of TARP, it is estimated that there will be between 1 and 10 combined sewer overflows a year to the CAWS from gravity combined sewers and District Pump Stations. It is expected that there will be more frequent overflows in the North Shore Channel and North and South Branches of the Chicago River compared to other waterways in the CAWS because of the high number of combined sewers and the longer distance to travel to the McCook reservoir.

The District contracts with professional meteorologists to determine the likelihood, duration, and intensity of wet weather events in the greater Chicago metropolitan area. In order to prevent or minimize localized overbank flooding or basement flooding from an anticipated storm event, the District will lower water levels in the CAWS by increasing the discharge at the Lockport Powerhouse. Lowering the water level will allow additional storage in the CAWS.

## Ecological Integrity Baseline Conditions

**TABLE 9. COMBINED SEWER PUMP STATION FLOWS, 2000–2010**

Pump Station	Total Number of Overflows	Mean Number of Overflows	Mean Overflow (MM/gal)	Maximum Overflow (MM/gal)	Total Overflow (MM/gal)
North Branch	165	15	130	1349	21,490
Racine Ave.	165	15	401	4019	66,191
95 <sup>th</sup> Street	15	1	57	137	848
122 <sup>nd</sup> Street	7	1	2	4	17
125 <sup>th</sup> Street	64	6	128	801	8179

During major wet weather events, the runoff may unexpectedly raise waterway levels, necessitating a decrease in water elevation by releasing flood waters into Lake Michigan at one or more of the three lakefront control structures. Since 1985, 37 reversals or back flows to the Lake have occurred. The frequency (percent) of reversals to Lake Michigan at the Wilmette Pumping Station, Chicago River Controlling Works, and the O’Brien Lock during the 26-year period was 23 (62%), 10(27%), and 4(11%), respectively. The maximum total volume of flood waters released back to Lake Michigan on September 13-16, 2008 at all three lakefront control structures was 11,049 million gallons.

With TARP completed, the frequency of back flows to Lake Michigan at the Wilmette Pumping Station, Chicago River Controlling Works, and the O’Brien Lock are predicted to be once every 16 months, once in 5 years, and once in 10 years, respectively.

Table 10 summarizes the mean flow during the period 1997-2006 for four District water reclamation plants, direct diversion of water from Lake Michigan at three lakefront controlling structures (lockages, leakages, navigational make-up, and discretionary diversion), tributary flows (Grand Calumet River, Little Calumet River, and the North Branch of the Chicago River), combined sewer overflows (gravity sewers and pumping stations), and other miscellaneous water sources (ungaged nonpoint runoff). The largest source of water to the CAWS is from the wastewater treatment plants operated by the District (1,888 cfs).

Figure 2 illustrates the estimated percentages of CAWS inflows from the five primary water sources described above during the ten-year period.

## Ecological Integrity Baseline Conditions

**TABLE 10. MEAN FLOW of PRINCIPAL SOURCES of WATER to CAWS, 1997-2006**

Sources of Water	Mean Flow (cfs)
Combined Sewer Overflows	157
Direct Diversion from Lake Michigan	369
Wastewater Treatment Plants	1888
Tributaries	358
Others (non point runoff)	360

**FIGURE 2. MAJOR SOURCES of WATER to CAWS**

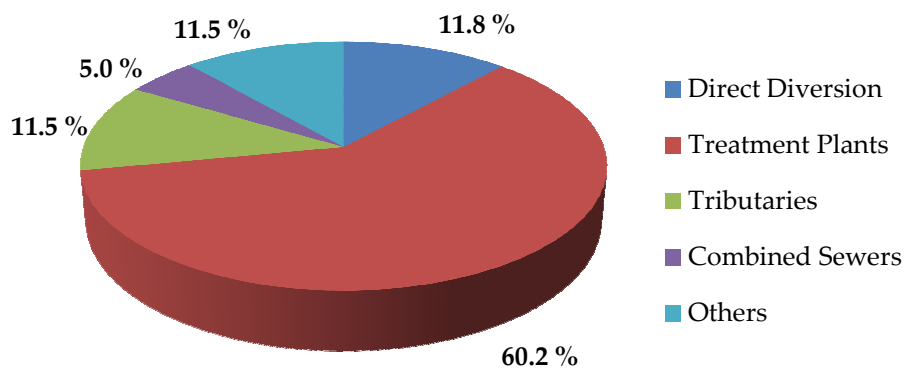

### Sediment Chemistry

Aquatic sediments become contaminated with inorganic and organic chemicals, which are absorbed to particulate matter or in solution. In most aquatic systems, the concentrations of chemical constituents in bottom sediments are far greater than the concentrations in the overlying water column. As the result of human activities, past (legacy) and present, contaminants in aquatic sediments originate from point source wastewater discharges, periodic overflows from combined sewers and nonpoint runoff, and atmospheric deposition. There is a very strong positive correlation between decreasing sediment grain size (large surface area) and increasing concentrations of chemical contaminants (Horowitz, 1985). The

## Ecological Integrity Baseline Conditions

---

majority of bed-load transport of suspended sediment contaminants in flowing water can be attributed to the smaller sediment grain size (less than 2 $\mu$ m). Subject to the concentration of sediment contamination, heavy metals and persistent organic chemicals can be toxic to aquatic organisms, particularly benthic invertebrates. Contaminated sediments can also affect fish and wildlife by contributing to the bioaccumulation of contaminants in the food chain.

Six heavy metals (cadmium, chromium, copper, lead, mercury, and zinc), six polychlorinated biphenyls (PCB 1016, PCB 1232, PCB 1242, PCB 1248, PCB 1254, and PCB 1260), and 15 polychlorinated aromatic hydrocarbons (acenaphthene, acenaphthylene, anthracene, benzo[*a*]anthracene, benzo[*a*]pyrene, benzo[*k*]fluoranthene, benzo[*ghi*]perylene, chrysene, dibenz[*ah*]anthracene, fluoranthene, fluorene, indeno[1,2,3-*cd*]pyrene, naphthalene, phenanthrene, and pyrene) were selected to describe the sediment chemistry in the CAWS.

The heavy metals and persistent organic chemicals identified above were selected to describe the extent of chemical sediment contamination in the CAWS. To assess the potential impact of contaminated sediments on the benthic community, metals and persistent organic chemicals measured in sediment were compared to the consensus-based threshold effect concentration (TEC) and the probable effects concentration (PEC) thresholds (MacDonald et al., 2000). TEC represents a sediment concentration below which adverse effects are not expected to occur (toxicity is unlikely) and a PEC concentration denotes the sediment concentration level where toxic effects are probable or likely to occur for both tolerant and sensitive organisms. The sediment concentration between the TEC and PEC can be thought of as being possibly toxic to benthic organisms.

The sediment chemistry data discussed below was collected and analyzed by District staff during 2002, 2003, 2005, 2006, 2007, and 2009. Sediment samples were collected from the side and from the center of a waterway once during a four-year period at 26 locations in the CAWS using a 6 X 6 inch Ponar grab sampler.

### *Heavy Metals*

It is likely that considerable quantities of heavy metals which reach surface waters eventually settle to the bottom and accumulate in sediments. In addition to natural geologic background, possible pathways of metal (anthropogenic origin) to aquatic systems include municipal and industrial waste discharges and urban runoff. Even though heavy metals are discharged to flowing waters at subtoxic levels, many are capable of being concentrated in sediments. Bottom sediments contain significantly higher concentrations of metals than are found in the overlying waters. The bottom sediment concentrations can be more than 100,000 times higher than dissolved in water (Horowitz, 1985). Heavy metals are non-degradable and persist in the environment for extended periods of time. High concentrations of metals are



## Ecological Integrity Baseline Conditions

more commonly associated with fine-grained organic sediment particles. It has been reported that heavy metals will substantially affect the structure and function of benthic organisms.

The mean concentrations of heavy metals measured in CAWS sediment during 2002, 2003, 2005, 2006, 2007, and 2009 and consensus-based sediment threshold effects limits are presented in Table 11.

**TABLE 11. MEAN CONCENTRATION of SELECT HEAVY METALS  
MEASURED in CAWS SEDIMENTS, 2002–2009**

	Mean Cadmium (mg/kg) TEC <sup>1</sup> = 0.99 PEC <sup>1</sup> = 5.0	Mean Chromium (mg/kg) TEC <sup>1</sup> = 43.0 PEC <sup>1</sup> = 110.0	Mean Copper (mg/kg) TEC <sup>1</sup> = 32.0 PEC <sup>1</sup> = 150.0	Mean Lead (mg/kg) TEC <sup>1</sup> = 36.0 PEC <sup>1</sup> = 130.0	Mean Mercury (mg/kg) TEC <sup>1</sup> = 0.18 PEC <sup>1</sup> = 1.1	Mean Zinc (mg/kg) TEC <sup>1</sup> = 120.0 PEC <sup>1</sup> = 460.0
Waterways						
North Shore Channel	<i>2.4</i>	25.4	<i>59</i>	<i>64</i>	<i>0.41</i>	<i>175</i>
North Branch	<b>22.6</b>	<b>150.2</b>	<b>209</b>	<b>317</b>	<i>1.00</i>	<b>695</b>
Chicago River	<b>6.1</b>	<i>88.0</i>	<b>176</b>	<b>501</b>	<b>1.25</b>	<b>512</b>
South Branch	<b>8.1</b>	<i>105.0</i>	<b>188</b>	<b>390</b>	<b>1.32</b>	<b>465</b>
Bubbly Creek	<i>3.7</i>	<i>76.0</i>	<b>152</b>	<b>338</b>	<b>1.71</b>	<b>578</b>
Chicago San. & Ship	<b>7.9</b>	<b>121.0</b>	<b>175</b>	<b>225</b>	<i>1.02</i>	<b>578</b>
Calumet River	<i>1.5</i>	32.7	<i>38</i>	<i>104</i>	0.08	275
Grand Calumet River	<b>8.6</b>	<b>138.5</b>	<b>342</b>	<b>414</b>	<b>1.44</b>	<b>1460</b>
Little Calumet River	<i>1.6</i>	<i>69.5</i>	<i>68</i>	<b>181</b>	<i>1.06</i>	376
Calumet–Sag River	<i>3.4</i>	<i>69.5</i>	<i>70</i>	<b>221</b>	<i>0.29</i>	<b>732</b>

<sup>1</sup>TEC (shown in italics) and PEC (shown in bold) represent consensus-based sediment concentrations below which adverse effects are unlikely and are probably toxic, respectively.

Almost all of the heavy metal concentrations in CAWS sediments were elevated above background conditions. The highest mean concentrations of cadmium (22.6 mg/kg), chromium (150.2 mg/kg), copper (342 mg/kg), lead (501 mg/kg), mercury (1.71 mg/kg), and zinc (1,460 mg/kg) in sediments were found in the North Branch of the Chicago River, North Branch of the Chicago River, Grand Calumet River, Chicago River, Bubbly Creek, and the Grand Calumet River, respectively (Table 11). The lowest mean concentrations of the six heavy metals in CAWS sediments were measured in the North Shore Channel or the Calumet River (Table 11).



## Ecological Integrity Baseline Conditions

---

The cadmium, chromium, copper, lead, mercury, and zinc concentrations in CAWS sediments exceeded the Threshold Effect Level in 38, 33, 51, 26, 47, and 39 of 92 samples, respectively, and exceeded the Probable Effect Level in 33, 26, 29, 57, 22, and 43 of 92 samples, respectively. Overall, the bulk of sediment samples that exceeded the Probable Effect Level were collected from Bubbly Creek, Chicago River, Chicago Sanitary and Ship Canal, Grand Calumet River, North Branch of the Chicago River, and the South Branch of the Chicago River. The mean concentration of all six heavy metals exceeded the Probable Effect Level in the Grand Calumet River (Table 11).

### *Total Polychlorinated Biphenyls*

Polychlorinated biphenyls or PCBs are man-made chlorinated, organic, industrial compounds. PCBs were manufactured in the United States from 1929 until their manufacture was banned in 1979. PCBs have been used in a number of industrial and commercial applications, including electrical, heat transfer, hydraulic lubricants, pigments in dyes, inks, and paints, and waterproofing agents. Their chemical properties, such as chemical stability, persistence for long periods of time with little likelihood of anaerobic degradation, and non-flammability with electrical insulating properties were responsible for many of their industrial applications.

Principal sources of PCBs to the aquatic environment are through atmospheric deposition, point source wastewater discharges, and leachate from landfills. PCBs adhere to the surface of fine organic particles in the water column resulting in their eventual deposition and accumulation in sediments. PCBs enter the aquatic food web through uptake by benthic organisms that are consumed by bottom feeding fish. Exposure to PCBs through contaminated fish is problematic due to evidence that at least some of the compounds exhibit certain toxicity and potential carcinogenic and mutagenic activity.

The mean concentrations of total PCBs measured in CAWS sediments during 2002, 2003, 2005, 2006, 2007, and 2009 and consensus-based sediment threshold effects limits are presented in Table 12.

The sediment concentrations of PCBs range from 0.01 µg/kg in the Little Calumet River to 42,600 µg/kg in the North Branch of the Chicago River. The highest mean concentration of total PCBs in CAWS sediments were found in the North Branch of the Chicago River (758 µg/kg). The lowest mean concentrations of total PCBs were collected from the North Shore Channel (25 µg/kg) (Table 12). PCB congener 1248, 1254, and 1260 accounted for 59.4, 10.1, and 16.5% of the total PCBs in CAWS sediments.

## Ecological Integrity Baseline Conditions

---

36 of 81 sediment samples collected from the CAWS (44%) were below the Threshold Effect Level for total PCBs. The total PCBs concentration in sediments exceeded the Threshold Effect Level in 35 of 81 samples (43%) and exceeded the Probable Effect Level in 10 of 81 samples. Excluding the Little Calumet River and the North Shore Channel, the mean total PCB concentration in sediments exceeded the Threshold Effect Level in 8 of the 10 Chicago Area Waterways (Table 12). The bulk of the sediments that exceeded the Probable Effect Level for total PCBs were in the Chicago Sanitary and Ship Canal and the North Branch of the Chicago River.

**TABLE 12. MEAN CONCENTRATION of  
TOTAL POLYCHLORINATED BIPHENYLS (PCBs)  
in CAWS SEDIMENTS, 2002–2009**

Waterway	Total PCBs (ug/kg) <sup>1,2</sup>
North Shore Channel	25
North Branch Chicago River	<b>758</b>
Chicago River	294
South Branch Chicago River	360
Bubbly Creek	333
Chicago Sanitary and Ship Canal	593
Calumet River	148
Grand Calumet River	113
Little Calumet River	No Data
Calumet–Sag Channel	205

<sup>1</sup>TEC = 60 ug/kg (in italics)

<sup>2</sup>PEC = 676 ug/kg (in bold)

### *Total Polychlorinated Aromatic Hydrocarbons*

Polychlorinated aromatic hydrocarbons (PAHs) include a large class of chemical compounds that consist of two or more benzene (aromatic) rings. PAHs naturally occur in oil,

## Ecological Integrity Baseline Conditions

---

coal, and tar deposits. These compounds are also byproducts of burning fuel (fossil, wood, coal). Anthropogenic sources (point source discharges and nonpoint runoff) appear to be the major sources of PAHs in sediments. The ultimate fate of most of these compounds is deposition and accumulation in sediments. PAHs are highly adsorbed to organic particulate matter. Degradation in sediment is very slow. PAHs are of environmental concern because many of these compounds have been shown to be toxic to aquatic organisms and are highly carcinogenic to humans at relatively low concentrations.

The mean concentrations of total PAHs measured in CAWS sediments during 2002, 2003, 2005, 2006, 2007, and 2009 and consensus-based sediment threshold effects limits are presented in Table 13.

**TABLE 13. MEAN CONCENTRATION of  
TOTAL POLYCYCLIC AROMATIC HYDROCARBONS (PAHs)  
in CAWS SEDIMENTS, 2002-2009**

Waterway	Total PAHs (ug/kg) <sup>1,2</sup>
North Shore Channel	1,492
North Branch Chicago River	<b>22,975</b>
Chicago River	<b>40,499</b>
South Branch Chicago River	<b>22,903</b>
Bubbly Creek	5,761
Chicago Sanitary and Ship Canal	4,956
Calumet River	435
Grand Calumet River	6,012
Little Calumet River	634
Calumet–Sag Channel	2,060

<sup>1</sup>TEC = 1,610 ug/kg (in italics)

<sup>2</sup>PEC = 22,800 ug/kg (in bold)

The sediment concentrations of PAHs range from 0.01 µg/kg in a number of waterways to 1,005,339 µg/kg (phenanthrene) in the North Branch of the Chicago River. The highest mean concentration of total PAHs in CAWS sediments were found in the Chicago River

## Ecological Integrity Baseline Conditions

---

(40,499 µg/kg). The lowest mean concentrations of total PAHs were collected from the Calumet River (435 µg/kg).

34 of 81 sediment samples (42%) collected from the CAWS did not exceed the total PAH Threshold Effect Level or the Probable Effect Level. The mean concentration of total PAHs in the Calumet River (435 µg/kg), Little Calumet River (634 µg/kg), and the North Shore Channel (1,492 µg/kg) did not exceed the Threshold Effect Level. 42 of 81 sediment samples collected from the CAWS (52%) exceeded the Threshold Effect Level for total PAHs, and 5 of 81 sediment samples exceeded the Probable Effect Level. The sediment samples that exceeded the Probable Effect Level for total PAHs were collected from the Chicago River, North Branch of the Chicago River, and the South Branch of the Chicago River.

### Water Quality

Over the years with the development of urban areas, it became necessary to provide sanitary sewers to transport sanitary wastes to treatment facilities and drainage for storm water to convey flood waters away from developed areas. Treated wastewater discharges and urban runoff from combined sewers and separate storm sewers directly affects the chemical water quality in rivers and streams. The quality of water is affected by a number of physical, chemical, and biological parameters.

Three chemical constituents (dissolved oxygen, total phosphorus, total mercury), and one biological indicator (fecal coliform) were selected to describe the chemical integrity of the CAWS.

The physical and chemical water quality data discussed were collected and analyzed by the District. Surface grab water samples were collected monthly by District staff during the period 2005-2009 from the center of the waterway at 26 ambient monitoring stations in the CAWS. Water samples were analyzed for a wide range of physical, chemical, and biological parameters.

#### *Dissolved Oxygen*

The importance of dissolved oxygen can be presumed from the knowledge that an adequate dissolved oxygen concentration must be maintained in an aquatic ecosystem for organisms to produce energy for growth and reproduction (aerobic conditions). The absence of dissolved oxygen results in a highly undesirable anaerobic nuisance conditions in the ecosystem. Dissolved oxygen concentrations are an important indicator of water quality and the ability of a water body to support a well-balanced aquatic community. A minimum

## Ecological Integrity Baseline Conditions

---

dissolved oxygen concentration of 5.0 mg/L is required for early life protection of fish in warm water ecosystems (USEPA, 1986).

The mean and minimum dissolved oxygen values measured in the CAWS during the period 2005-2009 are summarized in Table 14. The lowest mean dissolved oxygen values measured during the five-year period were 5.5 and 5.7 mg/L in the Grand Calumet River and in Bubbly Creek, respectively. The highest mean dissolved oxygen values were recorded in the Calumet River (9.0 mg/L) and in the Chicago River (8.8 mg/L). During 2005-2009, all ten waterways in the CAWS had a minimum dissolved oxygen value below the 5.0 mg/L minimum value required for early life stage protection in fish (Table 14).

**TABLE 14. MEAN and MINIMUM DISSOLVED OXYGEN CONCENTRATIONS  
MEASURED in CHICAGO AREA WATERWAY SYSTEM, 2005–2009**

Waterway	Mean Dissolved Oxygen (mg/L)	Minimum Dissolved Oxygen (mg/L)
North Shore Channel	7.5	0.3
North Branch Chicago River	7.2	3.0
Chicago River	8.8	4.5
South Branch Chicago River	7.4	3.7
Bubbly Creek	5.7	1.2
Chicago Sanitary and Ship Canal	6.5	2.4
Calumet River	9.0	4.5
Grand Calumet River	5.5	1.4
Little Calumet River	7.3	3.4
Calumet–Sag Channel	7.0	3.4

As the water flows downstream, away from Lake Michigan, towards the Lockport Controlling Works, the mean dissolved oxygen concentration decreases along the length of the CAWS (Table 14). The decrease in oxygen in the water column can be attributed to the following conditions: (1) low velocities in the CAWS during dry weather causing minimal reaeration; (2) oxygen demand exerted by organic bottom sediments (sediment oxygen demand); and (3) the biochemical oxygen demand from natural and anthropogenic sources, especially during wet weather.

## Ecological Integrity Baseline Conditions

---

### *Total Phosphorus*

Phosphorus is an essential nutrient for plant and animal growth, and similar to nitrogen, it passes through cycles of decomposition and photosynthesis. Generally, it is recognized that phosphorus is not the single cause for excessive plant growth. However, there is strong evidence that phosphorus is a key nutrient in accelerating plant growth. The condition of nutrient enrichment and excessive plant production is referred to as eutrophication. Excess nutrient enrichment can cause ecological degradation by reducing the dissolved oxygen in flowing waters. Phosphorus as phosphates is naturally found in flowing waters in low concentrations in the order of less than 0.2 mg/L (USEPA, 1976). Elevated concentrations generally indicate that man-made sources (wastewater, fertilizers, detergents, nonpoint runoff) are contributing phosphorus to aquatic systems. Reference conditions for total phosphorus levels in rivers and streams in Nutrient Ecoregion VI (northern half of Illinois) are 0.076 mg/L (USEPA, 2000). Currently, there is no State of Illinois standard for phosphorus in flowing waters.

**TABLE 15. MEAN and MAXIMUM TOTAL PHOSPHORUS CONCENTRATIONS  
MEASURED in the CHICAGO AREA WATERWAY SYSTEM, 2005–2009**

Waterway	Mean Total Phosphorus (mg/L)	Maximum Total Phosphorus (mg/L)
North Shore Channel	0.77	2.25
North Branch Chicago River	1.03	2.35
Chicago River	0.22	0.85
South Branch Chicago River	0.69	1.60
Bubbly Creek	0.61	1.70
Chicago Sanitary and Ship Canal	0.85	2.38
Calumet River	0.05	0.12
Grand Calumet River	0.82	4.35
Little Calumet River	1.03	6.73
Calumet–Sag Channel	1.59	6.32

The mean and maximum total phosphorus concentrations measured in the CAWS during the period 2005-2009 are summarized in Table 15. During the five-year monitoring

## Ecological Integrity Baseline Conditions

---

period, the lowest mean total phosphorus concentrations were found in the Calumet River (0.05 mg/L) and the Chicago River (0.22 mg/L). The highest mean total phosphorus levels were measured in the Calumet-Sag Channel (1.59 mg/L). Except for the Calumet River, the remaining nine waterways in the CAWS had a maximum total phosphorus value equal or above 0.85 mg/L (Table 15).

Total phosphorus substantially increased in concentration along the CAWS as water was transported downstream away from Lake Michigan towards the Lockport lock (Table 15). The increase in phosphorus levels in the CAWS resulted from District wastewater treatment plant discharges, periodic overflows from combined sewers, and nonpoint runoff from diffuse urban sources throughout the watershed.

### *Total Mercury*

Mercury is a toxic metal that is released to the environment through natural (e.g., volcanic eruptions, forest fires) and anthropogenic processes (e.g., fossil fuel burning, laboratories, hospitals, and dental offices). Most commonly, the gaseous form of mercury is released to the atmosphere, which is deposited onto the land surface and water through wet deposition. Once in the water, mercury can be converted to its most toxic form, methylmercury, which is assimilated by benthic organisms that in turn transport mercury to fish by ingestion. Humans are exposed to methylmercury by consuming contaminated fish. In the aquatic environment, the bulk of mercury is found in bottom sediments rather than water. Generally, the concentration of mercury increases in tissue at higher trophic levels in the food chain, a process referred to as biomagnification. The recommended acute and chronic numeric criteria for total mercury in Illinois flowing waters are 2.6 and 1.3 µg/L, respectively (IEPA, 1998).

The mean and maximum total mercury concentrations in the CAWS during the period 2005-2009 are presented in Table 16. The lowest mean total mercury values (0.05 µg/L) were measured during the five-year period in the Calumet River, Calumet-Sag Channel, Chicago Sanitary and Ship Canal, Little Calumet River, North Branch of the Chicago River, North Shore Channel, and the South Branch of the Chicago River (Table 16). The highest mean total mercury values were recorded in Bubbly Creek (0.08 µg/L) and in the Grand Calumet River (0.08 µg/L).

There was little variation in the mean mercury concentration along the length of the CAWS as the waterways flow downstream away from Lake Michigan, towards the Lockport Controlling Works (Table 16).

## Ecological Integrity Baseline Conditions

**TABLE 16. MEAN and MAXIMUM TOTAL MERCURY CONCENTRATIONS MEASURED  
in the CHICAGO AREA WATERWAY SYSTEM, 2005–2009**

Waterway	Mean Total Mercury (ug/L)	Maximum Total Mercury (ug/L)
North Shore Channel	0.05	0.67
North Branch Chicago River	0.05	0.29
Chicago River	0.06	0.19
South Branch Chicago River	0.05	0.08
Bubbly Creek	0.08	1.09
Chicago Sanitary and Ship Canal	0.05	0.14
Calumet River	0.05	0.11
Grand Calumet River	0.08	0.85
Little Calumet River	0.05	0.11
Calumet–Sag Channel	0.05	0.13

### *Fecal Coliform*

It has been known for over two hundred years that water can serve as a medium for the transfer of disease. Bacterial indicators of pollution in water are associated with contamination from feces of warm-blooded animals (man, wild and domestic animals, and birds). Fecal coliform bacteria, a subset of the total coliform group, are restricted to the intestinal tract of warm-blooded animals and are used routinely to define fecal bacterial contamination in water. The numbers of fecal coliforms in water are indicative of the potential health risk associated with pathogens. Fecal coliforms can enter aquatic systems through direct discharge of wastes from mammals and birds, urban and agricultural runoff, and from domestic wastewater. During the months of May through October, fecal coliform shall not exceed a geometric mean of 200 cfu/100 mL in General Use Waters in Illinois (IEPA, 1998).

The geometric means and maximum number of fecal coliforms in the CAWS during the period 2005-2009 are summarized in Table 17. Between 2005 and 2009, the lowest geometric means of fecal coliforms were in the Calumet River (16 cfu/100 mL) and in the Chicago River (142 cfu/100 mL). The highest geometric mean for fecal coliform was measured in the North Branch of the Chicago River (3,887 cfu/100 mL). The maximum numbers of fecal coliforms in



## Ecological Integrity Baseline Conditions

---

the CAWS were in Bubbly Creek (1,260,000 cfu/100 mL) and in the South Branch of the Chicago River (860,000 cfu/100 mL). The maximum concentrations of fecal coliforms collected from the CAWS were attributed to combined sewer overflows from the Racine Avenue Pumping Station.

**TABLE 17. GEOMETRIC MEAN and MAXIMUM NUMBER  
of FECAL COLIFORMS in the CAWS, 2005-2009**

Waterway	Geometric Mean Fecal Coliform (cfu/100ml)	Maximum Number Fecal Coliform (cfu/100ml)
North Shore Channel	1817	280,000
North Branch Chicago River	3887	260,000
Chicago River	142	200,000
South Branch Chicago River	726	860,000
Bubbly Creek	432	1,260,000
Chicago Sanitary & Ship Canal	658	700,000
Calumet River	16	960
Grand Calumet River	973	490,000
Little Calumet River	544	1,7000
Calumet-Sag Channel	547	8,600

Fecal coliforms substantially increased in concentration along the CAWS as water traveled downstream away from Lake Michigan to the Lockport lock (Table 17). The increase in the number of fecal coliforms in the CAWS resulted from District wastewater treatment plant discharges, gravity combined sewer overflows, and pumping station discharges that were not disinfected.

### Fish Community

The species composition, distribution, and abundance of fish are affected by both physical and chemical factors (Schlosser, 1991). Many anthropogenic disturbances characteristic of an urban landscape negatively impact the ecological health of fish. Urban stressors include wastewater discharges, combined sewer overflows, nonpoint runoff,

## Ecological Integrity Baseline Conditions

---

straightening and deepening river channels, and flow alterations caused by dams and water diversions.

Fish have a number of attributes that make them useful as biological indicators of ecosystem health. Fish are excellent indicators of long-term chemical and physical impairments because their lifespans are long. The fish community generally includes a range of species that represent a broad spectrum of feeding practices, reproductive traits, and tolerance to environmental perturbations. Fish are at the top of the aquatic food web and are consumed by humans; thus fish are important for assessing water contamination. Fish are easily identified compared to other groups of aquatic biota.

The fish data discussed below was collected and processed by District staff during 2002, 2004, and 2007-2009. Fish were collected in the field once every four years at 26 ambient monitoring stations in the CAWS employing a boat-mounted electrofisher. The electrofisher was powered by a direct current (DC) generator.

The number of fish species, composition of the fish community, and the number of tolerant and intolerant fish species were selected for the technical memorandum to quantify the quality and condition of the fish community in the CAWS. Increased species richness with a high percentage of intolerant species compared to tolerant species is generally indicative of a healthy fish community in a warm water ecosystem. A fish community dominated by one or two tolerant fish species and a few or absence of intolerant species represents a degraded, stressed, aquatic system.

During the monitoring period, 53 species of fish, including three hybrids, were collected and identified from the CAWS (Table 18). The highest species diversity in the CAWS was in the Cyprinidae (carps and minnows) (11 species) and the Centrarchidae (sunfishes) (10 species) families. The dominant non-game fish species in the CAWS were the gizzard shad (*Dorosoma cepedianum*), bluntnose minnow (*Pimephales notatus*), and the common carp (*Cyprinus carpio*) (Table 19). All three species were widespread and were collected from the 26 monitoring locations. The most abundant game fish in the CAWS were the pumpkinseed (*Lepomis gibbosus*), bluegill (*Lepomis macrochirus*), and largemouth bass (*Micropterus salmoides*) (Table 19).

Fish community metrics for CAWS are summarized in Table 20. The highest total number of fish species (37) was found in the Little Calumet River. The lowest species diversity for fish (5) was in the Grand Calumet River. The mean percentage of tolerant fish species in the CAWS was 71% (Table 20). The highest number of intolerant fish species (6) was collected in the Little Calumet River.

## Ecological Integrity Baseline Conditions

Overall, the fish community in the CAWS is characterized by highly tolerant species, a shift towards more generalized foraging (omnivores), that typically occurs with physical habitat degradation, and a low abundance of intolerant, native fish species.

**TABLE 18. LIST of COMMON and SCIENTIFIC NAMES for FISH COLLECTED  
from THE CHICAGO AREA WATERWAY SYSTEM, 2002-2009**

Common Name	Scientific Name	Native (N)/ Introduced (I)
ALEWIFE	<i>Alosa pseudoharengus</i>	I
BIGHEAD CARP	<i>Hypophthalmichthys nobilis</i>	I
BLACK BUFFALO	<i>Ictiobus niger</i>	N
BLACK BULLHEAD	<i>Ameiurus melas</i>	N
BLACK CRAPPIE	<i>Pomoxis nigromaculatus</i>	N
BLACKSTRIPE TOPMINNOW	<i>Fundulus notatus</i>	N
BLUEGILL	<i>Lepomis macrochirus</i>	N
BLUNTNOSE MINNOW	<i>Pimephales notatus</i>	N
BROWN BULLHEAD	<i>Ameiurus nebulosus</i>	N
BROOK SILVERSIDE	<i>Lepidesthes sicculus</i>	N
CARP HYBRID	<i>Cyprinus hybrid</i>	I
CENTRAL MUDMINNOW	<i>Umbra timi</i>	N
CHANNEL CATFISH	<i>Ictalurus punctatus</i>	N
CHINOOK SALMON	<i>Oncorhynchus tshawytscha</i>	I
COMMON CARP	<i>Cyprinus carpio</i>	I
CREEK CHUB	<i>Semotilus atromaculatus</i>	N
EASTERN MOSQUITOFISH	<i>Gambusia holbrooki</i>	I
EMERALD SHINER	<i>Notropis atherinoides</i>	N
FATHEAD MINNOW	<i>Pimephales promelas</i>	N
FRESHWATER DRUM	<i>Aplodinotrus grunniens</i>	N
GHOST SHINER	<i>Notropis buchanani</i>	N
GIZZARD SHAD	<i>Dorosoma cepedianum</i>	N
GOLDEN SHINER	<i>Notemigonus crysoleucas</i>	N
GOLDFISH	<i>Carassius auratus</i>	I
GRASS CARP	<i>Ctenopharyngodon idella</i>	I
GREEN SUNFISH	<i>Lepomis cyanellus</i>	N
GREEN SUNFISH HYBRID	<i>Lepomis hybrid</i>	N

## Ecological Integrity Baseline Conditions

---

LARGEMOUTH BASS	<i>Micropterus salmoides</i>	N
LONGNOSE GAR	<i>Lepisosteus osseus</i>	N
NILE TILAPA	<i>Oreochromis niloticus</i>	I
NORTHERN PIKE	<i>Esox lucius</i>	N
ORANGE SPOTTED SUNFISH	<i>Lepomis humilis</i>	N
ORIENTAL WEATHERFISH	<i>Misgurnus anguillicaudatus</i>	I
PUMPKINSEED	<i>Lepomis gibbosus</i>	N
PUMPKINSEED HYBRID	<i>Lepomis hybrid</i>	N
QUILLBACK	<i>Carpionodes cyprinus</i>	N
ROCK BASS	<i>Ambloplites rupestris</i>	I
ROUND GOBY	<i>Neogobius melanostomus</i>	I
SAND SHINER	<i>Notropis stramineus</i>	N
SMALLMOUTH BASS	<i>Micropterus dolomieu</i>	N
SMALLMOUTH BUFFALO	<i>Ictiobus bubalus</i>	N
SPOTFIN SHINER	<i>Cyprinella spiloptera</i>	N
THREADFIN SHAD	<i>Dorosoma petenese</i>	I
WALLEYE	<i>Stizostedion vitreum</i>	N
WARMOUTH	<i>Lepomis gulosus</i>	N
WHITE BASS	<i>Morone chrysops</i>	N
WHITE CRAPPIE	<i>Pomoxis annularis</i>	N
WHITE PERCH	<i>Morone americana</i>	I
WHITE SUCKER	<i>Catostomus commersoni</i>	N
YELLOW BASS	<i>Morone mississippiensis</i>	N
YELLOW BULLHEAD	<i>Ameiurus natalis</i>	N
YELLOW PERCH	<i>Perca flavescens</i>	N

---

The likely principal causes of the impaired fish community in the CAWS include (1) flow reversal causing the Chicago and Calumet Rivers to become the headwaters for the Illinois Waterway rather than flowing into Lake Michigan; (2) severe and widespread channelization; (3) riparian areas are functionally disconnected from the watercourses because of the vertical nature of the banks; (4) dominance of fine grained, contaminated, organic sediments rather than a mixture of coarse, clean, sediment types; and, (5) a precipitous drop in the dissolved oxygen concentration during periodic combined sewer discharges.

## Ecological Integrity Baseline Conditions

**TABLE 19. DOMINANT FISH SPECIES in  
CHICAGO AREA WATERWAY SYSTEM**

Waterway	Non-Game Fish	Game Fish
North Shore Channel	Gizzard Shad Bluntnose Minnow Golden Shiner	Pumpkinseed Bluegill Largemouth Bass
North Branch Chicago River	Gizzard Shad Spotfin Shiner Golden Shiner	Largemouth Bass Bluegill Pumpkinseed
Chicago River	Gizzard Shad Common Carp	Largemouth Bass
South Branch Chicago River	Emerald Shiner Gizzard Shad Goldfish	Largemouth Bass Bluegill
Bubbly Creek	Gizzard Shad Common Carp	Pumpkinseed Bluegill Largemouth Bass
Chicago Sanitary and Ship Canal	Gizzard Shad Bluntnose Minnow Common Carp	Pumpkinseed Bluegill Green Sunfish
Calumet River	Gizzard Shad Bluntnose Minnow	Rock Bass Smallmouth Bass Largemouth Bass
Grand Calumet River	Common Carp Gizzard Shad	
Little Calumet River	Common Carp Goldfish	Pumpkinseed Bluegill
Calumet-Sag Channel	Gizzard Shad Common Carp Bluntnose Minnow	Largemouth Bass Green Sunfish

## Ecological Integrity Baseline Conditions

**TABLE 20. FISH COMMUNITY METRICS  
for the CAWS, 2002-2009**

Waterway	Total Fish Species	Tolerant Fish Species (#, %)	Intolerant Fish Species (#, %)
North Shore Channel	27	17, 63	2, 7
North Branch	23	19, 83	0, 0
Chicago River	12	8, 67	1, 8
South Branch	16	12, 75	1, 6
Bubbly Creek	14	11, 79	0, 0
Chicago Sanitary & Ship	26	19, 73	0, 0
Calumet River	25	13, 52	3, 12
Grand Calumet River	5	4, 80	0, 0
Little Calumet River	37	22, 60	6, 16
Calumet-Sag Channel	19	14, 74	1, 5

# Ecological Integrity Baseline Conditions

---

## Literature Cited

- Butts, T. A., R. L. Evans, AND J. B. Stall. 1974. *A waste allocation study of selected streams in Illinois*. Report to Illinois Environmental Protection Agency, Urbana, Illinois.
- Duncker, J. 2011. United States Geological Survey, personal communication.
- Horowitz, A. J., 1985. *A primer on trace metal-sediment chemistry*. United States Geological Survey Water Supply Paper, 84-2277.
- IEPA (Illinois Environmental Protection Agency). 1998. *Title 35: Environmental Protection Subtitle C: water pollution, Chapter 1: Illinois Pollution Control Board*, Springfield, Illinois.
- Karr, J. R., 1991. Biological Integrity: A long-neglected aspect of water resources management. *Ecological Applications*, **1**:66-84.
- Leopold, L. B., M. G. Wolman, AND J. P. Miller. 1964. *Fluvial processes in geomorphology*. W. H. Freeman and Company, New York City, 522 pages.
- LimnoTech. 2009. *Chicago area waterway system habitat evaluation and improvement study: habitat evaluation report*. Report to the Metropolitan Water Reclamation District of Greater Chicago, Ann Arbor, Michigan.
- MacDonald, D. D., C.G. Ingersoll, AND T.A. Berger. 2000. Development and evaluation of consensus-based sediment quality guidelines for freshwater ecosystems. *Archives of Environmental Contamination and Toxicology*, **39**:20-31.
- Schlosser, I. J. 1991. Stream fish ecology: a landscape perspective. *Bioscience*, **41**:704-712.
- USEPA (United States Environmental Protection Agency). 1976. *Quality criteria for water*. Office of Water.
- USEPA (United States Environmental Protection Agency). 1986. *Quality criteria for water 1986*. Office of Water, EPA 440/5-86-001.
- USEPA (United States Environmental Protection Agency). 2000. *Ambient water quality criteria recommendations for rivers and streams in nutrient ecoregion VI*. Office of Water, EPA 822-B-00-017.





**A6. TRANSPORTATION MARKET ASSESSMENT-EXECUTIVE SUMMARY**





## Ecosystem Separation Study



## Executive Summary

Task 2.1

# Identification of Key Chicago Shipping and Logistics Market Drivers

Prepared for

**HDR**

Prepared by

**VICKERMAN**  
& ASSOCIATES, LLC

November 8, 2011

No Distribution of this *Identification of Key Chicago Shipping and Logistics Market Drivers Report* is permitted unless authorized with the expressed written permission of HDR and Vickerman & Associates

# Shipping Trends

## Container Growth

Containerized shipments make up the largest promotion of world trade. This form of shipping is forecasted to continue to grow and be the dominate method of trade

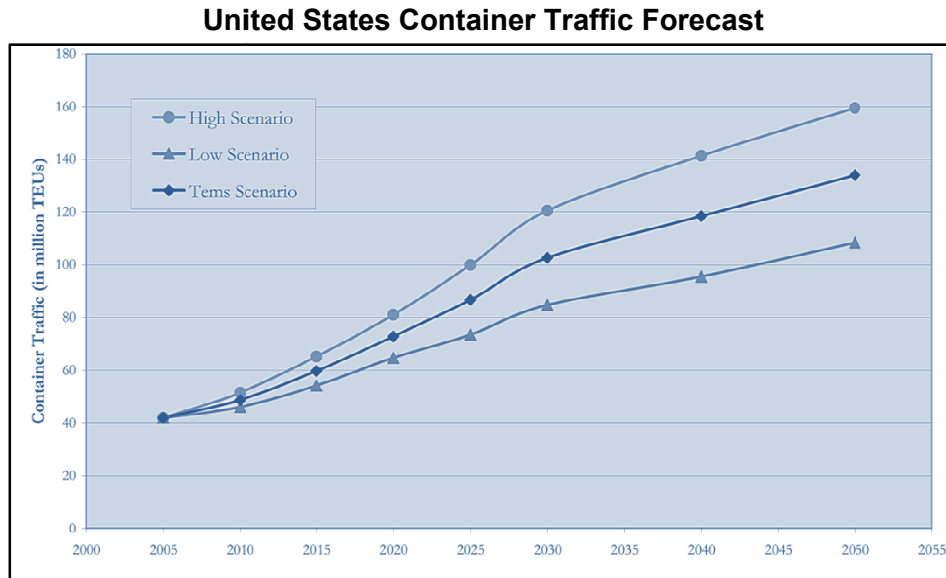

Source: GLSLS Market Assessment Study, January 2007

As forecasted by the Maritime Administration National Advisory Council:

*“Container volume is expected to more than double in the next 20 years, and nearly all non-bulk cargo will be containerized. Ports must plan now to ensure that they have the people, training, technology, transportation, assets, and the infrastructure to provide efficient and reliable transportation services.*

*Solutions must be flexible to accommodate changes that will inevitably occur.”*

A U.S. Maritime Report states:

*“Projected growth in the U.S. economy and historic trends at U.S. ports suggests that port container traffic will double by 2020 and triple by 2030. This may occur even if the average annual rate of growth in container traffic falls from the 1950-2006 average of 6.4% ... to 5%. Even if the growth rate falls to 4%, container traffic could still more than double by 2030.”*

## Nation’s transportation network

Through 2035, the mix by transportation type is forecasted to show little change, however the forecasted growth is big, placing pressure on the domestic transportation network and on all modes of transportation.

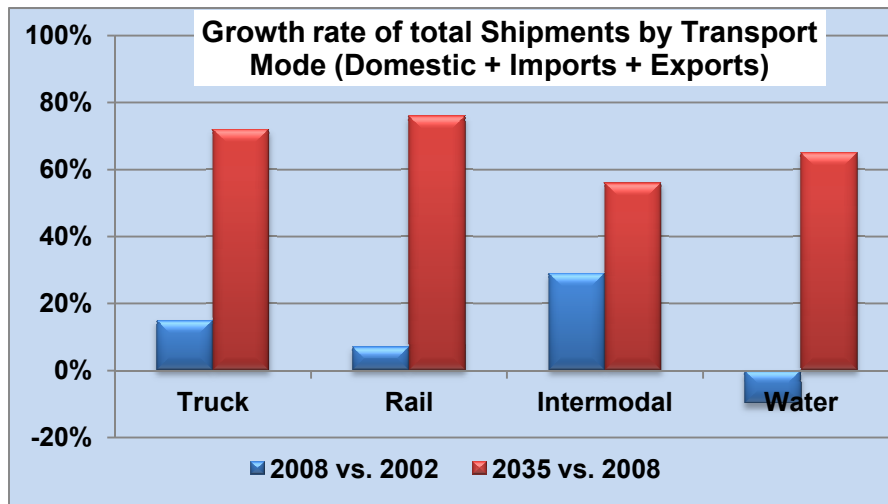
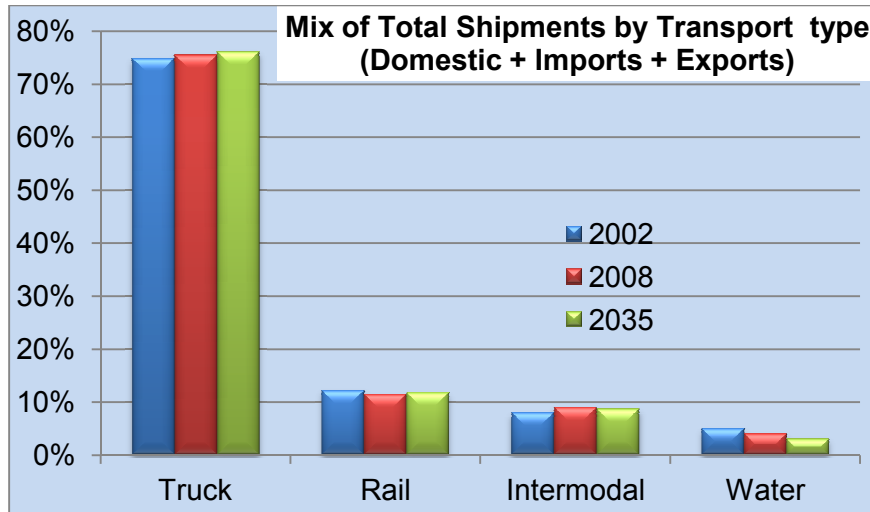

**Intermodal Growth**

Rail intermodal is the long-haul movement of shipping containers or truck trailers by rail, combined with a (usually much shorter) truck movement at one or both ends. Today intermodal accounts for approximately 21 percent of US rail revenue, second only to coal among all rail traffic segments.

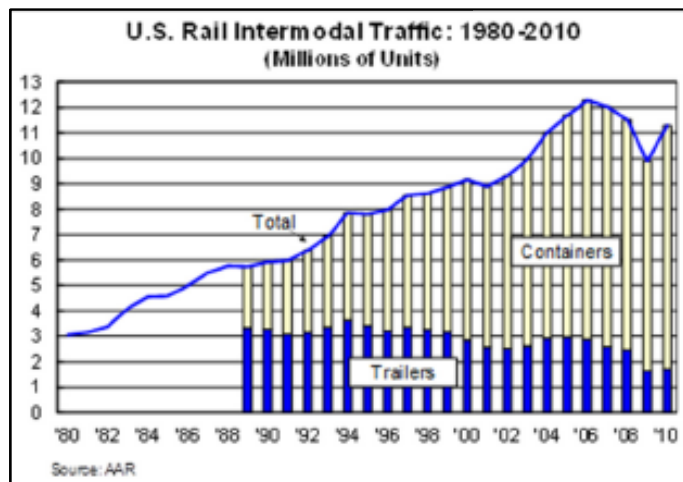

Source: AAR Economics Department

In the next few years, intermodal infrastructures have a chance to change and grow, primarily in response to the widening of the Panama Canal. The changes are dependent on the success of two aspects:

- The success of container on barge developments (including short sea shipping). Plus, the success of the proposed marine highway corridors will serve the nation's interior from Gulf Coast ports
- Short haul intermodal rail, which will serve as reverse mini land bridges from East Coast Ports to inland ports. Reverse Mini Rail Land bridges serve the reverse role of the current trans-continental land bridge for containers to/from Asia, except on a smaller scale. Instead of calling on West Coast ports, containers are shipped through the Panama Canal to the East Coast or Gulf Ports and then shipped by rail or truck to a mid-country market.

### Marine Highway Corridors



Public (government) interest in container barge services is growing, as is evident from the Maritime Administration's (MARAD) Marine Highways Program, which was fully implemented in April 2010. The Marine Highway Corridor routes consist of 11 Corridors, 4 Connectors, and 3 Crossings that can serve as extensions of the surface transportation system. These corridors identify routes where water transportation presents an opportunity to offer relief to landside corridors that suffer from traffic congestion, excessive air emissions or other environmental concerns and other challenges. Secretary LaHood has taken the first step to focus public and private efforts to use the waterways to relieve landside congestion and attain other benefits that waterborne transportation can offer in the form of reduced greenhouse gas



emissions, energy savings and increased system resiliency. Marine Highways present a unique opportunity for developing container load centers that can offer a triple play of intermodal services: truck – rail - barge.

Two proposed Marine Highway Corridors could have a direct effect on the Chicago transportation system.

1. The M-55 Corridor

**Landside Corridor Served:** Interstate-55

**Corridor Description:**

The M-55 Corridor includes the Mississippi and Illinois Rivers from New Orleans, LA, via St. Louis, MO, to Chicago, IL, through Louisiana, Mississippi, Arkansas, Tennessee, Missouri, and Illinois. It includes connecting commercial navigation channels, ports, and harbors. It connects to the M-90 corridor at Chicago, the M-40 Connector at Napoleon, AR, crosses the M-70 Corridor at St. Louis, MO, and meets the M-10 Corridor at New Orleans, LA.

**Attributes:**

At 2,348 miles in length, the Mississippi River is the 2nd longest river in the United States and 92 percent of the nation's agricultural exports are produced in its basin. Sixty percent of all U.S. grain exports move on the Mississippi River and the largest port in the United States (by tonnage) is located on the Mississippi at LaPlace, LA. The Port of New Orleans handled 229,067 containers (TEUs) in 2008, most of which also move inland on truck and rail.

The U.S. Department of Transportation indicates that this corridor is plagued with major freight truck bottlenecks at several points along its route, including the metropolitan areas of Chicago, St. Louis, Baton Rouge, and New Orleans, causing millions of hours in truck delay each year. In addition, the Department found that freight rail congestion is problematic for both in the Chicago and St. Louis areas. Even in rural segments, traffic studies on portions of I-55 in Southeast Missouri found that trucks account for approximately 50 percent of all daily vehicle movements.

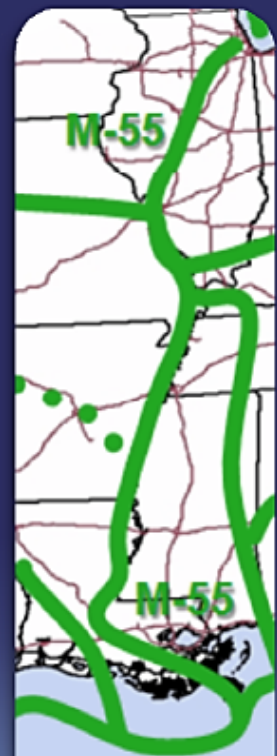

## 2. The M-90 Corridor

**Landside Corridors Served:** Interstate-90 (Also Interstates-80 and 94)

**Corridor Description:**

The M-90 Corridor is the Great Lakes, Erie Canal, and connecting commercial navigation channels, ports, and harbors from Albany, NY to Chicago, IL and Duluth, MN. It spans New York, Pennsylvania, Ohio, Indiana, Illinois, Michigan, and Wisconsin. It connects to the M-75 Detroit/Windsor Crossing near Detroit, MI, and the M-71/77 Lake Erie Crossing near Cleveland, OH.

**Attributes:**

I-90 is already experiencing major freight truck bottlenecks at several points and is expected to rank seventh in the nation for freight truck vehicle miles traveled by 2020. Similarly, I-80 also suffers major freight truck bottlenecks and is Ohio's top freight truck corridor based on vehicle miles traveled. It will represent approximately 20 percent of the State's daily truck traffic by 2020.

The corresponding Marine Highway Corridor provides benefits to both I-90 and I-80 and offers virtually unlimited capacity between from Western Lake Superior to the East Coast via the Saint Lawrence Seaway. Numerous vessel services currently utilize this corridor, but their container and trailer volumes are at present limited. New and expanded waterborne services offer the opportunity to absorb some of the future traffic congestion forecast for the corresponding landside corridor. In addition, while currently handling limited volumes of freight, the Erie Canal could provide a link between the Great Lakes and East Coast via the M-87 Connector between Buffalo and Albany, NY.

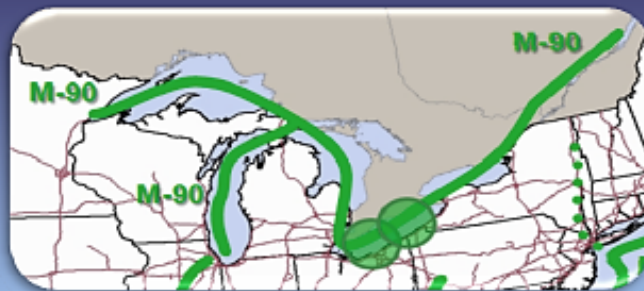

## Reverse Land Bridge

A recent set of investments made by eastern and central railroads form the foundation for the development of reverse landbridge services:

Examples of Reverse Landbridge Services from the East Coast and Gulf Coast (Rno Group)



The 1,200-mile Heartland Corridor routes Norfolk Southern trains from Norfolk, through Roanoke, Columbus, and Northwest Indiana to Chicago.



# America's Waterways

## The Great Lakes Saint Lawrence System (GLSLS)

The GLSLS provides a 2,300 mile system stretching from, the Gulf of the St Lawrence River to both the industrial heartland of the Midwest, Central Canada and the agricultural and natural resource areas of the Great Plains and Prairies. It serves more than 30 ports between the Gulf and Duluth. The Seaway has long played a role as a vital transportation link for this region's rapidly expanding and dynamic economy. The GLSLS has six canals incorporating 19 major sets of locks. These locks, however, limit the size and speed of vessels that can use the system. The maximum size of vessels that can use the locks is 740 feet long, 78 feet wide, and a draft of 30 feet.



In the past 10 years, the GLSLS has experience little to no growth in either tonnage, or transits. Historically the GLSLS has largely been focused on bulk traffic such as grain, coal, and ores. But this traffic has shown no growth in the past 10 years.

St. Lawrence Seaway Vessel Transits

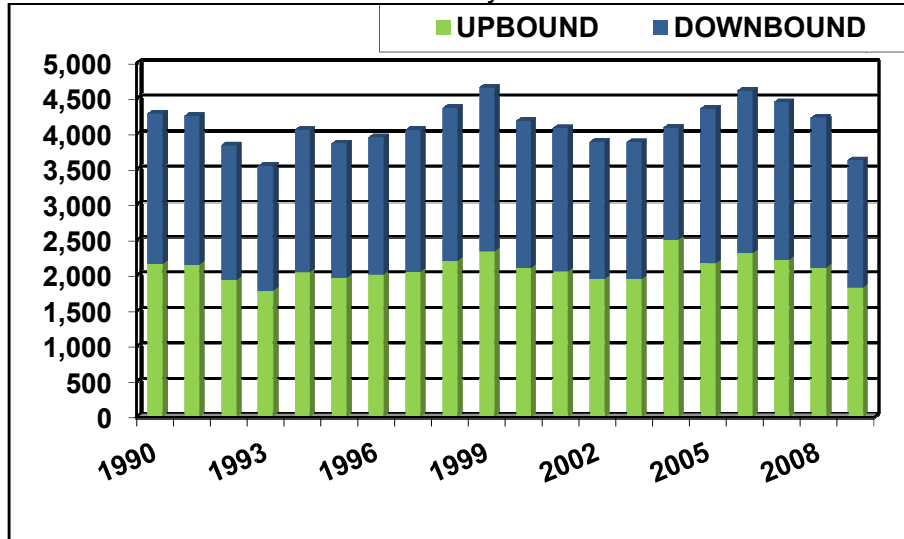



**International cargo/seaway transits have shown no growth over time**

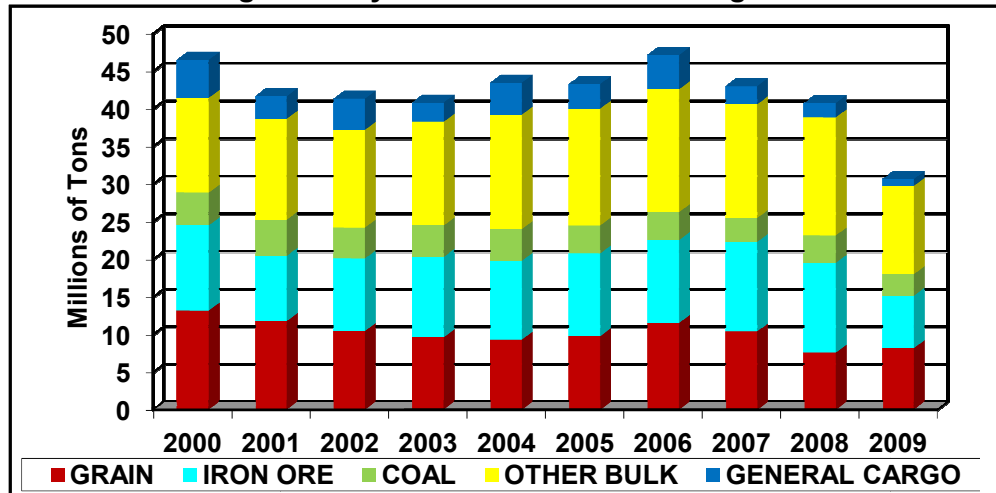

Source: Martin /Vickerman Report (Feb 2011)

While the Seaway moves over 200 million tons of traffic each year, more than 90% of its cargo is bulk traffic and most of the rest is neobulk such as steel. Very little container traffic moves on the GLSLS.

It takes about 10 days for a ship to go from one end of the System to the other end, while it only takes rail or truck no more than 3 or 4 days. In addition, rail operators have improved their competitive position in the last ten years by introducing intermodal double stack train operations.

The GLSLS bi-national region has about ½ the population of the U.S. and Canada, who are settled on less than 20% of the land area of Canada and the United States. It covers one of the world’s largest manufacturing and consumer markets. The area generates nearly half of the U.S. and Canadian GDP and dominates the continent’s service and manufacturing industries. In terms of the region’s growth, the demographic and economic trends that are projected through 2050 suggest that the economy will continue to grow and expand in line with historic rates. This means a doubling of the region’s GDP by 2050

The region’s emerging New Economy is heavily dependent on trade. The expansion of trade with all parts of the world is changing the fundamental charter of the GLSLS regional economy and its need for supporting transportation services.

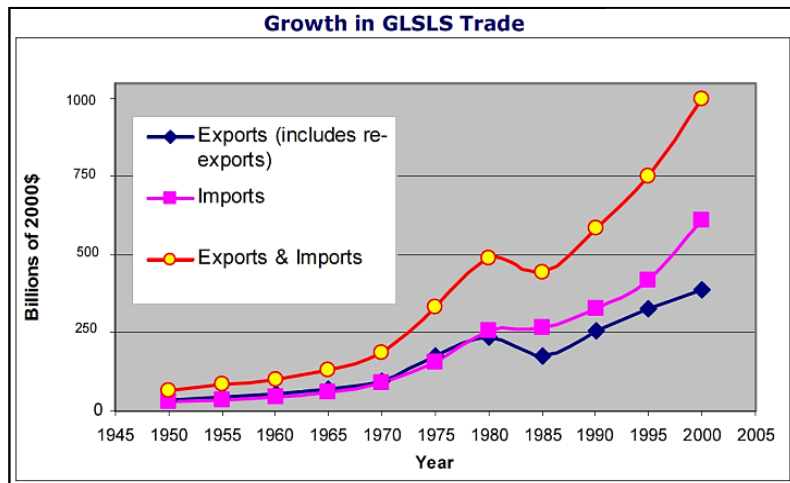

As the region's population, employment, GDP, and trade are projected to grow significantly through 2050, the regions freight traffic is expected to expand at an even faster rate (2007 Maritime Administration Report). It is anticipated that a growing share of traffic moved by all modes of transportation will be by containers. The total market for container traffic to and from the region is expected to more than double by 2050. But this growth will

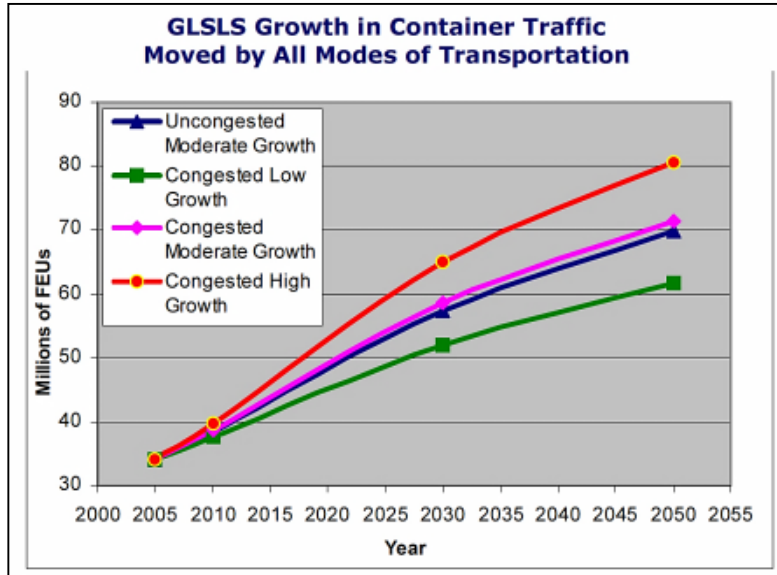

create issues. Today and in the future, trucks will move a significant amount of containerized freight (98% in 2005), followed by rail at 2%. However, available highway and rail capacity is suffering from deteriorating levels of service. As a result, moving containers by truck and rail in the future will cost more and as a result take longer, since traffic is expected to outgrow any improvements in capacity, and congestion is expected to increase.

The net effect of this continued economic growth, and capacity limitations on the GLSLS region's highways and railroads is an increased potential of water to play a role in the transportation of container and palletized traffic.

In the region, if the highway infrastructure is not able to absorb the 88% increase in road freight traffic, due to the inability to mitigate bottlenecks, both water and rail traffic could increase. In the case of water it can grow to as much as an 8% share without reaching GLSLS waterway capacity restrictions.

**The Great Lakes**



The Great Lakes have shaped the culture, history, and economy of the eight states that border the freshwater seas. The Great Lakes provide a competitive advantage for business and support fantastic recreational opportunities that help attract talented workers to the region.

A Michigan Sea Grant Study (2010) analysis of economic data shows that more than 1.5 million jobs are directly connected to the Great Lakes, generating \$62 billion in wages.

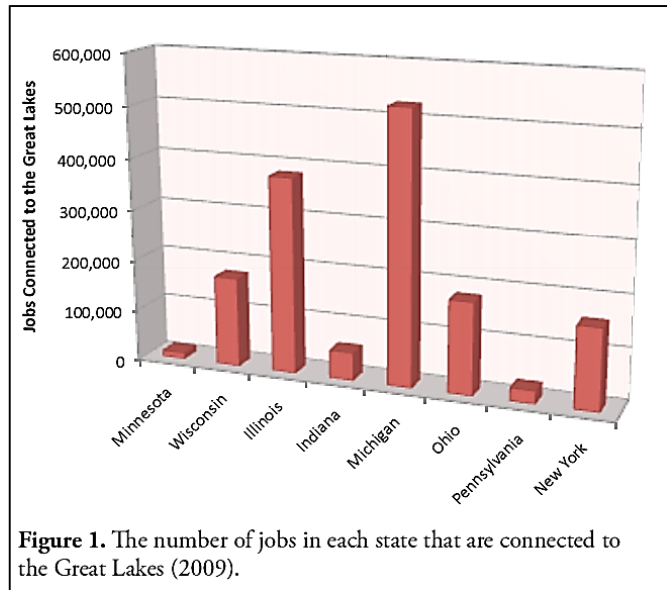

Great Lakes vessels transport an average of 163 million tons of cargo each year. Lake vessels can ship goods three times more efficiently than rail, and 10 times more efficient than trucks, which gives mining, manufacturing and agriculture in the region a competitive edge. Many of the transportation routes are multi-modal and involve transfers among lake-bound and international vessels, rail and trucks.

However, tonnage traffic on the Great Lakes is not increasing. The dominate type of tonnage shipping is traffic between United States ports on the Great Lakes System. Coal and crude materials are the largest waterbourne tonnage item.

Great Lakes (short ton) traffic trends

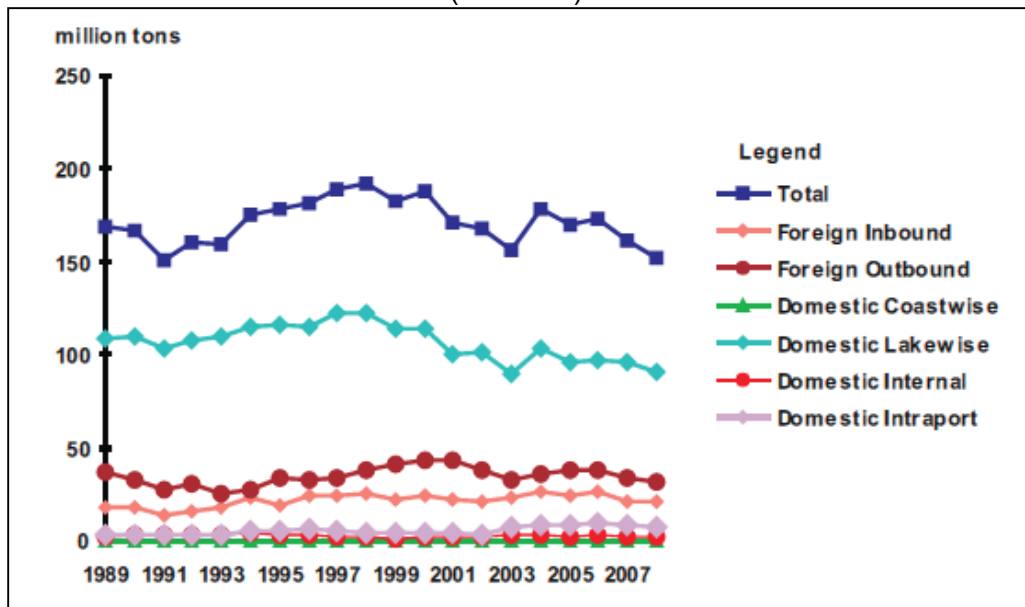

Source: Waterborne Commerce of the United States



## The Advantages of Inland Water Transportation

America's inland river barge system moves freight more safely and more efficiently than rail or truck. It is a key component of the transportation network and essential to our country's economic strength.

Water ports, by nature, are intermodal. Freight traveling by water must arrive and depart by another transportation mode. Intermodal connectors are roads that provide access to water ports or rail services. Truck congestion on or near the intermodal connections affects ports that rely on trucks for commodity transfer. Improvements to roadways that connect to ports increase the efficiency of ports, benefit trade, and contribute to employment growth and regional productivity.

Transporting freight by water is the most efficient energy choice. Barges move a ton of cargo 576 miles per gallon of fuel. A rail car would move the same ton of cargo 413 miles, and a truck only 155 miles. A river barge can travel as far on a tablespoon of fuel as a train on a cup or a truck on a gallon!

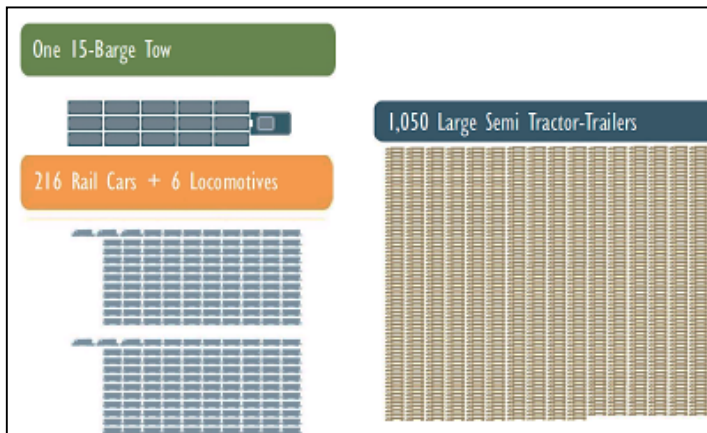
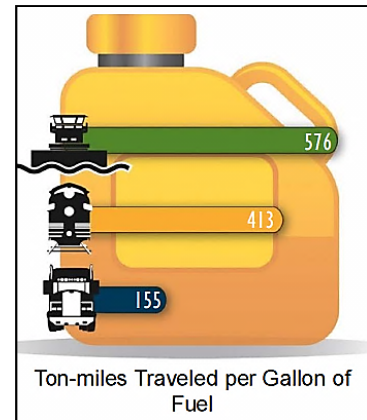

One 15-barge tow equals 216 rail cars or 1,050 trucks

## The Inland Waterway in the U.S.

The inland waterways system includes about 12,000 miles of commercially navigable channels and some 240-lock sites. America's waterways transport more than 60% of the nation's grain exports, about 22% of domestic petroleum and petroleum products, and 20% of the coal used in electricity generation. Every year, roughly 624 million tons of waterborne cargo transit the inland waterways, a volume equal to about 14% of all intercity freight and valued at nearly \$70 billion. The annual traffic on America's inland navigation system, including the Gulf Intracoastal Waterway and the Ohio, Mississippi and Columbia-Snake River systems carries the equivalent of 58 million truck trips each year.



Composition of Internal Tonnage by Waterway

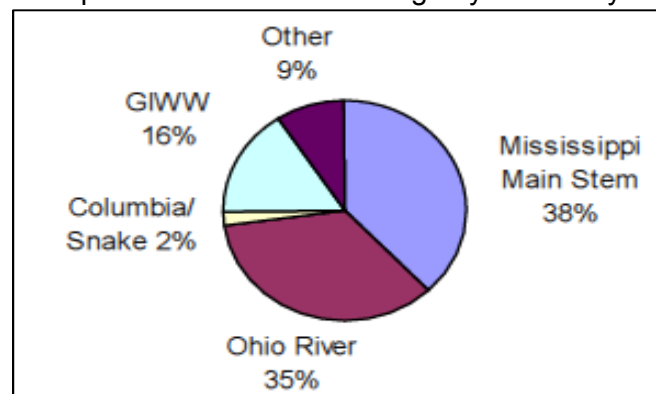

## The Mississippi and Ohio waterway system

The Mississippi River System and the Gulf Intracoastal Waterway serve thirty-one states. States on the Gulf Coast and throughout the Midwest and Ohio Valley especially depend on the inland and intracoastal waterways. Texas and Louisiana each ship over \$10 billion worth of cargo annually, while Illinois, Pennsylvania, West Virginia, Kentucky, Mississippi, and Alabama each ship between \$2 billion and \$10 billion annually.

The map below shows the level to which the various states use the waterway system.

Value of IWW Cargo by State

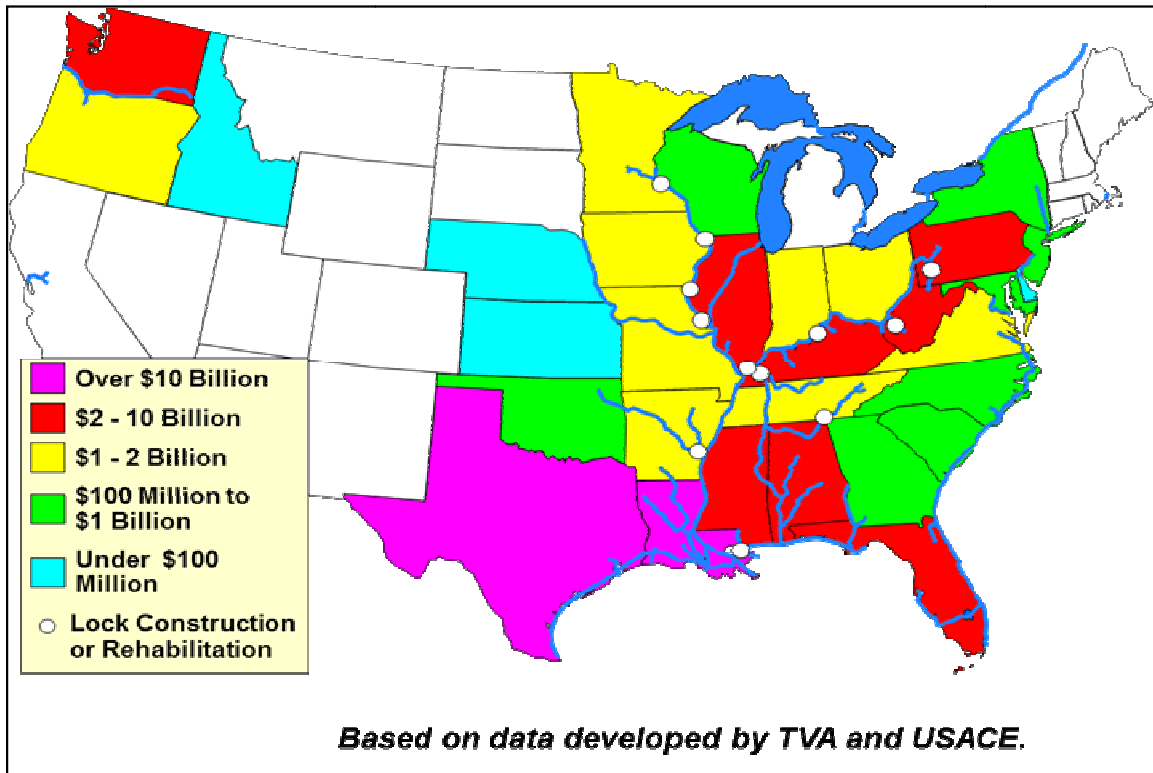

Internal Waterway traffic (vessel traffic that takes place solely on internal US waterways) has shown little growth over the past 20 years.

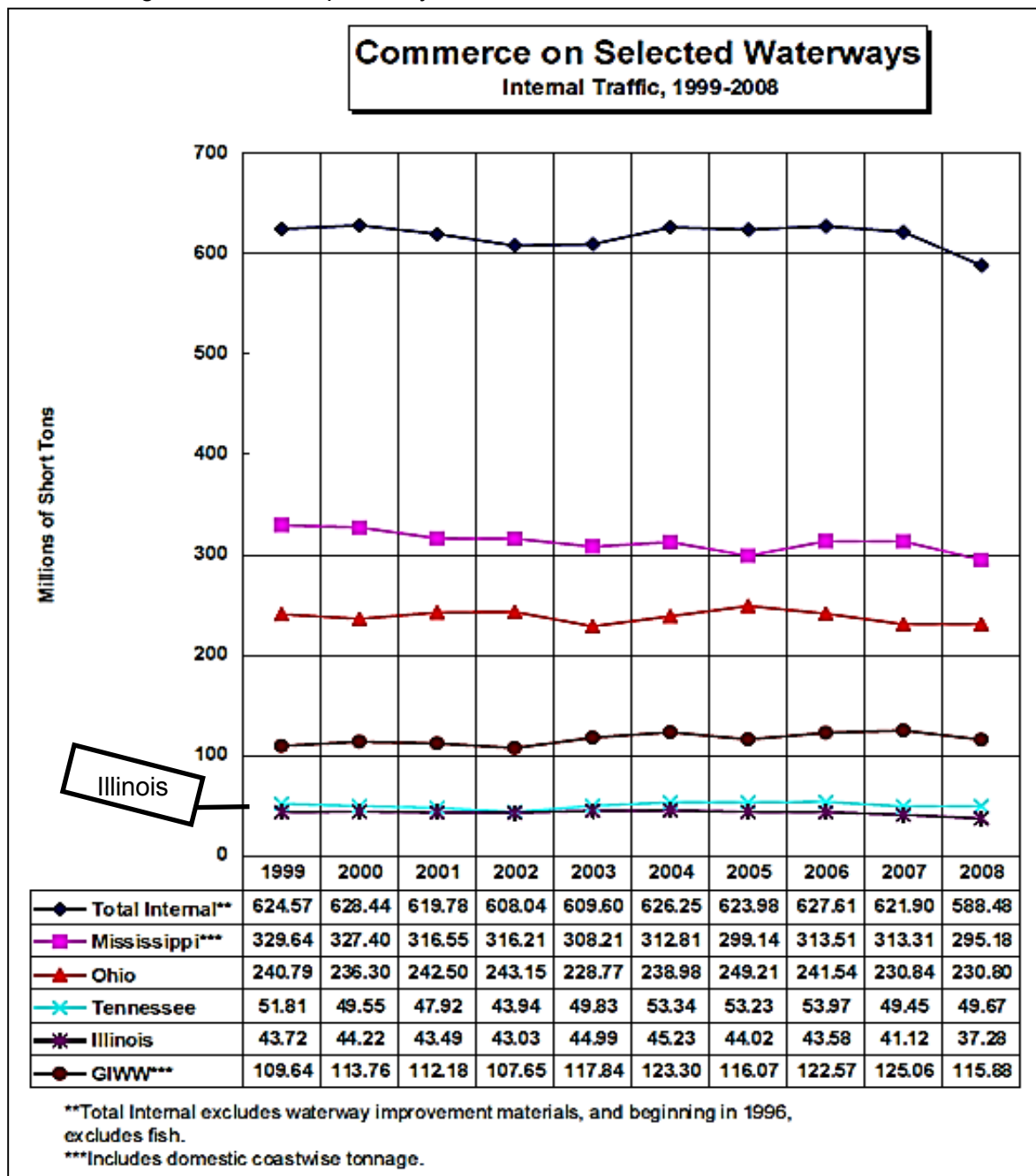

### Inland Waterway system issues

The world's preeminent inland navigation system, and waterway's reliability is increasingly threatened by the passage of time and the need to invest in improvement. The economic service life for navigation structures is typically 50 years and is usually extended through major rehabilitation to 75 years. Currently, 54 percent of the waterway structures are more than 50 years old and 36 percent are more than 70 years old. There are currently some projects under

construction, and some of these have had significant cost increases and schedule delays. Because of the strong industry and congressional support during the past decade for improving the efficiency of construction, lowering the costs of construction, and achieving the completed projects' benefits as early as possible, the surplus in the IWTF (Inland Waterway Trust Fund) has been spent down. Annual funding for system modernization is now limited to revenues as they are generated each year. This reality has contributed to increasing the backlog of needed improvements, both for new construction and major rehabilitation. For example, projects at 17 facilities have been authorized, but they have not yet received funding for construction.

What would happen if the Mississippi and Illinois Rivers were shut down in the vicinity of St Louis? Using the Federal Highway Administration's HERS ST model, the Texas Transportation Institute estimated the resulting impacts of shifting millions of tons of cargo from the river system to the city's already crowded Interstate arteries.

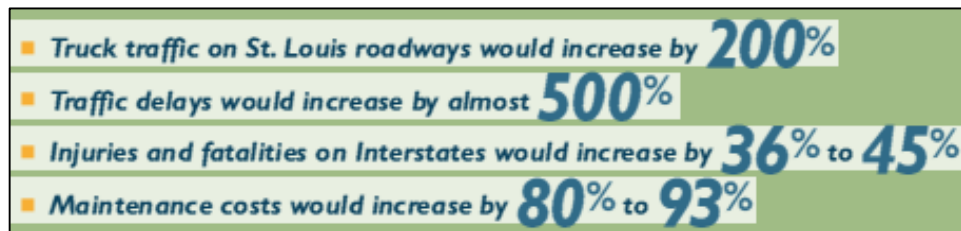

Assuming that cost-effective roadway improvements were undertaken, the analysis concluded that highway costs, over 10 years, would increase from \$345 million to over \$721 million. The case study clearly demonstrates that the loss of river transportation would have a dramatic negative impact.

**Can the role of the both the Seaway and the U.S. Inland Waterway System be expanded to include container shipments.**

Given that in Europe and elsewhere considerable container traffic moves by water, the question arises as to whether or not the GLSLS and the Inland waterway system is fulfilling its potential and whether or not there are additional roles that they might play as part of the North American Transportation System.

Containers move finished or semi-finished products in a "just in time" environment, which has made container traffic a highly time-sensitive payload what would be attracted to the waterways only if they offered competitive rates and transit times.

Typically, water transportation has been able to offer the lowest price. But while price dominates bulk transportation, it is far less important in the movement of container traffic in which transit time and a wide range of other services play a major role. With bulk traffic the focus is on the lowest rate per ton. In the case of container traffic, the focus is on transit times and the ability to reach certain markets by a given deadline. As a result, for container water shipments whose transit times are slower than truck and rail, it will be important to obtain the maximum economies of scale possible by boosting capacity as much as possible to minimize the average cost per container moved by water.

An area where container traffic might be able to expand under the current conditions on the waterways is where, as is the case of bulk cargo, the capacity limitations of the existing rail and

truck networks become problematic. In this environment an improved waterway container system would generate opportunities.

In terms of long term change and growth, container traffic offers the greatest opportunity. Container traffic is growing very rapidly while the demand for bulk cargo is much lower. The projected annual growth rates for container traffic range between 4 and 6% and even higher, whereas it is only 1 to 2 percent for bulk cargo (Great Lakes-St. Lawrence Seaway Market Assessment Report, 2007).

## The Greater Chicago Transportation Network

Indiana Freight and Transportation ...the Northwest Regional area of the State.

Freight is brought into and out of Northwest Indiana using a variety of modes. Trucking is the dominant mode, with over 60% of both inbound and outbound freight by value.

Mode of Travel for Inbound and Outbound Freight, by Value 2008

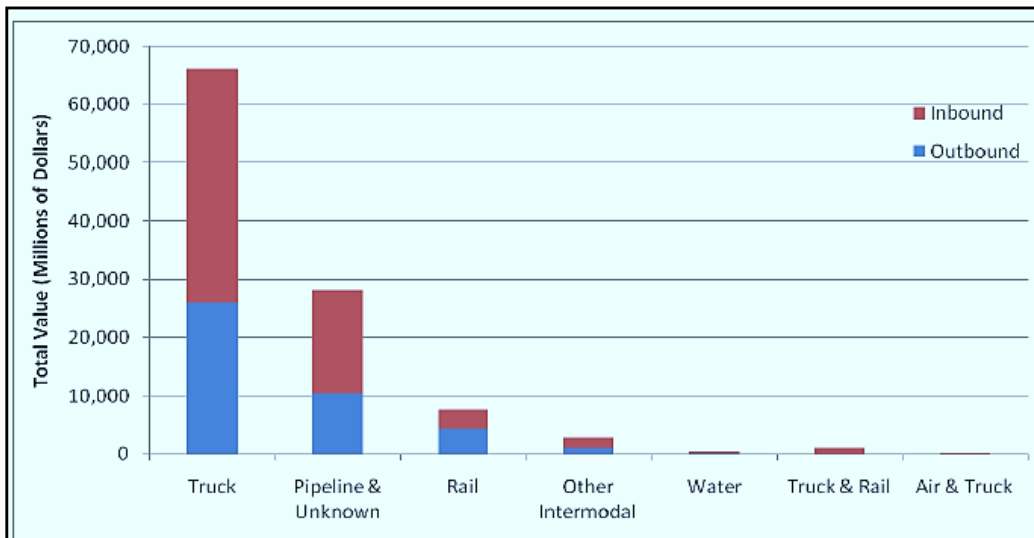

Source: NIRPC, August 2010 Freight Study (8)

The total value of combined inbound and outbound shipments is expected to nearly double between 2008 and 2035. The truck share of freight movements is projected to grow from about 62% in 2008 to 66% in 2035.



Projected Growth in Freight Movements, by Value and Mode, 2008 to 2035

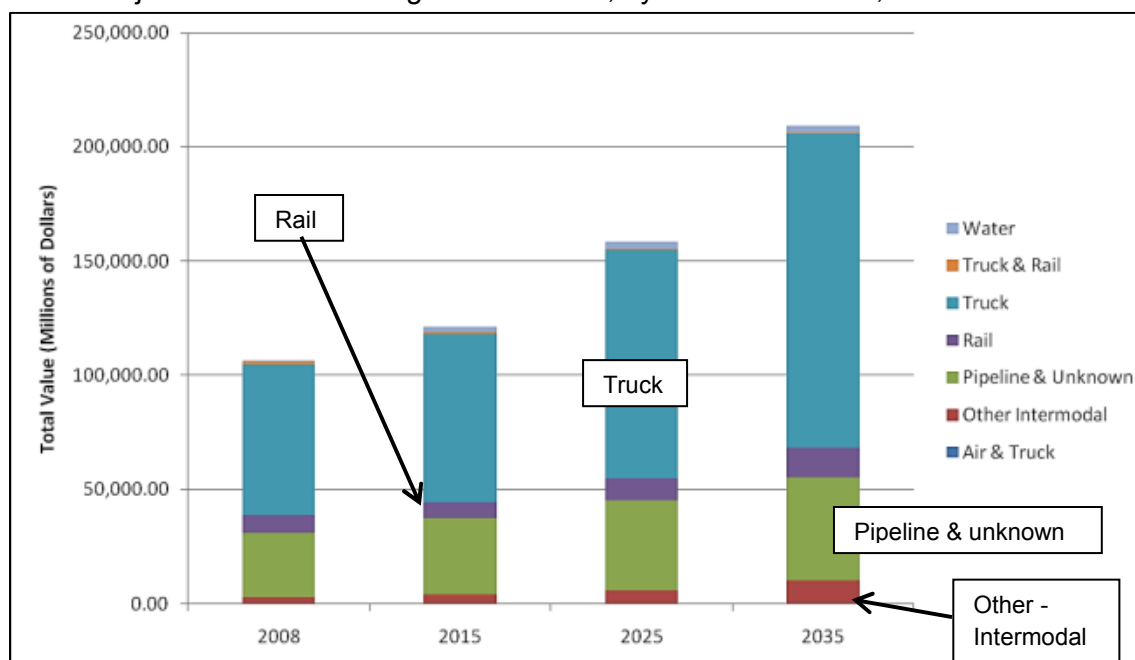

Indiana ranks 14th in the nation for waterborne shipping. The State ships 70 million tons of cargo by water each year. More than half of Indiana’s border is water. Indiana has 400 miles of coastline on the Ohio River and Lake Michigan, each of which is part of the country’s two largest shipping arteries – the Inland Waterway System and the Great Lakes/St. Lawrence Seaway. The Ports of Indiana have direct access to two U.S. Coasts – the Atlantic to the east and the Gulf to the south.

A Northwester Indiana Regional Planning Commission document (updated August 2010) states the region should consider how to shift more freight to the water mode to reduce congestion on the highways. The study also suggests looking at developing a short-sea program on the Great Lakes. Harbors such as Milwaukee and Muskegon could potentially be served by regular lake barge service. However, “it might be difficult to offer freight rates competitive with trucking”. “Some type of incentive that makes water more financially competitive will be critical to affecting any significant mode shift to water”.

### The State of Illinois

Illinois is the freight capital of the North America. Its central location and dense network of road, rail, and air facilities make it an ideal location from which to move, store, and distribute goods. Even without an international border or seaport, it is a major hub for trade. The State is the sixth largest in terms of total water commerce and the second largest for domestic shipping.





## Chicago Area ...a transportation hub

Chicago ---

- Is the third largest intermodal port in the World, behind Hong Kong and Singapore.
- Provides a transportation system where one third of rail and truck traffic – and half the nation’s container traffic – passes through.
- Is the single largest rail transfer center in the United States
- Is the 5th largest inland intermodal center in the world
- 78 rail terminals sort and distribute rail carloads and intermodal containers
- Is the only city in North America served by all six Class-One railroad companies,
- Is the trucking capital of the U.S. with 200 truck terminals

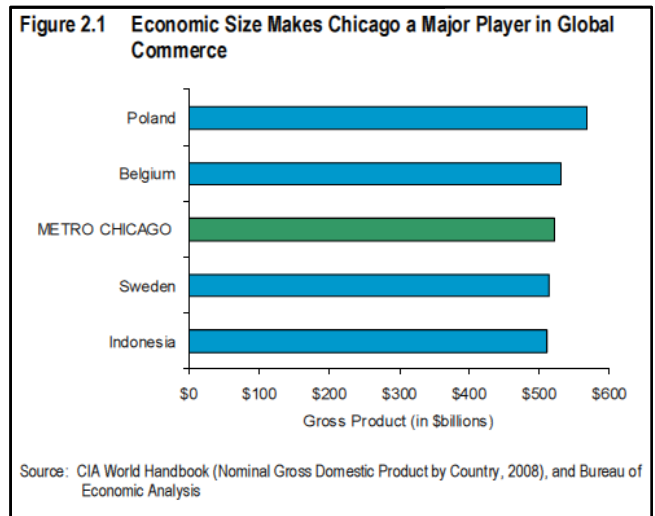

In 2005, the Chicago and the Los Angeles BEAs were by far the largest container markets. Chicago is by far the largest market for terminating containers. The top 10 BEAs comprised 70% of the total U.S. market for rail terminations of containers in 2005.

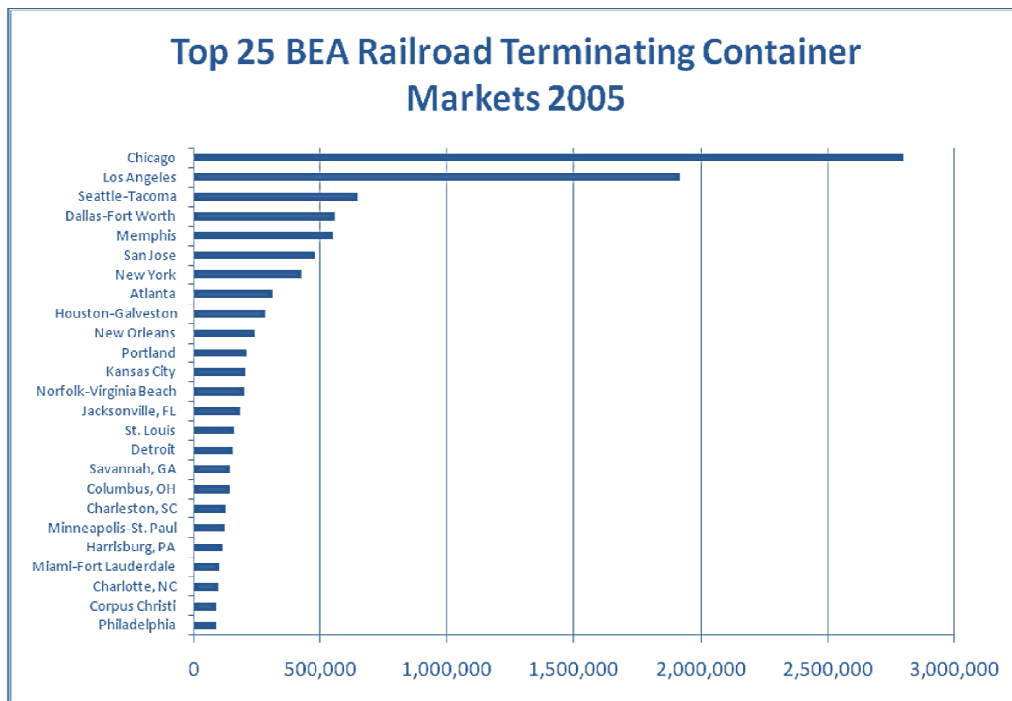

Figure 6.2.2 Top 25 BEA Markets for Railroad Terminating Containers, 2005.

## Rail

Greater Chicago's status as a freight hub is in part due to its geographical position as a lynchpin between U.S. coastal markets. It is also due to a lengthy tradition of long-range visioning, a recognition that investment in infrastructure will spur industry, and the belief that the Chicago region is now and will continue to be the heart of America.

Chicago's status as a national freight hub depends on access to intermodal facilities. Approximately one-half of all intermodal facilities are within one half-mile of the class I railroads.

Chicago's 21 intermodal freight hubs, which are operated by six rail companies, are becoming congested with no land to expand. The yards are being consolidated outside the traditional eight County Greater Chicago Metro Chicago Region to reduce costs and to improve the thru put of containers in and out of the freight hubs. (CMAP report)

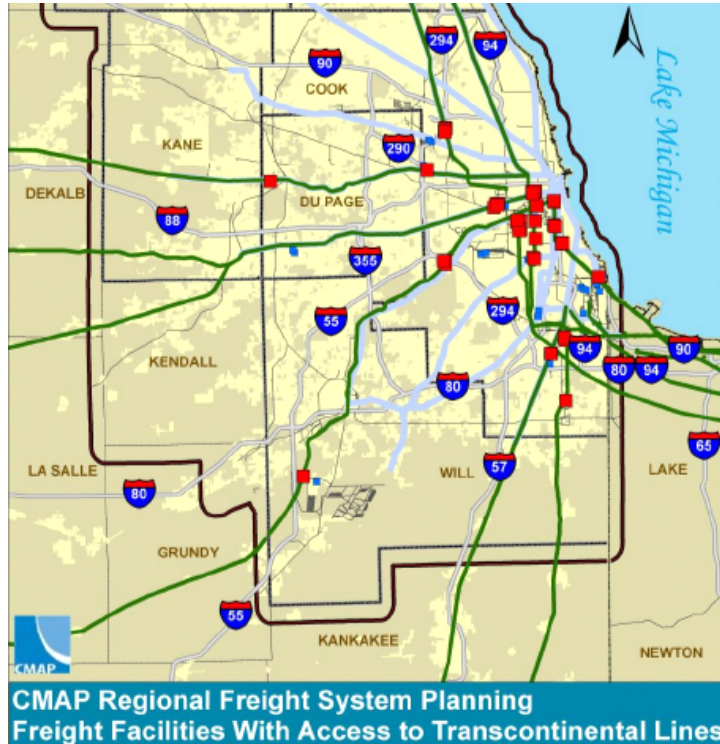

Within the Chicago region, coal is the largest single commodity moving on the rail network in the Chicago region. General freight, including intermodal containers, is the second largest commodity in total tonnage and is anticipated to have the greatest increase by the year 2040, growing by over 240 percent.

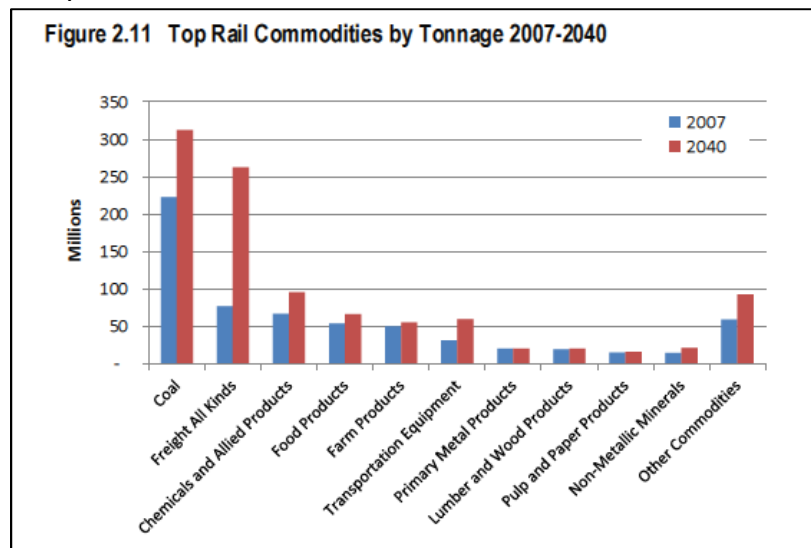

## **Chicago area Ports and Waterbourn Freight**

Chicago is positioned geographically as a gateway between the Great Lakes and the Mississippi River. The Mississippi River has the highest waterborne freight flows on its segment between St. Louis and the Gulf of Mexico; but there is a substantial drop-off in tonnage flows into greater Chicago. Despite Chicago's competitive geographic location for other modes of freight, and its seemingly high availability of port facilities, the region does not serve as a key hub for national waterbourn freight.

“Current freight movements and forecasted freight movements via water show that the maritime network appears to be underutilized, given the high amount of capacity for the region (both inland waterways and on the Great Lakes with access to the St Lawrence Seaway) and the region's reliance on heavier commodities such as steel manufacturing inputs, agricultural products and byproducts, and construction materials.”

The Chicago area ports are some of the largest tonnage ports in the United States. Crude materials are the largest commodity in traffic size followed by coal and coke. A third of the commodities are shipped out of the greater Chicago area

This waterborne freight tends to consist almost exclusively of relatively heavy, low value goods that are less time sensitive than freight carried by other modes. Of the 73 million tons of waterborne freight moved in the Chicago region in 2007

- 60% was inbound to destinations in the area
- 26% were outbound
- 12% was moving between points within the area

Over the next 30 years --- (Cambridge Systematics)

- Inbound tonnage is projected to decline by approximately 25%
- Outbound tonnage is expected to grow by 70%
- Local movements are projected to grow slowly climbing 24%

Chicago is not an ideal location for water import / export business. It is much easier for businesses to locate near the deep-water seaports. However, there is some volume of exports from the Great Lakes to Montreal, with trans loading to ocean ships.

Currently the Port of Chicago and barge operators see little potential for large-scale movement of intermodal containers on barges through the Great Lakes. The restrictions to Great Lakes growth and shipping containers on Great Lakes vessels are created by the St. Lawrence Seaway, whose locks are only 800 feet long and 80 feet wide. Even the smallest container ships do not fit through the seaway.

**U.S. Port Rankings based on Short Ton Volume**

Port	Total Trade Rank	Total Domestic Trade Rank	Foreign Trade Rank		
			Imports	Exports	Total Foreign Trade
Chicago	36	18	45	50	48
Indiana Harbor	51	35	87	93	94
Gary	62	43	80	98	99

Source: U.S. Army Corps of Engineers

**The Illinois River and Lock System**

The Illinois Waterway system has nine single chamber lock, and dam projects. The seven projects on the main part of the waterway have single 110 by 600 foot lock chambers and are over 60 years old. The Thomas O'Brien Lock and the dam on the Calumet River have a 110 by 1000-foot chamber. The Chicago Lock is an 80 by 600 foot lock chamber in the Chicago Harbor Channel. Most barge traffic moving to and from Lake Michigan uses the O'Brien Lock.

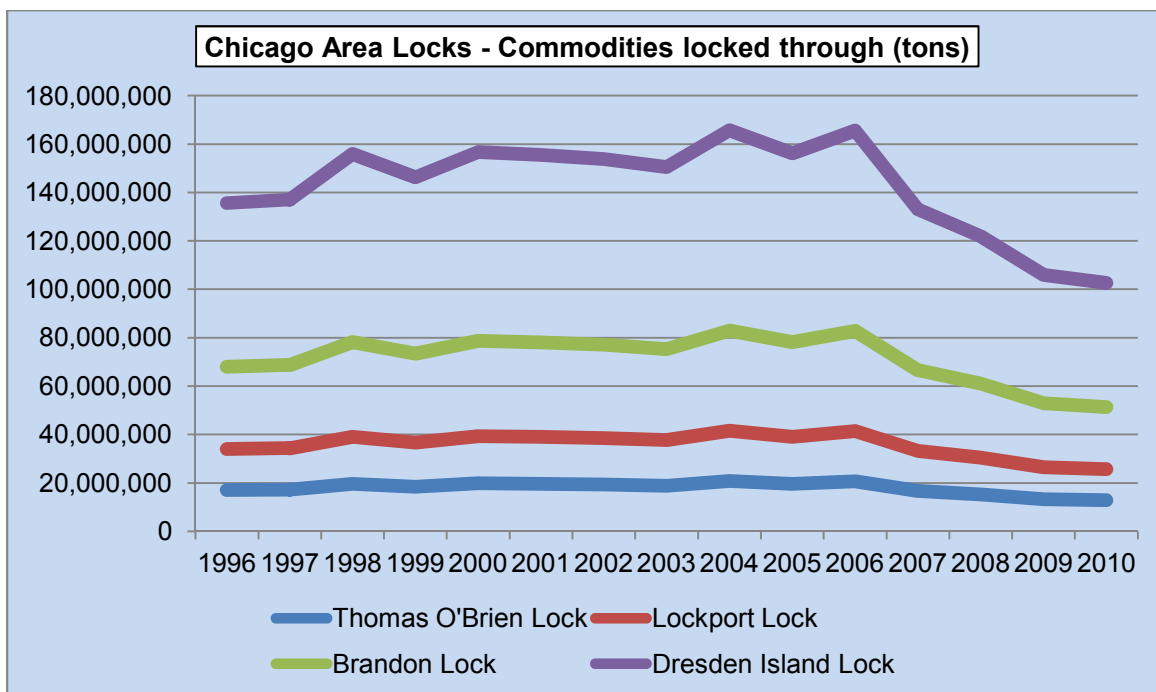

Source: U.S. Army Corp of Engineers

Like much of the U.S. transportation system, the water infrastructures (i.e. locks) in the region were built many decades ago and today have many deficiencies. Watercraft that use the locks in Will County and beyond face average delays of at least 50 minutes per lock. As a result, freight delays quickly add up and are costly for the freight shippers.



## Forecasted Trade Growth will force changes in how the Chicago area moves product.

### Freight volume ... volumes will continue to grow within the Chicago area

Water, rail, and truck freight volumes are projected to grow between now and 2040. This projected growth rate by Global Insight for the 7-county area shows additional transportation infrastructures will be required.

		<u>Inbound Tons</u>	<u>Outbound Tons</u>	<u>Through Traffic Tons</u>	<u>Total Tons</u>
<b>Water Freight</b>	<b>2007</b>	7,344,000	10,087,000	882,000	18,313,000
	<b>2040 forecast</b>	10,591,000	14,195,000	1,205,000	25,991,000
	<b>% Change</b>	<b>44%</b>	<b>41%</b>	<b>37%</b>	<b>42%</b>
<b>Rail Services (carload services plus intermodal)</b>	<b>2007</b>	162,081,000	110,956,000	11,506,000	284,543,000
	<b>2040 forecast</b>	306,897,000	233,830,000	424,174,000	964,901,000
	<b>% Change</b>	<b>89%</b>	<b>111%</b>	<b>3587%</b>	<b>239%</b>

Source: CMAP, Global Insight

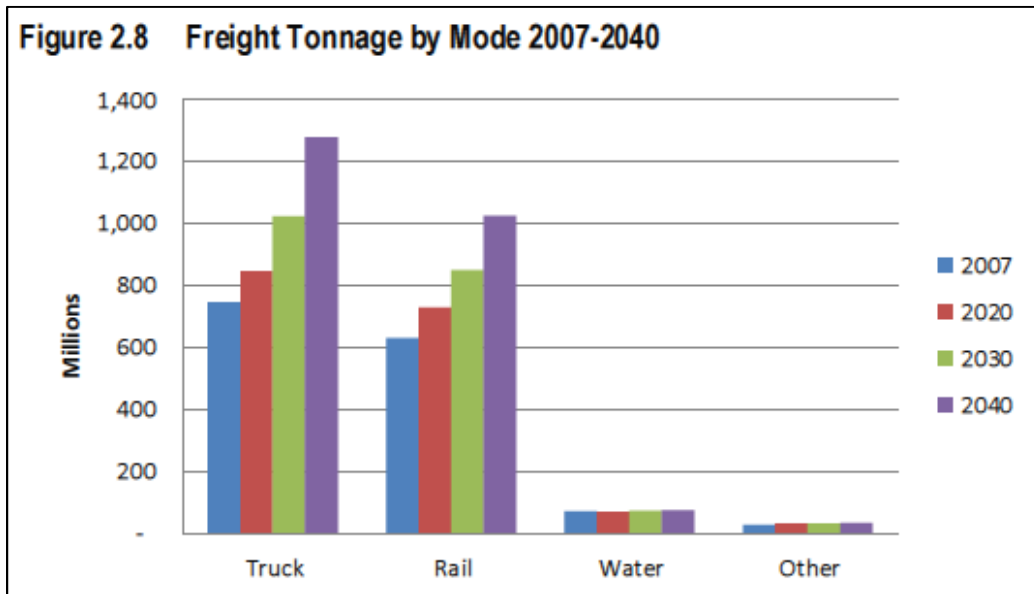

The above study, published by Cambridge Systematics, shows how uniquely active Chicago's rail networks is. For most major metropolitan area, truck movements would greatly outsize rail movements. The Chicago regions rail activity reflects an advantage in critical mass for rail movements that the region could leverage to encourage additional freight development. The lower water tonnage shows that the maritime network maybe underutilized. The above chart also clearly shows that freight tonnage is expected to grow about 80% for trucks, and about 70% for trains by 2040, placing additional gridlock on the road and rail infrastructure.

Based on economic trends and federal forecasts, the number of trucks on Chicago area roads is expected to increase by at least 80% in the next 25 years. Trucks average twice the road space used by cars. The resulting impact of increased truck traffic will be staggering --- trucks will account for more than half of the additional vehicles, and 2/3 of the effective increase in traffic on the region's roads. Facilities are needed that will help move the trucks off the roads Trucks are, and will remain, critical to freight transportation and to America's economy. However, railroads (forecasted to grow in volume 40% between 2010 and 2030) are more cost effective, more fuel efficient, and more environmentally desirable than an over-reliance on highways for freight transport. Moving freight by rail intermodal rather than by truck alone significantly reduces emissions, and that means cleaner air.



## Container Traffic

In terms of long-term growth, container traffic offers the greatest opportunity, in that it is growing very rapidly, while the demand for bulk cargo is much lower.

Public (government) interest in container barge services is growing, as is evident from the Maritime Administration's (MARAD) Marine Highways Program, which was fully implemented in April 2 2011.

The Illinois River and Mississippi River System, along with the Great Lakes, have historically served the nation's mid-county bulk markets with barge transportation services. These waterway systems can and will evolve into dual roles, much like the highway and rail systems do today, by serving both bulk and container markets.

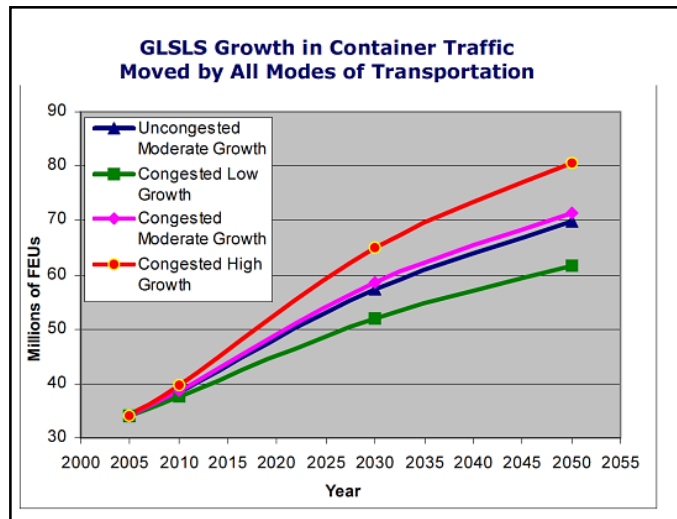

In the next few years, it is anticipated that at least 30 percent of West Coast port growth will be diverted via the Panama Canal (15 %) and by a round the world route via the Suez Canal (15%) to East Coast ports. This anticipated growth is driving an increase in Gulf Coast container handling capacity. The Gulf Coast has plans for total container capacity in excess of 9 million TEUs over the next decade, up from 2 million TEU's currently. Near the Mississippi River's base (from New Orleans to Mobile), the capacity could exceed 4 million TEUs alone. The Mississippi River and the Illinois River serve a large manufacturing base, the breadbasket of the nation. This base can support a container on barge business along the Rivers and into Chicago and then into the Great Lakes. Today this base is served by land bridge rail services from the west coast as well as by truck and rail from the east and gulf coasts.

Within the Great Lakes – Saint Lawrence Seaway served area, the region's population, employment, GDP, and trade are projected to grow significantly through 2050, and the region's freight traffic is expected to expand at an even faster rate. It is anticipated that a growing share of traffic moved by all modes of transportation will be by containers (including truck trailers). The total market for containerized traffic, which includes raw materials, food, and semi-finished and finished products, to and from the region is expected to more than double by 2050, from 35 million to over 70 million forty-foot units annually. This growth will create issues.

Today, as in future forecasts, trucks move the lion's share (over 98% in 2005) of containerized freight tonnage, and rail is moving the remaining 2 percent. However, available highway and rail capacity is suffering from deteriorating levels of service. In the case of highways, the capacity crunch is largely due to the growth of automobile traffic, particularly around major cities, such as Chicago. In the case of railroads, a move to increase productivity over the past



two decades resulted in increased concentration, amalgamation, and abandonment of secondary lines. As a result, moving containers by truck and rail in the future will cost more and probably take longer, since traffic is expected to outgrow any improvements in capacity and congestion is expected to increase.

### **In summary ...**

Within the greater Chicago area, the net effect of continued economic growth, increased Asian trade, and capacity limitations on the region's highways and railroads create an increased potential for water to play a greater role in the transportation of container and palletized (neobulk) traffic. Conservative assumptions on highway and rail capacity limitations suggest that –

- As freight traffic continues to grow, the share of freight moved by truck will decline due to congestion.
- The share of freight moved by railroads could grow assuming the railroads begin to bring back unused capacity in secondary lines and some bypass routes.
- The intermodal water option will grow if it can become competitive with rail and highway.
- The Obama administration is making it very clear that they want to move a larger percentage of the nation's intercity freight by rail or water, to take pressure off congested and crumbling highways, and to help improve the environment.

Cornel Martin (President and CEO of the Waterways Council) states: “ As a nation, we must look beyond today at the challenges that lie ahead and reinvest in waterways infrastructure that keeps America moving, keeps us strong, and gives us our competitive edge. The alternative is far too expensive and will cost us all more than we would be willing to pay.”

**A7. TRANSPORTATION MARKET ASSESSMENT-FULL REPORT**





## Ecosystem Separation Study



Task 2.1

### Identification of Key Chicago Shipping and Logistics Market Drivers

Prepared for

**HDR**

Prepared by

**VICKERMAN**  
& ASSOCIATES, LLC

Preliminary Draft Issued April 29, 2011  
For Peer Review Session I

No Distribution of this *Identification of Key Chicago Shipping and Logistics Market Drivers Report* is permitted unless authorized with the expressed written permission of HDR and Vickerman & Associates

# **Document Outline**

## **Section I**

### **Background**

- World Economy
- U.S. Foreign Trade

### **Containers**

- Containerized Shipping
- Container Production
- Container Growth

### **Transportation**

- Vessel Capacities
- Growth of the Nation's Transportation network
- Intermodal ... trends and forecasts

### **Water Transportation**

- Impact of the Panama Canal
- Impact of the Suez canal
- Advantages of Water Transportation
- Great Lakes – St. Lawrence Seaway

### **The Inland Waterway System in the U.S.**

- Background
- Inland traffic
- Marine Highway Corridors
- Waterway System Issues

## **Section II**

### **The State of Indiana – freight and transportation data**

- Background on State Ports
- Freight
- Commodities
- Rail facilities
- Northern ports

### **The State of Illinois Waterbourn Commerce**

#### **Chicago Area**

- A transportation hub
- Intermodal facilities
- Container Market
- Chicago area Ports
- Illinois River and Lock System
- Hub for trade to East – South - West

### **Section III (To Be Completed)**

#### **Nation's continuous Trade Growth will force changes in how the Chicago area moves product**

- Inland
- Waterway System
- Marine Highway System
- New Vessel Technologies
- Panama influence
- Infrastructure withing SLSLS will create opportunities

DRAFT

## Section I of III

### Background

#### The World Economy

GDP drives world trade and U.S. Trade. The 2009 downturn in world GDP and trade is unprecedented.

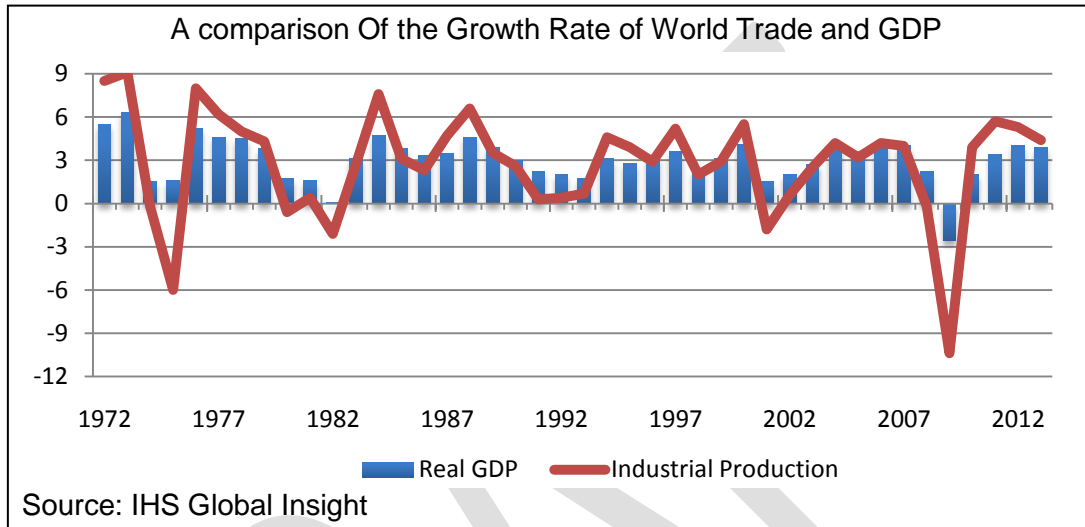

The global economic and trade recovery proceeded as anticipated in 2010, and as we enter 2011 some downside risks remain elevated. Nevertheless, most economists feel that the likely outcome is continued but moderate global trade and growth.

- However, the recovery is a story of two economies – robust strength in emerging markets but more fragile and tentative economic growth through much of the industrialized world (advanced markets).
- Emerging and developing economics prudent policies have contributed to a significantly improved medium-term growth outlook relative to the aftermath of previous global recessions. However, activities in these economics, particularly those in emerging Asia, remain dependent on demand in the advanced economics.
- Advanced and a few emerging economics still face major adjustments in their balance sheets and a need to reform their financial sectors.

In today's environment, global growth is estimated to have expanded by 4.8% in 2010 and is forecasted to expand by 4.2% in 2011. In the second half of 2010, there was a temporary slowdown and that slowdown will continue into the first half of 2011. (IMF, October 2010)

- Output of emerging and developing economics is projected to have expanded at a rate of growth to 7.1 % in 2010 and is forecasted to expand by 6.4% in 2011.
- In advanced economies, growth is only 2.7% in 2010 and forecasted to be 2.2% in 2011.



- All this indicates economic gains over the next couple of years will be secured with shorter steps.

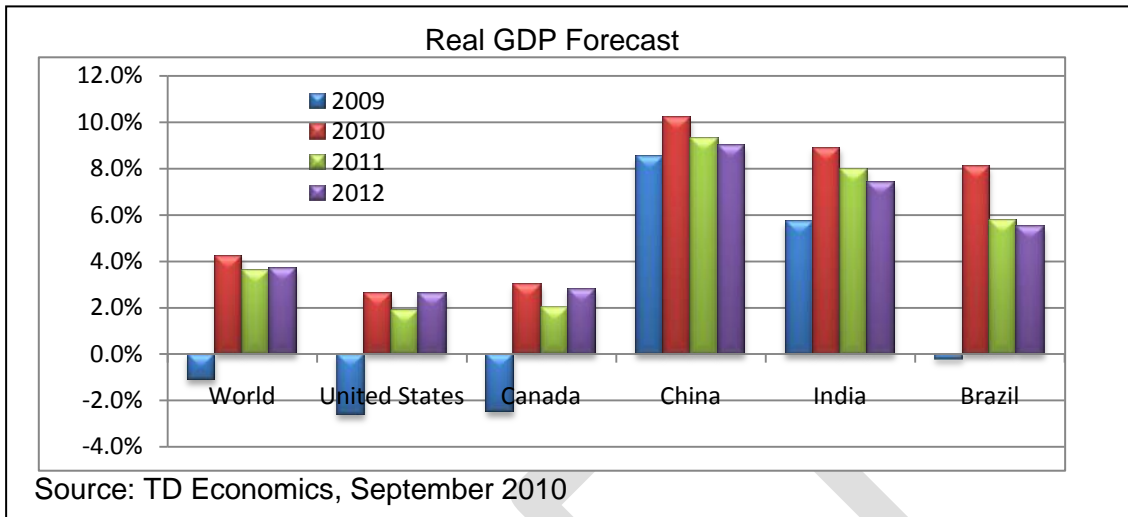

The number one threat to global economic and trade growth continues to be the sovereign debt situation of some European nations and its possible implications for financial market stability worldwide.

### The Importance of the Emerging Markets

The world is evolving and it appears that the world economy is at the pivot point of a new economic era. The advanced economies output expansion is not going to have the typical strength of past recoveries periods and past growth periods. Nevertheless, emerging markets and the developing world will see a faster pace of growth.

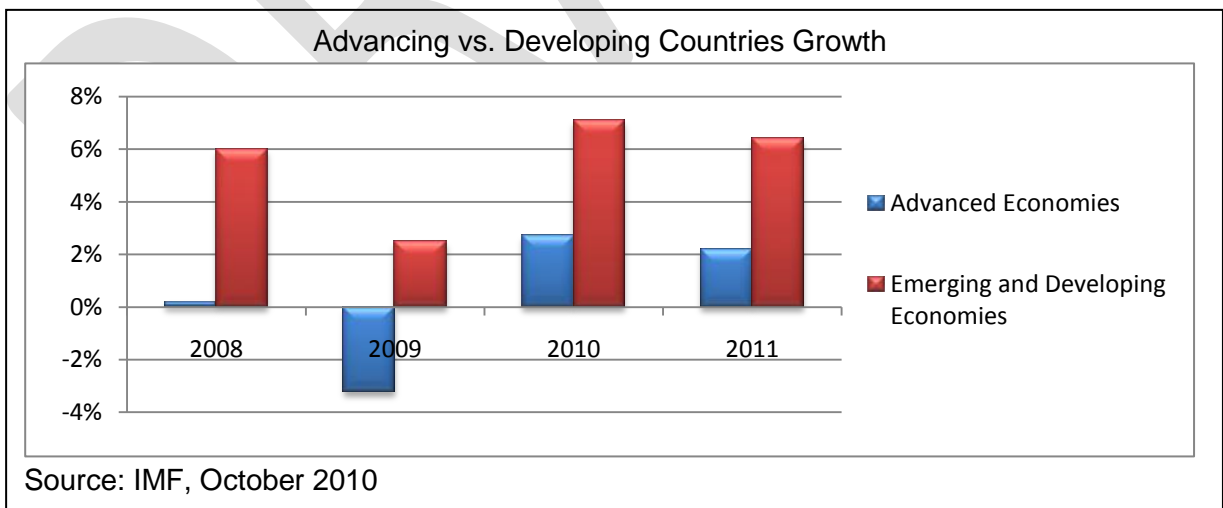

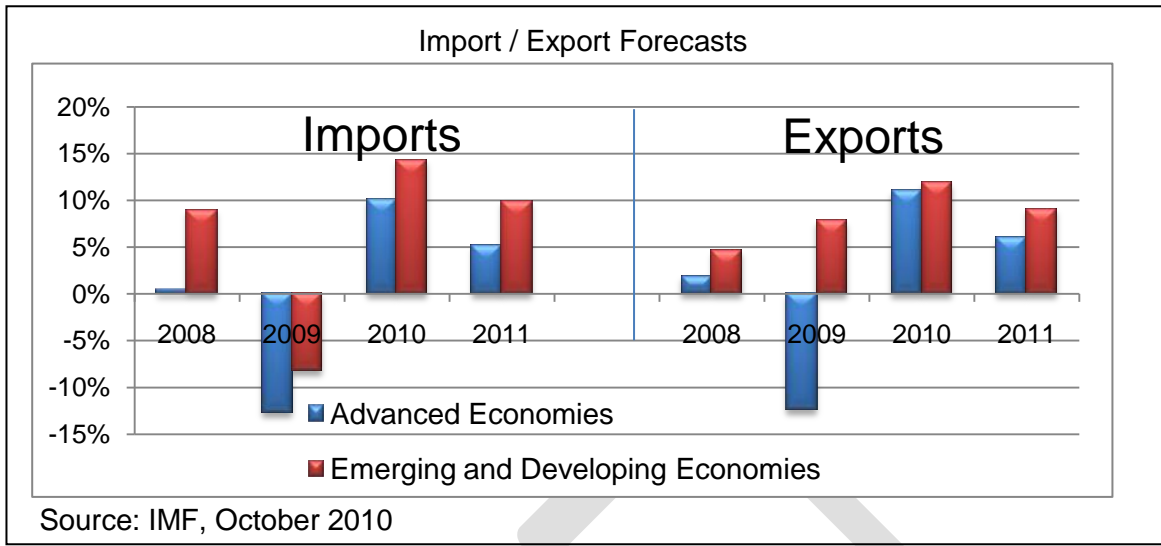

Looking ahead, the theme of relative structural and cyclical strength in the emerging market world will remain part of the global landscape for many years. However, amidst a deceleration in advanced economies, the nature of the global supply chain and the globalization of the world economy will also restrain the strength of the emerging markets. This fact combined with further policy efforts to check excessive price growth, suggest that the pace of emerging market growth has likely peaked.

Twenty years ago advanced nations / markets made up two-thirds of the global economy. Today they comprise only half, and within twenty years, advanced markets will decline to account for only one-third of the global output. As a result of this changing market share (in spite of slower expansion in the mature advanced economies), the global economy will continue to see strong growth.

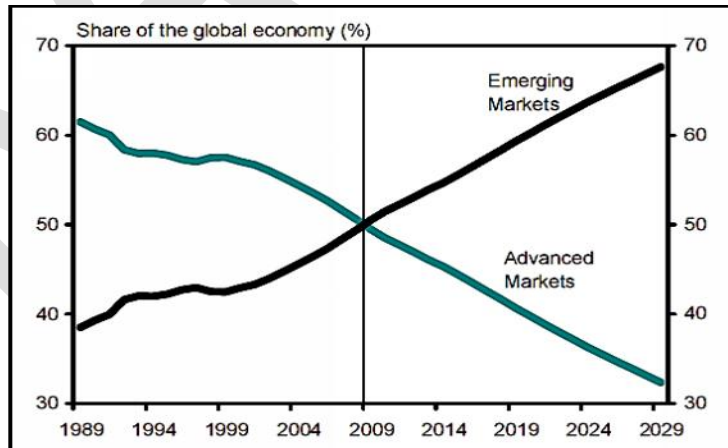

Source: IMF; Forecast by TD Economics as of 12/2010

For the emerging markets, Asia is and will continue to be the growing dominant “Global Economic Engine”. The influences of Asian trade will play an increasingly significant role in world ports and particularly so for North American port and intermodal systems. New North American port and intermodal investments must take into account these global economic forces into their plans.

Percent Change in Annual World Growth – Purchasing Power Parity Rates

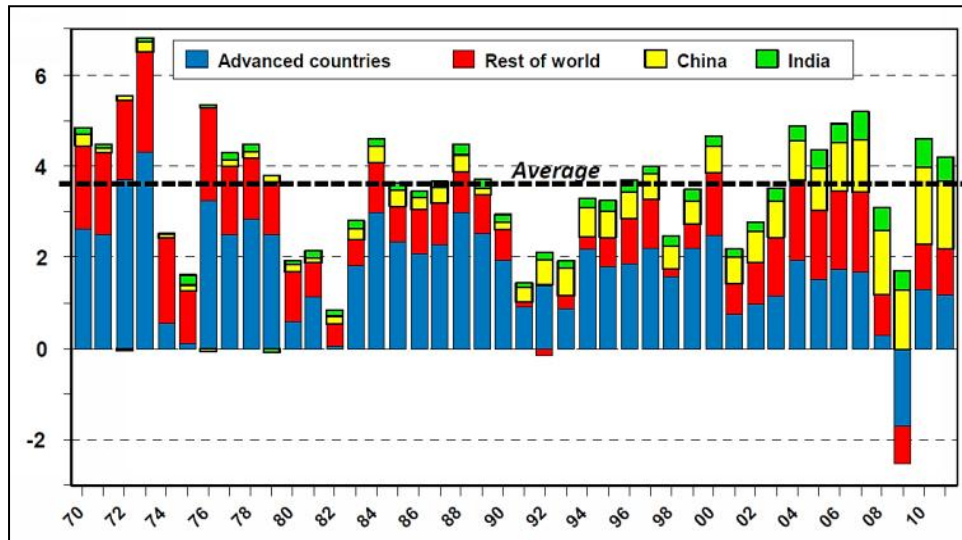

Source: CoBank knowledge Exchange Division, August 2010

**U.S. Foreign Trade**

U.S. trade performance is reliant upon the health of the global economy, the value of the dollar, and the shift in consumer goods manufacturing to low labor cost nations such as China, Southeast Asia and India. For the U.S., GDP growth and world trade are closely dependent and represent a true measure of the U.S. prosperity.

For the U.S., As Goes Economic Growth, So Goes Trade



Source: U.S. Department of Transportation based on U.S. Department of Commerce Data

Foreign trade accounted for only 13% of U.S. GDP in 1990; but it grew to nearly 22% by 2006. Recent projections indicate that foreign trade will be equivalent to 35% of GDP by 2020, and may grow to 60% by 2030. As foreign trade continues to grow, marine transportation will become even more important to the U.S. economy.

Value of U.S. Global Trade Compared to U.S. GDP (Trillions of 2000 Dollars)

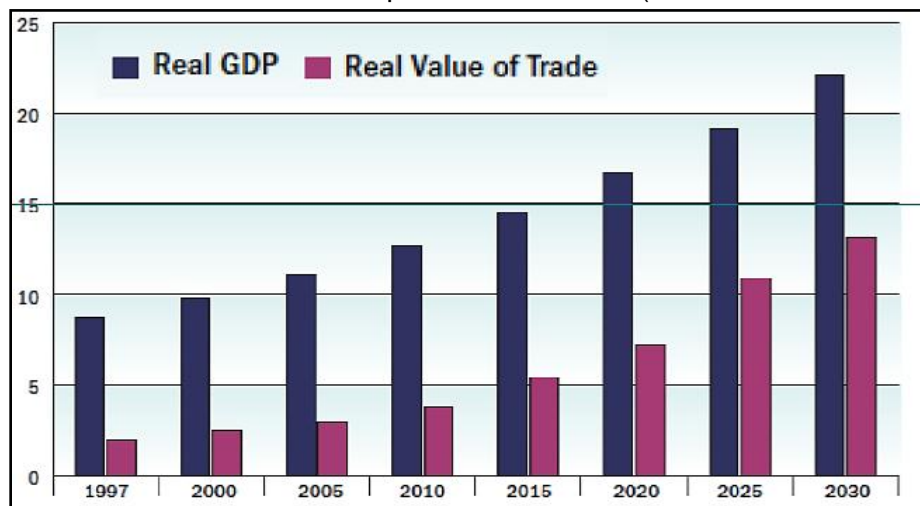

Source: Global Insights, Inc., 2009

For the U.S., the anticipated recovery in 2010 and 2011 and beyond is expected to be shallow relative to historic experiences due to the lingering economic costs.

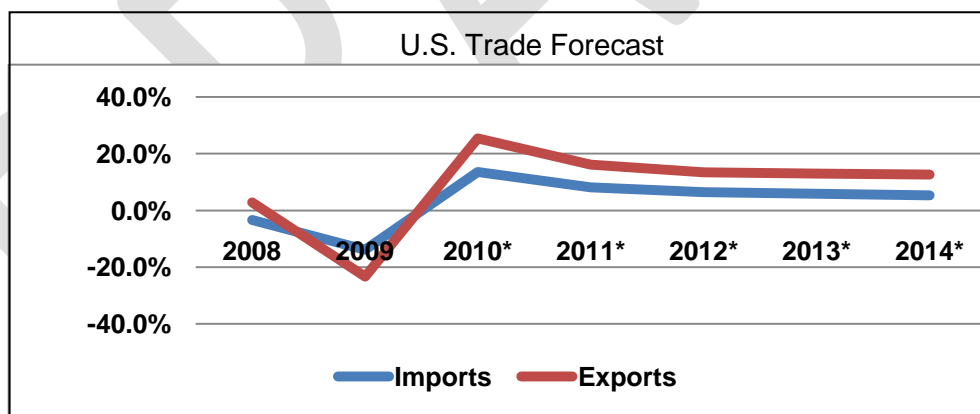

Source: TD Economics forecast, October / December 2010

Going forward, due to the rapid rate of economic growth of emerging markets, it is expected that the global economy will grow for the next twenty years and therefore help drive U.S. trade and the U.S. GDP toward future prosperity.

The U.S. GDP is forecasted to grow an average of 2.7% in the next ten years and 2.3% between 2020 and 2029. After a decline of almost 13% in the U.S. trade in 2009, a major turnaround in imports and exports was experienced in 2010; exports are estimated to be up 11.8%, and imports up 13.6%. In 2011 the growth will continue, but not as strong: exports and imports are both forecast to grow about 8%.

# Containers

## Containerized Shipping

(Major source of data: Dr. Jean-Paul Rodriguez, Hofstra University)

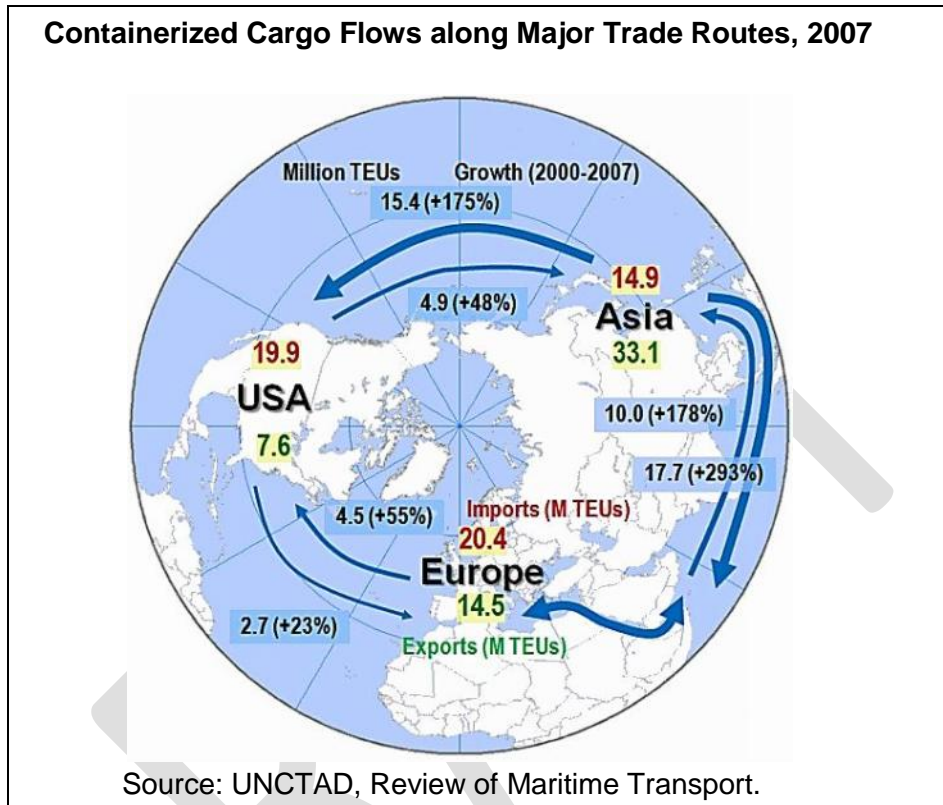

Global containerized flows are characterized by acute imbalances mainly linked with a disconnect between the manufacturing of mass consumption goods of export-oriented economies and large consumption markets such as North America and Europe. The Asian segment is the one that has experienced the fastest growth while transatlantic containerized trade between Europe and North America has become comparatively a low volume market.<sup>i</sup>

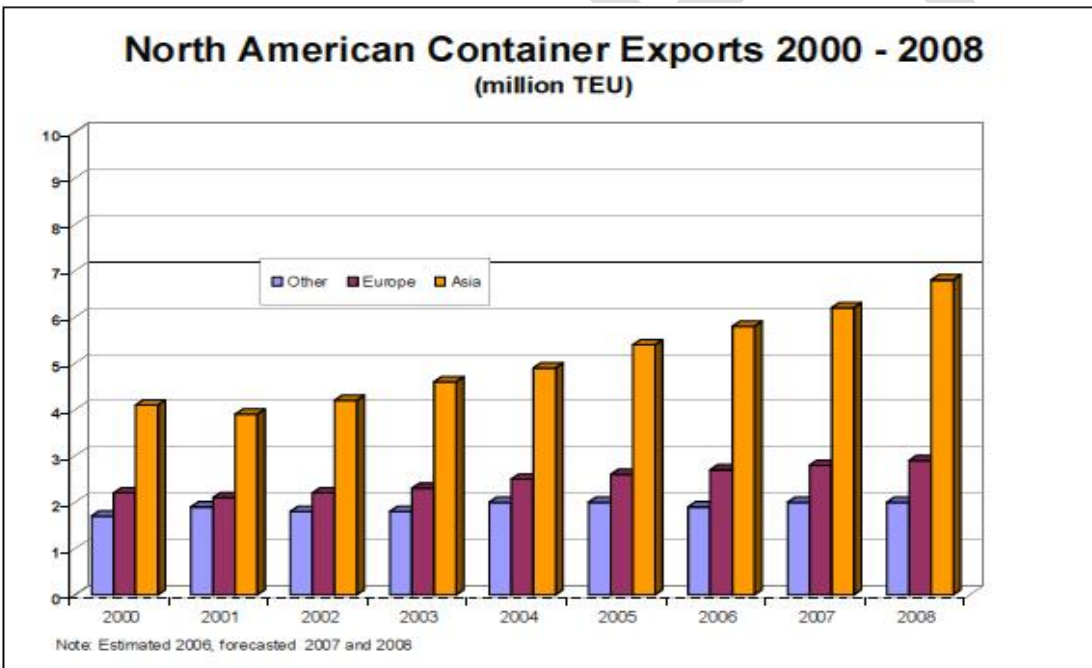
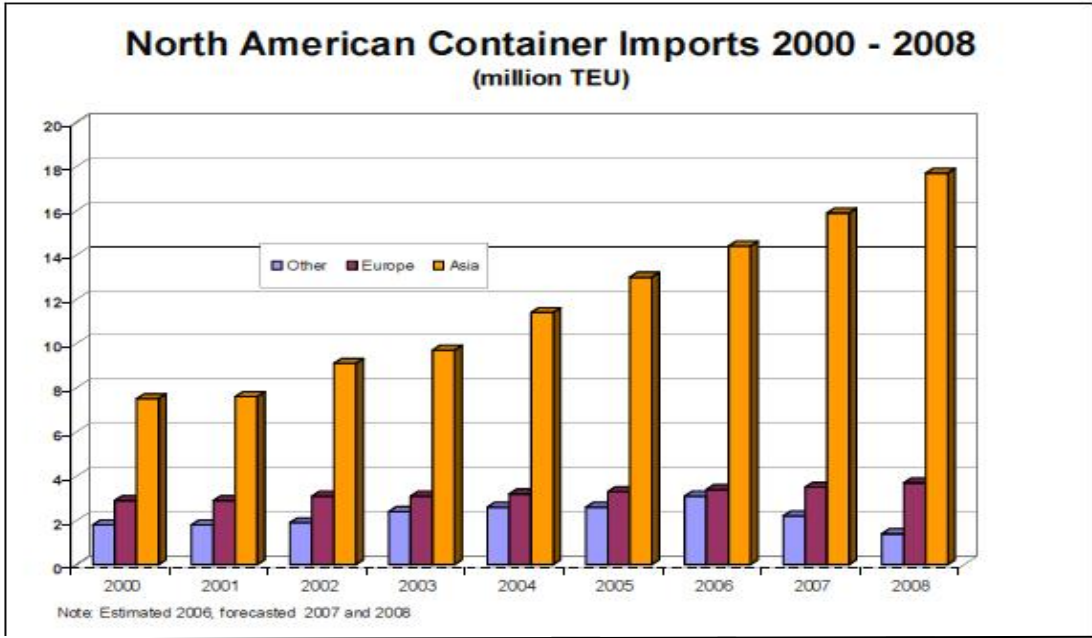

Source: Container Flows in World Trade, January 2009 (report #25)

From the above chart, it is easy to see why there is normally an excess of empty containers in the United States. American trade with several countries of the Pacific is chronically imbalanced, notably with China, Japan, and South Korea.



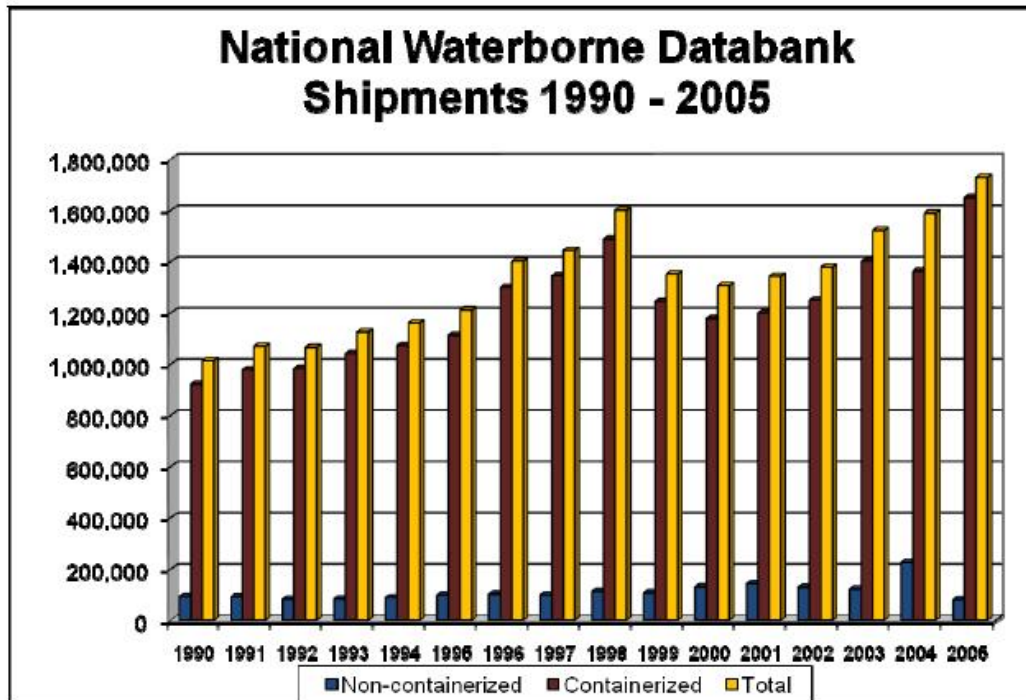

Source: Container Flows in World Trade, January 2009 (report #25)

The above chart shows that containerized shipments make up the largest portion of shipments with non-containerized shipments forming a small portion of shipments. The value of these shipments is shown below. The containerized commerce value has made up the largest portion of commerce since 1994.

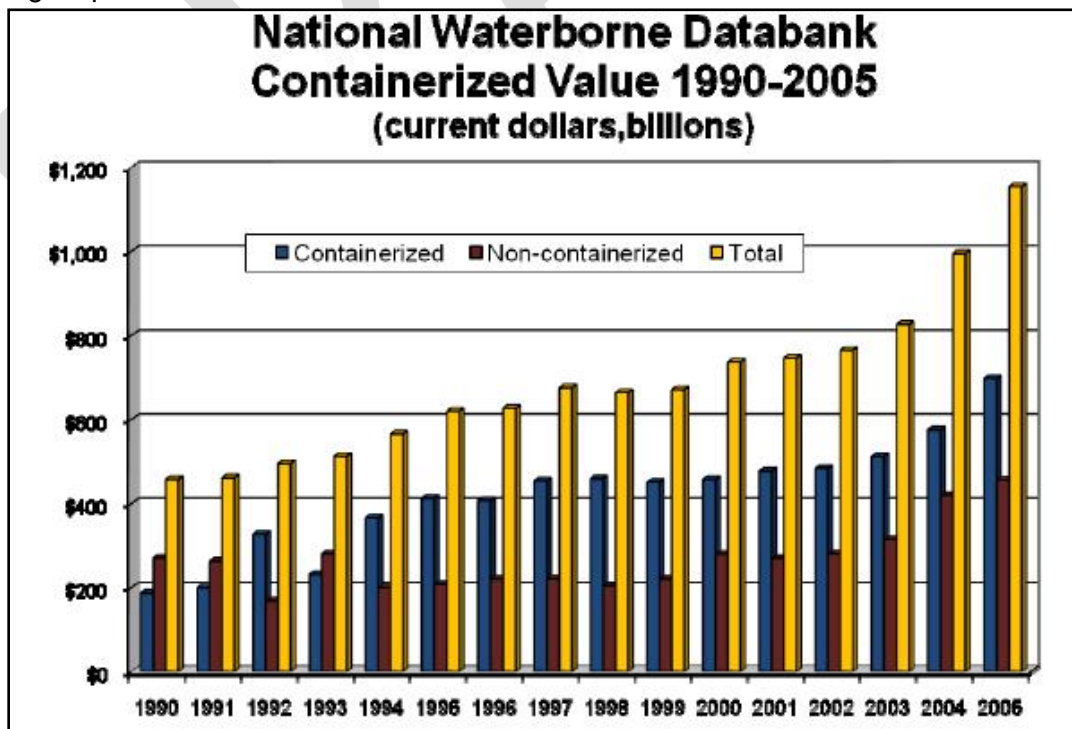



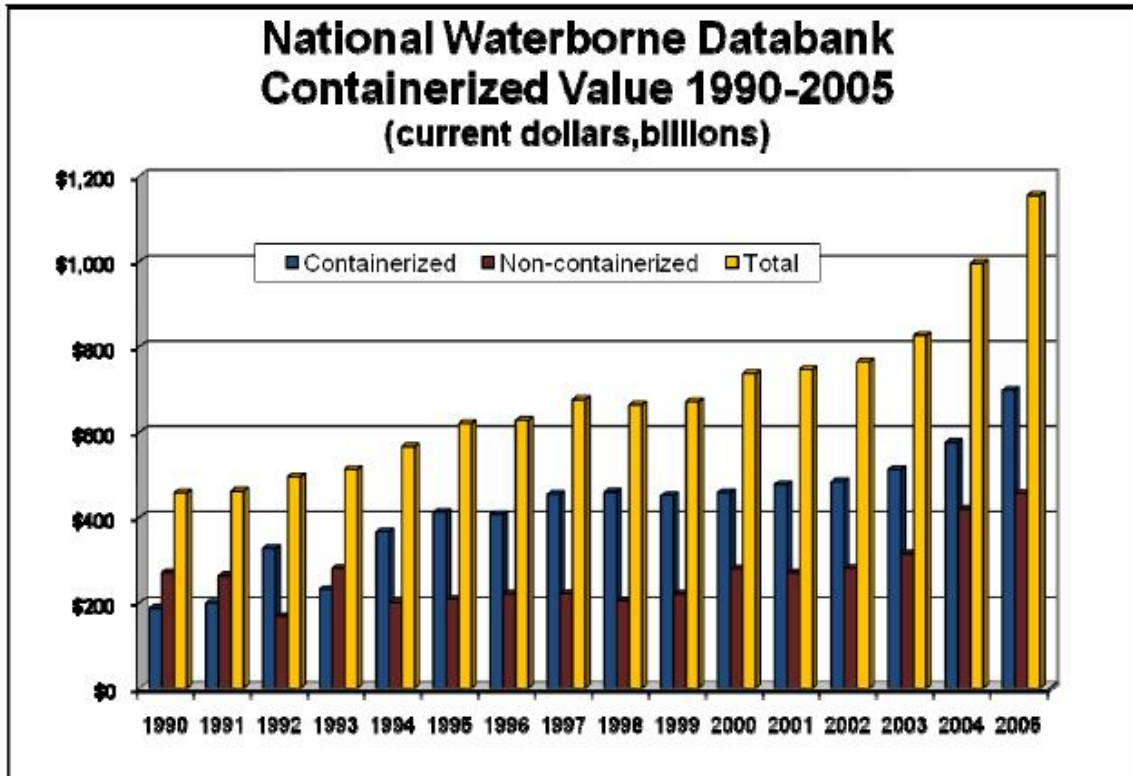

Source: Container Flows in World Trade, January 2009 (report #25)

### Container Production

The growth in global trade and freight distribution has led to a demand for new containers. Each year, with the exception of 2008 and 2009, about 2 to 2.5 million TEUs worth of containers are manufactured, the great majority of them in China. Production peaked to 3.9 million TEUs in 2007 with the global inventory of containers estimated to be at 28.2 million TEUs. This (approximately) implies three TEUs of containers for every TEU of maritime containership capacity. The twenty foot container (in spite of its higher cost) remains a prime transport unit, particularly for the shipping of commodities such as grain where it represents an optimal size taking account of weight per unit of volume capacity of containers, around 34 metric tons. China accounts for more than 90% of the global production of containers, which is the outcome of several factors, particularly its export-oriented economy and its lower labor costs. Considering that China has a positive trade balance, notably in the manufacturing sector, which highly depends on containerization, it is a logical strategy to have containers manufactured there. This enables a free movement since once produced a new container is immediately moved to a nearby export activity (factory or distribution center), then loaded and brought to a container port. A long distance empty repositioning is therefore not required for the newly manufactured container.

## Container Growth

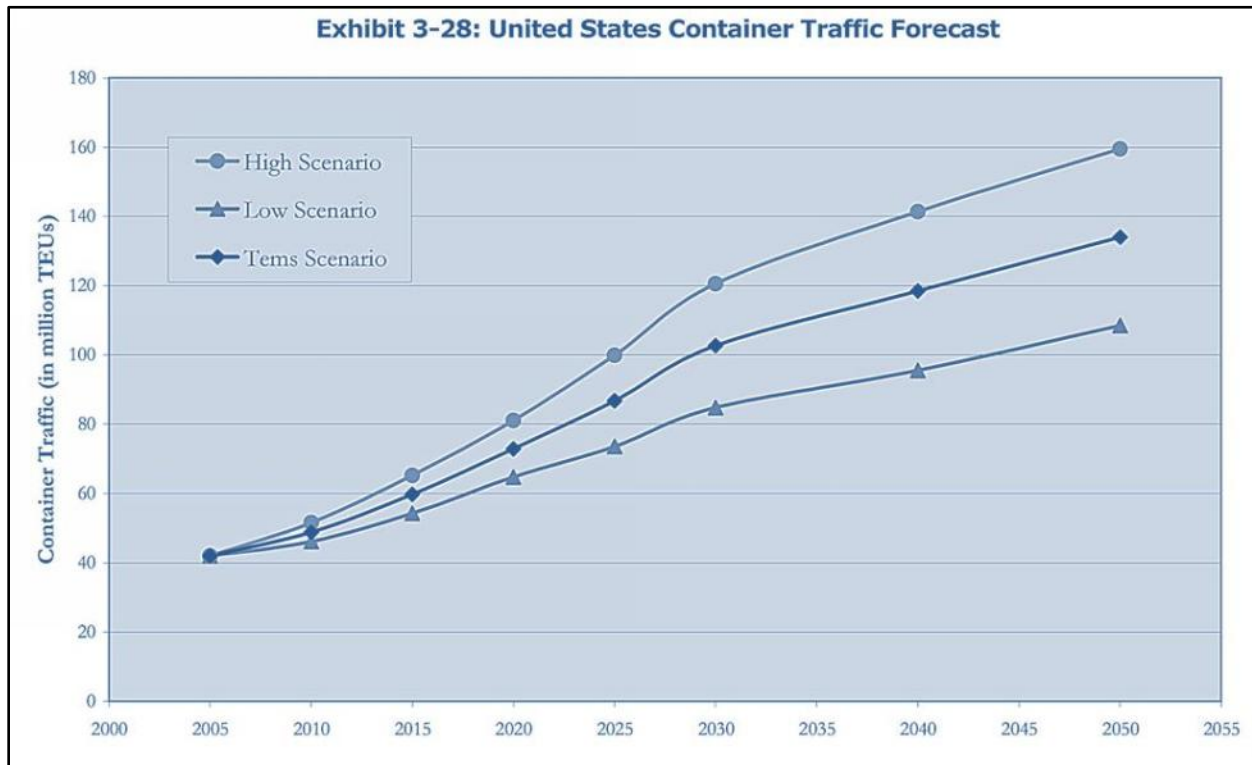

Source: GLSLS Market Assessment Study, January 2007

As forecasted by the Maritime Administration National Advisory Council:

*“Container volume is expected to more than double in the next 20 years, and nearly all non-bulk cargo will be containerized. Ports must plan now to ensure that they have the people, training, technology, transportation, assets, and the infrastructure to provide efficient and reliable transportation services. Solutions must be flexible to accommodate changes that will inevitably occur.”*

A Seaport bulletin in 2009 stated:

*“For the longer term”, this is the 80% scenario:”*  
*“The governments and financial institutions of the world resolve the outstanding financial issues in 2009 and 2010 and the real economy of the world responds to fiscal stimulus. In this case we expect the world container trade to grow somewhat in 2010 (perhaps 5%) and to continue to grow in subsequent years similar to the past but at lower rates, perhaps 7% to 9% a year.”*

A U.S. Maritime Report states:

*“Projected growth in the U.S. economy and historic trends at U.S. ports suggests that port container traffic will double by 2020 and triple by 2030. This may occur even if the average annual rate of growth in container traffic falls from the 1950-2006 average of*

6.4% ... to 5%. Even if the growth rate falls to 4%, container traffic could still more than double by 2030.”

Global Insight forecasts steady recovery for global shipping: (July 2010)

World trade by all modes of transportation will grow 8.1% in 2010 and 6.9% in 2011, following a 7.2% decline in 2009. Global containerized trade volumes are forecast to reach 10.0% growth in 2010. For the container industry, 2010 and 2011 will be banner years relative to the hardship the container industry faced in 2008 and 2009.

AXS-Alphaliner / Drewry Shipping Consultants: (September, 2010 – JOC)

Expects 2010 volume to increase 11.6% over 2009 to 545 million TEUs, exceeding pre-recession volume of 535 million TEUs in 2008. They forecast global container port throughput would grow an average 7.2% between 2009 and 2015 to 718 million TEUs. But, expect global container-handling capacity to grow just 20% over the same period. This mismatch will drive up utilization rates, and some parts of the world could see congestion returning by 2015. A capacity crunch could hit hardest in the Middle East and Asia, where Drewry expects terminal utilization rates to reach 95% by 2015, well above the global average of just over 80%.

Drewry and HIS Global Insight container growth forecasts.

**World Container Growth Forecast (includes full and empty containers, port to port, and transshipment volume in millions of TEU's)**

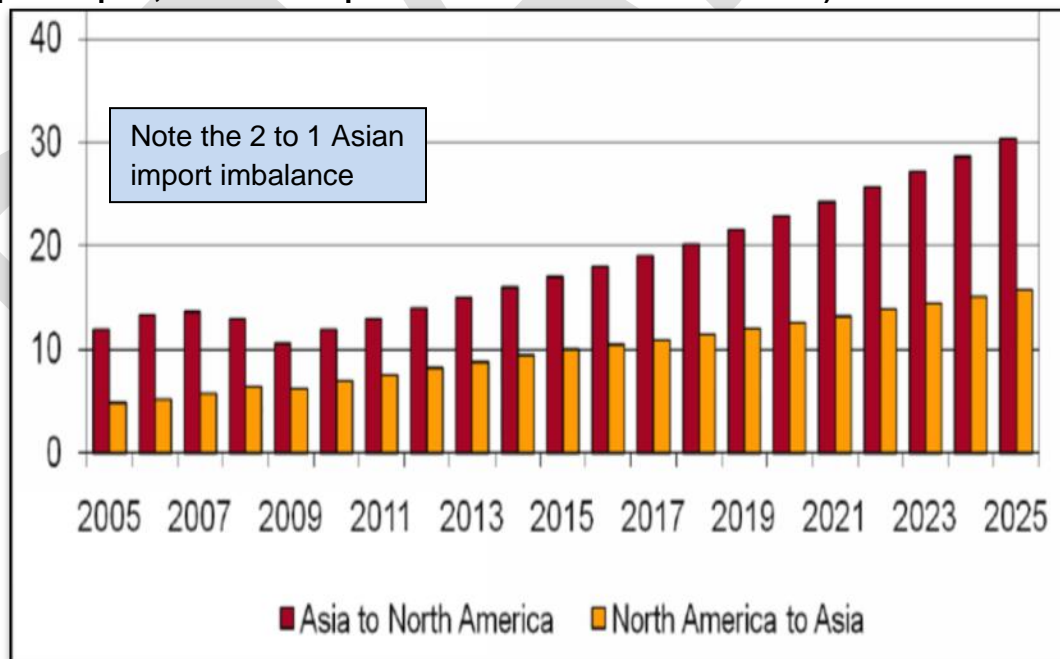

Source: Drewry Shipping Consultants

## Transatlantic Container Trade Recovery

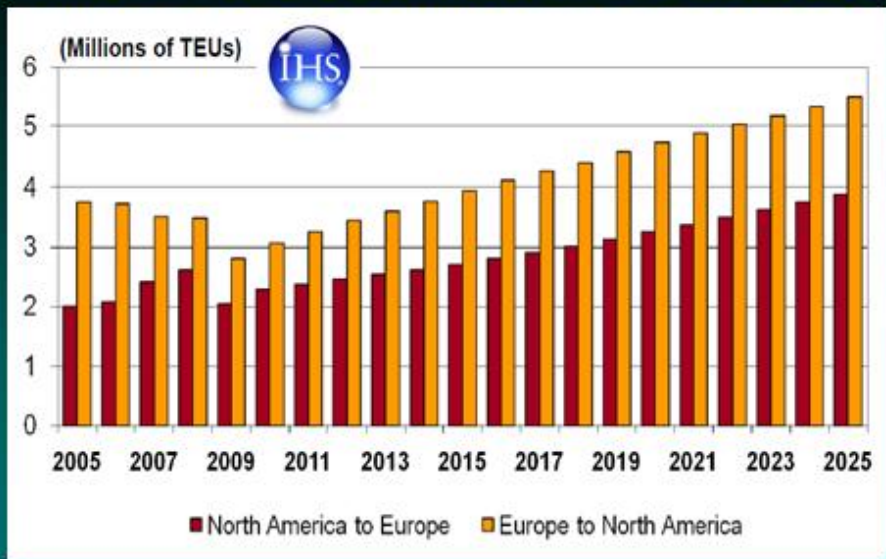

Source: IHS – Global Insight – The Global Outlook – October 14, 2010

VICKERMAN  
Copyright © 2010

## World Container Growth Forecast (includes full and empty containers, port to port, and transshipment volume in millions of TEUs)

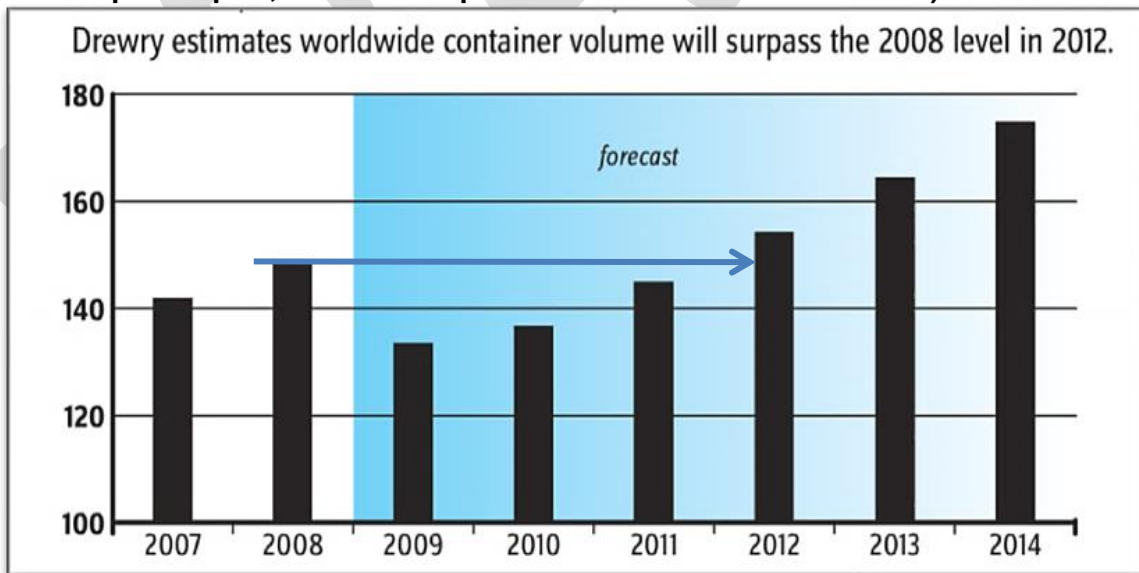

Source: Drewry Shipping Consultants

# Transportation

## Vessel capacities growing internationally

Vessel capacity had been growing at an annual rate of more than 10 percent but slowed in 2010 as carriers delayed delivery of vessels ordered prior to the recession. By August of 2010, weekly capacity was 20 to 25% higher than in January 2010. On transpacific routes, the consulting firm, AXS-Alphaliner, states, “both the Far-East-Europe and trans-Pacific freight rates could see more dramatic declines if demand fails to match supply growth which is planned for these trades”. Damas said, “the added capacity will take some of the momentum out of the tight markets”, “you have slower growth in demand but much higher growth in supply”.

**Deliveries of new container ship capacity in thousand TEU's**

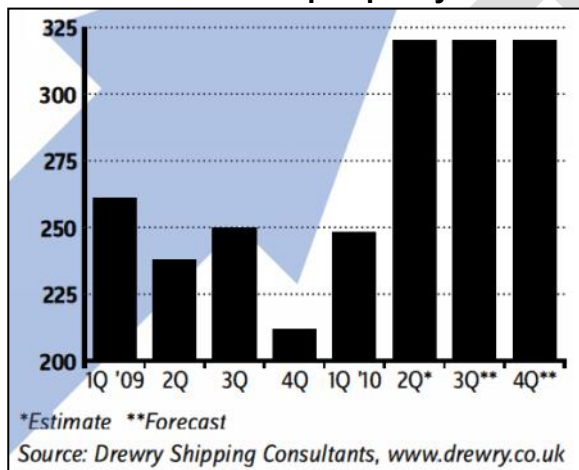

A projected slowdown in cargo demand raises the specter of overcapacity returning to the shipping industry.

**Container Shipping Supply vs. Demand**

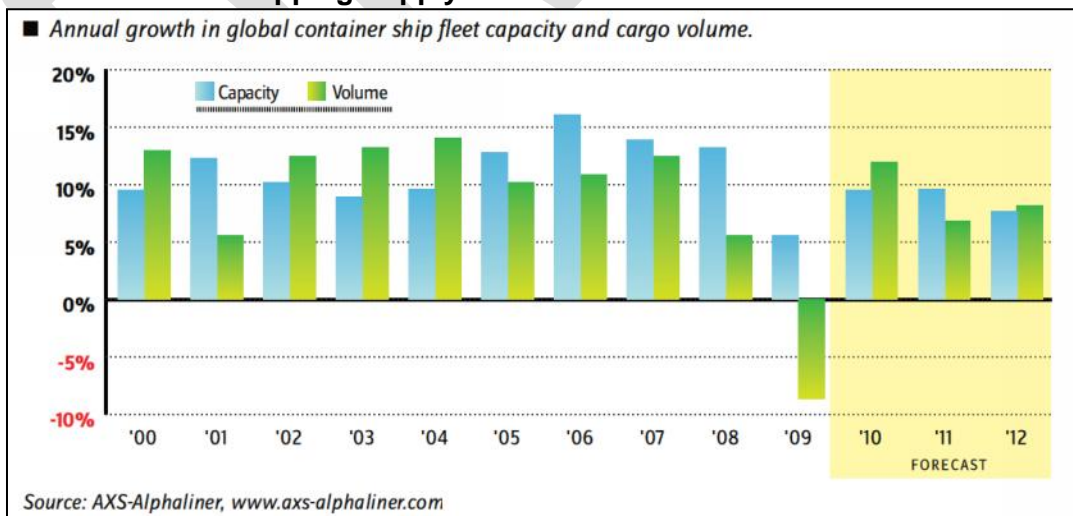

Although new ships delivered in 2010 to 2012 will decline, the total capacity of those ships will jump from 2009 as average vessel size grows. (Figure 19)

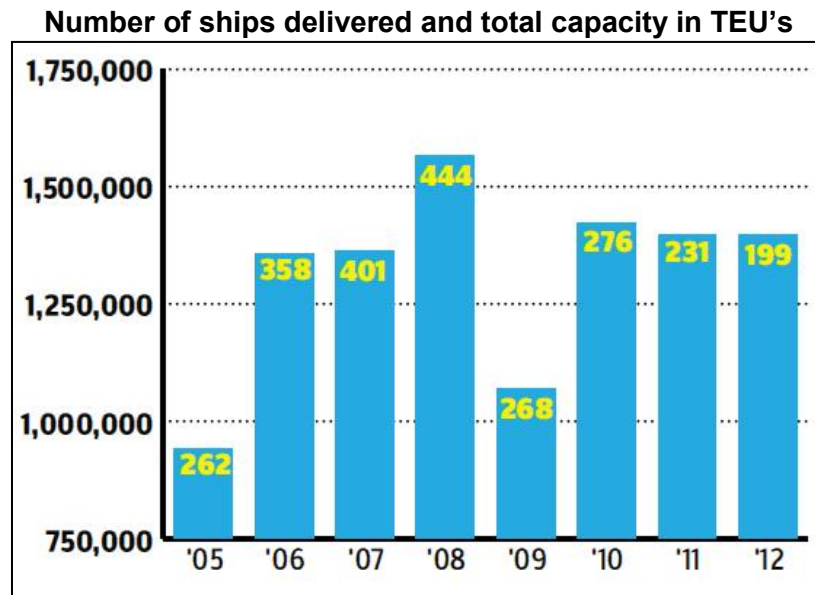

Source: JOC, Nov 1, 2010

Vessel capacity is expected to increase almost 20% in 2010, and 13% in 2011. The increase is because of carrier's rapid reactivation of idled ships and the resumption of delivery of new ships ordered before the recession

At the end of the 3<sup>rd</sup> quarter of 2010 AXS-Alphaliner calculates active liner capacity of 14.6 million TEU's aboard 5,958 ships

- The top 50 fleet operators control 13.4 million TEU's of capacity and 92% of active liner capacity.
- The top 50 operators have 3.2 million of TEU's of capacity in 419 new ships on order --- representing 24.1% of existing fleet capacity



**Total containership orders booked by TEU Range (percentage of TEU capacity)**

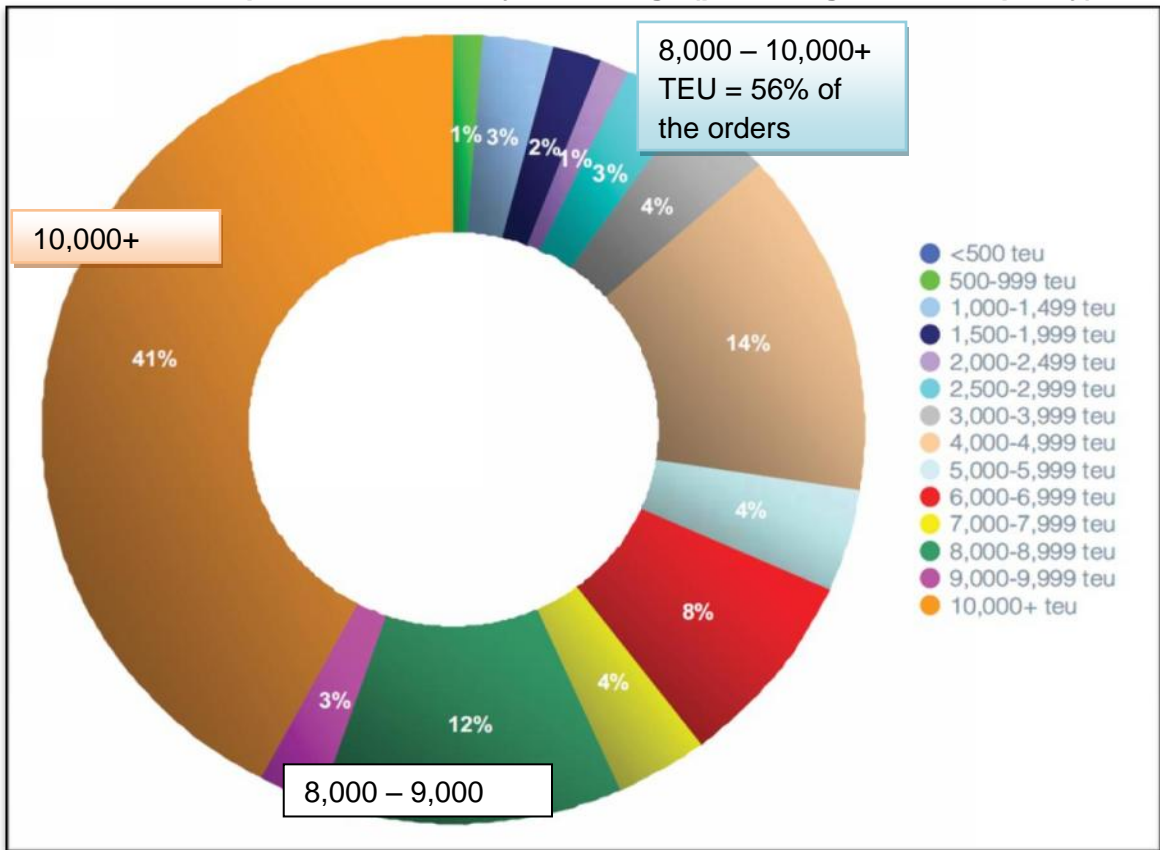

Source: Drewry 2010 Container Forecast



## **Growth of the Nation's transportation network**

([http://ops.fhwa.dot.gov/freight/freight\\_analysis/nat\\_freight\\_stats](http://ops.fhwa.dot.gov/freight/freight_analysis/nat_freight_stats))

The U.S. transportation system moved, on average, 53 million tons, worth \$36 billion each day in 2002. The U.S. Department of Transportation (FAF) estimates that tonnage increased by 11.2 percent by 2008, reaching 58.9 million tons per day. Nearly 10 percent of this tonnage is imports and exports. Growth between 2002 and the estimate for 2008 is slightly lower than the forecasted growth rates through 2035.

Through 2035, the mix by transportation type is forecasted to show little change, however the forecasted growth is big, placing pressure on the domestic transportation network and on all modes of transportation.

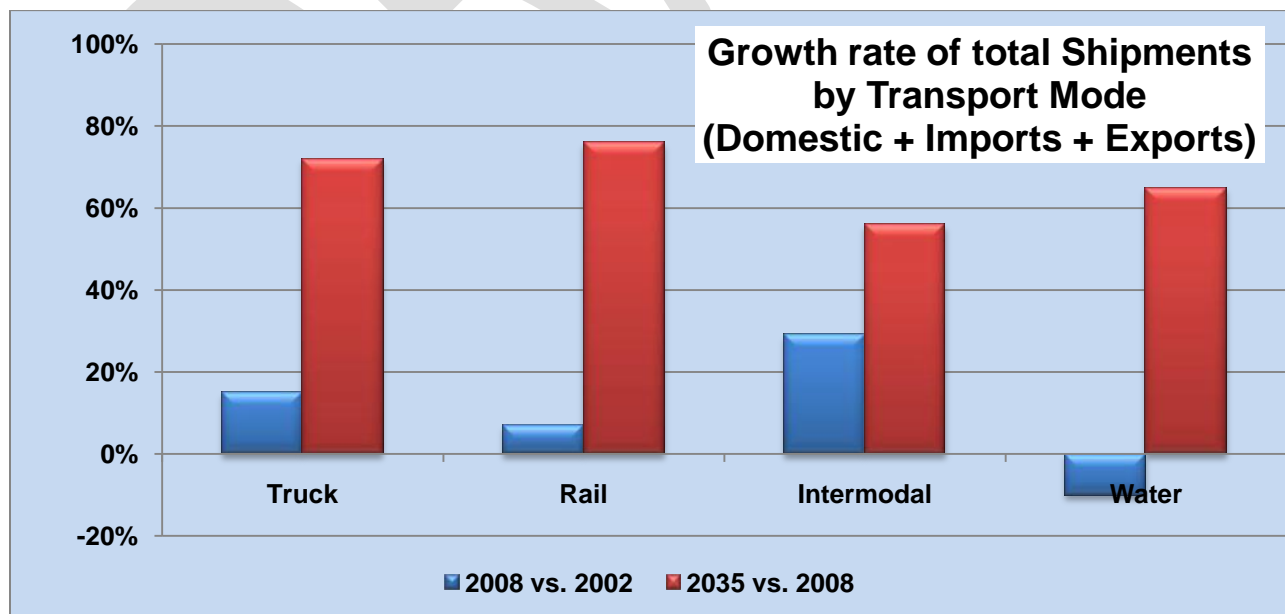
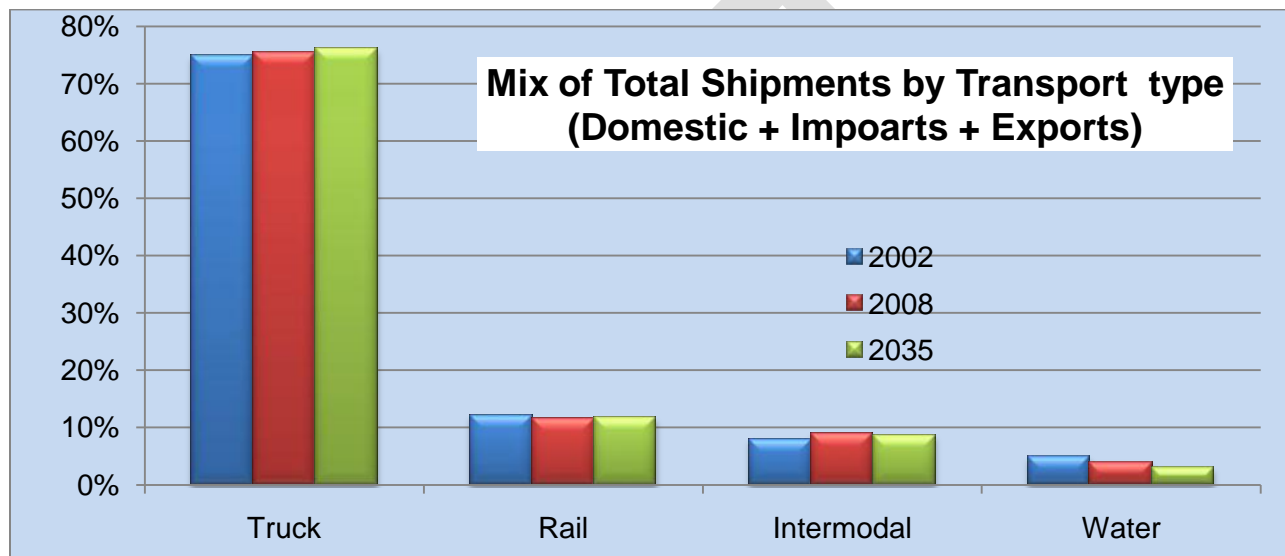

Source: Data chart #3)

The road and railroad infrastructure growth has definitely not kept pace with the volume of traffic. Between 1980 and 2007, the route miles of public roads increased by about 5% compared with a 98% increase in vehicle miles traveled. Class I railroad miles have continued to decline.

<b><u>Miles of Infrastructure by Transportation Mode</u></b>				
	1990	2000	2007	Percent change 1990 to 2007
<b>Public roads, route miles</b>	3,866,926	3,951,101	4,048,523	5%
<b>Interstates</b>	45,074	46,673	46,934	4%
<b>Railroad</b>	175,909	170,512	140,134	-20%
<b>Class I</b>	133,189	120,597	94,313	-29%
<b>Regional</b>	18,375	20,978	16,930	-8%
<b>Local</b>	24,337	28,937	28,891	19%
<b>Inland waterways</b>				
<b>Navigable channels</b>	11,000	11,000	11,000	0%
<b>Great Lakes-St. Lawrence Seaway</b>	2,342	2,342	2,342	0%

The average daily Long-Haul Traffic on the Highway System will increase dramatically in the next 25 years. Note the increased congestion in the greater Chicago area

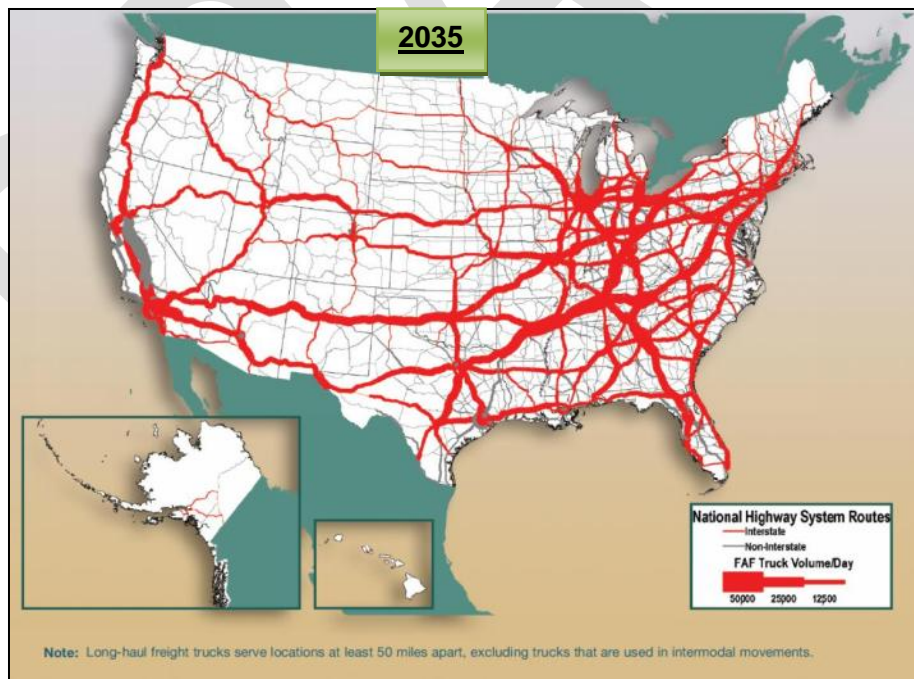
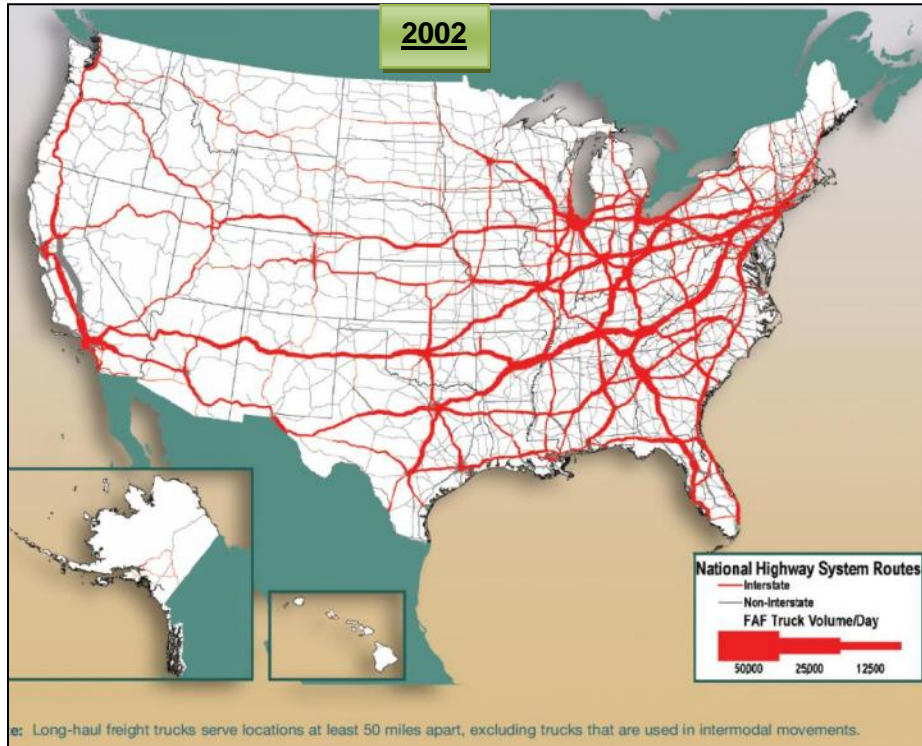

Forecast data indicates that truck travel may reach 600 million miles per day

Major truck routes on the Nations Highway System carry a significant concentration of trucks. The number of miles carrying large volumes and high percentages of trucks is forecast to increase dramatically by 2035. Segments with more than 10,000 trucks per day, and where at least every fourth vehicle is a truck, are forecast to exceed 14,000 miles (vs. 4,000 miles in 2002), an increase of almost 230% from 2002.

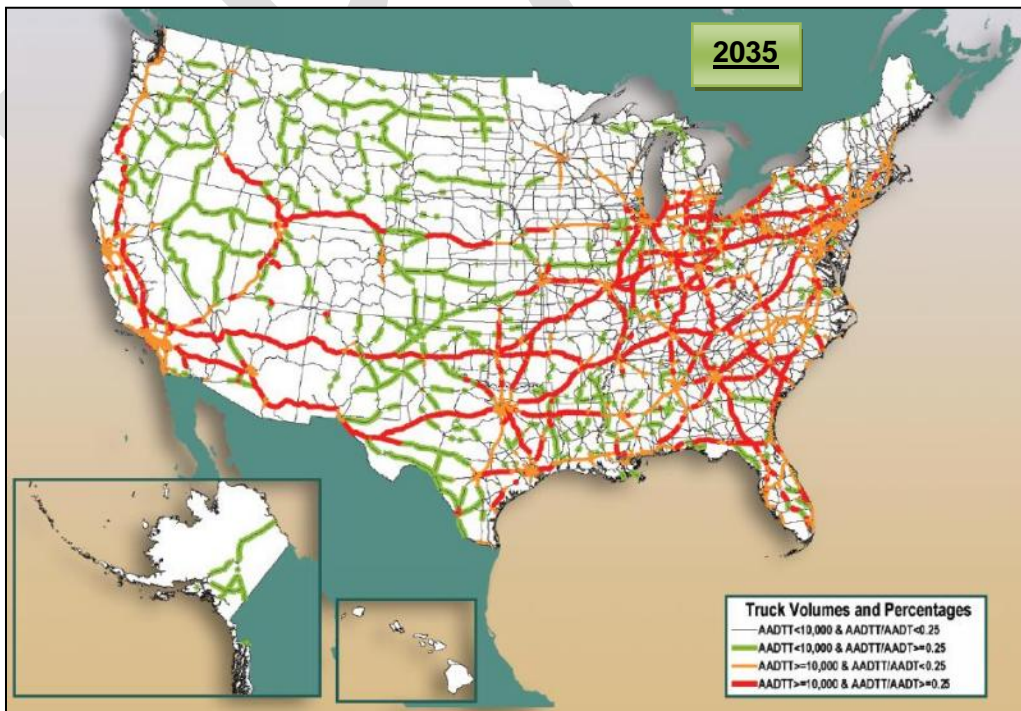
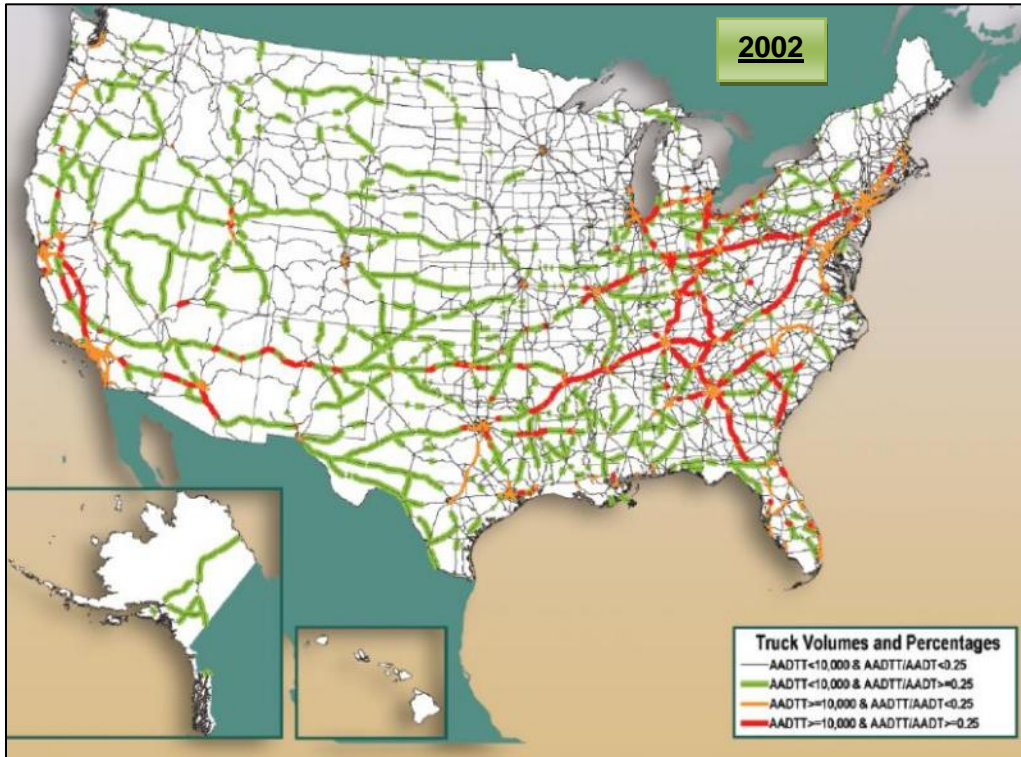



Peak congestion on the Highway System - Recurring congestion caused by volumes of passenger's vehicles and trucks that exceed capacity on roadways during peak periods is concentrated primarily in major metropolitan areas. Assuming no changes in network capacity, increases in truck and passenger traffic are forecast to expand recurring congestion to 40% of the System in 2035, compared to 11% in 2002. This will slow traffic on nearly 20,000 miles of the System (vs. 10,600 miles in 2002). This congestion will especially affect the greater Chicago area

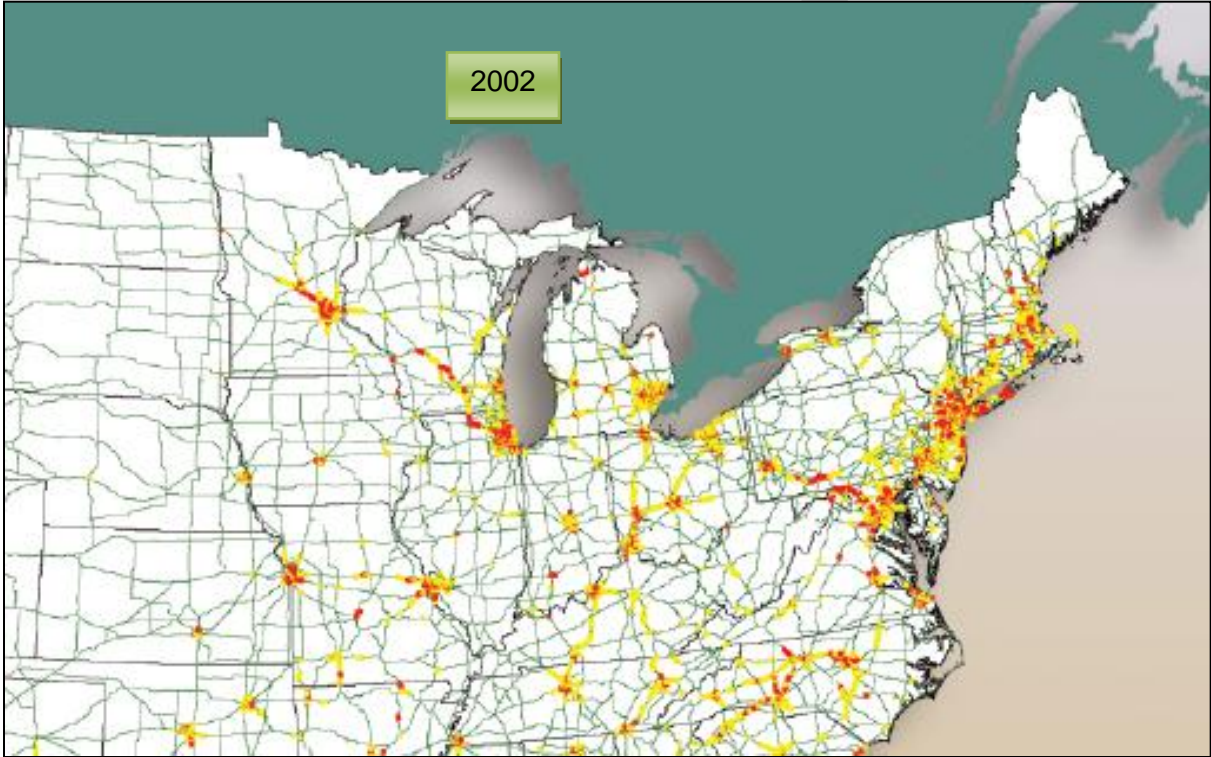

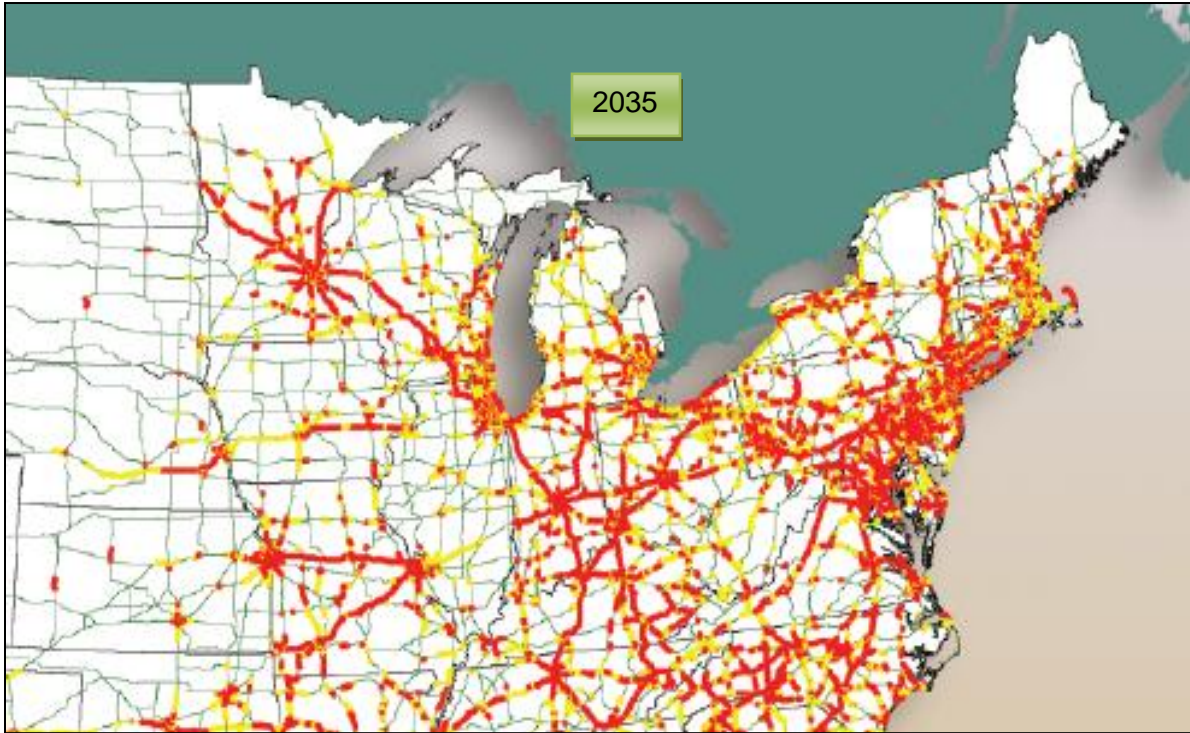

**Intermodal ... trends and forecasts**

**Intermodal Growth**

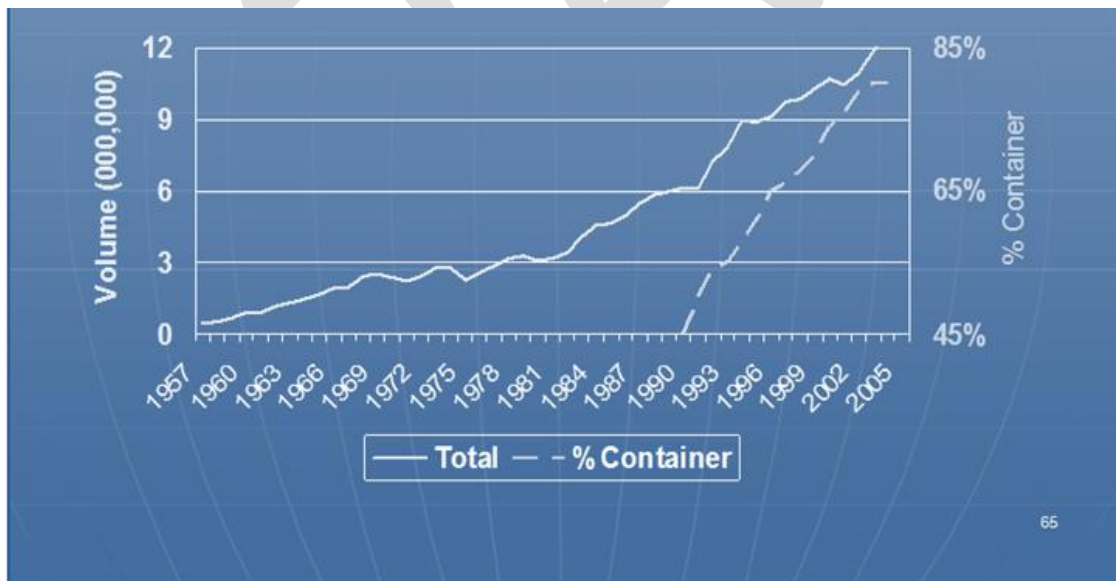

The intermodal infrastructure has, evolved through two generations of systems and services. These systems were designed in response to international shipping trends and the demand for intermodal services by shippers. (Rno Consultants [www.rnogroup.com](http://www.rnogroup.com))

## **1<sup>st</sup> Generation Intermodal – In Response to the Standardized Container Box and is characteristically single mode**

Intermodal began in 1956 with the introduction of the container box. With the container introduction, the truck played a dominant role with intermodal transport. In addition, even with the rapid adoption of the rail intermodal function at ports, the truck still played a strong role in draying containers between ports and rail intermodal yards. Markets within a 8-12 hour drive were conveniently served by truck, and more distant markets served by rail intermodal, with trucking playing a key drayage role at either end of the trip. As a result, the intermodal infrastructure at and around the port is characteristically truck oriented, with the role of rail geared to off- or near-dock.

## **2<sup>nd</sup> Generation Intermodal – In Response to Asian Trade Growth and is largely dual mode (rail and truck)**

The second generation of intermodal infrastructure was heavily influenced by the growth in Asian related trade. Demand for land-bridged intermodal services across the North American continent, between the east and west coasts as well as the industrial heartland, brought on a new generation of intermodal infrastructure systems and services, which were heavily focused on the rail intermodal system. The long distances between the West Coast ports and markets in the heartland and along the eastern seaboard made rail intermodal service very competitive. In addition, the rail intermodal industry became more service oriented and introduced innovations such as double stacking and time definite scheduled services. In addition, they worked with the respective ports to build on-dock rail terminals as well as inland ports to improve efficiencies. As a result, port related intermodal infrastructure development placed a heavy emphasis on moving the containers through the port as quickly and efficiently as possible, relying on both trucks and rail.

The significance of Asian trade densities and the operational dynamics of long-haul intermodal trips across the North American continent have largely been responsible for the dominant and profitable role of intermodal in the rail industry's business model. However, with the widening of the Panama Canal, the economics of all-water services to the East Coast and Gulf Ports are likely to become more viable. As a result, a portion of existing ships calling at West Coast ports, as well as a portion of future growth in trade, may be diverted to the East Coast and to Gulf Ports. This will deal a blow to current intermodal policy in the sense that an increasing share of Asian trade will be handled by ports which are predominantly served by truck (although on-dock rail is a far more common practice of late at some East Coast ports). While West Coast ports have a strong rail intermodal share. East Coast ports have largely been truck ports. Since their markets are in close proximity and are ideal for truck service. Many distances-to-market are too short to make rail intermodal viable. The result is that intermodal policy is likely to take a step back, unless it shifts into a third generational mode.

Therefore in response to the widening of the Panama Canal intermodal infrastructures have a chance to evolve into triple-play intermodal services (containers on trucks, rail and barge) at



container gateway ports. The opportunity to develop into a 3<sup>rd</sup> generation is largely dependent on the success of two aspects, specifically container-on-barge development (including short-sea-shipping) and short-haul intermodal rail. The former functioning as “marine highways” serving the nation’s interior from Gulf Coast ports and the latter serving as “reverse mini-land bridges” from East Coast ports to inland markets.

Reverse Mini Rail Land bridges serve the reverse role of the current trans-continental land bridge for containers to/from Asia, except on a smaller scale. Instead of calling on West Coast ports, containers are shipped through the Panama Canal to the East Coast or Gulf Ports and then shipped by rail or truck to a mid-country market. The challenge is in the cost competitiveness of the rail reverse mini land bridge, given the close proximity of the markets to the ports.

**Examples of Reverse Landbridge Services from the East Coast and Gulf Coast** (Rno Group – Chicago – reports - #20)



**New Intermodal Investments in Support of the Reverse Land Bridge**

A recent set of investments made by eastern and central railroads form the foundation for the development of reverse landbridge services:

The 1,200-mile Heartland Corridor routes Norfolk Southern trains from Norfolk, through Roanoke, Columbus, and Northwest Indiana to Chicago.

The CSX National Gateway will enhance three existing rail corridor that run through Maryland, Virginia, North Carolina, Pennsylvania, Ohio, and West Virginia. The capacity improvements will extend to a new intermodal yard in North Baltimore Ohio. This facility will serve all traffic from the East or Southwest to the Midwest and divert some traffic

from Chicago. The facility will take traffic from locations such as the Port of Savannah or the Port of New York and will build dedicated trains to Chicago that can be handled on to the western rail carriers, Union Pacific and BNSF, resulting in what is known in the industry as “block swap” (grouping containers or cars to go to a single destination). CSX is also relocating its northern headquarters from Chicago to the new North Baltimore intermodal terminal in 2011. (Report #8)

## Water Transportation

### The impact of the Panama Canal

Between 2009 and 2012, the Canal will reach maximum sustainable capacity. Therefore, the Panama Canal Authority in March 2009 took steps to begin a \$5.25 billion construction plan. In announcing bids to build locks on Panama’s Atlantic and Pacific coasts, the authority set in motion an effort to assure available capacity. The project will add a third set of locks by 2014, and will allow the canal to handle ships with nominal capacities of up to 12,600 TEUs; this is more than double the approximate 4,800 TEUs, which is now considered Panamax. The “new” Canal will double capacity and allow more traffic; allowing the canal to meet the changing economics of ocean shipping. In recent years, container shipping has become the Canal’s primary income generator and main driving force of traffic growth. Between 1999 and 2004, the Canal’s share of the Northeast Asia / U.S. East Coast container trade grew from 11% to 38%.

Before and after schematic of the original locks and the new third lane locks

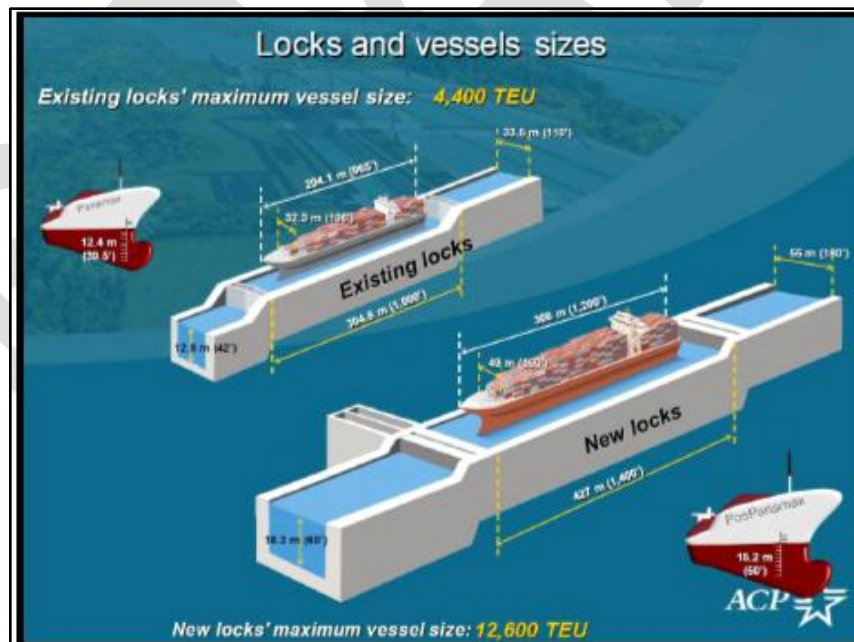

The average size of ships is increasing rapidly:

- In 1999, 2% of ships were over 5,000 TEUs, with a total capacity of 4 million TEUs.
- In 2006, 10% of ships were over 5,000 TEUs, with a total capacity of 8 million TEUs.
- In 2011, it is estimated that 50% of the global shipping fleet will be over 5,000 TEUs.

*"We anticipate that after 2014, the workhorse of the industry in the U.S. East Coast will be the vessel in the range of 6,000 to 8,000 TEUs," said Rodolfo Sabronge, the canal authority's vice president of research and market analysis. "They offer more flexibility to vessel operators and are in line with infrastructure investment plans in the East Coast and Gulf regions."*

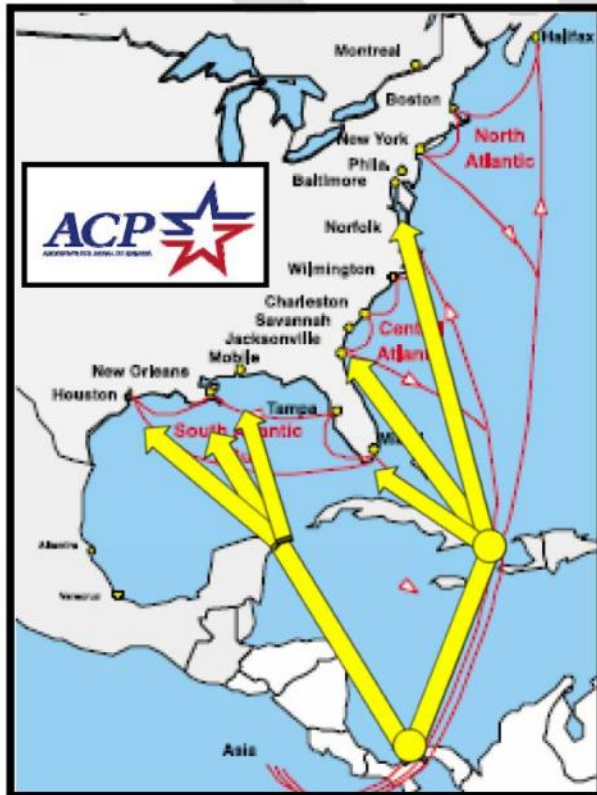

Panama Canal vessel deployment will determine new U.S. port and landside access patterns. The direct distance to New Orleans and Savannah via the Panama Canal is identical. However, each Port has very different landside road and rail access to the U.S. Heartland. (Source: Vickerman Tembec Study)

Richard Wainio, Port Director at Tampa, Fla., said his port and others along the Gulf Coast would be able to handle ships beneath the size of the post-Panamax giants. "Every port doesn't need to be able to handle the biggest ships," he said. "If you've got 40 feet of water, you're going to see an increase in your volume, post-2014." "Tampa expects growth in container trade after expansion of the Panama Canal is completed in 2014. Growth could come through direct calls or through containers transshipped through Caribbean

and regional container hubs that canal handle the largest container ships

Wainio foresees services in which large vessels will transit the canal, drop cargo at a transshipment point in Panama or the Caribbean and continue on to a couple of larger U.S. ports that serve markets large enough to support direct calls. Transshipment adds transit time, but Wainio said that could be minimized by careful scheduling and efficient hub-and-spoke operations. "Post-2014, I don't see a lot of East and Gulf Coast ports that can handle the bigger ships straight in," he said, "but I do see opportunities for regional ports in conjunction with two or three really big deep-water ports."

Wainio, who served 15 years as chief economist at the U.S. Panama Canal Commission, said he thinks canal officials are conservative in predicting all-water services eventually will carry 50 % of U.S. import volume from Asia. "The bottom line is that as the pie grows, there will be a lot more opportunities for carriers," he said. "I think that once the markets start to recover and we get closer to 2014, some of these carriers are going to be chomping at the bit to put some of these ships into Panama. I think they're going to be ready to go and you're going to see a fairly quick movement in that direction."

**But will the Panama have an impact on shipping trends? ... Will the market share shift between the West and East Coasts in the future?**

In 2009, many Supply Chain Officials and importers felt the change would shift supply chains (from the West to the East) that have built Southern California's ports into behemoths of trade.

Two recent studies by Drewry Supply Chain Advisors and the Dutch consulting firm Dynamar predict Atlantic and Gulf ports could seize up to 25 % of the West Coast's cargo base during the next decade. "Even if volumes grow, the West Coast's trade share will decline," the Drewry report said.

The consulting firm, the Tioga Group, said in a rebuttal, that the Drewry report "understates the importance of transit time and reliability in shipper routing choices and the role of the Southern California consumer market" and "ignores the substantial investments being made in West Coast port and rail intermodal capacity, and significant capacity limits on alternative routes."

Tioga said it is likely there will be growth opportunities for intermodal services via the West Coast as well as all-water services to the East and Gulf Coast; especially once the economy permits resumption of a decades-long trend toward increased container volume

"If I were an importer, I'd be thinking about what ports will open up, whether I need a distribution center there, and whether I should do some transshipment. The flow is mostly west-to-east now, but shippers need to prepare for east-to-west as well." Clifford F. Lynch, executive vice president of CTSI, a supply chain technology and services provider in Memphis.

A June 2010 article in the Journal of Commerce states: importers say the proposed toll increases effective January 2011, are unlikely to slow the shift of cargo from the West Coast to the East Coast via the all water service. But carriers believe the toll hikes will make alternatives such as the Suez Canal or intermodal rail land bridge more competitive. Carriers say the toll hikes will likely fuel the search for alternative routes, since they will pass the increases on to their customers.... Especially as the Southern California ports realize their fees are causing cargo diversions.

Carriers feel shippers may opt for the less-expensive Suez Canal route to the East Coast from South China and South and Southeast Asia --- especially if the slower transit time is not a factor.

The Panama increase will likely result in tolls on container ships rising nearly 14%.

The West Coast's share of the Asian container trade dropped from a high of about 80% in the 1990's to slightly less than 70% in 2010. When U.S. foreign trade declined during the 2008-09 recession, container volumes at most U.S. ports fell, but the market share in the U.S. – Asia trade did not change.

2009 Market Share ... U.S. Containerized Ocean Trade with Asian Countries			
	<u>Exports</u>	<u>Imports</u>	<u>Total Trade</u>
<b>U.S. East Coast</b>	31%	29%	30%
<b>U.S. Gulf Coast</b>	3%	2%	2%
<b>U.S. West Coast</b>	<u>66%</u>	<u>69%</u>	<u>68%</u>
<b>Total U.S. Ports</b>	100%	100%	100%

Panama Canal tolls will increase in the coming years to pay the canal authority's \$5 billion debt. However, the higher tolls probably will not be enough to shift cargo back to intermodal services through the West Coast.

The director of the National Ports and Waterways Institute in Maryland believes the market has reached a point of equilibrium, at least until a bigger wider Panama Canal opens. Even then, the modernized canal may produce only a "small bump" in market share for East and Gulf ports rather than an opening of the floodgates as some port executives in the regions predict. Although several factors contributed to the shift in market share during the past decade, the biggest factor favoring the all-water route has been the relatively low cost of serving major East Coast markets by direct services.

The freight rate for moving a 40-foot container from Hong Kong to New York via ocean service to LA and intermodal rail to the East Coast is about \$3,500 (according to Drewry Shipping Consultants). The all water route to New York is about \$3,100, for a savings of \$400 to \$500. However, the benefit of moving via the West Coast is a savings of seven days in transit. For high-value or time sensitive shipments, the shorter transit time is critical.

Today the East Coast ports have a lock on much of the Asian cargo destined for the immediate eastern seaboard, but they face an uphill battle against West Coast intermodal services for the lucrative markets stretching from Chicago to the Ohio Valley and down through Kentucky to Atlanta.

Asaf Ashar, director of the National Ports and Waterways Institute in Bethesda, only sees the East Coast picking up 2 to 3 percent points in market share when the 8,000 TEU and larger vessels regularly transit the canal. "Most of the diversion of cargo from West Coast ports that was expected to occur because of the all-water services already has occurred". The main benefit of the wider canal will be that it can accommodate the natural growth in cargo volume that will occur in the East Coast populations' centers."



Reasons for the lack of a major shift:

- The fact that retailer import distribution centers are already largely completed at major distribution centers in the U.S.
- Reliability of all-water services has already been proven

Nevertheless, East Coast ports are deepening harbors, expanding container terminals and developing rail infrastructure to interior markets in anticipation of a further diversion of cargo from West Coast gateways. NS Rail has completed its Heartland Corridor double-stack project between Hampton Roads Virginia and Chicago. CSX Intermodal is building its Gateway corridor from mid-Atlantic ports to Chicago in anticipation of growing cargo volumes to the Midwest.

However, the increased cost and transit time of serving even relatively close-in markets such as Atlantic and the distribution hubs in the Ohio Valley via truck or intermodal service from East Coast ports can diminish the economics of all-water services. The seven-day transit time disadvantage of all-water services will decrease even further, and the \$400 to \$500 cost savings inherent in all water services to the east Coast will disappear because of the added transportation costs of servicing the inland markets.

East Coast ports also face costly terminal expansion and projects to deepen harbors to accommodate the larger vessels that will transit the canal.

- Norfolk appears ready
- Ports in the Southeast as well as New York-New Jersey must deepen their harbors. In addition, New York – New Jersey has the Bayonne Bridge height problem.
- Maersk Line sees the Suez routing to the East Coast as another growth opportunity for the East Coast ports, except for the infrastructure limitations. (see separate comments on the Suez Canal opportunities)

Meanwhile West Coast ports already have depths of 50 feet or greater, which the larger ships need. Oakland and the Pacific Northwest ports have significant excess terminal capacity. BNSF Railroad and Union Pacific are well along on double tracking their corridors to the Midwest. The western railroads now offer expedited intermodal services to market such as Atlantic, where they compete with the all-water services to the East Coast. Plus, the market share of the Asian trade for reverse intermodal services for the East Coast ports to inland destinations remains in the low single-digits.

The following is based on comments at the September 2010 East Coast Maritime Conference in New Jersey, as reported by Peter Tirschwell in a October issue of the Journal of Commerce.

*“After listening to the speakers at the ECM event, I came to this conclusion: Bigger ships are coming to the East Coast, but it’s less of a certainty that they will bring more cargo overall. The workhorse all-water vessel will grow from today’s 3,500- to 4,000-TEU ship to 6,500 TEUs or more, with the likelihood that 8,000-TEU ships will eventually start to call East Coast ports regularly. The urgency of deepening the Savannah River,*

*eliminating air draft restrictions at the Bayonne Bridge at New York-New Jersey, and lengthening berths at several ports is obvious.”*

“This entire infrastructure is critical as these ports compete for the larger fleet that will be coming,” said John Martin, principal of the Martin Associates port consulting firm. However, the number of ships overall to come through the Panama Canal may remain stagnant or even decline. “It could be that fewer ships come” to the East Coast, Martin said.

### **The impact of the Suez Canal**

Traditionally, it is believed that Singapore serves as the geographical splitting point when choosing the fastest all-water deployment to the U.S. East Coast. North Asia cargo moves most quickly via the Panama Canal while carriers using ports in Southeast Asia take the western route via the Suez. Technically measured (in nautical miles) the non-stop distance between Hong Kong and New York via the Suez is only 350 miles longer than transit via the Panama Canal – less than one day’s difference for a containership traveling at 22 knots. An advantage of the Suez is that it offers considerable intermediate port call load and discharge cargo opportunities in the Indian Subcontinent and the Mediterranean.

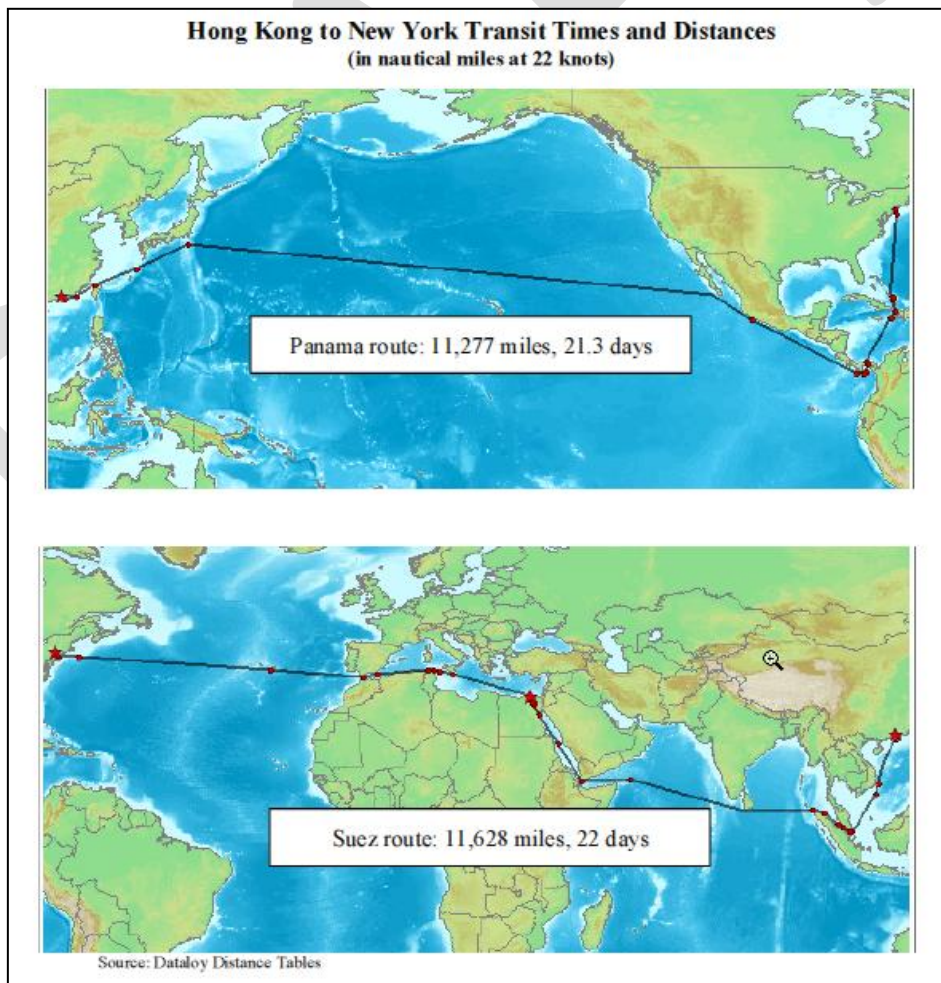



The Southeast Asia containerized shipping market place, a large part of the Intra-Asian container trade volumes, is at a critical tipping point wherein large Southeast Asian origin cargo volumes, which currently flow westbound to the West Coast of North America, could be easily diverted in a reverse flow (Eastbound via the Suez Canal route to the East Coast of North America) at a lower cost and faster transit time.

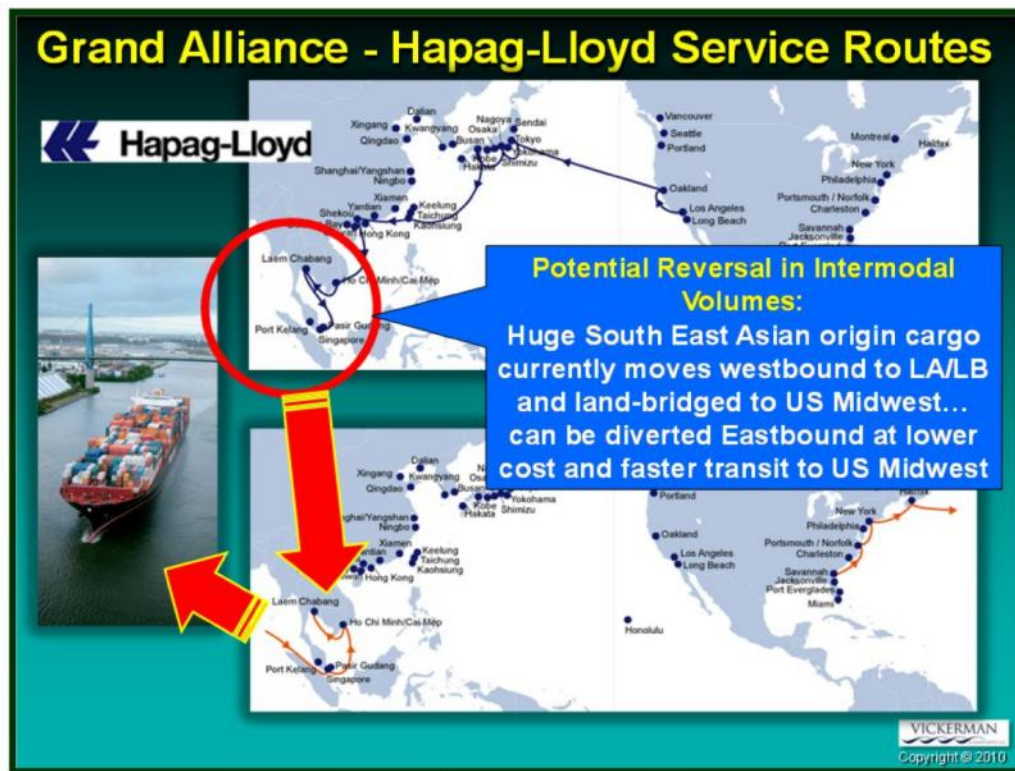

Halifax is reached faster from Hong Kong via the Suez, which makes it a prime candidate to be the first port of entry to the North American intermodal network. Hong Kong to Halifax via the Suez is 476 miles shorter than through the Panama Canal.

An Asia – U.S. Suez service requires at least one or two more vessels to maintain a weekly rotation than a similar service via the Panama Canal.

It is projected that the Suez will not raise nominal toll rates before 2015, and then raise them again in 2025. Based on historical precedent a 5% increase is possible both years. Canal traffic continues strong, and is forecast to expand at or above estimated world trade growth over the next decade.

A difference of opinion centers on the impact of the Panama Canal's proposed toll increases on container ships and loaded containers, and whether the rate hikes are enough to alter distribution strategies. Carriers believe the toll hikes will make alternatives such as the intermodal rail landbridge or the Suez Canal more competitive. Carriers say the toll hikes are

likely to fuel the search for alternative routes. They say they will pass the increases along to their customers one way or another. Carriers also say shippers may opt for the less-expensive Suez Canal route to the East Coast from South China and South and Southeast Asia, especially if the slower transit time is not a factor.

But today, the carriers are charging a surcharge for shipments through the pirate-infested waters of the Gulf of Aden, which tends to offset any cost advantages of the Suez route.

Maersk Line, a big user of the Suez Canal, disagrees. “We have seen an increasing number of (U.S. East Coast) all-water strings transiting through Suez. If the Panama Canal option is uncompetitive, this trend will continue,” said Lars Mikael Jensen, Maersk’s vice president, network and product, Pacific trade. “

The Suez Canal Authority completed its planned phase to increase the Canal draft to 66 feet in January 2010. This allows the canal to accommodate 100% of all the fully loaded container ships and 96.8% of all the fully loaded bulk carrier fleet. In addition, the Authority is conducting feasibility studies to improve its services and to reduce transit times by increasing the depth of the current bypasses, and dredging new bypasses.

## The Advantages of Water Transportation

Water ports, by nature, are intermodal. Freight traveling by water must arrive and depart by another transportation mode. Intermodal connectors are roads that provide access to water ports or rail services. Truck congestion on or near the intermodal connections affect ports that rely on trucks for commodity transfer. Improvements to roadways that connect to ports increase the efficiency of ports, benefit trade, and contribute to employment growth and regional productivity.<sup>ii</sup>

Water transportation reduces highway congestion and deterioration. One fully loaded barge carries the equivalent of 59 trucks. Water transportation is environmentally beneficial. A fuel comparison suggests that a river barge can travel as far on a tablespoon of fuel as a train on a cup or a truck on a gallon!

Transporting freight by water is the most efficient energy choice. Barges move a ton of cargo 576 miles per gallon of fuel. A rail car would move the same ton of cargo 413 miles, and a truck only 155 miles.

The AEP River Operations (provide barge transportation of dry bulk commodities throughout the inland river system) reports even better ton-mile efficiency at 642.23 miles per gallon

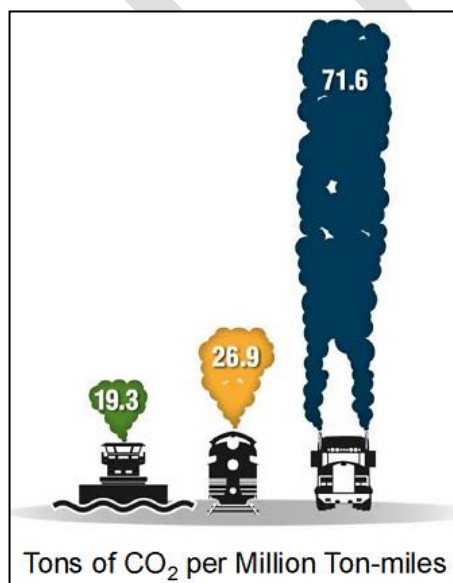
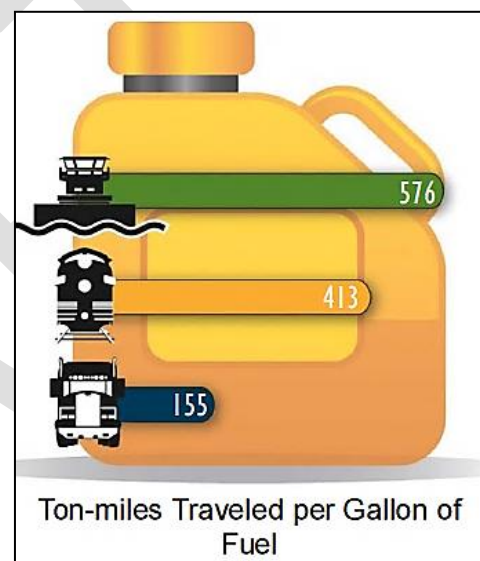

Inland waterway shipping also is the greener way to ship. Inland river barges produce less carbon dioxide. In terms of CO<sub>2</sub> produced per ton of cargo moved, inland river barges have a significant advantage over trains and trucks



One 15-barge tow equals 216 rail cars or 1,050 trucks

In Europe, the EU promotes waterways as an economically friendly alternative to highways and rail. A container-on-barge system is highly developed in Europe.





## Great Lakes – St. Lawrence Seaway<sup>iii</sup> (GLSLS)

The Great Lakes and St Lawrence Seaway System (GLSLS) provides a 2,300 mile system



stretching from, the Gulf of the St Lawrence River to both the industrial heartland of the Midwest, Central Canada and the agricultural and natural resource areas of the Great Plains and Praires. It serves more than 30 ports between the gulf and Duluth. The Seaway has long played a role as a vital transprotation link for this region’s rapidly expanding and dynmic economy. The GLSLS has six canals incorporating 19 major sets of locks. These locks limit the size and speed of vessels that can use the system. The maximun size of vessels that can use the locks is 740 feet long, 78 feet wide and a draft of 30 feet.

The GLSLS has experience little to no growth in either tonnage, or transits in the past 10 years.

St. Lawrence Seaway Vessel Transits

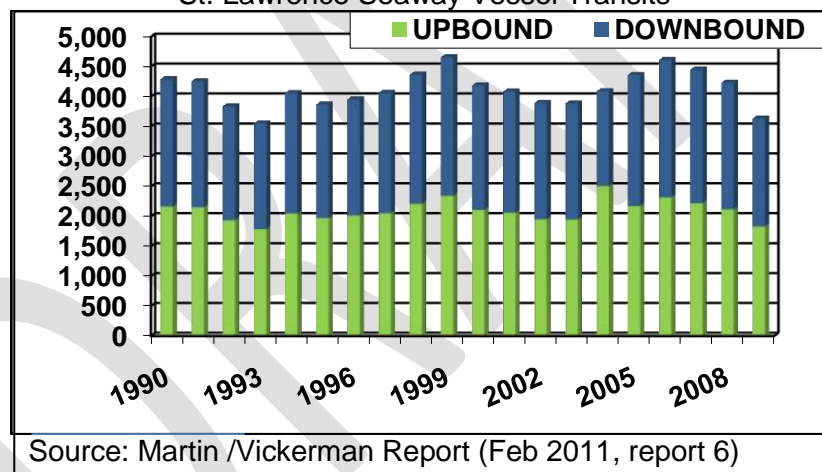

Total Great Lakes Tonnage US Ports – Foreign and Domestic Tonnage

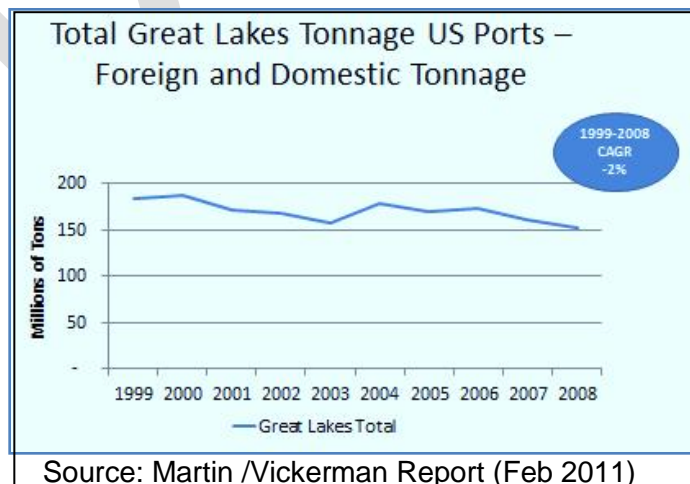

The dominate type of tonnage shipping is traffic between United States ports on the Great Lakes System. Coal and crude materials are the largest waterborne tonnage item.

Great Lakes (short ton) traffic trends

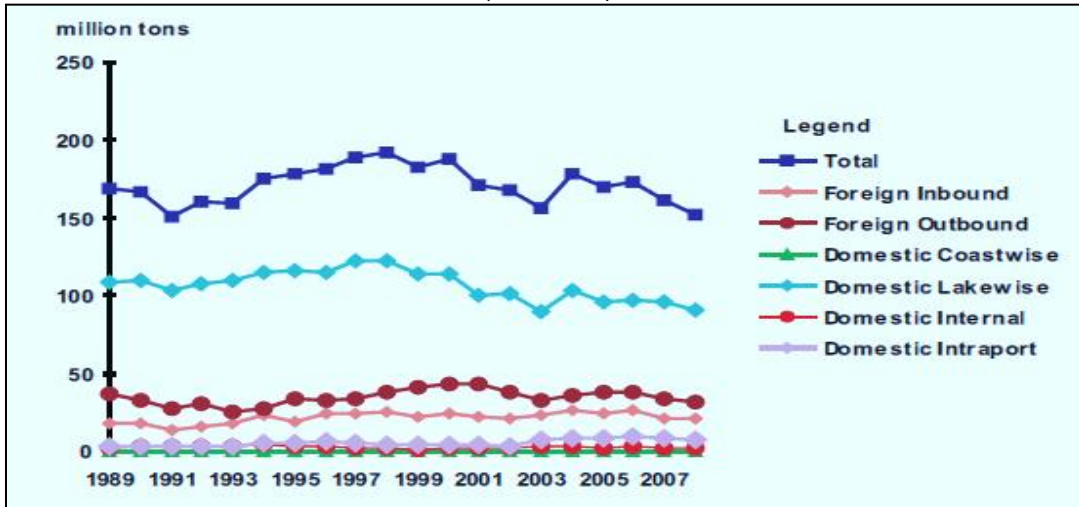

	1999	2000	2001	2002	2003	2004	2005	2006	2007	2008
<b>Total</b>	<b>182.9</b>	<b>187.5</b>	<b>171.4</b>	<b>167.2</b>	<b>156.5</b>	<b>178.4</b>	<b>169.4</b>	<b>173.0</b>	<b>161.0</b>	<b>152.4</b>
Foreign										
Inbound	22.2	23.9	22.0	21.5	23.3	26.1	24.1	26.1	21.5	20.9
Outbound	40.8	42.9	43.6	38.4	33.1	36.4	37.5	37.5	33.8	32.2
Domestic										
Coastwise	-	0.0	-	-	0.0	0.0	-	0.0	-	-
Lakewise	113.9	114.4	100.1	101.6	89.8	103.6	96.3	96.9	95.7	90.4
Internal	1.5	2.1	1.7	2.5	2.8	3.7	2.6	2.7	1.7	1.8
Intraport	4.4	4.2	4.0	3.2	7.4	8.7	8.9	9.7	8.2	7.1

\* Foreign Outbound includes Great Lakes Thru Foreign Traffic.

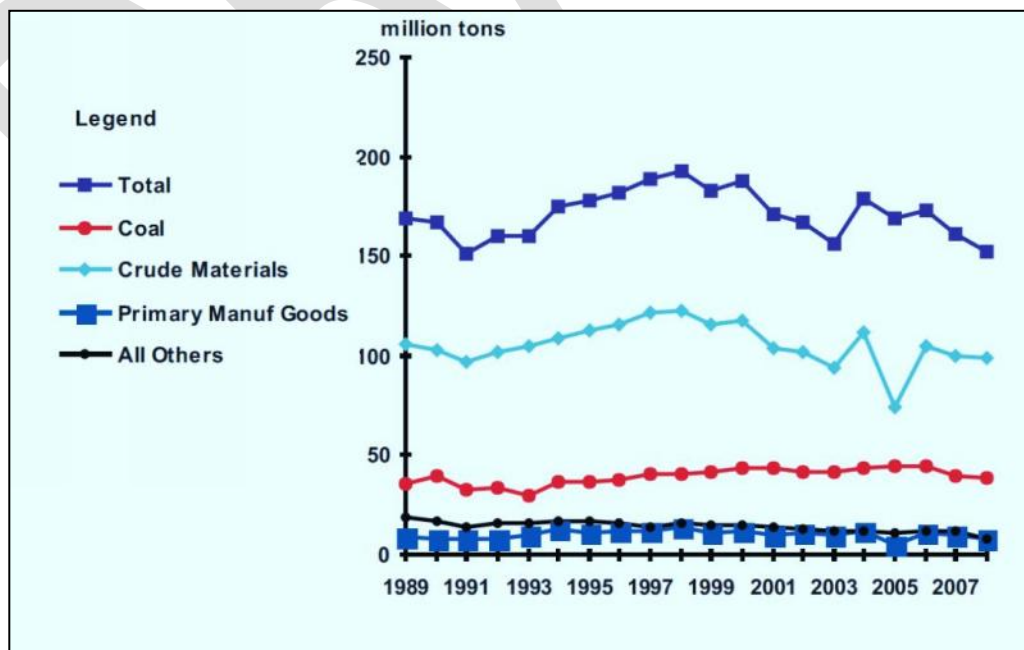

Source: Waterborne Commerce of the United States (report #25)

**International cargo/seaway transits have shown no growth over time**

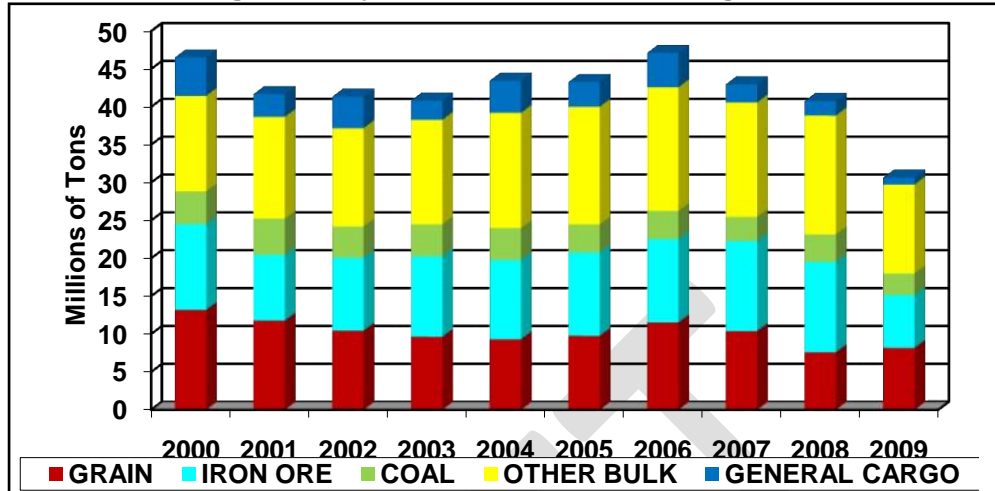

Source: Martin /Vickerman Report (Feb 2011)

While the Seaway moves over 200 million tons of traffic each year, more than 90% of its cargo is bulk traffic and most of the rest is neobulk such as steel. As stated above very little container traffic moves on the GLSLS.

Historically the GLSLS has largely been focused on bulk traffic such as grain, coal, and ores. But this traffic has shown no growth in the past 10 years. It takes about 10 days for a ship to go from one end of the System to the other end, while it only takes rail or truck no more than 3 or 4 days. In addition, rail operators have improved their competitive position in the last ten years by introducing intermodal double stack train operations.

**Great Lakes Steel Imports are Volatile**



**Plus the Gt. Lakes Impts of Aggregate – Limestone & Cement have shown little growth**

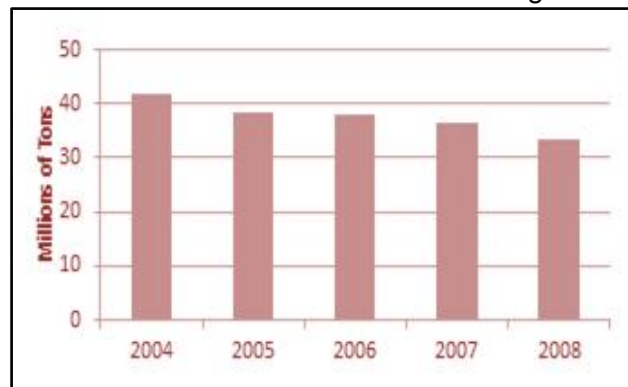





As the region's population, employment, GDP, and trade are projected to grow significantly through 2050, the region's freight traffic is expected to expand at an even faster rate. It is anticipated that a growing share of traffic moved by all modes of transportation will be by containers. The total market for container traffic to and from the region is expected to more than double by 2050 from 35 million to over 70 million 40-foot equivalent units.

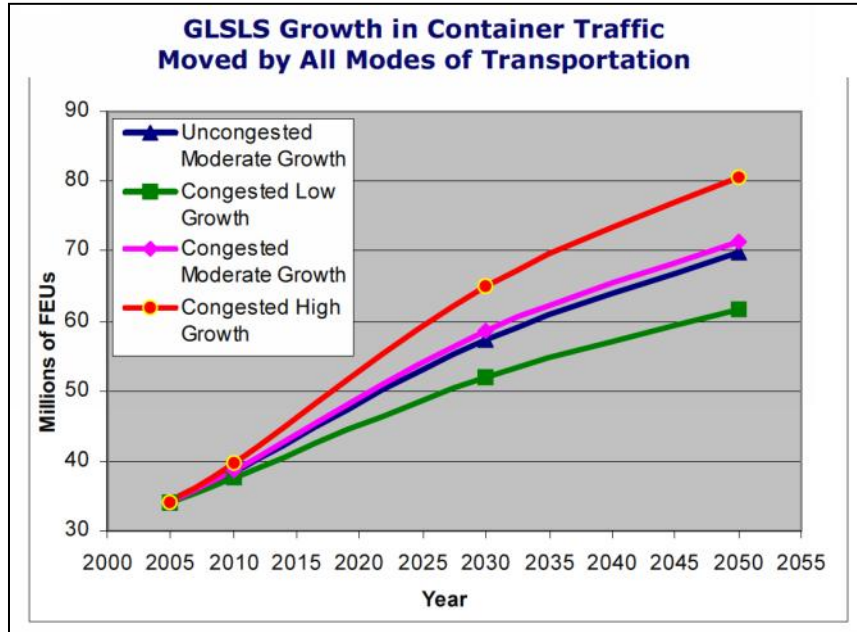

However, this growth will create issues. Today and in the future trucks will move a significant amount of containerized freight (98% in 2005), followed by rail at 2%. However, available highway and rail capacity is suffering from deteriorating levels of service. With railroads, a move to increase production over the past two decades resulted in increased concentration, amalgamation, and abandonment of secondary lines. As a result, moving containers by truck and rail in the future will cost more and probably take longer, since traffic is expected to outgrow any improvements in capacity and congestion is expected to increase.

The net effect of this continued economic growth, and capacity limitations on the GLSLS region's highways and railroads is an increased potential of water to play a role in the transportation of container and palletized traffic.

In the region if the highway infrastructure is not able to absorb the 88% increase in road freight traffic, due to the inability to mitigate bottlenecks, both water and rail traffic could increase. In the case of water, it could grow to as much as an 8% share without reaching GLSLS waterway capacity restrictions. (Report 3A)

The physical characteristics of the Seaway limit the size of ships that can enter the Great Lakes. Goods transported to East Coast ports need to be transloaded to smaller vessels that can transverse the Seaway. Given that the Seaway is operating at just 60% of capacity, it is unlikely that future investment would be warranted for widening. Another issue is the Jones Act. The act requires that all shipments from a Seaway port to another U.S. port be on a U.S. flagged vessel. This requirement hampers flexibility of operations --- an international vessel cannot deliver between U.S. ports.

In addition, for future growth the infrastructure of the ports on the Great Lakes need to be improved. In addition, the Harbor Maintenance Tax (HMT) is a disadvantage for the Seaway.

The 2,300-mile system includes 15 major ports and some 50 regional ports that are connected to more than 40 provincial and interstate highways as well as 30 rail lines. As a result the System connects the manufacturing, agricultural, and mining area of Central Canada, the

Midwest, and the Parries and the Great Plains. Each area while different is both a producer and consumer of goods and services and therefore a candidate of container traffic, but the major issue is seasonality. The System typically opens in late March and closes in late December, a period of 274 days. While the months of January, February, and March are typically some of the slowest months for manufacturing and the retail industry the inability to offer service at this time is a major limitation for the expansion of additional services. During the down period shippers and carriers must look for alternatives. Then once they build relationships, negotiate contracts, and develop a dependable logistic chain, it is difficult to see why they would return to the Seaway system. Most shippers and carriers are looking for seamless logistic systems negotiated for a given business cycle.

The Maier Melford Port Project is a planned intermodal port project that has the potential to have a major impact on the St. Lawrence Seaway. The planned project is forecast to be operational in 2013 as an ice-free terminal on the south side of the Canso Strait in Nova Scotia facing the Atlantic Ocean. The proposed terminal would be the closest container port to northern Europe and to the Strait of Gibraltar. The facility will start as purely an intermodal rail terminal that depends on a link to Canadian National Railroad to carry cargo to and from the Canadian and U.S. Midwest.



The terminal will become a transshipment hub for feeder services up and down the east coast and to the Great Lakes. Over time Short Sea Shipping opportunities will be created whereby smaller feeder vessels and container barges will be used to serve smaller secondary ports in Canada and North Eastern U.S. as well as taking a full advantage of the St. Lawrence Seaway System.

Can the role of the both the Seaway and the U.S. Inland Waterway System be expanded to include Container shipments?

Given that in Europe and elsewhere considerable container traffic moves by water, the question arises as to whether or not the GLSLS and the Inland waterway system is fulfilling its potential and whether or not there are additional roles that they might play as part of the North American Transportation System.

Containers more finished or semi-finished products in a “just in time” environment, which has made container traffic a highly time-sensitive payload what would be attracted to the waterways only if they offer competitive rates and transit times.

Typically, water transportation has been able to offer the lowest price. However, while price dominates bulk transportation, it is far less important in the movement of container traffic in which transit time and a wide range of other services play a major role. With bulk traffic, the focus is on the lowest rate per ton. In the case of container traffic, the focus is on transit times and the ability to reach certain markets by a given deadline. As a result, for container water shipments whose transit times are slower than truck and rail, it will be important to obtain the maximum economies of scale possible by boosting capacity as much as possible to minimize the average cost per container moved by water.

An area where container traffic might be able to expand under the current conditions on the waterways is where, as is the case of bulk cargo, the capacity limitations of the existing rail and truck networks become problematic. In this environment, an improved waterway container system would generate opportunities.

In terms of long-term change and growth, container traffic offers the greatest opportunity. Container traffic is growing very rapidly while the demand for bulk cargo is much lower. The projected annual growth rates for container traffic range between 4 and 6% and even higher whereas it is only 1 to 2 percent for bulk cargo (Great Lakes-St. Lawrence Seaway Market Assessment Report, 2007). The movement of bulk cargo grew quite strongly in the 1980's, but it has been slowing down in the recent years. The Mississippi River System carried in 2001 the same cargo it carried in 1995.

Over the next twenty to thirty years, if current trends continue, the freight volumes will increase by at least 70 to 100%. In addition, trade volumes are also forecasted to increase significantly. The existing infrastructure will find this difficult to handle due to capacity limitations and once existing modes reach full capacity, cargo will seek new opportunities to reach markets. At this point waterway systems will become more competitive and more attractive for container traffic.



## Inland Waterway System

To improve the flow of containers on the system, new vessel technologies are being developed, such as Container on barge (COB), following the success of this technology on the Rhine/Danube River System in Europe. In addition, new high-speed river and coastal vessel technologies capable of speeds greater than barges are currently being research in Europe.

### Container on Barge



COB service is provided on many European waterways, as well for short sea shipping. However in North America it is perceived as being too slow as compared to rail or truck shipping. A higher speed at a competitive cost is the critical requirement for being able to attract traffic to the waterways from truck and rail.

For the shipper, there is a tradeoff between the savings on inland transportation costs that COB represents and the additional time required to complete the all water transit is the question. For instance, after a container is loaded to a rail car in the New Orleans area it will be available at the Memphis ramp within 24 to 36 hours. For approximately 1/3 the cost and an additional 3 days (4 days total), the same container would be available at the Port of Memphis.

COB also represents one of the inland transportation systems options of the immediate future.

- COB uses the existing river and inland waterway system, which does not require as much infrastructure and support as do the rail and highway systems.
- It is an ideal way to transport hazardous materials since the barges remain on the river and any spillage would be confined in a barge or lost in the river.
- It is more "green" than rail or truck requiring less gas/diesel fuel than rail or truck and certainly has less of an impact on already congested highways and rail systems.<sup>iv</sup>

A standard open hopper river barge can carry 1600 short tons on its 9-foot draft in a 12-foot navigational channel. In terms of containers, a river barge will usually "cube out" before it drafts out. This means that the cubic volume of the containers will fill the barge prior to reaching 1600 short tons. A standard river box barge will carry eighty-one 20' containers or a maximum mix of about fifty 20' and 40' containers. Northbound river barge tows routinely accommodate 20 loaded barges. A 100 rail car unit train can accommodate a maximum of 300 containers (two 20 ft. and one 40 ft. per car). The same number of containers can be carried in six full barges. River tow rates are considerable cheaper than the best rail rates.<sup>v</sup>



# The Inland Waterway System in the U.S.

## Background

Today some of the top water ports in the U.S. are not located along the U.S. coast

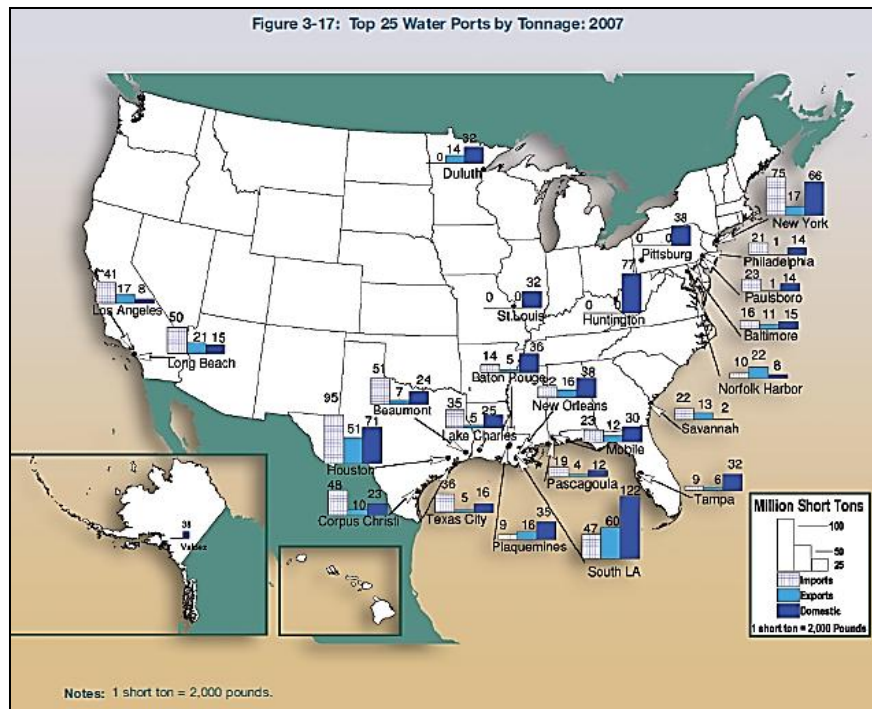

However, the inland ports are linked to the Coasts, via the inland waterway. The Inland Waterway System (IWW) is a key element in the nation's transportation system.

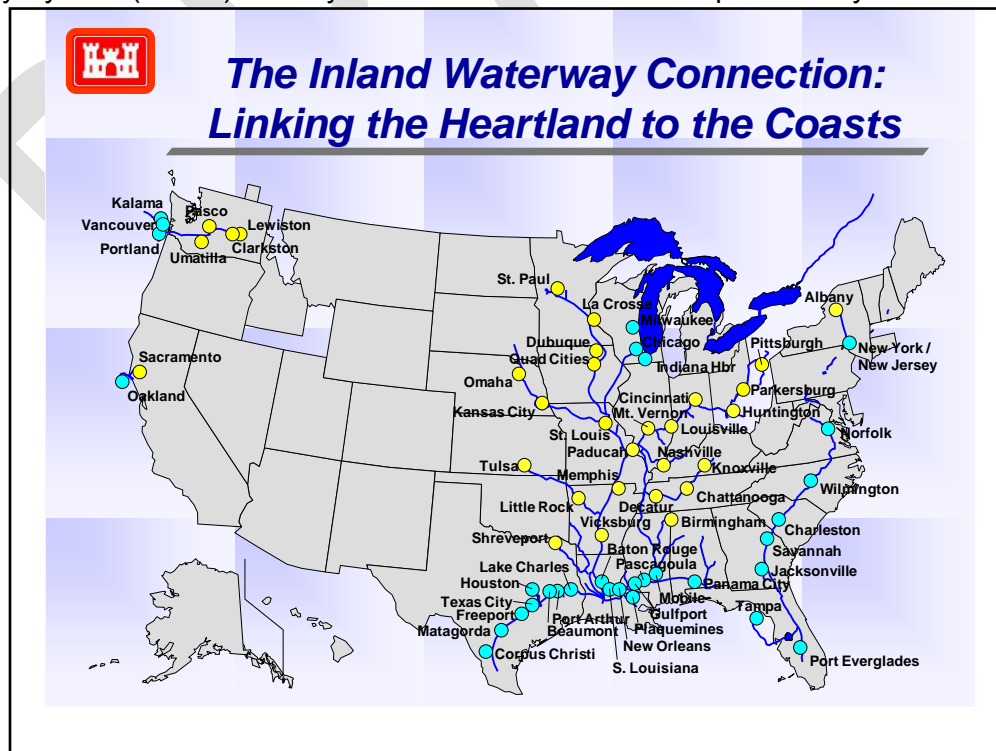



The IWWS includes approximately 12,000 miles of navigable waterways and 240 lock sites.

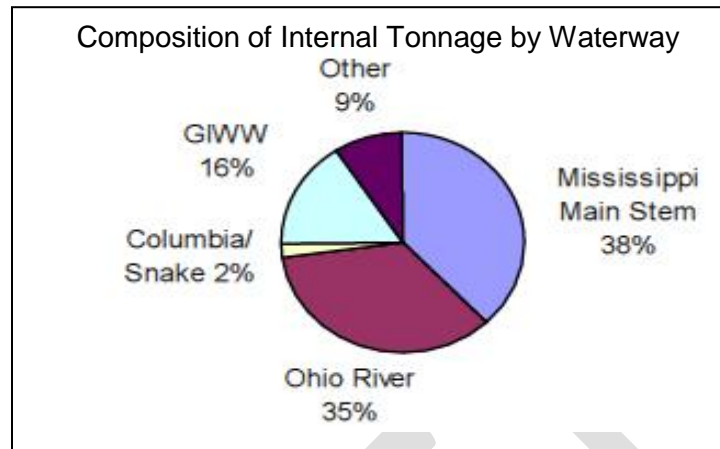

The Mississippi and Ohio waterway system in the U.S.

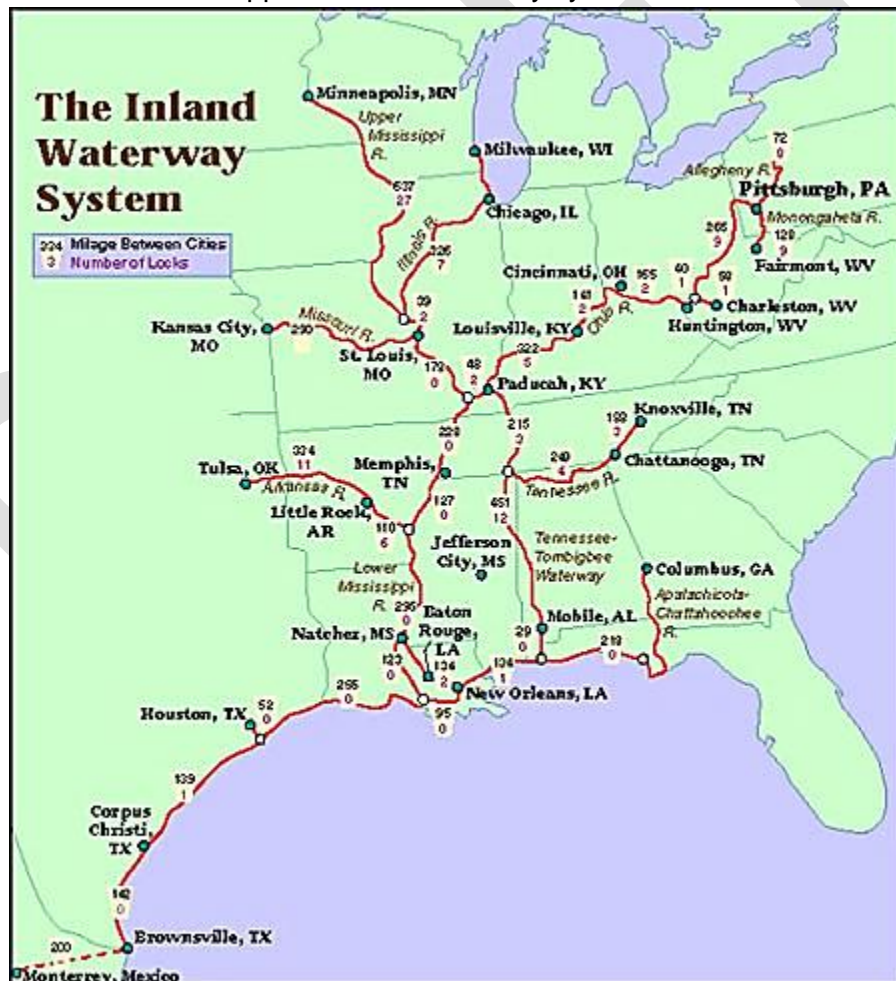

The Mississippi River System and the Gulf Intracoastal Waterway serve thirty-one states. States on the Gulf Coast and throughout the Midwest and Ohio Valley especially depend on the inland and intracoastal waterways. Texas and Louisiana each ship over \$10 billion worth of cargo annually, while Illinois, Pennsylvania, West Virginia, Kentucky, Mississippi, and Alabama each ship between \$2 billion and \$10 billion annually.....

Below is a map that shows the level to which the various states use the waterway system.

Value of IWW Cargo by State

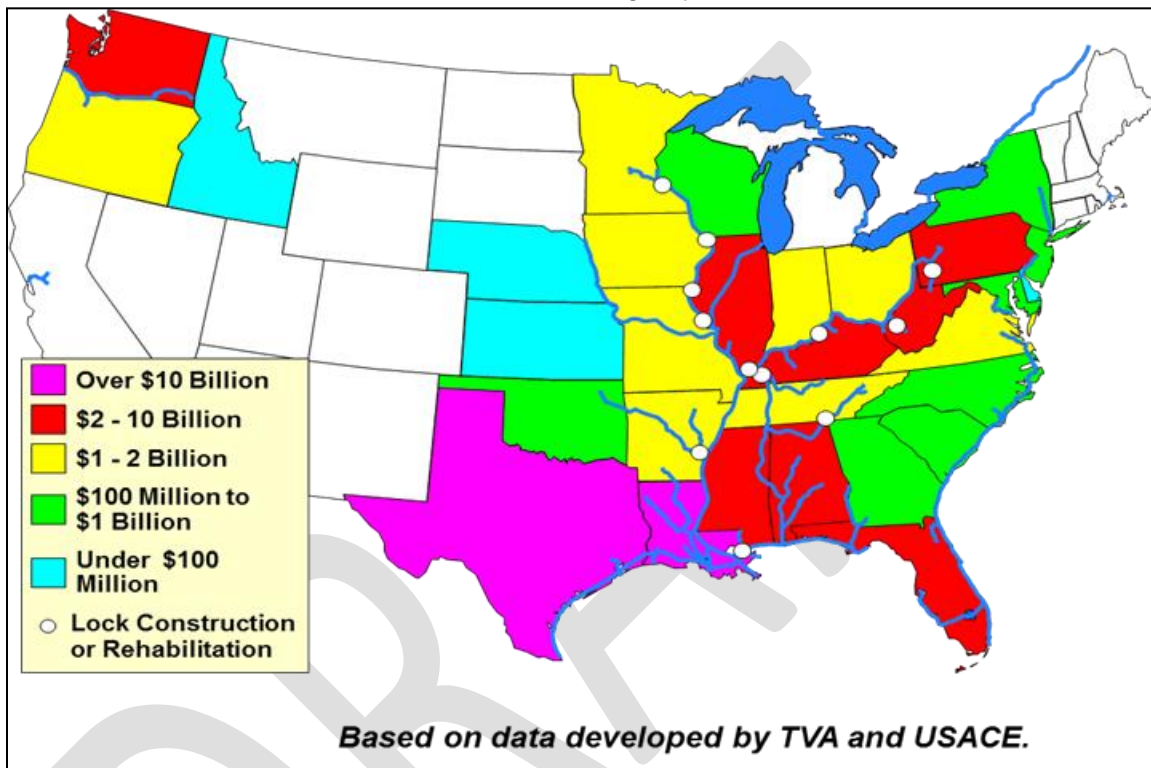

This chart shows the composition of 2008 total freight tonnage (in millions of tons) by principal commodity groups for the Mississippi River System<sup>vi</sup>. The chart shows that a very high percentage of domestic freight traffic is composed of bulk commodities – commodities that are low in value per ton and very sensitive to freight rates.

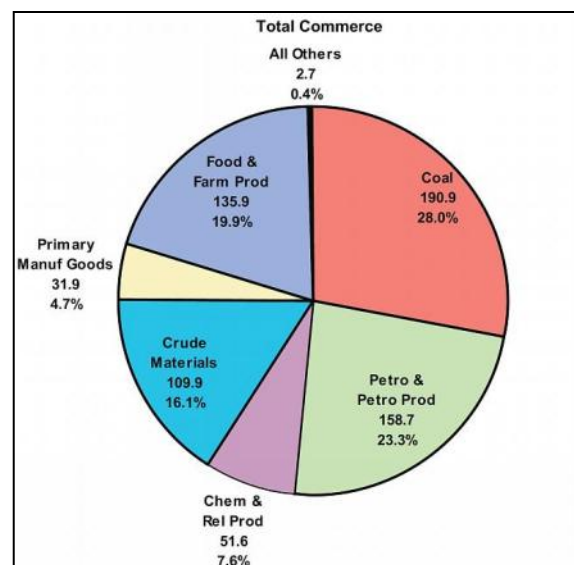

## The Inland waterways traffic

The Internal (vessel traffic that takes place solely on internal US waterways) has shown little growth over the past 20 years.

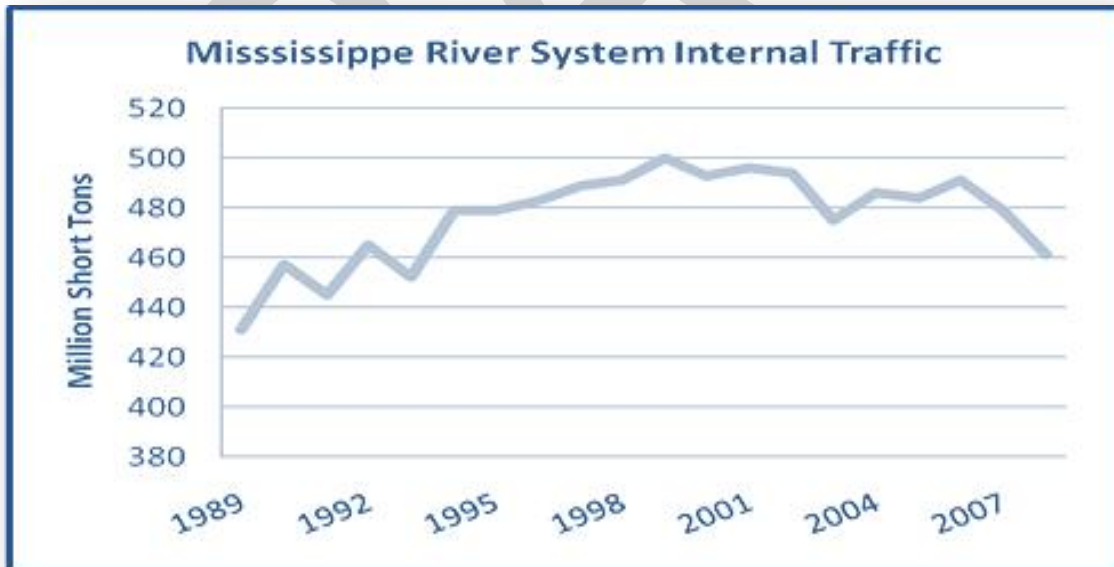
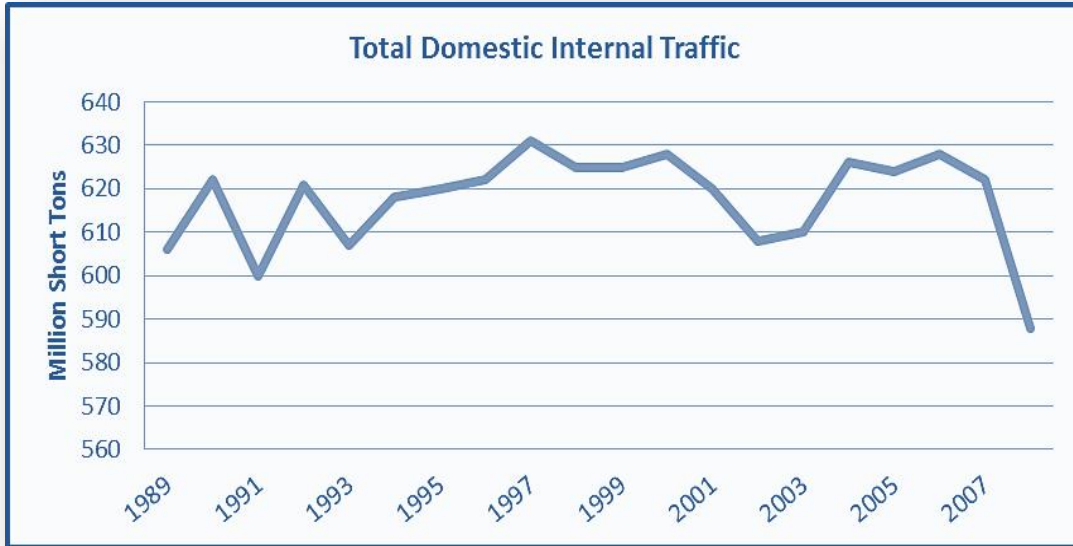

## Commerce on Selected Waterways

Internal Traffic, 1999-2008



	1999	2000	2001	2002	2003	2004	2005	2006	2007	2008
◆ Total Internal**	624.57	628.44	619.78	608.04	609.60	626.25	623.98	627.61	621.90	588.48
■ Mississippi***	329.64	327.40	316.55	316.21	308.21	312.81	299.14	313.51	313.31	295.18
▲ Ohio	240.79	236.30	242.50	243.15	228.77	238.98	249.21	241.54	230.84	230.80
✧ Tennessee	51.81	49.55	47.92	43.94	49.83	53.34	53.23	53.97	49.45	49.67
✱ Illinois	43.72	44.22	43.49	43.03	44.99	45.23	44.02	43.58	41.12	37.28
● GIWW**	109.64	113.76	112.18	107.65	117.84	123.30	116.07	122.57	125.06	115.88

\*\*Total Internal excludes waterway improvement materials, and beginning in 1996, excludes fish.

\*\*\*Includes domestic coastwise tonnage.



## Marine Highway Corridors

Public (government) interest in container barge services is growing, as is evident from the Maritime Administration's (MARAD) Marine Highways Program, which was fully implemented in April 2010. The Marine Highway Corridor routes consist of 11 Corridors, 4 Connectors, and 3 Crossings that can serve as extensions of the surface transportation system. These corridors identify routes where water transportation presents an opportunity to offer relief to landside corridors that suffer from traffic congestion, excessive air emissions or other environmental concerns and other challenges. Corridors are generally longer, multi-state routes whereas Connectors represent shorter routes that serve as feeders to the larger Corridors. Crossings are short routes that transit harbors or waterways and offer alternatives to much longer or less convenient land routes between points. By designating these Marine Highway Corridors, Connectors and Crossings, Secretary LaHood (Department of Transportation) has taken the first step to focus public and private efforts to use the waterways to relieve landside congestion and attain other benefits that waterborne transportation can offer in the form of reduced greenhouse gas emissions, energy savings and increased system resiliency. Marine Highways present a unique opportunity for developing container load centers that can offer a triple play of intermodal services





## M-55 Marine Highway Corridor

**Sponsor:** Missouri Department of Transportation

**Supporters:** Southeast Missouri Regional Port Authority, and the Ohio Department of Transportation.

**Landside Corridor Served:** Interstate-55

### **Corridor Description:**

The M-55 Corridor includes the Mississippi and Illinois Rivers from New Orleans, LA, via St. Louis, MO, to Chicago, IL, through Louisiana, Mississippi, Arkansas, Tennessee, Missouri, and Illinois. It includes connecting commercial navigation channels, ports, and harbors. It connects to the M-90 corridor at Chicago, the M-40 Connector at Napoleon, AR, crosses the M-70 Corridor at St. Louis, MO, and meets the M-10 Corridor at New Orleans, LA.

### **Attributes:**

At 2,348 miles in length, the Mississippi River is the 2nd longest river in the United States and 92 percent of the nation's agricultural exports are produced in its basin. Sixty percent of all U.S. grain exports move on the Mississippi River and the largest port in the United States (by tonnage) is located on the Mississippi at LaPlace, LA. The Port of New Orleans handled 229,067 containers (TEUs) in 2008, most of which also move inland on truck and rail.

The U.S. Department of Transportation indicates that this corridor is plagued with major freight truck bottlenecks at several points along its route, including the metropolitan areas of Chicago, St. Louis, Baton Rouge, and New Orleans, causing millions of hours in truck delay each year. In addition, the Department found that freight rail congestion is problematic for both in the Chicago and St. Louis areas. Even in rural segments, traffic studies on portions of I-55 in Southeast Missouri found that trucks account for approximately 50 percent of all daily vehicle movements.

The increased use of the Marine Highway component of the corridor in this area has the potential to reduce air emissions, conserve energy, lower highway maintenance costs, and enhance safety, although key infrastructure, including locks and dams, require modernization.

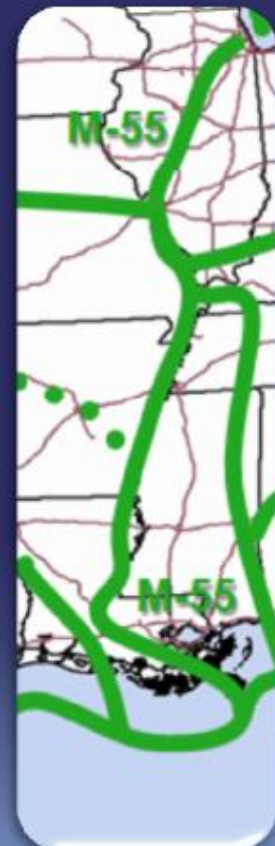



## Waterway system issues

However, while still the world's preeminent inland navigation system, the waterway and its reliability is increasingly threatened by the passage of time and the need to invest in improvement. The economic service life for navigation structures is typically 50 years and is usually extended through major rehabilitation to 75 years. Currently, 54 percent of the waterway structures are more than 50 years old and 36 percent are more than 70 years old. There are currently some projects under construction, and some of these have had significant cost increases and schedule delays. Because of strong industry and congressional support during the past decade for improving the efficiency of construction, lowering the costs of construction, and achieving the completed projects' benefits as early as possible, the surplus in the IWTF (Inland Waterway Trust Fund (USACE) has been spent down. Annual funding for system modernization is now limited to revenues as they are generated each year. This reality has contributed to increasing the backlog of needed improvements, both for new construction and major rehabilitation. For example, projects at 17 facilities have been authorized, but they have not yet received funding for construction.



### **Challenge: Aging Water Resources Infrastructure**

- Half of locks more than 50 years old
- Investments in water resources infrastructure have declined in real terms
- Result: more frequent closures for repairs, decreased performance and costly delays

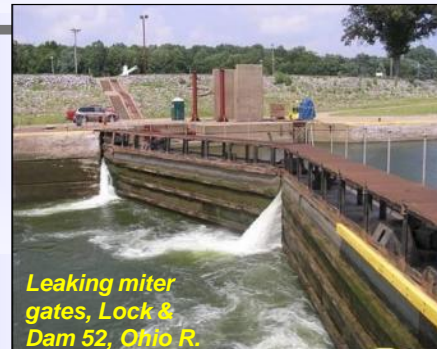

*Leaking miter gates, Lock & Dam 52, Ohio R.*



*Crumbling lock wall, Lower Mon 3, opened in 1907*



*Concrete deterioration at Chickamauga could result in lock failure*



## Meeting the Challenge: Major Navigation Projects Underway

As of 2007

Active new lock construction and major rehabilitation program underway in FY '07:

- 9 new or replacement locks
- 5 major rehabs
- \$368 million in funding
- Total investment underway of \$5.8 billion

- New Construction
- Major Rehabilitation

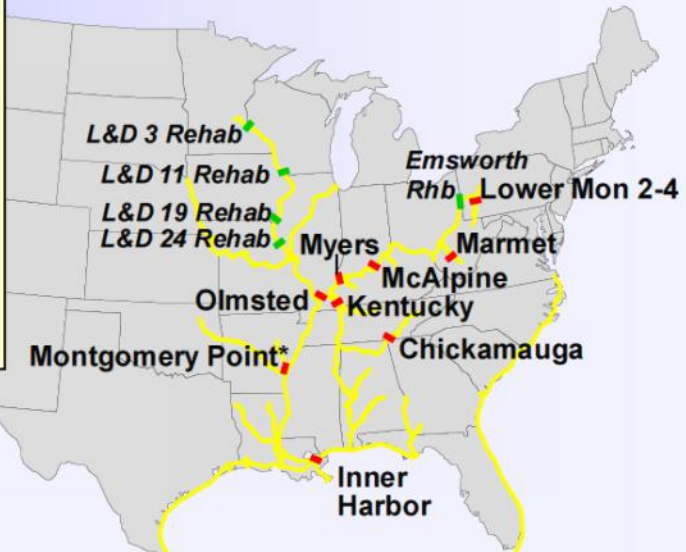

## Major Inland Navigation Studies

Potentially Leading to Projects Cost-Shared from IWTF  
2007

- Lock / Channel Improvement
- Major Rehabilitation
- System Study

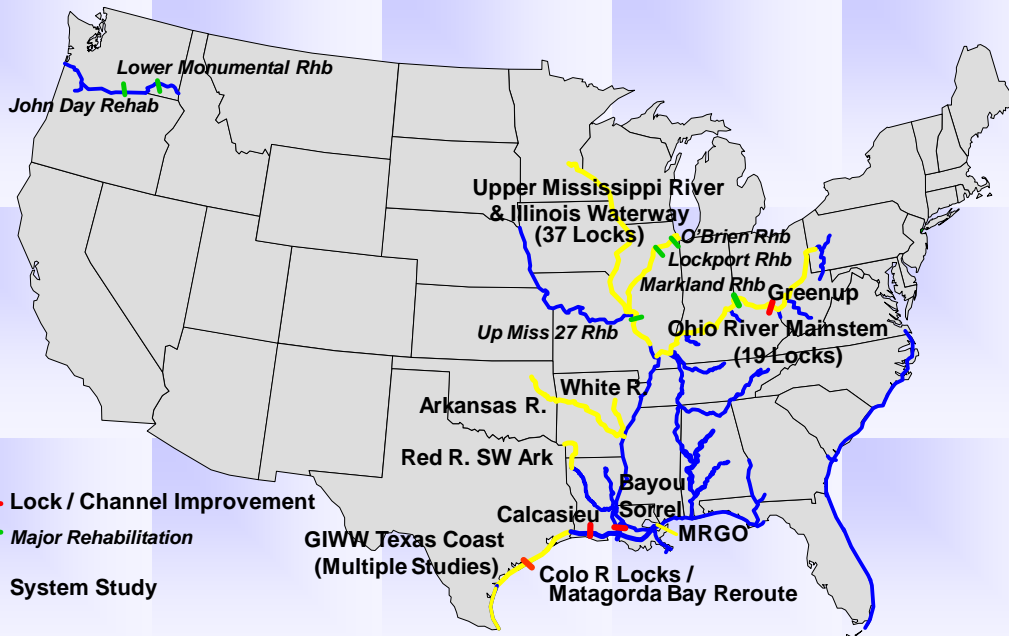

## Predicted Failures

Lower Ohio tons: 12.6 million

Middle Ohio tons: 8.4 million

Upper Ohio tons: 18 million

Project	2010		2012		2015		2020		2025		2030	
	MAIN	AUX	MAIN	AUX	MAIN	AUX	MAIN	AUX	MAIN	AUX	MAIN	AUX
Upper Ohio	Emsworth	*	*	*	*	*	*	*	*	*	*	*
	Dashields	*	*	*	*	*	*	*	*	*	*	*
	Montgomery	*	*	*	*	*	*	*	*	*	*	*
	New Cumberland	*	*	*	*	*	*	*	*	*	*	*
	Pike Island	*	*	*	*	*	*	*	*	*	*	*
	Hannibal	*	*	*	*	*	*	*	*	*	*	*
	Willow Island	*	*	*	*	*	*	*	*	*	*	*
	Belleville	*	*	*	*	*	*	*	*	*	*	*
	Racine	*	*	*	*	*	*	*	*	*	*	*
	RC Byrd	*	*	*	*	*	*	*	*	*	*	*
Mid	Greenup	*	*	*	*	*	*	*	*	*	*	*
	Meldahl	*	*	*	*	*	*	*	*	*	*	*
	Markland	*	*	*	*	*	*	*	*	*	*	*
Lower Ohio	McAlpine	*	*	*	*	*	*	*	*	*	*	*
	Cannelton	*	*	*	*	*	*	*	*	*	*	*
	Newburgh	*	*	*	*	*	*	*	*	*	*	*
	JT Myers	*	*	*	*	*	*	*	*	*	*	*
	Smithland	*	*	*	*	*	*	*	*	*	*	*
	Locks 52	*	*	*	*	*	*	D	D	D	D	D
Locks 53	*	*	*	*	*	*	D	D	D	D	D	
Olmsted	*	*	*	*	*	*	*	*	*	*	*	

\* Maintained in GOOD condition through spare gate replacement program

D Decommissioned and replaced by Olmsted L/D

	A
	B
	C
	D
	F

Source: 11/30/2010, AEP River Operations Presentation

A recent article in the Waterways Journal clearly spells out the Waterway issues



March 14, 2011 Editorial

### **A Broken River System Is Costly Burden For U.S.**

If a watch loses time and its accuracy cannot be depended upon, it is, in a sense, broken. **If a water transportation system is less productive than it should be and is not dependable, it is, in the same sense, broken. The navigation system made possible by our inland waterways is broken as a result of neglect—neglect of maintenance and modernization.**

Conceivably, the resulting financial loss can outweigh the cost of maintaining the system properly.

It is the responsibility of the U.S. Army Corps of Engineers to maintain waterways. Admittedly the agency's task is complicated by a reluctant administration and shortage of money. Nevertheless, its budgeting process seems to be askew.

Dredging (or lack of it) was the focus when Ken Wells, outgoing coordinator of the Big River Coalition, addressed the Inland Waterways Navigation Conference at Cincinnati on March 3.

Importantly, Wells spoke of the waterways as being a complete system, pointing out, for example, that the Mississippi River “connects some 14,000 miles of waterways to the Gulf of Mexico and allows some 29 states to reach export markets.” While numbers vary, he said, “the Customs District for the deep-draft section of the river reports that America ships between \$84 billion and \$104 billion worth of cargo into foreign trade every year.” The river handles almost 25 percent of all the bulk ships that call on U.S. ports. It is remarkable that the administration has paid lip service to the value of water transportation but has refused to support it. One wonders how President Obama expects to double exports within five years (his publicly announced intention).

“You can’t get there if you deliberately turn one of your main avenues for those exports into a chokepoint, and this is what the Corps policy has done,” Wells said.

The Corps announced some time back that reprogramming funds is no longer an option, and drew up a dredging plan that put the river on a starvation diet, Wells explained.

**The crux of the problem is that inadequate funds are directed to dredging. Channels not only become too shallow to handle the intended traffic, but they become narrower as well and introduce threats to safety. Vessels cannot be loaded beyond what channel depths will accommodate.**

To understand the seriousness of this financial shortage, consider that the Corps announced last September that it had only about \$63 million to dredge the deep draft section of the Mississippi River. The plot thickens when you learn that even though the area from Baton Rouge south usually costs \$85 million to dredge, the cost has averaged \$104 million annually for the past five years. According to Wells, what followed was that “we experienced the lowest river in 10 years. At the end of January, the ship pilots at the mouth of the river instituted a 44-foot draft restriction, down from the traditional 45-foot channel. Then in early February the pilots who handle ships above New Orleans instituted a combination of reduced drafts and daylight-only restrictions that effectively limited tonnage loaded at most of the grain terminals, refineries and chemical plants on the lower river.”

**By not maintaining our river system properly, we are potentially squeezing some of our cargoes out of the world market, Wells said.**

One example of the sensitivity of river reliability is that during a six-day period after Hurricane Katrina struck, the river closed. Corn and soybean prices in the Midwest immediately dropped 10–15 cents a bushel. “Uncertainty over the reliability of the river is the long-term enemy,” Wells said.

It is always perplexing that those in charge of the purse strings either don’t recognize, or choose to ignore, the importance of river-system maintenance, of which dredging is a major component. The problem is that we have a broken system and we are not moving to fix it. **The Corps has to be aware that its dredging program is inadequate. They should fight to change it and make it clear to the nation why the change is necessary.**

Admittedly, the nation’s finances are in a mess, but we cannot solve the problem by allowing our vital water transportation system to continue going downhill. It impacts the entire country. If we are unwilling or unable to maintain and improve our waterways, we will be unable to compete in the global marketplace.



## Section II

### Indiana Freight and Transportation

Source: Northwest Indiana Regional Planning Commission (8)

#### Background on State Ports

Indiana ranks 14th in the nation for waterborne shipping. The State ships 70 million tons of cargo by water each year, which is more than Michigan, Alaska, Virginia, Maryland, Mississippi, Tennessee, Oregon, Maine, Massachusetts, Puerto Rico, South Carolina, Georgia, and Hawaii. More than half of Indiana's border is water. Indiana has 400 miles of coastline on the Ohio River and Lake Michigan, each of which is part of the country's two largest shipping arteries – the Inland Waterway System and the Great Lakes/St. Lawrence Seaway. Indiana also ranks first in number of interstates and ninth in railroad miles, The Ports of Indiana have direct access to two U.S. coasts – the Atlantic to the east and the Gulf to the south. The state's three ports, located in Burns Harbor/Portage, Jeffersonville, and Mount Vernon, serve the world's most productive industrial and agricultural region through a combination of strategic location, Intermodal connections and specialized facilities. (4).

The following data on Indiana focuses on the Northwest Regional area of the State. The Region's proximity to greater Chicago is a key contributor to the size and straight of the goods movement in the region. Northwest Indiana possess major freight infrastructure in all modes: air, rail, highway and water.

#### NW Regional Freight

Freight is brought into and out of Northwest Indiana using a variety of modes. Trucking is the dominant mode, with over 60% of both inbound and outbound freight by value.

Mode of Travel for Inbound and Outbound Freight, by Value 2008

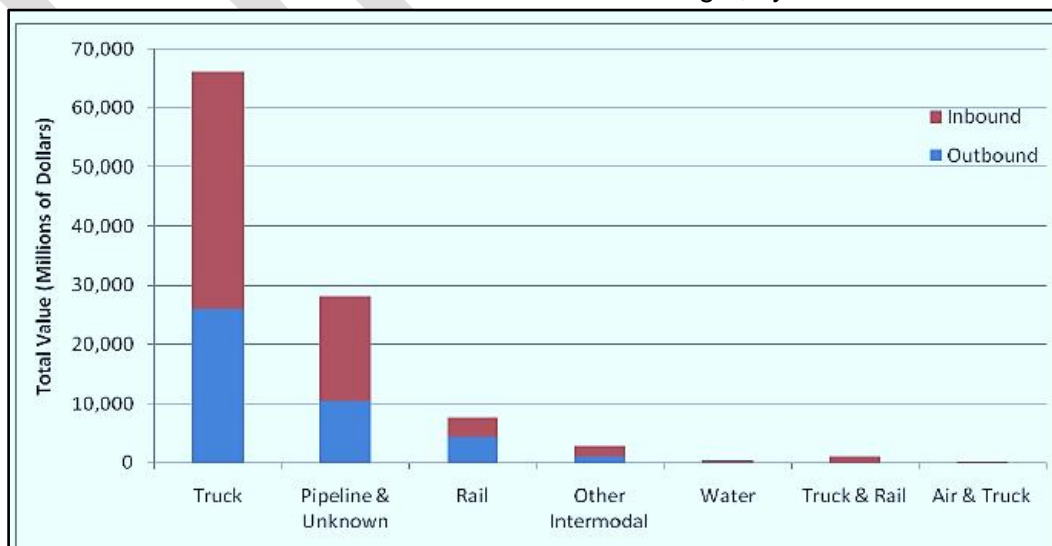

Source: NIRPC, August 2010 Freight Study (8)

The total value of combined inbound and outbound shipments is expected to nearly double between 2008 and 2035. The truck share of freight movements is projected to grow from about 62% in 2008 to 66% in 2035.

Projected Growth in Freight Movements, by Value and Mode, 2008 to 2035

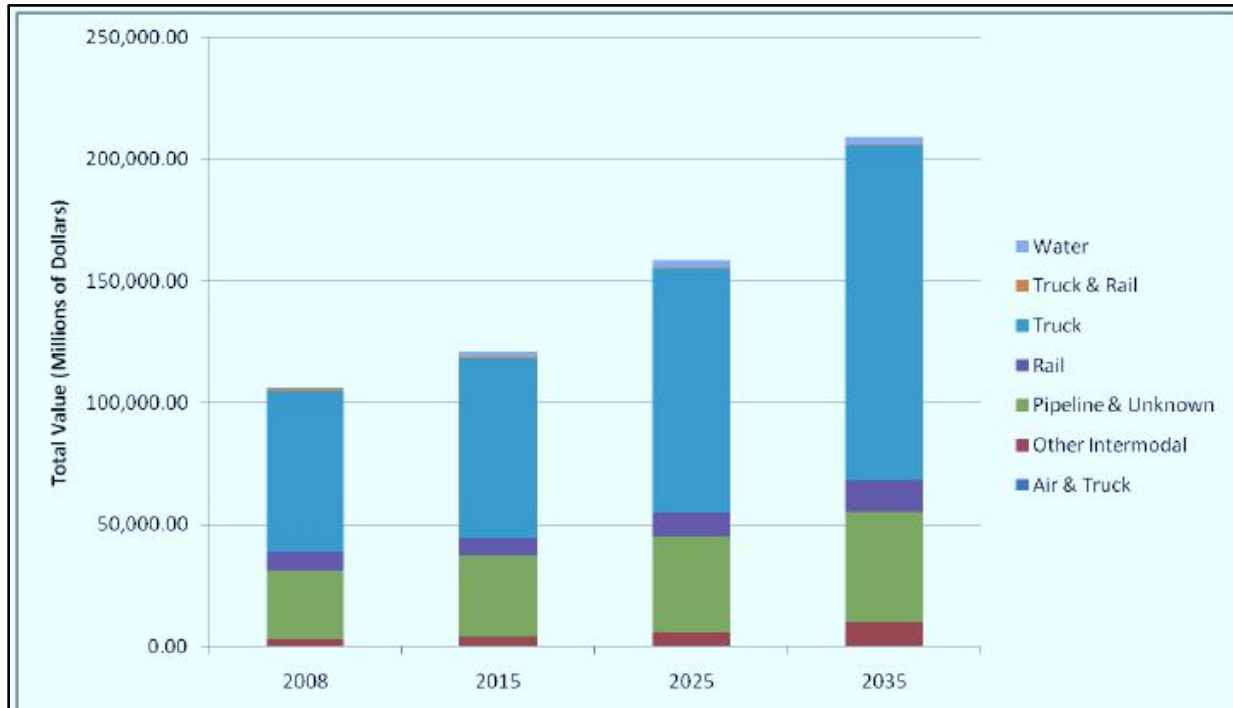

**NW Regional Commodities traded**

The top 15 commodities (by value) entering or leaving the region in 2008 are shown below. These volumes include transport by all modes and for both domestic and international trading partners. The highest percentage of commodities by value is machinery and electronics. Overall the area is a net importer of goods. The 2008 value of imports into the NW area was \$64,101 million of which 97% came from domestic origins and 3% from international origins. The value of exports from the area was \$42,034, of which 96% was destined for domestic destinations and 4% was exports.



## Top 15 Inbound and Outbound Commodities by value

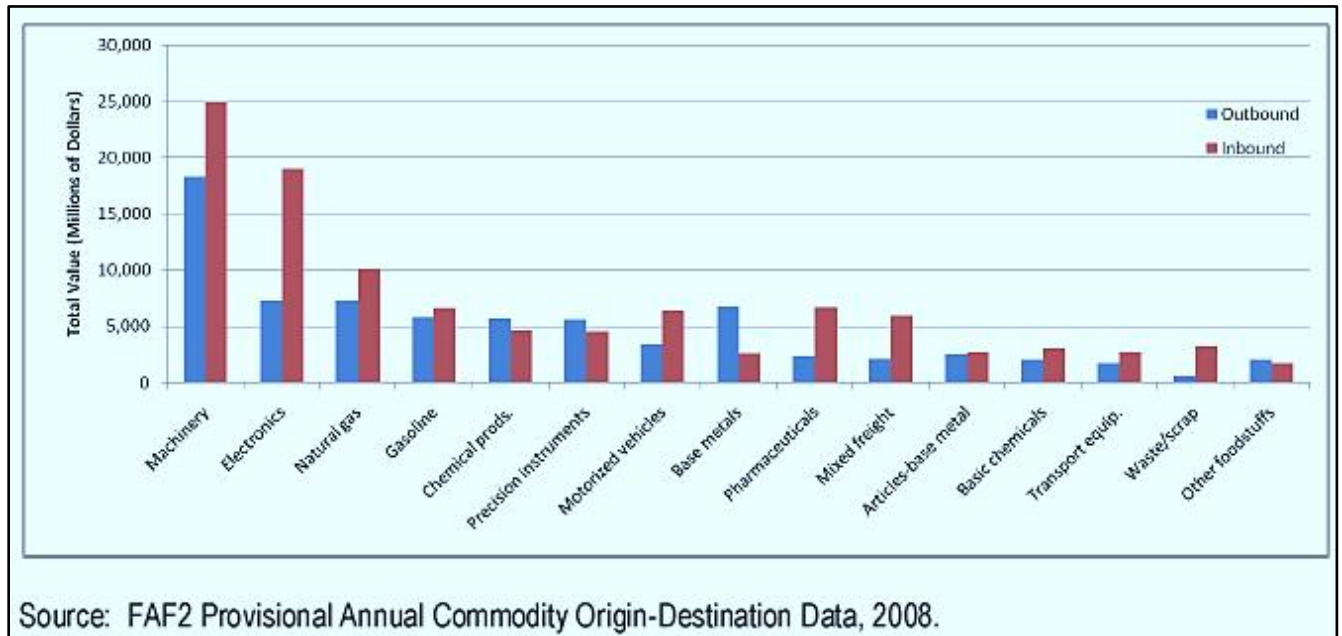

Mexico is the area's top international trading partner. The top commodities are exports of motorized vehicles/parts. Other important trading partners include Canada and Latin America.

The area's primary domestic trading partners in 2008 were in Midwest states, especially within Indiana and Illinois. Michigan, Ohio, and Wisconsin are also significant trading partners. The top goods (excluding gasoline, natural gas and crude oil) being shipped to these states from the area are:

- Indiana: machinery, motorized vehicles/parts
- Illinois: machinery, waste/scrap, mixed freight, transport equipment
- Michigan: machinery, motorized vehicles/parts
- Ohio: machinery, motorized vehicles/parts
- Wisconsin: machinery, mixed freight, motorized vehicles/parts

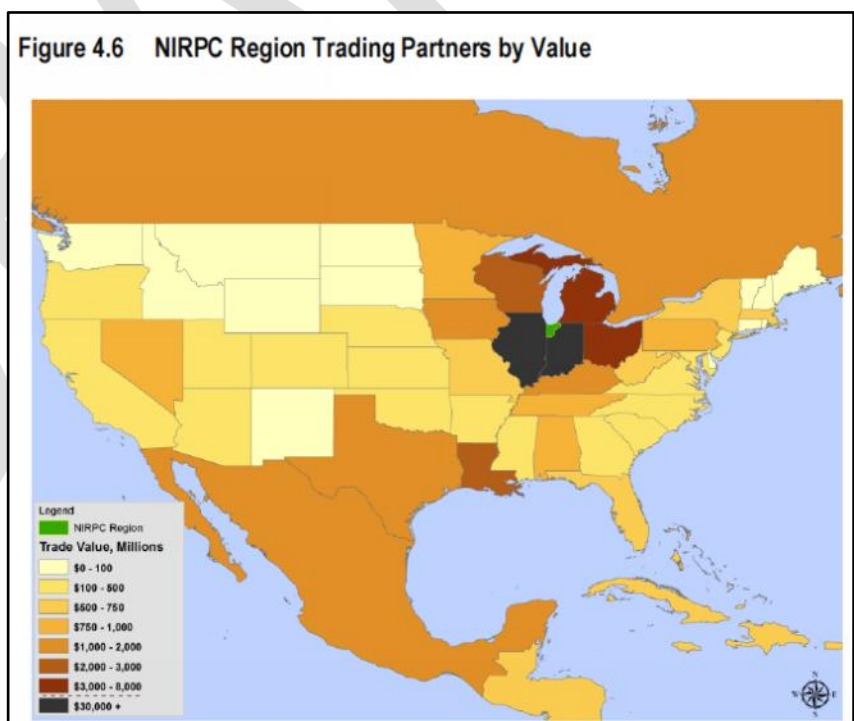

## Rail

The NW area of Indiana is considered part of the Greater Chicago area. Three of the North America's seven Class I rail operators provide service within the area: CSXT, NS and CN. In addition several short line and regional carriers operate in the area. The State's rail network (in 2005) included 4,165 route miles with 88% of those being operated by Class I companies. The dominant operators are CSXT and NS, which operate 76% of all Indiana route miles.

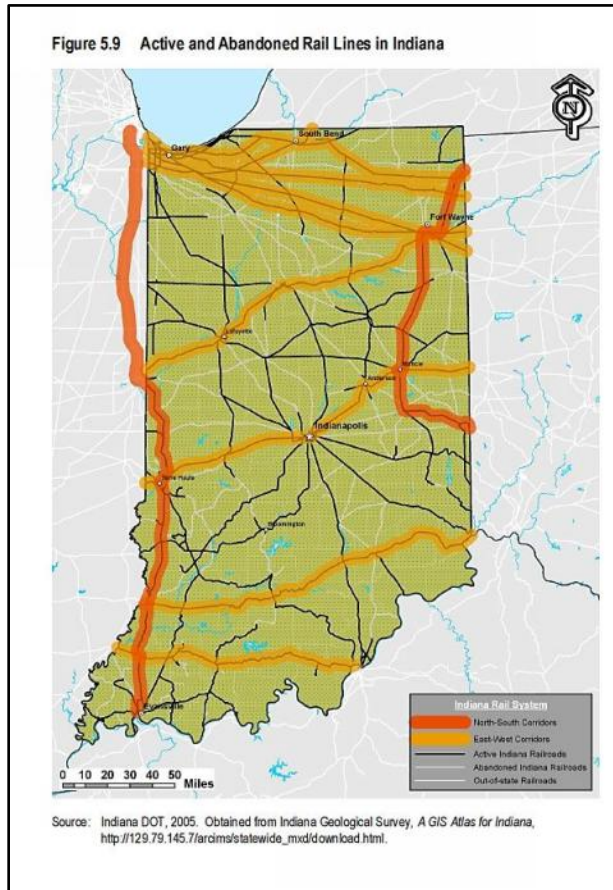

- The heaviest freight rail activity occurs on the CSXT (Garrett subdivision, running through the NW region from Willow Creek to the La Porte-St. Joseph county line), and the NS (Chicago Line subdivision, running for Chicago along Lake Michigan through LA Porte to the La Porte-St. Joseph County line),
- And followed by the CN (the South Bend subdivision, running from the Lake-Porter county line through Valparaiso to the La Porte-St. Joseph county line) and the NS (the Chicago District subdivision, running from Chicago through Hammond and Valparaiso to the La Porte-Starke county line).

The following map shows rail activity for the region. Most rail traffic is passing through the state, traveling between the East coast markets and Chicago's rail and intermodal yards.

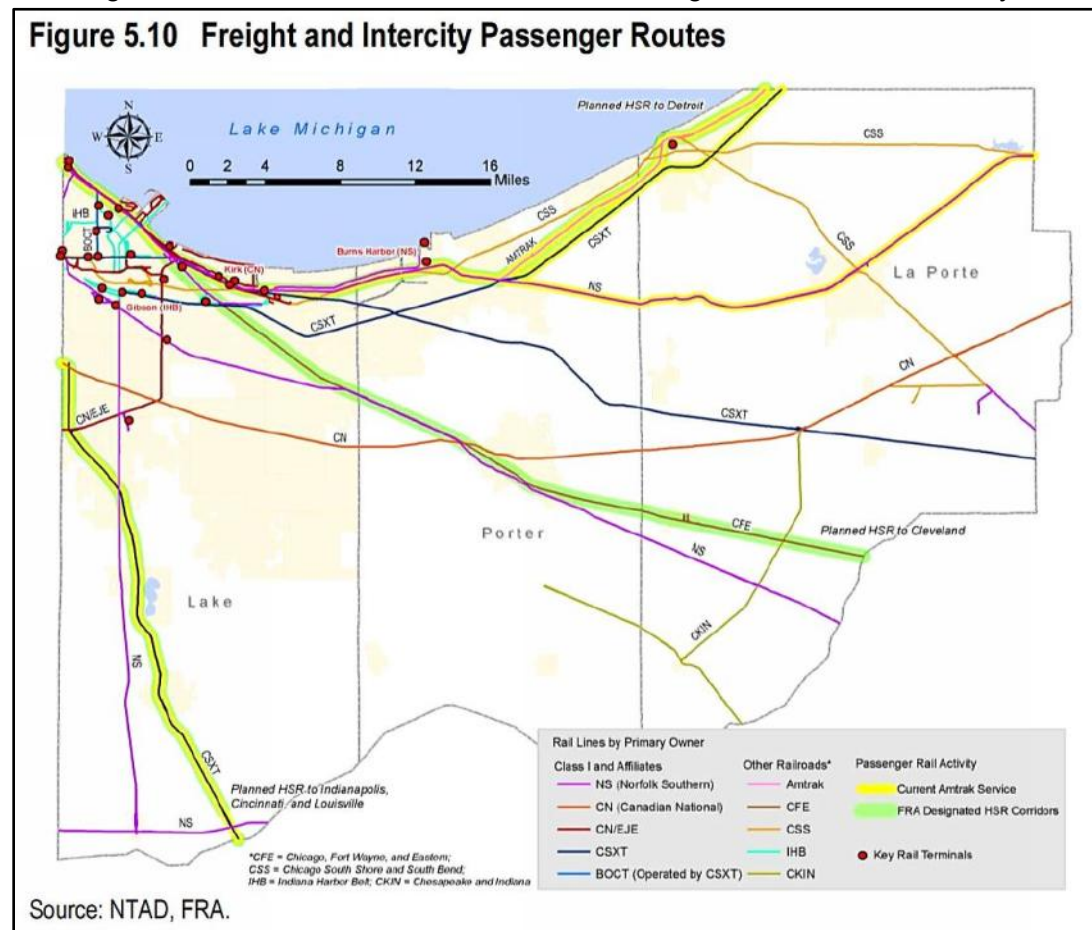

CSXT is guiding some users to the new Kingsbury Industrial Park located in La Porte, as an eastern alternative to the /Chicago congestion. A major logistics company has indicated a preference to locate a food distribution facility east of Chicago; because by located 50 miles east of Chicago they can reach more customers in a one day's truck drive than they can from west of Chicago. The facility is being developed to move trainloads of food products for distribution in Chicago and east of Chicago. Most of the product will come from South America, via Jacksonville.

**Indiana Northern Ports**

A Northwestern Indiana Regional Planning Commission document (updated August 2010) states the region should consider how to shift more freight to the water mode to reduce congestion on the highways. Many trucks operate between Indiana Harbor and Burns Harbor, but potentially these trips could be served by water. The study also suggests looking at developing a short-sea program on the Great Lakes. Harbors such as Milwaukee and Muskegon could potentially be served by regular lake barge service. But "it might be difficult to offer freight rates competitive with trucking". "Some type of incentive that makes water more financially competitive will be critical to affecting any significant mode shift to water".



## Northwest Indiana Freight Facilities

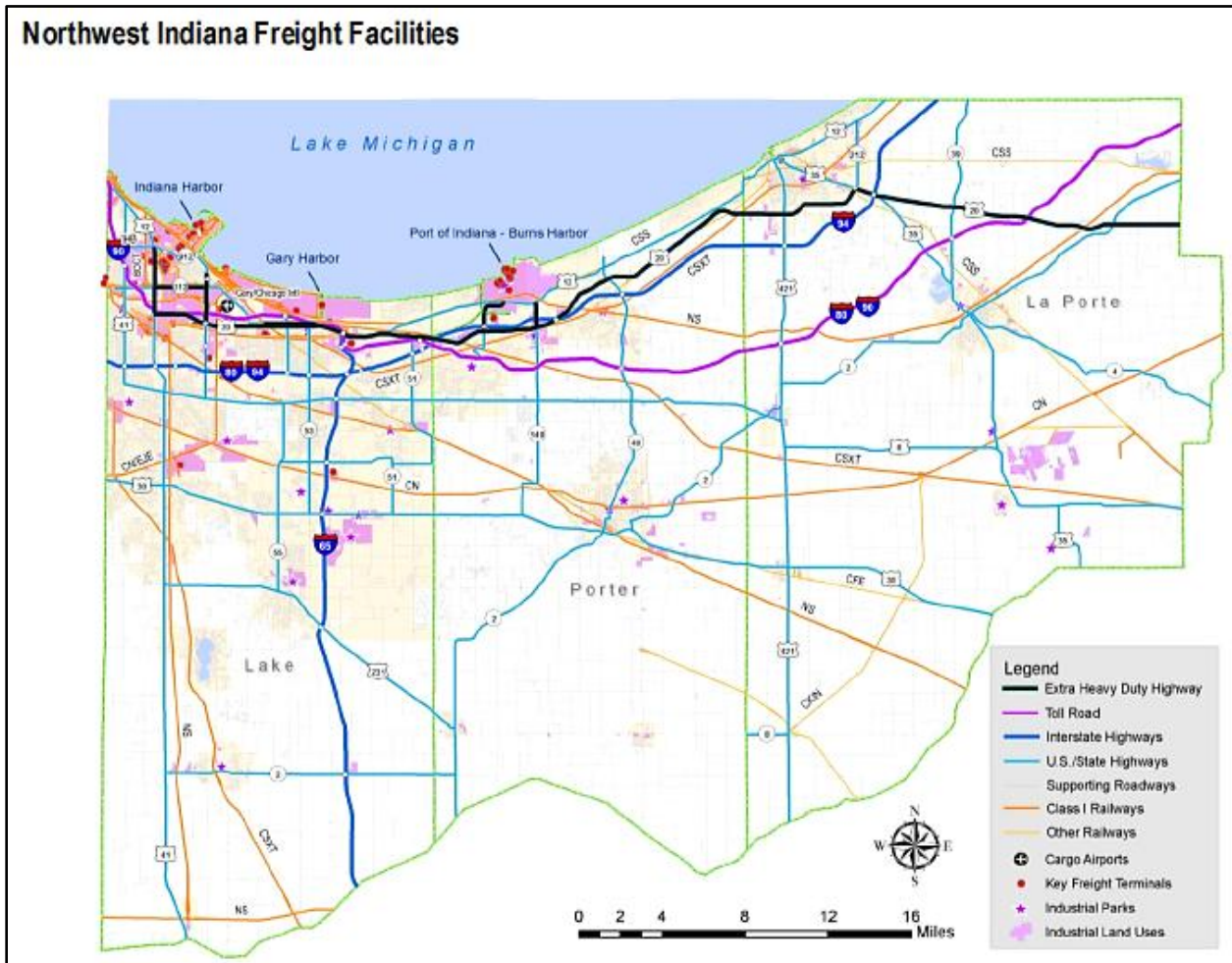

In 2008, about 32 million tons of foreign and domestic cargo shipments were handled on the Indiana Lakeshore facilities at Burns Harbor, Indiana Harbor, Buffington Harbor and Gary (including 1.9 million tons that moved via the Inland Waterway System through the O'Brien Lock). The majority (about 78%) of the tonnage was iron ore pellets discharged by laker vessels to the various steel mills along the Indiana Lakeshore. The 32 million tons handled in 2008 is less than the previous 4-year average of 34.2 million tons. The 1.9 million barge tons was also less than the average 3.0 tons over the past 4 years (2004-2007).

Due to the unique convergence of the lakeshore harbor facilities, steel mills and other industries are able to take advantage of cost-effective methods of receiving raw materials such as iron ore, coal and limestone and shipping finished products to domestic and international markets. In 2008 the waterborne shipping at the Lakeshore facilities supported 104,567 jobs in the region.

(5)

## Burns Harbor

- Operated by the Indiana Port Commission
- Handles more ocean-going cargo than any other U.S. Great Lakes port.
- The largest commodities processed at the port are steel, iron and grain. But also handles volumes of chemicals, fertilizers, limestone, coal, and heavy lift cargo.
  - handles about 15 percent of all U.S. steel trade with Europe
- The port handles barges traversing the Inland Waterway system via the Illinois Waterway, bulk carriers traveling throughout the Great Lakes and ocean vessels crossing the Atlantic via the St. Lawrence Seaway.
  - offers year-round barge access to Midwestern markets and
  - the Gulf of Mexico through the Inland Waterway System,
- Facility has 30 on site tenants and covers about 600 acres.
  - capacity for 1,000-foot vessels
  - 12 modern shipping berths
- Directly served by 2 railroads, NS and Indiana Harbor Belt (IHB) ... Class I railroads can access the port via the IHB.
- Of the 10 million annual tons handled at the port, 80% is shipped by truck or rail, and 20% by water.
  - Most tenants use truck vs. rail.
  - The water freight movement is about 1/3<sup>rd</sup> international, 1/3<sup>rd</sup> from the Great Lakes, and 1/3<sup>rd</sup> through the inland waterway system (Calumet River – Illinois River)

## Indiana Harbor and Ship Canal in East Chicago

- Privately owned, and is maintained by the Chicago District of the U.S. Army Corps of Engineers, as authorized by the Rivers and Harbors Act of 1913
- Connects the Grand Calumet River to Lake Michigan. It includes 4.7 miles of Federal Channel combined within the Indiana Harbor Canal, the Calumet River Branch and the Lake George Branch.
- In 2007 it was the 42<sup>nd</sup> largest U.S. port in tonnage. In 2002 less than 4% of the weight handled was foreign trade related.
  - The harbor is ranked 1st in tonnage among the 25 Federal commercial harbors on Lake Michigan, and 2nd in tonnage of the 55 Federal commercial harbors on the Great Lakes

## Gary Harbor

- Privately owned
- U.S. Steel and Arcelor Mittal Steel have large facilities located by the harbor
- Serviced by the former EJ&E Railroad (now CN)

## The State of Illinois waterborne commerce

The State is the 6<sup>th</sup> largest in terms of total water commerce. The 2<sup>nd</sup> largest for domestic shipping.

*Table 4-2: WATERBORNE COMMERCE BY STATES, 2008, RANKED BY TONNAGE  
(thousand short tons)*

State	Grand Totals*	Shipping		Receiving		Intrastate
		Domestic	Foreign	Domestic	Foreign	
<b>Total</b>	<b>2,477,094</b>	<b>673,141</b>	<b>522,080</b>	<b>673,141</b>	<b>998,679</b>	<b>283,193</b>
Louisiana	480,696	92,875	111,621	119,827	111,901	44,471
Texas	473,342	37,425	91,954	24,771	260,662	58,529
California	221,327	5,066	58,498	18,797	125,233	13,733
New Jersey	154,173	31,171	16,657	22,502	75,031	8,812
Washington	122,051	10,906	51,305	24,352	23,956	11,532
Illinois	115,508	83,407	852	16,868	2,723	11,658
Florida	110,524	8,775	16,380	47,743	36,493	1,133
Ohio	103,358	19,605	9,213	61,183	8,079	5,278
Pennsylvania	102,024	19,309	2,033	30,207	36,253	14,222
Kentucky	94,435	51,273	-	25,765	-	17,397
Alabama	85,561	15,054	14,308	18,893	23,806	13,501
Virginia	79,083	9,433	46,085	4,563	14,409	4,594
West Virginia	77,077	47,899	-	18,652	-	10,526
Indiana	72,668	15,763	151	52,912	1,214	2,628
New York	71,603	12,048	6,606	17,588	25,299	10,063

Source: Waterborne Commerce of the United States – 2008 (report #25)

The State of Illinois borders or contains over 1000 miles of the inland waterway system. The state's western border is defined by 580 miles of the upper Mississippi River. The Illinois Waterway flows for more than 300 miles, from Lake Michigan diagonally across the state to the upper Mississippi, which it joins at mile 217. The Ohio River forms 133 miles of the southern border of Illinois from mile 848 at the Indiana border through mile 981 at the Mississippi River.

An analysis of the waterborne commerce data for the State shows that over 83.9 million tons of commodities were shipped on the inland waterways out of the state. Coal made up more than 57% of the amount, followed by grain with over 28%. Most of the coal originated at docks on the Ohio River, while most of the grain originated at Illinois Waterway docks. Docks in the state received 19.6 million tons, with over 60% consisting of chemicals, ores/minerals, and iron/steel. Almost 12 million tons moved within the state. The main intrastate commodity was aggregates such as sand and gravel moving on the Illinois Waterway. In 2008, the over 115 million tons shipped to, from, and within Illinois on shallow-draft barges had a value of over \$15.5 billion.

Illinois docks shipped commodities by barge to 18 states and received commodities from 18 states. The leading state shipped to was Louisiana, with almost 40 million tons and a value of almost \$4.8 billion. The leading state shipping by barge to Illinois was also Louisiana, which shipped almost 9.6 million tons of high value commodities such as chemicals, iron, and steel products that are worth over \$3.3 billion.



## Illinois 2008 Commodities Shipped by Barge to and from Other States

(tonnage in thousands of tons; values in millions of dollars)

Shipments To	Ktons	Value	Top Commodity	Shipments From	Ktons	Value	Top Commodity
Louisiana	39,804	\$4,855	Grain	Louisiana	9,553	\$3,368	Chemicals
Indiana	14,730	\$595	Coal	Michigan	1,730	\$141	Aggregates
Tennessee	10,327	\$620	Coal	Texas	1,186	\$317	Chemicals
Ohio	5,359	\$301	Coal	Kentucky	1,173	\$150	Coal
Wisconsin	2,750	\$113	Coal	Missouri	935	\$130	Aggregates

Source: U.S. Army Corps of Engineers Waterborne Commerce Statistics

Manufacturing Facilities, Power Plants, Terminals, and Docks are located along Illinois waterways.<sup>vii</sup>



# Chicago Area

## A transportation hub

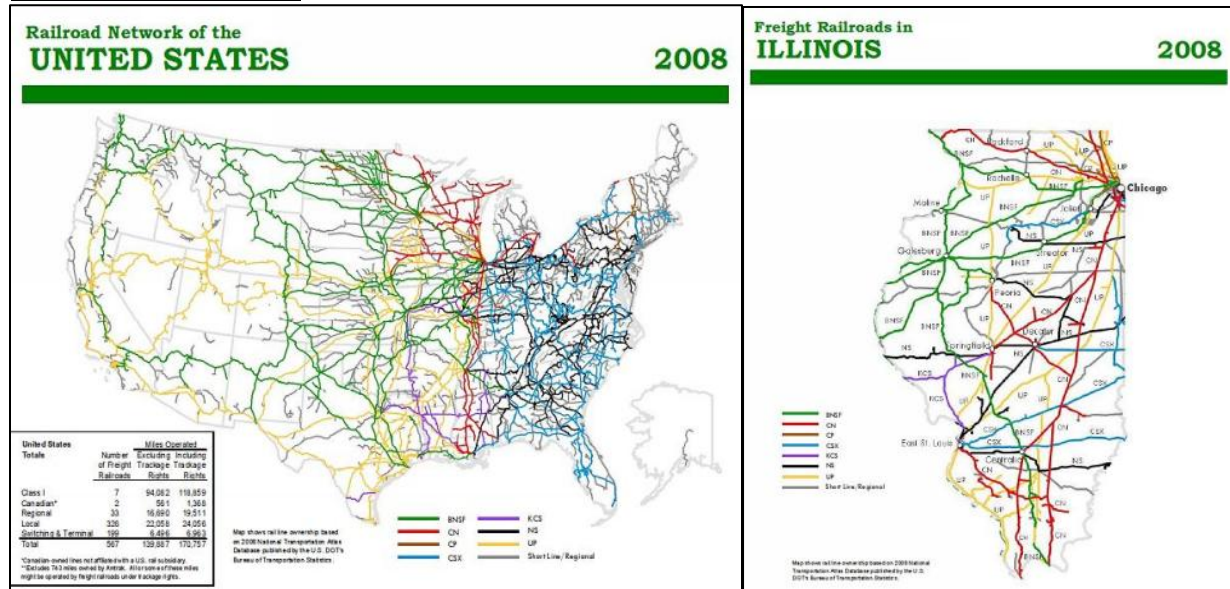

Chicago serves as the Nation's Transportation Center as well as the hub of U.S. Global, National, and regional Trade flows. Annual commodity shipping and receiving to, from and through the Chicago Region exceeds 1.15 billion tons. Fifty-five (55) major categories of commodities pass through the region, representing the full spectrum of consumer goods, commercial and industrial equipment, automobiles, parts food, finished goods and raw materials.<sup>viii</sup>

Chicago ---

- Is the third largest intermodal port in the World, behind Hong Kong and Singapore.
- Is the single largest rail transfer center in the United States (#4)
- Has a freight industry that generates \$8 billion annually in economic activity (#4)
- Provides a transportation system where one third of rail and truck traffic – and half the nation's container traffic – passes through.
- Is the 5th<sup>ix</sup> largest inland intermodal center in the world (transfer of containers between transportation modes)
- Is the major destination and interchange point for container traffic originating in West Coast ports and bound for Midwest and Eastern markets.
- Is also the only city in North America served by all six Class-One railroad companies, making it the busiest rail center in all the U.S.
- Is truly the trucking capital of the U.S., with 200 truck terminals shipping goods to every region of the continental U.S. via 10 interstate highways—the most in the country.<sup>x</sup>
- Has two international airports—O'Hare International Airport and Chicago Midway Airport—that together handle more passenger traffic than any other city in the world
- Is the corporate headquarters of 93 publicly traded companies, including 30 Fortune 500 firms.
- Is where fifteen-hundred foreign-owned companies have operations.<sup>xi</sup>



Located within the Chicago Region are multiple DC warehouse. (The Intermodal Container Transfer Facility (ICTF)

### Concentration of Key Import Consumption, ICTF Locations and Distribution Centers in Mid Atlantic / Midwest Regions

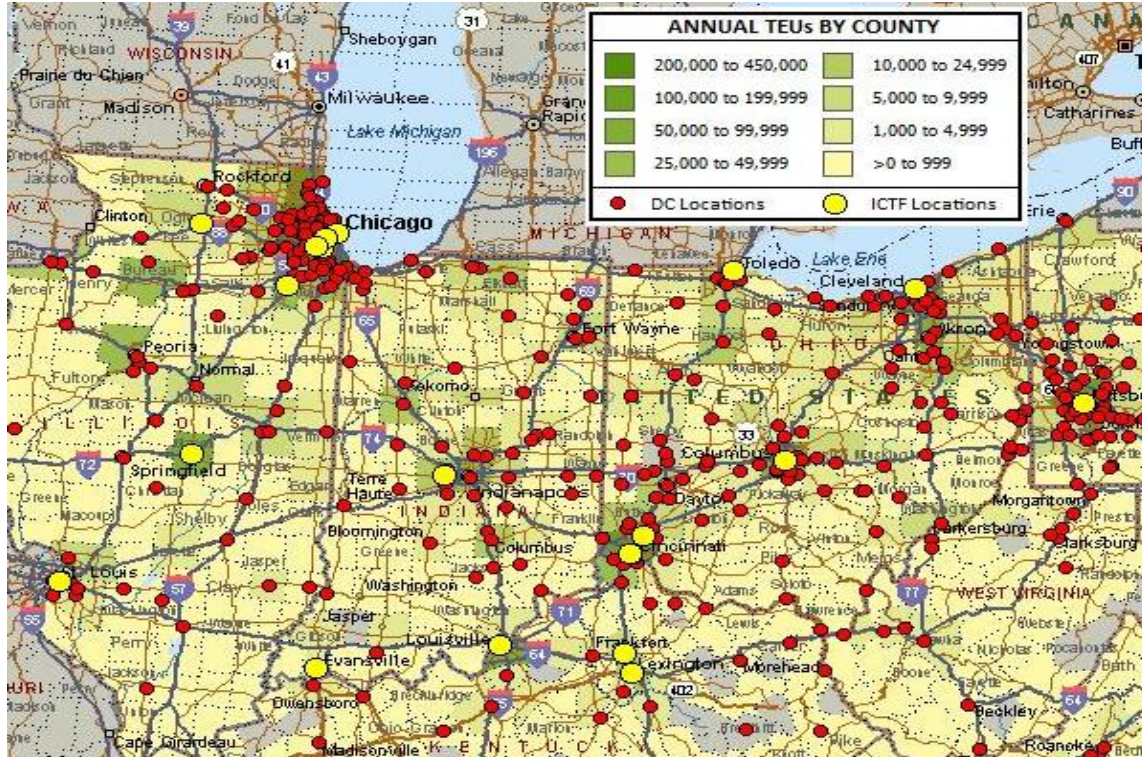

Source: Martin /Vickerman Report (Feb 2011)

#### Intermodal facilities ... Chicago area and Indiana

Chicago's 21 intermodal freight hubs which are operated by 6 rail companies are becoming congested with no land to expand. The yards are being consolidated outside the traditional 8 County Greater Chicago Metro Chicago Region to reduced costs and to improve the thru put of containers in and out of the freight hubs. (#4)

According to a "Ports of Indiana analysis", an Intermodal rail facility can generate \$800 million in development investments, 16,000 permanent jobs, 20,000 construction jobs, \$27 million in property tax revenue, and significant spin-off impact. (#4)

Recent (past 10 years) new logistic-related projects in the greater Chicago region: (#4)

- **BNSF Logistics Park** – Chicago (Elwood) is a 625-acre state-of-the-art facility completed in 2002. With a capacity of 800,000 lifts per year, the facility increased BNSF's Chicago annual lift capacity to nearly 3 million lifts. The BNSF Logistics Park is strategically positioned just 15 miles west of the proposed third Chicago airport at

Peotone, and integrates rail, trucking, transload, and Intermodal with distribution and warehousing.

- **CenterPoint Intermodal Center (Joliet)** is a 1,100-acre industrial park adjacent to the BNSF Logistics Park. Upon build-out, the park will feature up to 12 million square feet of rail-served industrial buildings. Strategic advantages of the park include foreign trade zone status, enterprise zone benefits, and access to both the Union Pacific and BNSF Railway lines as well as immediate access to Interstate 55 and close proximity to Interstate 80.
- **Logistics Park (Galesburg)** features 350 acres of development-ready land adjacent to Interstate 74. Galesburg lies along BNSF's main Intermodal line. For distribution operations seeking to avoid congestion in Chicago, Galesburg offers access to seven rail lines
- **Global III Intermodal Facility (Rochelle)**, a Union Pacific-owned operation has the capacity to handle 350,000 Intermodal containers originating primarily from the Pacific Rim. It has the capacity to expand to more than 700,000 lifts. A \$181 million development, the 1,200-acre facility opened in August, 2003.
- **LogistiCenter (Rochelle)** is a 300-acre master-planned business park. Located at the interchange of Interstate 88 and Interstate 39, the development features dual rail access from the Union Pacific and BNSF Railway via a city-owned short line. It has plans to accommodate 5 million square feet of industrial and distribution facilities.
- **International Crossings (Sauk Village)** is a 325-acre master-planned mixed use business park located 20 miles south of Chicago in suburban Cook County. Strategically positioned for transportation, the development is bounded by Interstate 394 on the west, Sauk Trail on the south, and the EJ&E Railroad on the North, and is within five minutes of Interstate 80/94 and Interstate 294
- **Park 88 (DeKalb)** is a 425-acre master-planned business park capable of accommodating up to 7 million square feet of distribution, bulk storage, warehouse and manufacturing space. The project provides rail access via Union Pacific and is located within two minutes of Interstate 88 and 10 minutes from Interstate 39.
- **NexPark (Jacksonville)** is an emerging 1,000+ acre multimodal logistics park in Central Illinois. Located adjacent to Interstate 72, the proposed park is within 30 minutes of Interstate 55 and five minutes from Corridor 67. The location features direct rail access via Norfolk & Southern and BNSF Railway, with Kansas City Southern located within five miles. Just 15 minutes 9 miles away by rail is Consolidated Terminal and Logistics' terminal at Naples – the farthest north year-round ice-free facility on the Illinois River.

### **Rail – Container Market ... Chicago is the largest**<sup>xii</sup>

In 2005, the Chicago and the Los Angeles BEAs were by far the largest container markets. Chicago is by far the largest market for terminating containers. The top 10 BEAs comprise 70% of the total U.S. market for rail terminations of containers in 2005. Four of the five largest BEAs increased their market share between 1995 and 2005.

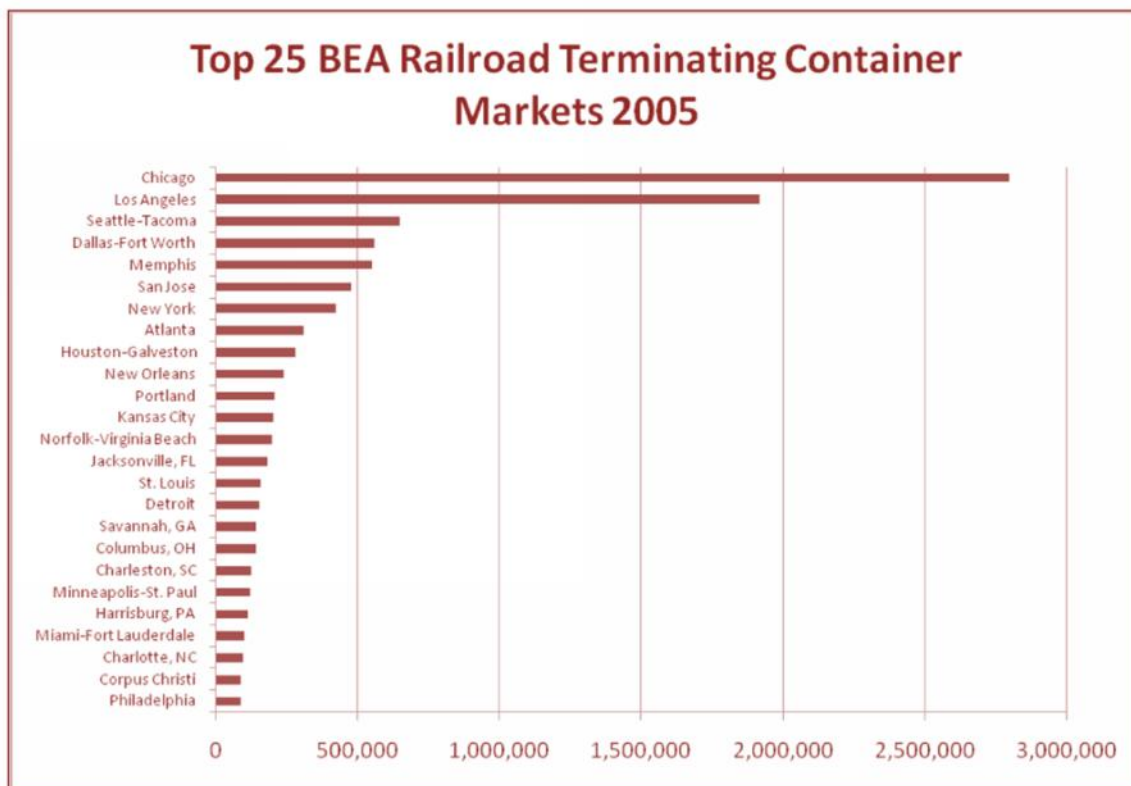
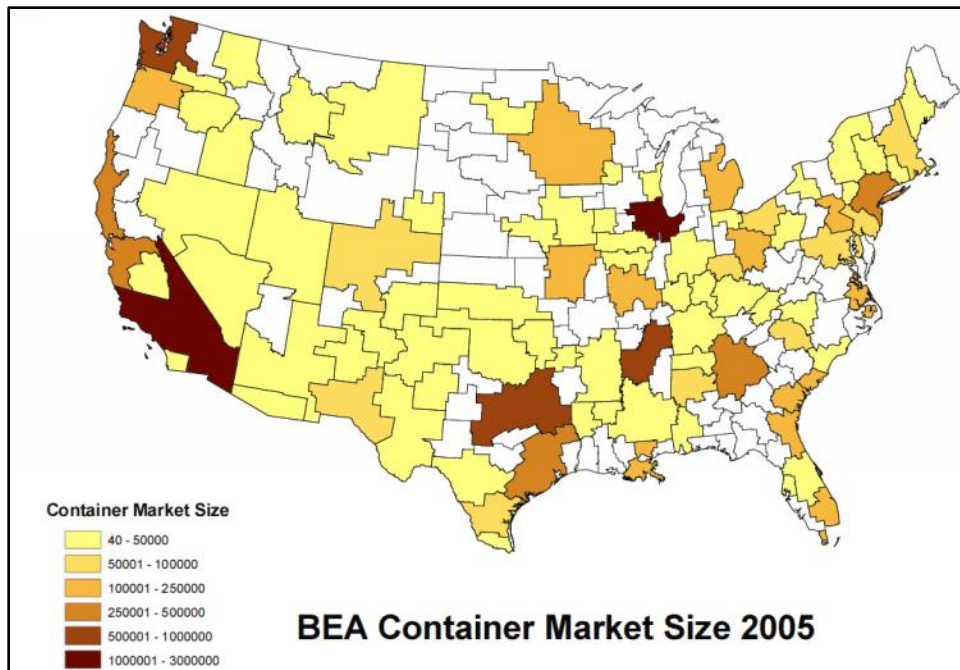

Figure 6.2.2 Top 25 BEA Markets for Railroad Terminating Containers, 2005.

## Chicago area Ports

The Chicago area ports are some of the largest tonnage ports in the United States. Crude materials are the largest commodity in traffic size followed by coal and coke. A third of the commodities are shipped out of the greater Chicago area

Port Rankings based on Short Ton Volume					
Port	Total Trade Rank	Total Domestic Trade Rank	Foreign Trade Rank		
			Imports	Exports	Total Foreign Trade
Chicago	36	18	45	50	48
Indiana Harbor	51	35	87	93	94
Gary	62	43	80	98	99

Source: U.S. Army Corps of Engineers (data #7)

Analysis of Chicago area Port Traffic Flows (section includes Chicago Harbor, Chicago River, Chicago Sanitary and Ship Canal, Calumet-Sag Channel and Lake Calumet, IL, Calumet Harbor and River, IL and IN.

Source: U.S. Army Corp (Data chart 1)



In the next 30 years most of the water freight is forecasted to grow ... primarily through water freight.

Note: The largest volume segment is forecasted to decline!

2009		All Traffic Types (Domestic & Foreign) ... Short tons		
Forecast growth of water volume in the Greater Chicago area By Global Insight for CMAP				
		Water Freight Tons		
		2007	2040 Forecast	Change
<b>Inbound</b>	Destined for 7-County Region	7,344,000	10,591,000	44%
	Destined for Remainder of CMAP Study area *	37,155,000	22,682,000	-39%
<b>Outbound</b>	Originating in 7-County Region	10,087,000	14,195,000	41%
	Originating in Remainder of CMAP Study area *	8,110,000	15,761,000	94%
<b>Intra CMAP Study area Traffic - originating in or destined for 7-County Region</b>		8,884,000	11,128,000	25%
<b>Other Intra CMAP Study Area Traffic *</b>		574,000	385,000	-33%
<b>Through Traffic</b>		882,000	1,205,000	37%
<b>Total</b>		72,976,000	75,948,000	4%
* Broader CMAP area extends to as far as LaPorte County in Indiana, as far as Kankakee, LaSalle and Winnebago Counties in Illinois, and as far as Walworth and Racine Counties in Wisconsin				

Source CMap data (data #1, chart D-2)

	<u>All Traffic Directions</u>	<u>Receipts</u>	<u>Shipments</u>	<u>Intraport</u>	<u>Total all Traffic</u>
<b>All Commodities</b>	100%	45%	33%	21%	100%
<b>Total Crude Materials, Inedible Except Fuels</b>	36%	68%	16%	16%	100%
<b>Total Coal, Lignite and Coal Coke</b>	25%	1%	48%	51%	100%
<b>Total Petroleum and Petroleum Products</b>	18%	36%	52%	13%	100%
<b>Total Primary Manufactured Goods</b>	12%	75%	22%	3%	100%
<b>Total Chemicals and Related Products</b>	7%	73%	23%	4%	100%
<b>Total Food and Farm Products</b>	2%	17%	83%	0%	100%
<b>Total All Manufactured Equipment, Machinery</b>	0%	98%	2%	0%	100%

**The Illinois River and Lock System**



The Illinois Waterway system has nine single chamber, lock and dam projects. The 7 projects on the main part of the waterway have single 110 by 600 foot lock chambers and are over 60 years old. The Thomas O'Brien Lock and the dam on the Calumet River have a 110 by 1000 foot chamber. The Chicago Lock is an 80 by 600 foot lock chamber in the Chicago Harbor Channel. Most barge traffic moving to and from Lake Michigan uses the O'Brien Lock. The Chicago Lock passes over 36,000 recreation vessels and over 440,000 passengers on more than 13,000 commercial passenger vessels.<sup>xiii</sup>

Illinois - 2008 Lock Tonnage						
LOCK	YEAR BUILT	LOCATION		KILOTONS		
		RIVER	MILE	UPBOUND	DOWNBOUND	TOTAL
L/D 53*	1980	Ohio	962.6	37,037	39,073	76,110
L/D 52*	1969	Ohio	938.9	51,788	38,272	90,060
Smithland	1980	Ohio	918.5	45,446	34,385	79,831
27	1953	Mississippi	185.5	4,072	909	4,981
Melvin Price	1990	Mississippi	200.8	21,088	29,986	51,074
25	1939	Mississippi	241.4	8,760	13,699	22,459
24	1940	Mississippi	273.4	8,701	13,699	22,400
22	1938	Mississippi	301.2	8,420	13,169	21,589
21	1938	Mississippi	324.9	8,477	12,669	21,146
20	1936	Mississippi	343.2	8,063	11,738	19,801
19	1957	Mississippi	364.2	7,905	11,102	19,025
18	1937	Mississippi	410.5	8,941	9,566	18,507
17	1939	Mississippi	437.1	8,924	8,658	17,582
16	1937	Mississippi	457.2	8,274	8,238	16,512
15	1934	Mississippi	482.9	8,193	7,625	15,818
14	1939	Mississippi	493	8,057	7,857	15,914
13	1938	Mississippi	523	7,128	7,083	14,211
12	1938	Mississippi	556	7,128	6,935	14,063
Lagrange	1939	Illinois	80.2	10,099	15,556	25,655
Peoria	1938	Illinois	157.7	10,379	11,384	21,763
Starved Rock	1933	Illinois	231	8,092	6,944	15,036
Marseilles	1933	Illinois	244.6	7,729	6,124	13,853
Dresden Island	1933	Illinois	271.5	7,838	5,523	13,361
Brandon Road	1933	Illinois	286	8,454	4,212	12,666
Lockport	1933	Illinois	291.1	7,419	3,896	11,315
O'Brien	1960	Calumet	326.5	4,039	2,783	6,822
Chicago	1938	Chicago Harbor	--	2	104	106
Kaskaskia	1973	Kaskaskia	0.8	72	548	620

\* Original dams and auxiliary chambers built in 1928-1929  
Source: U.S. Army Corps of Engineers Lock Performance Monitoring System

Total 2010 Tonnage per lock (Thousands) – 2010



Source: Chicago Metro Agency, December 2010 (#3 data)

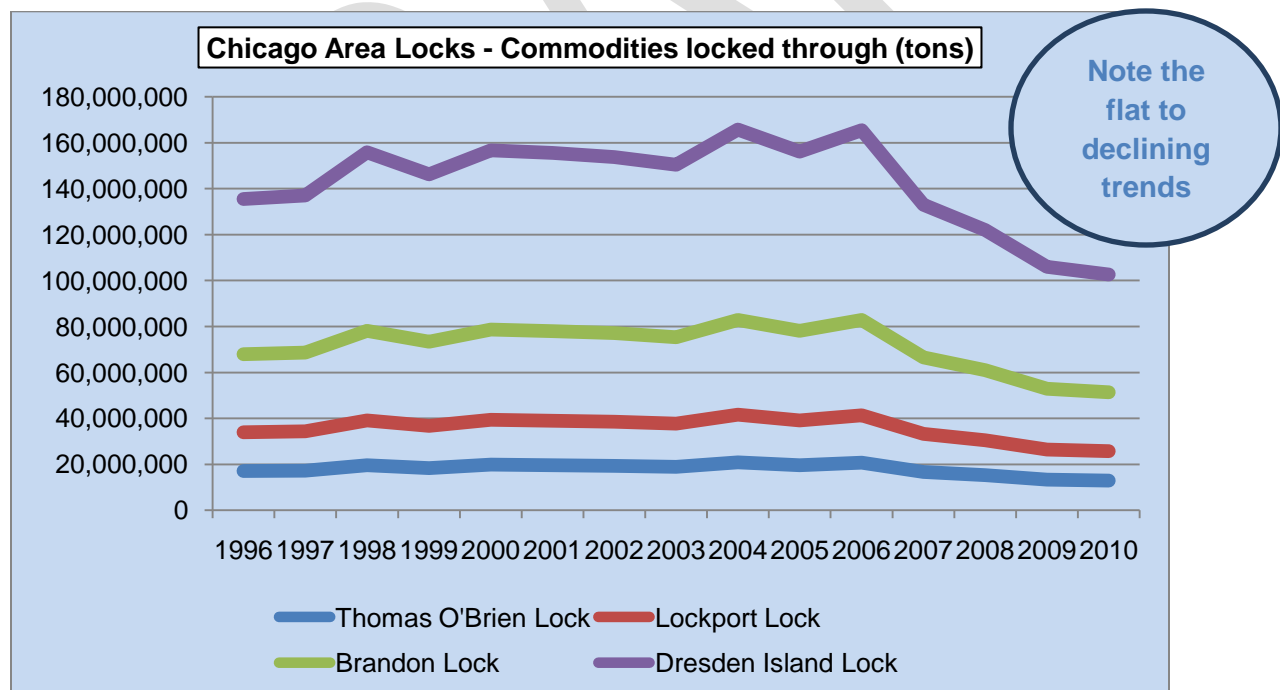

Source: U.S. Army Corp of Engineers (data chart 1)

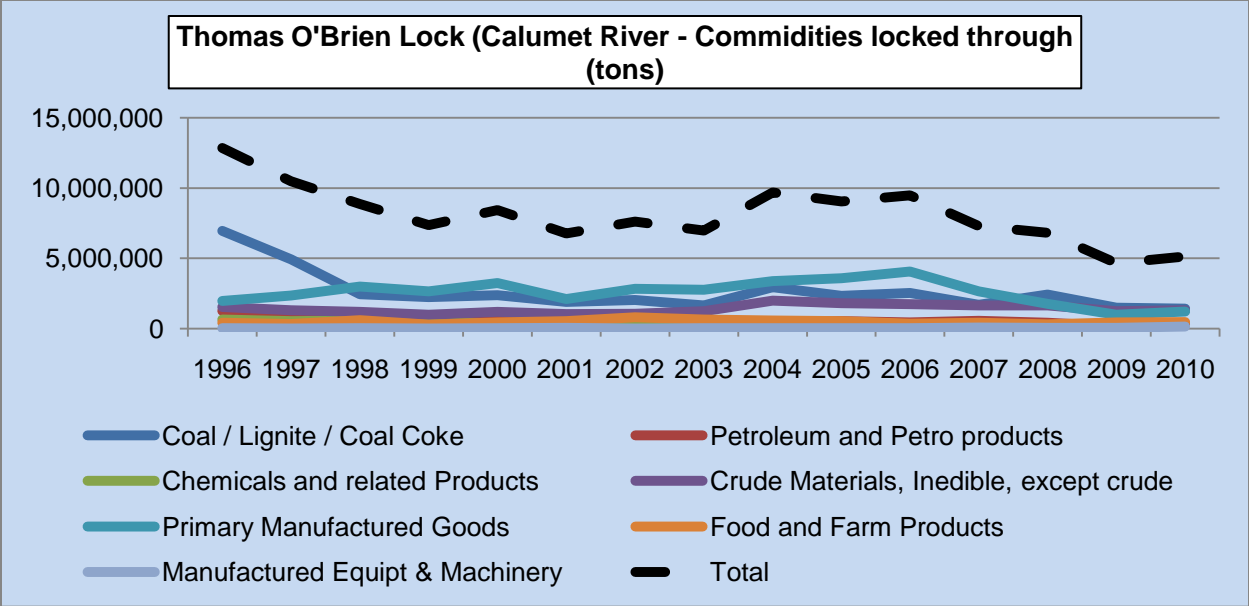

Source: U.S. Army Corp of Engineers (data chart 1)

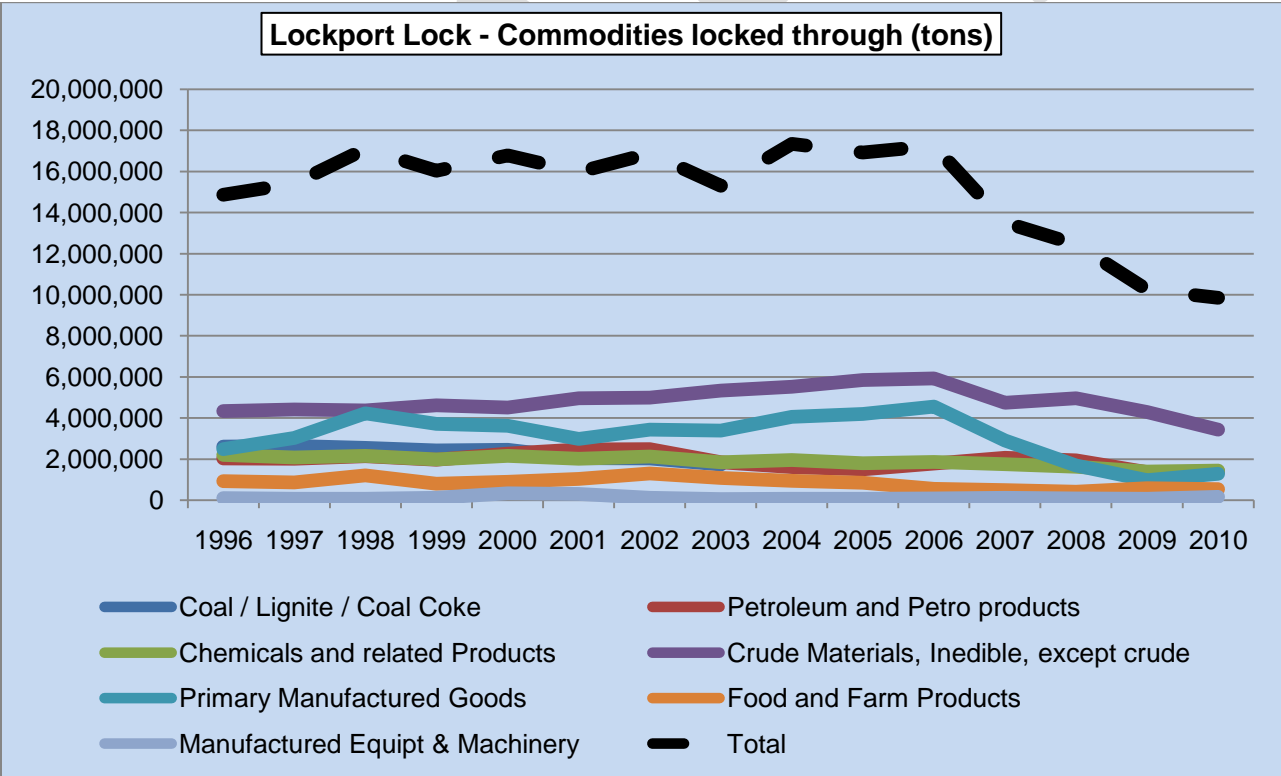

Source: U.S. Army Corp of Engineers (data chart 1)



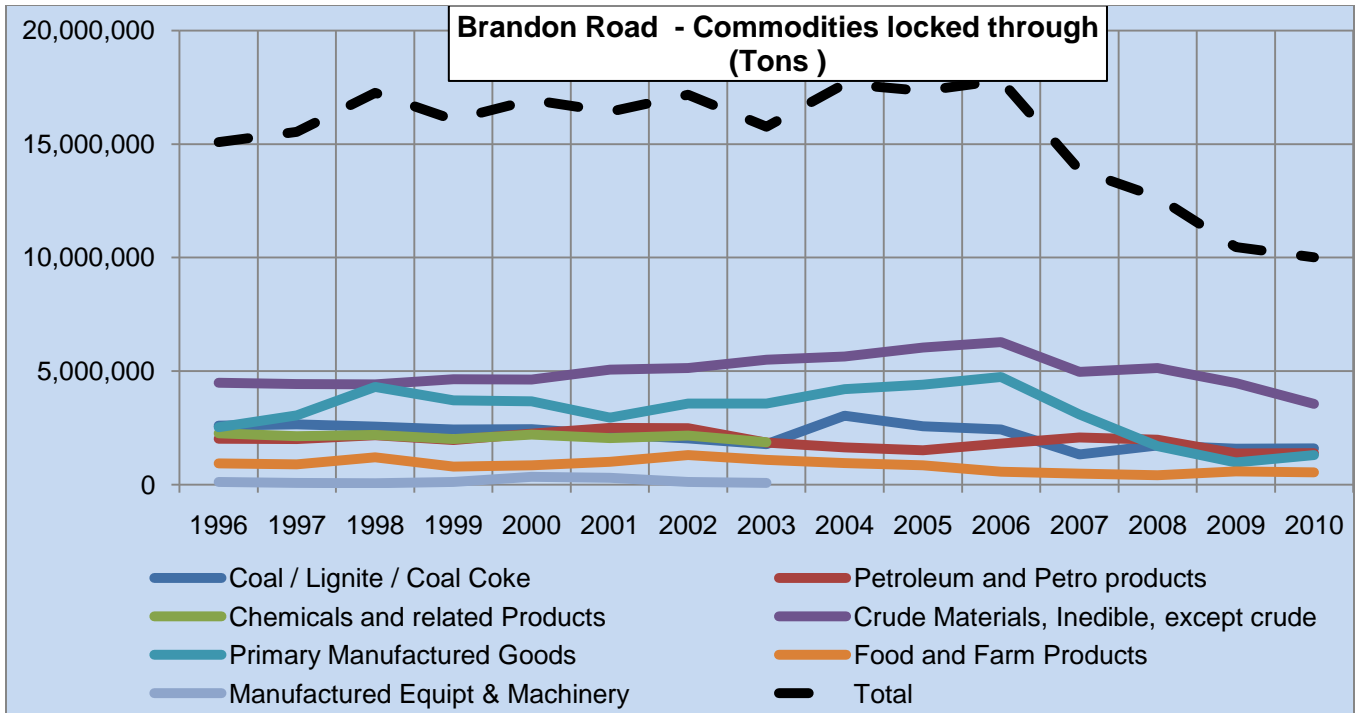

Source: U.S. Army Corp of Engineers (data chart 1)

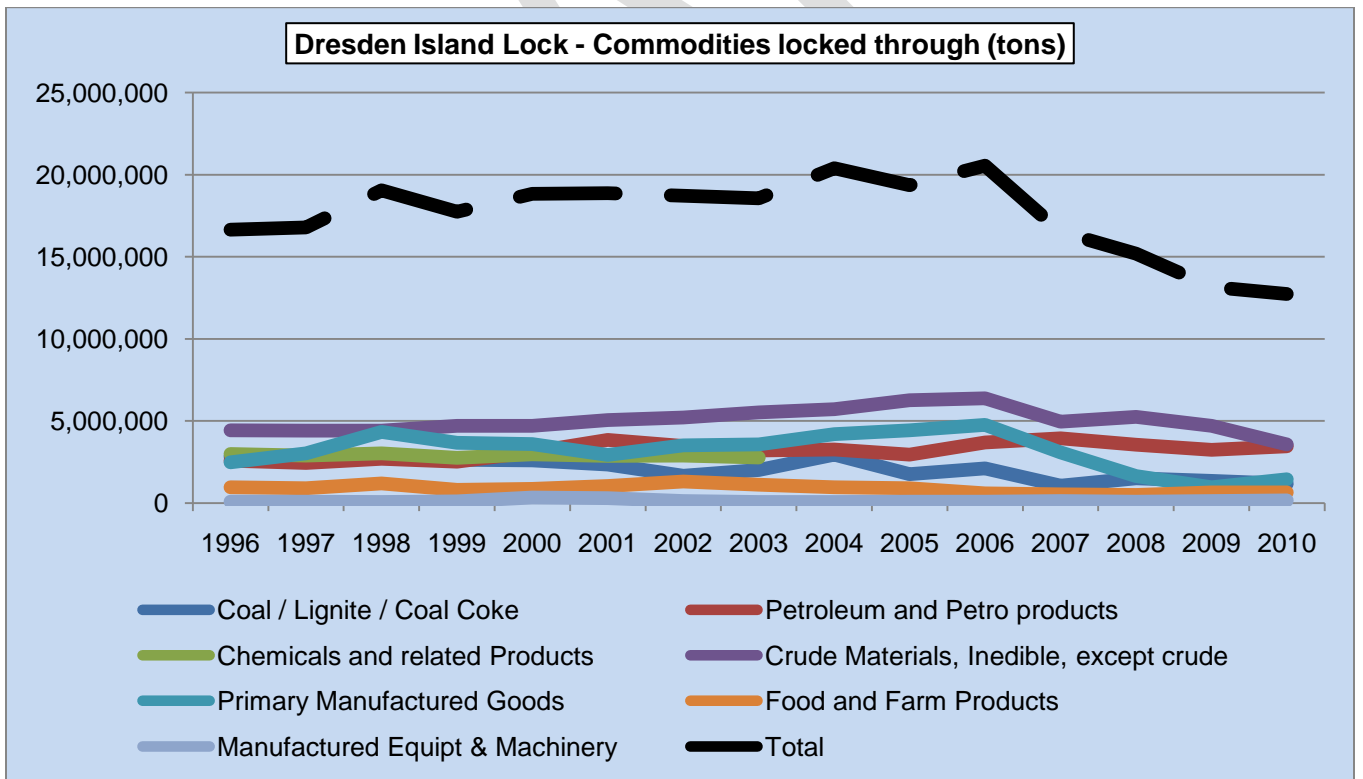

Source: U.S. Army Corp of Engineers (data chart 1)

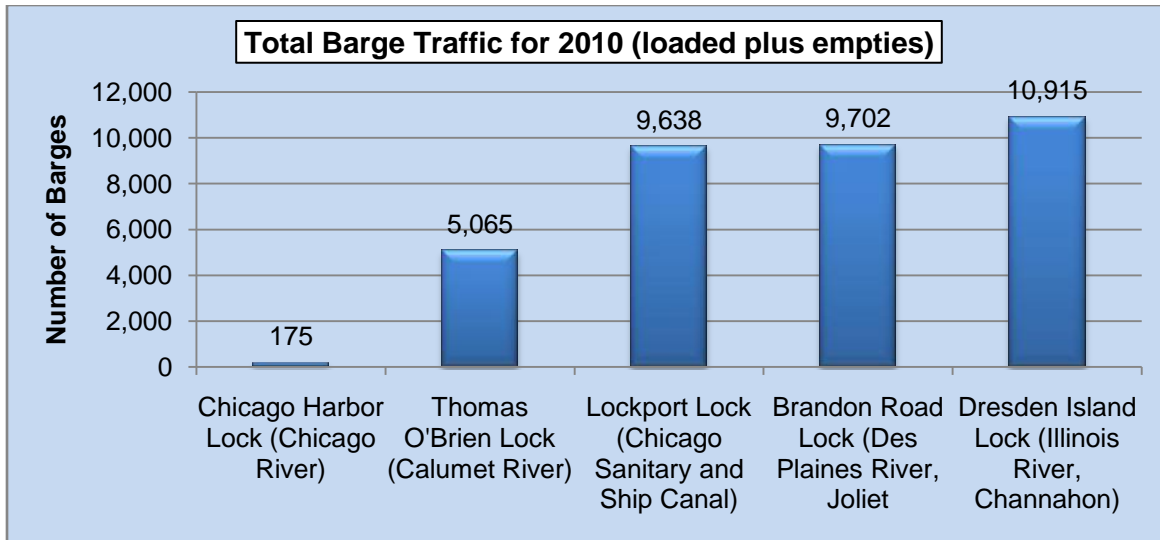

Source: Chicago Metropolitan Agency for Planning, 12/2010 (#3 data)

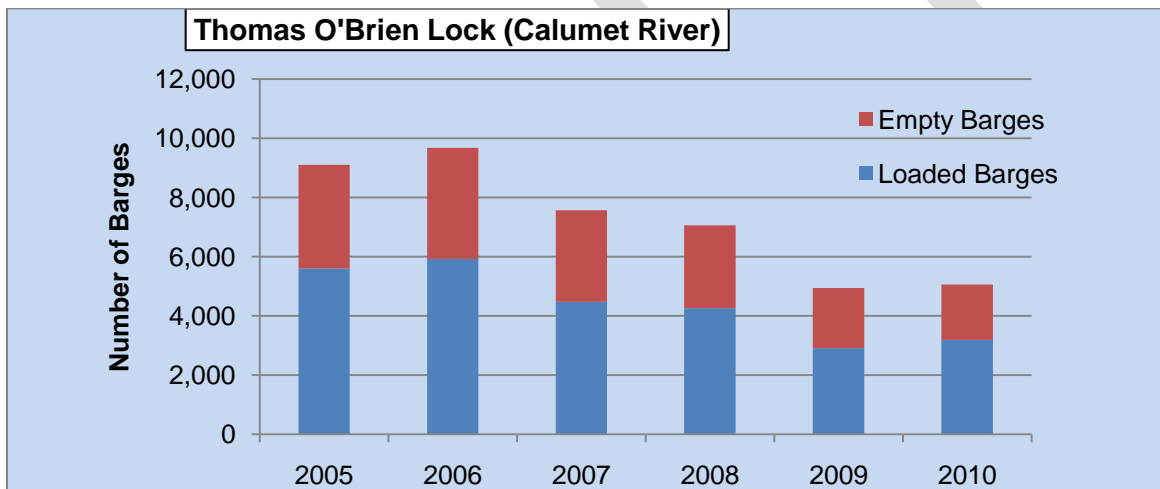

Source: Chicago Metropolitan Agency for Planning, 12/2010 (#3 data)

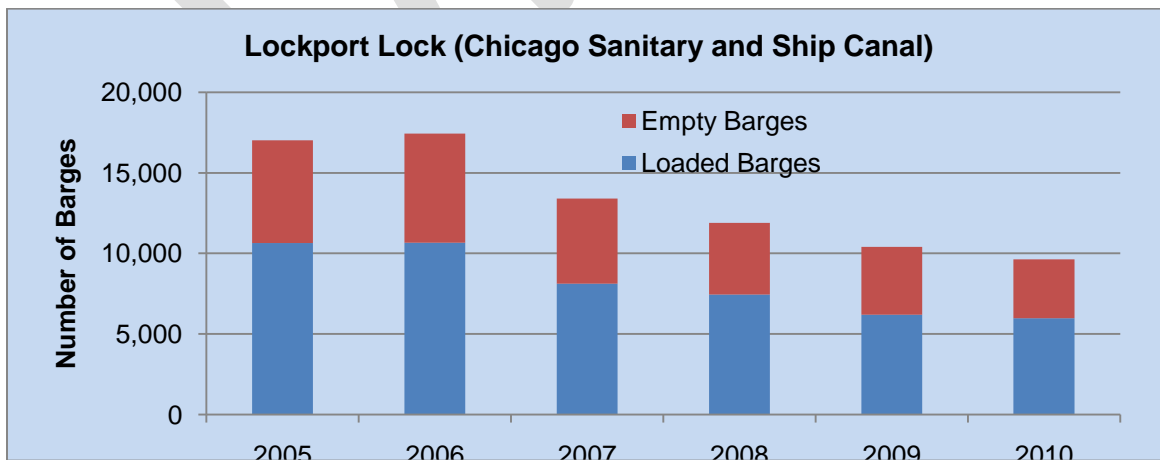

U.S. Ports Ranking by Cargo Volume 2009 ... short tons

Analysis of the type of vessels and the frequency of vessels passing through the Greater Chicago locks.

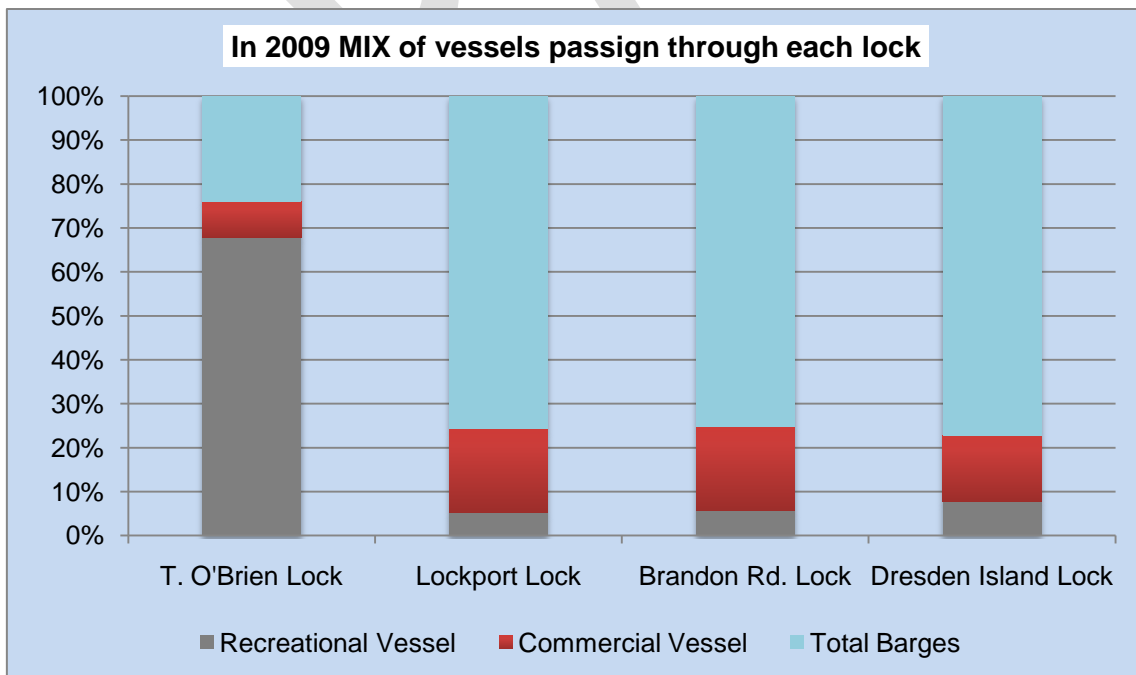
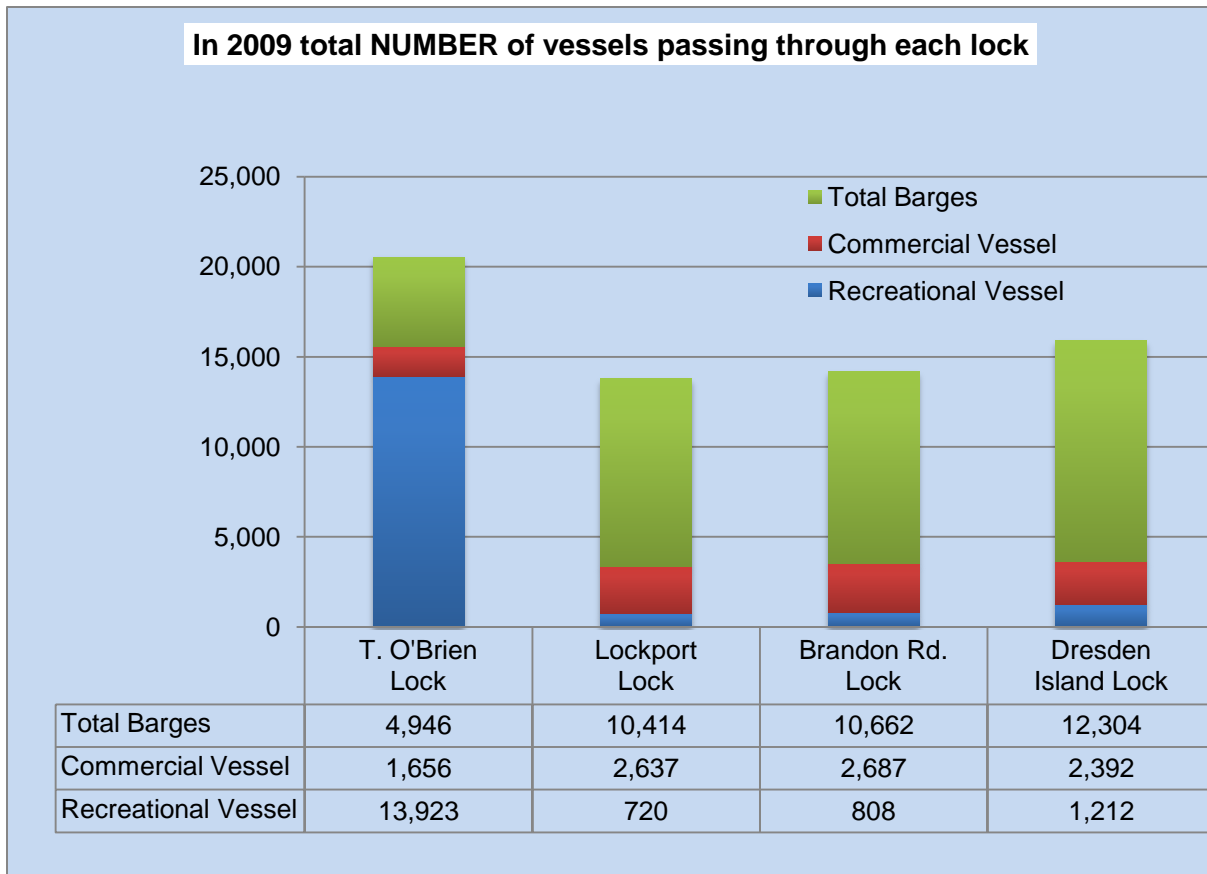

Source <http://www.ndc.iwr.usace.army.mil/lpms/pdf/2008%20&%202009.pdf> (data chart 3)

Total number of loaded and empty barges passing through each lock

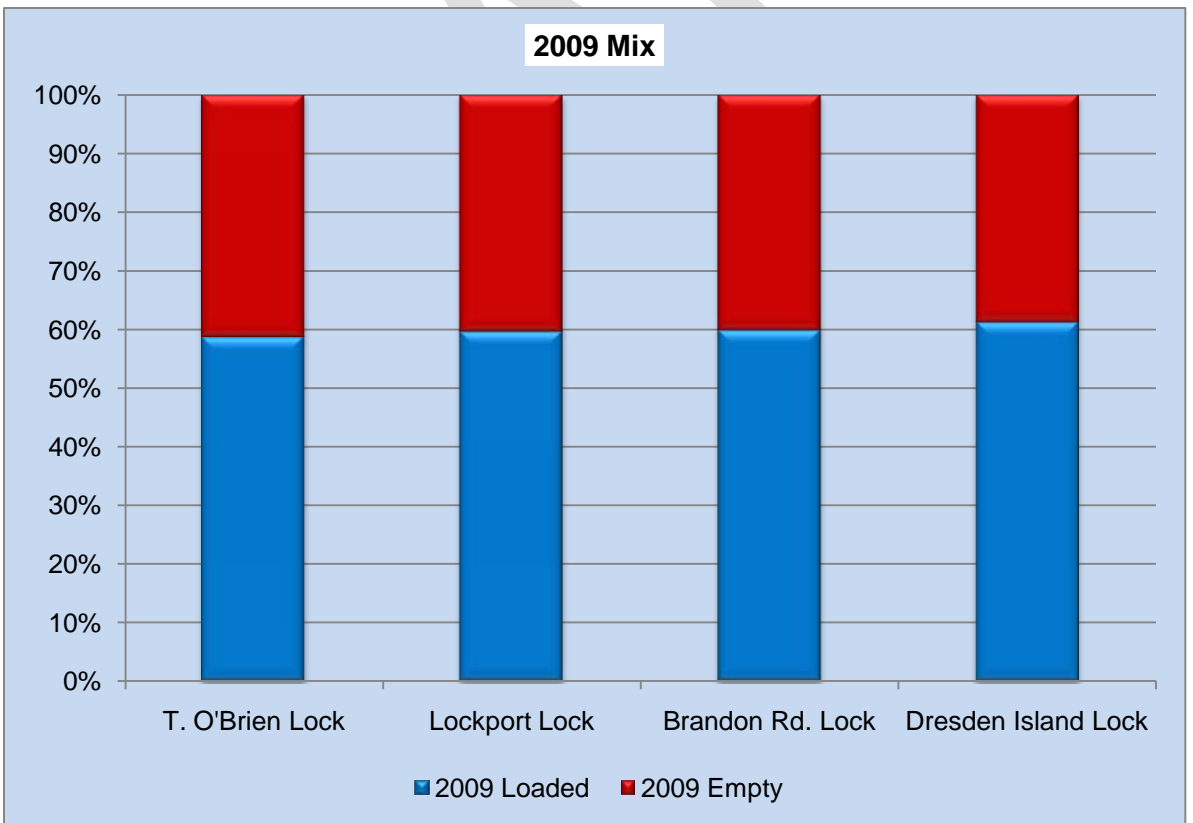
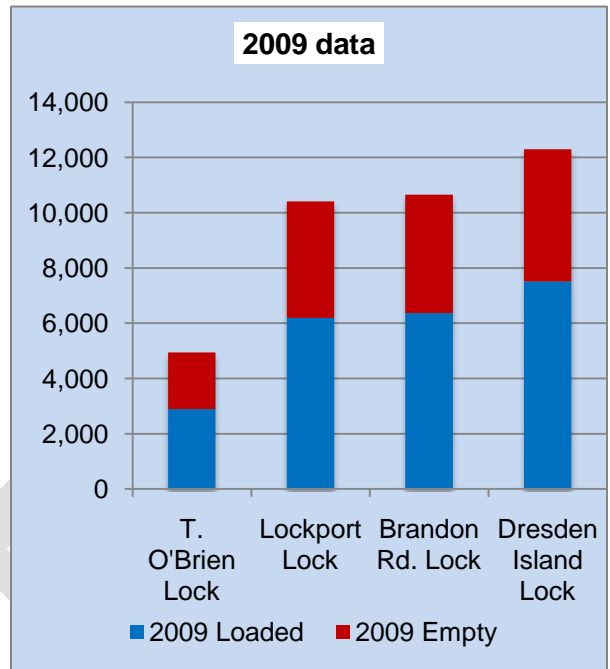
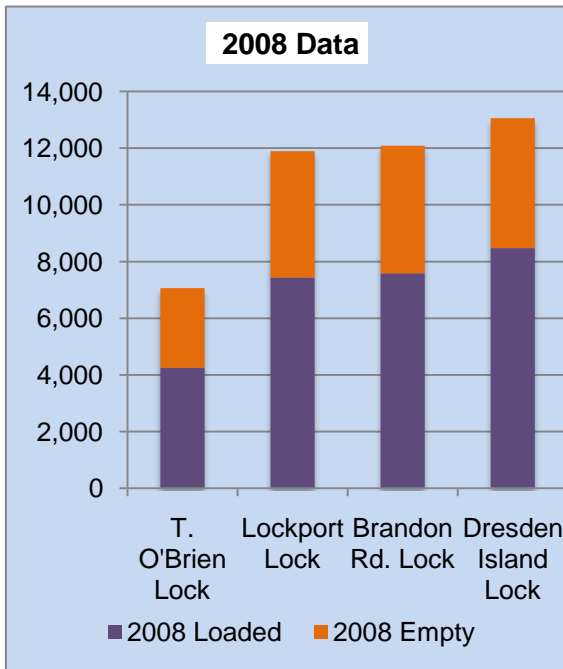

Total number of "Bottoms" passing through each lock. ("Bottoms" is the sum of recreational boats, and commercial vessels plus all barges)

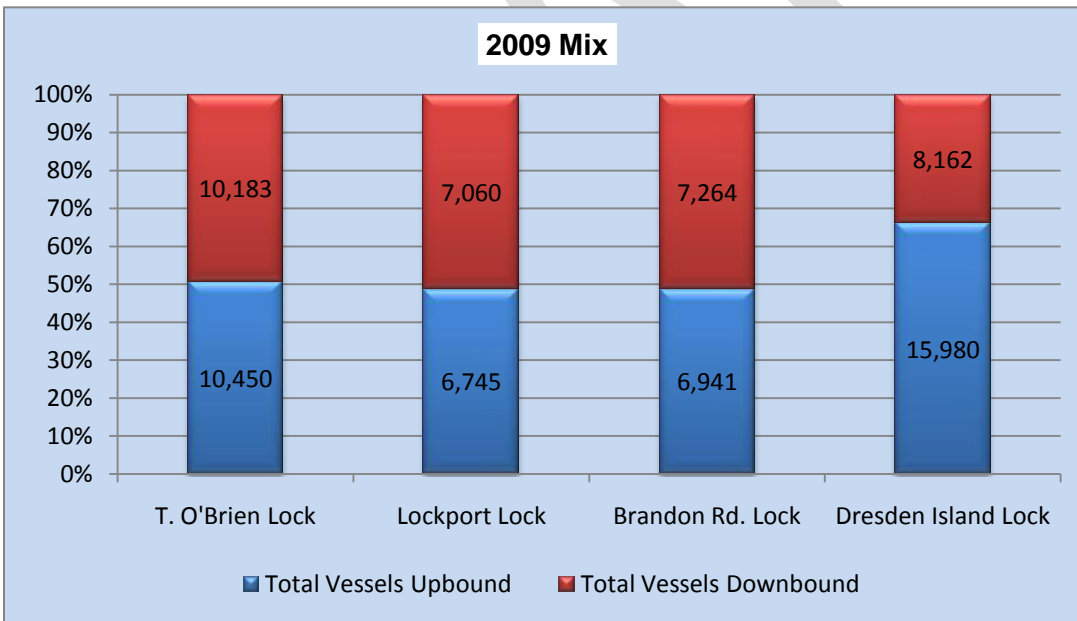
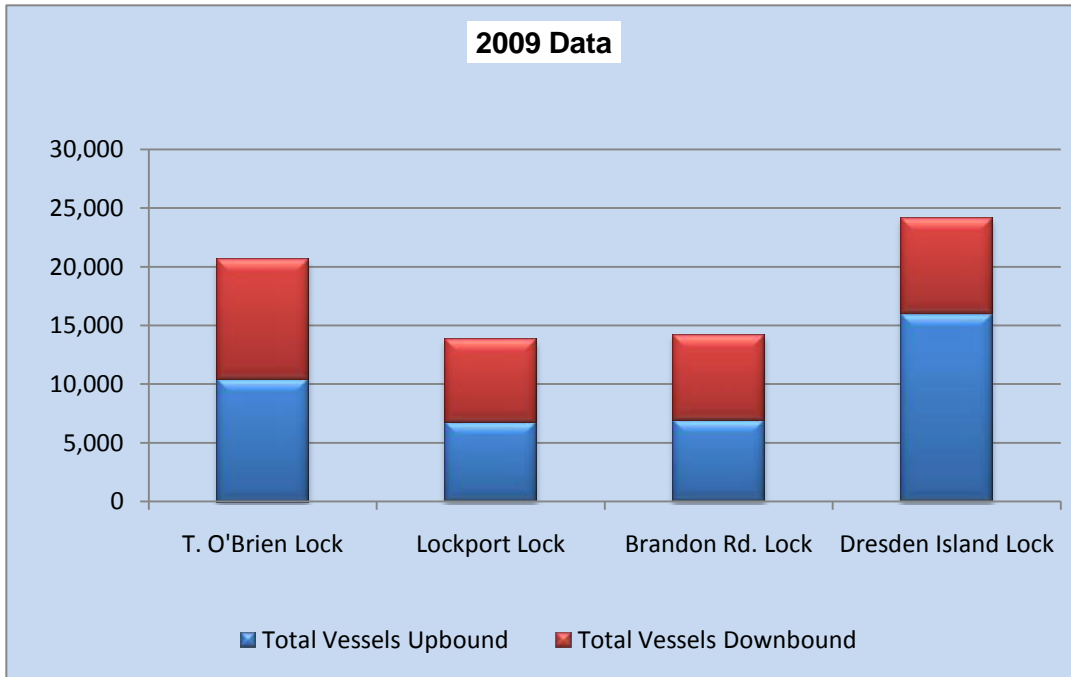

Source: <http://www.ndc.iwr.usace.army.mil/lpms/pdf/2008%20&%202009.pdf> (data chart 3)

**Chicago is a hub for Trade to points East – West and South**

The following charts clearly show the U.S. port of import or export for trade that flows from or to the Chicago area. The market size (and location) of the trade is stated in TEU's. The source of the charts and data is a Vickerman Associates / John Martin Study published in February 2011.

Imports from Northern Europe ... Volume / Port Share





Exports to Northern Europe ... Volume / Port Share

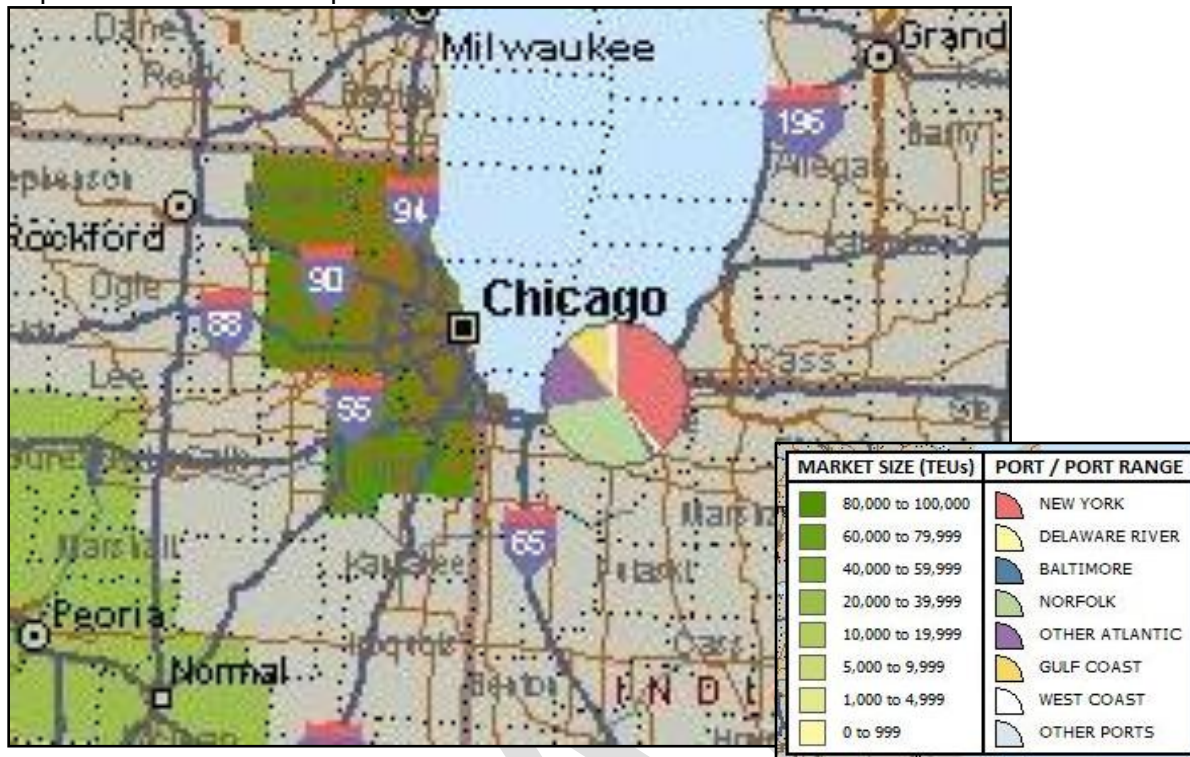

Imports from China ... Volume / Port Share

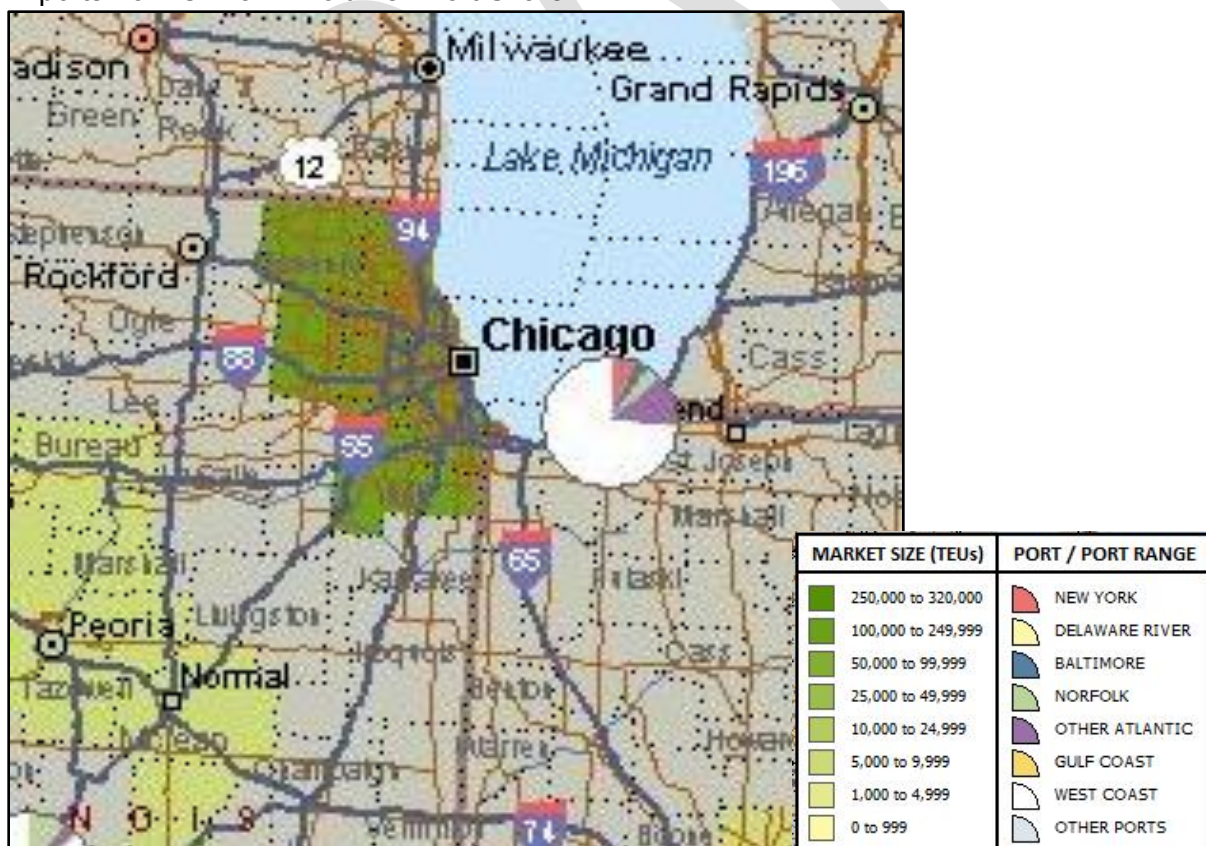



Exports to China ... Volume / Port Share

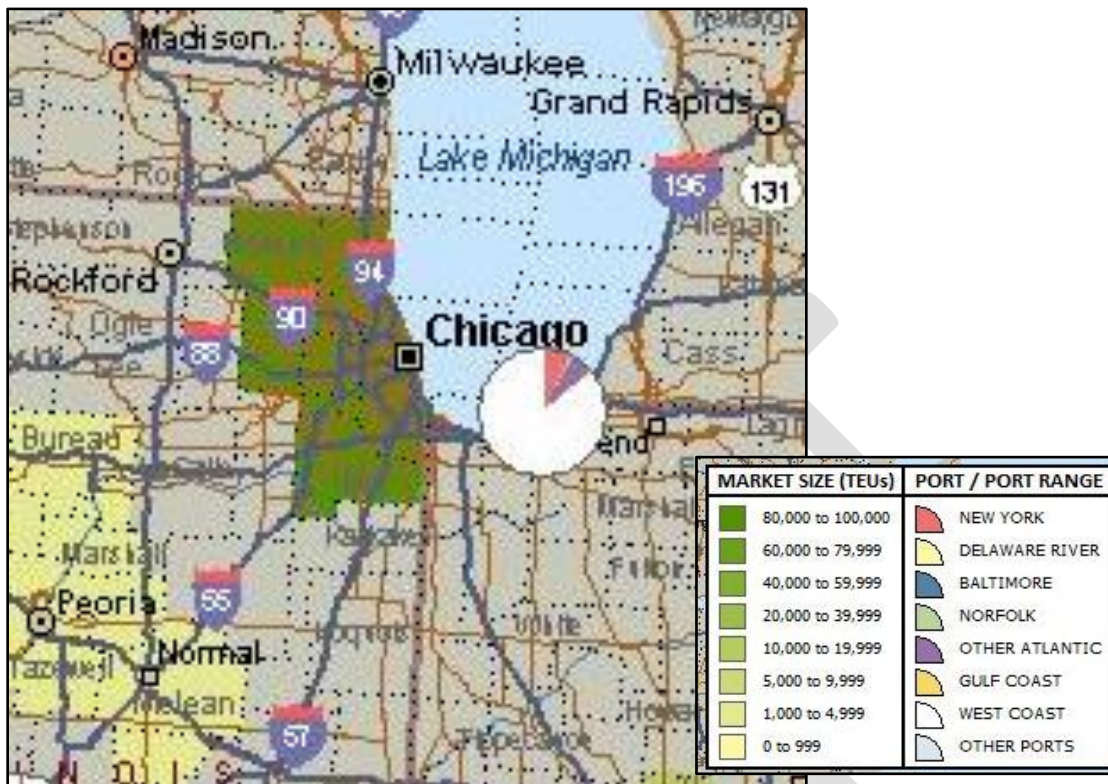

Imports from Southeast Asia ... Volume / Port Share

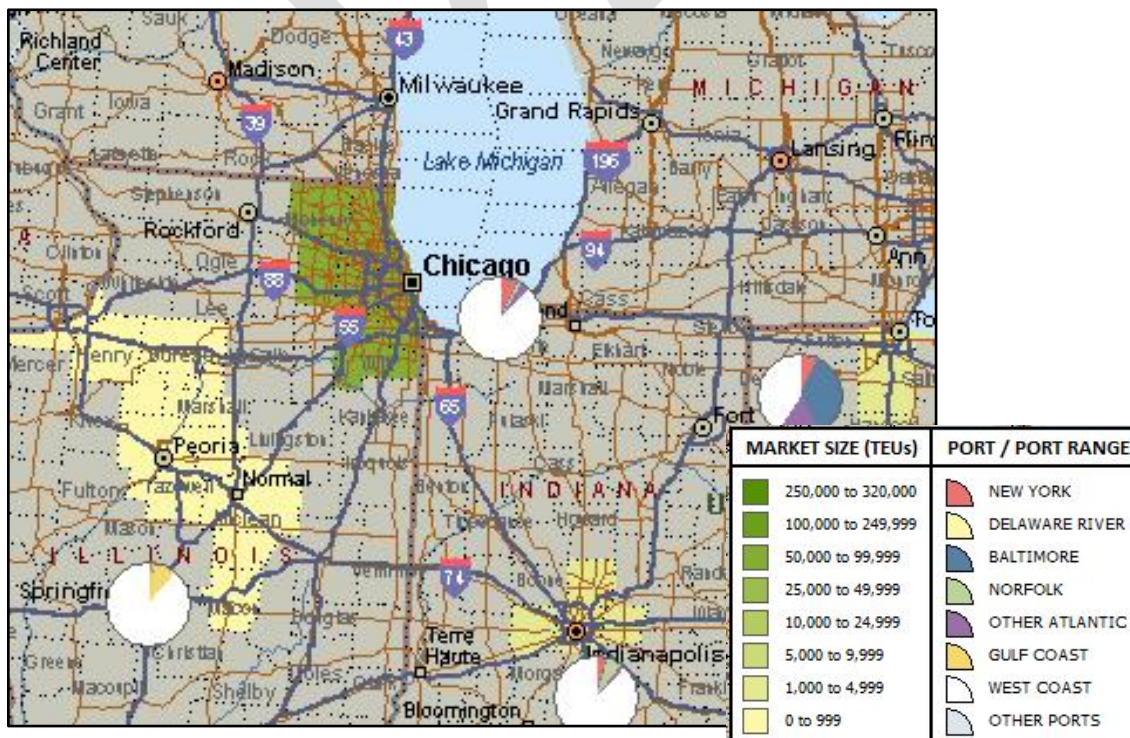



Exports to Southeast Asia ... Volume / Port Share

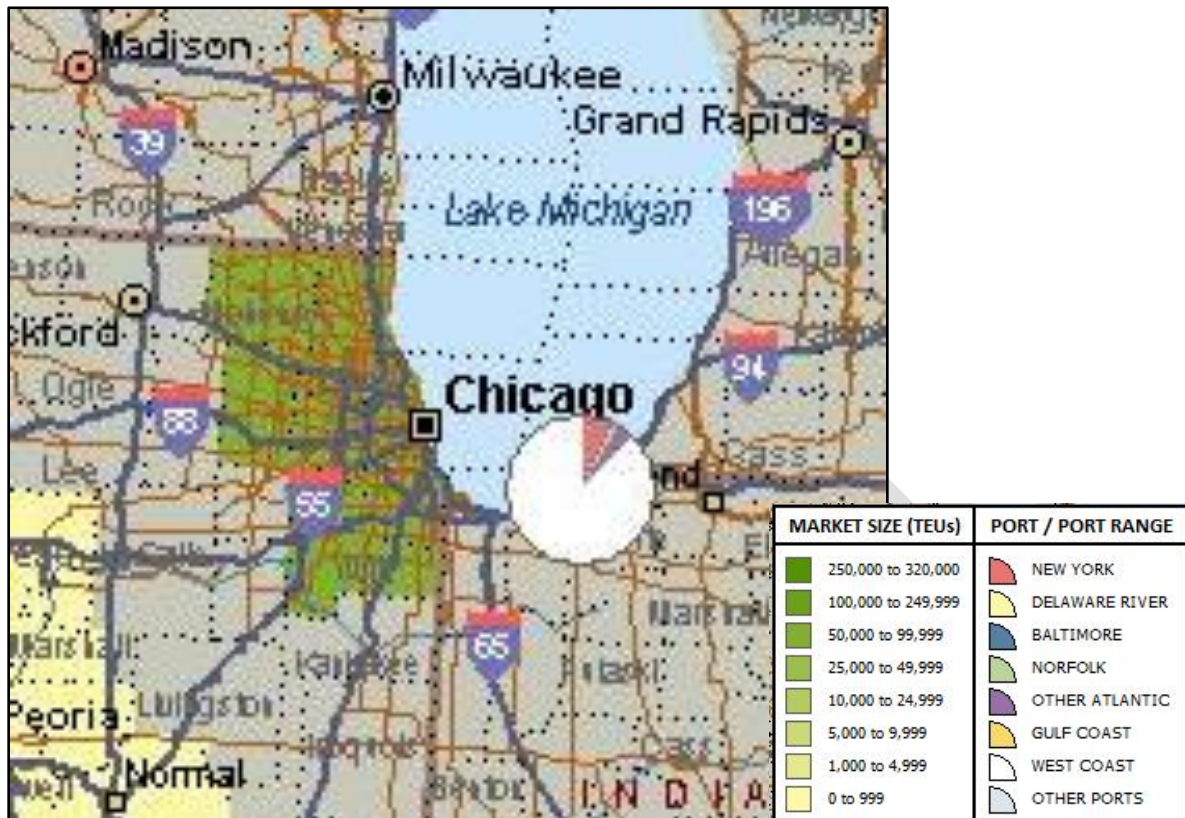

Imports to South America ... Volume / Port Share

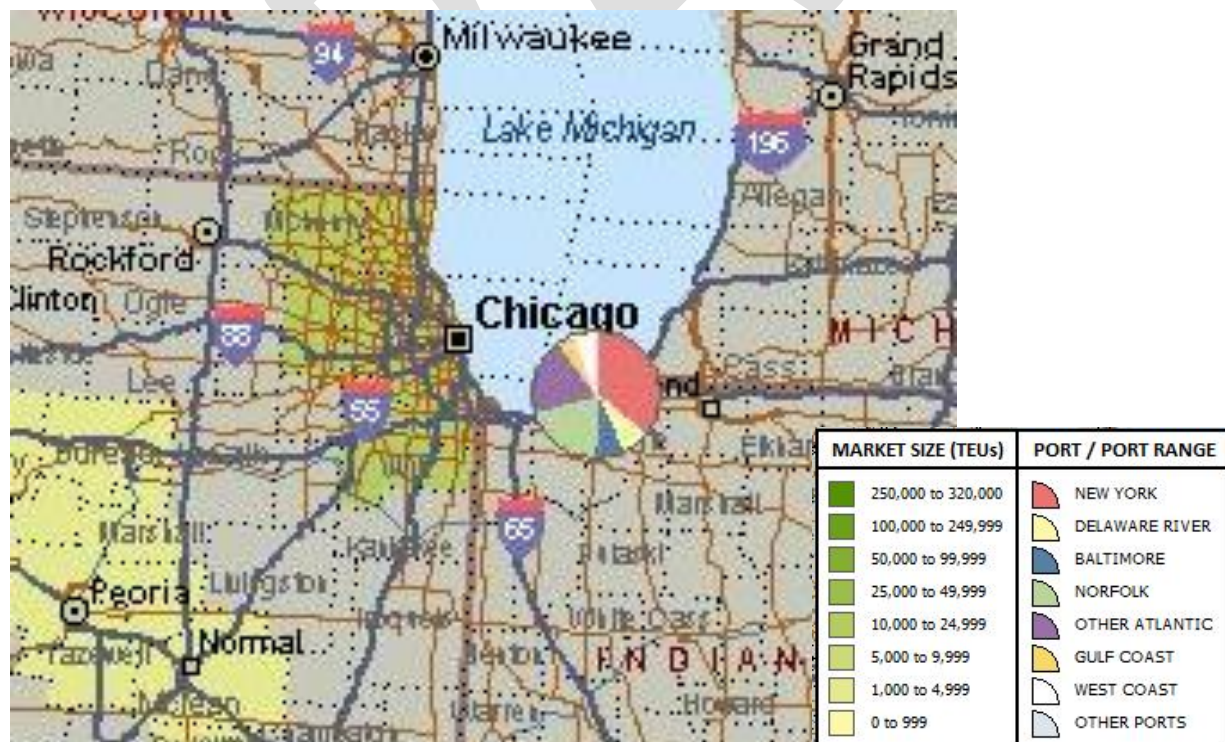

Exports to South America ... Volume / Port Share

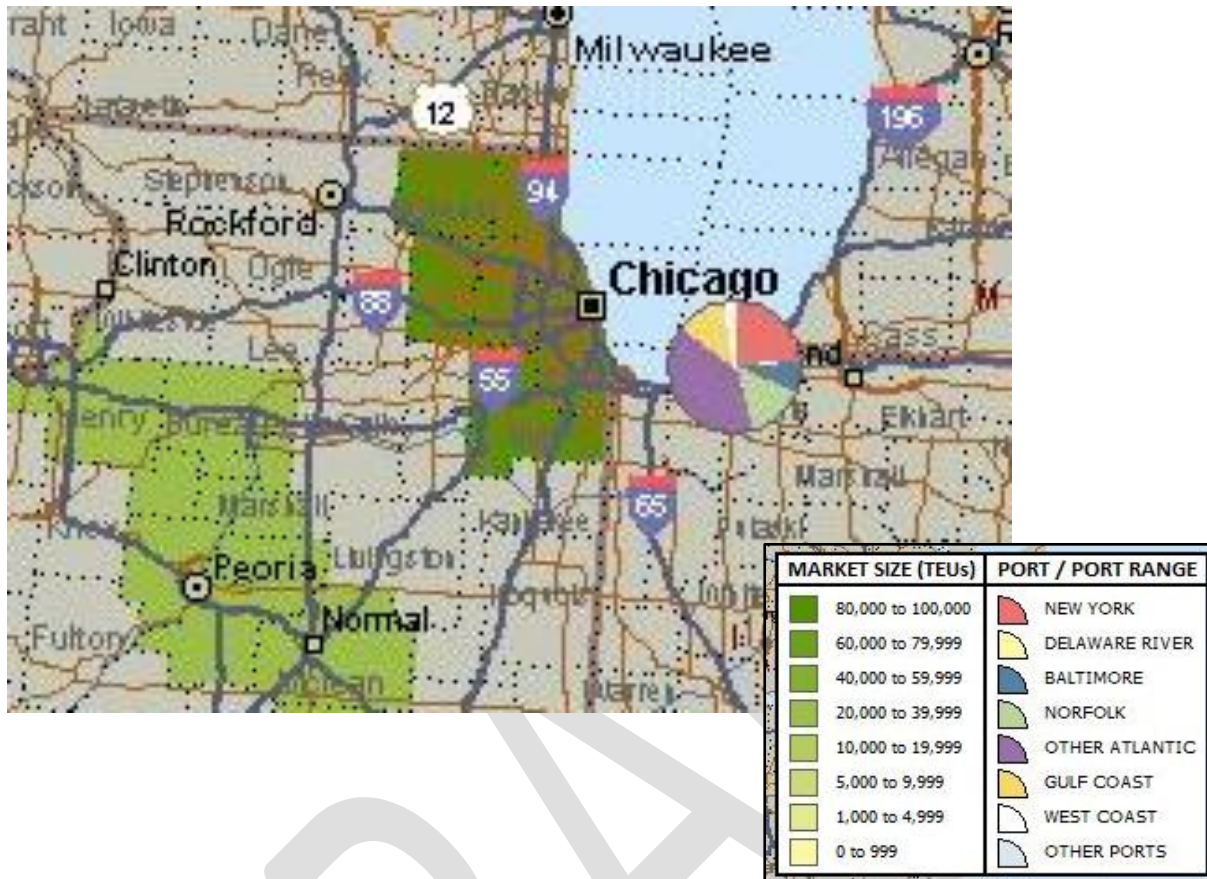



## Section III

### The Nation's continued Trade Growth (domestically and internationally) will force changes in how the Chicago area moves product.

#### Inland waterway System

The Illinois River and Mississippi River System, along with the Great Lakes, have historically served the nation's mid-county bulk markets with barge transportation services. These waterway systems can and will evolve into dual roles, much like the highway and rail systems do today, by serving both bulk and container markets.

#### Marine Highway program

Public (government) interest in container barge services is growing, as is evident from the Maritime Administration's (MARAD) Marine Highways Program, which was fully implemented in April 2 2011.

USDOT's Maritime Authority has begun research into advancing the concept of "Short Sea Shipping" (SSS). SSS is a concept used in Europe that has resulted in more than 40 percent of the domestic freight in Europe moving by water between ports. Today, only 13 percent of U.S. domestic trade moves by water. USDOT is promoting the concept of SSS in the United States as a way to move domestic freight, adding capacity instead of competition. USDOT is also focusing its attention on the need to improve the "first and last mile" of roadway access to U.S. water ports.

#### New vessel technologies

COB is being developed in a number of North American waterways, following the success of this technology on the Rhine/Danube river system. In addition, new high-speed river and coastal vessel technologies, capable of speeds greater than barges, are currently being researched in Europe. New smaller and larger container ships are being built that are capable of up to 20 knots. These vessels have relatively low energy costs and large payloads. The potential of these modern vessel technologies has the potential to greatly change the service levels and transit times on the Great Lakes.

To help compensate for any potential higher costs for COB, the RNO Consulting group recommends the following approach, which the Calumet River multimodal logistic center certainly achieves.

*"Concentrate reverse landbridge services between efficient ports and large markets. Aggregate services from the most efficient ports where a higher ratio of goods can transition between international containers and domestic shipments in shorter timeframes. And limit operations at the market end to a single logistics park so as to increase service velocity, reduce local shuttle costs, and improve equipment utilization efficiencies." ([http://www.rnogroup.com/Freight\\_Planning.html](http://www.rnogroup.com/Freight_Planning.html) ...report 20)*

### Panama - Suez influence

It is anticipated that at least 30 percent of West Coast port growth will be diverted via the Panama Canal (15 %) and by a round the world route via the Suez Canal (15%) to East Coast ports. In addition, the Suez Canal route appears to be an increasingly viable alternative due to, first, the expansion of trade south and west in Asia and, second, the ability of the Suez Canal to handle the larger post-Panamax container ships. Both of these trends could favor deployment of additional vessels and freight to North American's East Coast and Gulf Coast ports.

The Panama Canal's expansion is driving Gulf Coast container handling capacity. The Gulf Coast has plans for total container capacity in excess of 9 million TEUs over the next decade, up from 2 million TEU's currently. In the vicinity of the Mississippi River's base (from New Orleans to Mobile), the capacity could exceed 4 million TEUs alone. The Mississippi River and the Illinois River serve a large manufacturing base, the breadbasket of the nation. This base can support a COB business along the Rivers and into Chicago and then into the Great Lakes. Today this base is served by land bridge rail services from the west coast as well as by truck and rail from the east and gulf coasts.

### **The Infrastructure will change within the SLSLS region and create opportunities for the Calumet River Logistics Center**

Source: *GLSLS New Cargoes/New Vessels Market Assessment Report, 2007*

Within the Great Lakes – Saint Lawrence Seaway served area the region's population, employment, GDP, and trade are projected to grow significantly through 2050, and the region's freight traffic is expected to expand at an even faster rate. It is anticipated that a growing share of traffic moved by all modes of transportation will be by containers (including truck trailers). The total market for containerized traffic, which includes raw materials, food, and semi-finished and finished products, to and from the region is expected to more than double by 2050, from 35 million to over 70 million forty-foot units annually. This growth will create issues.

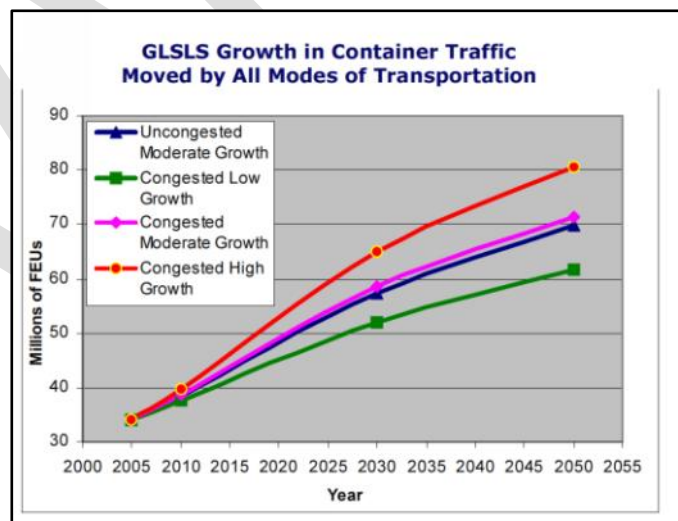

Today, as in future forecasts, trucks move the lion's share (over 98% in 2005) of containerized freight tonnage, and rail is moving the remaining 2 percent. However, available highway and rail capacity is suffering from deteriorating levels of service. In the case of highways, the capacity crunch is largely due to the growth of automobile traffic, particularly around major cities, such as Chicago. In the case of railroads, a move to increase productivity over the past two decades resulted in increased concentration, amalgamation, and abandonment of secondary lines. As a result, moving containers by truck and rail in the future will cost more and



probably take longer, since traffic is expected to outgrow any improvements in capacity and congestion is expected to increase.

Over the next twenty to thirty years, if current trends continue, the freight volumes will increase by at least 70 to 100 percent. Recent data and forecasts show trade volumes increasing rapidly as the level of integration of the world economy increased. For example, U.S. imports increased 63% in the 10 years from 1992-2002, while U.S. imports grew 138 percent in the same period according to the U.S. Bureau of Economic Analysis. The existing infrastructure will find this trend difficult to handle due to capacity limitations; and once existing modes reach full capacity, cargo will seek new opportunities to reach markets. At this point, the GLSLS System will become more competitive and more attractive for container traffic

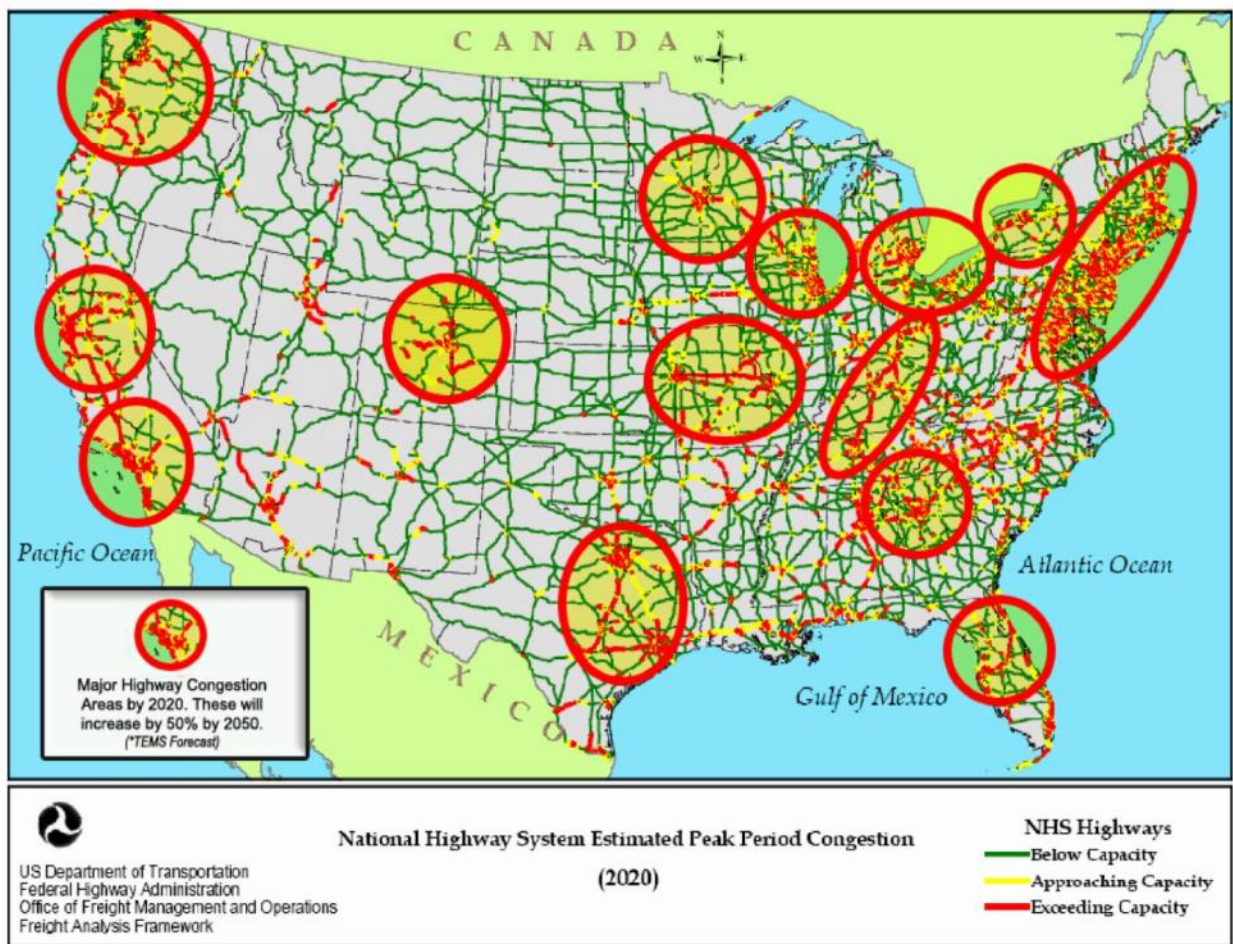

In terms of long-term growth, container traffic offers the greatest opportunity, in that it is growing very rapidly, while the demand for bulk cargo is much lower. The projected annual growth rates for container traffic range between 4 and 6 percent and even higher, whereas it is only 1 to 2 percent for bulk cargo. While the movement of bulk cargo grew quite strongly in the 1980's, it has been slowing down in recent years. "While bulk cargo provides the highest volume (for the GLSLS) it generates a much lower return than container traffic. Given the higher growth rate and the increase "value adder" of container traffic, container traffic clearly offers the greatest opportunity for increasing revenue and improving the economics of the GLSLS System.

"The continued expansion of world trade and the increasing globalism of world markets have implications for the existing port and inland waterway supply chain and logistics system of the current port and inland distribution systems. Not only are some ports reaching capacity and finding them unable to deal with the increasing size of containers ships, but the inland distribution systems feeding from the ports are also reaching capacity. In this environment, it might well be difficult for the current system to provide for all the needs of trade growth."  
(Report 3, 3A)

The GLSLS Market Assessment Study (January 2007) states

**T**he study shows that the GLSLS has the potential to play a significant part in helping to relieve anticipated capacity shortfalls in the movement of containers to U.S. and Canadian markets. Under very conservative assumptions about the future growth of the economy and trade and continuing difficulties in building new highway and rail capacity, a detailed analysis of shipper behavior shows that modern GLSLS-max container ships (20 knots) can be competitive with truck and rail, and attract significant container traffic. In this way the GLSLS can play a role as an intermodal reliever in helping to move containers to, from, and within the GLSLS market areas.



- **I-H<sub>2</sub>O West** - There are substantial domestic and cross-border freight flows between Chicago and eastern Wisconsin and Lake Erie, Central Canada, and Montreal which can be served with water intermodal services. In addition, given increasing rail congestion in Chicago and the limited ability of railroads to expand terminal capacity there, the Great Lakes could provide a Chicago bypass for some West coast container traffic. From the ports of Tacoma, Seattle, Vancouver, and Prince Rupert, the Burlington Northern Santa Fe (BNSF), Canadian National (CN), and Canadian Pacific (CP) railroads can transfer containers at the Lake Superior ports of Duluth and Thunder Bay for vessel transport to Great Lakes ports further east and south.

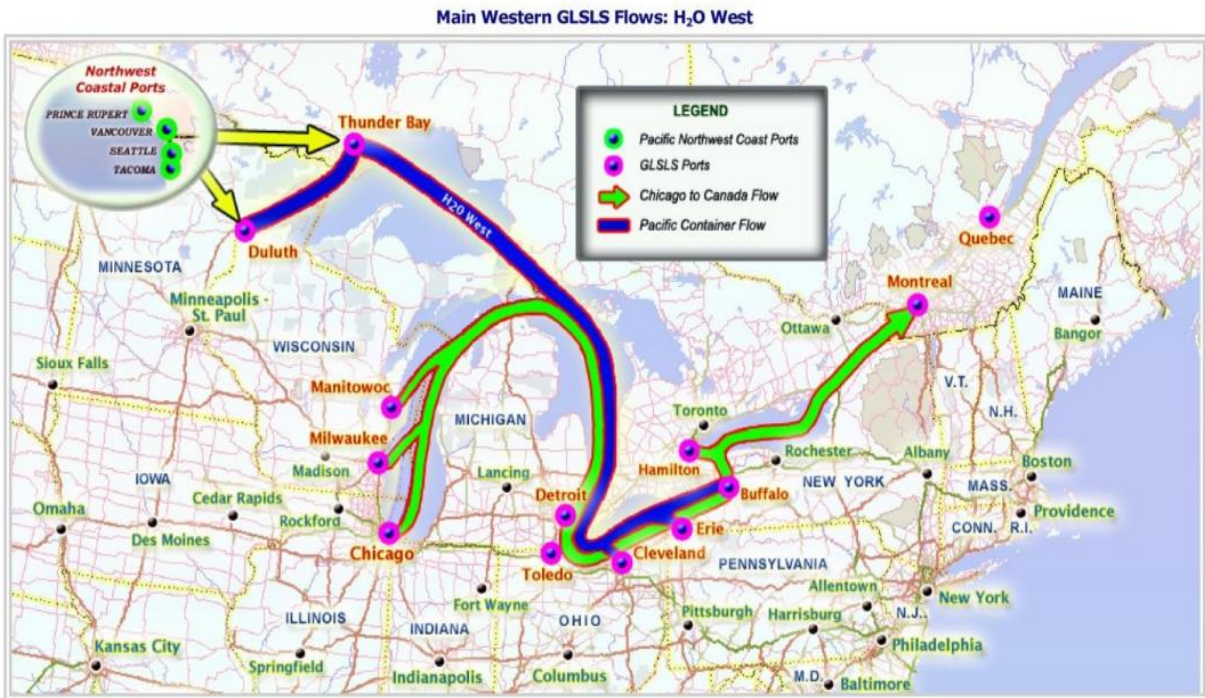

- **GLSLS Domestic Connector** - Services that provide an inter-lake/inter-seaway connection for domestic containers from Chicago to Montreal would bypass major rail and road congestion areas such as Chicago, Detroit/Cleveland, Buffalo/Toronto, and Northeast coastal cities.
  - Initial volumes and service requirements suggest that 150-200 FEU capacity, 20-knot, Ro/Ro container vessels could meet market demand, while also keeping intermodal transfers to truck and rail services as simple and as fast and cheap as possible. As traffic builds, however, higher volume containerships (GLSLS-max with 300-400 FEU capacity) and new port container handling facilities should become cost-effective for moving both domestic and international freight.

Source: The GLSLS Market Assessment Study (January 2007)

The net effect of continued economic growth, increased Asian trade, and capacity limitations on the region's highways and railroads is an increased potential for water to play a greater role in the transportation of container and palletized (neobulk) traffic. Conservative assumption on highway and rail capacity limitations suggest that –

- As road freight, traffic continues to grow to accommodate trade growth the market share of freight moved by truck will decline due to the congestion related diversion of traffic.
- The share of freight moved by railroads could grow assuming the railroads begin to bring back unused capacity in secondary lines and some bypass routes.
- The intermodal water option will grow if it can become competitive with rail and highway.

The opportunity exists for a Port Terminal on the Calumet River that integrates barge, ship, and rail freight.

---

<sup>i</sup> 2009 (Jan) article Container Flows in World Trade #25

<sup>ii</sup> Cambridge study for West Va

<sup>iii</sup> Report 3

<sup>iv</sup> ICW 1

<sup>v</sup> ICW 1

<sup>vi</sup> West Va report # 25

<sup>vii</sup> Report #18

<sup>viii</sup> Reports 2

<sup>ix</sup> <http://www.idi.com/about-us/market-offices/chicago-office>

<sup>x</sup> <http://www.idi.com/about-us/market-offices/chicago-office>

<sup>xi</sup> <http://www.idi.com/about-us/market-offices/chicago-office>

<sup>xii</sup> Report # 25

<sup>xiii</sup> Report #18

**A8. TRANSPORTATION TECHNICAL MEMO**





# CAWS Study Baseline Transportation Conditions

---

The purpose of this memorandum is to describe the baseline transportation conditions in the Chicago Area Waterways System (CAWS) study area. Information was obtained from readily available sources. The baseline conditions include existing and programmed/funded improvements as of January 1, 2011, and describe infrastructure and operations for water; railways; and roadways within the CAWS study area. Costs associated with these funded and/or authorized transportation programs/projects are assumed to be incurred by the respective agency and will not impact separation option costs. Land use information is also described. The intended use of this memorandum is to provide useful information to help determine potential impacts and opportunities to the CAWS study area transportation system as a result of the placement of an aquatic invasive species barrier(s).

## **I. INTRODUCTION**

The Greater Chicago area has historically played a major role as a freight hub within the United States (U.S.). Railroads, interstates, airports, and waterways all converge in Greater Chicago, making it a strategic location as a national freight hub. Over 500 freight trains operate within the region daily. An expansive interstate system carries over half of the region's freight each year, and O'Hare Airport is one of the largest U.S. foreign trade gateways. The extensive Chicago waterway system provides full connectivity between Chicago, the Great Lakes, and the Mississippi River.

In 2007, Cambridge Systematics prepared a report on freight system planning to assist the Chicago Metropolitan Agency for Planning (CMAP) in developing freight system recommendations for the GO TO 2040 Regional Comprehensive Plan.<sup>1,2</sup> Much of the information in the CMAP report and in the GO TO 2040 Plan is based on an analysis of the TRANSEARCH database. The TRANSEARCH database, maintained by IHS Global Insight, is an annually-updated dataset of U.S. county-level freight movement data by commodity type and mode of transportation. The freight statistics below are primarily based on information contained in the GO TO 2040 Plan.

CMAP estimates that approximately 1.472 billion tons of freight was moved by truck in 2007 — more than 2.3 times the rail volume, and approximately 67 percent of the annual regional freight tonnage. Of this total, approximately 36 percent of all freight movements were through-traffic. Three percent of freight moved by water, and less than one percent was moved by air. Total tonnage moved by both truck and rail is expected to increase substantially over the next 30 years, and waterborne freight is also expected to grow but at a slower pace and would carry a smaller portion of total regional freight. The reports prepared by Cambridge Systematics on behalf of CMAP indicate that “the much lower comparative water tonnage shows that the maritime network may be underutilized, given the high amount of capacity for the region (both inland waterways and on the Great Lakes with access to the St. Lawrence Seaway) and the region's reliance on heavier commodities such as steel manufacturing inputs, agricultural produces and byproducts, and construction materials.”<sup>3</sup> The ability of Chicago's rail network, port, roadways, and airports to carry freight efficiently will affect the overall competitiveness of the region's and the nation's economy.

---

<sup>1</sup>Bretthauer, Vicki W. and Martland, Carl D. Cambridge Systematics, Inc. 2007. Regional Freight System Planning Recommendations Study. Prepared for CMAP. Chicago, Illinois.

<sup>2</sup> GO TO 2040 Regional Comprehensive Plan, CMAP, 2010.

<sup>3</sup> Regional Freight System Planning Recommendations Study, prepared by Cambridge Systematics for CMAP, 2007.

# CAWS Study Baseline Transportation Conditions

**Figure 1: Freight Tonnage by Mode, 2007 - 2040**

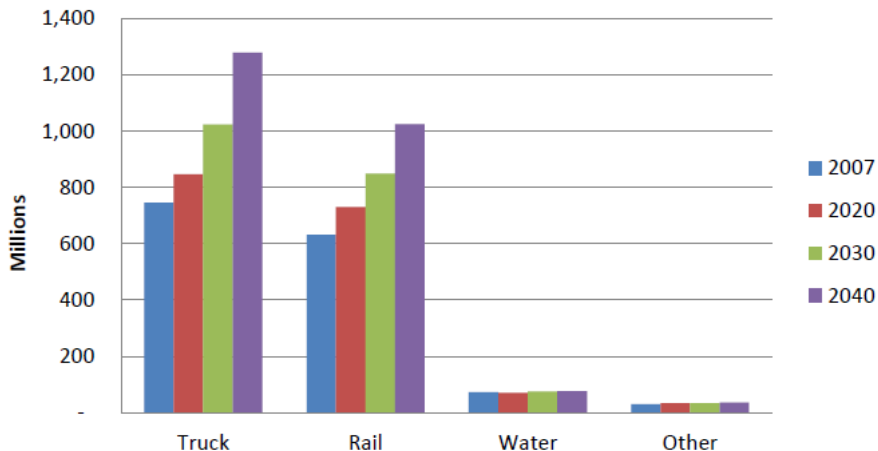

Source: TRANSEARCH. Air cargo < 0.1% of total freight volume

## **II. WATERBORNE TRAFFIC AND OPERATIONS**

The U.S. Army Corps of Engineers (USACE) website and Navigational Charts<sup>4</sup> were consulted to identify the locations and characteristics of the various water-based operation installations and other infrastructure affecting traffic and operations on the CAWS. The navigational charts provide a great deal of useful information. An example of a navigational chart is included as Exhibit A.

The navigational charts indicate the locations of harbors, marinas and small craft facilities on the CAWS. Most are located on Lake Michigan, the Chicago River, and the Calumet River. Mooring facilities are also located on the Calumet River and the Chicago Sanitary and Ship Canal.

### **A. INFRASTRUCTURE**

#### **1. ILLINOIS HARBORS AND PORTS**

**Chicago Harbor and Controlling Work Lock:** The Chicago Harbor is located on Lake Michigan at the mouth of the Chicago River. Authorized depths are 29 feet in the Lake Michigan harbor approach, 28 feet in the outer harbor, and 21 feet at Rush Street. The Federal channel within the harbor is 2.20 miles and it connects to the deep draft Chicago River channel extending 4.02 miles to the North Avenue Turning Basin. This harbor is a part of the Port of Chicago, and is the secondary link of the Great Lakes and the Inland Waterway System. In 2007, 1.7 million tons were shipped on the Main and North Branch of the Chicago River; 149,000 tons were directly received through this harbor. The harbor has a United States Coast Guard (USCG) Station, Chicago Marine Police, Illinois Conservation Police, Chicago Fire Dept.'s Fire Boat and City tug. Commodities handled are general cargo, petroleum, newsprint, salt, and cement. Privately-owned

<sup>4</sup> USACOE, *Inland Electronic Navigational Chart, Edition 1, Version 3.1, May 2008*

## CAWS Study Baseline Transportation Conditions

---

marinas at the Harbor moor 1,450 recreational boats. The harbor is a safe refuge on southern Lake Michigan for barges and vessels traveling north from or south to the Port of Chicago.

The USACE has indicated that improvements are needed to the Harbor and Controlling Works Lock to maintain safe operations, including repair of the northwestern breakwater, stabilization of the North Pier Utility tunnel, and the addition of gate winches as a fail-safe measure.

**Calumet Harbor:** The Calumet Harbor is located on Lake Michigan at the Calumet River in Chicago, Illinois. The approach channel and outer harbor are located in Lake County, Indiana.

Calumet Harbor is the primary link between the Inland-Waterway system, the Great Lakes, and foreign ports. From this harbor, deep-draft ships can reach the Atlantic Ocean through the St. Lawrence Seaway, and barges can reach the Gulf of Mexico through the Illinois and Mississippi Rivers. The harbor is central element of the Port of Chicago, the 33rd leading U.S. port and the 2nd largest port on the Great Lakes. Calumet Harbor, by itself, is a leading U.S. port, with 14.6M tons shipped or received in 2007. The Harbor is connected to 154 commercial ports: ships to 74 ports, and receives from 80 ports. The Harbor channel extends down the Calumet River to the Illinois Waterway (6.74 miles), and to Lake Calumet (1.30 miles). Commodities shipped on the Calumet River include limestone, coke, coal, salt, grain, cement, liquid bulk, potash, and steel. Nearly three million tons of coal is shipped to 22 ports on the Great Lakes. Thirty industrial tenants operate in the harbor, as well as a USCG Search and Rescue Station. The Chicago Confined Disposal Facility (CDF), with a total storage capacity of 1.3 million cubic yards of contaminated sediment, is also located at Calumet Harbor. The CDF is nearing capacity and requires additional storage capacity.

The Illinois International Port District (The Port) operates and maintains the Iroquois Landing Lakefront Terminus at the Harbor. Iroquois Landing is a 100-acre, open paved terminal with 3,000 linear feet of ship and barge berthing space with a navigational depth of 27 feet. It specializes in intermodal container service, with two 110,000 square-foot transit sheds and direct truck and rail access. 100 acres of adjacent property is currently available for lease and development.

**Lake Calumet:** The Port also operates and maintains Lake Calumet. Lake Calumet operations and terminals are located at the junction point of the Grand Calumet and Little Calumet Rivers approximately six miles inland from Lake Michigan. The southwest quadrant of Lake Calumet consists of three transit sheds totaling over 315,000 square feet adjacent to approximately 3000 linear feet of ship and barge berthing space. The Port owns two grain elevators at Lake Calumet with a capacity of 14 million bushels. The Port also has liquid bulk storage capacity of 800,000 barrels.

### **Chicago Park District Harbors:**

The Chicago Harbor System is comprised of nine different harbors along Lake Michigan. From north to south, these harbors include: Montrose Harbor, Belmont Harbor, Diversey Harbor, Dusable Harbor, Monroe Harbor, Burnham Harbor, 59<sup>th</sup> Street Harbor, and Jackson Park Outer & Inner Harbors. The harbors have different designs and accommodate a wide range of waterway traffic. Due to the Lakeshore Drive overpasses, only motorboats are allowed at the Diversey, 59<sup>th</sup> Street and Jackson Harbors. The remaining six harbors are accessible to motorboats and sailboats. The system contains over 5,100 boat slips and mooring is operated by the Chicago Park District.

Due to its current operation at capacity, the Chicago Park District created a 20-year framework plan for system recommendations. Additional harbors are proposed at Gateway Harbor, which

---

# CAWS Study Baseline Transportation Conditions

---

will be located just south of Navy Pier; Dusable East Harbor, also south of Navy Pier; 31<sup>st</sup> Street Harbor, adjacent to the 31<sup>st</sup> Street Beach; and the 87<sup>th</sup> Street Harbor, which is included as part of the redevelopment of the former USX Steel property, adjacent to the Calumet River. In all, these proposed projects amount to the addition of over 2,700 new boat slips and moorings to the Harbor system.

## **Other Harbors**

At least eight other recreational vessel harbors, marinas, and private docks are located on the Calumet River and Little Calumet River.

## **2. INDIANA HARBORS AND PORTS**

**Indiana Harbor:** Indiana Harbor is located on the southwest shore of Lake Michigan in East Chicago, Indiana about six miles southeast of Calumet Harbor. It is the 42nd leading U.S. port with 15.4 million tons of material shipped or received in 2008, and is interconnected with 83 commercial ports. It is ranked first in tonnage among the 25 Federal harbors on Lake Michigan and second in tonnage of the 55 Federal harbors on the Great Lakes; however, total commodities handled at this port, both foreign and domestic, has declined sharply since 2006.

Indiana Harbor has 4.7 miles of Federal Channel, consisting of the Indiana Harbor Canal, the Calumet River Branch, and the Lake George Branch. Major stakeholders include ArcelorMittal Steel, US Gypsum, LaFarge Cement, and Amoco, with ArcelorMittal's Indiana Harbor facility being the largest steelmaking complex in North America. Commodities are iron ore, limestone, coke, gypsum, steel, cement and concrete, petroleum products, and miscellaneous bulk products, generating nearly \$174 million annually in direct revenue.<sup>5</sup> Of the 8 million short tons in commodities at this Harbor in 2009, most was crude material and iron ore.<sup>6</sup>

**Burns Harbor:** Burns Harbor is located in Portage, Indiana, on the south shore of Lake Michigan, 18 miles from Chicago, and handles shipments to and from the CAWS. It is one of three ports managed by the Port of Indiana. Burns Harbor handles more ocean-going cargo than any other U.S. Great Lakes port and 15 percent of U.S. steel trade with Europe. The port handles international ships via the St. Lawrence Seaway, and barges via inland river links, including the CAWS, to 38 states and the Gulf of Mexico. As a multi-modal facility, the port handles an average of 500,000 trucks, 10,000 railcars, 400 barges and 100 ships per year. The port has 600 acres of land, 30 tenant companies and 85 acres of available land. Major cargoes include iron, steel, grain, chemicals, fertilizers, limestone, coal/coke, salt and heavy-lift project cargo.<sup>7</sup>

## **3. CARGO HANDLING TERMINALS AND BARGE FACILITIES**

There are 154 cargo handling terminals<sup>8</sup> and barge facilities on the CAWS. The USACE Navigational Charts provide information for each of these facilities, including the waterway; barge facility name; type of service; and commodities, as appropriate. An example of a navigational chart and corresponding barge facility information is included as Exhibit A. Of note, there are over 30 facilities within the Calumet Harbor.

---

<sup>5</sup> <http://www.lre.usace.army.mil/ETSpubs/HFS/Indiana%20Harbor.pdf>; Feb. 2011

<sup>6</sup> [http://www.ndc.iwr.usace.army.mil/wsc/webpub09/Part3\\_Ports\\_tonsbyTT\\_Dr\\_Yr\\_commCY2009-2005.HTM](http://www.ndc.iwr.usace.army.mil/wsc/webpub09/Part3_Ports_tonsbyTT_Dr_Yr_commCY2009-2005.HTM)

<sup>7</sup> [www.portsofindiana.com](http://www.portsofindiana.com); 2009.

<sup>8</sup> USACE, GLMRIS Baseline Assessment of Cargo Traffic on the Chicago Area Waterway System, Dec. 2011.

---

# CAWS Study Baseline Transportation Conditions

---

## 4. LOCKS

There are three primary locks on the CAWS system: the Chicago Harbor Lock, the TJ O'Brien Lock, and the Lockport Lock. Their locations are depicted on the navigational charts in Exhibit A, as well as Exhibit B. Data on lockage use was obtained from the USACE<sup>9</sup>. Some additional information was obtained from a report prepared by the Chaddick Institute<sup>11</sup>.

The USACE GLMRIS project released a report in December 2011 describing cargo traffic on the CAWS. The data in the GLMRIS report is consistent with this study.

**Chicago Controlling Works Lock:** The Chicago Lock is located on Lake Michigan at the mouth of the Chicago River in the heart of downtown Chicago, and serves as a gateway to one of the nation's busiest commercial and recreational waterways. The lock is managed by the USACE and limits Lake Michigan water flows into the Illinois Waterway. It provides flood damage reduction to the downtown area from the Chicago River. It is open for navigation 24 hours per day, 7 days per week all year long. It takes 15 minutes to cycle through the lock, and can lock 50-100 vessels at once. The gate measures 600' long by 80' wide, with a depth of 22.4 feet and a lift of 1 to 4 feet. The USACE has determined that the Chicago Lock is in need of repair. The lock handles mostly passenger vessels, and relatively few barges. However, it is noted that this lock serves as a backup for cargo vessels when the TJ O'Brien Lock is not functioning.

*Non-cargo vessels:* According to a recently released USACE GLMRIS report on non-cargo data, the Chicago lock sees an average of 711,902 commercial passenger one-way trips and 41,071 non-cargo vessel one-way trips annually (based on averaging 2000 through 2010 data). This includes passenger boats or ferries; governmental vessels, commercial fishing vessels, and recreational vessels. In 2010, there were over 35,000 non-cargo vessels that utilized this lock. The total number of vessels using this lock has declined by 10% since 2005; however, the number of commercial passenger vessels, such as tour boats, has risen by 11%, and in 2010, there were over 805,000 passengers.

**Table 1: Chicago Controlling Work Lock, Non-cargo Traffic (2005-2010)**

year	2005	2006	2007	2008	2009	2010
vessels	40,084	35,454	39,676	36,088	34,839	35,957
commercial passengers	728,591	687,567	774,950	732,438	685,012	805,575

---

<sup>9</sup> USACE, Navigation Information Connection <http://www2.mvr.usace.army.mil/nic2/default.cfm/>, accessed 4/8/2011

<sup>10</sup> USACE, GLMRIS, Baseline Assessment of Non-Cargo CAWS Traffic, Sept. 2011

<sup>11</sup> Schwieterman, Joseph. AN ANALYSIS OF THE ECONOMIC EFFECTS OF TERMINATING OPERATIONS AT THE CHICAGO RIVER CONTROLLING WORKS AND O'BRIEN LOCKS ON THE CHICAGO AREA WATERWAY SYSTEM, Chaddick Institute for Metropolitan Development, DePaul University. April 7, 2010.

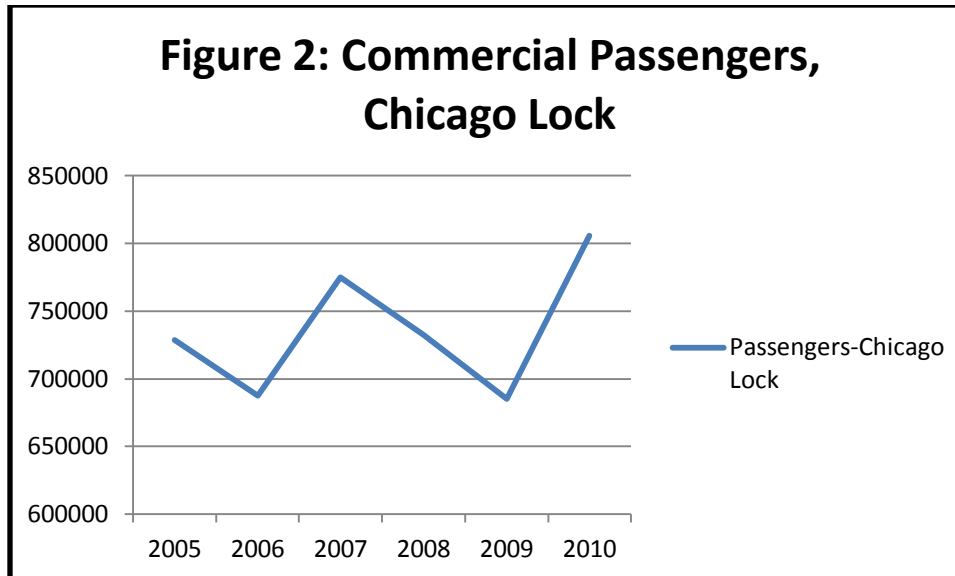

*Cargo Vessels:* In 2010, the Chicago Lock handled 175 barges carrying 102,000 tons of crude material. The split of upbound and downbound barges was relatively equal.

**TJ O'Brien Lock:** The O'Brien Lock is located approximately 7 miles from Lake Michigan, on the Calumet River. O'Brien Lock is a low lift sector gate lock. It provides a maximum lift of five feet for traffic passing from Lake Michigan to the Little Calumet River. The lock chamber is 1000 feet long by 110 feet wide. The adjacent dam is 257 feet in length and comprised of two sections. The fixed section is 204 feet of steel sheet pile cellular construction. The controlling segment, a reinforced concrete structure with four slide gate sections, is 53 feet in length. It takes 15 minutes to cycle through the lock. The lock handles both non-cargo and cargo vessels, and the USACE has determined that the O'Brien Lock is in need of major repair.

The USACE indicated in 2007 that a City of Chicago plan to reduce the width of the Chicago River in the City of Chicago, near the Chicago Lock has rerouted the barge traffic using the Chicago Lock to the O'Brien Lock. Although the USACE indicated that this will not cause a significant change in traffic flow, the result is that O'Brien Lock is essentially the only commercial access from the Illinois Waterway to Lake Michigan.<sup>12</sup> According to the Chaddick Institute report, the majority of commercial tonnage (98%) that is shipped over the Illinois waterway system en route to the Great Lakes uses the O'Brien Lock.

*Non Cargo Vessels:* The O'Brien Lock sees an average of 479 commercial passengers and 21,279 non-cargo vessel one-way trips (based on averaging 2000 through 2010 data). In 2010, there were over 14,000 non-cargo vessels that utilized this lock. Most of these (85%) are recreational vessels, likely originating from the numerous mooring facilities and private docks located south of the O'Brien lock. The number of non-cargo vessels using this lock has decreased since 2005, as shown below.

<sup>12</sup> Project Factsheet for Thomas J. O'Brien Lock and Controlling Works, Illinois Waterway, Illinois (Major Rehabilitation): 09/06/2007, USACOE



## CAWS Study Baseline Transportation Conditions

---

**Table 2: TJ O’Brien Lock, Non-cargo Traffic (2005-2010)**

Year	2005	2006	2007	2008	2009	2010
Vessels	22,543	18,488	20,596	17,288	16,069	14,238
commercial passengers	442	292	314	220	423	254

*Cargo Vessels:* In 2010, there were a total of 5,065 barges carrying over 5 million tons that used the O’Brien Lock. 3,192 were loaded, and 1,873 (37%) were empty. This is down from a high of nearly 10,000 barges in 2006. (See Figure 3). The split of upbound and downbound was relatively equal in 2010. The majority of upbound and downbound tonnage was coal, steel, manufactured goods, and crude material.

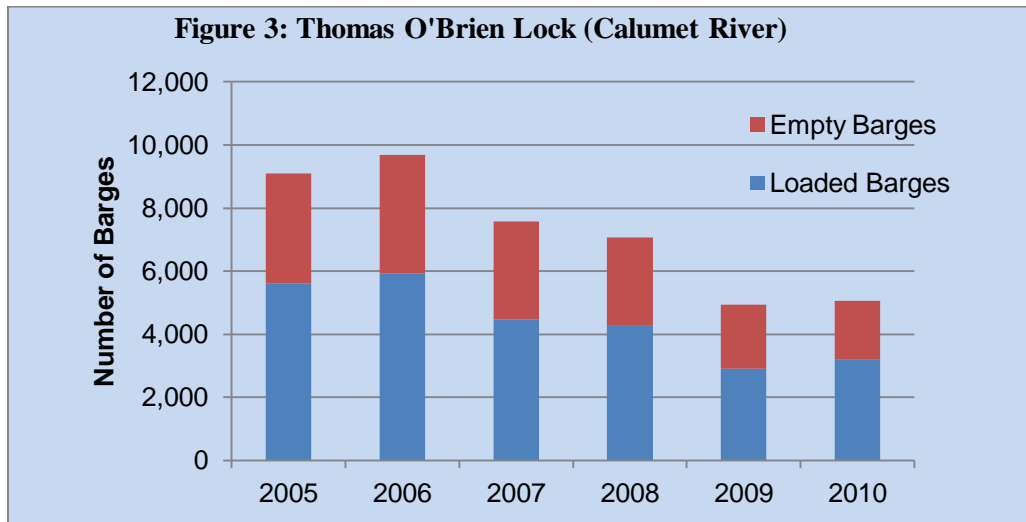

**Lockport Lock:** The Lockport Lock is located on the Chicago and Sanitary and Ship Canal. Lockport Lock and Dam are 291 miles above the confluence of the Illinois River with the Mississippi River at Grafton, Illinois. The complex is two miles southwest of the city of Lockport, Illinois. The lock is 110 feet wide by 600 feet long. Maximum vertical lift is 42.0 feet; the average lift is 39 feet. It averages 22.5 minutes to fill the lock chamber; 15 minutes to empty. The majority of vessels using this lock are barge, with limited non-cargo vessels.

*Non-cargo vessels:* The Lockport Lock sees an average of 164 commercial passengers and 3,026 non-cargo vessels each year (based on averaging 2000 through 2010 data).

*Cargo vessels:* In 2010, there were a total of 9,644 barges carrying over 9 million tons that used the Lockport Lock. 5,975 were loaded, and 3,669 (38%) were empty. This number is down from a high of nearly 18,000 barges in 2006. In 2010, there were more upbound loaded barges, and more downbound barges were empty. The majority of upbound and downbound tonnage was crude material, followed by coal, chemicals, petroleum, and manufactured goods. Upbound barges that enter the Lockport Lock can then travel on the Chicago Sanitary and Ship Canal, headed to destinations on the north CAWS, or on the Cal-Sag Channel, headed to destinations on the south CAWS and out to Lake Michigan and Indiana.

## CAWS Study Baseline Transportation Conditions

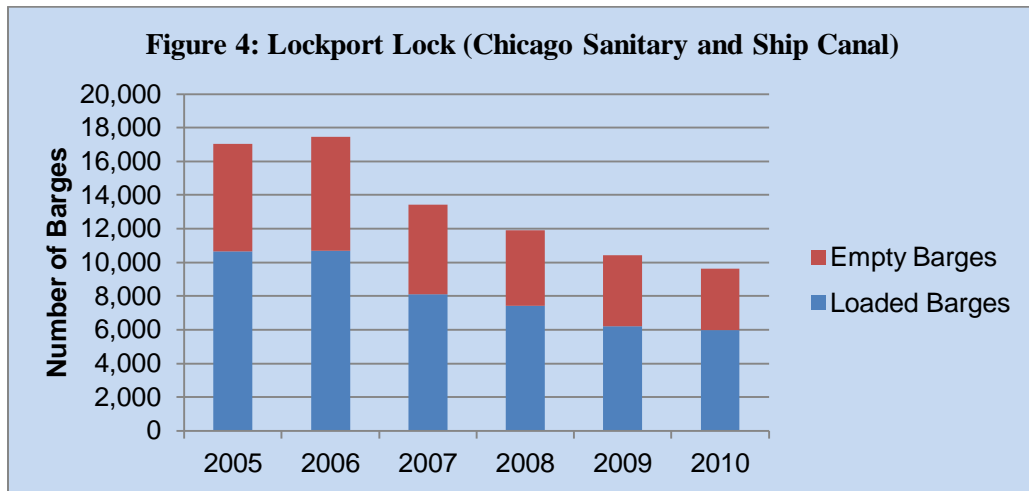

**Summary of Lock Data:** The Chicago Lock handles primarily non-cargo traffic, including passenger ferries and tour boats, recreational vessels, governmental vessels, and commercial fishing. There is very limited barge traffic handled at this lock. The TJ O'Brien Lock handles both recreational vessels as well as barges, and the Lockport Lock handles primarily barges. Figure 5 shows the comparison of barge traffic at the three locks. Two other locks, located south of the CAWS on the Des Plaines and Illinois rivers, are shown for comparison purposes.

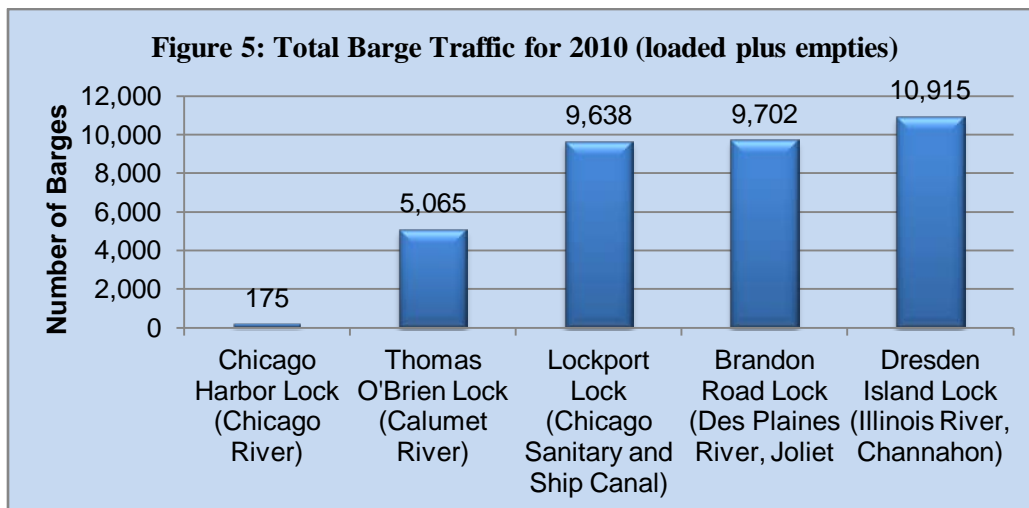

# CAWS Study Baseline Transportation Conditions

---

## **B. WATERBORNE TRANSPORTATION CHARACTERISTICS**

### **1. COMMODITIES**

According to CMAP's report and TRANSTECH's statistics<sup>13</sup>, waterborne freight in the Chicago business economic area (BEA)<sup>14</sup> consists primarily of relatively heavy, low value goods that are less time sensitive than freight carried by other modes. A total of nearly 73 million tons of waterborne freight moved in the Chicago BEA region in 2007, of which more than 60 percent (45 million tons) was inbound to destinations in the Chicago area. Twenty-six percent of the movements were outbound, while 12 percent was moving between points within the area. The CMAP report indicates that total freight tonnage for Chicago area locks has been declining since for the past several years (see Figure 6). Inbound tonnage is projected to decline over the next 30 years by approximately 25 percent, while outbound tonnage is expected to grow by 70 percent, bringing inbound and outbound movements to 34 and 33 million tons respectively. Local movements are expected to grow slowly over this period, climbing 24 percent from their 2007 level to a total of 11 million tons in 2040.

Coal is the largest commodity moved on the CAWS, followed by metallic ores and non-metallic minerals. According to CMAP, movement of coal is predicted to decline, while movement of metallic ores has a significant decline. Large increases in the shipped volumes of farm products, waste and scrap materials, and primary metal products are all predicted by 2040.

Freight trading partners are from various Great Lakes port regions, including Duluth, MN; Green Bay, WI; Northern Michigan, MI; and trading partners along the Illinois River to Mississippi River waterway network, such as St. Louis, MO, and New Orleans and Baton Rouge, LA. According to CMAP's report, trade with Duluth is projected to decline from about 16 percent of all freight to about three percent. Likewise, trade with New Orleans is anticipated to decline as a percent of all waterborne freight. The largest growth by percentage is the "elsewhere" category, which could indicate more diverse origins and destinations for waterborne freight trading with the Chicago region.

---

<sup>13</sup>Bretthauer, Vicki W. and Martland, Carl D. Cambridge Systematics, Inc. 2007. Regional Freight System Planning Recommendations Study. Prepared for CMAP. Chicago, Illinois.

<sup>14</sup> The Chicago BEA includes all counties within the CMAP region as well as the following Illinois counties: Kankakee, Iroquois, Boone, Winnebago, Stephenson, Grundy, DeKalb, Ogle, Lee, Carroll, Bureau, LaSalle, Putnam, Livingston, Mclean and DeWitt; the following Indiana counties: Lake, Porter, LaPorte, Newton, and Jasper; and Kenosha County, Wisconsin.

# CAWS Study Baseline Transportation Conditions

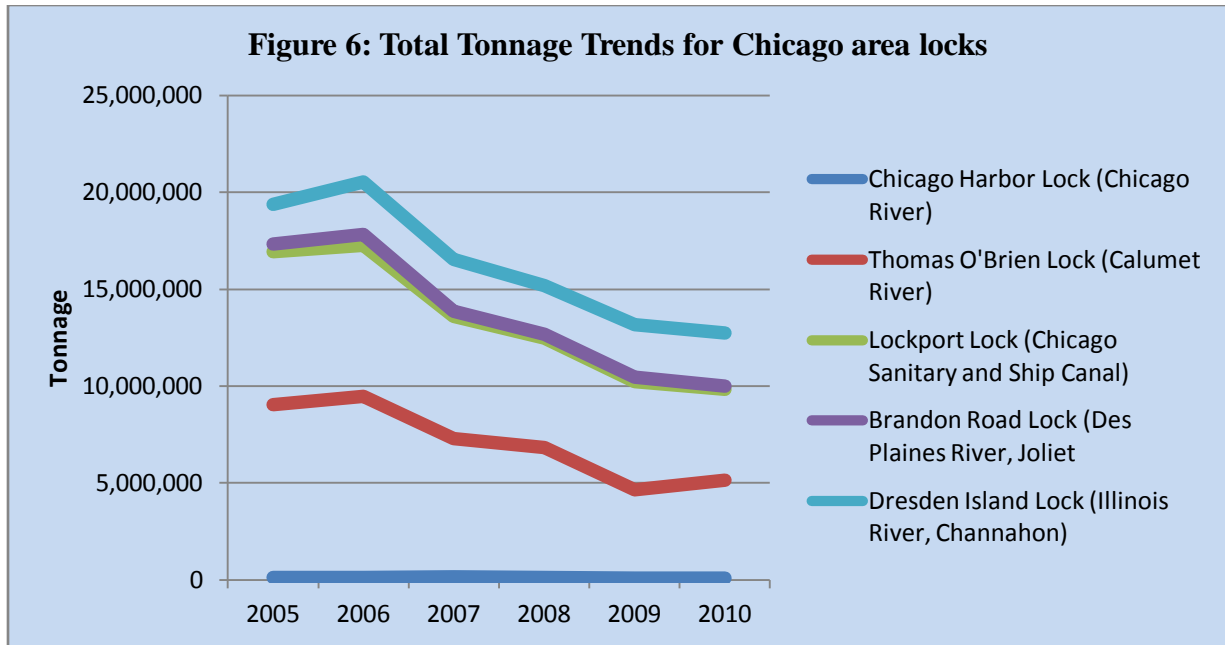

Source: Chicago Metropolitan Agency for Planning, 12/2010

**Table 4: 2009 Commodity Traffic Flows**

**Sections Included: Chicago Harbor, Chicago River, Chicago Sanitary and Ship Canal, Calumet-Sag Channel and Lake Calumet, IL, Calumet Harbor and River, IL and IN.**

2009	All Traffic Types (Domestic & Foreign)				
	All Traffic Directions	Receipts	Shipments	Inraport	Total all Traffic
All Commodities	100%	45%	33%	21%	100%
Total Crude Materials, Inedible Except Fuels	36%	68%	16%	16%	100%
Total Coal, Lignite and Coal Coke	25%	1%	48%	51%	100%
Total Petroleum and Petroleum Products	18%	36%	52%	13%	100%
Total Primary Manufactured Goods	12%	75%	22%	3%	100%
Total Chemicals and Related Products	7%	73%	23%	4%	100%
Total Food and Farm Products	2%	17%	83%	0%	100%
Total All Manufactured Equipment, Machinery	0%	98%	2%	0%	100%

## CAWS Study Baseline Transportation Conditions

---

Specific origin and destination of the goods transported on the CAWS was requested of the USACE, but not received. Instead, the USACE provided “past the point” mile point data which was useful in understanding and describing the types of commodities being transported, the vessel type, the tonnage, and the direction at various mile markers along the CAWS system. The data has been mapped and is included in Exhibit C of this memorandum.

**Table 5: Cargo Characteristics at CAWS Mile Markers**

<b>Mile Marker/ Waterway</b>	<b>Avg. Cargo in Tons (01' - 09')</b>	<b>Predominant Commodities</b>	<b>Predominant Vessel Type</b>	<b>Directional Split (upbound/downbound)</b>
<b>MP 303/ Des Plaines</b>	8m	Sand/Gravel/ – Coal & Lignite	Dry Cargo Barge	85/15
<b>MP 314/ Cal Sag</b>	7m	Petroleum Coke, Coal Coke, I&S Plates & Sheets	Dry Cargo Barge	70/30
<b>MP 324/ S. Branch Chicago River</b>	1.5m	Sand and Gravel	Dry Cargo Barge	75/25
<b>MP 325/ S. Branch Chicago River</b>	1.5m	Sand and Gravel	Dry Cargo Barge	75/25
<b>MP 327/ Calumet River</b>	13m	Coal & Lignite, Petroleum Coke	Dry Cargo Barge, *Self Propelled Dry	60/40
<b>MP 328/ Calumet River</b>	13m	Coal & Lignite, Petroleum Coke	Dry Cargo Barge, *Self Propelled Dry	60/40
<b>MP 333/ Calumet River</b>	10m	Coal & Lignite	*Self Propelled Dry	55/45

\*Includes lakers and integrated/articulated tugs

Source: USACE MP data, 2011

This data indicates the majority of barge traffic is shipping to destinations on the south CAWS or out to the Great Lakes, as expected. Limited quantities, primarily sand and gravel, are shipped on the Chicago River. Most coal that is shipped on the Chicago Sanitary and Ship Canal is headed to the Crawford and Fisk plants. There is speculation that these plants may close, which could reduce the amount of coal being shipped.

Volumes are highest on the Calumet River, past the O’Brien Lock. In all locations, upbound shipments outweigh downbound shipments, although the split becomes more equal as the CAWS approaches Lake Michigan at Calumet Harbor. The Calumet River is the only inland waterway on the CAWS with a deep draft that can accommodate laker vessels, and they likely deliver cargo on the inbound trip and receive cargo for the outbound trip. Much of the cargo transported on the Calumet River is coal and petroleum coke, which is either offloaded to barge facilities on the River, transferred to laker vessels, or carried through to the ports in Indiana or other Great Lakes

# CAWS Study Baseline Transportation Conditions

---

destinations. Some barge operators have indicated that their vessels never leave the CAWS system.

It is noted that the Panama Canal will be expanded by the year 2015, and is included in the “baseline condition.” With this expansion will come the opportunity for additional container cargo to reach the U.S. The container-on-barge market is not currently served by the CAWS; however, the opportunity for this new market sector is possible. More information on this potential opportunity is included in the Transportation Market Assessment and the Cost-Benefit Analysis prepared for this study.

## **2. COMMERCIAL TOURS AND WATER TAXIS**

There are currently five (5) commercial tour operators and water taxis operating along the Chicago shoreline and river. On a daily basis, these five operators together run a total of twenty-four (24) tours on the river/lake, thirty (30) tours on the river only and nine (9) tours on the lake only. The tour boats generally travel through the Chicago River Main Branch and a short way up the North and South Branches. Some use the Chicago Lock to enter Lake Michigan, and, as indicated in Section IIA, the number of commercial passengers has been increasing. One company in particular also runs twenty-eight (28) eastbound and twenty-eight (28) westbound water taxis each day. The water taxis tend to run between Union Station, Michigan Avenue and Navy Pier.

## **3. RECREATIONAL**

Recreational boating is largely the activity of local residents in the greater Chicago area. The majority of the recreational, as well as commercial tour traffic occurs during the time between May and October. In 2010, over 23,000 recreational boats passed through the Chicago Lock, and over 12,000 through the O’Brien Lock. Human-powered craft, canoes, kayaks, and sculls, almost exclusively remain within the river system. The Chaddick Institute report estimates that 2,550 boats pass through the locks every spring and summer to gain access to boat slips and other mooring facilities on Lake Michigan, primarily harbors managed by the Chicago Park District. This represents 45% of the approximate 5,600 boats that moor in Lake Michigan harbors. Other boats are permanently moored or stored downstream from the locks at the marinas mentioned previously, but make regular or occasional trips to Lake Michigan. Of these, an estimated 500 are moored during the summer season in marinas that are downstream of the locks. The remaining 55% of boats moored on Chicago’s harbors tend to be pulled from the water at lakeside boat ramps or brought to marinas or boat ramps in Indiana or southern Wisconsin. These boats do not travel through the locks to access the lake. Recreational boating is largely the activity of local residents in the greater Chicago area. The majority of harbors and marinas are on Lake Michigan and the Calumet River.

In September 2011, Chicago Mayor Emanuel announced that the City would be developing four boathouses on the Chicago River, in an effort to improve recreational opportunities along the river. The boathouse sites were chosen to line up with improvements the Chicago Department of Transportation is making to extend trails along the river, providing easier and more consistent river access for runners, bikers, and walkers. The boathouses, constructed through a mix of private donations and Chicago Park District funds, will each contain a concession facility and will serve both as access points and attractions along the river.



# CAWS Study Baseline Transportation Conditions

---

The four boathouses will be located at the following locations:

- River Park Boat House, 5100 N. Francisco—The site of the future boat house is at Argyle and the river.
- Clark Park Boat House, 3400 N. Rockwell—The site of the future boat house is at Roscoe and Rockwell, east of the river.
- Ping Tom Memorial Park Boat House, 300 W. 19th Street—The site of the future boat house is north of 18th street, through the under-bridge connection, west of the St. Charles line railroad tracks.
- 28th & Eleanor Boat House—The site of the future boat house is between Loomis and Fuller Streets on Eleanor, across the river from Ashland Avenue.

### **III. ROADWAYS**

#### **A. EXISTING ROADWAYS**

The largest mode share for freight travel in the Chicago area is trucking. A number of interstates and arterials parallel or cross the CAWS, as shown in Exhibit B. A complete listing of these roadways and some of the roadway characteristics has been compiled for the study team, including average daily traffic volumes and truck volumes. Major interstates in the CAWS study area include:

- Interstate 90/94, which parallels the Chicago River and provides connections to Indiana and Wisconsin. It also crosses the Cal Sag Channel and the Little Calumet River.
- Interstate 55, which parallels the Chicago Sanitary and Ship Canal and the Des Plaines River, and provides connection to southern Illinois and St. Louis.
- Interstates 294 and 57, which cross the Cal Sag Channel. I-294, the Tri-State Tollway, travels to Wisconsin and Indiana. I-57 travels south towards Kankakee and Champaign, Illinois. A new interchange of these interstates is proposed as part of the region’s *Go To 2040* Long Range Transportation Plan.
- Interstate 355, which crosses the Des Plaines River. I-355 connects to I-290 on the north and I-80 on the south, ultimately providing connections to Wisconsin, Iowa and Indiana.

#### **B. PROGRAMMED ROADWAY IMPROVEMENTS**

There are a number of programmed improvements to roadways that are adjacent to, or cross the CAWS system. The 2010-2015 Transportation Improvement Program for northeastern Illinois (TIP) was consulted to determine such improvements. A list of 2010-2015 programmed roadway projects that have the potential to impact the CAWS system has been assembled.

#### **C. LONG RANGE REGIONAL PROJECTS**

The CMAP *Go To 2040* long range transportation plan indicates six major regional projects that increase the capacity of the interstate system, reducing congestion and travel times for freight travel. Collectively, these improvements will influence the pattern of truck traffic within the region. The new interchange at Interstates 294 and 57 are adjacent to the Little Calumet River and Cal Sag Channel (see Exhibit B). There may be new opportunities to enhance the connection between the CAWS and the interstate in this location.

<b>CMAP <i>Go To 2040</i> Regional Projects</b>		
<b><i>Project</i></b>	<b><i>Location</i></b>	<b><i>Description of Proposed Work</i></b>
Central Lake County Corridor: IL 53 North and IL 120 Limited	IL 53 at Lake Cook Road to Central Lake	Extension of IL Rte 53 north from its current terminus at Lake-Cook Road to Central Lake County. Includes dual terminus with I-90 to the

## CAWS Study Baseline Transportation Conditions

Access	County	
Elgin O'Hare expressway and West O'Hare Bypass Improvements	Elk Grove Village and surrounding communities.	east and IL 120 at Wilson Road to the west. -A new western expressway bypass of O'Hare airport -An extension of the Elgin O'Hare Expressway from I-290/IL 53 to the Western O'Hare bypass and West O'Hare Terminal - Addition of a single lane in each direction on the existing Elgin O'Hare expressway.
I-294/I-57 Interchange (Adjacent to Little Calumet River and Calumet Sag Channel)	I-294 at I-57 (Markham IL)	Full Interchange at the junction of I-294 and I-57 for improved north-south regional travel. Improvements will also be made to connecting arterials at the new interchange.
I-80 Add Lanes	I-80 between US 30 east and US 45.	Additional of two lanes (one each direction) on I-80 from US 30 east to US 45 to serve traffic utilizing I-355 north and east-west cross-county traffic.
I-88 Add Lanes	I-88 ( IL 56 – Orchard Road)	Two (one each direction) lanes are proposed from IL 56 east to Orchard Road along I-88.
I-94 Add Lanes North	I-94 (IL 173 to the Wisconsin Border)	Two additional lanes (one each direction) proposed for I-94 in northern Lake County from IL 173 to the Wisconsin border.

Another project of note is the Illiana Expressway, which is a proposed east-west thoroughfare connecting northeast Illinois and northwest Indiana through Will County. The facility will link I-57 in Illinois with I-65 in Indiana, and is 25 – 30 miles long. The Illiana expressway project is not included in the fiscally-unconstrained priority list of the CMAP Go To 2040 plan but continues to experience regional support for development. However, the project is listed on NIRPCs (Northwestern Indiana Regional Planning Commission) Connections 2030 Regional Transportation Plan.

#### **IV. RAILROADS**

##### **A. EXISTING RAILROAD SYSTEM**

Chicago is also the only metropolitan area in which six of the nation's seven Class I railroads have major terminals. Nearly 500 freight trains per day operate in the Chicago region. In 2007, regional rail tonnage was estimated at more than 631 million tons, with about 24,000 trailers and containers and about 16,800 carload units moving into, out of, or through the region daily. A number of railroads parallel or cross the CAWS and several intermodal facilities are present, as shown in Exhibit B. A complete listing of the rail crossings, adjacent railroads, and intermodal yards and other rail yards has been compiled for the study team. The listing indicates the owner railroad, other railroads with operating rights, and the waterbody that it crosses. Each of the Class I's that operate in the Chicago area have invested heavily in capital to meet increasing demands, as described below.

##### *BNSF Railway (BNSF)*

Owned by Berkshire Hathaway, the Burlington Northern Santa Fe serves areas from the US and Canadian Pacific Coasts to Chicago and the Gulf Coast. Some major facilities in the study area include the Cicero, Corwith, Logistics Park Chicago, Western Avenue Yard, and Willow Springs terminals. BNSF continues to invest heavily in maintaining and renewing its network to provide

---

## CAWS Study Baseline Transportation Conditions

---

safety and reliability. The Company's capital expenditures for the 2010 were \$2.5 billion compared to \$2.4 billion in 2009. Capital commitments, which include amounts spent on leased assets, are forecasted to be \$3.5 billion. - "BNSF – Financial Information Performance summary" Web 07 Apr. 2011 <http://www.bnsf.com/about-bnsf/financial-information/>

### *Canadian National (CN)*

Services for the CN extend from the east and west coasts of Canada, through central US, south to the Gulf Coast. Major CN facilities in the study area include Glenn Yard, Markham Yard, Gateway intermodal terminal, and the former EJE facilities. CN invests proportionately more than any other North American Class 1 railroad in capital programs. A significant portion of capital investment is targeted on track infrastructure for safety, productivity and fluidity of the network. \$1.5 billion (Canadian) in capital programs were planned for 2010, of which more than \$1 billion (Canadian) was earmarked for track infrastructure. "CN – Quarterly Releases and Dividends." Web 07 Apr. 2011 <http://www.cn.ca/en/investors-financial-quarterly-releases-dividends-2010.htm>

### *CSX Transportation (CSXT)*

Services extend across the eastern United States from Quebec to Florida and west to the Mississippi River. Major facilities in the study area include Barr Yard, 59th Street, and Bedford Park intermodal terminals. The Company's surface transportation capital budget was forecasted to be nearly \$5 billion between 2008 and 2010. Approximately 60% of the company's capital is targeted for infrastructure investment.

-CSXT – Financial Reports and Filings." Web. 07 Apr. 2011

<http://investors.csx.com/phoenix.zhtml?c=92932&p=iro-l-reportsannual>

### *CP Rail System (CPRS)*

CPRS maintains services in Canada extending from Vancouver to Quebec, and U.S. service in the upper Midwest and the Middle Atlantic states. Major facilities in the study area include the Bensenville Yard and Schiller Park intermodal terminals. The company's capital expenditures were \$1.0 billion in 2008.

- "CPRS Investor Relations." Web. 07 Apr. 2011

<http://www8.cpr.ca/cms/English/Investors/Financial/Annual+Report.htm>

### *Norfolk Southern (NS)*

Services extend from Kansas City and Chicago to the Middle Atlantic States, south to the Gulf Coast, New England and Dallas. Major facilities include 47th St., 63rd St., Calumet, and Landers intermodal terminals. The company's capital expenditures were \$1.47 billion in 2010.

- Norfolk Southern, Annual Financial Report." Web. 08 Apr. 2011

[http://www.nscorp.com/nscportal/nscorp/Investors/Financial\\_Reports/Annual%20Report/](http://www.nscorp.com/nscportal/nscorp/Investors/Financial_Reports/Annual%20Report/)

### *Union Pacific Railroad (UPRR)*

Services extend from the Pacific Coast to the Midwest and the Gulf Coast. Major UPRR facilities in the study area include the Global I, Global II, Joliet (Global IV) and Yard Center intermodal terminals. UP capital expenditures totaled \$3.1 billion in 2007. - "UP: Annual Reports and Proxy Statements." Union Pacific. Web. 08 Apr. 2011. <http://www.up.com/investors/annuals/index.shtml>

### *Intermodal Centers*

The UPRR runs parallel to the Des Plaines River, as does the BNSF. At Joliet, the CSX and CN join as well. The former Joliet Arsenal property has been developed into two intermodal facilities. The CenterPoint Intermodal Center-Joliet ("CIC-Joliet") is the largest master-planned inland port in North America. It is adjacent to the I-55/I-80 interchange and is anchored by Union Pacific-Joliet Intermodal Terminal. It is near the Des Plaines River but is not connected to it. The

# CAWS Study Baseline Transportation Conditions

---

CenterPoint Intermodal Center-Ellwood is located approximately 2 miles to the south, and is anchored by the BNSF Logistics Park.

Logistics Park Calumet North spans from the Calumet River to the North, Lincoln Highway (Route 30) to the south, the Illinois-Indiana state line to the east, and the Will-Cook County line to the west. The CN Intermodal Terminal in Harvey, UP Intermodal Terminal in Dolton, Indiana Harbor Belt Terminal in Riverdale, CSX Intermodal Terminal in Riverdale, and the IAIS Intermodal Terminal in Blue Island are all located here. These assets are linked together by an extensive expressway network, which will be enhanced with the construction of the I-294/I-57 interchange. While these facilities are in close proximity to the Little Calumet River and Cal Sag Channel, they are mostly separated from the rivers by forest preserve and open space that lines the riverfront. Therefore, there is currently limited direct interface between barge, rail, and trucking in this area.

Other railroads in the study area include the Belt Railway Company (BRC), the Indiana Harbor Belt (IHB), and the Chicago Rail Link (CRL). These railroads provide vital connections and links between the terminals and ports in Illinois and Indiana, as well as with Class I Railroads. Major facilities in the study area include the BRC South Chicago Yard, the IHB Blue Island Yard, and the CRL South Deering Yard.

## **B. FUTURE RAILROAD IMPROVEMENTS**

Although the Chicago rail system is one of the most extensive in the nation, the Chicago area freight rail traffic suffers from congestion, low operating speeds and delays due to traffic demands that exceed the capacity of the Chicago Rail System. To address these issues, the Chicago Region Environmental and Transportation Efficiency (CREATE) Program was established in 2005. CREATE is the first of its kind partnership between all of the Class I Railroads; the federal government; the State of Illinois; Metra; Amtrak; and the City of Chicago. The overall goals of the CREATE Program are to improve freight and passenger rail operations, and to improve highway operations in the Chicago metropolitan area while reducing the environmental impacts of rail operations on the general public. The CREATE Program includes the development of four freight and passenger rail transportation corridors in the Chicago metropolitan area, and also includes rail-highway grade separation projects (over- or under-passes to grade-separate railroads and highways) on existing rail lines.

The development of the four rail corridors includes the upgrading of existing track structure, the double-tracking or triple-tracking of certain lines, the construction of rail-highway grade separations and rail-rail flyovers, the installation of new or improved signaling, and various other additions and improvements. These improvements will significantly improve freight and passenger rail operations. Progress has been made to secure initial funding for this program and a small number of the projects have been complete. The CREATE program improvements are shown in Exhibits B and D.

In addition to the CREATE improvements, the State of Illinois and UPRR are improving trackage between St. Louis and Chicago to facilitate high speed passenger rail. These improvements will include an additional mainline track as well as signal and crossing improvements, which will increase freight capacity and operations on this line.

# CAWS Study Baseline Transportation Conditions

## V. LAND USE PLANNING

Inherent in any transportation improvement is the need to be consistent with the land use planning goals of the community and region. The Chicago area is a rich mixture of land use types, and the areas adjacent to the CAWS are no exception. All along the system, industrial, open space, residential, and commercial land uses co-exist. The State of Illinois, the City of Chicago, and the southern suburbs have developed plans that enhance the economic and open space opportunities along the waterway. The barrier location alternatives developed as part of this project recognize the framework provided by these plans.

### *Industrial Retention*

Recognizing the value of Chicago's industrial areas, the City of Chicago established Industrial Corridors in the 1990s to focus its industrial retention efforts. The Calumet River Corridor is one such corridor. The Calumet Corridor is heavily-industrialized, and contains almost 60% of the land in Chicago that is available for industry. At the same time, there is a great amount of existing rail in the Calumet Area, making it North America's largest center for intermodal freight shipping.

Since at least 2002, Chicago and the south suburbs have been developing plans retain and enhance existing businesses and industries within the Calumet area, and attract new industrial and business development, creating new job opportunities. The *Calumet Area Land Use Plan* was developed by the City of Chicago, as was the establishment of a Tax Increment Financing (TIF) district for the Calumet area.

**Figure 7: Calumet Area Land Use Map**

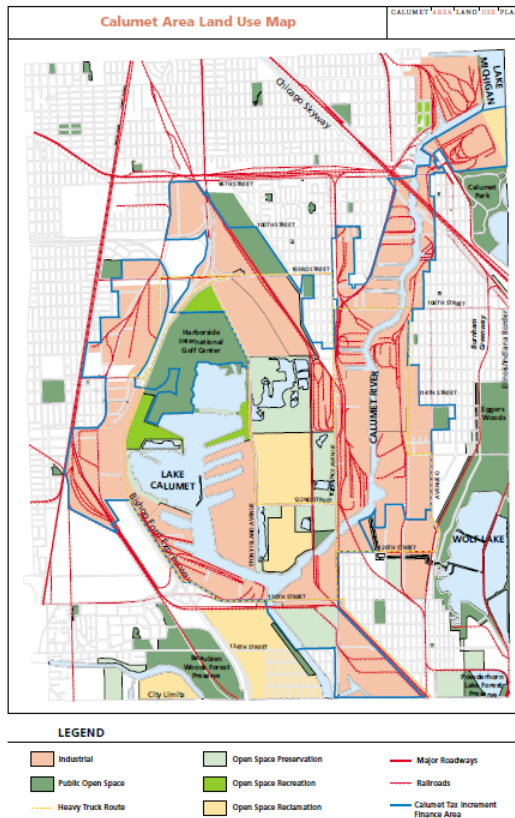



## CAWS Study Baseline Transportation Conditions

Currently, the *Chicago Sustainable Industries Plan* is being developed by Chicago to further retain the manufacturing base and enhance the industrial nature of the corridors. Phase 1, released in March 2011, describes the corridors for protection. The Calumet Corridor is one such corridor, and includes Planned Manufacturing Districts (PMDs). Over 71% of the Calumet Corridor is within a PMD. The corridor contains 4,200 acres of land, with 67 businesses providing nearly 4,900 jobs. The Calumet Area Industrial Council Local Industrial Retention Initiative (LIRI) was also developed to interact with area companies to retain or expand those companies within the city.

**Figure 8: Calumet Industrial Corridor**

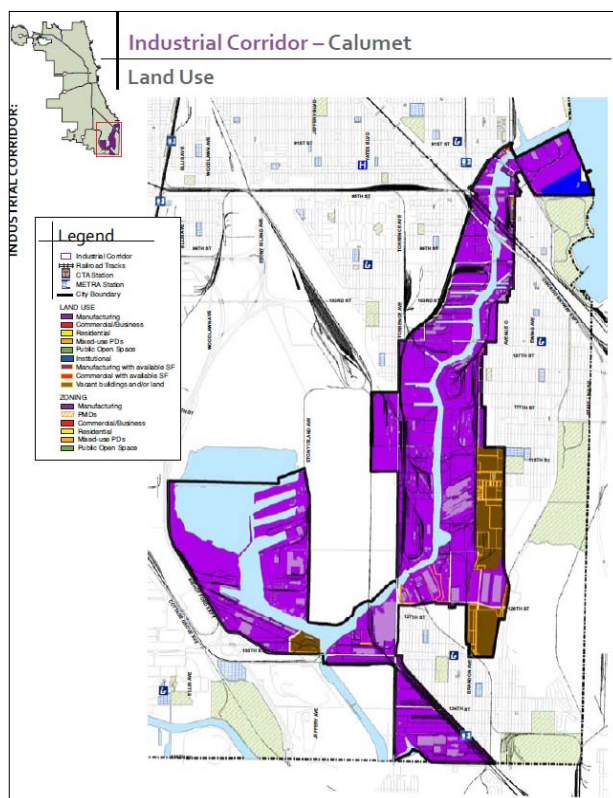

In 2007, the Chicago Southland Economic Development Corporation developed the *Calumet River Corridor Economic Development Vision and Strategy*. The purpose of this program is to create a framework for development and investment in the seven south suburban communities that comprise the Calumet River Corridor, including Robbins, Blue Island, Calumet Park, Riverdale, Dolton, Calumet City, and Burnham. The project focused on the Calumet River system as an important environmental amenity and economic asset. It highlights the fact that there is already direct access to all major modes of transportation, including interstate highways, rail freight lines, inter-modal freight yards, waterways connecting Lake Michigan and the Mississippi River, international airports, multiple regional commuter rail lines, and various domestic and commercial markets.

The South Suburban Mayors and Managers Association developed the *Lake Riverdale Sustainable Master Plan* in 2010. This plan outlines strategies and ideas for promoting industrial redevelopment and open space opportunities in the south suburbs that reside near the Little Calumet River and the Cal Sag Channel. The plan emphasizes its unique location with regards to transportation, including water. While many of the properties adjacent to the water are proposed



## CAWS Study Baseline Transportation Conditions

for open space enhancement and residential development, there is one property currently owned by Arcelor Mittal that is targeted for waterside industrial redevelopment, to take advantage of existing channel side docking facility.

**Figure 9: Lake Riverdale Proposed Development Areas**

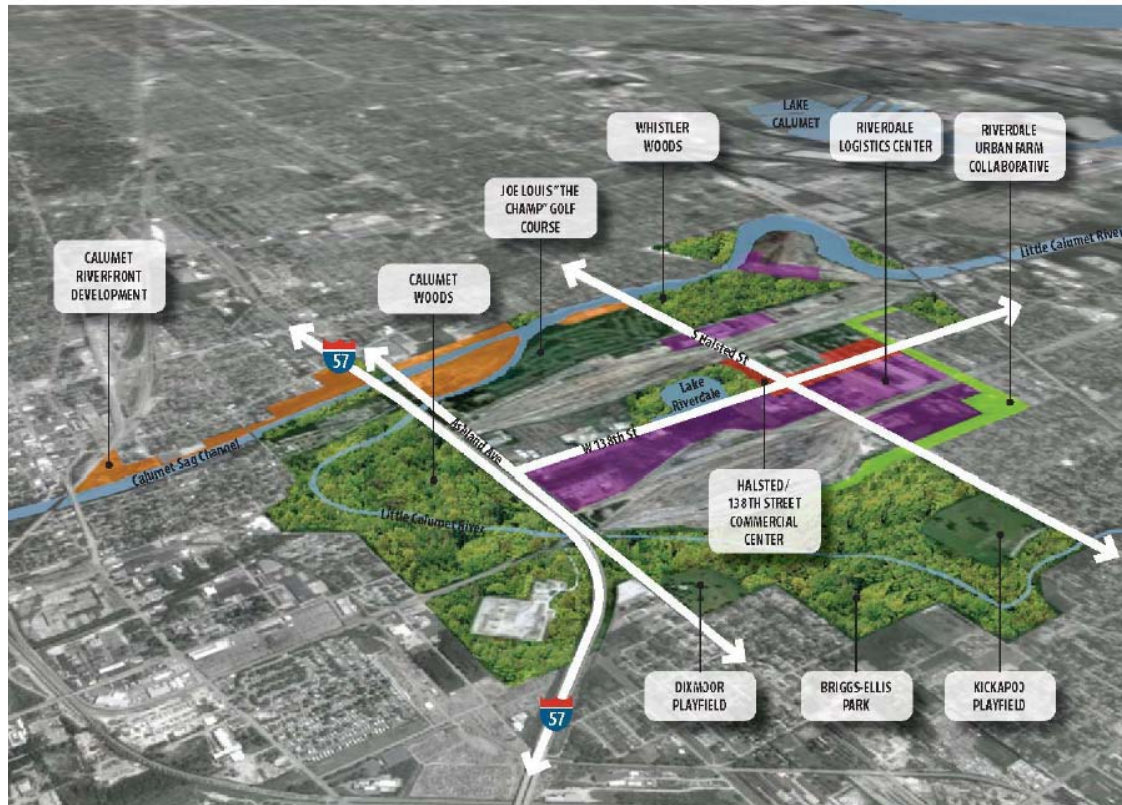

▲ Lake Riverdale Proposed Development Areas

### *Open Space and Recreation Preservation*

The industrial land in the Calumet area exists side-by-side with Chicago's most important wetlands and natural habitats, and the aforementioned plans recognize the need to protect these resources. Implementation of the various plans has now taken shape as *Millennium Reserve*, the largest open space project in the country, which will ultimately provide public recreation opportunities in 140,000 acres of land in the Calumet region. In late December 2011, Illinois Governor Pat Quinn announced the restoration of 15,000 acres of open space in the Calumet Core Reserve to start the project, dedicating \$18 million from the Illinois Jobs Now! capital program. Illinois is also partnering with the city of Chicago, the Chicago Park District, the Forest Preserve District of Cook County and other groups on a number of projects to restore and conserve the Calumet area's natural resources, which will collectively help form the Millennium Reserve. The program has gained recent acknowledgement as part of the federal America's Great Outdoors (AGO) program. The State of Illinois Department of Natural Resources also recognizes that these natural areas are of statewide significance, and home to some threatened and endangered species.

The State of Illinois believes that the *Millennium Reserve* will be a catalyst to promote economic growth in the area. Specifically, it is envisioned that the *Millennium Reserve* will improve the economy by:

# CAWS Study Baseline Transportation Conditions

- Modernizing the Illinois International Port District
- Creating a destination region for tourists and visitors
- Increasing property values for home owners near the Reserve

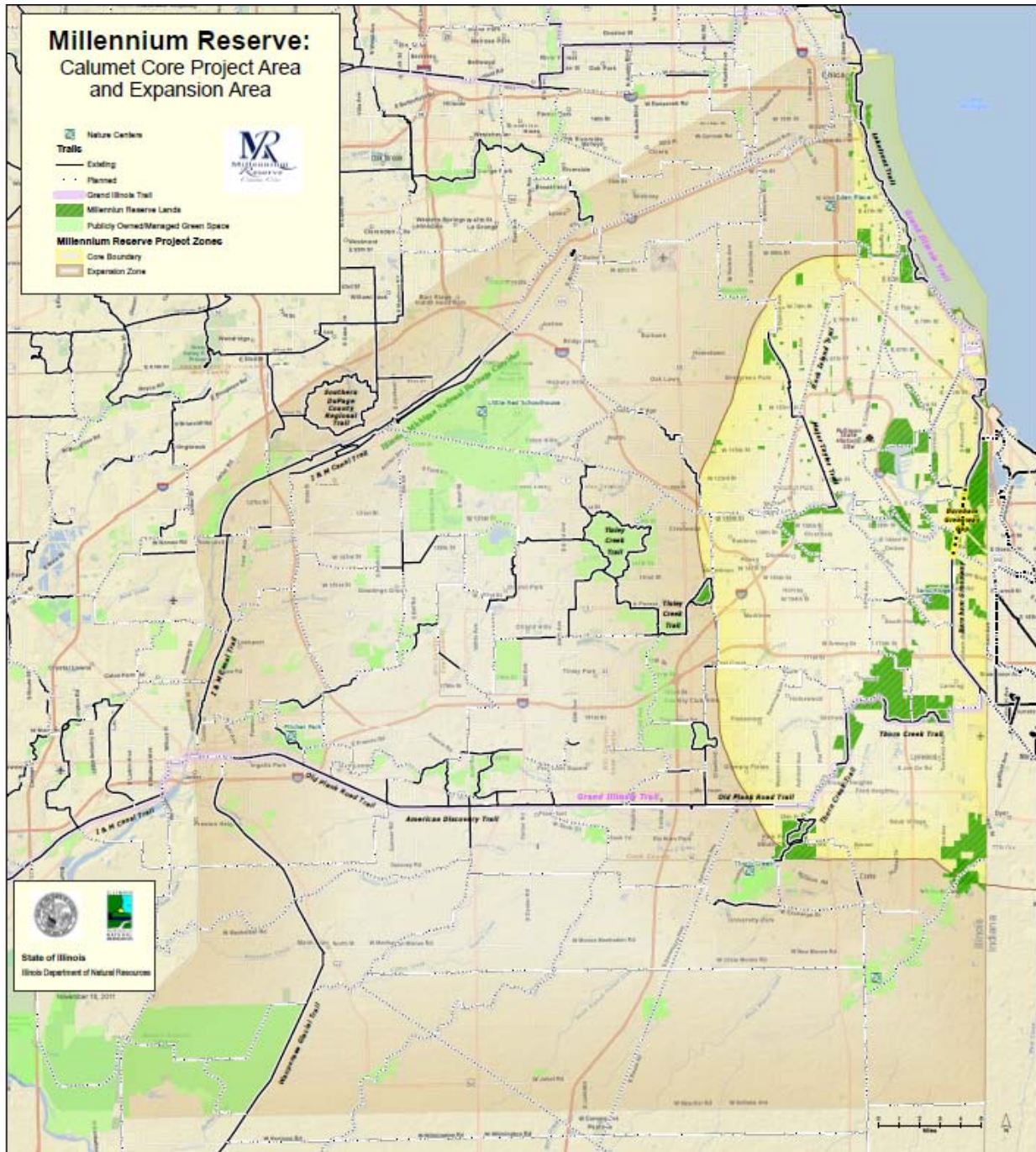



Exhibit A  
 USACOE Navigation Chart and appendix page (example; note, not to scale)

US ARMY CORPS OF ENGINEERS ILLINOIS WATERWAY MILE 330.9 TO 333.5



1998

- 1) The legend is located immediately preceding map No. 1
- 2) Barge Facility information and submerged cable and pipeline clearances are located in appendices A and B respectively.



MAP REVISED MARCH 1999  
 REF. NAV NOTICE IW99-04

MAP NO. 142

NUMBER	CHART#	WATERWAY	LOCATION	BARGE FACILITY NAME	TYPE OF SERVICE
310	142	Calumet River	Mile 331.0 west bank Calumet River 1200 feet north of East 106th Street Bridge and outer portion north side of Slip No. 4 Chicago.	Holly Marine Towing 104th Street Slip Mooring.	Mooring tugboats towboats and floating equipment; mooring barges for fleetting and minor repairs.
311	142	Calumet River	Mile 331.0 west bank Calumet River inner portion of north side of Slip No. 4 Chicago.	General Mills Rialto Grain Elevator Wharf.	Receipt and shipment of grain; mooring barges for fleetting.
312	142	Calumet River	Mile 331.1 west bank Calumet River on north side of Slip No. 3 approximately 1700 feet north of East 106th Street Bridge Chicago.	Steelmet Slip No. 3 Wharf.	Receipt and occasional shipment of miscellaneous dry bulk commodities by barge including scrap metal; occasional shipment of stone by barge.
313	142	Calumet River	Mile 331.1 east bank Calumet River approximately 1100 feet north of East 106th Street Bridge Chicago.	Marblehead Lime Co. North Wharf.	Receipt of limestone by self-unloading vessels and shipment of lime products by barge.
314	142	Calumet River	Mile 331.1 west bank Calumet River on south side of Slip No. 3 approximately 1600 feet north of East 106th Street Bridge Chicago.	Beelman River Terminals Inc. Wharf.	Mooring company-owned barges; mooring barges for cleaning and minor repairs.
315	142	Calumet River	Mile 331.3 west bank Calumet River between south side of East 100th Street Bridge and entrance to Slip No. 2 Chicago.	KCBX Terminals Co. Loading Wharf.	Shipment of miscellaneous dry bulk commodities including coal petroleum coke bauxite fertilizer and bentonite clay.
316	142	Calumet River	Mile 331.3 east bank Calumet River approximately 1400 feet south of East 100th Street Bridge Chicago.	S.H. Bell Co. Chicago Terminal Barge Wharves.	Receipt and occasional shipment of semi-finished steel products and ferroalloys pig iron fluorspar fertilizer and bulk refractory materials including aluminum compounds and chrome ores all by barge
317	142	Calumet River	Mile 331.3 west bank Calumet River Slip No. 2 Chicago.	KCBX Terminals Co. Barge Unloading Slip.	Receipt of miscellaneous dry bulk commodities by barge including coal petroleum coke and bauxite; mooring Co.-owned towboat; and mooring barges.
318	142	Calumet River	Mile 331.4 east bank Calumet River approximately 1000 feet south of East 100 <sup>th</sup> Street Bridge south side of slip Chicago.	S.H. Bell Co. Chicago Terminal North Slip.	Receipt of semi-finished steel products and miscellaneous dry bulk commodities by barge; mooring barges for fleetting.
319	142	Calumet River	Mile 331.4 east bank Calumet River approximately 1300 feet south of East 100 <sup>th</sup> Street Bridge Chicago.	S.H. Bell Co. Chicago Terminal South Slip.	Receipt and shipment of semi-finished steel products and miscellaneous dry bulk commodities by barge; mooring barges for fleetting.
320	142	Calumet River	Mile 331.5 east bank Calumet River north side of slip and river side south of East 100 <sup>th</sup> Street Bridge Chicago.	Morton Salt Calumet River Wharf.	Receipt of salt by self-unloading vessels; transient mooring of barges.
321	142	Calumet River	Mile 331.9 east bank Calumet River north of Chicago Skyway Bridge Chicago.	Kindra Lake Towing Slip.	Mooring company-owned barges towboat and tugboats; mooring barges for fleetting.
322	142	Calumet River	Mile 332.0 west bank Calumet River between Consolidated Rail Corp. and Chicago Skyway Bridges Chicago.	Metal Management Inc. Calumet River Wharf.	Receipt and occasional shipment of steel and miscellaneous dry bulk commodities by barge including salt and sand; mooring barges and small vessels for repair; mooring company-owned equipment.





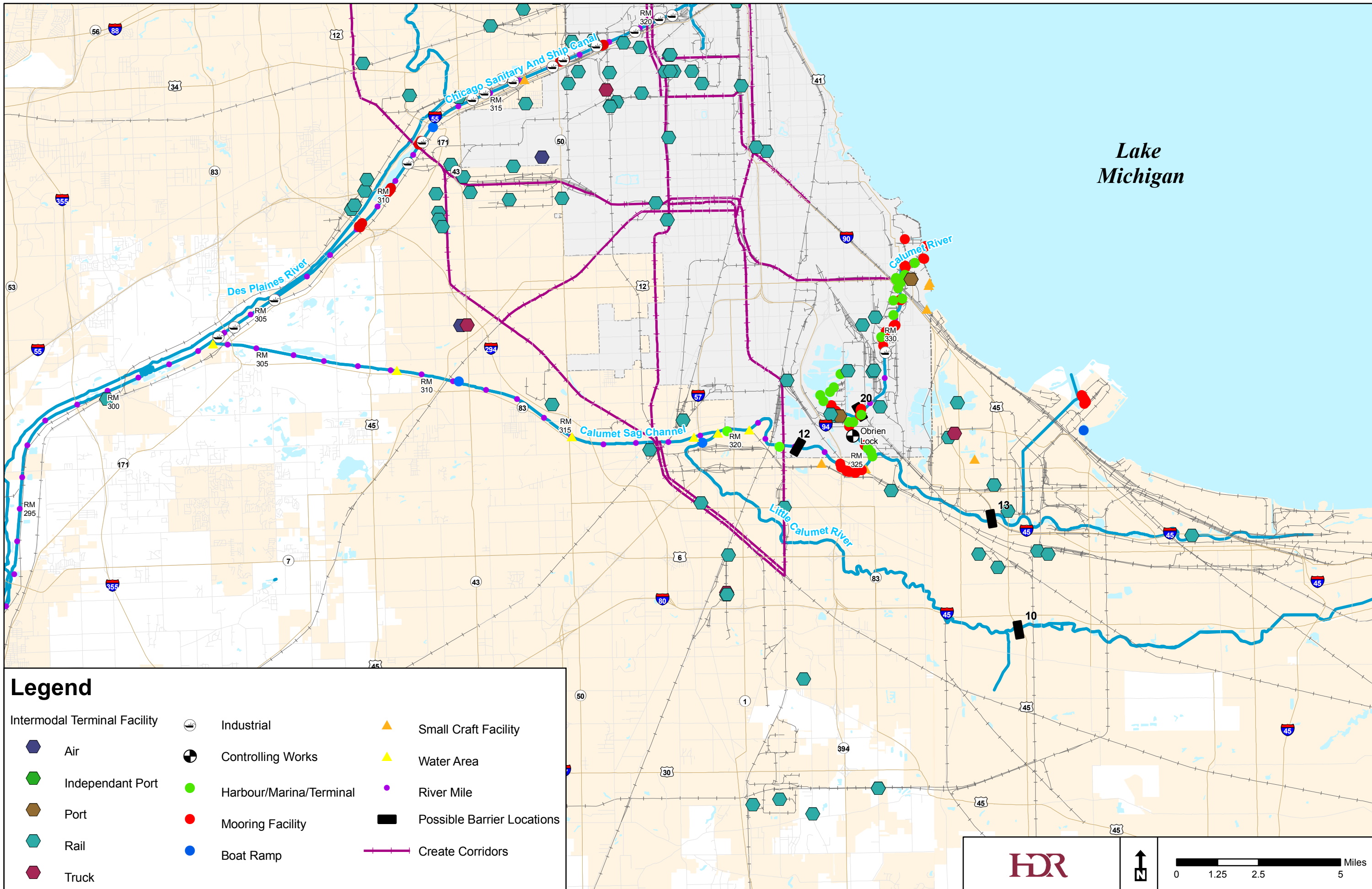

### Legend

- |                              |                  |            |                         |                      |                            |
|------------------------------|------------------|------------|-------------------------|----------------------|----------------------------|
| Intermodal Terminal Facility |                  | Industrial |                         | Small Craft Facility |                            |
|                              | Air              |            | Controlling Works       |                      | Water Area                 |
|                              | Independent Port |            | Harbour/Marina/Terminal |                      | River Mile                 |
|                              | Port             |            | Mooring Facility        |                      | Possible Barrier Locations |
|                              | Rail             |            | Boat Ramp               |                      | Create Corridors           |
|                              | Truck            |            |                         |                      |                            |

Source: Intermodal Facilities - RITA/BTS, Harbour/Marinas, Mooring Facilities, Boat Ramp, Small Craft Facilities, Water Area - USACE/NOAA, River Mile - USACE/HDR, Industrial Facilities, Controlling Works, Create Corridors - HDR

Lake Michigan

HDR

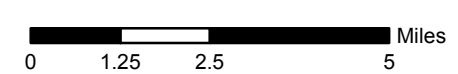





Draft Transportation Facilities: Lower CAWS



# Exhibit C: 2008 Waterborne Commerce on the Illinois Waterway and the Port of Chicago Flow of Commerce in Tons

## Legend:

-  Analysis Termini
- Waterborne Commerce, 2008. Arrow Width Proportional to Flow Volume (annual flows less than 100,000 tons are not depicted):
-  Green: Internal Downbound Commerce;
-  Blue: Internal Upbound Commerce;
-  Purple: International or Lakewise Commerce;

## Freight Traffic, 2008, Port of Chicago (short tons):

Coal:	5,249,000
Chemicals and Related Products:	4,043,000
Crude Materials – Inedible – Except Fuels:	8,538,000
Primary Manufactured Goods:	3,046,000
Food and Farm Products:	272,000
Manufactured Equipment, Machinery, and Products:	21,000
Unknown or Not Otherwise Classified:	22,000
<b>Total:</b>	<b>21,191,000</b>

Port of Chicago Includes Chicago River, Chicago Sanitary and Ship Canal, Calumet-Sag Channel, Lake Calumet, Calumet River and Calumet Harbor

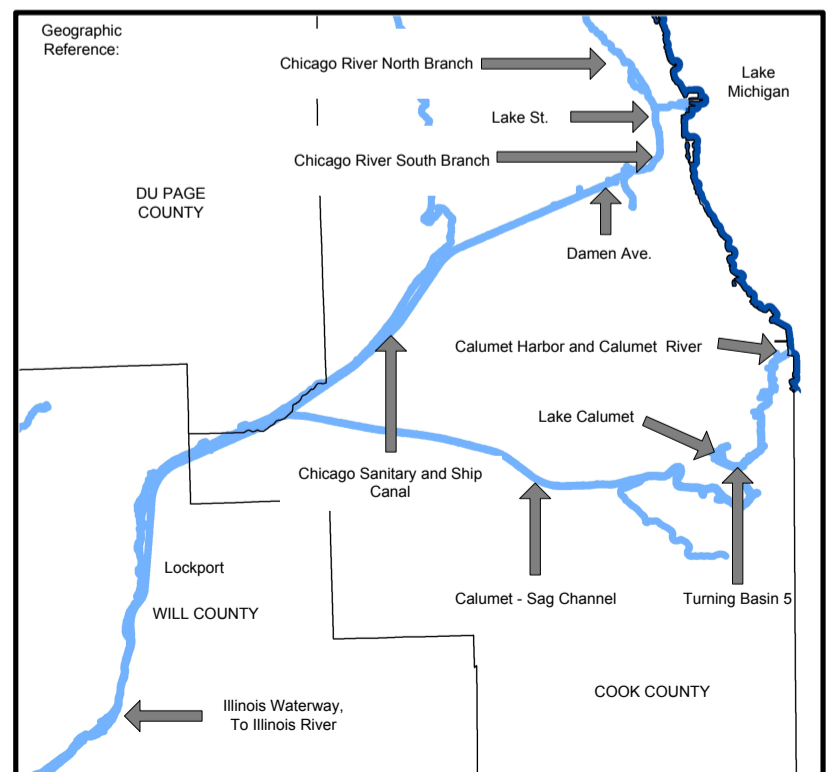
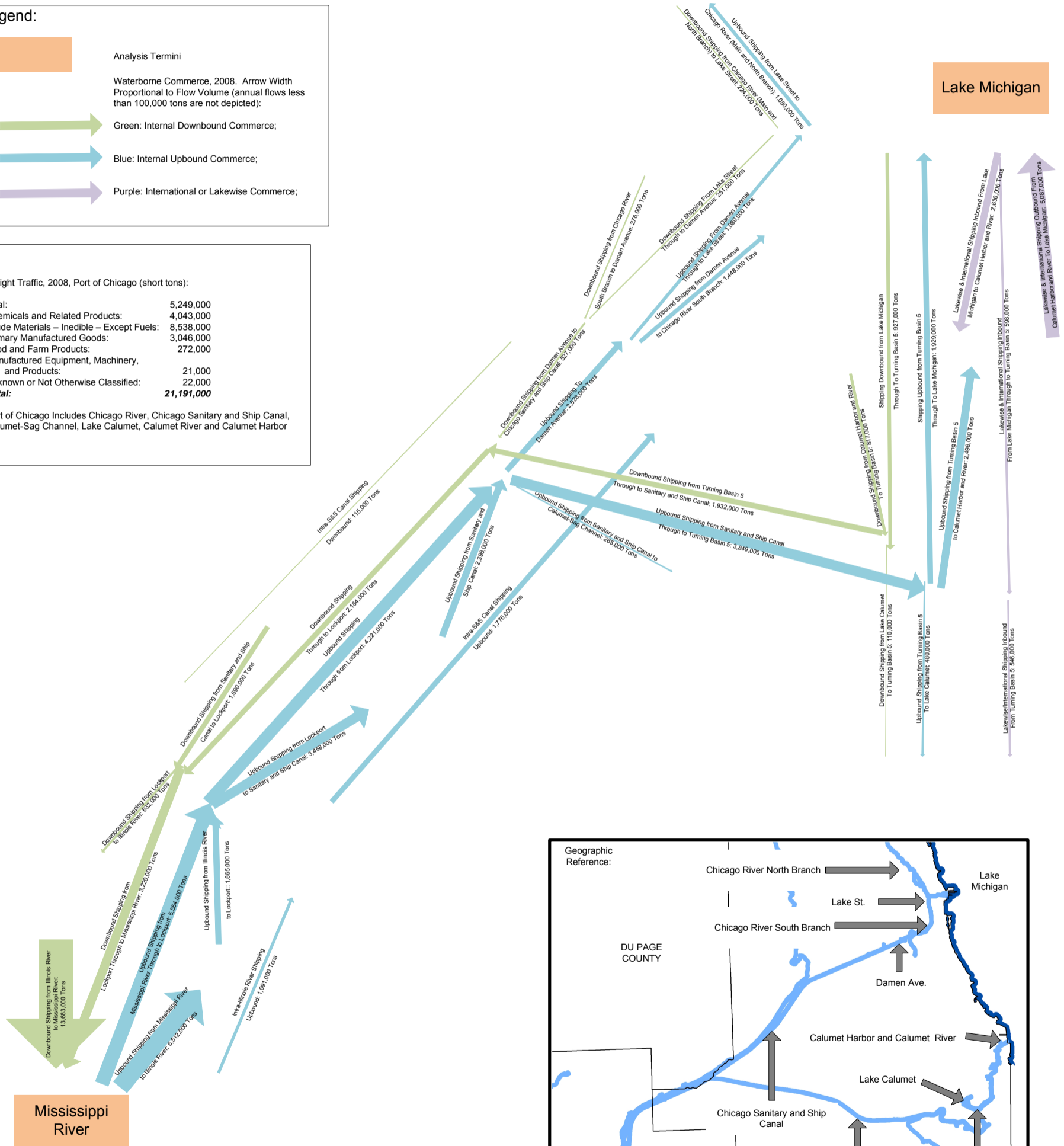

Data Source: U.S. Army Corps of Engineers, Waterborne Commerce of the United States, 2008. <http://www.iwr.usace.army.mil/ndc/data/datawvus.htm>

Prepared by Congestion Management Program  
Chicago Metropolitan Agency for Planning  
December, 2010





# Status of CREATE Projects (2/4/11)

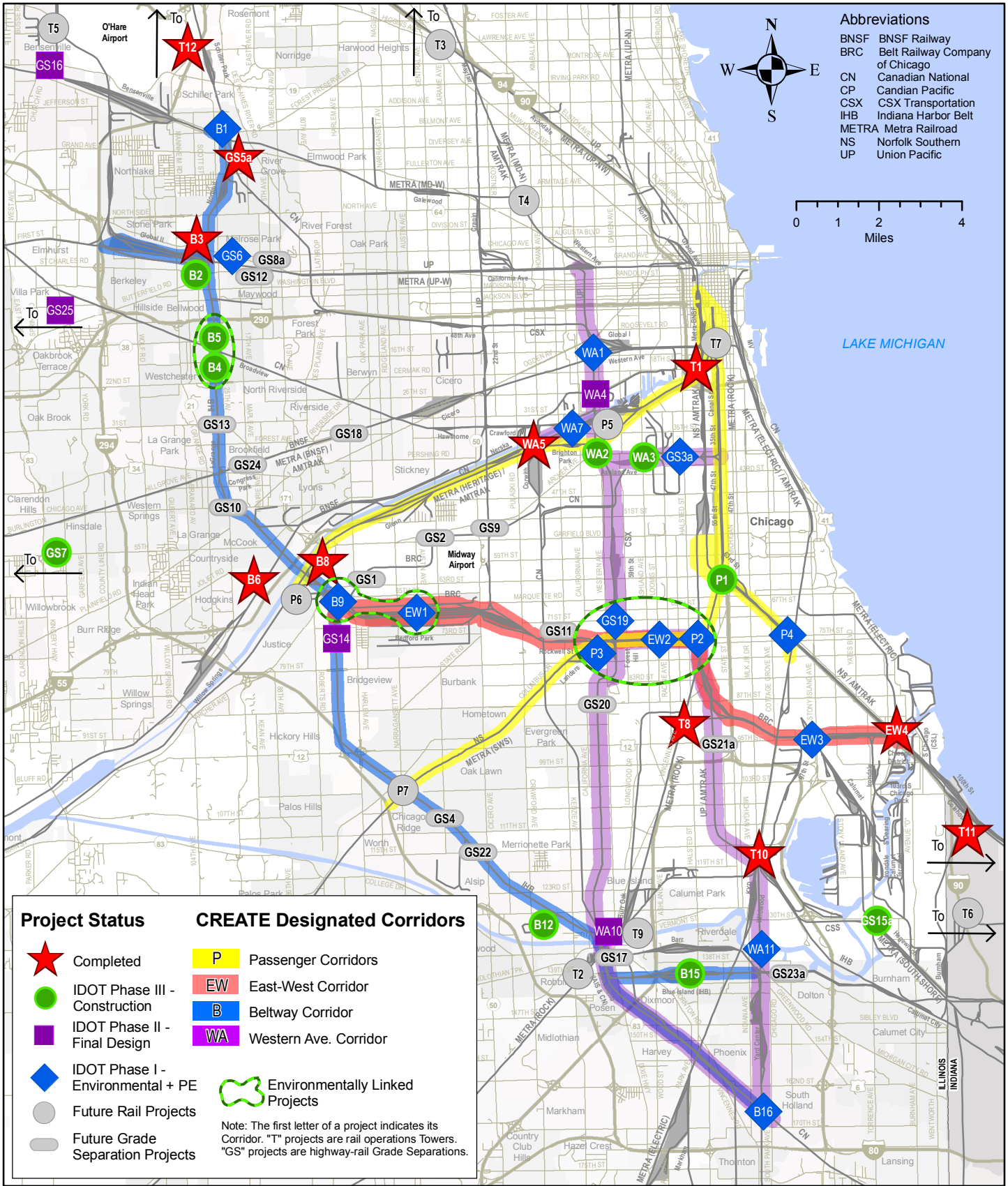

Note: Viaduct projects in the City of Chicago are not displayed.



# CREATE Program - Overall Project Status Summary

Revised - 4-Feb-11

						Current Project Status - 4-Feb-11						Project Completion Date
Proj. No.	Project Name	Municipality	Railroads Affected	Lead Entity	Initiation Pending Funding Availability	IDOT Phase I - Environmental + PE	IDOT Phase II - Final Design (PS&E)	IDOT Phase III - Construction	Project Completed			
BELT CORRIDOR	B1	CP double & IHB connection	Franklin Park	Metra/CP/IHB/CN	Metra	-	X	-	-	-		
	B2	Proviso 3rd Main	Bellwood / Berkeley / Elmhurst / Melrose Park	IHB/UP/Metra	UP	-	-	-	X	-		
	B3	Melrose connection	Bellwood	IHB/UP	UP	-	-	-	-	X	Sep 2009	
	B4*	TCS LaGrange to CP Hill	LaGrange / LaGrange Park / McCook	IHB	IHB (CSX)	-	-	-	X	-		
	B5*	TCS LaGrange to CP Hill	Bellwood / Broadview / Melrose Park	IHB/CN	IHB (CSX)	-	-	-	X	-		
	B6	McCook	McCook	CSX/BNSF/Amtrak/Metra	CSX	-	-	-	-	X	Dec 2009	
	B8	TCS Argo to Canal	Bedford Park / Bridgeview / Summit	CSX/Amtrak/Metra	CSX	-	-	-	-	X	Mar 2009	
	B9**	Argo	Chicago / Bedford Park / Bridgeview / Summit	BRC/CSX/Amtrak/Metra	CSX	-	X	-	-	-		
	B12	CP Francisco	Alsip / Blue Island	CSX	CSX	-	-	-	X	-		
	B15	TCS Blue Island	Blue Island / Dolton / Riverdale	IHB	IHB (CSX)	-	-	-	X	-		
	B16	Thornton Jct	South Holland	UP/CN	UP	-	X	-	-	-		
E-W CORRIDOR	EW1**	Argo	Chicago / Bedford Park / Bridgeview / Summit	BRC/Amtrak/Metra	BRC (CSX)	-	X	-	-	-		
	EW2***	80th Street	Chicago	BRC/Metra/UP/NS	BRC (NS)	-	X	-	-	-		
	EW3	Pullman Jct	Chicago	BRC/NS	NS	-	X	-	-	-		
	EW4	CP 509	Chicago	BRC/NS/Amtrak	NS	-	-	-	-	X	Jul 2008	
WESTERN AVE CORRIDOR	WA1	Ogden Jct.	Chicago	CSX/NS/UP/Metra	UP	-	X	-	-	-		
	WA2	TCS Blue Island Sub	Chicago	CSX/Amtrak/Metra	CSX	-	-	-	X	-		
	WA3	Ashland Ave. & CJ Mains	Chicago	NS	NS	-	-	-	X	-		
	WA4	BNSF Horseshoe	Chicago	BNSF/CN/NS/CSX	BNSF	-	-	X	-	-		
	WA5	Corwith Tower	Chicago	BNSF/CN/Amtrak/Metra	BNSF	-	-	-	-	X	Jun 2009	
	WA7	Brighton Park	Chicago	NS/CSX/CN/Amtrak/Metra	NS	-	X	-	-	-		
	WA10	Blue Island Jct.	Blue Island	CN/CSX	CSX	-	-	X	-	-		
WA11	Dolton Interlocking	Chicago / Dolton / Riverdale	IHB/CSX/UP/Amtrak	CSX	-	X	-	-	-			
PASSENGER CORRIDORS	P1	63rd & State	Chicago	Metra/NS	Metra	-	-	-	X	-		
	P2***	74th Street	Chicago	BRC/Metra/NS	Metra	-	X	-	-	-		
	P3***	75th Street	Chicago	BRC/CSX/NS/Metra	Metra	-	X	-	-	-		
	P4	Grand Crossing	Chicago	NS/Amtrak	NS	-	X	-	-	-		
	P5	Brighton Park	Chicago	CN/Amtrak/Metra	Metra	X	-	-	-	-		
	P6	Canal	Summit	CN/Amtrak/Metra	Metra	X	-	-	-	-		
	P7	Chicago Ridge	Chicago Ridge	Metra/IHB	Metra	X	-	-	-	-		
TOWER PROJECTS	T1	21st Street	Chicago	Amtrak/Metra	Amtrak	-	-	-	-	X	Feb 2005	
	T2	Blue Island Jct.	Blue Island	CN	CN	X	-	-	-	-		
	T3	Roundout	Lake Forest	CP/Metra/Amtrak	CP/Metra	X	-	-	-	-		
	T4	A-5	Chicago	CP/Metra/Amtrak	CP/Metra	X	-	-	-	-		
	T5	B-17	Bensenville	CP/Metra	CP/Metra	X	-	-	-	-		
	T6	Calumet Tower (IN)	Indiana / Chicago	IHB	IHB	X	-	-	-	-		
	T7	16th Street	Chicago	Metra/Amtrak	Metra	X	-	-	-	-		
	T8	Gresham	Chicago	Metra	Metra	-	-	-	-	X	Jan 2010	
	T9	Blue Island	Blue Island	Metra	Metra	X	-	-	-	-		
	T10	Kensington	Chicago	Metra/NICTD/Amtrak	Metra	-	-	-	-	X	Jan 2010	
	T11	Hick (IN)	Indiana / Chicago	NS/Amtrak	NS	-	-	-	-	X	Jul 2010	
	T12	Deval	Des Plaines	UP/Metra	UP	-	-	-	-	X	May 2005	
GRADE SEPARATION PROJECTS	GS1	63rd St / Harlem Ave	Chicago	BRC	CDOT	X	-	-	-	-		
	GS2	Central Ave / 54th St	Chicago	BRC	CDOT	X	-	-	-	-		
	GS3a	Morgan St / Pershing Road	Chicago	NS	CDOT	-	X	-	-	-		
	GS4	Central Ave	Chicago Ridge / Oak Lawn	IHB	IDOT	X	-	-	-	-		
	GS5a	Grand Ave	Franklin Park	IHB/CN/Metra	IDOT	-	-	-	-	X	Sep 2007	
	GS6	25th Ave	Melrose Park / Bellwood	UP/Metra	IDOT	-	X	-	-	-		
	GS7	Belmont Rd	Downers Grove	BNSF/Metra/Amtrak	Metra	-	-	-	X	-		
	GS8a	5th Ave	Maywood	UP/Metra	IDOT	X	-	-	-	-		
	GS9	Archer Ave / Kenton Ave	Chicago	BRC	CDOT	X	-	-	-	-		
	GS10	47th St / East Ave	LaGrange / McCook	IHB	IDOT	X	-	-	-	-		
	GS11	Columbus Ave / Maplewood Ave	Chicago	BRC	CDOT	X	-	-	-	-		
	GS12	1st Ave	Maywood	UP/Metra	IDOT	X	-	-	-	-		
	GS13	31st St	LaGrange Park	IHB	IDOT	X	-	-	-	-		
	GS14	71st St	Bridgeview	CSX	IDOT	-	-	X	-	-		
	GS15a	130th St / Torrence Ave	Chicago	NS/NICTD	CDOT	-	-	-	X	-		
	GS16	Irving Park Rd	Bensenville	CP	IDOT	-	-	X	-	-		
	GS17	Western Ave	Blue Island	CSX	IDOT	X	-	-	-	-		
	GS18	Harlem Ave	Berwyn / Riverside	BNSF/Metra/Amtrak	IDOT	X	-	-	-	-		
	GS19***	71st St / Bell Ave	Chicago	CSX	CDOT	-	X	-	-	-		
	GS20	87th St / Rockwell St	Chicago / Evergreen Park	CSX	CDOT	X	-	-	-	-		
	GS21a	95th St / Eggleston Ave	Chicago	UP/Amtrak/Metra (prop.)	CDOT	X	-	-	-	-		
	GS22	115th St	Alsip	CSX	IDOT	X	-	-	-	-		
	GS23a	Cottage Grove	Dolton	IHB/CSX	IDOT	X	-	-	-	-		
	GS24	Maple Ave	Brookfield	BNSF/Metra	IDOT	X	-	-	-	-		
	GS25	Roosevelt Road	West Chicago	UP/Metra	IDOT	-	-	X	-	-		
Other	Common Operational Picture	Chicago and suburbs (Chicago Terminal District)	All Railroads		-	-	X	-	-			
Other	Viaduct Improvement Program	Chicago (various locations)	various	CDOT	-	-	X	-	-			
Other	Grade Crossing Safety Program	Suburbs (various locations)	various	IDOT/CDOT	X	-	-	-	-			
<b>Total Projects</b>						<b>27</b>	<b>15</b>	<b>7</b>	<b>10</b>	<b>11</b>		

\* Projects B4 and B5 are linked for the purposes of environmental review and design/construction.

\*\* Projects B9 and EW1 are linked for the purposes of environmental review and design/construction.

\*\*\* Projects P2, P3, EW2, and GS19 are linked for the purposes of environmental review.

## APPENDIX B. PROJECT DATA AND TOOLS

### **B1. PROJECT DESCRIPTION**

- PROJECT FACTSHEET
- FREQUENTLY ASKED QUESTIONS
- OVERVIEW OF STUDY PROCESS

### **B2. SUMMARY OF STAKEHOLDER INTERVIEWS**

- LIST OF STAKEHOLDERS INTERVIEWED
- STAKEHOLDER INFORMATION REQUEST
- SUMMARY OF STAKEHOLDER INTERVIEWS

### **B3. CHARRETTE MATERIALS**

- CHARRETTE I PACKET 3-17-11
- CHARRETTE I SUMMARY 3-18-11
- CHARRETTE II SUMMARY 4-22-11

### **B4. PRELIMINARY EVALUATION OF ALTERNATIVES**

- ALTERNATIVES EVALUATION SUMMARIES 8-24-11
- INVESTMENTS/IMPROVEMENTS EVALUATION SUMMARIES 8-24-11
- DETAILED TIMELINES

### **B5. ECONOMICS MATERIALS**

- RAP SESSION PRESENTATION
- PEER REVIEW RAP WORKBOOK
- ECONOMICS TECHNICAL APPENDIX





## **B1. PROJECT DESCRIPTION**

- PROJECT FACTSHEET
- FREQUENTLY ASKED QUESTIONS
- OVERVIEW OF STUDY PROCESS



# Envisioning a Chicago Area Waterway System for the 21st Century

## Project Factsheet

Updated May 2011

### Project Overview

The Great Lakes Commission and the Great Lakes and St. Lawrence Cities Initiative are leading a project to develop and evaluate options for separating the Mississippi River and Great Lakes watersheds to prevent the transfer of aquatic invasive species via the Chicago Area Waterway System (CAWS) while improving transportation, water quality and flood management. The concept is referred to as “ecological separation.” With support from a team of consultants, the project will provide a detailed evaluation of potential options for ecological separation, including their costs, benefits and impacts.

### Preventing AIS Movement between the Great Lakes and Mississippi River

For more than a decade federal, state, tribal and local agencies have taken action to prevent Asian carp from reaching Lake Michigan. More than 180 non-native aquatic species have become established in the Great Lakes, causing economic losses estimated at \$5.7 billion annually. Asian carp are only the latest—and potentially the most damaging—invasive species poised to invade the Great Lakes. Because they are highly mobile, reproduce quickly and consume massive quantities of food, Asian carp could have devastating impacts on the Great Lakes and threaten the region’s sport fishing industry, valued at \$7 billion annually. Similarly, AIS from the Great Lakes—such as zebra mussels and round gobies—have damaged the Mississippi River ecosystem.

Asian carp have been migrating northward from the Mississippi and Illinois rivers and threaten to enter Lake Michigan via man-made waterways in the Chicago area. A key line of defense is a dispersal barrier system operated by the Army Corps of Engineers on the Chicago Sanitary and Ship Canal. In early 2010 new DNA monitoring techniques detected evidence of Asian carp beyond the dispersal barrier and in June a live Asian carp was captured in Lake Calumet. In response, a comprehensive control strategy is being implemented. Some have called for closure of navigation locks in the Chicago area as a temporary control measure. Those opposed to lock closure cite economic losses from disruption of commercial and recreational boat traffic, and the need to open the locks to prevent flooding.

### Finding a Permanent Solution

Many observers in the Great Lakes region believe that a long-term and permanent solution is needed, and that this must entail separating the Great Lakes and Mississippi

River watersheds, beginning in the Chicago area. Such a solution would protect these two great watersheds from the transfer of all aquatic invasive species between the basins, not just Asian carp. Separation would avoid continued reliance on control measures that are likely to fail while at the same time accommodating the substantial benefits currently provided by the CAWS.

### Ecological Separation—the Preferred Solution

Many observers agree that ecologically separating the Great Lakes and Mississippi River is the preferred solution to protect both watersheds from damaging aquatic invasive species. Eco-separation is a relatively simple concept: it means preventing the interbasin transfer of aquatic organisms through waterways. It likely will entail using physical barriers to prevent the movement of aquatic organisms—at all life stages—via canals and waterways between the watersheds. How to achieve this goal, however, is unclear and difficult to visualize—and thus is the purpose of the project.

Ecological separation will impact a complex system of rivers, canals and navigation structures used for commercial and recreational boating, wastewater management, flood control and emergency response. Achieving eco-separation likely will require modifying existing water infrastructure or building physical barriers to stop the flow of water while maintaining the system’s benefits. Currently eco-separation is a concept but not a readily conceivable reality.

If done right, eco-separation will be accomplished in a way that improves commercial transportation and water quality, and ensures that the flood control, tourism and recreational benefits currently provided by the CAWS are accommodated and enhanced.

### Project Description:

#### Developing Options for Eco-Separation

To address this challenge, the Great Lakes Commission (GLC) and the Great Lakes and St. Lawrence Cities Initiative (Cities Initiative) are leading a project to develop and evaluate options for ecologically separating the Mississippi River and Great Lakes watersheds in the CAWS. The project will evaluate potential options for eco-separation, including their costs, benefits and impacts. These options should prevent the transfer of aquatic invasive species while also maintaining, if not improving, other aspects of the system, including transportation of goods and people, water quality and flood management. This effort will advance two strategic objectives:

- Evaluate the economic, technical, and ecological feasibility of eco-separation by illustrating options to achieve it, along with associated costs, impacts and potential benefits of a re-engineered hydrologic system for greater Chicago; and
- Support and complement the work of the Army Corps of Engineers under their Great Lakes and Mississippi River Inter-Basin Study by defining, assessing and vetting options for ecological separation.

The initiative will fully characterize baseline conditions for current uses, quantifying the existing system's costs and benefits to stakeholders in Northeast Illinois and Northwest Indiana and the Great Lakes in general. A key outcome will be cost estimates for implementing the various options along with the costs (or risks) of not implementing them, including the cost of ongoing control and management activities. Another key outcome will be detailed analyses of the benefits to Chicago and the region of a redesigned waterway system.

Final products from the initiative will include:

- **Technical reports** on key aspects of the CAWS and impacts associated with the options for eco-separation evaluated under the project. The technical reports will focus on issues such as hydrology, transportation, economics and environmental benefits and impacts.
- A **detailed integration report** consolidating information from the technical reports and delineating options for eco-separation and evaluating their costs, benefits and impacts.
- A **concise summary report** conveying the project results to policymakers and the general public.

The GLC and the Cities Initiative are managing the overall project and have hired technical consultants with expertise in the key areas to be addressed in the technical reports.

### Project Management and Organization

The GLC and the Cities Initiative are managing the project with assistance from an Executive Committee of state and city officials and the following entities:

- **Consultant Team:** HDR Engineering, Inc. is serving as lead consultant for the project, with support from an array of premier specialty firms that bring additional skill sets needed to identify and fully evaluate potential options for separation. HDR has more than 35 years of experience in the Chicago area working on complex projects involving structural engineering, multi-modal transportation, economics, fisheries, hydraulics and hydrology, flood control, and public outreach. The consultant team is responsible for developing the technical reports.
- **Advisory Committee:** This committee provides guidance and input on the project, with an emphasis on developing and evaluating options for separation. It includes stakeholders from the Great Lakes region, with an emphasis on interest groups in the Chicago area.

- **Resource Group:** This group, made up of governmental and quasi governmental entities with a direct interest in the project, observes project proceedings; provides information about related proceedings for which they have responsibility; and provides other input that will inform the project and help achieve a successful outcome.

### Project Schedule and Timeline

The project is expected to take 18 months to complete, beginning in July 2010. It includes three phases:

- **Phase I: Hire consulting team and establish Executive Committee and Advisory Committee (July-December 2010):** During this phase the lead consultant and sub-consultants were selected and a detailed study plan was developed. The Advisory Committee convened to provide advice on the study plan and the process for consultation throughout the project.
- **Phase II: Identify and evaluate options for eco-separation (January-October 2011):** During this phase a preliminary array of eco-separation options are being developed and evaluated. Stakeholders defined criteria for selecting and evaluating options. There will be peer review of all work.
- **Phase III: Narrow and evaluate options, run models and prepare final reports (October-December 2011):** During this phase the range of options will be narrowed to a minimum of three and additional evaluation and modeling will be conducted. The final integration and summary reports will be prepared.

### Stakeholder Engagement

The project is engaging a broad stakeholder group to ensure a credible range of potential solutions is investigated and that benefits and costs of solutions are fully understood. The Chicago area (including Northwest Indiana) and the broader Great Lakes region has a substantial interest in the project. Quantifying the costs and benefits of the CAWS and fully characterizing the potential benefits and impacts of ecological separation requires extensive communication with stakeholders. The project is being conducted in close consultation with an Advisory Committee with representation from key interest groups.

### Project Funding

Project funding has been secured from six regional entities: the Joyce Foundation, the C.S. Mott Foundation, the Great Lakes Fishery Trust, the Great Lakes Protection Fund, the Wege Foundation and the Frey Foundation.

### Contacts

- Tim Eder, Executive Director, Great Lakes Commission, 734-971-9135, [teder@glc.org](mailto:teder@glc.org).
- Dave Ullrich, Executive Director, Great Lakes and St. Lawrence Cities Initiative, 312-201-4516, [david.ullrich@glslcities.org](mailto:david.ullrich@glslcities.org).

# Envisioning a Chicago Waterway System for the 21<sup>st</sup> Century

---

## Frequently Asked Questions

August 2010

### **What will the project accomplish?**

The project will evaluate potential scenarios for ecologically separating the Great Lakes and Mississippi River watersheds, including their costs, benefits and impacts. It will advance two strategic objectives:

- Evaluate the economic, technical, and ecological feasibility of ecological separation by illustrating scenarios to achieve it, along with associated costs, impacts and potential benefits for the greater Chicago area; and
- Support and complement the work of the Army Corps of Engineers under their Great Lakes and Mississippi River Inter-Basin Study by defining, assessing and vetting scenarios for ecological separation.

The project will characterize baseline conditions for current uses, quantifying the existing system's costs and benefits to stakeholders in Northeast Illinois and Northwest Indiana and the Great Lakes in general. A key outcome will be cost estimates for implementing the various options along with the costs (or risks) of not implementing them, including the cost of ongoing control and management activities. Another key outcome will be detailed analyses of the benefits to Chicago and the region of a redesigned waterway system.

### **How do you define “ecological separation?”**

“Ecological separation” is a relatively simple concept: it means preventing the interbasin transfer of aquatic organisms—at all life stages—through waterways. Ecological separation will impact a complex system of rivers, canals and navigation structures used for commercial and recreational boating, wastewater management, flood control and emergency response. Achieving eco-separation likely will require modifying existing water infrastructure or building physical barriers to stop the flow of water while maintaining the system's benefits. Currently eco-separation is a concept but not a readily conceivable reality. How to achieve ecological separation is unclear and difficult to visualize—and thus is the purpose of the project.

### **Why is this project needed?**

The immediate catalyst for this project is the imminent threat that Asian carp will get into the Great Lakes via waterways in the Chicago area. Asian carp have been migrating up the Mississippi River system since the early 1990s. For the past decade we have been taking actions to prevent them from entering Lake Michigan via the Chicago Sanitary and Ship Canal, which forms an artificial hydrological connection between the Great Lakes and the Mississippi River watersheds. Unfortunately, monitoring over the past year has shown that Asian carp are getting closer to Lake Michigan. In June 2010 a live Asian carp was captured in Lake Calumet, just six miles from the lake. This makes it clear that existing control efforts are inadequate. There is a consensus among many experts that the only permanent and totally effective way to keep Asian carp from entering the Great Lakes via waterways in the Chicago area is to completely disconnect the artificial hydrological connection between the two watersheds. The project will identify and evaluate options to achieve this. While the threat from Asian carp is the immediate catalyst for the project, it will also address the broader need to evaluate options for improving the effectiveness of the Chicago Area Waterway System for moving cargo and recreational vessels, controlling stormwater; disposing of treated wastewater, and other uses.

## **How will the project be conducted and how will it address the many complex issues related to the Chicago Area Waterway System?**

The Great Lakes Commission and the Great Lakes and St. Lawrence Cities Initiative will assemble a multidisciplinary team of highly qualified experts to identify options for achieving ecological separation and evaluating their costs and impacts. This will include experts in the fields of hydrology, engineering, wastewater and stormwater management, transportation planning, water quality and environmental protection, and related disciplines. Substantial effort is being devoted to securing preeminent technical experts, with a special focus on the unique challenges associated with the Chicago Area Waterway System. Leadership from the City of Chicago and the State of Illinois, together with guidance from a broader stakeholder advisory committee, will ensure that all appropriate issues are considered.

## **Will hydrologic separation negatively impact businesses in and around Chicago, including the shipping industry?**

The goal is to have a positive impact. Ecological separation will have implications for many uses of the system, including commercial shipping, and the project will carefully assess them. The project will look at ways to maintain current uses of the Chicago Area Waterway System while also providing a permanent solution to the threat posted by Asian carp and other aquatic invasive species. If done right, ecological separation will be accomplished in a way that improves commercial transportation and water quality, and ensures that the flood control, tourism and recreational benefits currently provided by the Chicago Area Waterway System are accommodated and enhanced.

## **Will organizations and businesses that use the Chicago Area Waterway System have a say in how the project is conducted?**

Yes, the Chicago metropolitan area (including Northwest Indiana), the broader Great Lakes region, states, municipalities, businesses, industry, and nongovernment groups will be consulted in this investigation. The project will engage a broad stakeholder group to ensure a credible range of potential solutions is investigated and that benefits and costs of solutions are fully understood. Specifically, a stakeholder advisory committee with broad representation from key interest groups will be convened to provide guidance and input on the project, with an emphasis on developing and evaluating scenarios for ecological separation.

## **Why are we so worried about Asian carp? What would happen if they become established in the Great Lakes?**

Aquatic invasive species are among the greatest threats facing the ecological and economic health of the Great Lakes. More than 180 non-native aquatic species have become established in the Great Lakes, causing economic losses estimated at \$5.7 billion annually. Today the most imminent threat to the lakes is the introduction of Asian carp. Originally introduced in the southern reaches of the Mississippi River to support aquaculture operations, carp escaped from confinement facilities and migrated in high population levels through the Upper Mississippi and Illinois River systems. Asian carp are highly mobile, reproduce and grow quickly, and consume massive quantities of food, all of which enables them to compete against—and ultimately displace—native species. One species, the silver carp, pose a danger to people because they jump out of the water when disturbed by boat motors. Given the impacts caused by proliferation of the carp in the Mississippi and Illinois Rivers—where in places they make up 90 percent of the biomass—there is considerable concern over the potentially devastating impacts their invasion would bring to the Great Lakes and St. Lawrence River region.

While questions remain about exactly how Asian carp would colonize the Great Lakes should they become established, there is no doubt they would have devastating impacts. They likely would undermine the region's sport fishing industry, valued at \$7 billion annually. In addition, they are likely to be the most prolific in shallow, near-shore areas and tributaries. These are precisely the areas most heavily used for recreation, sport fishing, boating and other activities. Thus, the parts of the lakes that we use the most would suffer the most from an invasion of Asian carp.



## **How can we be sure Asian carp haven't already established a breeding population in the Great Lakes?**

Leading scientists, such as those who developed the state-of-the-art environmental DNA (eDNA) testing method, have not found evidence that a significant population of Asian Carp have made it into Lake Michigan. While several positive eDNA tests have indicated the presence of Asian carp, they have not shown a consistent pattern that would point to substantial numbers of fish in the Chicago Area Waterway System or Lake Michigan. In addition, several large-scale fishing and eradication operations have been conducted, with only one Asian carp found past the electric barriers on the Chicago Sanitary and Ship Canal. These and other efforts make it clear, however, that Asian carp are close to entering the Great Lakes in large numbers, which is why regional collaborations such as ours are needed to solve the problem in a way that allows continued recreational and commercial use of the waterway system while safeguarding both the Great Lakes and Mississippi River watersheds from damaging aquatic invasive species.

## **Can't Asian carp enter the Great Lakes through other pathways? The Chicago Area Waterway System is only one route for aquatic invasive species to enter the Great Lakes. You could spend a lot of money shutting down this pathway and still not solve the problem.**

We are concerned about all pathways through which Asian carp could enter the Great Lakes, but the current project is focused on the most urgent threat: the unrestricted access that Asian carp have to swim from the Mississippi River system into the Great Lakes system. Other pathways, such as the Maumee River leading to Lake Erie, are only a threat occasionally, when carp-filled rivers overflow temporarily into adjacent watersheds. We expect the outcomes from project to provide a collaborative model and scientific and technical information that will help address other potential pathways. In addition, legislation has been introduced in Congress that would implement a comprehensive risk assessment of pathways through which Asian carp could enter the Great Lakes.

## **Isn't the Army Corps of Engineers already doing a similar study? How is this project different? How does it relate to the Corps' work?**

This problem, which goes beyond aquatic invasive species to the fundamental goal of protecting the ecological and commercial vitality of the Great Lakes, is bigger than any one organization can solve alone. Our project will complement not only the work of the Corps of Engineers, but of the many other federal and state organizations that are committed to finding solutions to the problems facing the Great Lakes. In addition, with leadership from the Great Lakes states and cities, our project can provide a unique perspective on, and focus attention on the most critical challenges associated with, the Chicago Area Waterway System.

## **Why do we need complete ecological separation when we have the electric barrier on the Chicago Sanitary and Ship Canal? Isn't the federal government already implementing a strategy to keep carp out of Lake Michigan?**

The electric dispersal barrier system provides an important, interim mechanism for keeping Asian carp from migrating toward Lake Michigan. Similarly, the Asian Carp Control Strategy Framework currently being implemented by federal and state agencies outlines a variety of important short-term measures to monitor for and control Asian carp in the Chicago Area Waterway System. While necessary, these measures do not provide a permanent and fool-proof approach to keeping Asian carp out of the Great Lakes. Monitoring has already shown the presence of carp beyond the electric barrier system, and a live carp was caught in Lake Calumet in June 2010. Our current strategies have already shown their limitations and it is only a matter of time before they fail. It's important to remember that once carp become established in the Great Lakes, it likely will be impossible to control or eradicate them. Therefore, what we need is a permanent and fully effective solution that makes it impossible for Asian carp—or any other aquatic invasive species—to migrate between the Great Lakes and Mississippi River watersheds. If implemented properly, ecological separation will provide such as a solution.

**Why can't we just close the navigation locks to prevent Asian carp from swimming into Lake Michigan? Wouldn't that be cheaper way to achieve ecological separation?**

Closing navigation locks on the Chicago Area Waterway System would not provide a fully effective or sustainable way to separate the Great Lakes and Mississippi River watersheds. First, even when closed, the locks leak and could allow carp to pass through. Second, the locks provide important services to the Chicago area, including the transport of commercial and recreational boats and flood control. Closing the locks could threaten public safety, risk flooding during storm events, and undermine the economic vitality of the Chicago area. Federal agencies are exploring ways to operate the locks that might reduce the risk that Asian carp might pass through them.

**Will ecological separation include reversing the flow of the Chicago River so that it flows back into Lake Michigan, like it did originally? Wouldn't this threaten to contaminate Chicago's drinking water with the city's sewage?**

Ecologically separating the Great Lakes and Mississippi River watersheds is immensely complex and there are many issues that need to be considered, including the hydrology of the Chicago River. The feasibility and impacts of reversing the flow of the Chicago River will certainly be evaluated, but it's too early to know if it would be required. Any feasible scenario for ecological separation must safeguard Chicago's drinking water supply. Technologies for treating wastewater have improved dramatically over the past century and may create new options for the Chicago area. This is one of many important issues that need to be carefully considered.

**Is this just about Asian carp, or are there other reasons to evaluate options for ecological separation of the Great Lakes and Mississippi River watersheds?**

Ecological separation of the Great Lakes and Mississippi River watersheds will protect both watersheds from the transfer of all aquatic invasive species, not just Asian carp. The Chicago Area Waterway System is a two-way path that has enabled damaging invasive species—such as zebra mussels—to invade the Mississippi River basin. In addition to the threat from invasive species, there are other important reasons to examine how the system is structured and operates, including advancing restoration of urban waterways; improving management of stormwater and wastewater; enhancing the efficiency of commercial navigation operations; building infrastructure for tourism and recreation; and other restoration opportunities. The study will help the Chicago region advance a vision of a truly world-class, inter-modal transportation system for the 21st Century.

**If Asian carp are so close to Lake Michigan, we need action, not more studies. Haven't we already studied this issue enough?**

There is no doubt that we face an urgent need to keep Asian carp out of the Great Lakes. This must include both short-term and long-term actions. In the near-term, federal and state agencies are implementing a comprehensive control strategy to monitor for and control the forward movement of Asian carp toward Lake Michigan. The Great Lakes states, cities and other parties are supporting these efforts while also advocating strengthened actions. In the long-term we need to identify, evaluate and begin implementing a permanent solution that is effective, sustainable, and that accommodates benefits currently provided by the Chicago Area Waterway System. While some studies have been conducted toward this end, additional and more detailed analysis is needed. Chicago's current waterway system developed over more than a century and is immensely complex. Transforming this system will take time and will require careful analysis by experts in a variety of disciplines. This level of analysis has not been done and must begin now. Our project is directed toward this end and will provide the foundation for moving forward.

**How long will it take to accomplish ecological separation? Won't it be too late to stop Asian carp from invading the Great Lakes?**

It's unclear how long it will take to separate the Great Lakes and Mississippi River watersheds. This will depend on the options identified, their costs, impacts and other considerations. Given the size and complexity of the Chicago Area Waterway System, it likely will take some time to implement an effective plan to achieve

ecological separation. In the meantime, it's vital that we take effective short-term action to keep Asian carp out of the Great Lakes. Asian carp are not yet established in the basin and it's not too late to keep this from happening. We must be vigilant, however, in safeguarding the lakes while a long-term solution is developed and implemented. At the same time, it is vital that we develop a credible vision for this long-term solution.

**Can we really expect the Great Lakes states to cooperate in carrying out this project when they have been suing each other over the threat of Asian carp entering the Great Lakes from the Chicago Area Waterway System?**

While the states have disagreed on whether to temporarily close navigation locks in the Chicago area, they are in total agreement on the need to pursue ecological separation as the best permanent solution to safeguarding the Great Lakes from damaging aquatic invasive species. The project is being coordinated by the Great Lakes Commission, which represents all eight states that border on the lakes. The Commission's members have unanimously endorsed the goal of ecological separation and the project that will evaluate options for achieving it. The Great Lakes states, together with cities along the lakes, are committed to finding a long-term solution that safeguards both the ecological health of the lakes and the economic vitality of the Chicago area.

**Who are the Great Lakes Commission and the Great Lakes and St. Lawrence Cities Initiative, and why are they qualified to carry out this project?**

The Great Lakes Commission is an interstate agency established in 1955 to work on behalf of the eight Great Lakes states "to promote the orderly, integrated and comprehensive development, use and conservation of the water resources of the Great Lakes Basin." The Commission is governed by delegations from each of the Great Lakes states, with associate membership from the Canadian provinces of Ontario and Quebec. The Commission is chaired by Illinois Governor Pat Quinn and has a professional staff of approximately 25 people. Additional background on the Commission is available at [www.glc.org/](http://www.glc.org/).

The Great Lakes and St. Lawrence Cities Initiative is a binational coalition of more than 70 mayors and other local officials that works to advance the protection and restoration of the Great Lakes and the St. Lawrence River. It was founded by Chicago Mayor Richard M. Daley in 2003. It is governed by a Board of Directors comprised of eight U.S. mayors and eight Canadian mayors.

The Great Lakes Commission and the Great Lakes and St. Lawrence Cities Initiative are well known and well respected, and have the credibility to lead this project. Their leadership will engage key stakeholders and ensure buy-in to the process and overall vision of the project. Their stature and ongoing engagement in Great Lakes management and policymaking will ensure that project outcomes are widely recognized and firmly established as the foundation for future discussion on the issue of ecological separation of the Great Lakes and Mississippi River watersheds. In addition, both organizations have strong ties to Chicago and northwest Indiana and in-depth knowledge of the economics, politics and jurisdictional arrangements in the region.



# Overview of Study Process

## A. OVERVIEW

The approach used for the study process was to engage stakeholders; environmental consultants; local, state, and federal agencies; and the GLC/CI using a series of interactive meetings, seminars, and technical sessions to develop three alternatives for physical separation and enhancing the CAWS. The study process consisted of five tasks as shown in Figure 1 and summarized below.

		CONCEPTUAL PHASE Jan 2011 – May 2011		FEASIBILITY PHASE May 2011-Dec 2011		REPORT PHASE Dec 2011
		Task 1: Scenarios and Criteria Development	Task 2: Alternatives Development	Task 3: Alternatives Testing & Feasibility Screening	Task 4: Alternatives Refinement & Economic Analysis	Task 5: Summary
TASKS		<ul style="list-style-type: none"> <li>Solicit Input from Resource Group</li> <li>Conduct Baseline Studies</li> <li>Solicit AC Feedback and Criteria for Selecting Options</li> <li>Develop Benefit and Cost Matrix</li> <li>Initial Options Development</li> <li>Develop Structure and Logic Models</li> </ul>	<ul style="list-style-type: none"> <li>Prepare Draft Options</li> <li>Economic Input Values Integration</li> </ul>	<ul style="list-style-type: none"> <li>Review Draft Options with AC</li> <li>Incorporate AC and RG Input</li> <li>Select Final Options for Analysis</li> <li>Engineering and Scientific Analysis</li> </ul>	<ul style="list-style-type: none"> <li>Run Options Analyses</li> <li>Review Results of Options and Analyses and Outputs</li> <li>Present Options Analyses and Outputs to the RG and AC</li> <li>Refine and Finalize Options Analyses</li> <li>CAWS-ET Tool Runs</li> <li>Draft Integration Report</li> </ul>	<ul style="list-style-type: none"> <li>Prepare Draft Study Reports</li> <li>Finalize Study Reports</li> <li>Submit Final Deliverables and Assist in Preparation of Public Summary Report</li> <li>Delivery of CAWS-ET Tool</li> <li>Final Integration Report</li> </ul>
	MEETINGS & WORKSHOPS	<ul style="list-style-type: none"> <li>Evaluation Criteria Development</li> <li>Key Issues Round Table</li> <li>Stakeholder Group Meetings</li> <li>Advisory Committee Meeting #2</li> </ul>	<ul style="list-style-type: none"> <li>Conceptual Alternatives Visioning Session</li> <li>Review Meeting</li> <li>CAWS Boat Tour</li> <li>Stakeholder Follow-Up Meeting</li> <li>External Peer Review Meeting #1</li> </ul>	<ul style="list-style-type: none"> <li>Risk Analysis Process (RAP) Sessions</li> <li>Advisory Committee Meeting #3</li> <li>External Peer Review Meeting #2</li> </ul>	<ul style="list-style-type: none"> <li>Economic Seminars</li> <li>Advisory Committee Meeting #4</li> <li>RAP Session #3</li> </ul>	

SROI = Sustainable Return on Investment process  
 CAWS-ET = Chicago Area Waterway System – Evaluation Tool

**Figure 1. Overview of Study Process**

### TASK 1: SCENARIOS AND CRITERIA DEVELOPMENT

Task 1 consisted of generating the baseline data required for alternatives development. Specific activities conducted under Task 1 are listed below.

- Kick-off Meeting
- Stakeholder Group Meetings
- Advisory Committee Meeting #2
- Baseline Data Research and Analysis
- Preliminary Alternatives Development
- Development of the Benefit and Cost Matrix
- Development of Structure & Logic Models

## Overview of Study Process

---

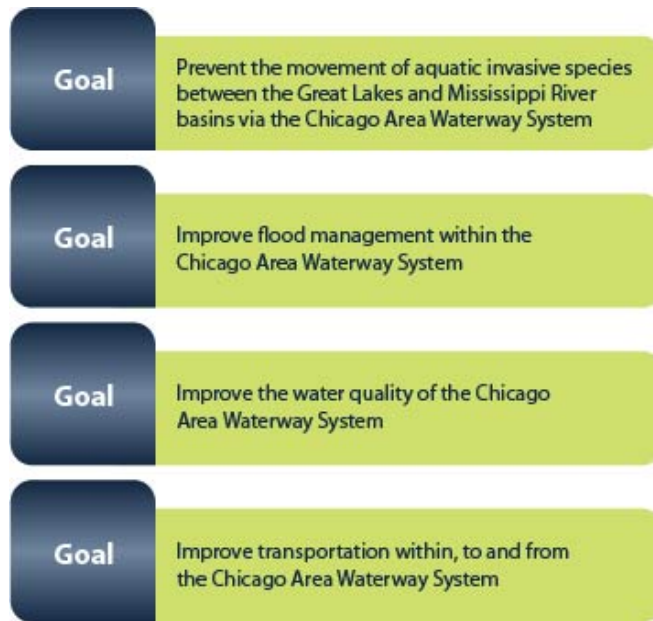

**Figure 2. Study Criteria Developed**

Data gathering was designed to document the current baseline conditions that exist today and highlight the criteria that will shape the future use of the CAWS. The collaborative data gathering process engaged stakeholders, key agencies managing and influencing the CAWS, and recognized experts from a broad spectrum of public and private entities in addition to the GLC/CI. Collection of CAWS data took place through raw data exchanges, teleconferences, and face-to-face meetings. These interactions and sharing of knowledge formulated the scenarios and criteria to be applied in the alternatives development task (Figure 2). The scenarios and criteria were utilized as the framework

for development of a Rapid Evaluation Tool for screening the benefits and impacts of CAWS modifications.

The initial step of the SROI process was conducted as part of Task 1 and produced a range of possible cost and benefit categories. For each of the stakeholder impacts identified in the cost and benefit matrix, a “structure and logic model” was developed to illustrate how impacts will be estimated or “monetized” to permit stakeholder scrutiny and modification. The benefit cost matrix and the logic models were developed in coordination with the AC members to ensure that all impacted groups were allowed to provide input on both the impacts and how they were derived. Through this stakeholder engagement process, the SROI evaluation framework was refined, data sources to populate the framework were identified, and data gaps were highlighted.

### TASK 2: ALTERNATIVES DEVELOPMENT

Task 2 consisted of identifying and screening physical separation strategies. Specific activities conducted under Task 2 are listed below.

- Conceptual Options Session (Charrette I and II)
- Review Meeting
- Economic Input Values Integration
- CAWS Boat Tour
- Stakeholder Follow-up Meetings
- External Peer Review Meeting #1



---

## Overview of Study Process

---

The HDR Team conducted a multi-day charrette-style session to formulate alternatives. This conceptual visioning session was conducted in order to efficiently accommodate the large variety of disciplines required to envision an enhanced CAWS. The charrette was a systematic involvement tool used to generate and test ideas and concepts and make revisions based on input from participants selected by HDR and the GLC/CI. The ideas introduced in the charrette process were continually refined so that general consensus was achieved on the vision and key strategies to reach the goals of the study. After the charrette was complete, a post charrette package was prepared to identify the vision, goals, objectives, strategies, and policies, including performance targets and timeframes for each goal and recommendation (Appendix B). This special data gathering session enabled an in-depth understanding of the needs, key issues, and special circumstances surrounding the current and future operation of the CAWS.

Following the conceptual visioning session, the scenarios that were developed were rigorously reviewed by the HDR Team, the GLC/CI, the AC, stakeholders, and an external peer review team in order to evaluate results of the charrette process for fatal flaws that may impact the overall ranking of alternatives in the SROI process.



**Figure 3. CAWS Boat Tour (6/28/11)**

A Rapid Evaluation Tool was used for screening the benefits and impacts of the options. The Rapid Evaluation Tool was used to score the initial options presented in the charrette and to revise the rankings of the various options once the charrette was completed. These scores were utilized in the SROI process.

Probabilistic risk analysis and simulation techniques were used to account for uncertainty in both the input values and model parameters for the data collected in Task 1. All projections and input values were expressed as probability distributions (a range of possible outcomes and the probability of each outcome), with a wider range of values provided for inputs exhibiting a

## Overview of Study Process

---

greater degree of uncertainty. Each element was converted into monetary values to estimate overall impacts in comparable financial terms and discounted to translate all values into present-value terms. Specifying uncertainty ranges for key parameters entering the decision calculus allowed the SROI framework to evaluate the full array of social costs and benefits of the project while illustrating the range of possible outcomes.

### TASK 3: ALTERNATIVES TESTING AND FEASIBILITY SCREENING

Task 3 consisted of analyzing the technical aspects of the proposed alternatives and testing the valuation of economic metrics. Specific activities conducted under Task 3 are listed below.

- Engineering and Scientific Analysis
- Risk Analysis Process Session #1
- Risk Analysis Process Session #2
- Advisory Committee Meeting #3
- External Peer Review Meeting #2

The overall goal of this step was to identify the general footprint and affected environment of the alternatives. Examples of assessed infrastructure that may be impacted by the alternatives include major roads, bridges, rail, sewers, and private and public utilities. Critical issues such as cost, feasibility, and reliability were assessed. A preliminary impacts analysis of the options was performed with particular focus on multi-modal transportation, water quality, flood/stormwater management, AIS, and ecological integrity. Detailed data requests were submitted to the necessary governmental agencies for additional site-specific data at the locations of infrastructure modifications. This data was used to refine the costs and associated impacts and opportunities represented by the options. Two additional meetings were conducted in order to solicit review comments from the AC and external peer review team related to the preliminary impacts analysis.

Two Risk Analysis Process (RAP) sessions were conducted in order to collect additional feedback on the SROI model framework before outcomes were quantified. Those involved in these sessions included key technical representatives and select stakeholders. Facilitation techniques were used to elicit risk and probability beliefs from participants about:

1. The benefit and cost matrix,
2. The structure and logic models, and
3. Uncertainty attached to each input variable that was used to populate the structure and logic framework. Included in this quantification was the degree of uncertainty for each variable.

# Overview of Study Process



Figure 4. SROI Process

## TASK 4: ALTERNATIVES REFINEMENT AND ECONOMIC ANALYSIS

Task 4 consisted of the SROI analysis of the options generated in previous tasks and the preparation of the Draft Integration Report that will describe the specifics of the entire project. Specific activities conducted under Task 4 are listed below.

- CAWS-ET Tool Runs
- RAP Session #3
- Public Meetings
- Advisory Committee Meeting #4
- Draft Integration Report

An SROI analysis was conducted to quantify the impacts of each option described in the cost and benefit matrix by stakeholder group. The impacts span economic, social and environmental factors (Figure 5). The final structure and logic model resulting from Task 3 will be referred to as the CAWS-Evaluation Tool (CAWS-ET) model.

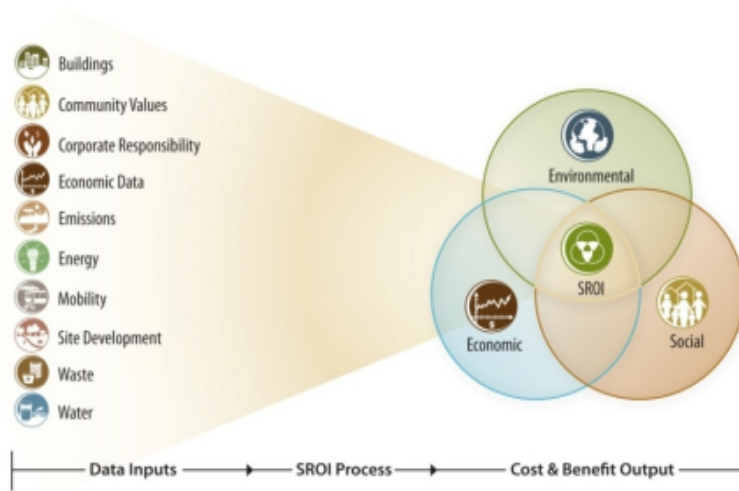

Figure 5. SROI Methodology

The evaluation framework model and data inputs were coded and simulated using probabilistic (Monte Carlo) analysis. The analysis quantified and monetized the costs and benefits for each separation option. The SROI outcomes analysis identified the most probable optimal separation options based on the maximization of financial, environmental and societal returns. These results were presented to the GLC/CI as well as the AC and RG through another RAP session where the CAWS-ET tool was simulated in real time with alternative model assumptions and refinements. All project metrics were generated by individual stakeholder groups so that decision-makers can assess the varying impacts and tradeoffs by stakeholder.

## Overview of Study Process

---

The final step in the process was the generation of SROI metrics, including Net Present Value (NPV), Discounted Payback Period, Benefit-Cost Ratio and the Internal Rate of Return, in addition to the traditional financial metrics. Financial metrics were included as a point of comparison and to transparently and comprehensively illustrate the relative merits of all potential investments being analyzed. Underlying each of these monetized effects were specific impacts which were also quantified.

### TASK 5: SUMMARY

Task 5 consisted of final document preparation. Specific activities conducted under Task 5 are listed below.

- Delivery of CAWS-ET Tool
- Summary Report
- Final Integration Report

This document serves as the final Integration Report that concisely reviews the engagement of experts, conceptual visioning, public and agency outreach, and development and analysis of three alternatives for separation. Technical memoranda, a summary of key issues, and potential actions to prevent interbasin transfer of species and enhancements to the CAWS have been incorporated. A final presentation to review the integration report and study process was given to the GLC/CI.

Task 5 also included preparation of a summary report by GLC/CI aimed at a more public audience than the integration report. The goal of the summary report is to help engage stakeholder groups throughout the Chicago area and Great Lakes region, providing them with useful information in a clear, concise, and transparent manner that reinforces the development of credible solutions and a basic understanding of the associated costs and benefits.

### **B. COLLABORATION**

In order to successfully evaluate the economic, technical and ecological feasibility of separation, a defensible, credible process was required. With this in mind, a “no boundaries” approach was taken in which government agencies, stakeholders and technical experts worked together to consider opportunities for placement of physical barriers, challenges to overcome and potential improvements to the CAWS. Collaborating parties can be grouped into several categories depending on their role in this project as described below.

**Executive Committee (EC):** In addition to representatives from the GLC and CI, the Mayor of Grand Rapids, the Governor of Ohio, the Governor of Illinois and the Mayor of Chicago served on an Executive Committee that guided the overall effort. The EC was kept apprised throughout the project by the GLC/CI, and representatives attended AC and Preview meetings.

---

## Overview of Study Process

---

**Stakeholders:** A key stakeholder was defined as having some jurisdictional authority or management oversight of CAWS elements. Initial meetings with stakeholder groups focused on data collection and discussion of technical issues related to the project. A summary of meetings with a brief description of outcomes is included in Appendix A, as well as a list of stakeholders that were interviewed. Additional follow-up sessions were conducted to discuss the initial alternatives developed during Charrette I and II.

**Advisory Committee (AC):** An Advisory Committee was convened to provide guidance and input on the project, with an emphasis on developing and evaluating options for separation. The AC represented a broad array of stakeholders that were interested in or would be affected by separation (or the lack thereof) and were given the opportunity to provide advice and input to the study effort. Approximately two-thirds of the AC were from the Chicago area or/and Northwest Indiana, as listed in Appendix D. This committee met three times during the project and was responsible for project oversight, document review, and criteria development. Agendas, meeting minutes, and presentations for the three AC meetings that occurred during the study are included in Appendix D.

**Resource Group (RG):** The Resource Group was comprised of representatives from tribal, state, and federal agencies, as listed in Appendix D, with a direct interest in the project and the ability to assist with data collection and technical expertise. This group was responsible for observing project proceedings, providing additional information where necessary, and providing input to help achieve a successful outcome.

**Peer Review Team:** The Peer Review Team was comprised of five technical experts in the fields of engineering, water quality, transportation planning, and economics with specific knowledge of the Chicago metropolitan area and the CAWS. The Team was responsible for reviewing information presented by the HDR Team at two separate times during the study process. Team members, agendas, meeting minutes, additional comments and presentations for each peer review session are included in Appendix C. Materials that were provided to the Team for review are incorporated within Appendices A and B.



**Figure 6.**  
**Collaborating Groups**





## **B2. SUMMARY OF STAKEHOLDER INTERVIEWS**

- LIST OF STAKEHOLDERS INTERVIEWED
- STAKEHOLDER INFORMATION REQUEST
- SUMMARY OF STAKEHOLDER INTERVIEWS



## List of Stakeholder Interviews

---

Alliance for the Great Lakes

American Waterways Operators

Chicago Metropolitan Planning Commission

City of Chicago

Council of Great Lakes Governors

Friends of Chicago River

Great Lakes Fishery Commission

IDNR\_Injerd

IDNR\_Vic

International Joint Commission

IEPA

Metropolitan Planning Council

Midwest Generation

MWRDGC

Northwest Indiana Forum

Natural Resources Defense Council

Recreational Boaters

USACE

USCG

USEPA

USFWS

USGS

## **Open Questions**

What are your primary interests regarding the Chicago Area Waterway System?  
What data or information can you share to help inform our study of the CAWS?  
Where else would you refer us to become as knowledgeable as possible for the study?

## **Categories of Information / Reports / Data for CAWS**

### **ECOLOGY**

Physical habitat  
Chemical water quality  
Biological communities  
Asian carp fish surveys  
Chemical sediment quality  
Future climate changes  
Mathematical modeling (water quality)

### **ECONOMICS**

Future waterway development plans  
Economic analyses  
Land uses  
Property values  
Recreational boaters  
Marina locations  
Passenger boats  
Rail studies  
Truck studies  
Water studies (barge/ship)

### **STORMWATER**

Flooding  
Water source flows/outlet flows  
Sewer atlas  
Backflows to Lake Michigan  
CSO discharges  
Mathematical modeling (quantity)  
Future plans (stormwater and CSOs)

### **TRANSPORTATION**

Rail studies (cargo in and out of Chicago region)  
Truck studies (cargo in and out of Chicago region)  
Water studies (cargo in and out of ports/CAWS)  
Passenger boats  
Recreational boaters  
Goods and materials shipped by water  
Air quality  
Future plans  
Bridges

### **WATER QUALITY/WASTEWATER**

Chemical water quality  
Mathematical modeling (water quality)  
Future improvement plans (wastewater)  
CSO discharges  
NPDES dischargers  
Backflows to Lake Michigan

KEY CONTACT

Name  
Address  
Phone  
E-mail

DATE:  
LOCATION/PHONE:  
HDR PARTICIPANTS:  
CALL PARTICIPANTS:

Q1: What are your primary interests regarding the CAWS?

- Bullet Notes

Q2: What data or information can your agency share to inform our study?

The following resources were discussed for possible inclusion in the study, with a notation for follow up responsibility:

WHO	WHAT

Q3: Where else would you refer us to become as knowledgeable as possible?

The following were discussed as possible sources of additional information:

WHO	WHAT

Meeting Notes & Background

- Bullet Notes

Team follow-up

(Q2 Default follow-up is to the assigned initial contact to maintain one person reaching out to key contact, Q3 varies)

WHO	WHAT

During the stakeholder interview process, the team recorded and confirmed stakeholder interests regarding the CAWS. These are listed below in alphabetical order. The stakeholder who offered each of the below comment is intentionally left off the list.

What are your primary interests regarding the CAWS?

- Access between Lake and river opportunities.
- Access to water suitable for cooling processes of power plants.
- AIS vectors between Great Lakes and other water bodies
  - Ecologic integrity
  - Economic impact
  - Recreational / other inspirational values
- As a means to support the supply chain of the power plant – barged coal.
- Availability of Potable Water supply for future economic development.
- Being able to access both river and lake – keeping continuity / continuous access.
- Capitalize on proximity to Lake Michigan for water intensive (but also water efficient) economic development, which would only be strengthened by return of clean effluent/storm water to the lake to offset diversion.
- CAWS (plus Lake) to evolve into the “heart” and defining Chicago asset that enables Chicago to develop into world class urban center.
- CAWS / land use interaction and access to CAWS.
- CAWS as “second shoreline”.
- CAWS as a means to improve the efficiency of moving goods and people – for the benefit of modernizing our development patterns.
- CAWS as a means to increase property value and Chicago’s global prominence.
- CAWS as a means to manage water that supports existing functions of: treatment plant discharge, storm water flood controls, and combined sewer overflows.
- CAWS as a pathway for aquatic invasive species.
- CAWS as a potential contributor to the ecological integrity of the GL.
- CAWS as an asset for economic development.
- CAWS as an asset for broad quality of life improvements, recreational, economic, natural resources, management of water flows, health, safety etc.
- CAWS as habitat / habitat support for State Threatened and Endangered species.
- CAWS as an opportunity of policy and regulatory innovation / precedence.
- Conveyance of storm water flows.
- Diversity of opportunities – creating access to and additional points of interest
- Enforcing and protecting water quality standards per CWA.
- Engage the public on CAWS with safe access and recreational opportunities.
- Establishing a physical barrier separating CAWs from Mississippi River basin.
- Extensive experience with control of sea lamprey – resource about invasive species control.
- Facilitation of a consensus around AIS prevention.



- Fate and role of the electric barrier system.
- GLRI funding oversight – emphasis on Asian carp as invasive species.
- Governance is a critical item to address and potentially reform to improve management options.
- Governance of agreements and waterway regulations related to WQ and river traffic.
- Governance of waterways: Federal, State and local agreements, contracts, jurisdictions, proceedings, processes, etc.
- Improve freight related movement of goods into and out of Chicago.
- Management of water resources: Allocation process and management.
- Minimize property and environmental damage from flooding, as well as offset storm water component of diversion, through a robust green infrastructure strategy (including effluent/storm water reuse) to reduce eventual flow to CAWS, which in turn may make return to the lake more practical.
- Monitoring activities related to Asian carp, and recreational fishing.
- Non-biased systematic data collection and data archiving.
- Offer a logical framework to serve as a clearing house of information that clearly articulates and informs leaders of GL / CAWS issues.
- Permitting discharges as delegated through the IEPA.
- Preserve function as receiving water for treatment plant effluents.
- Project specific support – targeted USGS resources and expertise to support other agency projects.
- Protect and improve the CAWS's recreational, habitat, human access and wq while not impinging upon other uses.
- Protecting public health and safety
  - WQ appropriate for public use
  - Conveyance of sewage effluent
  - Flood control
- Protection of water environment, including public health
- Shipping related transportation, and the industries that rely on the movement of goods through the Calumet system:
  - Industry is very concerned about the impact from invasive species within the ecosystem – the environmental and economic impacts that could potentially result
  - Managing expectations as to the actual outcome and implementation of the 21st Century project report both for the public at large and stakeholders needs attention
  - Acknowledgement of existing CAWS investments (i.e. ACE dredging and flood control projects) that will be impacted
  - Respect the positions of Indiana industries and public safety issues have them clearly reflected in analysis
  - Assurance of data integrity (financial & scientific) before any inclusions in the report are made and subsequent recommendations and/or conclusions are made any conclusions are made
  - Develop an understanding of each side's issues – collaborative understanding

- Support other agencies who are actively managing or using waterway operations.
- The “mixing” of CAWS and Lake Michigan is one trigger for AGL engagement.
- The governance of managing water to improve water quality of rivers and lake, and to sustainably manage the diversions and allocations of GL water through the CAWS.
- The potential of CAWS to act as a vector of impact to fisheries.
- The prevention of biological pollution, bi-national interests, diversions and flows.
- The primary concern of your agency is the safety of the vessels and mariners – both recreational and commercial along navigable waterways.
- To develop a vision that is as inclusive as possible while improving the access and value of the recreational, habitat and wq components of the entire CAWS.
- To have an equitable distribution of all reasonable values of CAWS.
- To instill a regional perspective.
- Transportation for towing industry and towing industry customers:
  - Cost of movement of goods – barge is always the most cost effective and environmentally friendly (with the smallest carbon footprint) transportation form
  - Safety – is significantly safer than other forms of transportation (rail, truck) & has significantly less impacts to lifestyle
  - Reduction in: noise, road traffic congestion, fatalities, death, air emissions
  - Inherently safer material transport of hazardous materials
- Water diversion and commercial navigation in the CAWS.
- WQ standards that support operation of plant – both inflow and discharge related expenses.

During Stakeholder interviews, the following potential resources were identified. Many, but not all of these resources were evaluated and considered in the research for this project:

<b>Description of Suggested Resource as Provided by Stakeholder</b>
GLIMRS, PVA - Efficacy Studies for Asian Carp and electric barrier USCOE, Lynn Wayland, "first efficacy", Mike Barduhn,
"The Rag" Ned Dickman – Great Lakes Boating
2003 Volpe Report – traffic study on river
2006 report by EVA regarding the alternative transport routes of coal - MWG
2040 plan (online and hard copy acquired)
30 yr fish data from electric barrier to confluence with Illinois River – Irwin understands this dataset
Access to board members with insights into rail, other transit and downtown development concepts (BNSF, JLL, Architects, etc)
American Waterway Operators – Lynne Muench
Asian Carp Rapid Response Plan
Barge / goods data: Darren Melvin
Bing O'Meara, Publisher; Lakeland Boating
Blue Island-using crew as a feature of waterway, Jodi Proutt (City staff) may have insights.
BOAT US contact name for recreational boating concerns. David Kennedy
Boating Writers International; Greg Proteau, Executive Director
Book: The Waterway Guide – for marina and boatyard listings
Bridge data– elevation relative to waterways or list of lowest bridges relative to waterway; planned capital investments, operational data
Bubbly Creek feasibility study
Cal-Sag: 7 communities greening plan (Hitchcock design?)
Calumet Open Space
Calumet Plan reports and Calumet H&H
Calumet River Fleeting – barge info
CAWS 3-dimensional model from U of I - Garcia
CCAP – comments in there about river as a cooling factor – urban heat island, mitigation
Center For Excellence contacts such as Nick Mandrate and Sarah Baily regarding risk assessment and data formats that can be used bi-nationally
Center for Neighborhood Technology - Traffic studies and green infrastructure insights
CGL AIS advisory panel contact list
Chambers of Commerce
CHEERS study addresses users, available online
Chemical Industry Council of Illinois – Lisa Freede - economic data on transportation of bulk materials in CAWS associated with the US Supreme Court Case filed by the State of Michigan
Chemical sediment study - Baxter and Woodman, Mandy Pool
Chicago Agendas: Chicago River, Nature, Water
Chicago Climate Action Plan (and updates)
Chicago Park District – Planning docs for river and river marinas, beach and habitat, etc
Chicago Park District Master Plan
Chicago Police and fire departments – safety issues
Chicago River Paddle...both Kayaks and canoes. Near Lane Tech High School
City of Chicago (Planning)- Unpublished report on the Illinois port system by
CMAP - Water 2050 plan

CNT - Cargo study of southern suburbs: David Chandler at CNT, david@cnt.org
Cook county – parcel layer
Council approved Downtown Development Plans: West Loop Transportation Center Plan, Central Area Action Plan
Court Filings on closure of locks– as a key source for many interests, including fire and police issues
CREATE - Mr. Tom Murtha, Senior Planner (freight system planning)
David Salzman
Dept of Defense - National security check – PT boat example
Dept of Interior, SFBPC
Design Charette findings on landscape, wq, naturalization etc.
Dr. Brett Baden : Senior Economist on innovation clusters; (312.386.8752, bbaden@cmap.illinois.gov)
Dr. Phil Moy
DUFLOW model for CAWS from Marquette –Dr. Melching
East Chicago WWTP, Pete Banyai
Economic indications that property values along CAWS increases faster than areas away from the waterways
Electric barrier contacts such as John Gannon and Kay Austin, Phil Moy, Duane Chapman
Elsip – possible boat launch information
Engage with South Suburban Mayors and Managers
Environmental Policy Center - Howard Lerner
Estimates of possible nutrient removal capital costs
Fish data from May 2010 Little Calumet River rotenone application (downloaded)
Fisheries and Oceans Canada: (USGS, USFWS) : parallel process evaluating risks to GL Bob Lambe – Canadian Regional Director
Fishing tournaments in the CAWS require a fishing license from the IDNR – as an indication of recreational fishing economy / interest.
FOCR / Openlands reports on recreational boating
Foth Reports: 35% Dredging Plan, Sediment Characterization on the CalSag studies, NPDES dischargers (Steven Russel from USCOE PM for Froth Reports)
Friends of Chicago River - Biological Data – John Quail
Friends of Chicago River - Waterways for our Future –publication in conjunction with other agencies
Gary Sanitary District contact information
GIS CDOT: Bridges? River related traffic? If necessary, we will request the river crossings of freight / trolley tunnels if we are locating barrier in proximity
GIS DoIT: Transportation layers, (RR, highway, roadway, etc) City Boundary, Hydraulic and river layers, parcel map, boat launches, boat slips / marinas
GIS DPD: – River bank study, industrial corridors, wildlife areas, opens space areas, adjacent land use, zoning layers
GIS DWM: CSO database, sewer layers and related feature classes, “sand layer” (if Water is willing to share “key” river crossings of potable water related infrastructure, we will consider these locations)
GIS-Parcel map - County
GLFC - Real costs related data of AIS control related to Sea Lamprey
GLRI and Healing our Waters
Grant Crowley – may offer insights to recreational boating on the CAWS
Great Lakes Port Association – barge traffic from river to GL ports and vice versa
Great Lakes Ports Study - Steve Fisher, from DC
Great Lakes Water Quality Agreement
Hammond Indiana Sanitary District - Dr Michael Unger
Hansen Materials - barge data

Henry's Fishing, source for any fishing related data - Tommy Palmasono
Hitchcock Design (seven cities on Calumet, Joel Baldin)
IDEM - Danielle Barnett, Remedial Action Plan coordinator for Grand Calumet River Area of Concern regarding ecological data and additional contacts
IDNR - Certificate of documentation – partial quantification of boat numbers – “documented vessel”
IDNR - Dye tracer data in support of the Asian Carp rapid response work was collected on the CSSC between RM 291 (Lockport Lock and Dam) and RM 297 (Corps-Electric fish barrier) and on the Calumet River-Cal-Sag Channel between RM 326 (O'Brien Lock and Dam) and RM 314 (approx... Ridgeland Avenue).
IDNR – list of State of Illinois threatened and endangered species within CAWS
IDNR - Monthly IL6 reports (flows through structures)
IDNR ECO CAT – T&E consultation process (Joe Kath)
IDNR fishing licenses for Cook County may indicate economy of recreational fishing
IDNR Rotenone study, and other fish sampling by (Steve Pescatelli ) in CAWS
IDOT - Intermodal, Rail, Truck, Pumping Stations, bridges
IEPA - Specific permit details associated with NPDES dischargers
IJC reports (~2002) that look at diversions in and out of Great Lakes and or consumptive uses
IL Chamber of Commerce – rec boaters – James Ferrell?
IL Natural History Survey – historical data of fish communities in CAWS
IL River – LTRMP – Rick Sparks on the Upper Mississippi
Illinois Chamber of Commerce – Infrastructure Council – barge / roadway / lifecycle etc
Illinois Pollution Control Board testimony, including Laura Barghusen, Openlands testimony, inclusive of map of boat docks on CAWS
Indiana Department of Natural Resources - Ron McAhron
Indiana DNR - Sediment data on Grand Calumet River
Indiana Port Economic Study – Jody Peacock
Industrial strategy document(s) (two current studies underway with DPD)
Informa Economics <i>Barge Commodity Profile 2010</i> report: <a href="http://www.bargefleet.com/">http://www.bargefleet.com/</a>
Initial separation study with Irwin and Scudder and Joel
IPCB - Documents such as DO studies submitted to IPCB
Irwin and Joel Study on separation
Joel Schweiderman – DePaul economic study
Kathy Luther, NIRPC; Dan Repay, Little Calumet River Basin Commission,
Kayak Chicago : <a href="http://www.kayakchicago.com/locations/chicago-river/">http://www.kayakchicago.com/locations/chicago-river/</a>
Kendra Towing
Lake Carriers Association contact
Lake County stormwater plans – contact Patty Werner
Lake Riverdale Plan (Reggie Greenwood)
LimnoTech Habitat Study: 2005-2009 – index related data
Lincoln Park Juniors
Link to Kingston Workshop findings or contacts
List of terminals and docks – John Kindra / Ms Terry Doyle
Listing of IJC activities associated with the electric barrier
Louis Berger Group waterway traffic forecast: <a href="http://www2.mvr.usace.army.mil/UMRS/NESP/Documents/LBG%20Non%20Grain%20Forecasts%20-%20Final%20Report%20Oct%2029%202007%20(2).pdf">http://www2.mvr.usace.army.mil/UMRS/NESP/Documents/LBG%20Non%20Grain%20Forecasts%20-%20Final%20Report%20Oct%2029%202007%20(2).pdf</a>
Major Water Users, i.e. Corn Products, Alsip Paper, Midwest Gen
Mapping of key stakeholders at Capital centers – focused on IL, WI, IN and MI
Martin Report on Burns Harbor (\$14B estimate)

Master Plan - Capital Improvement Plans for relevant facilities
Metra and or RTA for information associated with Bridge work.
Metro 2020 Infrastructure Plan
Metro Mayors Caucus, and/or other mayoral organizations that should have a larger voice in the issue(s)
MI Supreme Court lawsuit affidavits
MICRA – Mississippi Interstate Conservation Resource Association – control plan for Mississippi River Basin
Midwest Gen studies – ecological studies by EA Engineering
Milwaukee Port Association – river barge traffic to that port
Model Stormwater and Floodplain Ordinances (pre MWRDGC authority) – low priority
MPC - Moving at the Speed of Traffic (downloaded)
MPC Advisory Board
MPC web site for MPC perspectives
Mr. Ross Patronsky, Senior Planner (conformity analysis)
Ms Gang, architect and Harvard based studio. Envisioning CAWS. – Studio Gang
MWRDGC - Ambient Water Quality – available online, but may need compilation
MWRDGC - Backflow volumes to Lake – Online, but may need compilation
MWRDGC - Biological and water quality data
MWRDGC - Estimates of CSO capture/Treatment – available online
MWRDGC - Fats/Oil/Grease Bi-monthly report
MWRDGC - Gauging stations / WQ stations – online data
MWRDGC - General Chemistry Data - monthly
MWRDGC - physical habitat studies
MWRDGC - Plant and PS effluent data – online, but may need compilations
MWRDGC - USGS - Flow, WQ Data and insights
MWRDGC - watershed plans
MWRDGC - Watershed plans – less informative to CAWs – non priority
MWRDGC - watershed plans etc.
National Corn Growers Association –“ water compelled rates” documentation (Paul Bertels is the best contact)
National Marine Manufacturing Association –office in Chicago
Natural Areas - Open Space plan
NMMA - Boating economics- Tom Damnrich manufacturing in boating industry
NPDES discharge permit - MWG
NRDC - Greg Gould – transit study collaboration opportunities
NRDC - LA and Longbeach CA reports on air quality
NRDC 2010 separation analysis: <a href="http://docs.nrdc.org/water/wat_10102001.asp">http://docs.nrdc.org/water/wat_10102001.asp</a>
Ontario Ministry of Natural Resources – following with great interest, reach out to communicate
Passenger Vessel Association (PVA) contact information; Peter Lauridsen; Regulatory Affairs Consultant
Port of Indiana Jody Peacock
Priority Pollutants
PSIX vessel search
Public Water supply info reported to IDNR- transferred to USCOE for diversion accounting
Purdue Transportation freight study - Dr. Amlan Mitra
Rapid response group
Recent Rule Making (i.e. Bow Boats)
Recent rule makings that have relevance (HDR Team to research others)
River crossings - ID which are fixed and which are geared to lift/rotate
Rule Making reports current and past



Sediment data 02-09
South Suburban Mayors Caucus
Southern IL sampling in CAWS - Greg Whittedge
Southern Illinois study regarding barge vs truck – Bob Sheehan
Stormwater ordinances of Lake County Stormwater Group and Cook County Forest Preserve
Texas Transportation Institute – traffic related economics
U of C - Center for Global Studies
U of C Reuben Keller – AIS scientist
U of I – Chicago – Marty Jaffe – Urban Planning and Policy Center, Green Infrastructure related policy with IEPA
U of I models via MWRD
U of M Don Scabia –climate studies: downscaling to local level
UAA - documentation associated with Illinois Pollution Control Board
UAA – great source of many data points, including some slip information
UAA – Rec boaters (and other data)
UAA - Recreational values
UAA - Relevant reports and IPCB R08-9 regulatory hearings – available online
UC Berkeley study of waterway shipper demand: <a href="http://www.corpsnets.us/docs/ModelPrefUpperMissGrain/07-NETS-R-01.pdf">http://www.corpsnets.us/docs/ModelPrefUpperMissGrain/07-NETS-R-01.pdf</a>
University of Marquette - Dr. Mark Garlich
University of Toledo
Urban development and non-point source pollution report -associated with soft engineering
USACE - UC Berkeley study of waterway shipper demand: <a href="http://www.corpsnets.us/docs/ModelPrefUpperMissGrain/07-NETS-R-01.pdf">http://www.corpsnets.us/docs/ModelPrefUpperMissGrain/07-NETS-R-01.pdf</a>
USCG - Bob Bailey (Marine Safety Unit) – CDR Robert Bailey, Commanding Officer of MSU Chicago
USCG - Commander Scott Anderson will assume dpi for D9 on July 18, 2011
USCG - Sector Commander CAPT Luann Barndt, commanding officer of Sector Lake Michigan through June 14
USCG - webpage: registered, documented commercial vessels
USCG R&D and GLRI - Barge bilge water study
USCOE - Data – river traffic, insights
USCOE - Diversion Reports – (i.e. Ty)
USCOE - dredging project history and plans
USCOE - Telemetry data – movement of fish in CAWS
USCOE, IDNR - NEPA documents for Rotenone applications, and for Electric Barrier(s)
USDOT - Possible study associated with the movement of goods throughout Great Lakes
USEPA - Chemical water quality: emerging contaminants data
USFWS - Doug Hobbs; Sport Fishing Boating Partnership Council Coordinator; U.S. Fish and Wildlife Service
USGS - <a href="http://il.water.usgs.gov/data/cwo/">http://il.water.usgs.gov/data/cwo/</a> Chicago Water Way link
USGS - Multi-beam echosounder data was collected (in cooperation with the University of Illinois-Dept of Civil and Environmental Engineering) for approximately 40 + miles of the CAWS and is currently being processed and reviewed
USGS - Outline of available data sources prepared by Jim Duncker
USGS – Ryan Jackson’s 3D work on fractures in CSSC canal wall
USGS - Single-beam echo-sounder data was collected for most of the CAWS with the exception of the Cal-Sag Channel for hydraulic modeling of the waterway (in cooperation with the MWRDGC and U. of Illinois).
USGS, MWRD, EPA, IPCB R08-09 (UAA), IEPA (industrial permits),IL Chamber, USCOE
Water Taxi Data: Carol Ross Barney
Wateriders is Kayak place on the Chicago River. This is at 600W Chicago Ave.

<http://www.wateriders.com/contact-and-directions/>

Watershed model – North Branch Chicago River, Little Calumet River, Cal-Sag

Weaver Booz – MDW airport stormwater mgt and urban insights into river front uses

### **B3. CHARRETTE MATERIALS**

- CHARRETTE I PACKET 3-17-11
- CHARRETTE I SUMMARY 3-18-11
- CHARRETTE II SUMMARY 4-22-11



**Charrette 1 GOALS:** (1) Filter the World of possible locations into five locations, (2) organize locations into 5 ensembles, (3) define various barrier technologies (4) prepare a list of mitigating strategies for consideration.

**Charrette 2 GOALS:** Select three ensembles for RAPS analysis (plus baseline), develop mitigation strategy for three complete Options.

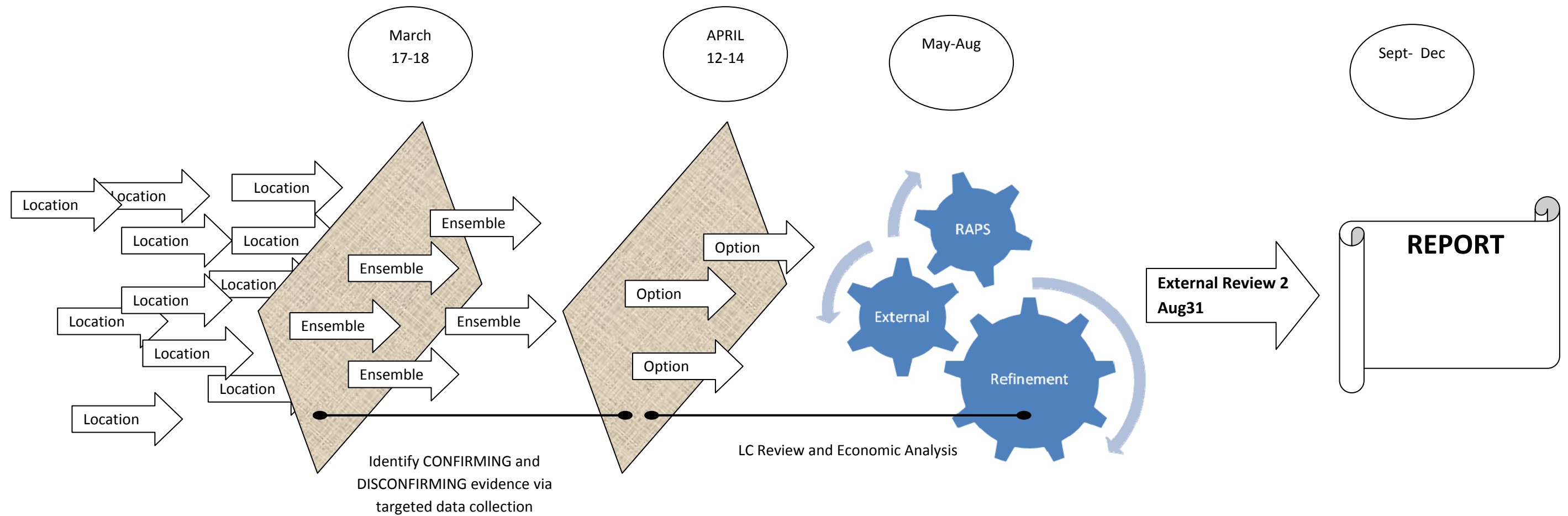

Agenda Item	Time	Day - Time	Lead
<b>Project Timeline and Charrette Process</b>		R 10:00- 10:30	Scott
Goals	10 min		Pete
Framework – tree and mitigation plot	15 min		
<b>Develop Common Understanding</b>		R 10:30 – 12:30	
Hydro Review	30 min		Pete / Irwin
Basemap Review	30 min		
Barge-Navigation update	30 min		
<b>Workbook Option Development</b>		R 12:30-happyhour	Group
Review Workbook	10 min		
Location Scoring	60		
Ensemble Scoring	60		
Brainstorm BT	60		
Reconsider / Reflect	30		
Brainstorm Mitigation	30		
<b>Break out</b>		F8-9 AM	Team leaders
Dig deeper	30 min		
Record data needs / key questions	30 min		
<b>Define Dirty Dozen</b>		F 9:00 -2:30 PM	Group
Report key items from break out	1 hr		
Critical Review of best ensembles to date	1 hr		
Define and record the final elements	1 hr		
Produce work sheet for dirty dozen	1.5 hr		
Review and record winning elements	1 hr		
<b>Brainstorm/review mitigating options</b>		2:30-closing	Team Leaders

## Decision Tree

**Ensemble:** selected set of locations to construct barrier

**Option:** Ensemble + Site Specific Barrier Technology + Suite of Mitigation Strategies

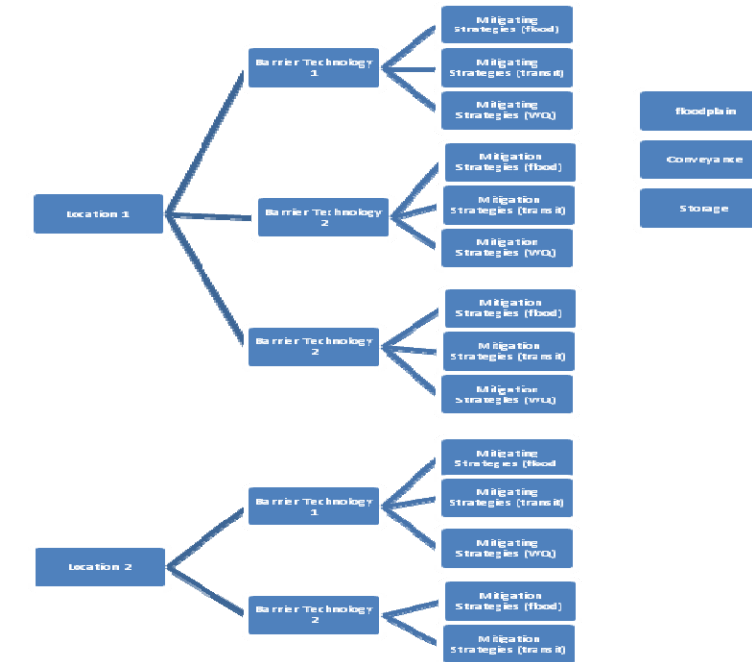

## Stormwater Mitigation Needs

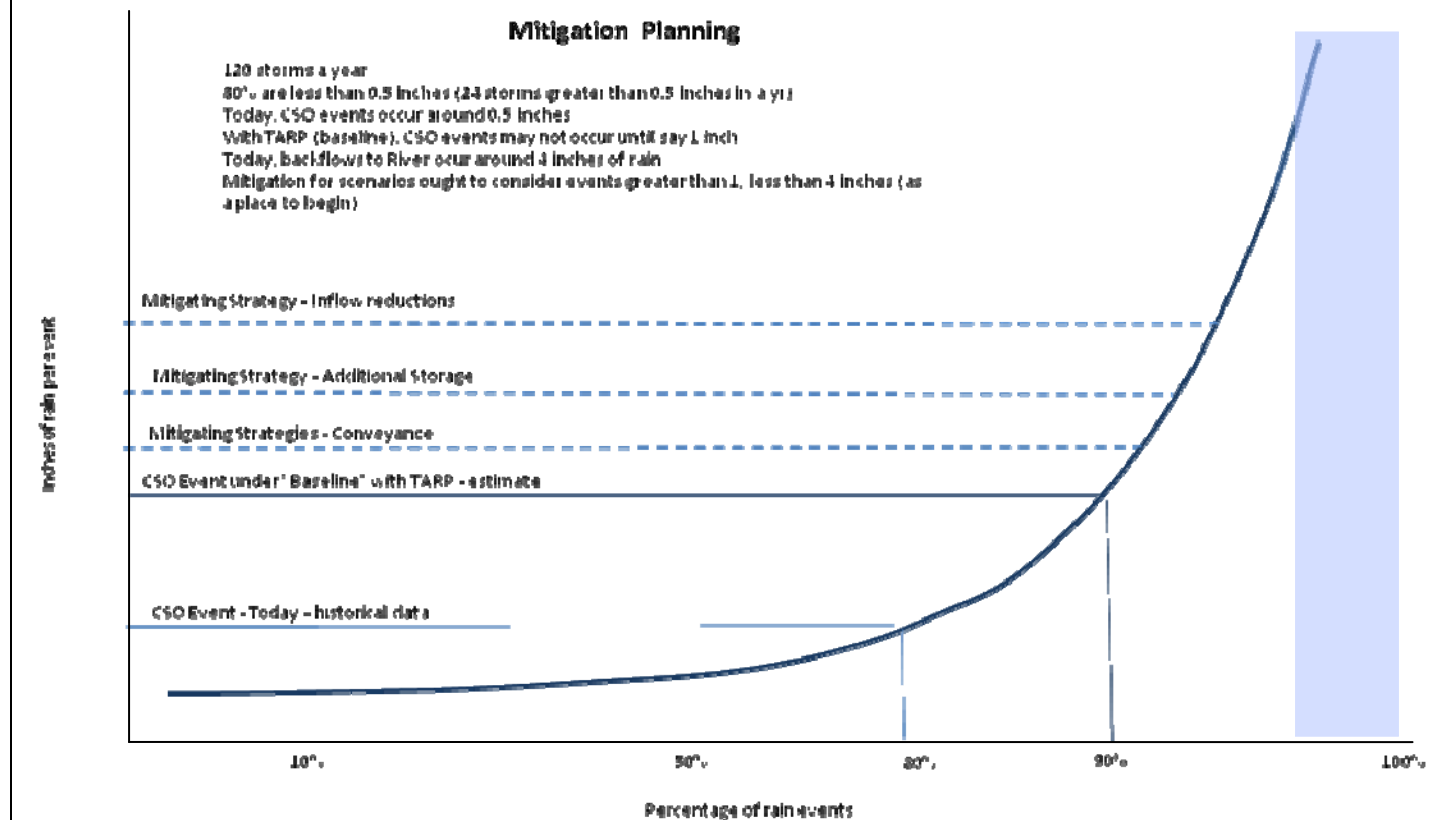



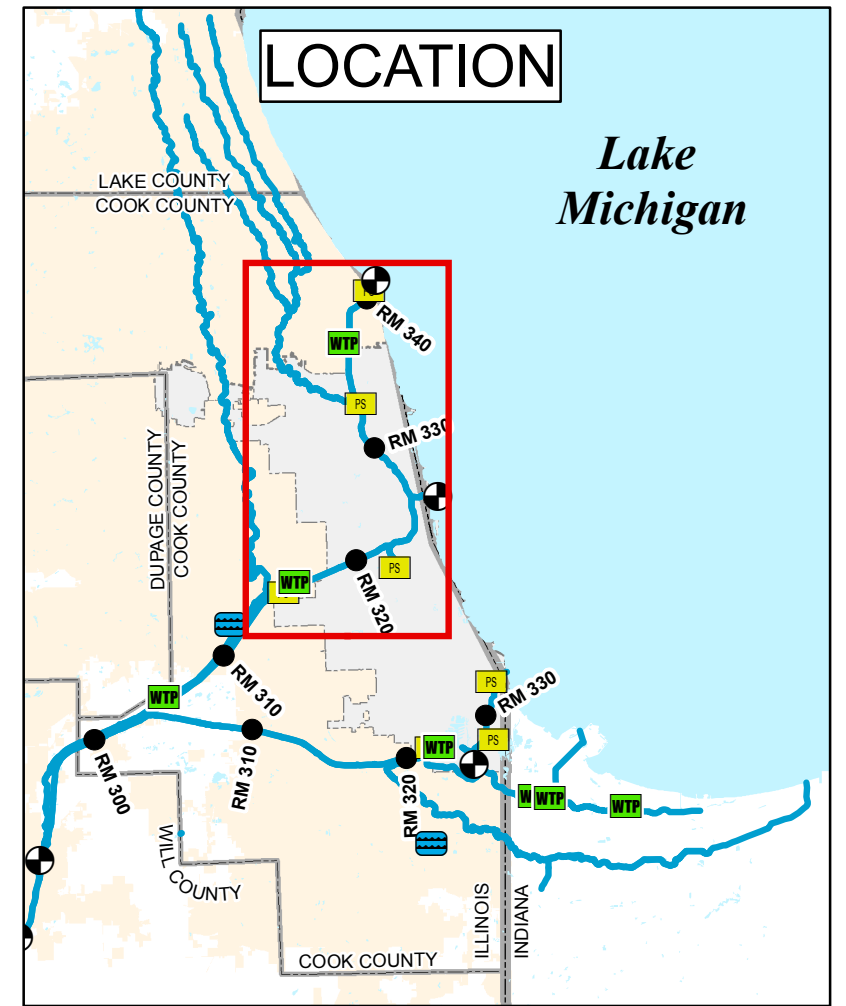
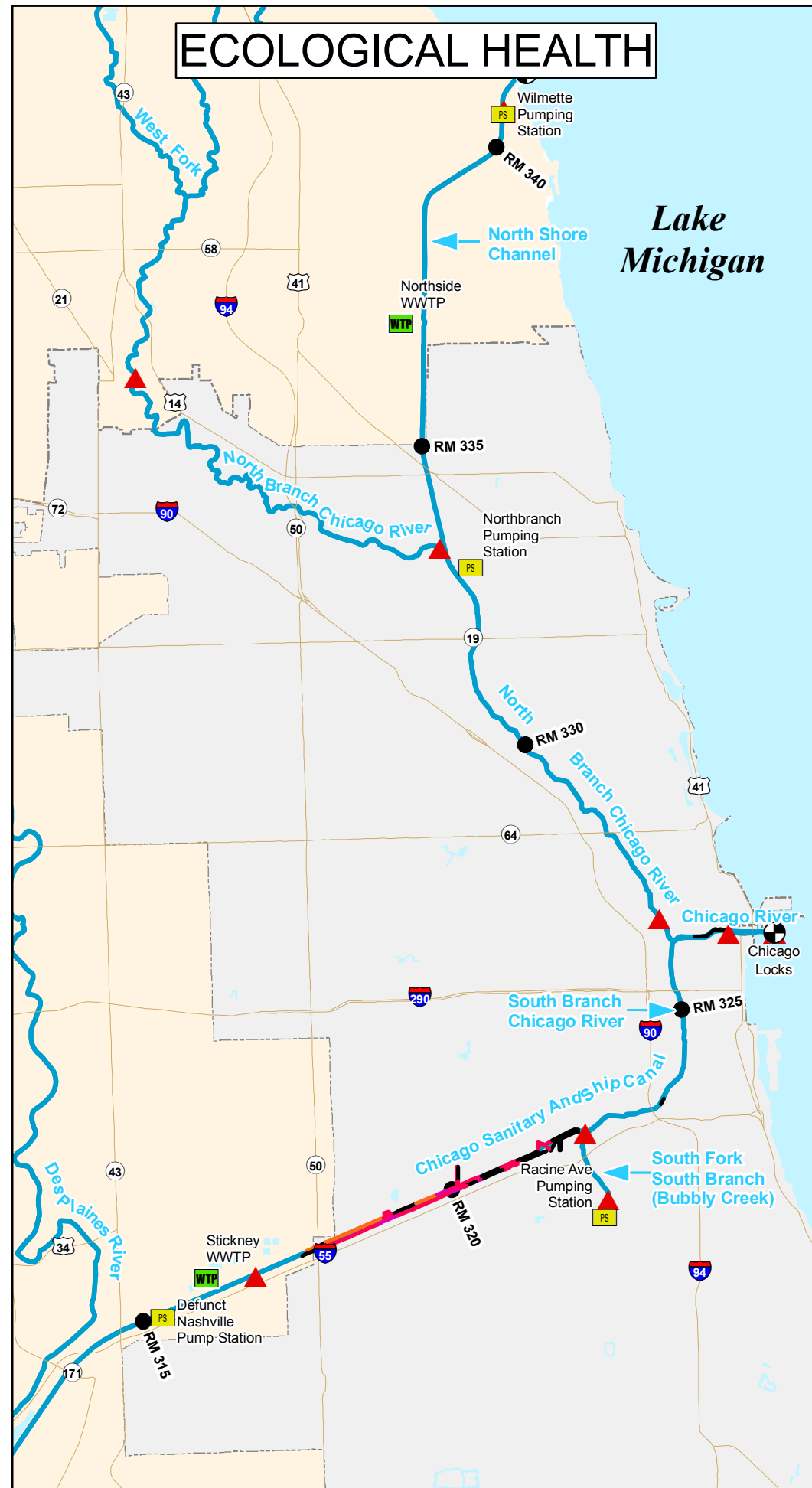
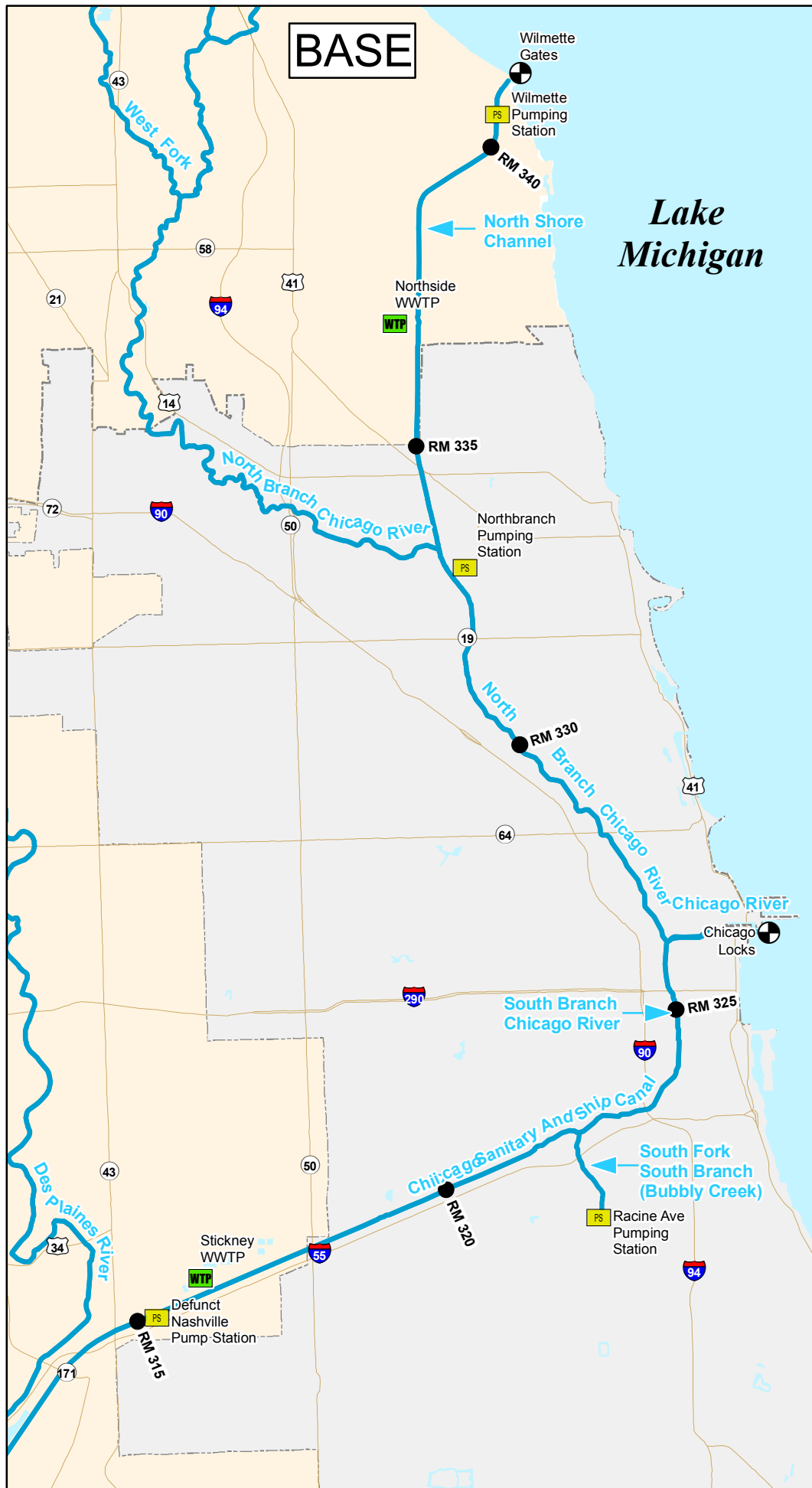

- |  |                   |                    |  |               |
|--|-------------------|--------------------|--|---------------|
|  | Controlling Works | <b>Bank Survey</b> |  | Not available |
|  | Pumping Station   |                    |  | good          |
|  | WWTP              |                    |  | poor          |
|  | Reservoir         |                    |  | failed        |
|  | USGS Gage         |                    |  |               |
|  | City of Chicago   |                    |  |               |

**HDR**

**BASEMAP: Upper CAWS**

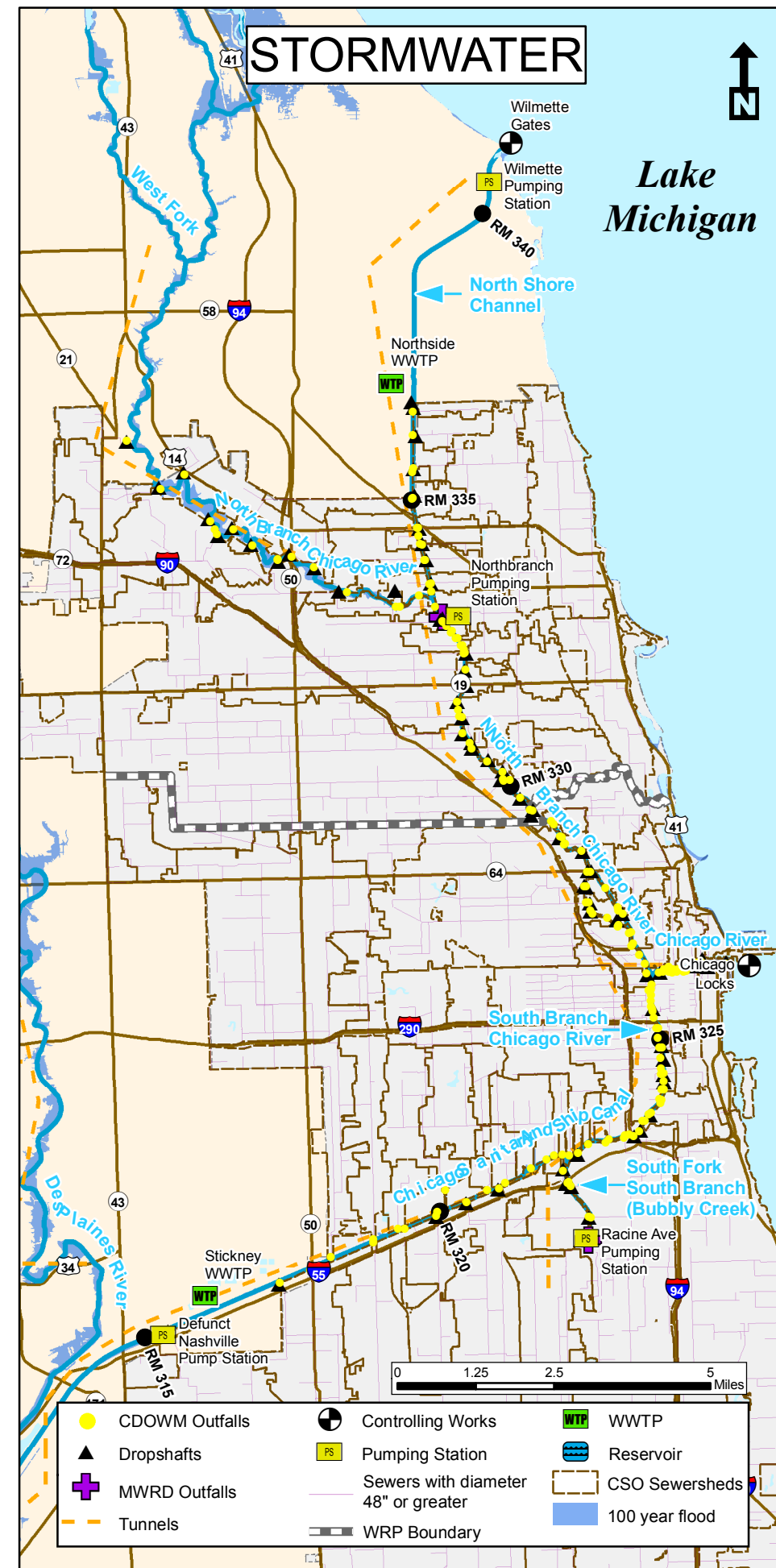
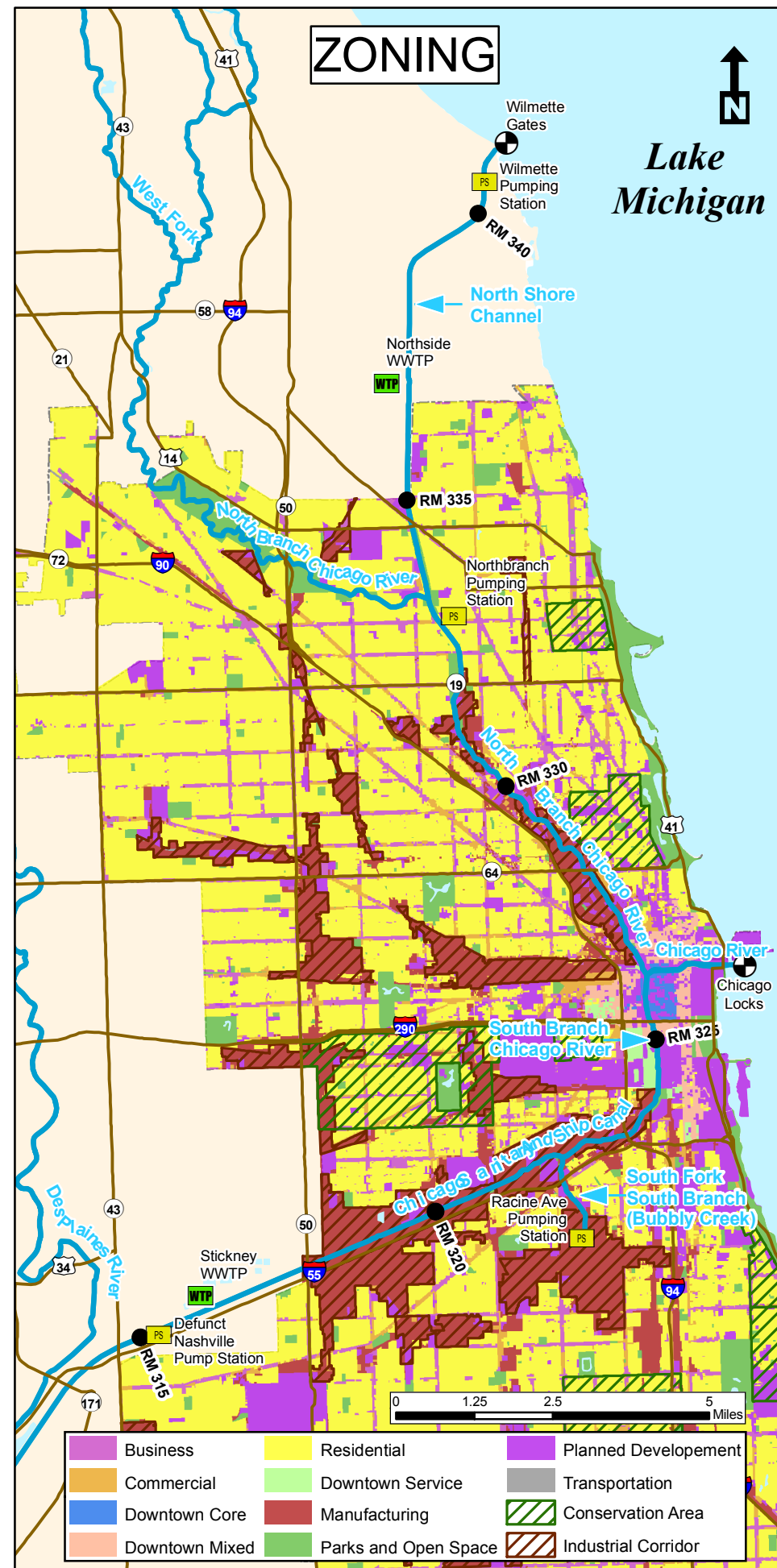
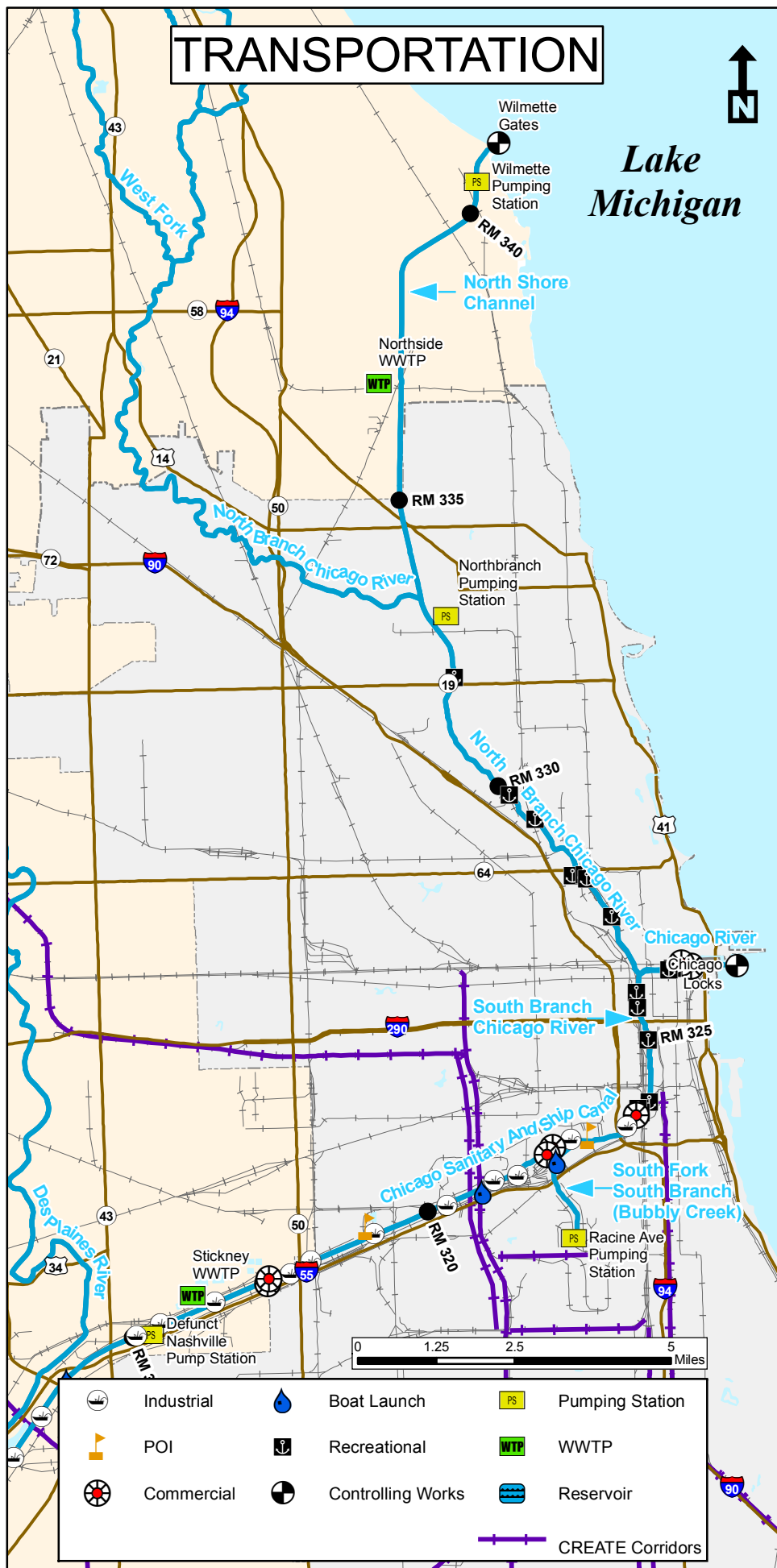

**BASEMAP: Upper CAWS**



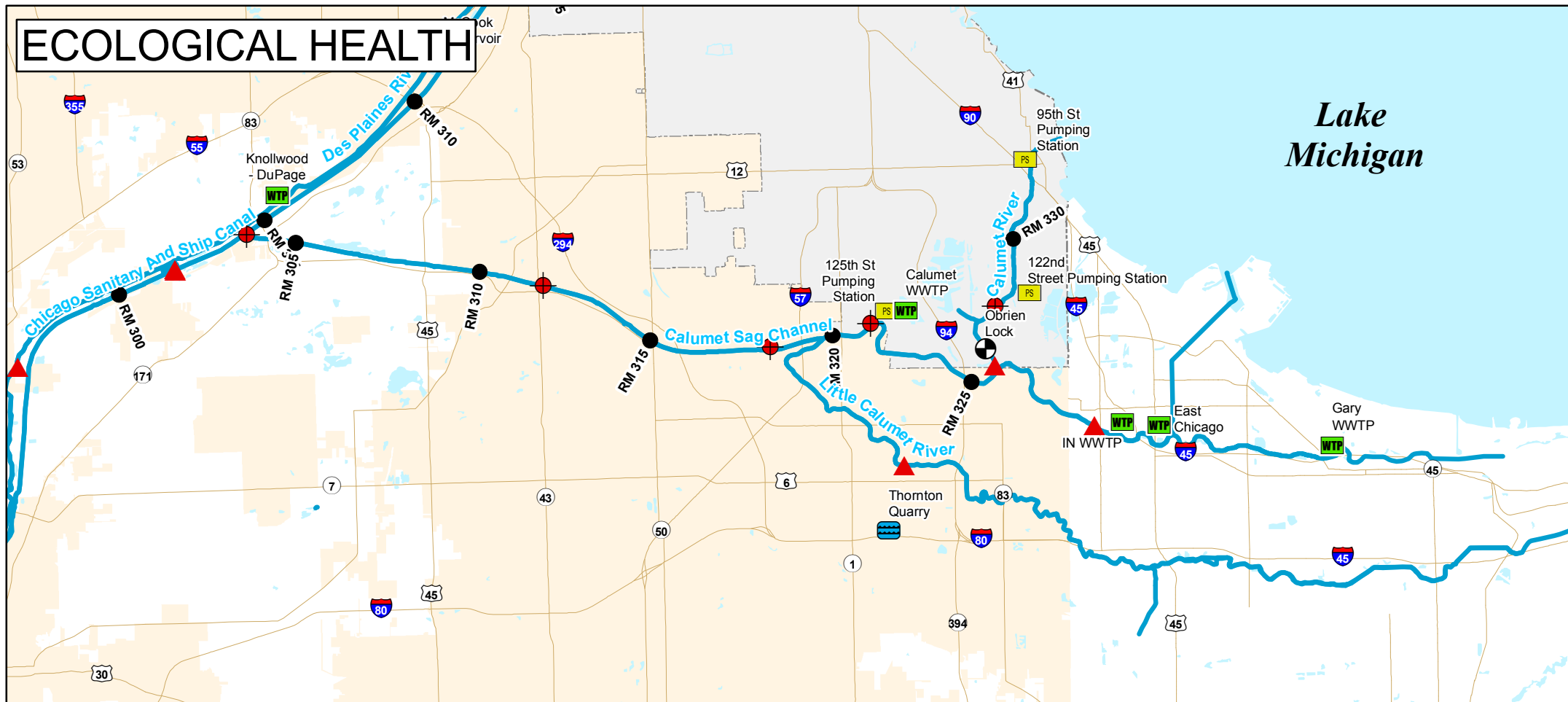
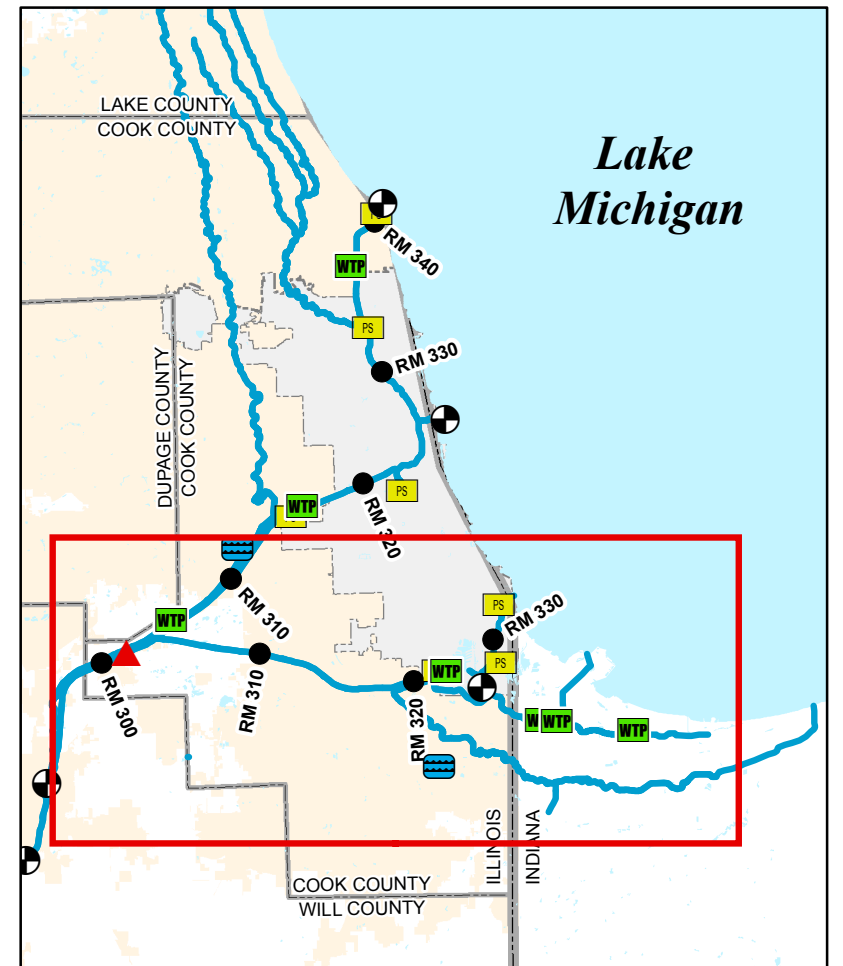
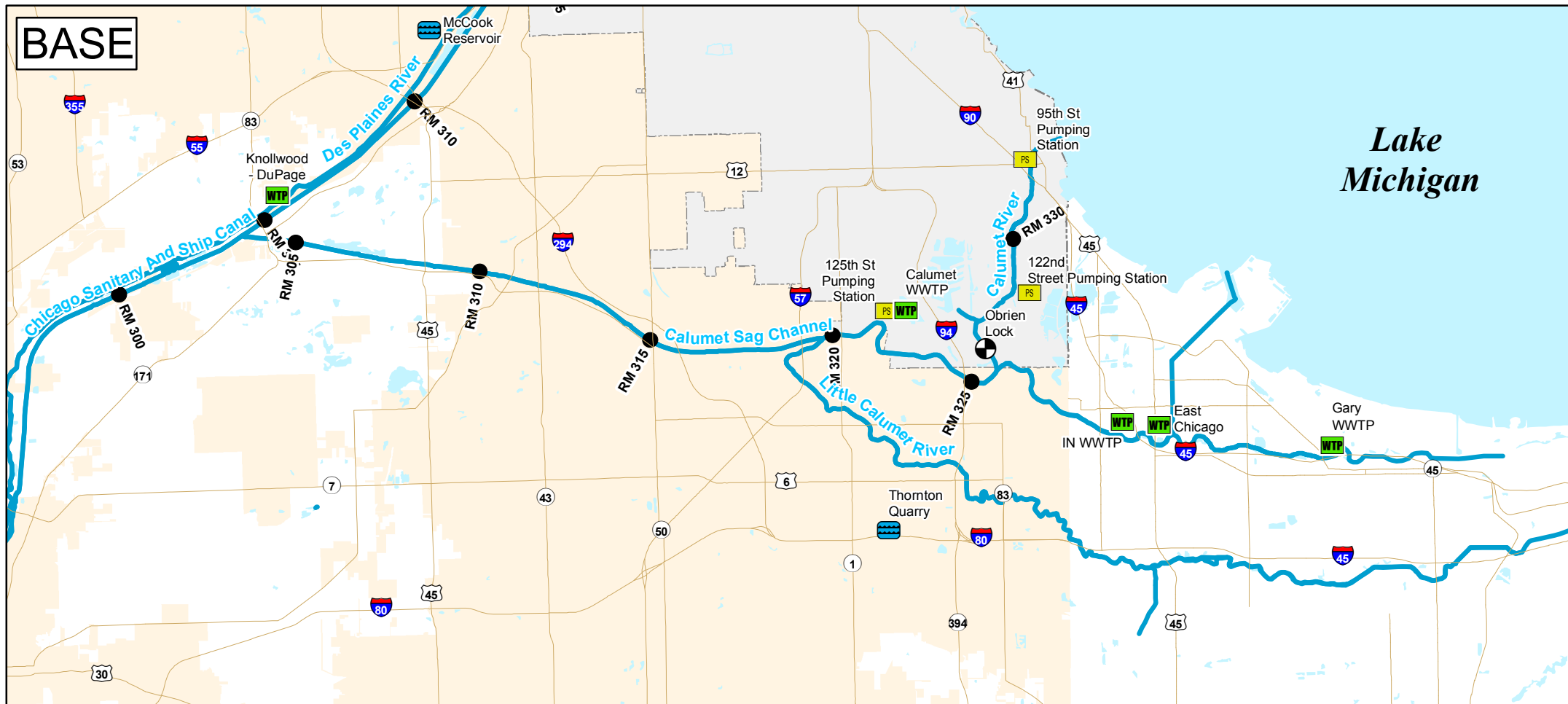

- |  |                       |                    |
|--|-----------------------|--------------------|
|  | Supplemental Aeration | <b>Bank Survey</b> |
|  | Controlling Works     | Not available      |
|  | Pumping Station       | new                |
|  | WWTP                  | good               |
|  | Reservoir             | fair               |
|  | USGS Gage             | poor               |
|  | City of Chicago       | failed             |

**HDR**

**BASEMAP: Lower CAWS**

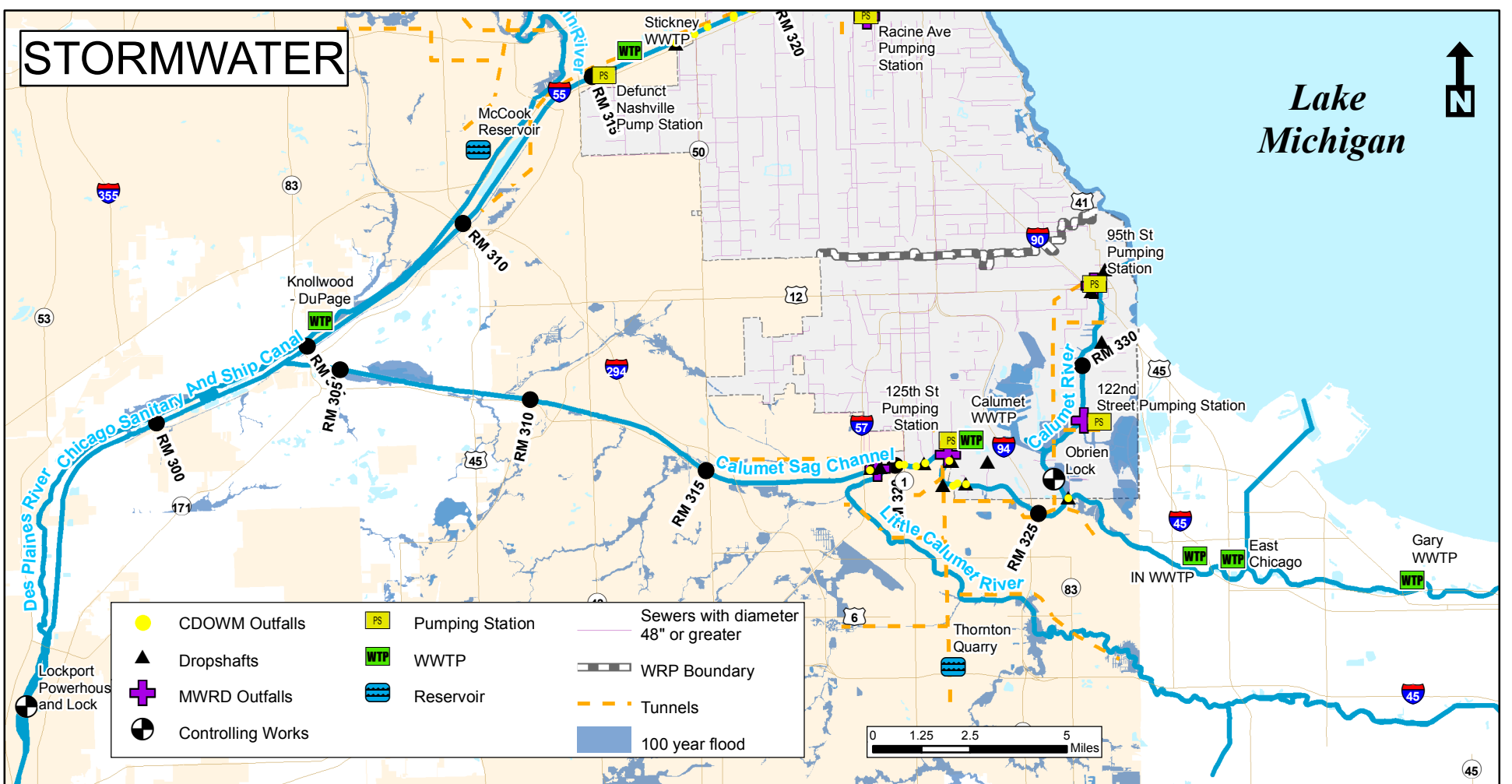
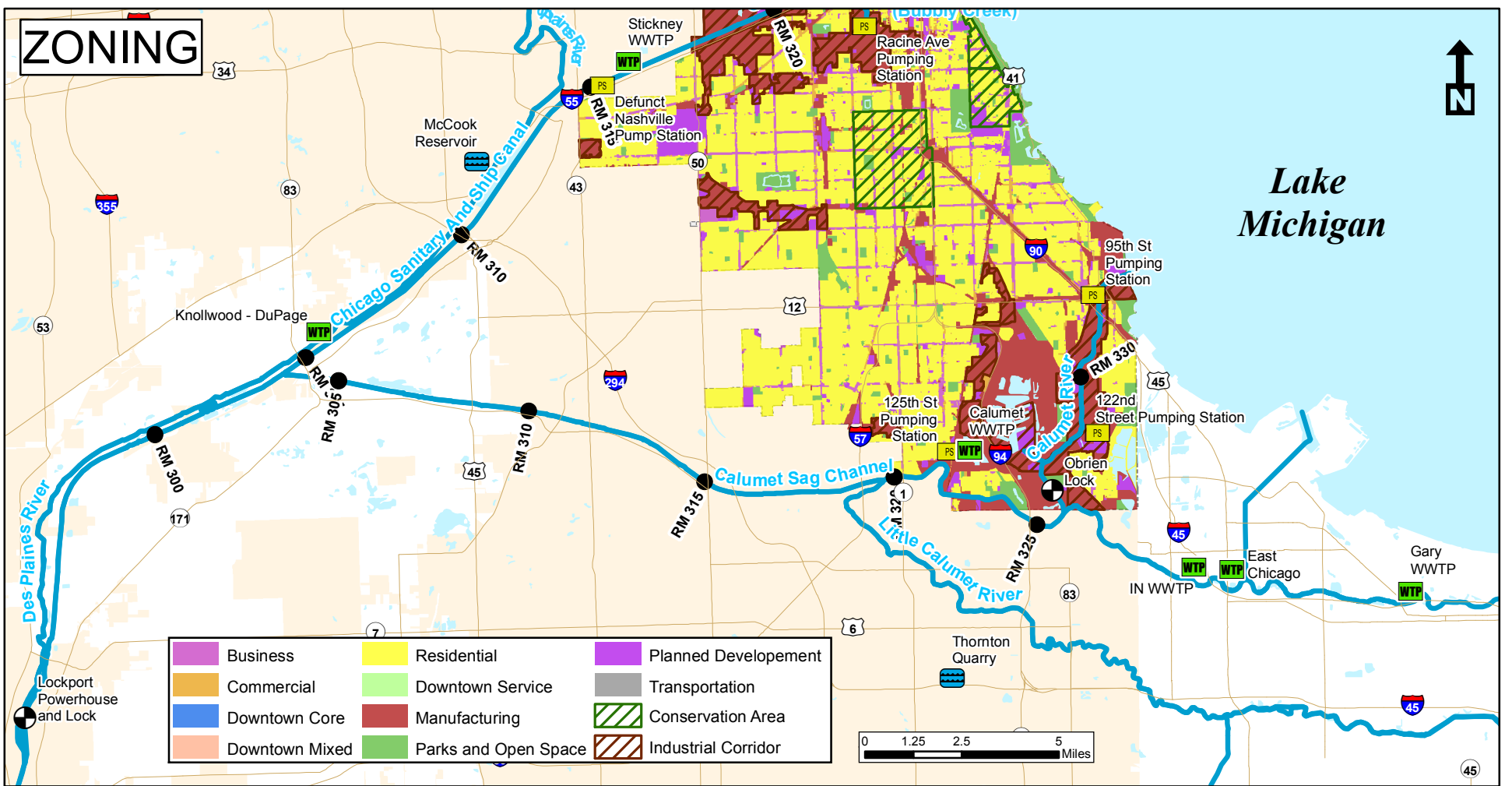
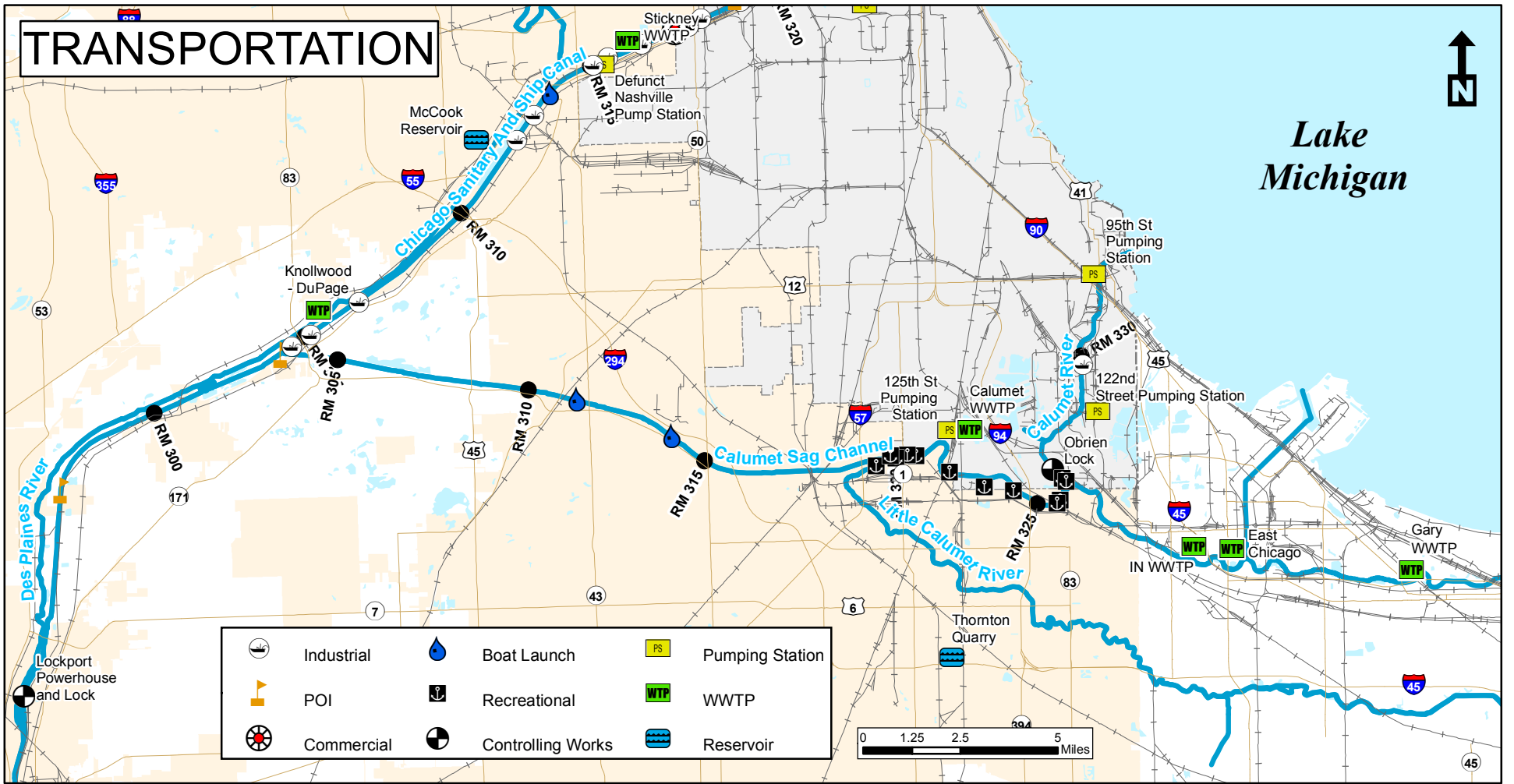

BASEMAP: Lower CAWS



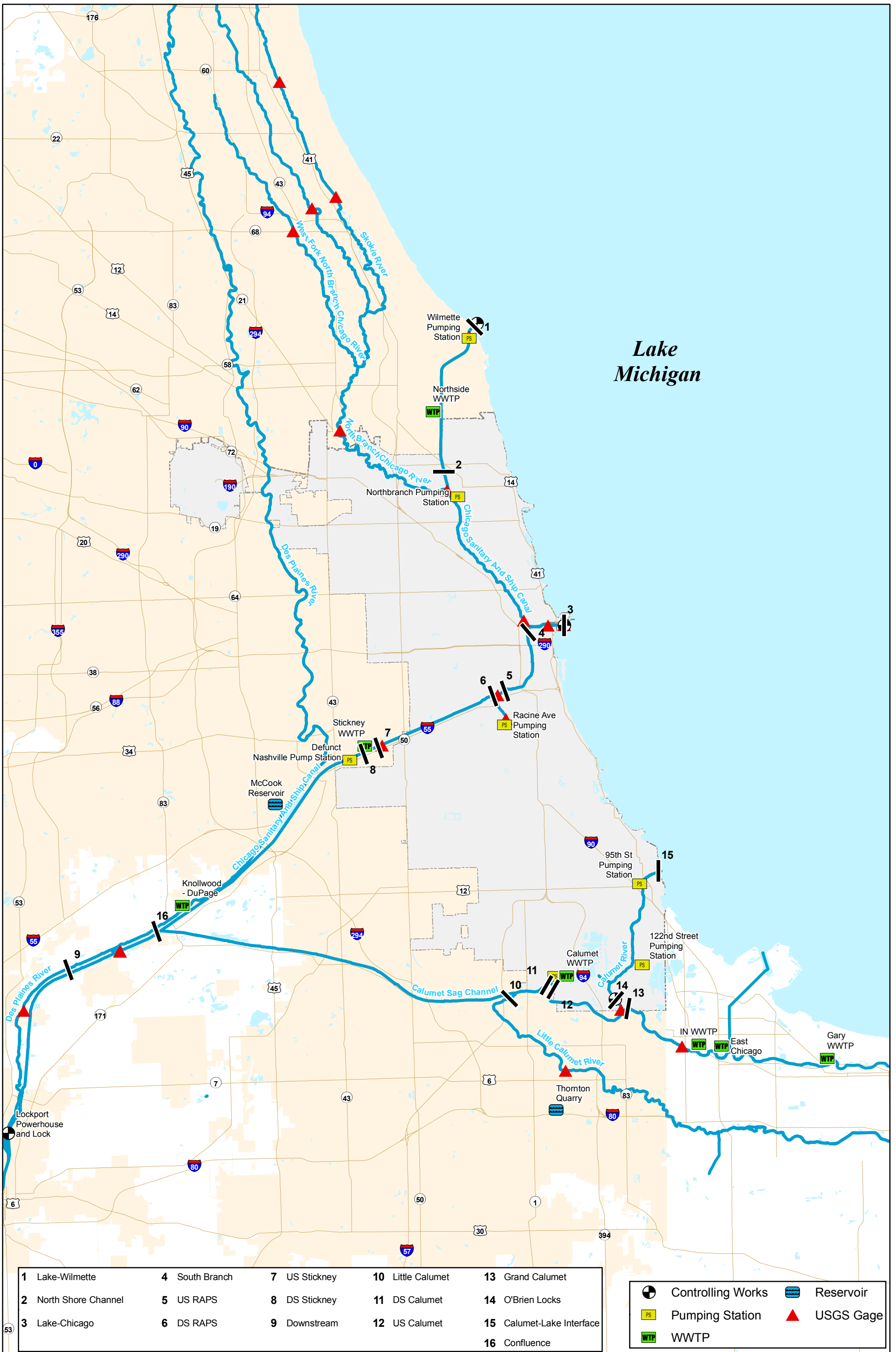

# POSSIBLE BARRIER LOCATIONS

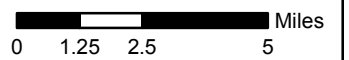

Stormwater Data

WWTP NAME	Receiveing_water	Design Avg Flow (DAF) MGD	Design Max Flow (DMF) MGD	Treatment	Rivermile outfall
Northside_Plant_WWTP	NSC	245.5	333	2ndary, act sludge	336.9
Stickney_WWTP	SSC	786.9	1,200	2ndary, act sludge	315.5
Calumet_WWTP	Little Calumet	286.6	354	2ndary, act sludge	321.4
Lemont_WWTP	SSC	2.5	2.3	2ndary, act sludge	300.6

Reservoirs	Capacity
McCook	10 BG
Thornton	4.8*

\*Tarp volume-less overbank flooding capture

Pump Station	Receiving water	Annual Avg freq (2000-2010)	Annual Average discharge MG	Max discharge MG	Rivermile outfall
122 <sup>nd</sup> Street Pumping Station	Calumet River	1	1.3	4.3	
125 <sup>th</sup> St Pumping Station	Little Cal	6	127.8	800.9	321.4
95 <sup>th</sup> St Pumping Station	Calumet River	2	42.4	136.9	
Northbranch Pumping Station	NBCR	15	130.2	1348.9	333.1
Racine Ave Pumping Station	SFSBCR	15	401.2	4018.6	321.7

LM Control Direct Diversion	2006 Direct Diversions MGD	2007 Direct Diversions MGD	Average MGD	Control Structures –BACK FLOWS	10 yr AVG backflow MG	10 yr MAX backflow MG	annual prob backflow to lake
Wilmette	31	21	26	Wilmette	449	2942	0.75
Chicago	117	128	122	Chicago	1960	5785	0.4
OBrien	82	84	83	Obrien	1346	2669	0.2
Lockport				Lockport	0	0	0
Total direct	230	233	232		3755	11396	

	Authorized Allocation	2004		2005		2006		2007	
		Average cfs	percent	Average cfs	percent	Average cfs	percent	Average cfs	percent
LM pumpage by state	1530	1414.1	55%	1496.5	60%	1383.2	54%	1380.9	47%
Runoff diverted	800	832.6	32%	693.2	28%	807.3	32%	1194.8	41%
Total direct	435	338.2	13%	311.6	12%	355.7	14%	361.6	12%
lockages	100	36.4	11%	38.8	12%	37.6	11%	30.4	8%
Leakages	50	21.4	6%	23.6	8%	24.9	7%	23.4	6%
Navigation Makeup	35	27.6	8%	19.7	6%	25.7	7%	59.1	16%
Discretionary	270	252.8	75%	229.3	74%	267.4	75%	248.4	69%
	<b>2765</b>	<b>2584.9</b>		<b>2501.3</b>		<b>2546.2</b>		<b>2937.3</b>	

	Authorized Allocation	2004-2007	
		Average cfs	percent
LM pumpage by state	1530	1419	54%
Runoff diverted	800	882	33%
Total direct	435	342	13%
lockages	100	36	10%
Leakages	50	23	7%
Navigation Makeup	35	33	10%
Discretionary	270	249	73%
	<b>2765</b>	<b>2642.425</b>	



Barge POI	River mile	Phone	Waterway	Bargeperday
Corp Dock	333.3			
NASCO (North American Stevdoring)	333	773-734-4885		
Metal Management	332.7	773-251-2915		
LUHR BROS	332.5	618-281-4106		
North American Salt	332.5	773-978-7258		
Great Lakes Towing Co.	332.4	773-768-6152		
Crowley Yacht Yard	332.3	773-221-9990		
Kindra Lake Towing, LP	331.9	773-721-1180		
Morton Salt	331.5	708-758-5800		
S H Bell	331.4	773-375-1010		
KCBX Terminals Co.	331.3	773-375-3700		
Beelman Trucking	331.1	219-989-0496		
ELG	331.1	773-374-1500		
Carmeuse	330.9	773-221-9400		
Beemsterboer	330.9	773-721-9600		
Holcim Cement	331.3	773-768-1717		
Chicago Dry Dock	331	773-721-3100		
Cronimet	330.7	773-933-2900		
Bayou Steel	330.6	773-768-0177		
DTE Coal Services Inc.	330.3	773-913-5460		
Reserve Marine	329.5	773-382-0115		
Horsehead Resource Development Co.	329.5	773-933-9260		
Nidera	329.3	773-375-1830		
Chicago Port RR	329	773-375-7225		
Cargill Salt	328.5	773-374-3808		
Kinder Morgan (Arrow Terminal- River)	328.3	773-646-8000		
Lafarge Cement Corp.	327.1	773-640-9406		
Kinder Morgan (Arrow Terminal- Lake Cal)	327.1- 327.3	773-646-8000	Lake Calumet	
St. Mary's Cement	327.1- 327.3	773-995-5100	Lake Calumet	
Kinder Morgan (Stolt)	327.1- 327.3	773-646-4440	Lake Calumet	
Emesco	327.1- 327.3	773-646-2100	Lake Calumet	
Maryland Pig	327.1- 327.3	773-646-2080	Lake Calumet	
Metal Management	327.1- 327.3	773-251-2915	Lake Calumet	
Reserve Marine- Sheds	327.1- 327.3	773-382-0115	Lake Calumet	
<b>Key Industrial Water Users</b>	<b>Waterway</b>	<b>Volume withdrawl</b>	<b>Volume Disharge to water</b>	<b>River Mile</b>
Will County Generating Station				296
<a href="#">Citgo Petroleum Corporation, Lemont, IL</a>				298
Argonne Intake				302.3
Crawford Generating Station				318.5
Fisk Generating Station				322
Cornstarch Products				

USGS DATA

Number	Station Name	Period of record (daily discharge)	Comments	Min Q (cfs)	Max Q (cfs)	Mean Q (cfs)	Min Stage (feet)	Max Stage (feet)
5536000	NORTH BRANCH CHICAGO RIVER AT NILES, IL	10/01/1950-present	Minimum flow is a mean daily value.	0.1	3340	107		
5536101	NORTH SHORE CHANNEL AT WILMETTE, IL	10/01/1996 -09/30/2003	Max discharge is a mean daily discharge estimated by regression.	-58	245e	38		
5536105	NB CHICAGO RIVER AT ALBANY AVE AT CHICAGO, IL	10/01/1989 - present		3.6	3580	143		
5536118	NB CHICAGO RIVER AT GRAND AVE AT CHICAGO, IL	07/02/2002-present		-1850	14100	572		
5536123	CHICAGO RIVER AT COLUMBUS DRIVE AT CHICAGO, IL	10/01/1996 – 09/30/2006	Minimum discharge is a mean daily discharge.	-2540	1240	198		
Number	Station Name	Period of record	Comments	Min Q (cfs)	Max Q (cfs)	Mean Q (cfs)	Min Stage (feet)	Max Stage (feet)
5536358	CALUMET R. BELOW O'BRIEN LOCK AND DAM AT CHICAGO, IL	10/01/1996-03/30/2005	Max discharge is an estimated mean daily value.	-769	1069e	142		
5536290	LITTLE CALUMET RIVER AT S. HOLLAND, IL	10/01/1947- present		7.9	4400	190		
5536357	GRAND CALUMET R. AT HOHMAN AVE AT HAMMOND, IN	10/01/1991-present		0.00	701	25		
5536131	SFSBR CHICAGO RIVER (BUBBLY CREEK) AT 36 <sup>TH</sup> ST AT CHICAGO, IL	07/26/2009-09/30/2010	(approximate dates_side-looking ADCP velocity data).	NA	NA	NA		
5536133	SFSBR CHICAGO RIVER (BUBBLY CREEK) AT I-55 AT CHICAGO, IL	04/07/2010-09/30/2010	(approximate dates_side-looking ADCP velocity data).	NA	NA	NA		
5536995	CSSC AT ROMEOVILLE	10/01/1984-09/30/2005		-1918	19448	3297		
5536890	CSSC NEAR LEMONT, IL	12/07/2004-present	Additional temperature and conductivity data available also.	-2104	20053	2962		
5536140	CSSC AT STICKNEY, IL	10/01/2007-present	Discharge not available at this time--only stage					
Number	Station Name	Period of record	Comments	Min Q (cfs)	Max Q (cfs)	Mean Q (cfs)	Min Stage (feet)	Max Stage (feet)
5536121	CHICAGO RIVER AT CHICAGO LOCK AT CHICAGO, IL	08/01/1997-present	Min/max stage readings only. (Chicago City Datum)	NA	NA	NA	-3.27	4.14
4087440	LAKE MICHIGAN AT CHICAGO LOCK	08/01/1997-present (stage only)	Min/max stage readings only. (Chicago City Datum)-affected by wave action.	NA	NA	NA	-3.79	3.84

Plan

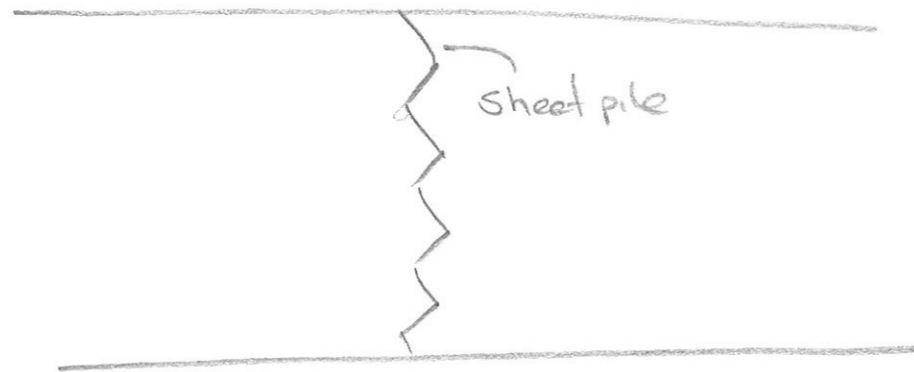

Pros:

- Cheap
- fast (could be a temporary action - immediate)

Profile

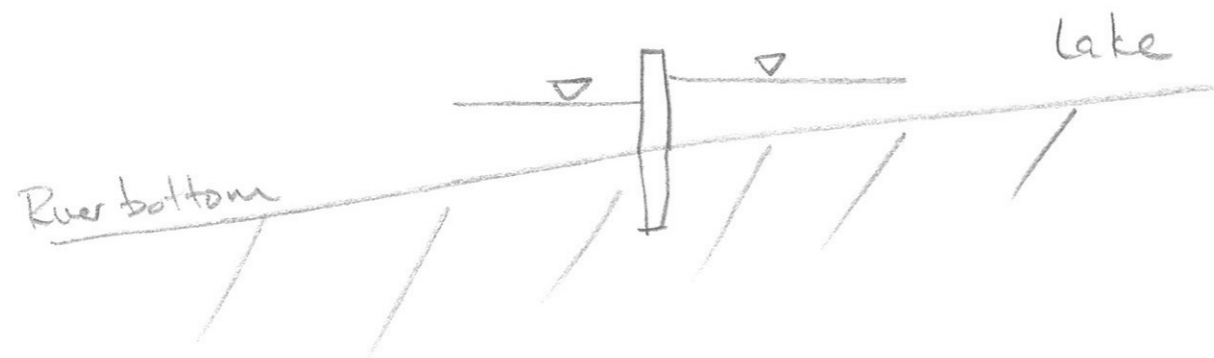

Cons:

- lack of land use opportunities
- limited barrier effectiveness
- leaky

Cross Section

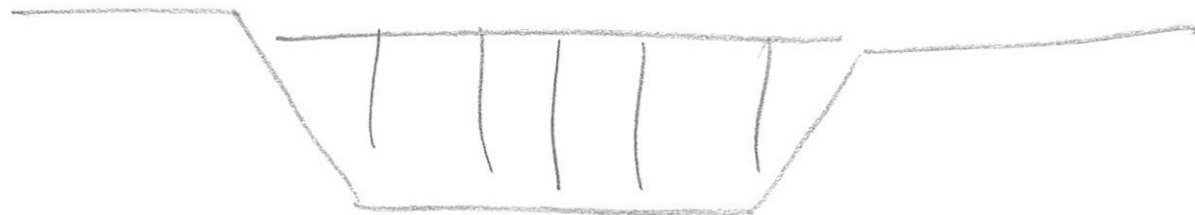

Key Elements:

Sheet pile driven to act as dam

Rationale:

Simplest barrier option

AIS Confidence: High Medium Low

Plan

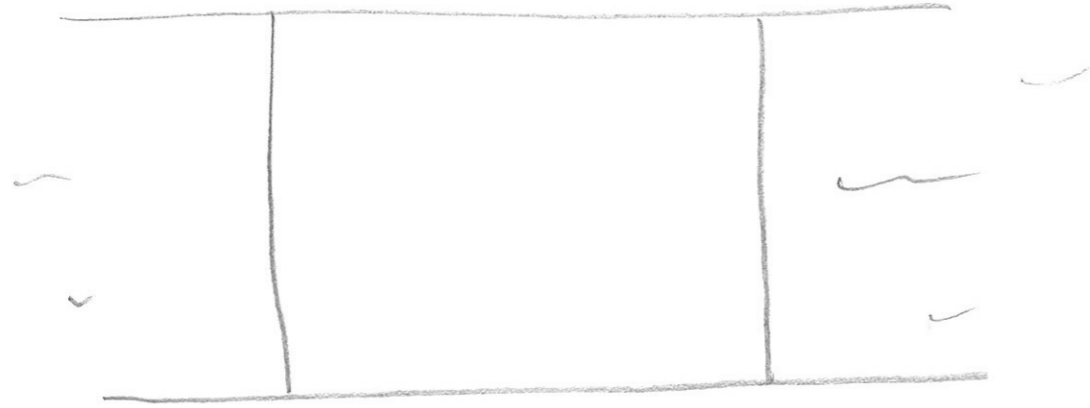

Profile

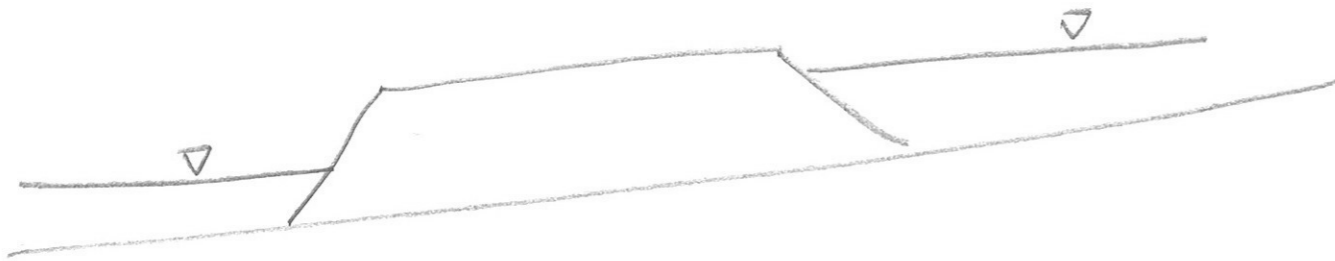

Cross Section

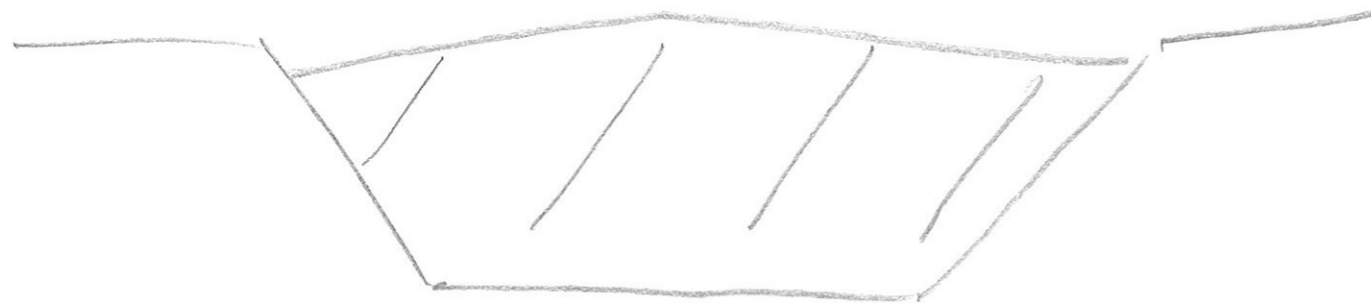

Pros:

- Creates land bridge opportunities
- Flexible options for land-use and adjacent lands
- Solid barrier which can be as long / large as needed.

Cons:

Key Elements:

- develop a land bridge which can be developed or created to serve different purposes.

Rationale:

maximize land use opportunities with high AIS effectiveness

AIS Confidence: High Medium Low

Plan

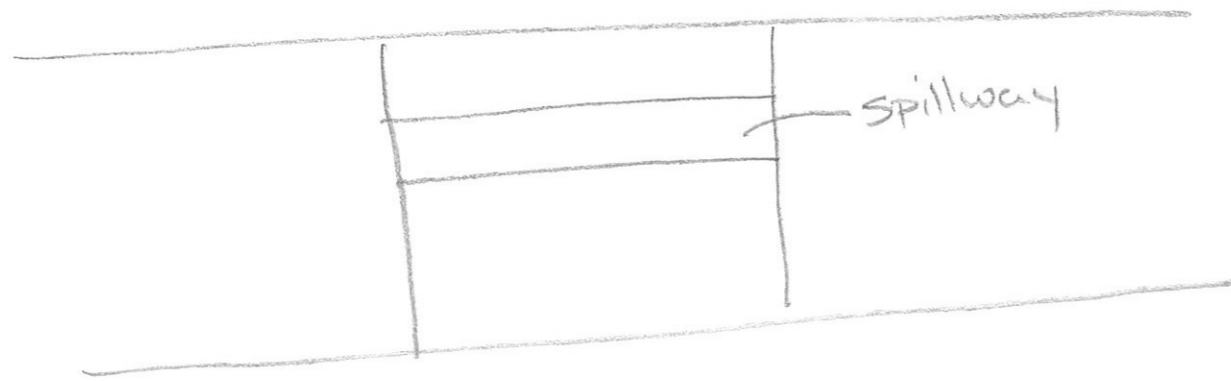

Profile

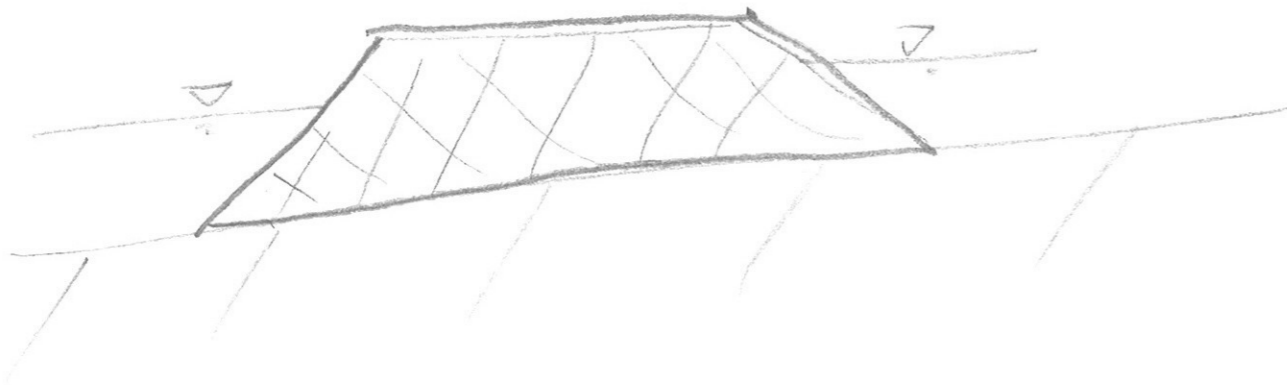

Cross Section



Pros:

- manages flood H<sub>2</sub>O
- possible use of spillway to generate some WQ flows

Cons:

- Breaks the hydraulic divide during storm event
- Impairs AIS benefits. - presents AIS risk

Key Elements:

Other mitigating strategies & location of this barrier determine size of spill way.

Rationale:

Benefits of land bridge opportunities while mitigating flooding

AIS Confidence: High Medium Low

**Plan**

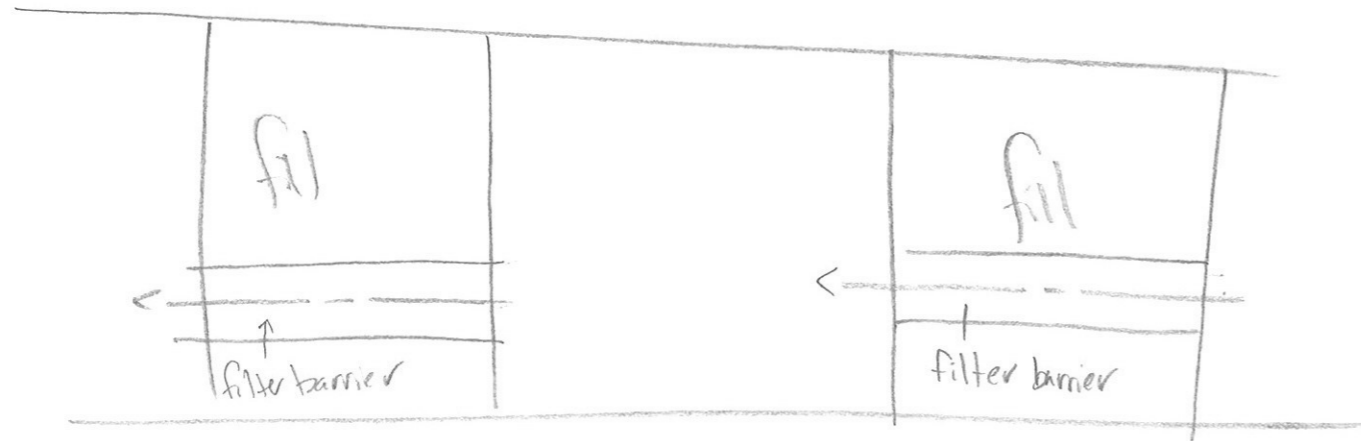

**Profile**

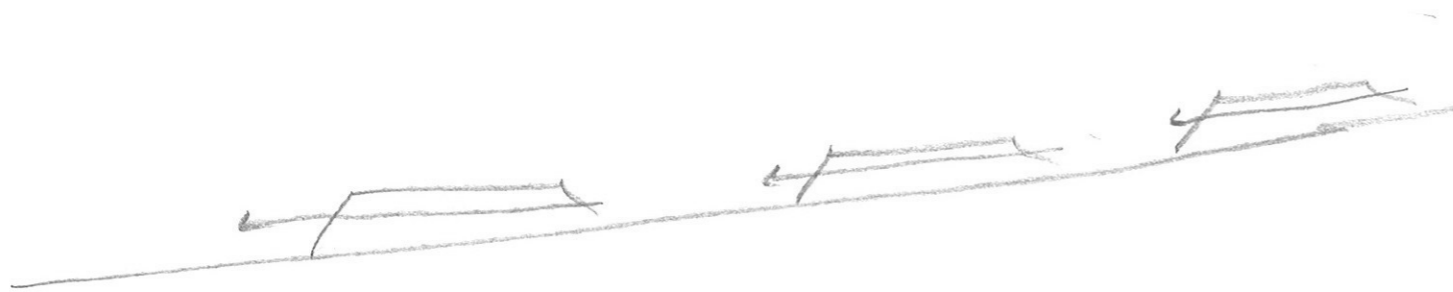

**Cross Section**



**Pros:**

- multiple points of landuse opportunity
- improved WQ
- improved flows, minor flooding relief
- flexible design options
- intermittent pools for appropriate use

**Cons:**

- Navigation hurdles
- passes H<sub>2</sub>O - breaks divide

**Key Elements:**

A series of filters that restricts AIS, yet passes H<sub>2</sub>O. ..Could be more than two barriers per "filter"

**Rationale:**

AIS Confidence:    **High**            **Medium**            **Low**



Plan

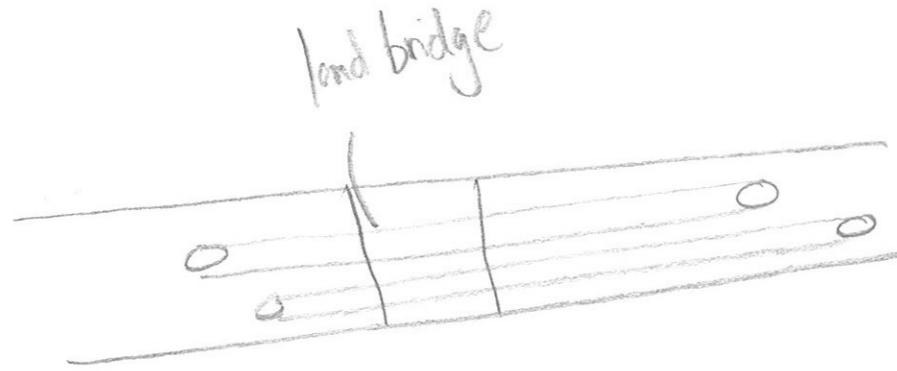

Profile

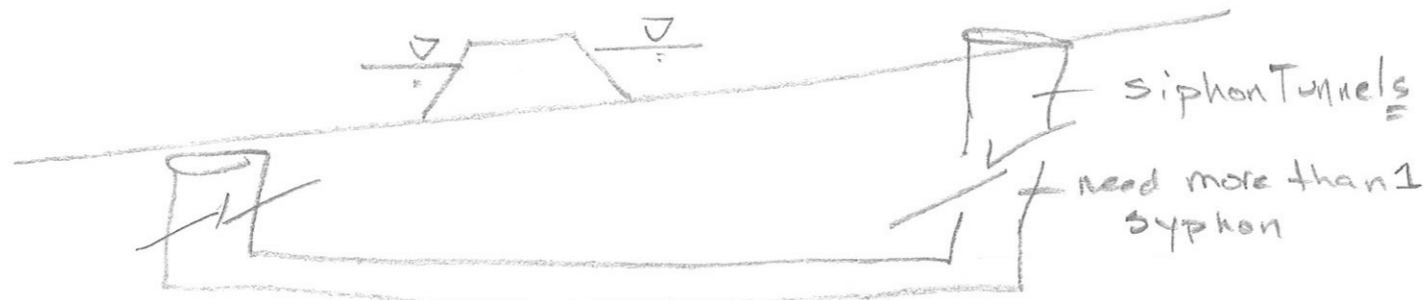

Cross Section

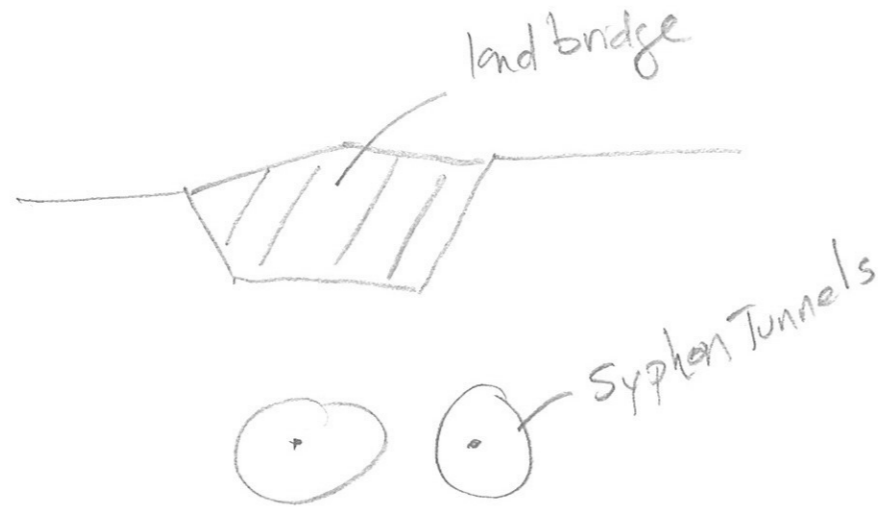

Pros:

- manage flood H<sub>2</sub>O
- manage WQ flows
- low energy
- AIS control structures confined space

Cons:

- Presents AIS risk GL to M1

Key Elements:

Battery of siphons allows you to pass H<sub>2</sub>O as needed to manage WQ & flooding. Tunnel would have high velocity flows, high pressure, and no habitat attractant, to AIS.

Rationale:

Will need to manage flows. This is a low energy option for moving H<sub>2</sub>O.

AIS Confidence: High Medium Low



<b>Ecology / WQ</b>	<b>Issue Mitigated</b>	<b>Benefit</b>	<b>Cons</b>	<b>Capital</b>
Permeable Barrier	create base flows	flow draws lake water like current discretionary flows	diversion and AIS concerns	MM
Riverbank restoration	increase habitat	more robust river system, cooling effect,		M
Aeration Infusion	increase DO	WQ improves in general, fish habitat improves	Artificial, costly, energy demanding	MM
Sediment removal	toxics	reduces risk of Lake contamination	activate and stir sediments	B
Re-Route facility flows (RAPS, Stickney)	WQ	Create flow to move water	complicating hydraulics.	
Strategic sewer separation	WQ - flow	Increase movement of backwaters	not so clean inflows, MS4 permit	MM



# Summary

March 18, 2011

The following is brief overview of the charrette held on March 17<sup>th</sup>-18<sup>th</sup> for the GLC/CI Separation Study:

- Reviewed charrette goals, project timeline, and decision framework
- Discussed CAWS system operations and usage regarding water quality, stormwater, and transportation (industrial/commercial shipping)
- Evaluated preliminary barrier locations (20)
  - Assessed general trendline (positive or negative) for the implications of each barrier location regarding ecological health, stormwater, transportation, and recreation
  - Documented key issues/comments
- Screened barrier locations based on preliminary barrier location assessments and developed list of possible barrier pairings for upper and lower CAWS
- Evaluated upper and lower CAWS barrier pairings using same methodology as individual locations
- Screened barrier pairings based on assessments → resulted in 4 barrier ensembles (combinations of barrier locations to provide separation of all CAWS waterways)
- Developed and evaluated barrier types (technologies) for physical separation
  - Assessed pros, cons, and key elements for each type
  - Focused on impermeable barrier types and also documented potential permeable barrier types
- Preliminarily discussed potential mitigation strategies for barrier locations
- Identified data gaps and next steps for further evaluation of potential barrier locations and preparation for Charrette II





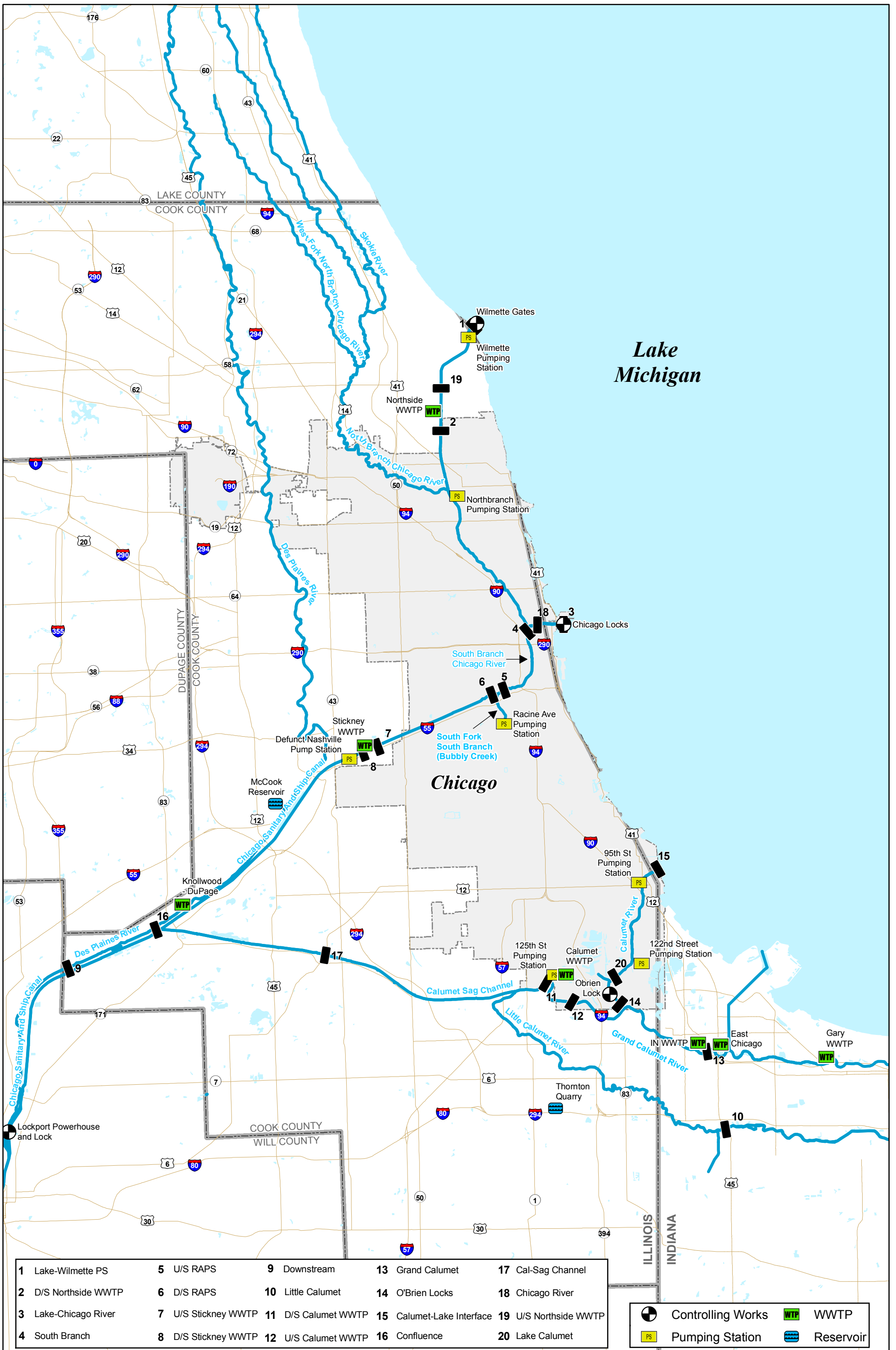

**PRELIMINARY BARRIER LOCATIONS**  
Charrette I - March 18, 2011

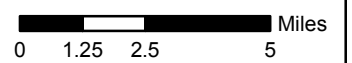

## Tabulation Table: Locations – Upper CAWS

Indicate +,0,- (trendline slope) and comment on the implications of the location and potential mitigation requirements.

Location	Eco Health (+,0,-)	Transportation (+,0,-)	Stormwater (+,0,-)	Recreation (+,0,-)	Total (+,0,-)	Comments on Key Elements
<b>1 Wilmette PS</b>	(-) No flow diversion; sediment issues	(0) No impact (already blocked by PS)	(-) No backflow to lake aggravates existing flooding	(0) Limited impact (already blocked by PS)	-2	Barrier location near upstream extent of TARP, so limited impact to CSOs; however, barrier would require mitigation for larger flood events due to removal of backflow to lake. Also, WQ issues in reach north of Northside WWTP would develop because of stagnation (no lake diversion)
<b>2 D/S Northside WWTP</b>	(-) Flow stagnation d/s of barrier (no source of flow)	(0) No impact (no industrial use in NSC)	(+) Reduction in volume	(-) Local population use of NSC would be eliminated	-1	CSO discharges to lake u/s; CSOs to dry ditch d/s of barrier Reduction in stormwater volume d/s of barrier by diverting CSOs u/s of barrier to lake, reducing flooding d/s
<b>3 Chicago Locks</b>	(-) Stagnation, DO issues in Chicago River w/o diversion	(-) Limited barge/industrial use	(-) No backflow (outlet) to lake	(-) Barrier to CAWS for commercial and private boats	-4	Lack of source water to mitigate stagnation and DO issues on Chicago River Significant mitigation required for increased flooding risk downtown Chicago
<b>4 Mouth of South Branch</b>	(-) Stagnation d/s of barrier; CSOs to lake	(-) Barrier to barge/industrial use	(-) No backflow (outlet) to lake	(+) River becomes lake (no locking needed)	-2	(0) u/s of barrier, WQ improves (lake quality) except CSO discharges; (-) D/S stagnation and DO issues (-) Increase flooding potential because RAPS would not have backflow outlet to lake
<b>5 U/S Racine Ave. PS (RAPS)</b>	(0) Stagnation both sides of barrier; no RAPS CSO to lake	(-) Barrier to barge/industrial use of CSSC	(-) No backflow (outlet) to lake	(0) Limited recreational use d/s of RAPS	-2	(0) dry weather stagnation issues both sides of barrier but no CSOs from RAPS to lake Barrier assumed to be u/s of Fisk power plant (barge access to d/s CSSC for coal would remain)
<b>6 U/S Racine Ave. PS (RAPS)</b>	(-) u/s CSOs to lake and d/s stagnation issues	(-) Barrier to barge/industrial use of CSSC	(-) Lose stormwater storage/conveyance in CAWS d/s	(0) Limited recreational use d/s of RAPS	-3	Lose access by barge for coal supply to Fisk power plant
<b>7 U/S Stickney WWTP</b>	(-) RAPS CSOs to lake and stagnation issues u/s	(-) Barrier to barge/industrial use of CSSC	(-) Lose stormwater storage/conveyance in CAWS d/s	(0) Limited recreational use d/s of RAPS	-3	Lose access by barge for coal supply to Fisk power plant. Impact to industrial transportation (barge, etc.) increases as barrier location moves further d/s along CSSC Locations 4, 5, and 6 more positive than 7 → screen out location 7
<b>8 D/S Stickney WWTP</b>	(-) Stickney and RAPS CSOs to lake; d/s stagnation issues	(-) Barrier to barge/industrial use of CSSC	(-) Lose stormwater storage/conveyance in CAWS d/s	(0) Limited recreational use d/s of RAPS	-3	Lose access by barge for coal supply to Fisk power plant. Impact to industrial transportation (barge, etc.) increases as barrier location moves further d/s along CSSC Locations 4, 5, and 6 more positive than 8 → screen out location 8
<b>9 U/S Lockport</b>	(-) Stickney and RAPS CSOs to lake; u/s stagnation issues	(-) Barrier to use of CSSC and Cal-Sag Channel	(-) Lose outlet for CAWS (not able to drawdown)	(-) No connection to CAWS including Cal-Sag	-4	Lose ability to drawdown water levels in CAWS prior to storm events, increasing the potential flooding risk in the CAWS Locations 4, 5, and 6 more positive than 9 → screen out location 9
<b>16 CSSC and Cal-Sag Confluence</b>	(-) Stickney and RAPS CSOs to lake; u/s stagnation issues	(-) Barrier to use of CSSC and Cal-Sag Channel	(-) Lose outlet for CAWS (not able to drawdown)	(-) No connection to CAWS including Cal-Sag	-4	Lose ability to drawdown water levels in CAWS prior to storm events, increasing the potential flooding risk in the CAWS Locations 4, 5, and 6 more positive than 16 → screen out location 16
<b>18 Chicago River</b>	(-) u/s of barrier CSOs to lake and stagnation issues	(-) Limited barge/industrial use	(-) No backflow (outlet) to lake	(-) Barrier to CAWS for commercial and private boats	-4	CSOs to lake and stagnation issues limited to Chicago River Recreation access maintained on Chicago River but lose connection to North and South Branch
<b>19 U/S Northside WWTP</b>	(-) u/s of barrier flow stagnation issues and CSOs to lake	(0) No impact (no industrial use in NSC)	(-) Lose backflow outlet to lake	(+) More lakeside recreation u/s of barrier	-1	(-) Lose diversion from lake for WQ/flushing and CSOs to lake u/s of barrier (+) u/s of barrier would become 'lake water'

## Tabulation Table: Locations – Lower CAWS

Indicate +,0,- (trendline slope) and comment on the implications of the location and potential mitigation requirements.

Location	Eco Health (+,0,-)	Transportation (+,0,-)	Stormwater (+,0,-)	Recreation (+,0,-)	Total (+,0,-)	Comments on Key Elements
<b>10 Little Calumet</b>	(0) Limited change from existing	(0) No impact (no existing industrial use)	(-) Lose backflow outlet for release of additional stormwater to lake	(0) No impact (no/limited existing use)	-1	Barrier near natural divide Barrier independent of all locations on Calumet → barrier must occur in addition to barriers located on Calumet
<b>11 D/S Calumet WWTP</b>	(-) Flow stagnation d/s of barrier (no source of flow)	(-) Barrier to barge/industrial use between Cal-Sag and O'Brien lock	(-) Lose backflow outlet for release of additional stormwater to lake	(-) Lose connection to Lake MI	-4	Requires Calumet WWTP plant upgrade; limited opportunities for flow augmentation d/s of barrier as Little Calumet River has limited flow to flush Cal-Sag channel during dry weather Locations 12 and 20 more positive than 11 → screen out location 11
<b>12 U/S Calumet WWTP</b>	(0) u/s of barrier becomes lake; limited CSOs in u/s reach	(-) Barrier to barge/industrial use of Cal-Sag and O'Brien lock	(-) Lose backflow outlet for release of additional stormwater to lake	(-) Lose connection to Lake MI	-3	Stagnation u/s of barrier to Grand Calumet River. Similar to location 14 except not at existing lock facility; easier to provide effluent from WWTP for flow augmentation and would eliminate need for barrier location 13 (Grand Calumet River)
<b>13 Grand Calumet</b>	(0) Limited impact on CAWS and on IN	(0) No impact (no existing industrial use)	(-) Lose backflow outlet for release of additional stormwater to CAWS	(0) No impact (no/limited existing use)	-1	Barrier near natural divide Barrier independent of location 20 on Calumet and dependent of location 12 → barrier must occur in addition to barrier 20, but not needed with barrier 12
<b>14 O'Brien Lock</b>	(0) Same as existing except during extreme storm events	(-) Barrier to barge/industrial use between Cal-Sag and Lake Calumet	(-) No backflow (outlet) to lake	(-) Lose connection to Lake MI	-3	O'Brien lock does have existing releases to the Lake during extreme storm events, barrier would prevent backflow to lake; mitigation would require water source lakeside for stagnation; would require barge transfer/lift Locations 12 and 20 more positive than 14 → screen out location 14
<b>15 Lake MI/Calumet</b>	(-) No mixing w/ Lake water d/s of barrier and stagnation d/s	(-) Barrier to barge/industrial use of Lake Calumet and Cal-Sag	(-) Lose backflow outlet for release of additional stormwater to lake	(-) Lose connection to Lake MI	-4	Limits 'laker' ships from entering Lake Calumet; mitigation could provide opportunity to improve port but terminals for 'laker' ships would need to be relocated (approx. 35) Locations 12 and 20 more positive than 15 → screen out location 15
<b>17 Cal-Sag Channel</b>	(-) CSOs and WWTP to lake	(-) Barrier to barge/industrial use between Cal-Sag, CSSC, and O'Brien lock	(0) Lose backflow outlet for release to lake but much of flood storage volume remains	(-) Lose connection to Lake MI	-3	Less release to Cal-Sag because of barrier but more releases to Lake MI; advantage over location 11 is no barrier required on Little or Grand Calumet (locations 10 and 13) Locations 12 and 20 more positive than 17 → screen out location 17
<b>20 Lake Calumet</b>	(0) Lake Calumet water level would decrease; limited CSO issues and already stagnant	(+) Provides potential for multi-modal shipping center to maximize shipping efficiency	(-) No backflow (outlet) to lake	(-) Lose connection to Lake MI	-1	Significant wetland mitigation required Existing stagnation issues likely not significantly increased and limited CSO mitigation issues; mitigation could provide potential multi-modal shipping transportation opportunity including container on barge

## Tabulation Table: Ensemble – Upper CAWS

Indicate +,0,- (trendline slope) and comment on the implications of the ensemble and potential mitigation requirements.

Ensemble	Eco Health (+,0,-)	Transportation (+,0,-)	Stormwater (+,0,-)	Recreation (+,0,-)	Total (+,0,-)	Comments on Key Elements
<b>1 &amp; 3 Wilmette PS &amp; Chicago Locks</b>	(-) No flow diversion; stagnation on NSC and Chicago River	(-) Limited barge/industrial use but no connection to CSSC	(-) No backflow to lake aggravates existing flooding	(-) Barrier to CAWS for commercial, private, and public safety use	-4	Lack of source water to mitigate stagnation and DO issues on Chicago River. Significant mitigation required for increased flooding risk downtown Chicago. Connection between CAWS and Lake for recreation is lost.
<b>1 &amp; 18 Wilmette PS &amp; Chicago River</b>	(-) No flow diversion; issues w/ stagnation but less severe than 3	(-) Limited barge/industrial use but no connection to CSSC	(-) No backflow to lake aggravates existing flooding	(-) Limits CAWS/Lake access d/s of Chicago River only (less negative than 3)	-4	Stagnation issues on Chicago River less severe than barrier 3 location. Recreation scenario more positive than barrier 3 location. Ensemble 1&18 more positive than 1&3 → screen out location 3 and Ensemble 1&3
<b>2 &amp; 18 D/S NS WWTP &amp; Chicago River</b>	(-) Flow stagnation d/s of barrier 2 (no source of flow); CSOs to lake	(-) Limited barge/industrial use but no connection to CSSC	(-) No backflow to lake downtown aggravates existing flooding	(-) Limits CAWS/Lake access d/s of Chicago River only (less negative than 3)	-4	More CSOs to lake than ensemble 1&18. Requires additional treatment for Northside WWTP (flows to lake). Potential for 'credit' to diversion account w/ return of Northside WWTP to lake. Ensemble 1&18 more positive than 2&18 → screen out location 2 and Ensemble 2&18
<b>4 Mouth of South Branch</b>	(-) Stagnation d/s of barrier; CSOs to lake	(-) Barrier to barge/industrial use of North Branch and Chicago River only	(-) No backflow (outlet) to lake	(+) River becomes lake (no locking needed)	-2	Northside WWTP requires additional treatment. Significant CSO mitigation required. RAPS conveyance issue (no backflow to lake). Significant WQ mitigation issues w/ moderate flood control mitigation required.
<b>5 U/S Racine Ave. PS (RAPS)</b>	(0) Stagnation both sides of barrier; no RAPS CSO to lake	(-) Barrier to barge/industrial use of CSSC	(-) No backflow (outlet) to lake	(0) Limited recreational use d/s of RAPS	-2	Assuming Fisk power plant remains in operation, barrier location would be u/s of Fisk. Potential for flow augmentation u/s of barrier (w/ Lake MI water) and d/s of barrier w/ Stickney water Footnote: If Fisk plant is offline and CSOs would already be addressed through other means, then barrier could be placed at location 6 (same flow augmentation scenario)
<b>4/5* South Branch U/S RAPS</b>	(0) Stagnation both sides of barrier; no RAPS CSO to lake	(-) Barrier to barge/industrial use of North Branch and Chicago River only	(-) No backflow (outlet) to lake	(+) River becomes lake (no locking needed)	-1	Merged location 4 and 5 into single barrier location. Location 4 at mouth of South Branch is very congested w/ significant infrastructure, and location 5 moved u/s of Fisk plant and other u/s barge terminals. Revisions to locations 4 and 5 resulted in similar likely location between mouth of South Branch and RAPS.
<b>6 U/S Racine Ave. PS (RAPS)</b>	(-) u/s CSOs to lake and d/s stagnation issues	(-) Barrier to barge/industrial use of CSSC	(-) Lose stormwater storage/conveyance in CAWS d/s	(0) Limited recreational use d/s of RAPS	-3	Significant CSO mitigation issue w/ RAPS lakeside. Dry weather stagnation issues u/s (lakeside) of RAPS w/ possible mitigation by using new WWTP to treat sanitary flows currently going to Stickney along CSSC between RAPS and Stickney. Ensemble/location 4/5 more positive than 6 → screen out location 6
<b>19 &amp; 18* U/S NS WWTP &amp; Chicago River</b>	(-) u/s of barrier flow stagnation issues and CSOs to lake	(-) Barrier to barge/industrial use of Chicago River only	(-) Lose backflow outlet to lake	(0) More lakeside recreation u/s of barrier on NSC; Barrier to CAWS for commercial, private, and public safety use	-3	CSOs lakeside larger than 1&18 but manageable. Significant flood control mitigation issue with loss of backflow outlets to lake at Wilmette and Chicago River. Ensemble 19&18 more positive than 1&18 → screen out location 1 and Ensemble 1&18

\*Ensemble Barrier Locations screened for further review

## Tabulation Table: Ensemble – Lower CAWS

Indicate +,0,- (trendline slope) and comment on the implications of the ensemble and potential mitigation requirements.

Ensemble	Eco Health (+,0,-)	Transportation (+,0,-)	Stormwater (+,0,-)	Recreation (+,0,-)	Total (+,0,-)	Comments on Key Elements
<b>12 &amp; 10*</b> <b>U/S Calumet</b> <b>WWTP &amp; Little</b> <b>Calumet</b>	(0) u/s of barrier becomes lake; limited CSOs in u/s reach	(-) Barrier to barge/industrial use of Cal-Sag and O'Brien lock	(-) Lose backflow outlet for release of additional stormwater to lake	(-) Lose connection to Lake MI	-3	Stagnation u/s of barrier to Grand Calumet River.  Similar to location 14 except not at existing lock facility; easier to provide effluent from WWTP for flow augmentation and would eliminate need for barrier location 13 (Grand Calumet River)
<b>11 &amp; 10</b> <b>D/S Calumet</b> <b>WWTP</b>	(-) Flow stagnation d/s of barrier (no source of flow)	(-) Barrier to barge/industrial use between Cal-Sag and O'Brien lock	(-) Lose backflow outlet for release of additional stormwater to lake	(-) Lose connection to Lake MI	-4	Requires Calumet WWTP plant upgrade; limited opportunities for flow augmentation d/s of barrier as Little Calumet River has limited flow to flush Cal-Sag channel during dry weather  Locations 12 and 20 more positive than 11 → screen out location 11
<b>14 &amp; 10 &amp; 13</b> <b>O'Brien Lock</b>	(0) Same as existing except during extreme storm events	(-) Barrier to barge/industrial use between Cal-Sag and Lake Calumet	(-) No backflow (outlet) to lake	(-) Lose connection to Lake MI	-3	O'Brien lock does have existing releases to the Lake during extreme storm events, barrier would prevent backflow to lake; mitigation would require water source lakeside for stagnation; would require barge transfer/lift  Locations 12 and 20 more positive than 14 → screen out location 14
<b>15 &amp; 10 &amp; 13</b> <b>Lake MI/Calumet</b>	(-) No mixing w/ Lake water d/s of barrier and stagnation d/s	(-) Barrier to barge/industrial use of Lake Calumet and Cal-Sag	(-) Lose backflow outlet for release of additional stormwater to lake	(-) Lose connection to Lake MI	-4	Limits 'laker' ships from entering Lake Calumet; mitigation could provide opportunity to improve port but terminals for 'laker' ships would need to be relocated (approx. 35)  Locations 12 and 20 more positive than 15 → screen out location 15
<b>20 &amp; 10 &amp; 13*</b> <b>Lake Calumet</b> <b>Little Calumet</b> <b>Grand Calumet</b>	(0) Lake Calumet water level would decrease; limited CSO issues and already stagnant	(+) Provides potential for multi- modal shipping center to maximize shipping efficiency	(-) No backflow (outlet) to lake	(-) Lose connection to Lake MI	-1	Significant wetland mitigation required  Existing stagnation issues likely not significantly increased and limited CSO mitigation issues; mitigation could provide potential multi-modal shipping transportation opportunity including container on barge

\*Ensemble Barrier Locations screened for further review



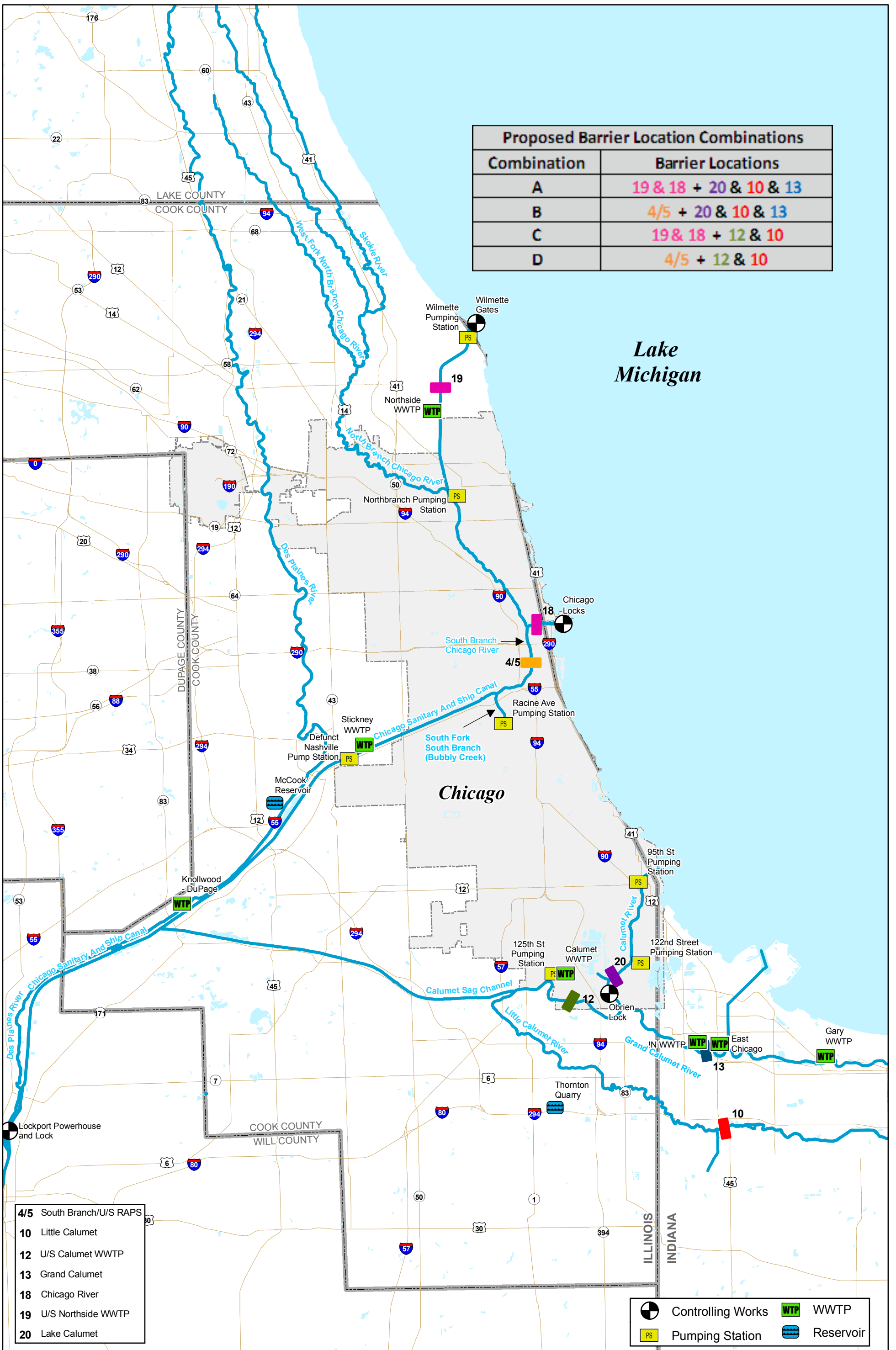

- 4/5 South Branch/U/S RAPS
- 10 Little Calumet
- 12 U/S Calumet WWTP
- 13 Grand Calumet
- 18 Chicago River
- 19 U/S Northside WWTP
- 20 Lake Calumet

	Controlling Works		WWTP
	Pumping Station		Reservoir

**INITIAL SCREENING BARRIER LOCATIONS**  
Charrette I - March 18, 2011

	 N	 0 1.25 2.5 5 Miles
--	-------	------------------------



# GLC/CI Charrette I

## Barrier Types

March 18, 2011

### Barrier Type A: Sheetpile

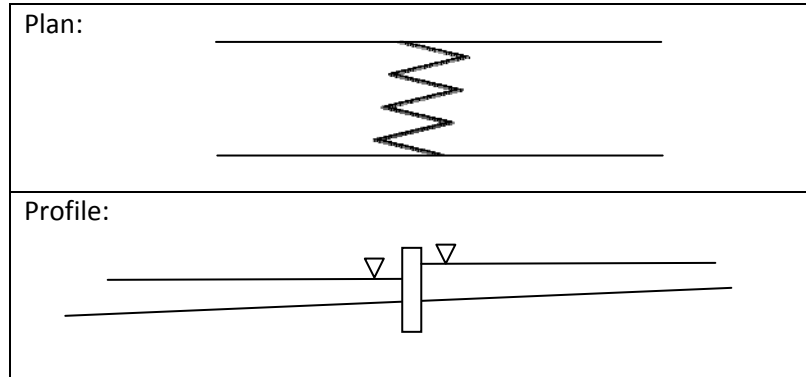

#### **Key Elements:**

Sheetpile driven to act as a dam assumed to be impermeable

#### **Pros:**

Inexpensive

Fast

Low Operational Cost

#### **Cons:**

Lack of land use opportunities

Limited barrier effectiveness

Potential leaks and impact damage

# GLC/CI Charrette I

## Barrier Types

March 18, 2011

### Barrier Type B: Land Bridge w/ No Industrial Vessel (Barge) Transfer

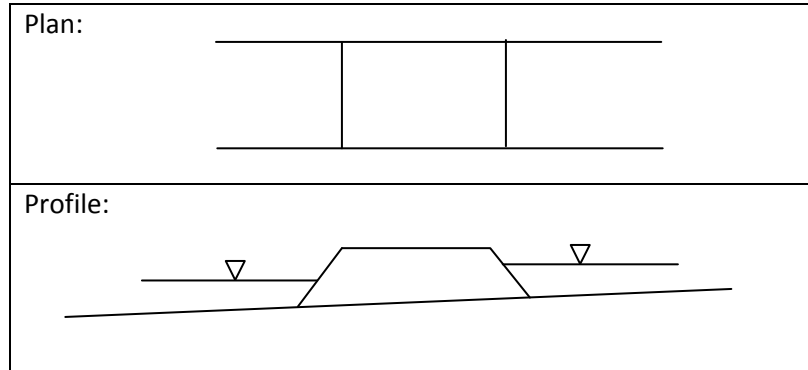

#### Key Elements:

Create a impermeable land bridge which can be developed or used to for other purpose/opportunity (e.g. transportation crossing, park/residential)

#### Pros:

- Creates land use opportunities (multi-purpose)
- Flexibility for land use on land bridge and adjacent opportunities
- Solid barrier which can be as long/large as necessary
- Standard technology for construction
- Maximize land use opportunities with high AIS effectiveness

#### Cons:

- Construction could be significant if longer than a few hundred feet
- If barrier is multi-use, transfer of commercial/recreation boats becomes more challenging
- Longer planning horizon for implementation

# GLC/CI Charrette I

## Barrier Types

March 18, 2011

### Barrier Type C: Land Bridge with Industrial Vessel (Barge) Transfer

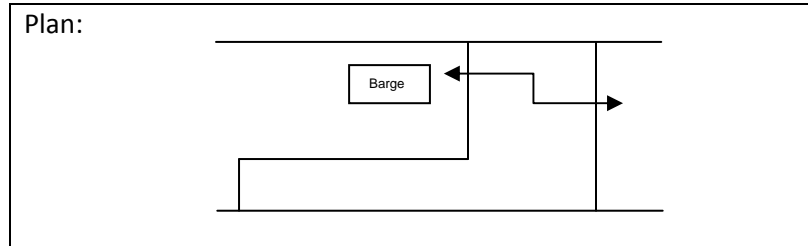

#### **Key Elements:**

Create an impermeable land bridge which includes a vessel transfer mechanism (most likely in an industrial area)

#### **Pros:**

Accommodates navigation

Creates land use opportunities (multi-purpose)

Flexibility for land use on land bridge and adjacent opportunities

Solid barrier which can be as long/large as necessary

#### **Cons:**

Barge transfer is non-standard technology

Longer planning horizon for implementation

Higher risk of AIS transfer with barge/commercial vessel transfer

# GLC/CI Charrette I

## Barrier Types

March 18, 2011

### Barrier Type D: Constructed Barrier with Intermodal Facility

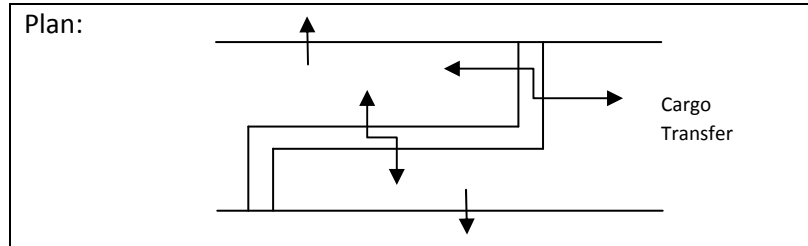

#### **Key Elements:**

Create an impermeable barrier in a shape that facilitates cargo transfer both across the barrier and to land side; development of intermodal facility would likely require private development and/or political buy-in

#### **Pros:**

- Port Efficiency
- Transfer to multi-modes of transportation possible
- Economic development opportunity
- Accommodates navigation
- Creates land use opportunities (multi-purpose)
- Flexibility for land use on land bridge and adjacent opportunities
- Solid barrier which can be as long/large as necessary
- High AIS effectiveness

#### **Cons:**

- Longer planning horizon for implementation
- Construction could be significant if longer than a few hundred feet
- If barrier is multi-use, transfer of commercial/recreation boats becomes more challenging

# Barrier Types by Location

March 18, 2011

Location	Description	Possible Barriers	Notes
4	South Branch	B(R); C(R)	With Recreational Vessel Transfer
5	Upstream of Racine Ave PS	B(R); C(R)	With Recreational Vessel Transfer
10	Little Calumet River	A; B	Natural divide east of Hart's Ditch
12	Upstream of Calumet WWTP	C(R)	With Recreational Vessel Transfer
13	Grand Calumet River	A; B	Natural divide east of Whiting WWTP and west of IN Harbor Canal
18	Chicago River	B(R)	With Recreational Vessel Transfer
19	Upstream of Northside WWTP	A(R); B(R)	With Recreational Vessel Transfer
20	Upstream of O'Brien L/D	C(R); D(R)	C would be less complex easier to fund if D is too difficult

# GLC/CI Charrette I

## Barrier Mitigation Strategies

March 18, 2011

Mitigation Discussions:

Barrier Location 19 (u/s of Northside WWTP)

Issue Type:	Location	Dry Weather Impacts	Wet Weather Impacts	Mitigation
Water Quality / Ecological Health	Upstream	POS for chem/bio NEG for stagnation	NEG for CSOs to Lake	<b>Wet:</b> Decrease inflows, increase storage and conveyance <b>Dry:</b> Fill channel lakeside of barrier or add flow
	Downstream	NEG – lose diversion for WQ	None	<b>Wet:</b> None needed <b>Dry:</b> Plant upgrade; SEPA; diversion from North Branch
Stormwater	Upstream	N/A	-POS for new outlet and more capacity -NEG for basement flooding with increasing Lake levels	<b>Wet:</b> replumb CSOs; deep storage; tidegate; separation of CSOs; storage in Lake MI
	Downstream	N/A	NEG for no outlet to Lake	Same as upstream mitigating measures

Transportation:

Mitigating measures for impassable barrier:

- Vessel Transfer (Barge, Commercial, Recreational)
- Cargo Transfer between Barges and Lake Vessels
- Cargo Transfer between Barges and Landside Modes (Truck Rail)
- Co-Locate with Multimodal Logistics Center
- Connect to Multimodal Logistics Center
- Marina Rationalization



## GLC/CI Charrette II

# Summary

April 22, 2011

The following is a brief overview of the charrette held on April 19<sup>th</sup>-20<sup>th</sup> for the GLC/CI Separation Study:

- Reviewed charrette goals, charrette schedule, and deliverables from this charrette effort and Peer Review document needs
- Each Discipline Lead discussed what has been learned since first charrette and what informational gaps still exist
- Breakouts by Transportation, Flooding and Eco-Health section took place with each section refining further the impacts and mitigation measures required for each barrier site
- At the end of the breakout session, all sections came back for the rest of the day to collaborate and discuss their findings in a “Challenge Session”, Breakout sessions occurred both days.
- The Challenge Session resulted in further insight as to how each barrier site may impact the other barrier sites and CAWS system
- Flooding/CSO and Transportation/Shipping issues appear to be most problematic in development of a plan
- Discussed CAWS system operations and usage regarding water quality, stormwater, and transportation (industrial/commercial shipping)
- Much discussion ensued in terms of transportation enhancement and opportunity within the Calumet Lake area
- It was identified there may be an additional connection for consideration with Wolf Lake
- Identified data gaps and next steps for further evaluation and development in preparation for the Peer Review on May 9-10.

# CAWS Barrier Site Considerations

---

With TARP completed, it has been modeled that no more than 1 CSO event per year will occur. Federal guidance allows up to 4 events per year with prescribed treatment of screening and disinfection. The successful implementation of any barrier placement is incumbent upon completion of TARP.

Barriers 18 and 19 would be implemented jointly resulting in no releases of river water to the lake. The following identifies potential positives, negatives and mitigation actions for the placement of each barrier.

## Site 19 – Barrier Placement lakeside of Northside WWRP

### Lakeside Section

#### Positives:

- Improved water quality potential as the lakeside section will be connected to the lake.
- Potential for increased fishing opportunities with lake connection for salmon and trout.
- Potential for increased recreational boating opportunities with development of harbor/marina.

#### Negatives:

- Potential for stagnation of lakeside section; can be addressed by installation of airlift system, flow augmentation with either lake water or treated Northside WWRP effluent.
- CSOs (1 or 4) could negatively impact improved biological conditions. If TARP is in place, one event in 18 months is predicted.
- Sediment contamination, sediment transport to the lake

#### Mitigation:

- Increased TARP capacity to address CSO events into lakeside section
- Treatment level of CSO events
- Dredging and removal of sediments

### Riverside Section

#### Positives:

- Treatment of Northside WWRP would not have to be modified as operation would continue as it is currently

#### Negatives:

- Potential conveyance issues as all CSO events would go riverside with no potential for releases to the lake during extreme events

#### Mitigation:

- Flood plain storage for North Branch
- Channel modification for conveyance
- TARP completion and enhancement
- Develop Green infrastructure

## Site 18 – Barrier Placement next to Chicago River controlling works

### Lakeside Section/Riverside Section

#### Positives:

- No CSO releases to the lake
- CSO events and treatment would not have to be modified
- Opportunity to develop lakeside enhanced harbor and marina
- O&M needs for controlling works would cease

#### Negatives:

- Recreational and commercial traffic impeded

# CAWS Barrier Site Considerations

---

- Public safety and response vessels impeded
- Barge traffic could no longer access river or lake
- Water quality riverside could be negatively impacted due to stagnation
- Extreme CSO events and flood waters could no longer be released to the lake. Conveyance capabilities riverside need to be investigated for extreme events.

## Mitigation:

- Recreational boat transfer and disinfection system
- Additional public safety boats for Police and Fire Departments
- Capture of CSO outlets to Chicago River with completion of TARP
- Flow augmentation from the Jardine Water Plant to address stagnation issue of Chicago River or use of airlift circulation system

Barrier 4/5 citing will result in two open lake connections, one at Wilmette and the other at the Controlling Works on the Chicago River. Water quality would need to be addressed during CSO events and normal Northside WWRP operation as it is anticipated that water quality would need to meet more stringent lake water quality standards.

Site 4/5 – Barrier Placement somewhere on the South Branch, TBD

## Lakeside Section

### Positives:

- Improved water quality and habitat (could result in improved salmon and trout fishing opportunity)
- Little impact to water taxis and recreational boat access to and from the lake
- Flooding impacts should be reduced as there is no restriction to backflow to the lake

### Negatives:

- Restrict barge access from riverside, will have to access from Calumet across the lake
- May require additional public safety boats
- Barrier will prohibit recreational boat traffic
- Water quality of wastewater and CSO releases for North Branch and Chicago River will require further treatment to meet lake water quality standards
- Stagnation for section of South Branch, lakeside of barrier, may occur
- CSO events may negatively impact the improved biological and habitat conditions
- Contaminated sediment issues

### Mitigation:

- If boats want to access riverside of the barrier, a boat transfer and disinfection system will be required
- Flow augmentation with lake water or circulation of the South Branch section may be required to address stagnation issue
- Additional Police and Fire Department safety response boats may be required
- Improvements to wastewater treatment plants will be required to meet lake water quality standards
- Treatment of water during CSO events will be required, screening and disinfection, if allowed to occur up to 4 times annually. While this may meet federal guidelines, this treatment does nothing for improving water quality for biological/ecological requirements
- Dredging and removal of sediments

# CAWS Barrier Site Considerations

---

## Riverside Section

### Positives:

- Minor ecological effect
- Little effect to barge traffic and industrial operations with adequate water levels
- Should not have conveyance issues
- No back flow of water from Racine Pump station

### Negatives:

- Stagnation of riverside section down to Stickney outfall.
- Lowered water level within channel
- Barge movement and industrial operation negatively effected due to lowered water level
- Restricted boat traffic movement due to barrier

### Mitigation:

- Flow augmentation from Stickney WWRP at barrier
- Water level control with construction of additional navigation lock
- Boat transfer and disinfection system

Barrier Site 20 is located at lakeside of the T.J. O'Brien lock. Several options for citing are being considered, related to transportation and shipping potential. There are potential T&E, wetland, land use, and contamination issues when developing harbor/port options. There are also general conveyance issues when flood situations occur.

## Lakeside Section

### Positives:

- New dedicated port to handle transfer of bulk products and container traffic
- Lakeside ecology should not be effected, may have stagnation issue
- Opportunity for improved shipping and transportation

### Negatives:

- Port development will negatively impact T&Es and wetlands.
- Land use may dictate where Port will be located
- Barge traffic will no longer be able to access Calumet river lakeside of barrier
- Bridges directly north of O'Brien lock may require modification
- Recreational boats will be restricted in access to or from the lake
- Contaminated sediment and movement to lake

### Mitigation:

- Recreational boat transfer and disinfection system
- New lakeside recreational marina and harbor
- New Port development
- Spillway consideration at barrier may need to be considered for flood events
- Flow augmentation or use of SEPA may be required to address potential stagnation issue
- Depending on selected Port location, bridges directly north of O'Brien Lock will require modification
- Dredging and removal of sediment

## Riverside Section

### Positives:

- No back flow of untreated water to the lake

# CAWS Barrier Site Considerations

---

- O&M costs greatly reduced or eliminated at O'Brien Lock

## Negatives:

- Recreational boat movement restricted to and from lake
- Barge traffic to and from the lake restricted
- Potential for increased flooding
- Stagnation of section from barrier to Calumet WWRP may occur

## Mitigation:

- Recreational boat transfer and disinfection system
- Barge material transfer site
- Flow augmentation with Calumet WWRP effluent from barrier to plant
- Provide overflow relief at barrier for extreme flood situations

Barrier sites 10 and 13 are similar as they will be placed at the grade separation elevation where the Grand Calumet and Little Calumet River flows separate in east and west flow directions. There should be little to no effect, positive or negative, as flows currently separate to the east and west. Flooding concerns should require further investigation and contact with USACE and INDNR.

## Other Considerations:

### AIS Mitigation

Vectors - It must be realized that recreational boats are vectors for transfer of AIS. When moving boats from one basin to another, practices must be in place and implemented for cleaning/disinfection of boats once removed from the water. What those practices and techniques might be need further investigation before recommendations and costs may be made.

Human activity can also result in AIS transfer. Fishing activity is one of the more obvious activities that can and does result in the spread of AIS. Fishing gear can collect and harbor some AIS as well as the obvious transfer vector of bait buckets and indiscriminate stocking or release.

For both of the above examples, **public outreach** and **education** are vital to decrease the risk of AIS spread. This may include the implementation of signage and placards at boat launch sites, along bicycle and hiking trails, sports and bait shops. Flyers should be made available and distributed to targeted retail outlets and informational sites. Education should also be initiated within local schools as the future of AIS will be dictated by the youth of today.

### Flood Flows

How much of a risk will be accepted when addressing flood flow remediation? Does there need to be a complete separation of the two basins at all times or will there be an acceptance of risk management as a result of some spillway overflow to address periods of high flood flows such as 100 or 200 year events, or must construction and mitigation be completed for events beyond these? TARP is to address the 100 year event but should it be enhanced to the 200 or 500 year event? TARP is not scheduled to be completed until 2029.

## CAWS Barrier Site Considerations

---

### Water Quality

It is understood that “general use standards” for inland streams and waterways are different than “Lake Michigan standards” with Lake Michigan being more stringent. How much effort and cost will be required to update wastewater treatment plants so that effluents will meet water quality standards?

If CSOs are allowed to go to the lake, will they be allowed up to 4 events as federal guidance suggests, and if allowed, what level of treatment will be required? With TARP on line, it is suggested there is to be no more than one event annually. If this is the case, will treatment be necessary? It should be understood that with treatment of CSOs by screening and disinfection, this does not improve water quality for biological and ecological requirements such as dissolved oxygen.



**NEAR LAKE BARRIER -ENSEMBLE**

Locations 18, 19, 20, 10, 13

Location	Transportation	Flooding	CSO	EcoHealth
18/19	<p>19 - Portage considerations for recreational paddle/oar craft (\$)</p> <p>18 - Recreational boat lift/transfer/disinfection. Public safety- Additional Police and Fire boats; Additional/dual Commercial/Tour boats (\$)</p>	<p>19 lakeside - No mitigation expected;</p> <p>18 Lakeside - NA (lake)</p> <p>18/19 Riverside: Any combination of storage, conveyance, inflow reductions. We expect floodplain access for primary storage, channel modifications and/or treatment plant modifications for conveyance, additional TARP and/or underground volume for secondary storage, and various green infrastructure - see flood mitigation table.(\$\$\$)</p> <p>Spillway at greater than 100yr, 24 hr storm at one or both barriers</p>	<p>19 CSO basin only (no 18 CSO basin)</p> <p>TARP as Intended Scenario: Allow CSO to Lake untreated</p> <p>TARP as Expected Scenario: more than 4 csos, so needs additional storage (treatment DOES NOT IMPROVE ECO) (\$\$)</p> <p>No CSO to lake allowed scenario: Major effort to capture and or treat (\$\$\$)</p> <p>Note: CSO will discharge to lake with floodwater at greater than 100yr 24hr stormevents.</p>	<p>19 - Stagnation to be addressed with either airlift or lake water augmentation on lakeside section (\$)</p> <p>19 - Upgrade Northside WWRP to meet Lake water quality standards for lakeside inflow (Flood control double benefit) (\$\$)</p> <p>18- Stagnation to be addressed with either airlift and/or lake water augmentation from Jardine (use existing Lake MI diversion allocation through Jardine) (\$\$)</p>
20 - Site to be refined	<p>Raise RR and highway bridge; (\$\$)</p> <p>New recreational boat marina in Lake Calumet; (\$\$)</p> <p>Boat lift/transfer system for rec; (\$)</p> <p>New Port development; (\$\$)</p> <p>Laker/barge material transfer (\$\$)</p> <p>Landfill and/or wetland mitigation (\$\$)</p> <p>MWRD biosolids drying bed relocation (\$)</p>	<p>Any combination of storage, conveyance, inflow reductions: Conveyance: channel modifications (morphology, geometry, tunnel siphon). floodplain storage (Levees)</p> <p>Spillway at greater than 100yr, 24 hr storm at barrier</p> <p>See flood mitigation table. (\$\$\$)</p>	<p>TARP as Intended Scenario: No additional mitigation</p> <p>TARP as Expected: No additional mitigation ==&gt; more than 4 csos, but no change to CSOs moving lakeside (CSOs located and function as current operations)</p>	<p>Lakeside-flow augmentation with lake water or aerate with airlift system, SEPA; (\$\$)</p> <p>Riverside-flow augmentation with Calumet WWTP effluent (\$\$)</p>
10 - Little Calumet grade separation	N/A	<p>USACE control structure modification (inflatable dam/gate)</p> <p>Present flow directions maintained. (\$)</p>	<p>NA - may need more research to discover CSO into Little Cal from those communities. (\$)</p>	<p>Provide baseflow for Little Cal through splitting of Hart's Ditch flows (\$) or diversion of WWTP flows on riverside of Grand Calumet barrier (\$)</p>
13 - Grand Calumet grade separation - location TBD per Wolf Lake determination	N/A	<p>Potential Wolf Lake connection during high rain events?</p> <p>Present flow directions maintained. (\$)</p>		<p>No change</p>

**OPEN UPPER CAWS - ENSEMBLE**

Locations 4/5, 20,10,13

Location	Transportation	Flooding	CSOs	EcoHealth
4/5 - Site on South Branch	<p>Recreational boat lift scenario - presents significant AIS risk (\$)</p> <p>Recreational boat cutoff scenario - limited commercial rec traffic past barrier; private rec boats use Calumet system for passage into riverside; limits AIS risk; no mitigation cost barge traffic via lake routes / Calumet Port; no mitigation cost</p> <p>Navigation Lock downstream of Stickney required for maintaining 9' channel - for navigation (\$\$)</p> <p>Public safety- Additional Police and Fire boats; (\$)</p>	<p>Additional mitigation not expected, WIB could be improved upstream - dependent on Lake levels.</p>	<p>Lakeside:</p> <p>TARP as Intended Scenario: Allow CSO to Lake untreated</p> <p>TARP as Expected: more than 4 csos, so needs additional storage and treatment (treatment DOES NOT IMPROVE ECO) based on standards, guidance, permit process, and benchmarks.(\$\$\$)</p> <p>No CSO to lake allowed scenario: Major effort to capture and or treat - likely not possible to mitigate. (\$\$\$\$)</p> <p>Riverside:</p> <p>No change, - send to St Louis. (\$)</p> <p>Note: CSO will discharge to lake with floodwater at greater than 100yr 24hr stormevents.</p>	<p>Lakeside:</p> <p>Flow augmentation with Lake water to barrier;(\$\$)</p> <p>Riverside:</p> <p>Flow augmentation from Stickney Plant to barrier (\$\$)</p> <p>BMPs in North Branch Watersheds for non-point loadings from MS4 areas (\$\$)</p>
20 - Site to be refined	<p>Raise RR and highway bridge; (\$\$)</p> <p>New recreational boat marina in Lake Calumet; (\$\$)</p> <p>Boat lift/transfer system for rec; (\$)</p> <p>New Port development; (\$\$)</p> <p>Laker/barge material transfer (\$\$)</p> <p>Landfill and/or wetland mitigation (\$\$)</p> <p>MWRD biosolids drying bed relocation (\$)</p>	<p>Any combination of storage, conveyance, inflow reductions:</p> <p>Conveyance: channel modifications (morphology, geometry, tunnel siphon).</p> <p>floodplain storage (Levees)</p> <p>Spillway at greater than 100yr, 24 hr storm at barrier</p> <p>See flood mitigation table. (\$\$\$)</p>	<p>TARP as Intended Scenario: No additional mitigation</p> <p>TARP as Expected: No additional mitigation ==&gt; more than 4 csos, but no change to CSOs moving lakeside (CSOs located and function as current operations)</p>	<p>Lakeside-flow augmentation with lake water or aerate with airlift system, SEPA; (\$\$)</p> <p>Riverside-flow augmentation with Calumet WWTP effluent (\$\$)</p>
10 - Little Calumet grade separation	N/A	<p>USACE control structure modification (inflatable dam/gate)</p> <p>Present flow directions maintained. (\$)</p>	<p>NA - may need more research to discover CSO into Little Cal from those communities. (\$)</p>	<p>Provide baseflow for Little Cal through splitting of Hart's Ditch flows (\$) or diversion of WWTP flows on riverside of Grand Calumet barrier (\$)</p>
13 - Grand Calumet grade separation - location TBD per Wolf Lake determination	N/A	<p>Potential Wolf Lake connection during high rain events?</p> <p>Present flow directions maintained. (\$)</p>		<p>No change</p>

**Ensemble:** selected set of locations to construct barrier

**Option:** Ensemble + Site Specific Barrier Technology + Suite of Mitigation Strategies

**Mitigation Strategy:** Selected mitigation elements that resolves the issues associated with each location.

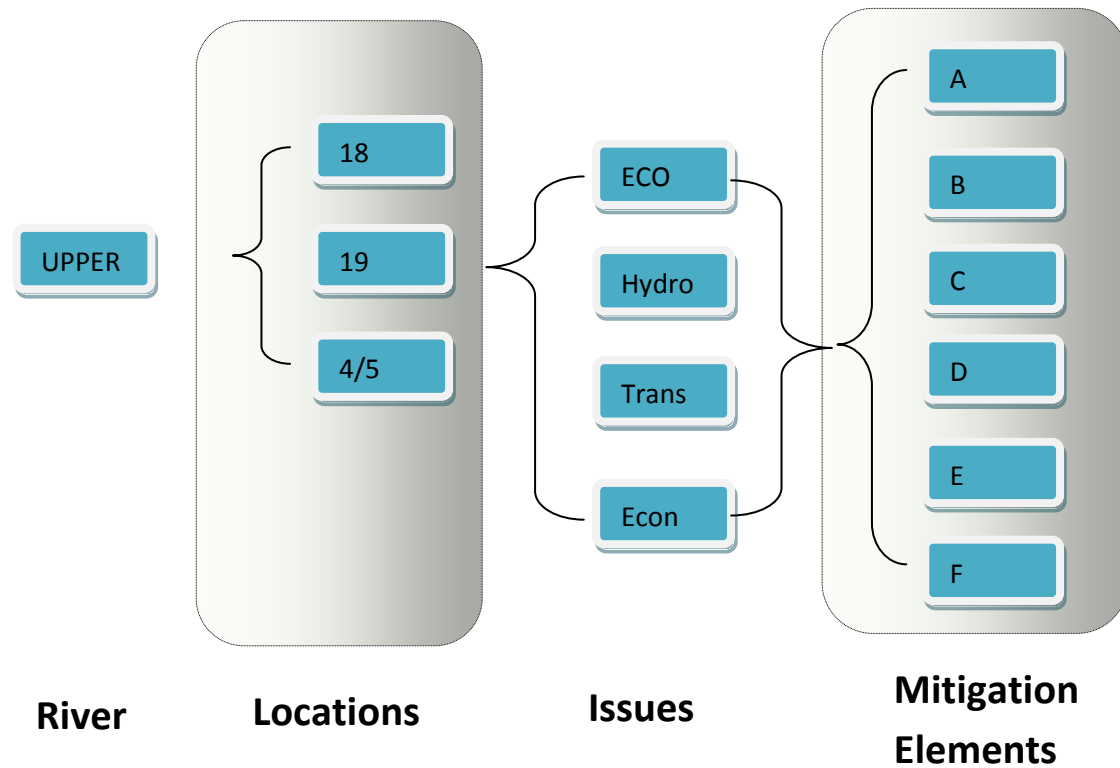

**PROPOSED AGENDA – CHARRETTE II (April 19 and 20)**

GOAL of CHARRETTE II: Explore mitigation for each ensemble, refine the existing locations, deliver three clearly defined *options* that meet client needs and can be processed in the RAPS protocol.

TIME – APRIL 19	ACTIVITY	WHO
8:00-8:45 (up to 15 mins per leader)	Update from team leaders – What questions have been answered since last Charette	Irwin – Baseline, Paul –Flooding, John V Transportation Dennis, Guidance
8:45 – 9:15	Walk through review of each scenario – Key Items	Pete
9:30 – 1:30	BREAKOUT TRANSPORTATION- Evolve Lower CAWS mitigation strategy	John V.
9:30 – 1:30	BREAKOUT Flooding – Evolve Upper CAWS Mitigation Strategy	Paul
9:30 – 11:30 (or earlier)	BREAKOUT – Eco (and AIS) Evolve mitigation strategy, join flooding as needed.	Irwin
Lunch with the break out.		
1:30 – 3:00	Challenge Session - Calumet River Present best transportation plan, flooding and Eco challenge and synergize	John V.
3:00-4:30	Challenge Session – Upper CAWS Present Upper Caws flood mitigation, Transit challenge - synergize.	Pete
<b>TIME – APRIL 20</b>		
8:00-8:15	Donuts and Dennis. Provide insights/feedback	Dennis
8:00 – 11:00	Transit focus on Upper CAWS, and retool as necessary	Group
8:00 – 11:00	Flooding focus on Lower CAWS, and retool as necessary	Group
11:00-1:30	Team Leaders raise key points. Open Discussion as Group. Lunch	Paul
1:30 – 2:15	Define, Articulate and record each Option	Scott
2:15-3:00	Outline for Peer Review Docs Outline for LC meeting Define the necessary visuals / figures to tell the key stories.	Scott
3:00-5:00	Option Presentation Dry Run	TBD
4:00-5:00	Establish list of visual aids to be created	TBD (concurrent with above)

Any breakout that completes tasks early to move forward with a list of visuals, list of impacted stakeholders, and outline of final report.

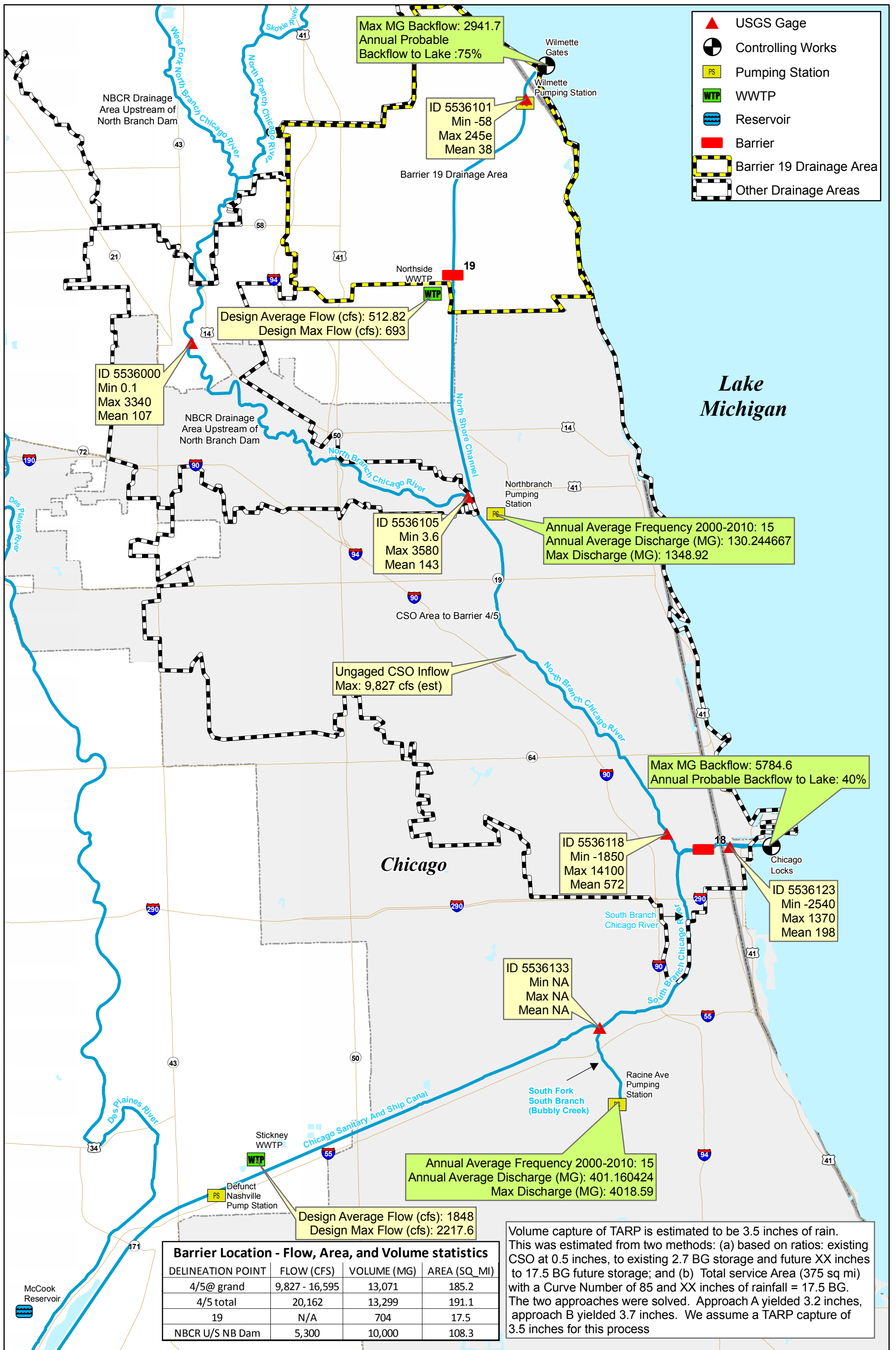

**Upper CAWS Barrier 18 & 19 Location**  
Charrette II - April 19 2011

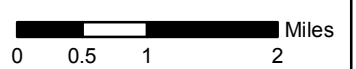

**Barrier #19:** North Shore Channel above outfall from North Side WRP

Key Assumptions:

- This location is only to be in conjunction with #18
- NSRP is not significantly changing processes for the AIS project
- CSOs upstream of NSWTP will become lakeside and loss of backflow outlet to lake during extreme storm events
- Water elevations within the embayment will be consistent with Lake Michigan water elevations.
- Sediments which have accumulated in this reach of the channel will be exposed to Lake Michigan.

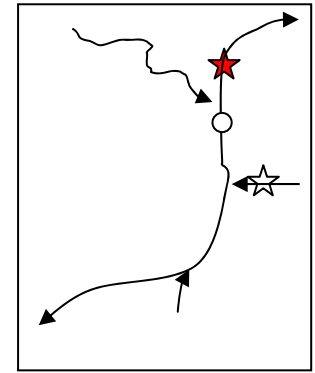

*Lakeside (Upstream)*

Description:

Currently, a small harbor is located lakeside of the Wilmette Pumping Station and sluice gates, and no navigation is possible between the NSC and Lake Michigan. Under the proposed conditions, the pump station and Sluice gates will no longer be in service, and the Channel will be opened to Lake Michigan. This will create an embayment of Lake Michigan up to the proposed barrier location.

**LAKESIDE of Barrier**

Condition During WET (CSO) Weather	Condition During DRY Weather
<b>EH:</b> The Channel may receive intermittent CSO discharges. Frequencies and volumes are TBD. The distal end of the embayment will experience stagnant water conditions, resulting in low DO, odors, and possible algal blooms.	<b>EH:</b> The dissolved oxygen concentration will increase and the nutrient concentrations will decrease
<b>Flood:</b> Base elevations will increase from today, and reduce some channel capacity to flow water – however, the channel will have an open outlet to the Lake. Flooding is not expected to be a problem.	<b>Flood:</b> NA
<b>Trans:</b> NA	<b>Trans:</b> As this reach traverses a residential area, no barge or commercial traffic is expected, however, lake oriented recreational opportunities and marinas will expand with the increased footage and access to Lake.

*Riverside (Downstream)*

Currently, the downstream reach proximal to the proposed barrier (downstream of the NSWTP outlet) has little commercial traffic and is primarily surrounded by park land/residential land uses. There is no indication of overbank flooding, the waterway use is predominantly recreational.

**RIVERSIDE of Barrier (flow away from Lake Michigan)**

Condition During WET (CSO) Weather	Condition During DRY Weather
<b>EH:</b> CSO frequency will be reduced due to TARP baseline, resulting in fewer CSO discharges.	<b>EH:</b> There is no discretionary flow from lake, which may have some minor deleterious effect on WQ. However, reduced CSO discharges may have a positive trending effect on EH. Little if any change in EH is expected.
<b>Flood:</b> There is a loss of an outlet to the Lake during extreme weather events. This increases the risk of local and downstream flooding. There is additional relief due to the reduced CSO drainage area drainage (portion shifted to lake side), but this is not considered enough to compensate for a loss of backflow capacity. The river elevation is operated as is today, and the channel capacity will be as is today, but TARP will convey more storms, and a larger portion of each event, reducing the average risk. However, the lack of an outlet is of concern for extreme flooding events.	<b>Flood:</b> NA
<b>Trans:</b> NA	<b>Trans:</b> This channel reach is predominantly recreational uses, which will face a barrier and reduction in channel length. Otherwise no significant change anticipated.

For each location, there are a variety of stakeholders, with varying degrees of impact.

The following table indicates the identified stakeholder, potential impact, magnitude and probability of occurrence – without additional mitigation-given barrier location only. This table is intended to be representative, not a complete list.

Stakeholder	Impact	Magnitude	Probability
Proximal Residents	Change flows and WQ in neighborhood, recreation	Low	High
Industry	Minor	Low	Low
Commercial Vessels	Minor	Low	Low
Recreational Boaters	Change opportunities	High	High
MWRD	Lose backflow	High	High
IDNR / USCOE	Diversion accounting	High	High
IDNR	Habitat, T&E, Fishing	Low	High
Municipalities	Chicago – DWM, CDOT, various issues.	High	High
EPA	Lake Michigan Water Quality	Low	Low
Port Authority	NA		
Indiana	NA		
Env. Advocates	Various	Low	Low
USFWS	T&E, AIS	Low	Low
Legal - Regulatory	Various (use permits, construction, discharge)	High	High
Marinas	Increase access	High	High



**Barrier #18:** Chicago River

Key assumptions include:

- This location is only to be in conjunction with #19.
- Locks are maintained, but defaulted to the open position.
- Northplant effluent remains roughly 60% of dwf, with comparable wq.
- Loss of backflow outlet to lake during extreme storm events

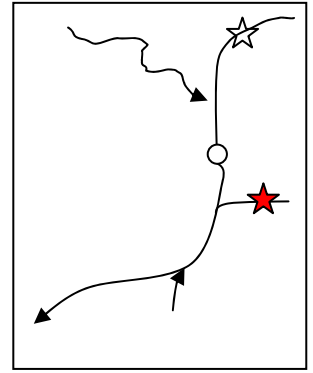

*Lakeside (Upstream)*

This is the most urbanized stretch of the river, adjacent to highrise apartments, hotels and offices. This reach – The Chicago River – is the primary route for recreational and commercial traffic to interface with Lake Michigan. The Chicago Controlling Works (locks, and sluice gates) are located at the lake interface. The riverbanks are low points, (Lower Wacker, Union Station) and have experienced periodic overbank flooding. WQ in this reach is currently high, due to diversionary flows both discretion and lockages. However, there is some concern over the quality of sediments which would now be located lakeside.

The proposed barrier would fall within this stretch, and create a lake embayment up to the barrier which would be consistent with lake water elevations.

**LAKESIDE of Barrier**

Condition During WET (CSO) Weather	Condition During DRY Weather
<p><b>EH:</b> The embayment may receive intermittent CSO discharges. Frequencies and volumes are TBD.</p>	<p><b>EH:</b> The barrier could create conditions of stagnation near the barrier. The barrier will prevent flows, and create backwater conditions – increasing with distance from the lake. This could result in low DO, and odorous conditions proximal to the barrier. Mitigation strategies are available to resolve this.</p>
<p><b>Flood:</b> Base elevations will increase from today, and reduce some channel capacity to convey flood water – however, the embayment will have an open outlet to the Lake through the locks. Overbank flooding is not expected to be a problem in the embayment. The higher base elevations will add some hydraulic pressure on CSO outlets and potentially increase basement flooding risk.</p>	<p><b>Flood:</b> NA</p>
<p><b>Trans:</b> NA</p>	<p><b>Trans:</b> As a major thoroughfare for water traffic, the barrier presents a problem for recreational, commercial and some industrial flow into the existing CAWS. The lakeside portion, however, could become a new asset for marina, or other recreational uses.</p>

*Riverside (downstream)*

Downstream of barrier location #18, is the south branch and the North Branches of the Chicago River. These rivers are currently industrial and a great deal of mixed use – from Kayak to Sand and gravel barges. The key downstream characteristics in a post barrier scenario are summarized as follows:

**RIVERSIDE of Barrier (flow away from Lake Michigan)**

Condition During WET (CSO) Weather	Condition During DRY Weather
<p><b>EH:</b> CSO frequency will be reduced due to TARP baseline, resulting in fewer CSO discharges.</p>	<p><b>EH:</b> There is no discretionary flow from lake, which may have some minor deleterious effect on WQ. However, reduced CSO discharges may have a positive trending effect on EH. Little if any change in EH is expected.</p>
<p><b>Flood:</b> There is a loss of an outlet to the Lake during extreme weather events. This increases the risk of local and downstream flooding. The river elevation is operated as is today, and the channel capacity will be as is today, but TARP will convey more storms, and a larger portion of each event, reducing the average risk. However, the lack of an outlet is of concern for extreme flooding events. (RAPS, NBPS, Gravity CSO, Tributary flows)</p>	<p><b>Flood:</b> NA</p>
<p><b>Trans:</b> NA</p>	<p><b>Trans:</b> The majority of industrial travel would not be impacted; commercial traffic would lose continuity between the lake and the river system, which is a large impact (~50%) to the commercial traffic, and the recreational boaters would be most impacted by lack of continuity between lake and river at this location. Many marinas and dry docks would be inaccessible from the lake.</p>

The following table indicates the identified stakeholder, potential impact, magnitude and probability of occurrence – without additional mitigation-given barrier location only. This table is intended to be representative, not a complete list.

Stakeholder	Impact	Magnitude	Probability
Proximal Residents	Less river traffic	Low	High
Industry	Minor	Low	High
Commercial Vessels	Minor	High	High
Recreational Boaters	Limit access	High	High
MWRD	Lose backflow	High	High
IDNR / USCOE	Diversion accounting	High	High
IDNR	Habitat, T&E, Fishing	Low	High
Municipalities	Chicago – DWM, CDOT, various issues.	High	High
EPA	Lake Michigan Water Quality	Low	Low
Port Authority	NA		
Indiana	NA		
Env. Advocates	Various	Low	Low
USFWS	T&E, AIS	Low	Low
Legal - Regulatory	Various (use permits, construction, discharge)	High	High
Marinas	Increase access	High	High



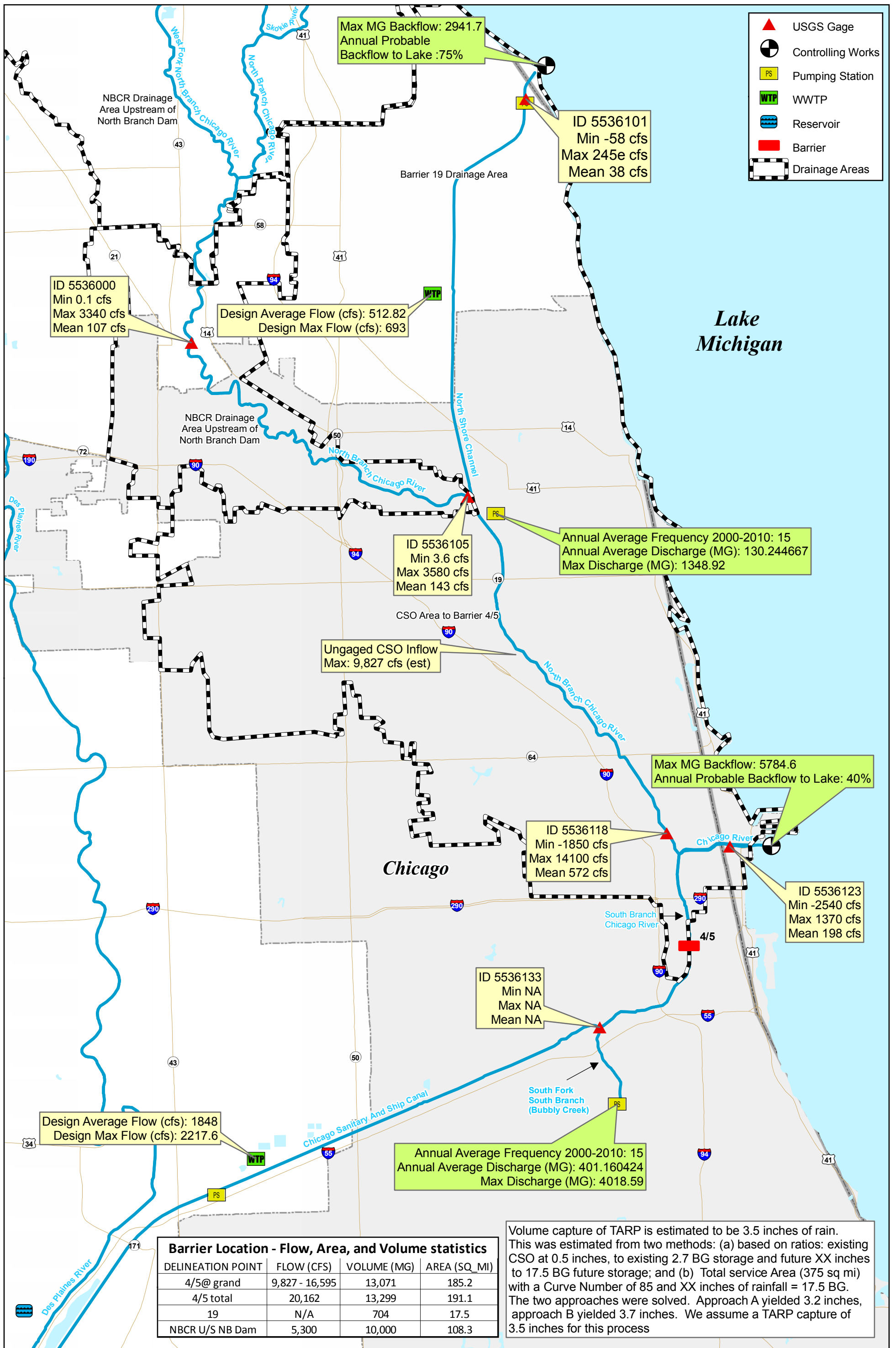

**Barrier #4/5:** South Branch Chicago River above Fisk Generating Station water intake, below Wolf Point.

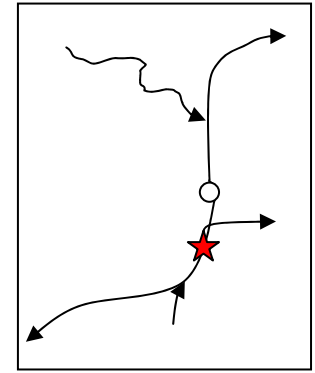

*Key Assumptions:*

- NSWWTP is treating to “Lake Standard”
- Fisk is operational
- RAPS is operational
- Barge traffic past this point will be eliminated
- Bubbly Creek Restoration (USCOE project) is not implemented

This barrier location moves a large portion of the CSO drainage area to Lake Michigan drainage, as well as the Northside WWTP discharge. This option maintains a large portion of the CAWS continuity with Lake Michigan.

*Lakeside (Upstream)*

Flood risk is mitigated with the two outlets, but is exacerbated by the raised river elevation. This will be a challenge to parse. Water in Basement is inherently at higher risk due to the higher river elevation. On the whole this location improves the WQ conditions of the upstream segments, but also exposes some increased risk of sediment pollution to the lake.

**LAKESIDE of Barrier**

**Condition During WET (CSO) Weather**

**EH:** A large portion of the river system is now considered lakeside, and driven by lake water quality and plant effluent which is now treated to new standards. This area will be exposed to intermittent CSO discharges, but at a reduced frequency due to TARP.

**Flood:** Base elevations will increase from today, and reduce the capacity to convey floodwaters. This upstream segment will have two open outlets, which will alleviate some of the flood conveyance concerns, but lake elevations could rise significantly compared to today. Overbank flooding remains a concern. The higher base elevations would also exacerbate the WIB risk, as more head will be need to access the outlet. (even if there is conveyance, due to the outlets, it will take higher hydraulic grades within the system to access the river).

**Trans:** NA

**Condition During DRY Weather**

**EH:** The barrier could create conditions of stagnation near the barrier. The barrier will prevent flows, and create backwater conditions – increasing with distance from the lake. This could result in low DO, and odorous conditions proximal to the barrier. Mitigation strategies are available to resolve this. On the whole, however, the ecological health of the entire upstream portion would be improved as a result of being lakeside.

**Flood:** NA

**Trans:** As a major thoroughfare for water traffic, the barrier presents a problem for recreational, commercial and some industrial flow into the existing CAWS. However, new recreational/ commercial opportunities due to improved EH may be discovered.

*Riverside (Downstream)*

The downstream conditions associated with this barrier location (4/5) can be summarized as follows:

**RIVERSIDE of Barrier (flow away from Lake Michigan)**

**Condition During WET (CSO) Weather**

**EH:** CSO frequency will be reduced due to TARP baseline, resulting in fewer CSO discharges.

**Flood:** There is a loss of an outlet to the Lake during extreme weather events. This increases the risk of local and downstream flooding. The river elevation is operated as is today, and the channel capacity will be as is today, but TARP will convey more storms, and a larger portion of each event, reducing the average risk. However, the lack of an outlet is of concern for extreme flooding events, especially as the location gets closer to RAPS / Bubbly Creek.

**Trans:** NA

**Condition During DRY Weather**

**EH:** There is no discretionary flow from lake, which may have some minor deleterious effect on WQ. However, reduced CSO discharges may have a positive trending effect on EH. Little if any change in EH is expected.

**Flood:** NA

**Trans:** The majority of industrial travel would not be impacted; commercial traffic would maintain most of its activity with the exception of some non-revenue operations between lake, river and downstream. The recreational boaters would lose access to some dry dock and marinas, but few travel past this reach for recreational purposes.

The following table indicates the identified stakeholder, potential impact, magnitude and probability of occurrence – without additional mitigation-given barrier location only. This table is intended to be representative, not a complete list.

Stakeholder	Impact	Magnitude	Probability
Proximal Residents	Change flows and WQ in neighborhood, recreation	Low	High
Industry	River barrier	Low	High
Commercial Vessels	River barrier – Loss of River route to dry dock	Low	High
Recreational Boaters	Barrier to many points	High	High
MWRD	Lose backflow, gain efficiency in drawdown	High	High
IDNR / USCOE	Diversion accounting	High	High
IDNR	Lake Species in the River – (salmon etc)	Low	High
Municipalities	Chicago – DWM, CDOT, various issues.	High	High
EPA	Lake Michigan Water Quality	Low	High
Port Authority	Reroute commercial barge traffic to Calumet	Low	High
Indiana	NA		
Env. Advocates	Various	Med	High
USFWS	T&E, AIS	Low	Low
Legal - Regulatory	Various (use permits, construction, discharge)	High	High
Marinas	Disrupt access for some	High	High

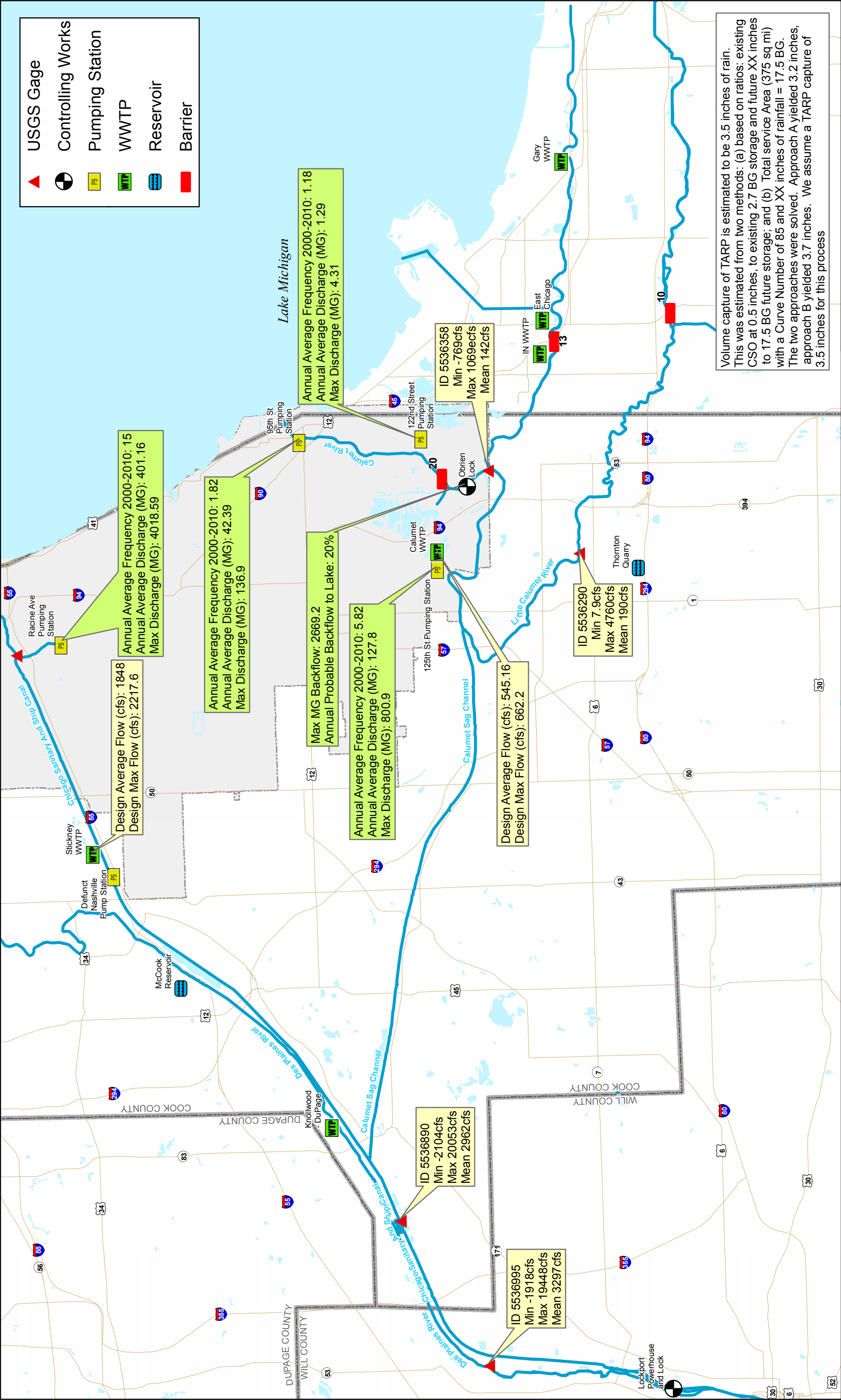

**Legend:**

- USGS Gage (Red triangle)
- Controlling Works (Black circle with cross)
- Pumping Station (Yellow square with PS)
- WWTP (Green square with WTP)
- Reservoir (Blue rectangle with wavy lines)
- Barrier (Red rectangle)

Volume capture of TARP is estimated to be 3.5 inches of rain. This was estimated from two methods: (a) based on ratios: existing CSO at 0.5 inches, to existing 2.7 BG storage and future XX inches to 17.5 BG future storage; and (b) Total service Area (375 sq mi) with a Curve Number of 85 and XX inches of rainfall = 17.5 BG. The two approaches were solved. Approach A yielded 3.2 inches, approach B yielded 3.7 inches. We assume a TARP capture of 3.5 inches for this process

**HDR**

Scale: 0, 0.75, 1.5, 3 Miles

North arrow and location icon



**Barrier #20:** Calumet River – Lakeside of Lake Calumet confluence

The proposed barrier location, #20 is roughly 1.0 river miles upstream of the O’Brien Locks. It would obviate the need to operate the O’Brien Locks. Lake Calumet would switch from being a lakeside lake, to a riverside (downstream) lake. Inherent in this location is a redesign of the port system within the Calumet River.

The barrier is positioned to maintain penetration of Lakers / Salties from Lake Michigan, while allowing barge traffic to arrive as far upstream as possible to interface with goods options across the barrier.

There is recreational traffic, with most, or all, of the recreational marinas are riverside of the O’Brien Locks. The frequency of overbank flooding in the Calumet is limited, with the exception of the Little Calumet River in Indiana.

The Calumet River is currently driven hydraulically by Lake Michigan, and is approximately 2 feet higher than the separation point at the O’Brien Lock. Water quality is poor, and landuse is heavily industrial, supported by the waterway movement of goods. Lake Calumet would become riverside, resulting in changes to WQ and water elevations, possibly uses including flood storage.

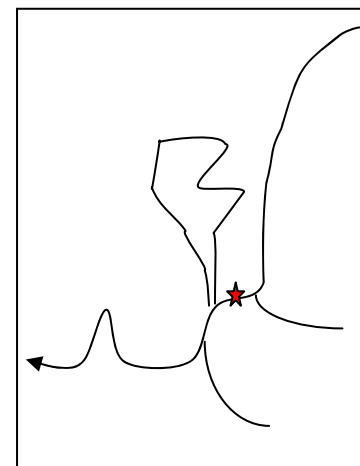

**LAKESIDE of Barrier**

Condition During WET (CSO) Weather	Condition During DRY Weather
<p><b>EH:</b> There would be no expected change to the WQ in this reach of the Calumet River.</p>	<p><b>EH:</b> The barrier could create conditions of stagnation near the barrier. The barrier will prevent flows, and create backwater conditions – increasing with distance from the lake. (Existing conditions allow the movement of water through the locks, reducing the stagnation). This could result in low DO, and odorous conditions proximal to the barrier. Mitigation strategies are available to resolve this. Furthermore, Lake Calumet would become riverside, and more susceptible to river level changes. Water elevations would decrease from lake level to river level.</p>
<p><b>Flood:</b> No change in overbank or WIB flooding in this river reach is expected with this barrier location.</p>	<p><b>Flood:</b> NA</p>
<p><b>Trans:</b> NA</p>	<p><b>Trans:</b> This is a major industrial corridor. Any barrier will impact the movement of goods, in this case, especially goods that move via barge. Furthermore, recreational traffic that currently proceeds between the Calumet River and the Little Calumet or CalSag is eliminated.</p>

The downstream reach associated with location #20 can be summarized as follows:

**RIVERSIDE of Barrier (flow away from Lake Michigan)**

Condition During WET (CSO) Weather	Condition During DRY Weather
<p><b>EH:</b> CSO frequency will be reduced due to TARP baseline, resulting in fewer CSO discharges. Flows will be dominated by the plant effluent, the Grand and Little Calumet discharge.</p>	<p><b>EH:</b> There is no discretionary flow from lake, which may have some minor deleterious effect on WQ. However, reduced CSO discharges may have a positive trending effect on EH. Little if any change in EH is expected.</p>
<p><b>Flood:</b> There is a loss of an outlet to the Lake during extreme weather events. This increases the risk of overbank flooding – however, Lake Calumet would now offer potential flood storage. The river elevation is operated as is today, and the channel capacity will be as is today, but TARP will convey more storms, and a larger portion of each event, reducing the average risk of flooding.</p>	<p><b>Flood:</b> NA</p>
<p><b>Trans:</b> NA</p>	<p><b>Trans:</b> Barge traffic could operate up to the barrier, but would then need a different handling mechanism. This barrier location includes the notion of opening Lake Calumet to the additional barge traffic as a mitigating measure. But overall, the barge and recreational traffic is greatly impacted by being denied access to Lake Michigan.</p>

The following table indicates the identified stakeholder, potential impact, magnitude and probability of occurrence – without additional mitigation-given barrier location only. This table is intended to be representative, not a complete list.

Stakeholder	Impact	Magnitude	Probability
Proximal Residents	Changes to river traffic, less lake access	Low	High
Industry	High	High	High
Commercial Vessels	High	High	High
Recreational Boaters	Limited access	High	High
MWRD	Lose backflow	High	High
IDNR / USCOE	Diversion accounting	High	High
IDNR	Habitat, T&E, Fishing	Low	High
Municipalities	Chicago – DWM, CDOT, various issues.	High	High
EPA	Lake Michigan Water Quality	Low	Low
Port Authority	Constrains / changes commerce activity	High	High
Indiana	Flooding and Ports activity	High	High
Env. Advocates	Various	Low	Low
USFWS	T&E, AIS	Low	Low
Legal - Regulatory	Various (use permits, construction, discharge)	High	High
Marinas	Increase access	High	High

**USGS Gage**

**Controlling Works**

**Pumping Station**

**WWTP**

**Reservoir**

**Barrier**

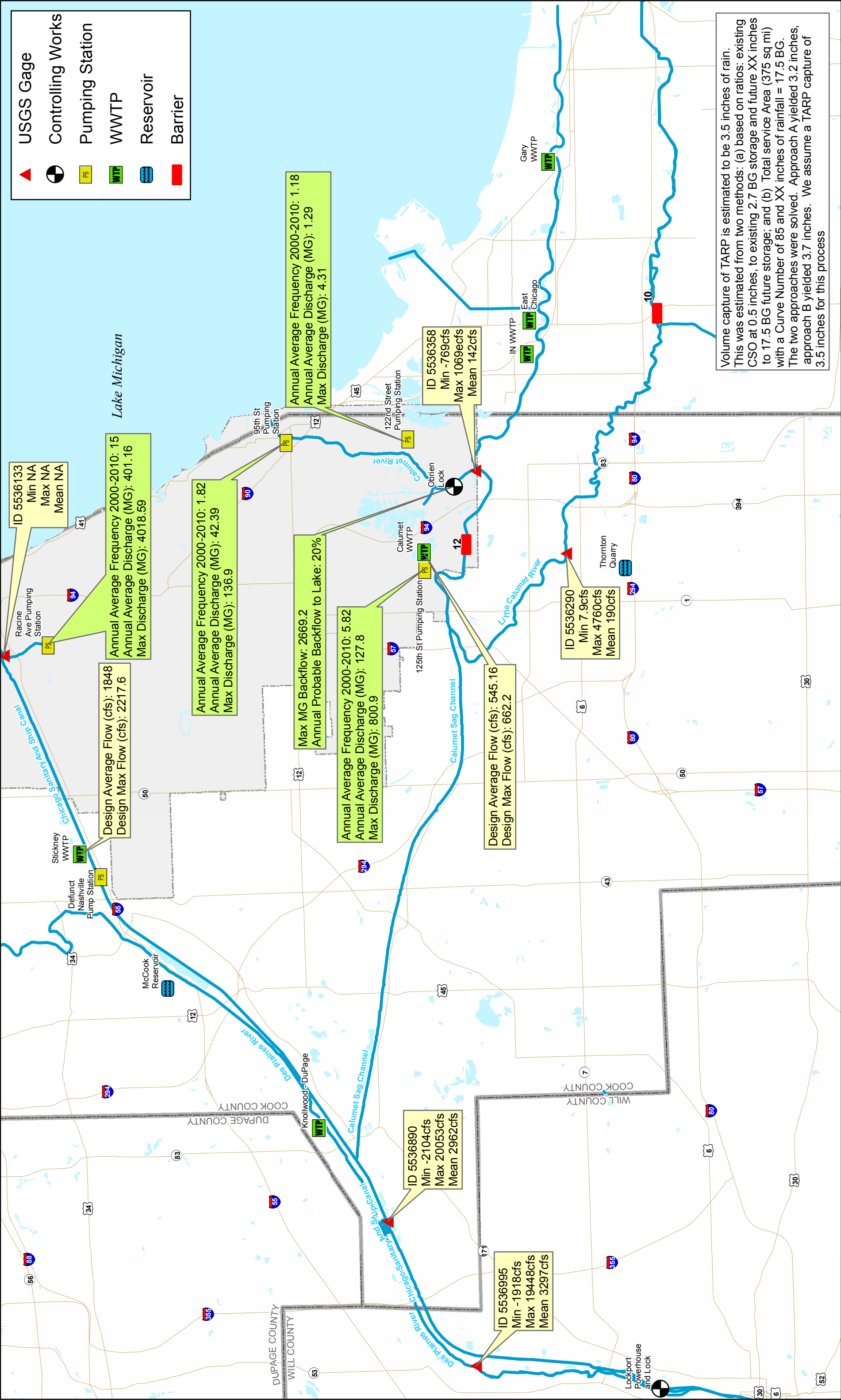

ID 5536133  
Min NA  
Max NA  
Mean NA

Annual Average Frequency 2000-2010: 15  
Annual Average Discharge (MG): 401.16  
Max Discharge (MG): 4018.59

Design Average Flow (cfs): 1848  
Design Max Flow (cfs): 2217.6

Annual Average Frequency 2000-2010: 1.82  
Annual Average Discharge (MG): 42.39  
Max Discharge (MG): 136.9

Max MG Backflow: 2669.2  
Annual Probable Backflow to Lake: 20%

Annual Average Frequency 2000-2010: 5.82  
Annual Average Discharge (MG): 127.8  
Max Discharge (MG): 800.9

Design Average Flow (cfs): 545.16  
Design Max Flow (cfs): 662.2

ID 5536290  
Min 7.9cfs  
Max 4760cfs  
Mean 190cfs

Annual Average Frequency 2000-2010: 1.18  
Annual Average Discharge (MG): 1.29  
Max Discharge (MG): 4.31

ID 5536890  
Min -2104cfs  
Max 20053cfs  
Mean 2962cfs

ID 5536995  
Min -1918cfs  
Max 19448cfs  
Mean 3297cfs

ID 5536358  
Min -769cfs  
Max 1069cfs  
Mean 142cfs

Volume capture of TARP is estimated to be 3.5 inches of rain. This was estimated from two methods: (a) based on ratios: existing CSO at 0.5 inches, to existing 2.7 BG storage and future XX inches to 17.5 BG future storage; and (b) Total service Area (375 sq mi) with a Curve Number of 85 and XX inches of rainfall = 17.5 BG. The two approaches were solved. Approach A yielded 3.2 inches, approach B yielded 3.7 inches. We assume a TARP capture of 3.5 inches for this process



Miles  
0 0.75 1.5 3





**Barrier #10**

Little Calumet River South at hydrologic summit/divide (State of Indiana)

*Direction of waterway flow: Towards Lake Michigan*

The Little Calumet River South (east of hydrologic summit) will flow into Lake Michigan through Burns Ditch (no change in flow direction).

There will be no change in the ecological integrity of the Little Calumet River South (east of the hydrologic summit).

**What is the mitigation strategy that will ensure that separate storm water outfalls discharging to the Little Calumet River South (east of the hydrologic summit) during a significant rain event (6-8") will not cause basement flooding and overbank flooding along the Little Calumet River South (east of the hydrologic summit) and tributaries in Indiana, and will not overflow the physical barrier on the Little Calumet River South?**

*Direction of waterway flow: Towards Little Calumet River North (State of Illinois)*

The Little Calumet River South (west of the hydrologic summit) will flow into the Little Calumet River North (no change in flow direction).

There will be no change in the ecological integrity of the Little Calumet River North (west of the hydrologic divide).

**What is the mitigation strategy that will ensure that separate storm water outfalls discharging to the Little Calumet River South (west of hydrologic summit) during a significant rain event (6-8") will not cause basement flooding and overbank flooding along the Little Calumet River South (west of hydrologic summit) and tributaries in Illinois, and will not overflow the physical barrier on the Little Calumet River South?**

**Barrier #13**

Grand Calumet River at hydrologic summit/divide (State of Indiana)

*Direction of waterway flow: Towards Lake Michigan*

The Grand Calumet River (east of hydrologic divide) will flow into Lake Michigan through the Indiana Harbor Canal (no change in flow direction).

There will be no change in the ecological integrity of the Grand Calumet River (east of hydrologic divide).

**What is the mitigation strategy that will ensure that combined and separate storm water outfalls discharging to the Grand Calumet River (east of hydrologic summit) during a significant rain event (6-8") will not cause basement flooding and overbank flooding along the Grand Calumet River (east of hydrologic summit), and will not overflow the physical barrier on the Grand Calumet River?**

*Direction of waterway flow: Towards Little Calumet River North (State of Illinois)*

The Grand Calumet River (west of hydrologic summit) will flow into the Little Calumet River North (no change in flow direction).

There will be no change in the ecological integrity of the Grand Calumet River (west of hydrologic summit).

**What is the mitigation strategy that will ensure that combined sewers discharging to the Grand Calumet River (west of hydrologic summit) during a significant rain event (6-8") will not cause basement flooding and overbank flooding along the Grand Calumet River (west of hydrologic summit), and will not overflow the physical barrier on the Grand Calumet River?**

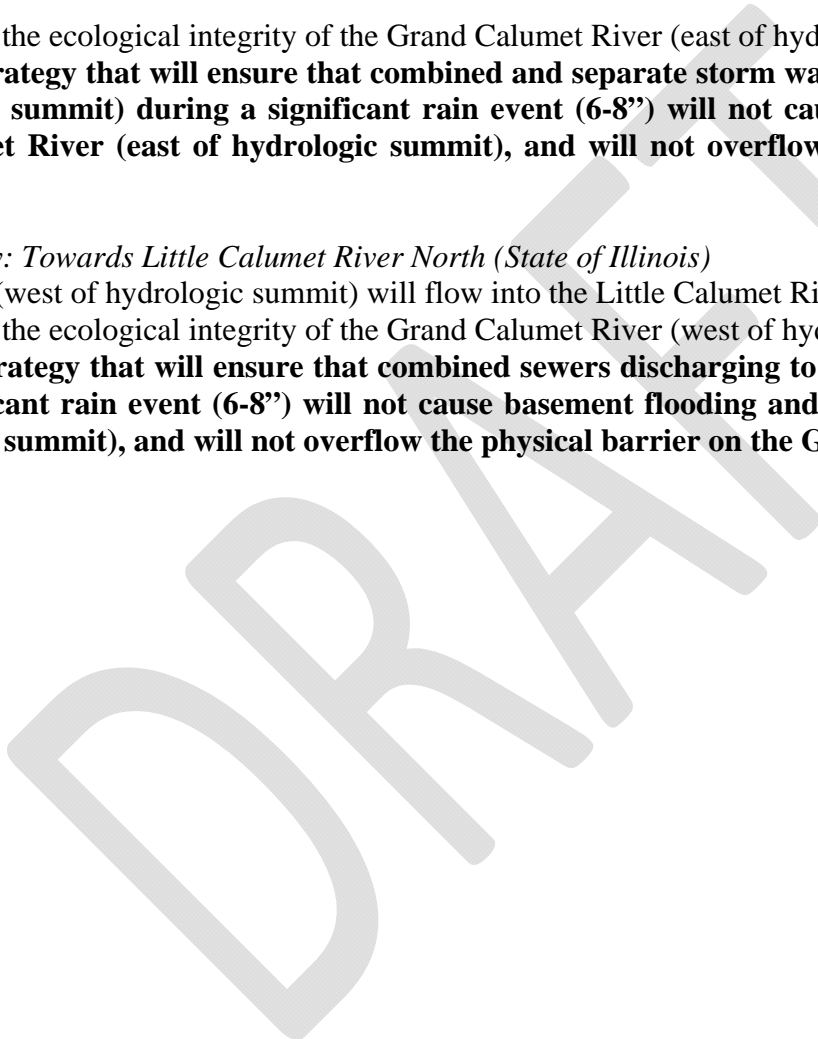

WWTP NAME	Receiving water	Design Avg Flow (DAF) CFS	Design Max Flow (DMF) CFS	Treatment	Rivermile outfall
Northside_Plant_WWTP	NSC	512.82	693	2ndary, act sludge	336.9
Stickney_WWTP	SSC	1848	2217.6	2ndary, act sludge	315.5
Calumet_WWTP	Little Calumet	545.16	662.2	2ndary, act sludge	321.4
Lemont_WWTP	SSC	3.542	3.85	2ndary, act sludge	300.6

TARP SYSTEM	Length (miles)	Volume (MG)	Reservoirs	Capacity
Mainstream	40.5	1200	McCook	10 BG
Calumet	36.7	630	Thornton	4.8*
DesPlaines	25.6	405	McCook	

Pump Station	Receiving water	Annual Avg freq (2000-2010)	Annual Average discharge MG	Max discharge MG	Rivermile outfall
122nd Street Pumping Station	Calumet River	1	1.3	4.3	
125th St Pumping Station	Little Cal	6	127.8	800.9	321.4
95th St Pumping Station	Calumet River	2	42.4	136.9	
Northbranch Pumping Station	NBCR	15	130.2	1348.9	333.1
Racine Ave Pumping Station	SFSBCR	15	401.2	4018.6	321.7

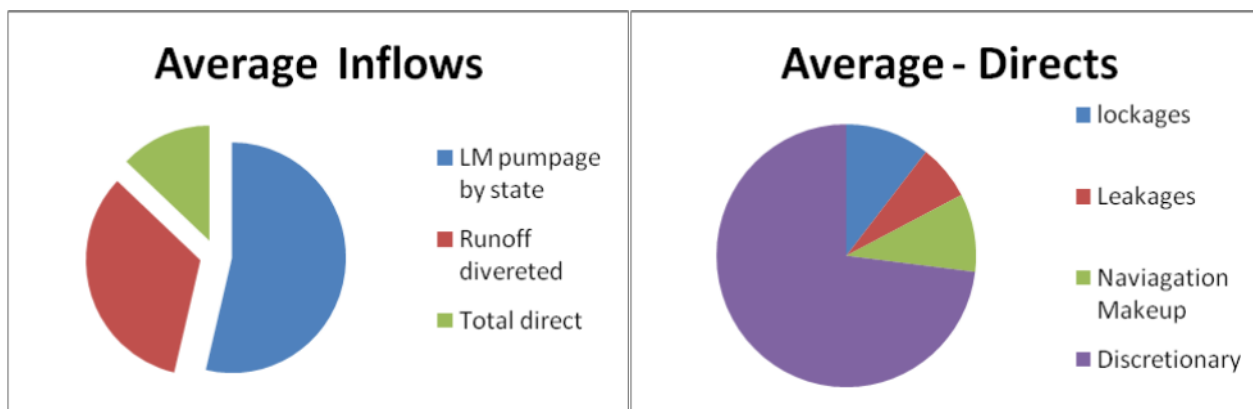

LM Control Structures	2006 Direct Diversions (cfs)	2007 Direct Diversions (cfs)	Typical (cfs)	Typical MGD
Wilmette	47.5	33	40	26
Chicago	180.6	198	189	122
OBrien	127.6	130	129	83
Total direct	355.7	361	358	232

Control Structures - FLOWS	AVG backflow MG	MAX MG backflow	annual prob backflow to lake
Wilmette	449	2942	75%
Chicago	1960	5785	40%
Obrien	1346	2669	20%
Lockport	0	0	0%

Supplemental Aeration	
Name	Rivermile
SEPA Station No. 5 at Junction	303.4
SEPA Station No. 4 at Worth (Harlem Ave)	311.7
SEPA Station No. 3 at Blue Island	318
SEPA Station No. 2 at 127th St	321.3
Webster Avenue Instream Aeration Station	328.9
Devon	
SEPA Station No. 1 at Torrence	

Barge POI	River mile	Phone	Waterway
Kinder Morgan (Arrow Terminal- Lake Cal)	327.1- 327.3	773-646-8000	Lake Calumet
St. Mary's Cement	327.1- 327.3	773-995-5100	Lake Calumet
Kinder Morgan (Stolt)	327.1- 327.3	773-646-4440	Lake Calumet
Emesco	327.1- 327.3	773-646-2100	Lake Calumet
Maryland Pig	327.1- 327.3	773-646-2080	Lake Calumet
Metal Management	327.1- 327.3	773-251-2915	Lake Calumet
Reserve Marine- Sheds	327.1- 327.3	773-382-0115	Lake Calumet

Number	Station Name	Period of record (daily discharge)	Comments	Min Q	Max Q	Mean Q	Min Stage	Max Stage
				(cfs)	(cfs)	(cfs)	(feet)	(feet)
5536000	NORTH BRANCH CHICAGO RIVER AT NILES, IL	10/01/1950-present	Minimum flow is a mean daily value.	0.1	3340	107		
5536101	NORTH SHORE CHANNEL AT WILMETTE, IL	10/01/1996 -09/30/2003	Max discharge is a mean daily discharge estimated by regression.	-58	245e	38		
5536105	NB CHICAGO RIVER AT ALBANY AVE AT CHICAGO, IL	10/01/1989 - present		3.6	3580	143		
5536118	NB CHICAGO RIVER AT GRAND AVE AT CHICAGO, IL	07/02/2002-present		-1850	14100	572		
5536123	CHICAGO RIVER AT COLUMBUS DRIVE AT CHICAGO, IL	10/01/1996 – 09/30/2006	Minimum discharge is a mean daily discharge (backflow Feb 21, 1997).	-2540	1370	198		
Number	Station Name	Period of record	Comments					
5536358	CALUMET R. BELOW O'BRIEN LOCK AND DAM AT CHICAGO, IL	10/01/1996-03/30/2005	Max discharge is an estimated mean daily value.	-769	1069e	142		
5536290	LITTLE CALUMET RIVER AT S. HOLLAND, IL	10/01/1947- present		7.9	4760	190		
5536357	GRAND CALUMET R. AT HOHMAN AVE AT HAMMOND, IN	10/01/1991-present		0.00	701	25		
5536131	SFSBR CHICAGO RIVER (BUBBLY CREEK) AT 36 <sup>TH</sup> ST AT CHICAGO, IL	07/26/2009-09/30/2010	(approximate dates_side-looking ADCP velocity data).	NA	NA	NA		
5536133	SFSBR CHICAGO RIVER (BUBBLY CREEK) AT I-55 AT CHICAGO, IL	04/07/2010-09/30/2010	(approximate dates_side-looking ADCP velocity data).	NA	NA	NA		
5536995	CSSC AT ROMEOVILLE	10/01/1984-09/30/2005		-1918	19448	3297		
5536890	CSSC NEAR LEMONT, IL	12/07/2004-present	Additional temperature and conductivity data available also.	-2104	20053	2962		
5536140	CSSC AT STICKNEY, IL	10/01/2007-present	Discharge not available at this time--only stage					
Number	Station Name	Period of record	Comments					
5536121	CHICAGO RIVER AT CHICAGO LOCK AT CHICAGO, IL	08/01/1997-present	Min/max stage readings only. (Chicago City Datum)	NA	NA	NA	-3.27	4.14
4087440	LAKE MICHIGAN AT CHICAGO LOCK	08/01/1997-present (stage only)	Min/max stage readings only. (Chicago City Datum)-affected by wave action.	NA	NA	NA	-3.79	3.84

Summary Of Mitigation Choices

**Mitigation TABLE 1: OVERBANK FLOODING**

	<b>Example</b>	<b>Pros</b>	<b>Cons</b>	<b>Capital per unit volume</b>	<b>Ancillary Values (WIB, Aesthetic, Wildlife, Heat Island, Climate, etc)</b>
<b>STORAGE</b>					
Surface - floodplain	Forest Preserve on North Branch	Return Natural hydrology	Cook county Forest Preserve	\$	High (Aesthetic, hydrology, etc)
Surface-Hole	McCook Reservoir	Proven, effective	Few additional values	\$	Low
Subsurface - dead	Deep cavity pumped up	Small footprint, drain under management control	Pump operations, energy, O&M	\$\$	Med (WIB)
Subsurface-detained	Deep Cavity, restricted outlet to TARP	Smallest footprint, low energy, Proven	Blockage, cleaning	\$\$	Med (WIB)
Subsurface - surge	Surcharge pool for local sewers	Local benefit, distributed	Distributed, maintenance, limited capacity	\$\$\$	Med
<b>IN-FLOW REDUCTION</b>					
Roadway restriction	Catch basin constraints	Reduce ROW flows	Maintenance	\$	Med (WIB)
Reduce Effective Impervious	Porous pavers, downspouts disconnections	Low energy, low cost, shared responsibility	Uncertainties of maintenance greements – limits utility commitments	\$	Med (Green, WIB)
Increase Tree canopy	Plant trees	Green,	Minimal impact	\$	High (Green, wildlife, climate, AQ, etc)
<b>CONVEYANCE</b>					
reroute sewer lake	Direct CSO area to lake	Conveyance – not treatment	Moves problem	\$\$	Low
reroute sewer downstream	Direct CSO basin past the barrier	Reduces CSO to Lake	Moves problem	\$\$	Low
Channel Modification	Widen channel	Non-sewer solution	Limited reality, bottleneck opening	\$\$\$	Med (transportation)
<b>PLANT MODIFICATION</b>					
Split Flows% to lake	NSWRP discharge to lake as needed	Effective stage control, tertiary treatment, improves WQ	Untested, additional management	\$\$\$	High (WQ)
<b>SPILLWAY</b>					
Sidestream	Side channel	Conveyance = channel capacity	Land, little value other than spilling, Breaks Boundary Rule	\$	Low
Siphon	Pass flows under barrier	Conveyance increase, management controls		\$\$	Low
Barrier Weir	Pass flows over weir	Conveyance increase, management controls	Breaks Boundary Rule	\$	Low
Sand Filter Barrier	Pass flows through barrier	WQ improvements	Breaks Boundary Rule	\$	Med (WQ)

Summary Of Mitigation Choices

**MITIGATION TABLE 2: Ecological Integrity**

	<b>Example</b>	<b>Pros</b>	<b>Cons</b>	<b>Construction Capital</b>	<b>Ancillary Values (Aesthetic, Recreational, etc)</b>
<b>Riverbank Restoration</b>					
River edge	Soften, Add banks, reduce slope	Increase habitat opportunities	Reduce capacity	\$\$	Access, visual
Build habitat	Tree Planting	Shading, cooling water, habitat benefit	Maintenance	\$	Climate change, AQ, aesthetic
Clear invasive plants	Eradicate Buckthorn	Complimentary to mission	Maintenance	\$	Reduce invasive, aesthetic
<b>Aeration</b>					
Machine	SEPA / Blowers	Managed, proven	Cost, Land, Maintenance	\$\$	
Natural	Build Riffles	Recreation, natural	Channel modifications	\$	Recreation, aesthetic
<b>Sediment Mitigation</b>					
Dredge	Hydraulic dredge	Removal	relocate	\$\$	Opening channel
Cap	Synthetic cap, clay barrier	In situ	Still there	\$\$	Potential remediation
<b>Strategic Sewer Separation</b>					
Capitalize on Storm flows	Separate basin sewers	More frequent flows	Flows not clean	\$\$	
<b>RE-route Facility Flows</b>					
Redirect WWTP	NS WRP	Manage elevations, improve WQ	Expensive, additional treatment to Lake Std	\$\$\$	
Redirect PS	RAPS – divert portion	Manage elevations, improve WQ	Expensive, additional treatment to Lake Std	\$\$\$	
<b>Permeable Barrier</b>					
Flow through	Sand filter duct	Early phasing, reduce pumping, reduce stagnation	Basin transfer of water	\$	
Flow Under	Siphon	Flow control, reduce stagnation	Basin transfer of water	\$	
Flow Over	spillway	Flow control, reduce stagnation	Basin transfer of water	\$	





#### **B4. PRELIMINARY EVALUATION OF ALTERNATIVES**

- ALTERNATIVES EVALUATION SUMMARIES 8-24-11
- INVESTMENTS/IMPROVEMENTS EVALUATION SUMMARIES 8-24-11
- DETAILED TIMELINES



# Evaluation of Separation Alternatives Summary - Potential Challenges

**\*\*WORK IN PROGRESS AUGUST 2011\*\***

## Challenges

Positive

Neutral

Negative

Extensive Investment Required

Not Applicable

Category		Near Lake					
		North Shore Channel and Chicago Lock			Calumet, Grand Calumet, Little Calumet Rivers		
		Overall	Near Term Implementation	Long Term Implementation	Overall	Near Term Implementation	Long Term Implementation
Prevent AIS Transfer							
Transportation	Existing Freight Movement						
	New Cargoes	N/A	N/A	N/A			
	Recreational						
	Tour Boats/Water Taxis				N/A	N/A	N/A
Stormwater Management							
Ecological Health	CSOs (WQ)	N/A		N/A	N/A	N/A	N/A
	Contaminated Sediments						
	Flow Augmentation						
	WRP Improvements						

Category		Mid-System					
		South Branch			Lake Calumet, Grand Calumet, Little Calumet		
		Overall	Near Term Implementation	Long Term Implementation	Overall	Near Term Implementation	Long Term Implementation
Prevent AIS Transfer							
Transportation	Existing Freight Movement						
	New Cargoes	N/A	N/A	N/A			
	Recreational						
	Tour Boats/Water Taxis				N/A	N/A	N/A
Stormwater Management							
Ecological Health	CSOs (WQ)	N/A		N/A	N/A	N/A	N/A
	Contaminated Sediments						
	Flow Augmentation						
	WRP Improvements						

Category		Down River		
		CSSC/Cal-Sag Confluence		
		Overall	Near Term Implementation	Long Term Implementation
Prevent AIS Transfer				
Transportation	Existing Freight Movement			
	New Cargoes			
	Recreational			
	Tour Boats/Water Taxis	N/A	N/A	N/A
Stormwater Management				
Ecological Health	CSOs (WQ)			
	Contaminated Sediments			
	Flow Augmentation			
	WRP Improvements			

# Down River Alternative - Potential Challenges

**\*\*WORK IN PROGRESS AUGUST 2011\*\***

## Challenges

Positive

Neutral

Negative

Extensive Investment Required

Not Applicable

Category	Down River		
	CSSC/Cal-Sag Confluence		
	Overall	Near Term Implementation	Long Term Implementation
Prevent AIS Transfer			
Transportation	Existing Freight Movement		
	New Cargoes		
	Recreational		
	Tour Boats/Water Taxis	N/A	N/A
Stormwater Management			
Ecological Health	CSOs (WQ)		
	Contaminated Sediments		
	Flow Augmentation		
	WRP Improvements		

Category	Down River			
	CSSC/Cal-Sag Confluence			
	Overall	Near Term Implementation	Long Term Implementation	
Prevent AIS Transfer				
Transportation	Existing Freight Movement	Severe impact to all freight movement on Cal-Sag Channel. Requires modal transfer or 2nd handling of cargo. No laker to barge interface.	Severe impact to all freight movement on Cal-Sag Channel. Requires modal transfer or 2nd handling of cargo.	Severe impact to all freight movement on Cal-Sag Channel. Requires modal transfer or 2nd handling of cargo. Limited to barge to barge transfer.
	New Cargoes	Potential exists, but is limited due to increased handling costs of barge to barge transfer.	Market timing indicates opportunity in 2015 timeframe based on Panama Canal expansion, but only for barge to barge transfer	Reduced opportunity to capture new market based on Panama Canal expansion (2015)
	Recreational	Recreational access to Lake Michigan from downstream of barrier eliminated. Improvements would provide transfer over barrier.	Recreational access to Lake Michigan from downstream of barrier eliminated.	Recreational access to Lake Michigan from downstream of barrier eliminated. With full improvement, would transfer over barrier.
	Tour Boats/Water Taxis	N/A	N/A	N/A
Stormwater Management	CAWS elevation controlled by lake elevation. Reduced outlet capacity relative to drainage area. Improvements would be needed to increase conveyance and storage.	Increased risk of flooding for moderate and larger storms with impermeable barrier until improvements is completed. Comparable AIS and flood risk management could be achieved with operational modification to Lockport.	Flood risk protection is equal to or better than existing conditions post barrier with additional conveyance and augmented TARP/additional storage.	
Ecological Health	Combined Sewer Overflows (Water Quality)	N/A - Permitting and regulatory changes will be required for discharge of CSOs lakeside of barrier. With TARP completion, CSO frequency is assumed acceptable.	Prior to TARP completion, permitting and regulatory changes required for discharge of CSOs lakeside of barrier are unlikely to be approved.	N/A - Permitting and regulatory changes will be required for discharge of CSOs lakeside of barrier. With TARP completion, CSO frequency is assumed acceptable.
	Contaminated Sediments	Removal of contaminated sediments will be required the length of the CAWS.	Removal of contaminated sediments will be required the length of the CAWS.	Removal of contaminated sediments will be required the length of the CAWS.
	Flow Augmentation	Flow augmentation may be required from Stickney to confluence of Cal-Sag channel and lakeside of Cal-Sag channel. Negatively impact flow riverside of barrier.	Flow augmentation may be required from Stickney to confluence of Cal-Sag channel and lakeside of Cal-Sag channel. Negatively impact flow riverside of barrier.	Flow augmentation may be required from Stickney to confluence of Cal-Sag channel and lakeside of Cal-Sag channel. Negatively impact flow riverside of barrier.
	Water Reclamation Plants Improvements	All treatment plants upgraded to tertiary treatment and bioaccumulative chemical removal	All treatment plants upgraded to tertiary treatment and bioaccumulative chemical removal	All treatment plants upgraded to tertiary treatment and bioaccumulative chemical removal

# Mid-System Alternative - Potential Challenges

**\*\*WORK IN PROGRESS AUGUST 2011\*\***

Challenges

Positive

Neutral

Negative

Extensive Investment Required

Not Applicable

Category	Mid-System					
	South Branch			Lake Calumet, Grand Calumet, Little Calumet		
	Overall	Near Term Implementation	Long Term Implementation	Overall	Near Term Implementation	Long Term Implementation
Prevent AIS Transfer						
Transportation	Existing Freight Movement					
	New Cargoes	N/A	N/A	N/A		
	Recreational					
Stormwater Management	Tour Boats/Water Taxis				N/A	N/A
	CSOs (WQ)	N/A		N/A	N/A	N/A
Ecological Health	Contaminated Sediments					
	Flow Augmentation					
	WRP Improvements					

Category	Mid-System						
	South Branch			Lake Calumet, Grand Calumet, Little Calumet			
	Overall	Near Term Implementation	Long Term Implementation	Overall	Near Term Implementation	Long Term Implementation	
Prevent AIS Transfer							
Transportation	Existing Freight Movement	All freight movement north of barrier is affected.	Northbound freight would be diverted south; Southbound freight diverted to Chicago Lock.	Northbound freight would be diverted south; Southbound freight diverted to Chicago Lock.	Laker access to Calumet River and Lake Calumet maintained. Inland and intra-lake barge movement to Cal-Sag River eliminated.	Inland and intra-lake barge movement to Cal-Sag River eliminated. Without full mitigation, barge interface with Calumet River operations eliminated. Requires modal shift.	Inland and intra-lake barge movement to Cal-Sag River eliminated. With full mitigation, barge interface with Calumet River operations modified. Inbound and outbound traffic at barrier transferred.
	New Cargoes	N/A	N/A	N/A	Potential exists.	Market timing indicates opportunity in 2015 timeframe based on Panama Canal expansion, but only if new port in place	Reduced opportunity to capture new market based on Panama Canal expansion (2015)
	Recreational	Opportunity to expand marinas and recreational activity with increased access to lake. Some loss of access to dry docks.	Without full mitigation, severing access to Lake Michigan from downstream of barrier.	With full mitigation, boats will be lifted over barrier. Opportunity to expand marinas and recreational activity with increased access to lake. Some loss of access to dry docks.	Recreational access to Lake Michigan from downstream of barrier eliminated. Mitigation would provide transfer over barrier.	Recreational access to Lake Michigan from downstream of barrier eliminated.	Recreational access to Lake Michigan from downstream of barrier eliminated. With full mitigation, would transfer over barrier.
	Tour Boats/Water Taxis	Impacts on tour boats or water taxis for maintenance and dry dock purposes. Requires new maintenance/dry dock north of barrier. Chicago lock permanently open.	Impacts on tour boats or water taxis for maintenance and dry dock purposes. Requires new maintenance/dry dock north of barrier. Chicago lock permanently open.	Impacts on tour boats or water taxis for maintenance and dry dock purposes. Requires new maintenance/dry dock north of barrier. Chicago lock permanently open.	N/A	N/A	N/A
Stormwater Management	CAWS elevation controlled by lake elevation. Under high lake level conditions, overbank and water in basement flooding risk may increase. Below RAPS operation trigger (moderate storms or smaller) water in basement flooding risk reduction.	<u>Lakeside:</u> Except for high lake conditions (10 to 20 year cycle), flood risk protection for lakeside is equal to or better than existing conditions. During high lake conditions, flood risk may increase. <u>Riverside:</u> Flood risk protection for CAWS is equal to or better than existing conditions for small storms post barrier. Flood risk may increase for storms with large flows from RAPS.	<u>Lakeside:</u> Flood risk protection is equal to or better than existing conditions post barrier. <u>Riverside:</u> Flood risk protection for CAWS is equal to or better than existing conditions post barrier.	Loss of outlet to Lake Michigan. Mitigation would be needed to increase storage for extreme events.	<u>Calumet River:</u> Increased risk of flooding with impermeable barrier until mitigation is completed. TARP completion (Thornton reservoir) in 2015 reduces risk. Comparable AIS and flood risk management could be achieved with operational modification to O'Brien. <u>Grand &amp; Little Calumet:</u> Increased risk of flooding with impermeable barrier until mitigation is completed.	Flood risk protection is equal to or better than existing conditions post barrier with augmented TARP/additional storage.	
Ecological Health	Combined Sewer Overflows (Water Quality)	N/A - Permitting and regulatory changes will be required for discharge of CSOs lakeside of barrier. With TARP completion, CSO frequency is assumed acceptable.	Prior to TARP completion, permitting and regulatory changes required for discharge of CSOs lakeside of barrier are unlikely to be approved.	N/A - Permitting and regulatory changes will be required for discharge of CSOs lakeside of barrier. With TARP completion, CSO frequency is assumed acceptable.	N/A - CSO pollutant loading occurs now. It will continue but will be reduced with TARP implementation in 2015 and frequency with TARP is assumed acceptable.	N/A - CSO pollutant loading occurs now. It will continue but will be reduced with TARP implementation in 2015 and frequency with TARP is assumed acceptable.	N/A - CSO pollutant loading occurs now. It will continue but will be reduced with TARP implementation in 2015 and frequency with TARP is assumed acceptable.
	Contaminated Sediments	Contaminated sediment removal required	Contaminated sediment removal required	Contaminated sediment removal required	No change.	No change.	No change.
	Flow Augmentation	Stagnation Lakeside will require pumping from the lake to the barrier, or treated effluent from the treatment plant.	Stagnation Lakeside will require pumping from the lake to the barrier, or treated effluent from the treatment plant.	Stagnation Lakeside will require pumping from the lake to the barrier, or treated effluent from the treatment plant.	Flow augmentation will be required riverside of barrier from Calumet WTP.	Flow augmentation will be required riverside of barrier from Calumet WTP.	Flow augmentation will be required riverside of barrier from Calumet WTP.
	Water Reclamation Plants Improvements	Northside treatment plant will require additional upgrade for removal of nutrients and bioaccumulative chemicals of concern.	Northside treatment plant will require additional upgrade for removal of nutrients and bioaccumulative chemicals of concern; improvements unlikely to be completed prior to near-term barrier construction.	Northside treatment plant will require additional upgrade for removal of nutrients and bioaccumulative chemicals of concern.	No changes required of Calumet WRP.	No changes required of Calumet WRP.	No changes required of Calumet WRP.

# Near Lake Alternative - Potential Challenges

**\*\*WORK IN PROGRESS AUGUST 2011\*\***

Challenges	
Positive	
Neutral	
Negative	
Extensive Investment Required	
Not Applicable	

Category	Near Lake					
	North Shore Channel and Chicago Lock			Calumet, Grand Calumet, Little Calumet Rivers		
	Overall	Near Term Implementation	Long Term Implementation	Overall	Near Term Implementation	Long Term Implementation
Prevent AIS Transfer						
Transportation	Existing Freight Movement					
	New Cargoes	N/A	N/A	N/A		
	Recreational					
	Tour Boats/Water Taxis				N/A	N/A
Stormwater Management						
Ecological Health	CSOs (WO)	N/A		N/A	N/A	N/A
	Contaminated Sediments					
	Flow Augmentation					
	WRP Improvements					

Category	Near Lake						
	North Shore Channel and Chicago Lock			Calumet, Grand Calumet, Little Calumet Rivers			
	Overall	Near Term Implementation	Long Term Implementation	Overall	Near Term Implementation	Long Term Implementation	
Prevent AIS Transfer							
Transportation	Existing Freight Movement	Some freight movement negatively affected.	All freight through Chicago lock would be diverted south	All freight through Chicago lock would be diverted south	Laker and intra-lake barge movement on Calumet River eliminated. Inland barge movement on Cal-Sag River maintained.	Calumet River-Lake Michigan traffic severed. Without full mitigation (transfer infrastructure), substantial impacts to Cal-Sag and Calumet traffic. Requires modal transfer which will have higher costs.	Calumet River-Lake Michigan traffic severed. With full mitigation (transfer infrastructure), less impacts to Cal-Sag and Calumet traffic than without mitigation.
	New Cargoes	N/A	N/A	N/A	Potential exists.	Market timing indicates opportunity in 2015 timeframe based on Panama Canal expansion, but only if new port in place	Reduced opportunity to capture new market based on Panama Canal expansion (2015)
	Recreational	Opportunity to expand marinas and recreational activity with increased access to lake at North Shore Channel barrier. Many marinas and dry docks would be inaccessible from lake at Chicago Lock barrier.	Without full mitigation, severing access to Lake Michigan from downstream of barrier.	With full mitigation, boats will be lifted over barrier. Opportunity to expand marinas and recreational activity with increased access to lake at North Shore Channel barrier. Many marinas and dry docks would be inaccessible from lake at Chicago Lock barrier.	Recreational access to Lake Michigan from downstream of barrier eliminated. Mitigation would provide transfer over barrier.	Recreational access to Lake Michigan from downstream of barrier eliminated.	Recreational access to Lake Michigan from downstream of barrier eliminated. With full mitigation, would transfer over barrier.
	Tour Boats/Water Taxis	Tour boats negatively affected, route severed to Lake requiring re-routing. Water taxis not affected	No mitigation for tour boat access to lake, cannot lift over barrier. River access not affected.	No mitigation for tour boat access to lake, cannot lift over barrier. River access not affected.	N/A	N/A	N/A
Stormwater Management	Loss of outlet to the Lake during extreme weather events is of concern. TARP would need to convey more stormwater than current.	Flooding with frequency equivalent to existing conditions lake backflows with impermeable barrier until mitigation is completed. Comparable AIS and flood risk management could be achieved with operational modification to Wilmette and CRCW.	Flood risk protection for CAWS is equal to or better than existing conditions post barrier with augmented TARP/additional storage.	Loss of outlet to Lake Michigan. Lake Calumet and Calumet River provide would provide some potential flood storage. Mitigation would be needed to increase storage for extreme events.	<u>Lake Calumet:</u> Increased risk of flooding with impermeable barrier until mitigation is completed. TARP completion (Thornton reservoir) in 2015 reduces risk. Comparable AIS and flood risk management could be achieved with operational modification to O'Brien. <u>Grand &amp; Little Calumet:</u> Increased risk of flooding with impermeable barrier until mitigation is completed.	Flood risk protection is equal to or better than existing conditions post barrier with augmented TARP/additional storage.	
Ecological Health	Combined Sewer Overflows (Water Quality)	N/A - Permitting and regulatory changes will be required for discharge of CSOs lakeside of barrier. With TARP completion, CSO frequency is assumed acceptable.	Prior to TARP completion, permitting and regulatory changes required for discharge of CSOs lakeside of barrier are unlikely to be approved.	N/A - Permitting and regulatory changes will be required for discharge of CSOs lakeside of barrier. With TARP completion, CSO frequency is assumed acceptable.	N/A - CSO pollutant loading occurs now. It will continue but will be reduced with TARP implementation in 2015 and frequency with TARP is assumed acceptable.	N/A - CSO pollutant loading occurs now. It will continue but will be reduced with TARP implementation in 2015 and frequency with TARP is assumed acceptable.	N/A - CSO pollutant loading occurs now. It will continue but will be reduced with TARP implementation in 2015 and frequency with TARP is assumed acceptable.
	Contaminated Sediments	Contaminated sediments lakeside of North Shore Channel barrier will require removal.	Contaminated sediments lakeside of North Shore Channel barrier will require removal.	Contaminated sediments lakeside of North Shore Channel barrier will require removal.	Contaminated sediments would not be conveyed to the lake.	Contaminated sediments would not be conveyed to the lake.	Contaminated sediments would not be conveyed to the lake.
	Flow Augmentation	Stagnation Lakeside will require pumping from the lake to the barrier, or treated effluent from the treatment plant.	Stagnation Lakeside will require pumping from the lake to the barrier, or treated effluent from the treatment plant.	Stagnation Lakeside will require pumping from the lake to the barrier, or treated effluent from the treatment plant.	Flow augmentation required riverside of barrier. Pumped and conveyed from Lake Calumet or Calumet WTP.	Flow augmentation required riverside of barrier. Pumped and conveyed from Lake Calumet or Calumet WTP.	Flow augmentation required riverside of barrier. Pumped and conveyed from Lake Calumet or Calumet WTP.
	Water Reclamation Plants Improvements	No changes required of Northside WRP.	No changes required of Northside WRP.	No changes required of Northside WRP.	No changes required of Calumet WRP.	No changes required of Calumet WRP.	No changes required of Calumet WRP.



# Separation Alternatives Summary - Investment/Improvement Costs

**\*\*WORK IN PROGRESS AUGUST 2011\*\***

Improvement Element Cost	Symbol
< \$100 million	\$
\$100 - \$500 million	\$\$
\$500 million - \$1 billion	\$\$\$
> \$1 billion	\$\$\$\$
Not Applicable	N/A

Category		Near Lake					
		North Shore Channel and Chicago Lock			Calumet, Grand Calumet, Little Calumet Rivers		
		Overall	Near Term Implementation	Long Term Implementation	Overall	Near Term Implementation	Long Term Implementation
Prevent AIS Transfer		N/A	N/A	N/A	N/A	N/A	N/A
Transportation	Existing Freight Movement	N/A	N/A	N/A	\$\$\$\$	\$\$	\$\$\$\$
	New Cargoes	N/A	N/A	N/A	\$\$\$\$	\$\$\$\$	\$\$\$\$
	Recreational	\$	\$	\$	\$	\$	\$
	Tour Boats/Water Taxis	\$	\$	\$	N/A	N/A	N/A
Stormwater Management	Overall	\$\$\$\$	\$\$\$\$	\$\$\$\$	\$\$	\$\$	\$\$
	Lakeside	N/A	N/A	N/A	N/A	N/A	N/A
	Riverside	\$\$\$\$	\$\$\$\$	\$\$\$\$	\$\$\$\$	\$\$\$\$	\$\$\$\$
Ecological Health	CSOs (WQ)	N/A	\$\$	N/A	N/A	N/A	N/A
	Contaminated Sediments	\$	\$	\$	N/A	N/A	N/A
	Flow Augmentation	\$	\$	\$	\$\$	\$\$	\$\$
	WRP Improvements	N/A	N/A	N/A	N/A	N/A	N/A

Category		Mid-System					
		South Branch			Lake Calumet, Grand Calumet, Little Calumet		
		Overall	Near Term Implementation	Long Term Implementation	Overall	Near Term Implementation	Long Term Implementation
Prevent AIS Transfer		N/A	N/A	N/A	N/A	N/A	N/A
Transportation	Existing Freight Movement	N/A	N/A	N/A	\$\$\$	\$\$	\$\$\$
	New Cargoes	N/A	N/A	N/A	\$\$	\$\$	\$\$
	Recreational	\$	\$	\$	\$	\$	\$
	Tour Boats/Water Taxis	\$	\$	\$	N/A	N/A	N/A
Stormwater Management	Overall	\$\$\$\$	\$\$\$\$	\$\$\$\$	\$\$	\$\$	\$\$
	Lakeside	\$\$	\$\$	\$\$	N/A	N/A	N/A
	Riverside	\$	\$	\$	\$\$\$\$	\$\$\$\$	\$\$\$\$
Ecological Health	CSOs (WQ)	N/A	\$\$\$	N/A	N/A	N/A	N/A
	Contaminated Sediments	\$\$	\$\$	\$\$	N/A	N/A	N/A
	Flow Augmentation	\$\$	\$\$	\$\$	\$\$	\$\$	\$\$
	WRP Improvements	\$\$\$\$	\$\$\$\$	\$\$\$\$	N/A	N/A	N/A

Category		Down River		
		CSCC/Cal-Sag Confluence		
		Overall	Near Term Implementation	Long Term Implementation
Prevent AIS Transfer		N/A	N/A	N/A
Transportation	Existing Freight Movement	\$\$\$	\$\$	\$\$\$
	New Cargoes	\$\$	\$\$	\$\$
	Recreational	\$	\$	\$
	Tour Boats/Water Taxis	\$	\$	\$
Stormwater Management	Overall	\$\$\$\$	\$\$\$\$	\$\$\$\$
	Lakeside	\$\$\$\$	\$\$\$\$	\$\$\$\$
	Riverside	N/A	N/A	N/A
Ecological Health	CSOs (WQ)	N/A	\$\$\$\$	N/A
	Contaminated Sediments	\$\$\$\$	\$\$\$\$	\$\$\$\$
	Flow Augmentation	\$\$\$	\$\$\$	\$\$\$
	WRP Improvements	\$\$\$\$	\$\$\$\$	\$\$\$\$

## Down River Alternative - Investment/Improvement Costs

**\*\*WORK IN PROGRESS AUGUST 2011\*\***

Improvement Element Cost	Symbol
< \$100 million	\$
\$100 - \$500 million	\$\$
\$500 million - \$1 billion	\$\$\$
> \$1 billion	\$\$\$\$
Not Applicable	N/A

Category		Down River		
		CSSC/Cal-Sag Confluence		
		Overall	Near Term Implementation	Long Term Implementation
Prevent AIS Transfer		N/A	N/A	N/A
Transportation	Existing Freight Movement	\$\$\$	\$\$	\$\$\$
	New Cargoes	\$\$	\$\$	\$\$
	Recreational	\$	\$	\$
	Tour Boats/Water Taxis	\$	\$	\$
Stormwater Management	Overall	\$\$\$\$	\$\$\$\$	\$\$\$\$
	Lakeside	\$\$\$\$	\$\$\$\$	\$\$\$\$
	Riverside	N/A	N/A	N/A
Ecological Health	CSOs (WQ)	N/A	\$\$\$\$	N/A
	Contaminated Sediments	\$\$\$\$	\$\$\$\$	\$\$\$\$
	Flow Augmentation	\$\$\$	\$\$\$	\$\$\$
	WRP Improvements	\$\$\$\$	\$\$\$\$	\$\$\$\$

Category		Down River		
		CSSC/Cal-Sag Confluence		
		Overall	Near Term Implementation	Long Term Implementation
Prevent AIS Transfer		N/A	N/A	N/A
Transportation	Existing Freight Movement	\$\$\$	\$\$: Assumes new transfer mechanism not in place. Requires modal transfer, or 2nd handling of cargo. Will result in higher shipping costs & loss to other modes, not captured here.	\$\$\$: Assumes new transfer mechanism in place from barge to barge, requiring 2nd handling of cargo or modal shift. Will result in higher shipping costs & loss to other modes, not captured here.
	New Cargoes	\$\$	\$\$: Potential for increase only if barge-barge transfer in place by 2015	\$\$: Assumes barge-barge transfer in place after 2015. Potential loss of some opportunity due to other ports already being in place
	Recreational	\$: Boat lift and disinfection facilities.	\$: Boat lift and disinfection facilities.	\$: Boat lift and disinfection facilities.
	Tour Boats/Water Taxis	\$: Costs associated with building new maintenance/dry dock facility north of barrier.	\$: Costs associated with building new maintenance/dry dock facility north of barrier.	\$: Costs associated with building new maintenance/dry dock facility north of barrier.
Stormwater Management*	Overall	Green infrastructure/ sewer separation for inflow reduction (\$\$\$\$)	Improvement elements and costs same as overall.	Improvement elements and costs same as overall.
	Lakeside	Floodplain storage on North Branch (\$\$); Interim and emergency flooding/CSO barrier bypass tunnels/gates (\$\$); Lock and Gate Modifications (\$); Storms exceeding TARP: increase storage and conveyance capacity (\$\$\$\$)	Improvement elements and costs same as overall. Improvement elements unlikely to be completed prior to near-term barrier construction; potential additional economic costs associated with increased flooding risk.	Improvement elements and costs same as overall.
	Riverside	N/A	N/A	N/A
Ecological Health	Combined Sewer Overflows* (Water Quality)	N/A	Prior to TARP completion, permitting and regulatory changes required for discharge of CSOs lakeside of barrier are unlikely to be approved. CSO improvement elements unlikely to be completed prior to near-term barrier construction (\$\$\$\$).	N/A
	Contaminated Sediments	Removal of contaminated sediments will be required the length of the CAWS. = \$\$\$\$	Removal of contaminated sediments will be required the length of the CAWS. = \$\$\$\$	Removal of contaminated sediments will be required the length of the CAWS. = \$\$\$\$
	Flow Augmentation	Flow augmentation may be required from Stickney to confluence of Cal-Sag channel and lakeside of Cal-Sag channel. Negatively impact flow riverside of barrier. = \$\$\$	Flow augmentation may be required from Stickney to confluence of Cal-Sag channel and lakeside of Cal-Sag channel. Negatively impact flow riverside of barrier. = \$\$\$	Flow augmentation may be required from Stickney to confluence of Cal-Sag channel and lakeside of Cal-Sag channel. Negatively impact flow riverside of barrier. = \$\$\$
	Water Reclamation Plants Improvements	All treatment plants upgraded to tertiary treatment and bioaccumulative chemical removal = \$\$\$\$	All treatment plants upgraded to tertiary treatment and bioaccumulative chemical removal = \$\$\$\$	All treatment plants upgraded to tertiary treatment and bioaccumulative chemical removal = \$\$\$\$

\*CSO assumption: TARP with improved conveyance

# Mid-System Alternative - Investment/Improvement Costs

\*\*WORK IN PROGRESS AUGUST 2011\*\*

Improvement Element Cost	Symbol
< \$100 million	\$
\$100 - \$500 million	\$\$
\$500 million - \$1 billion	\$\$\$
> \$1 billion	\$\$\$\$
Not Applicable	N/A

Category	Mid-System					
	South Branch			Lake Calumet, Grand Calumet, Little Calumet		
	Overall	Near Term Implementation	Long Term Implementation	Overall	Near Term Implementation	Long Term Implementation
Prevent AIS Transfer	N/A	N/A	N/A	N/A	N/A	N/A
Transportation	Existing Freight Movement	N/A	N/A	\$\$\$	\$\$	\$\$\$
	New Cargoes	N/A	N/A	\$\$	\$\$	\$\$
	Recreational	\$	\$	\$	\$	\$
	Tour Boats/Water Taxis	\$	\$	\$	N/A	N/A
Stormwater Management	Overall	\$\$\$\$	\$\$\$\$	\$\$	\$\$	\$\$
	Lakeside	\$\$	\$\$	\$\$	N/A	N/A
	Riverside	\$	\$	\$	\$\$\$\$	\$\$\$\$
Ecological Health	CSOs (WQ)	N/A	\$\$\$	N/A	N/A	N/A
	Contaminated Sediments	\$\$	\$\$	\$\$	N/A	N/A
	Flow Augmentation	\$\$	\$\$	\$\$	\$\$	\$\$
	WRP Improvements	\$\$\$\$	\$\$\$\$	\$\$\$\$	N/A	N/A

Category	Mid-System					
	South Branch			Lake Calumet, Grand Calumet, Little Calumet		
	Overall	Near Term Implementation	Long Term Implementation	Overall	Near Term Implementation	Long Term Implementation
Prevent AIS Transfer	N/A	N/A	N/A	N/A	N/A	N/A
Transportation	Existing Freight Movement	N/A	N/A	N/A	\$\$\$: Affects only barge segment, which can be mitigated.	\$\$\$: Barge interface with Calumet River operations modified. Inbound and outbound traffic at barrier transferred.
	New Cargoes	N/A	N/A	N/A	\$\$	\$\$: Assumes new port not in place. Will require modal transfer. Will result in higher shipping costs & loss to other modes not captured here.
	Recreational	\$: Boat lift and disinfection facilities.	\$: Boat lift and disinfection facilities.	\$: Boat lift and disinfection facilities.	\$: Boat lift and disinfection facilities.	\$: Boat lift and disinfection facilities.
	Tour Boats/Water Taxis	\$: Costs associated with building new maintenance/dry dock facility north of barrier.	\$: Costs associated with building new maintenance/dry dock facility north of barrier.	\$: Costs associated with building new maintenance/dry dock facility north of barrier.	N/A	N/A
Stormwater Management*	Overall	Green infrastructure/ sewer separation for inflow reduction (\$\$\$\$)	Improvement elements and costs same as overall.	Improvement elements and costs same as overall.	Green infrastructure/ sewer separation for inflow reduction (\$\$)	Improvement elements and costs same as overall.
	Lakeside	Floodplain storage on North Branch (\$\$); Interim and emergency flooding/CSO barrier bypass tunnels/gates (\$); Lock and Gate Modifications (\$)	Improvement elements and costs same as overall. Improvement elements unlikely to be completed prior to near-term barrier construction, potential additional economic costs associated with increased flooding risk.	Improvement elements and costs same as overall.	N/A	N/A
	Riverside	CSSC and Bubbly Creek turning basin/channel modifications for RAPS flows (\$)	Improvement elements and costs same as overall. Improvement elements unlikely to be completed prior to near-term barrier construction; potential additional economic costs associated with increased flooding risk from RAPS.	Improvement elements and costs same as overall.	Lock and Gate Modifications (\$); Storms exceeding TARP: increase storage capacity and conveyance (\$\$\$\$) Spillway integrated w/ port/barrier structure (\$); Little Calumet Channel Modification (\$)	Improvement elements and costs same as overall. Potential additional economic costs associated with increased flooding risk. TARP completion (Thornton reservoir) in 2015 reduces risk for Lake Calumet barrier.
Ecological Health	Combined Sewer Overflows* (Water Quality)	N/A	Prior to TARP completion, permitting and regulatory changes required for discharge of CSOs lakeside of barrier are unlikely to be approved. CSO improvement elements unlikely to be completed prior to near-term barrier construction (\$\$).	N/A	N/A	N/A
	Contaminated Sediments	Contaminated sediments will be removed or treated in-situ. = \$\$	Contaminated sediments will be removed or treated in-situ. = \$\$	Contaminated sediments will be removed or treated in-situ. = \$\$	N/A	N/A
	Flow Augmentation	Flow augmentation includes pumping water from Lake Michigan, from the CAWS, or from WRPs to locations above, below, or a combination above and below the proposed physical barrier. = \$\$	Flow augmentation includes pumping water from Lake Michigan, from the CAWS, or from WRPs to locations above, below, or a combination above and below the proposed physical barrier. = \$\$	Flow augmentation includes pumping water from Lake Michigan, from the CAWS, or from WRPs to locations above, below, or a combination above and below the proposed physical barrier. = \$\$	Flow augmentation will be required riverside of barrier from Calumet WTP. = \$\$	Flow augmentation will be required riverside of barrier from Calumet WTP. = \$\$
	Water Reclamation Plants Improvements	Northside WRP improvements include treating wastewater to comply with State of Illinois Lake Michigan water quality standards. = \$\$\$\$	Northside WRP improvements include treating wastewater to comply with State of Illinois Lake Michigan water quality standards. = \$\$\$\$	Northside WRP improvements include treating wastewater to comply with State of Illinois Lake Michigan water quality standards. = \$\$\$\$	N/A	N/A

\*CSO assumption: TARP with improved conveyance

# Near Lake Alternative - Investment/Improvement Costs

\*\*WORK IN PROGRESS AUGUST 2011\*\*

Improvement Element Cost	Symbol
< \$100 million	\$
\$100 - \$500 million	\$\$
\$500 million - \$1 billion	\$\$\$
> \$1 billion	\$\$\$\$
Not Applicable	N/A

Category	Near Lake					
	North Shore Channel and Chicago Lock			Calumet, Grand Calumet, Little Calumet Rivers		
	Overall	Near Term Implementation	Long Term Implementation	Overall	Near Term Implementation	Long Term Implementation
Prevent AIS Transfer	N/A	N/A	N/A	N/A	N/A	N/A
Transportation	Existing Freight Movement	N/A	N/A	\$\$\$\$	\$	\$\$\$\$
	New Cargoes	N/A	N/A	\$\$\$\$	\$\$\$\$	\$\$\$\$
	Recreational	\$	\$	\$	\$	\$
	Tour Boats/Water Taxis	\$	\$	\$	N/A	N/A
Stormwater Management	Overall	\$\$\$\$	\$\$\$\$	\$\$\$\$	\$\$	\$\$
	Lakeside	N/A	N/A	N/A	N/A	N/A
	Riverside	\$\$\$\$	\$\$\$\$	\$\$\$\$	\$\$\$\$	\$\$\$\$
Ecological Health	CSOs (WQ)	N/A	\$\$	N/A	N/A	N/A
	Contaminated Sediments	\$	\$	\$	N/A	N/A
	Flow Augmentation	\$	\$	\$	\$\$	\$\$
	WRP Improvements	N/A	N/A	N/A	N/A	N/A

Category	Near Lake						
	North Shore Channel and Chicago Lock			Calumet, Grand Calumet, Little Calumet Rivers			
	Overall	Near Term Implementation	Long Term Implementation	Overall	Near Term Implementation	Long Term Implementation	
Prevent AIS Transfer	N/A	N/A	N/A	N/A	N/A	N/A	
Transportation	Existing Freight Movement	N/A	N/A	N/A	\$\$\$\$: Need to rebuild all terminals of Port Chicago at Lake Calumet. Need to rebuild all other impacted terminals between Lake Calumet and Lake Michigan.	\$\$\$\$: Need to rebuild all terminals of Port Chicago at Lake Calumet. Need to rebuild all other impacted terminals between Lake Calumet and Lake Michigan.	
	New Cargoes	N/A	N/A	N/A	\$\$\$\$	\$\$\$\$: Potential for increase only if new port in place by 2015	
	Recreational	\$: Boat lift and disinfection facilities.	\$: Boat lift and disinfection facilities.	\$: Boat lift and disinfection facilities.	\$: Boat lift and disinfection facilities.	\$: Boat lift and disinfection facilities.	\$: Boat lift and disinfection facilities.
	Tour Boats/Water Taxis	\$: Costs associated with building new maintenance/dry dock facility lakeside of barrier for tour boats.	\$: Costs associated with building new maintenance/dry dock facility lakeside of barrier for tour boats.	\$: Costs associated with building new maintenance/dry dock facility lakeside of barrier for tour boats.	N/A	N/A	N/A
Stormwater Management*	Overall	Green infrastructure/ sewer separation for inflow reduction (\$\$\$\$)	Improvement elements and costs same as overall.	Improvement elements and costs same as overall.	Green infrastructure/ sewer separation for inflow reduction (\$\$)	Improvement elements and costs same as overall.	
	Lakeside	N/A - Capture and treat lakeside CSOs via augmented TARP (cost embedded riverside)	N/A - Improvement elements and costs same as overall.	N/A - Improvement elements and costs same as overall.	N/A	N/A	
	Riverside	Floodplain storage on North Branch (\$\$); Augmented TARP/additional storage and conveyance capacity (\$\$\$\$)	Improvement elements and costs same as overall. Improvement elements unlikely to be completed prior to near-term barrier construction; potential additional economic costs associated with increased flooding risk.	Improvement elements and costs same as overall.	Lock and Gate Modifications (\$); Storms exceeding TARP: increase storage capacity and conveyance (\$\$\$\$) Spillway integrated w/ port/barrier structure (\$); Little Calumet Channel Modification (\$)	Improvement elements and costs same as overall. Potential additional economic costs associated with increased flooding risk. TARP completion (Thornton reservoir) in 2015 reduces risk for Calumet River barrier.	Improvement elements and costs same as overall.
Ecological Health	Combined Sewer Overflows* (Water Quality)	N/A	Prior to TARP completion, permitting and regulatory changes required for discharge of CSOs lakeside of barrier are unlikely to be approved. CSO improvement elements unlikely to be completed prior to near-term barrier construction (\$\$).	N/A	N/A	N/A	
	Contaminated Sediments	Contaminated sediments will be removed or treated in-situ. = \$	Contaminated sediments will be removed or treated in-situ. = \$	Contaminated sediments will be removed or treated in-situ. = \$	N/A	N/A	
	Flow Augmentation	Flow augmentation includes pumping water from Lake Michigan, from the CAWS, or from WRPs to locations above, below, or a combination above and below the proposed physical barrier. = \$	Flow augmentation includes pumping water from Lake Michigan, from the CAWS, or from WRPs to locations above, below, or a combination above and below the proposed physical barrier. = \$	Flow augmentation includes pumping water from Lake Michigan, from the CAWS, or from WRPs to locations above, below, or a combination above and below the proposed physical barrier. = \$	Flow augmentation includes pumping water from Lake Michigan, from the CAWS, or from WRPs to locations above, below, or a combination above and below the proposed physical barrier. = \$\$	Flow augmentation includes pumping water from Lake Michigan, from the CAWS, or from WRPs to locations above, below, or a combination above and below the proposed physical barrier. = \$\$	Flow augmentation includes pumping water from Lake Michigan, from the CAWS, or from WRPs to locations above, below, or a combination above and below the proposed physical barrier. = \$\$
	Water Reclamation Plants Improvements	N/A	N/A	N/A	N/A	N/A	

\*CSO assumption: TARP with improved conveyance

# Down River Alternative Detailed Timeline

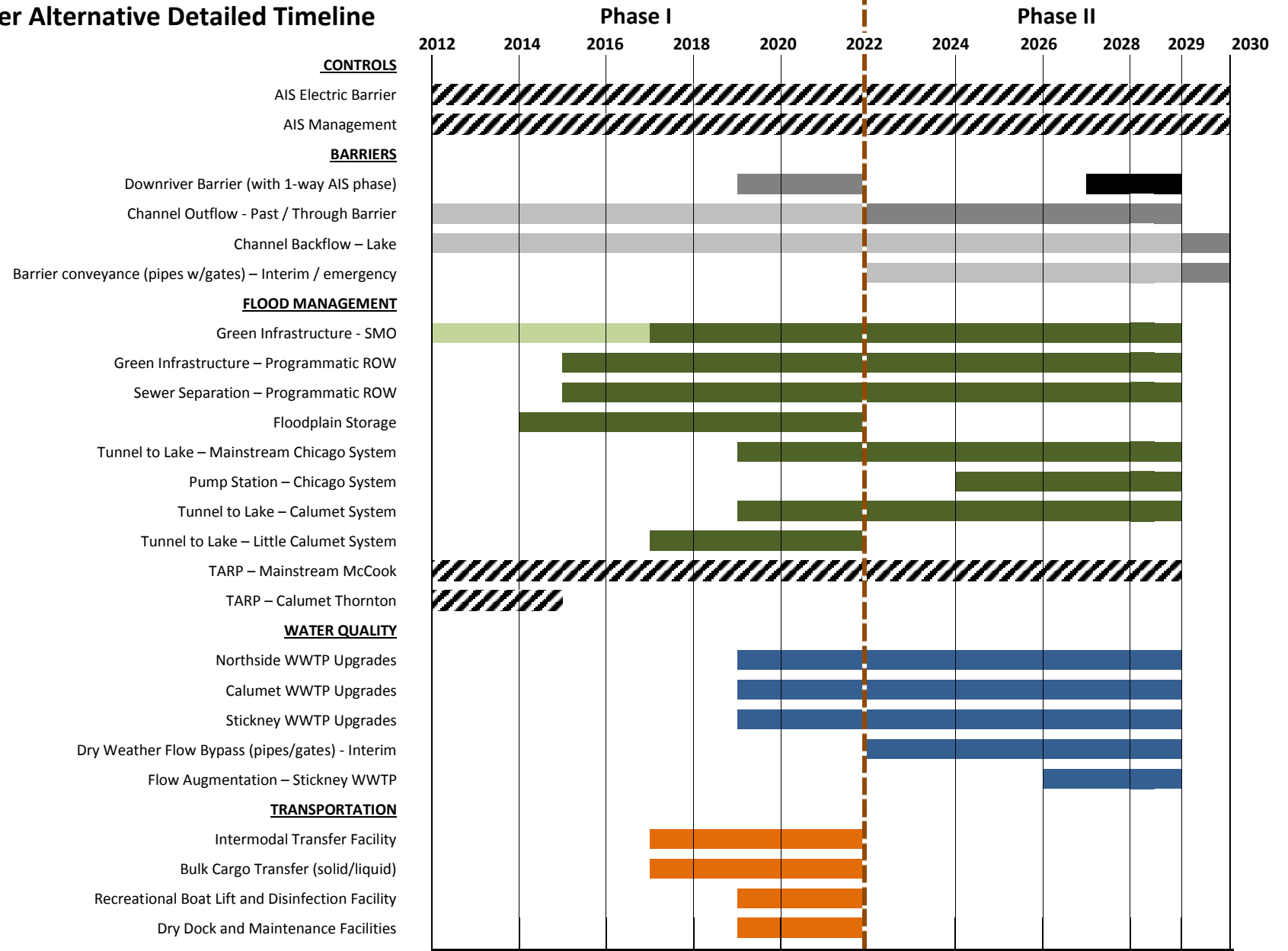

 Ongoing Baseline Programs / Activities

# Mid-System Alternative Detailed Timeline

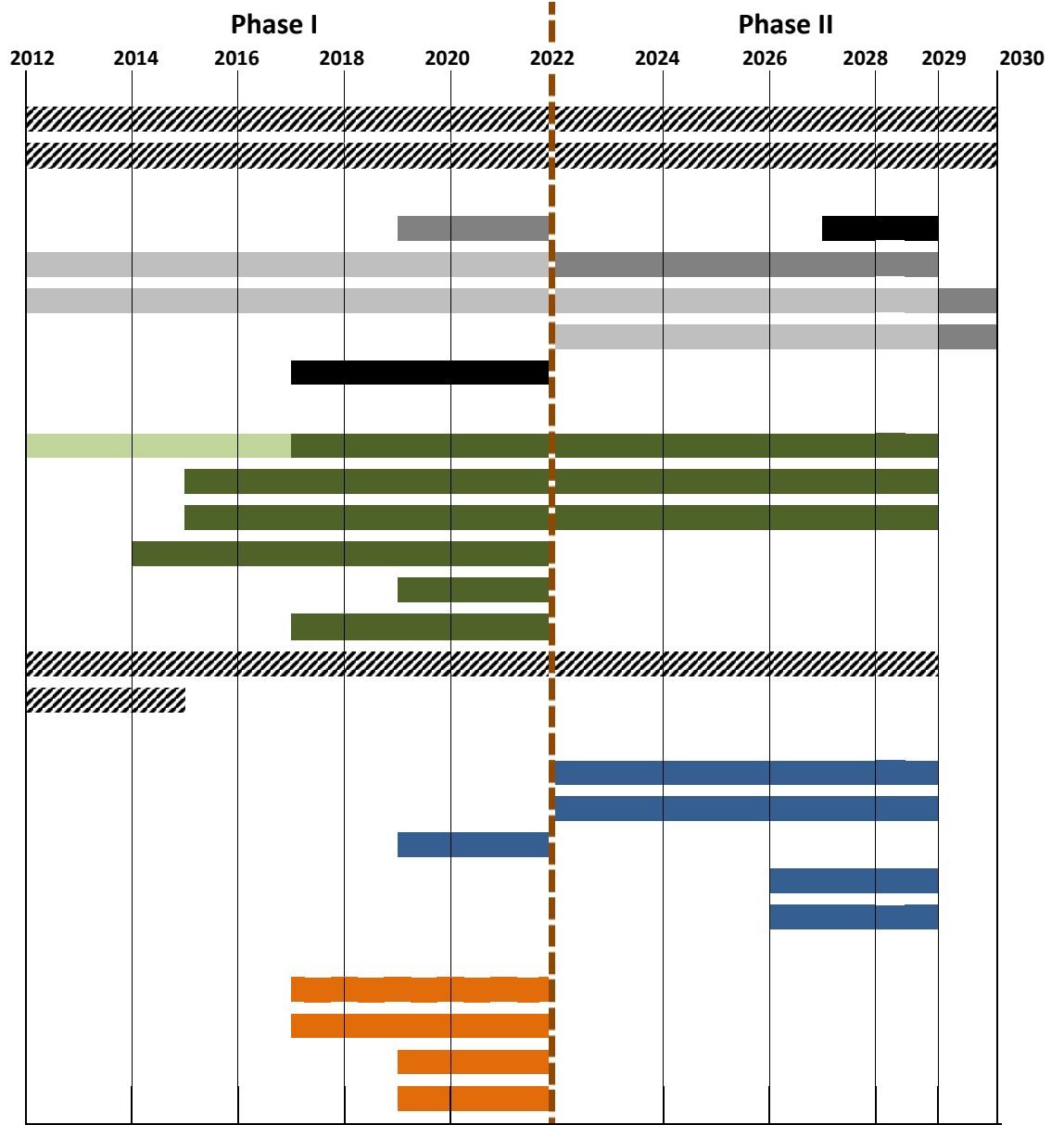

 Ongoing Baseline Programs / Activities



# Near Lake Alternative Detailed Timeline

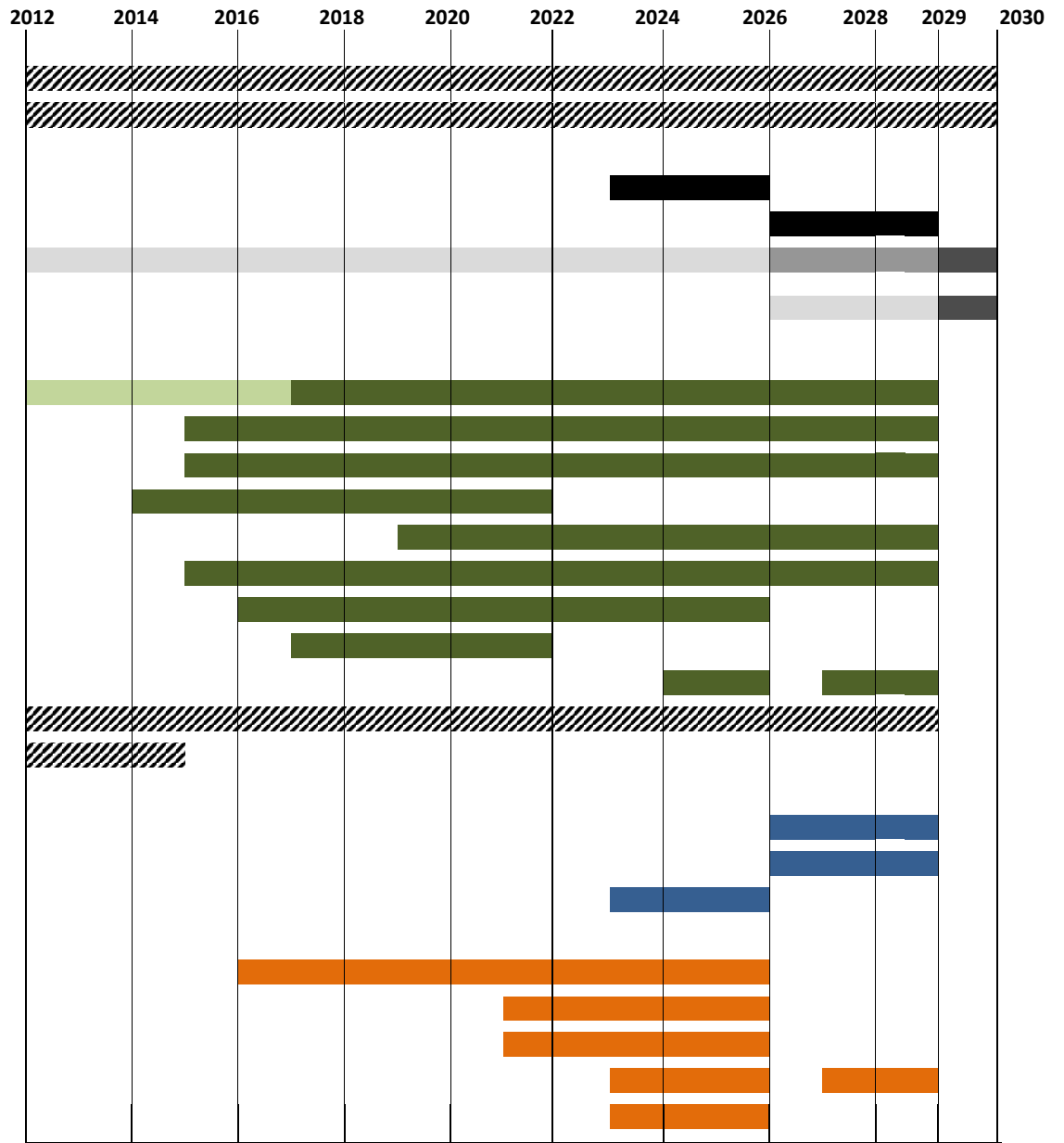

 Ongoing Baseline Programs / Activities



## **B5. ECONOMICS MATERIALS**

- RAP SESSION PRESENTATION
- PEER REVIEW RAP WORKBOOK
- ECONOMICS TECHNICAL APPENDIX



## Envisioning a Chicago Area Waterway System for the 21st Century

# Cost-Benefit Analysis of Physical Separation Options

August 3



ONE COMPANY | Many Solutions™

## Agenda

- Objectives
- Discussion of AWO meeting
- Economics Primer (concepts)
  - CBA Considerations for CAWS Study
  - Base Case and Options Discussion
- Literature Review
  - Separation Economics
  - Invasive Species Economic Damage
- Benefits and Costs of Separation
- Project Economic Outputs

2

## Objectives

- To reach consensus on key economic issues
  - Study approach
  - Range of impacts to be quantified
  - Approach to quantification of impacts
  - Final product(s) of analysis
  - Next Steps
- To highlight data needs, gaps and key challenges

3

## Primer - What is SROI/CBA?

- Quantifies the net social value (i.e., impact on welfare or people's well-being) of a policy, program, project, activity, event, etc.
- Compares the "value" of alternative projects or policies to users
- Compares costs of investments to the benefits to the public
- Understand the relative importance of all potential costs and benefits (by stakeholder)
- Helps determine when and where to invest

5

## Primer - What is CBA?

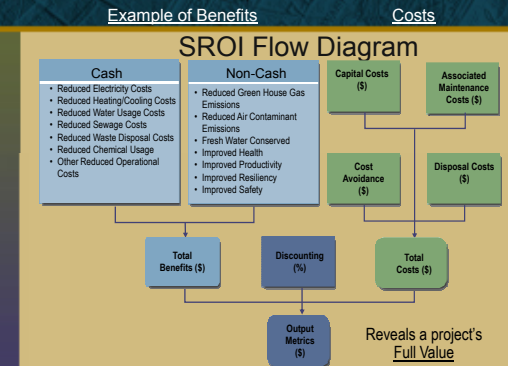

6

## General Background Economics Discussion

4

## Primer - What is CBA?

- Estimates gains or losses to consumers, producers, public authority, etc. separately
- "Transfers" are netted out
  - Losses to one group may be gained by other groups
  - Losses/gains can still be quantified
- Be careful not to double-count
  - E.g., property value impacts usually manifestation of something else
- Many well-established rules for conducting CBA
  - Office of Management and Budget (OMB), USACE, TIGER

7

## Primer - What is CBA? (cont'd)

- CBA very different from economic impact studies (EI)
- EI studies focus on the flow of money spent in the economy – big numbers do not mean \$ is well spent
  - Public Relations tool
  - Jobs focused – efficiencies do not matter
- CBA focuses on whether investments should be made from a public perspective
  - Decision Making Tool

8

## Primer - Defining the Base Case

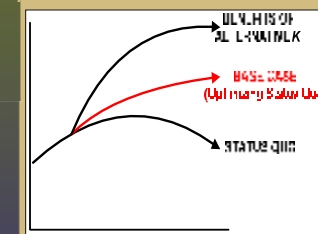

- Status quo or do-nothing often not a credible option
- Other assumptions may be required for a realistic base case
- Unrealistic "base cases" can over-inflate benefits
- Without a sensible "base case", results will not be credible

9

## Primer – Study Period

- For infrastructure investments, the benefits accrue many years after the infrastructure was put in place
- Important to have a study period that is long enough to ensure that benefits are adequately captured
- *TIGER Guidance, July 1, 2011:*
  - Both benefits and costs must be estimated for each year after work on the project is begun and for a period of time at least 20 years in the future (or the project's useful life, whichever is shorter)

10

## Primer – Discounting

- Converts benefits and costs over time into a common year (present value) for comparison.
- Takes into account time value of money:
  - \$1 today worth more than \$1 tomorrow
- Office of Management and Budget (OMB) – “Circular No. A-94 – Guidelines and Discount Rates for BCA of Federal Programs”
  - rate for CBA (7%, **real**) derived from pretax return to private sector investment
  - Sensitivity rate of 3%
- Theory and evidence suggest declining rates over time
  - Uncertainty, ethics

11

## Primer – Discounting: The Rate Really Matters

- Discounting affects benefits more than costs – benefits usually occur much later costs
- With a 7% DR, \$1 in costs today equals
  - \$2 in benefits in 10 years
  - \$4 in benefits in 20 years
  - \$8 in benefits in 30 years
- Changes in discount rate may alter the ranking of projects

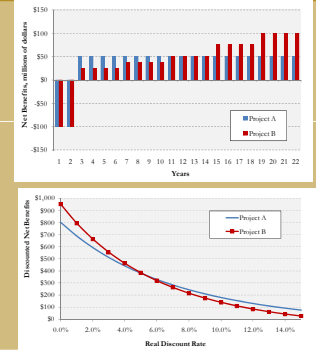

## CAWS CBA

- Quantify the net public value of 3 alternatives for physical separation relative to a base case option
- Mitigation for transportation, ecological health and storm water management is included in each option
- Understand the relative importance of all potential costs and benefits (by stakeholder) for each alternative

13

## CAWS CBA – The Base Case

- The “Base Case” includes:
  - Continued mitigation of AIS transfer through electrification and other measures
  - Current and programmed and authorized infrastructure investments:
    - Transportation – CREATE, Chicago Park District Marina (1200 slips),
    - Storm Water Management – TARP
      - Phased in per timeline – 2029
      - Improved conveyance in accordance with TARP
    - Water Quality
      - Disinfection on North Side and Calumet Plants

14

## CAWS CBA – Options

- The Options includes separation barriers at:
  - Locations: 4/5, 10, 13, 20 (mid system)
  - Locations: 19&3, 10, 13, 15 (near lake)
  - Locations: 9/16 (single site down river)

15

## CAWS CBA – Study Period

- Recommend using a study period that extends 30-50 years from barrier completion (including mitigation)
- Sensitivity analysis can be done to assess the impact of various study periods
  - *Residual value can be used to extract any remaining value from the barrier post the study period*

16

## CAWS CBA – Discounting

- Recommend using various discount rates to be compliant with federal guidelines
  - 7% real
  - 3% real
  - Declining rate over time
- But...
  - Make the Case that a lower discount rate should be used for assessing the project due to long run potential ecosystem impacts

17

*Literature Review Commentaries*

18



## Economics Literature Review

- DePaul University Study, April 2010
  - Closure of Chicago and O'Brien Locks
  - Most comprehensive study on closures
  - NPV = - \$4.7 billion
- Key Findings
  - Existing shipper costs - \$89 million annually
    - \$12/ton cost difference for barge and other modes
  - Costs to intra-lake barge users = \$6 million annually
  - External Costs from modal shifts = \$27.5 million annually

19

## Economics Literature Review DePaul (cont'd)

- Key Impacts
  - Cost to recreational boaters - \$10M/yr
  - Commercial tours and cruises - \$20M/yr
  - Public protection - \$6M/yr
  - Storm water, flooding and water reclamation \$375M/yr for 8 years
  - Decline in property value = \$51M
    - From decline in water quality

20

## Economics Literature Review Taylor, 2010

- Taylor Affidavit, 2010
  - Assumed physical barriers at existing locks
  - Goods movements focus only
  - Goods transloaded to other modes near barrier site
  - Assumed all goods have either a local Origin or Destination within 25 miles
  - Additional shipping costs - \$9-\$10/ton or \$60-70M/yr
  - Affidavit does not consider possibility of transloading to rail or barge across barrier

21

## Economics Literature Review Muench, 2010

- Lynn Muench, 2010
  - Many businesses devastated by closure
    - cites many examples
  - Transfer of cargo to rail or truck before CAWS would require massive facility for loading and unloading that could not be built in short run
  - Restricted access to shipyards
  - Property values on Cal-Sag would drop
  - Lock closures would not stop AIS transfer
- Lynn Muench, 2011
  - Would destroy the existing industry

22

## Economics Literature Review TTI/USACE

- Texas Transportation Institute
  - Study for all inland waterway systems in U.S.
  - Examines congestion, emissions, safety, and infrastructure
  - \$11/ton cost difference of barge to other modes on average
- USACE (report not yet complete)
  - \$27/ton cost difference of barge to other modes

23

## Economics Literature Review GAO, 2011

### Comparison of External Transportation Cost

Table 4: Cross-Modal Comparisons of Externalities<sup>a</sup>

Category	Type	Trucking	Railroad	Waterways	Trucking to rail ratio <sup>b</sup>	Trucking to waterways ratio
Air pollution <sup>c</sup>	Tons of particulate matter per million ton-miles, 2002	0.1194	0.0179	0.0195 <sup>d</sup>	6.7	10.2
	Tons of nitrogen oxide per million ton-miles, 2002	3.0193	0.6747	0.4691 <sup>d</sup>	4.5	6.4
	Tons of CO2 equivalents per million ton-miles, 2007	320.8	28.96	17.48	7.0	13.1
Accidents <sup>e</sup>	Injuries per billion ton-miles, avg. 2005-2007	2.54	0.39	0.01	6.4	208.8
	Injuries per billion ton-miles, avg. 2000-2007	55.98	3.92	0.05	16.9	1,239.6
Congestion <sup>f</sup>	Cost of delay to road users in 2002, (in billions of constant 2010 dollars)	\$10.86	\$0.58	Not available	18.6	Not available

Source: GAO analysis of data from DOT, EPA, and the Texas Transportation Institute.

24

## AIS Literature Review General

- Economic and environmental Impacts are difficult to estimate – often understated
- Many estimates in the literature assessing the impacts of different AIS
- Many different estimation approaches utilized
- No literature forecasting the impact to the Great Lakes of future AIS
- No literature forecasting the number of AIS to transfer in the future between basins
- Historic data suggests transfer of about 1 AIS per year

25

## AIS Literature Review USACE, GLMRIS, 2011

- Provides a list of AIS that occur in Great Lakes and Mississippi basin and associated risk of becoming invasive
- Estimates 10% of species introduced will become established
- Estimates 10% of species established will become invasive
- More AIS introduced into Great Lakes = Higher probability some will become invasive
- 88 AIS have potential to disperse into Mississippi River watershed
- 56 AIS have potential to disperse into Great Lakes watershed

26

## AIS Literature Review Cornell University, 2005

- Impacts are difficult to estimate as little is known about species and their ecology
- Largest impact on commercial and recreational fishing

Table 5. Environmental and economic impacts (damage and control costs) of biological invaders in the Great Lakes Basin in millions of dollars

Stakeholder group	Functional group						Total
	Fish	Algae	Aquatic plants	Mussels	Other invertebrates	Birds and parasites	
Landowners, agriculture						1 <sup>a</sup>	3
Public health						610 <sup>b</sup>	610
Tourism			4 <sup>c</sup>	0.5 <sup>c</sup>	19 <sup>c</sup>	1 <sup>c</sup>	40
Electric industry					490 <sup>d</sup>	19 <sup>d</sup>	509
Commercial fishing	2250 <sup>e</sup>	10 <sup>f</sup>	11 <sup>f</sup>	5 <sup>f</sup>	3 <sup>f</sup>	1 <sup>f</sup>	2279
Sport fishing	2250 <sup>e</sup>	10 <sup>f</sup>	5 <sup>f</sup>	3 <sup>f</sup>	3 <sup>f</sup>	5 <sup>f</sup>	2275
Boating			4 <sup>g</sup>	0.5 <sup>g</sup>	0.5 <sup>g</sup>		5
Transport			1 <sup>h</sup>	1 <sup>h</sup>	1 <sup>h</sup>		3
Bird/wildlife watchers					2 <sup>g</sup>	1 <sup>h</sup>	3
Total	4500	20	200	31.5	4	621	5685.5

27

## AIS Literature Review Other

National Center for Environmental Economics. January 2005

- 138 non-native fish introduced into the United States
- Economic loss to sport fishing from AIS **nationally** = \$1 billion annually

-Great Lakes AIS

- Sea lamprey control benefits = \$2-4 billion/yr
- Ruffe control benefits = \$24-214 million/yr

28

## AIS Literature Review Other

• Congressional Research Service. November 2002, National

- European green crab = \$44 million/yr
- Zebra mussel = \$750 million to \$1 billion over 10 years
  - other studies suggest billions/yr
- Asian river clam = \$1 billion/yr
- Sea lamprey = \$10-15 million / yr

29

## AIS Literature Review Other

• National Wildlife Federation, 2004

- Annual **national** costs estimate = \$137 billion
- AIS pose risk to Great Lakes \$6.9 billion fishing industry – **economic impact analysis**

30

*Key Inputs Discussion*

31

## Cost Input Requirements

• Cost provided by year for each mitigation

- in 2011 \$
- level of detail up to team
- all costs including planning and design associated with implementing solution
- any contingency should be identified
- estimate of O&M costs required as well
- +/- 25%

32

*Costs and Benefits of Separation*

33

## General CBA Framework

Example of Benefits      Costs

### SROI Flow Diagram

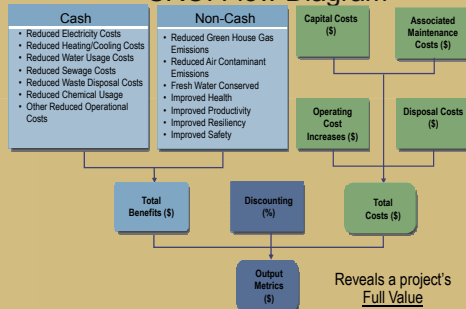

34

## Capital Cost of Separation Alternatives

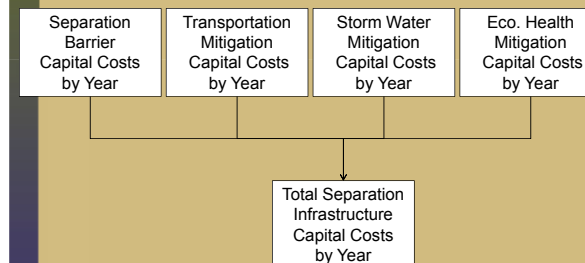

35

## O&M Costs of Separation Alternatives

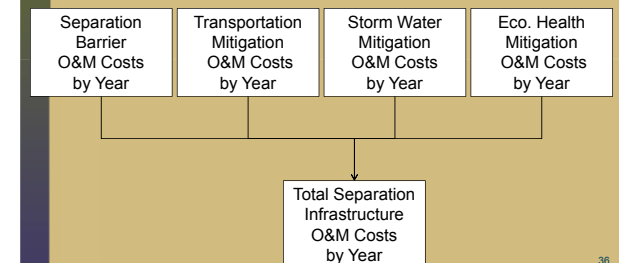

36

## Impacts of Physical Separation: To be Quantified

# Potential Impact	Discipline	Stakeholder	Description
1 Benefit	Ecological	Public	Reduction in the economic and environmental costs associated with future AIS transfer(s) between the Great Lakes and Mississippi River Basins through the CAWS. Economic costs include direct, indirect, option and existence values.

37

## Impacts of Physical Separation: To be Quantified

# Potential Impact	Discipline	Stakeholder	Description
2 Cost A	Transportation	Shippers	Increase in transportation costs* associated with <u>existing</u> transportation shipments through the CAWS as a result of the physical separation barrier. The increase in transportation cost for shippers will vary depending on whether the shipment changes modes or is transferred over the barrier.

\* Shipping costs plus externalities – emissions, safety, congestion, maintenance.

38

## Impacts of Physical Separation: To be Quantified

# Potential Impact	Discipline	Stakeholder	Description
2 Benefit B	Transportation	Shippers	Reduction in transportation costs associated with <u>non-traditional cargoes</u> moving through the CAWS facilitated by new port at the separation barrier.

\* Shipping costs plus externalities – emissions, safety, congestion, maintenance.

39

## Impacts of Physical Separation: To be Quantified

# Potential Impact	Discipline	Stakeholder	Description
3 Cost A	Transportation	Rec. Boaters	Increase in the time-related costs of recreational boaters needing to cross the separation barrier(s). "Lift and disinfection" time measured relative to lockage time (base case).

40

## Impacts of Physical Separation: To be Quantified

# Potential Impact	Discipline	Stakeholder	Description
3 Benefit B	Transportation	Rec. Boaters	Decrease in time-related costs of recreational boaters accessing the Lake through the Chicago River (and vice versa). There will also be additional trips or induced demand associated with the improved access.

41

## Impacts of Physical Separation: To be Quantified

# Potential Impact	Discipline	Stakeholder	Description
3 Cost C	Transportation	Recreational Boaters	Additional time and vehicle operating costs associated with recreational boaters relocating marinas to be lakeside of the separation barriers.

42

## Impacts of Physical Separation: To be Quantified

# Potential Impact	Discipline	Stakeholder	Description
4 Benefit	Transportation	Tour boats and water taxis.	Decrease in time related costs for tour boats and water taxis whose access to both river and lake has been unencumbered with removal of Chicago lock.

43

## Impacts of Physical Separation: To be Quantified

# Potential Impact	Discipline	Stakeholder	Description
5 Cost	Transportation	Tour boats, water taxis, rec. boats, public boats, barges.	Additional costs associated with transits south for vessels too large for lift transfer over the barrier (e.g., tour boats accessing shipyards for maintenance and repairs, barges transiting south for winter months, recreational boats).

Mitigated through transportation improvements???

44

## Impacts of Physical Separation: To be Quantified

# Potential Impact	Discipline	Stakeholder	Description
6 Cost	Transportation	Public Agencies	Additional costs for Public Safety and Response Operations associated with requirement for vessels on both sides of separation barriers.

45

## Impacts of Physical Separation: To be Quantified

# Potential Impact	Discipline	Stakeholder	Description
7 Cost or Benefit	Storm water management	Public, property owners	Mitigation has been designed to provide equivalent storm water conditions as the <u>base case</u> . There is no additional impact – the cost estimates for the mitigation reflect a neutral scenario with the base case.

46

## Impacts of Physical Separation: To be Quantified

# Potential Impact	Discipline	Stakeholder	Description
8 Benefit	Ecological health.	Public	There will be water quality improvements resulting in potential species diversification in the North branch.

47

## Impacts of Physical Separation: To be Quantified

# Potential Impact	Discipline	Stakeholder	Description
9 Benefit	Transportation	Public	Economic value associated with the opportunity to develop enhanced harbors, marinas, and recreational fishing opportunities with direct access to lake near Wilmette.

48

## Impacts of Physical Separation: To be Quantified

# Potential Impact	Discipline	Stakeholder	Description
1 Cost 0 Avoidance	General infrastructure	USACE	Avoided costs from not having to maintain and operate the Chicago and O'Brien Locks.

49

## Impacts of Physical Separation: To be Quantified

# Potential Impact	Discipline	Stakeholder	Description
1 Benefit 1	Ecological health.	Public	The economic value of returning additional potable water to Lake Michigan and ecological value of returning water to lake.

50

## Impacts of Physical Separation: To be Quantified

# Potential Impact	Discipline	Stakeholder	Description
1 Benefit 2	Transportation	Public	Reduction in rail delays associated with lift bridges spanning the Calumet River (pertains to Option 15 only).

51

## Impacts of Physical Separation: To be Quantified

# Potential Impact	Discipline	Stakeholder	Description
1 Cost 3	Transportation	Barge Operators	Increased costs associated with barge operators requiring additional barges on both sides of separation barrier.

52

## Impacts of Physical Separation: To be Quantified

# Potential Impact	Discipline	Stakeholder	Description
14 Others			

53

## Key Challenges for Major Impacts

- Estimating the value of a reduction in the economic and environmental costs associated with future AIS transfer(s) without supporting forecast data.
  - Leverage historical literature
  - Scenario Analysis – look explicitly at various potential impacts.
- Estimating transportation cost impacts for existing and new cargoes.
  - How much cargo changes modes?
  - How much new cargo realized?
  - Use scenario analysis

54

## Project Outputs

55

## Evaluation Criteria

### Overview

#### Whether to Proceed

Measure of Worth	Definition	Interpretation
Net Present Value	Present-day value of benefits less present-day value of costs	NPV greater than zero means project is economically efficient. Projects are ranked according to NPV
Rate of Return	The discount rate at which NPV=0	Rate-of-Return should exceed pre-set hurdle to qualify for consideration
Benefit-Cost Ratio	Present value of benefits divided by the present value of costs. Indicates dollars of benefit per \$1.00 of cost	A ratio of greater than one means a worthwhile project

#### When to Proceed

Measure of Timing	Definition	Interpretation
First Year Benefit	Benefits in the first year after implementation divided by costs to date including interest paid during construction, expressed as a percent.	A ratio equal to the hurdle rate means the project is optimally timed. A ratio below the hurdle rate means the project is immature. A ratio above the hurdle rate is overdue
Pay-Back Period	Number of years until capital recouped through the flow of benefits	A short pay-back period means less risk

56

## Next Steps

- Finalize benefit categories for peer review
- Collect data to populate model inputs
- Results review at September RAP session

57

## Background

58

## Total Economic Value of Ecosystem

- **Direct values.** The raw materials and physical products that are used directly for production, consumption and sale.
- **Indirect values.** The ecological functions which maintain and protect natural and human systems and provide essential life support (e.g., watershed protection, nutrient cycling)
- **Option values.** The premium placed on maintaining ecosystems, landscapes, species and genetic resources for future possible uses which have economic value.
- **Existence values.** The value of ecosystem attributes and their component parts, regardless of current or future possibilities to use them - people value simply because they exist.

59







ONE COMPANY | *Many Solutions*<sup>®</sup>

# Peer Review RAP Workbook

**Envisioning a Chicago Area  
Waterway System for the 21st  
Century**

**August 24, 2011**

HDR Corporation  
Decision Economics

Risk Analysis • Investment and Finance  
Economics and Policy

# **Peer Review RAP Workbook**

**Envisioning a Chicago Area  
Waterway System for the 21st  
Century**

**August 24, 2011**

Prepared By:

HDR

## Introduction

This Risk Assessment Process (RAP) workbook provides an overview of the cost benefit analysis (CBA) framework for assessing the costs and benefits of the three alternatives identified for physically separating the Mississippi River and Great Lakes Basins in the Chicago Area Waterway System (CAWS). The workbook identifies the benefit and cost categories to be assessed and provides an overview of how each will be quantified through structure and logic models. The workbook also contains an Appendix I that provides a summary literature review and cost database of AIS impact studies.

The three alternatives to be assessed are:

1. The Mid River Alternative (4/5,10,13,20);
2. The Near Lake Alternative (19&3,10,13,15); and,
3. The Down River Alternative (9/16).

Each alternative will be assessed **relative** to a base case alternative that does not entail physical separation. The base case includes the following attributes:

- Continued mitigation of Aquatic Invasive Species (AIS) transfer through electrification
- Current, programmed and authorized infrastructure investments:
  - Transportation – CREATE, Chicago Park District Marina (1200 slips)
  - Storm Water Management – TARP
    - Phased in per timeline – 2029
    - Improved conveyance in accordance with TARP
  - Water Quality
    - Disinfection on North Side and Calumet Plants

All impacts identified in the cost benefit analysis will reflect impacts that are incremental to the base case. For example, costs associated with storm water mitigation for the Near Lake Alternative will reflect costs over and above what is forecast to be incurred in the base case for TARP or incremental costs.

It should also be pointed out that each of the alternatives under consideration contains significant mitigation measures to offset some of the potential negative effects of implementing a physical barrier on the CAWS such as increased flooding, stagnation, and disrupted transportation services. The Cost Benefit Analysis will include the cost of these

mitigation measures for each alternative and, where possible, separately identify the benefits of the mitigation.

The CBA framework utilizes a consumer/producer surplus approach that is focused on gains or losses to different groups (e.g., consumers, producers). Typically, the total benefits associated with an alternative are compared to the total costs of the alternative to determine if the benefits outweigh the costs. It may not always be possible to quantify all potential effects, but a qualitative assessment of the relevant effects should also be considered if quantification is not feasible.

Two important considerations for quantifying costs and benefits in a Cost Benefit Analysis study:

1. How many years to utilize for forecasting costs and benefits (e.g., the study period); and,
2. What discount rate to apply to future streams of costs and benefits to put everything in a common basis (e.g., 1 \$ now is worth more than 1 \$ next year).

For this study, we recommend using a:

1. Study period that extends 30 years from barrier completion (including all mitigation strategies being in place). The cost benefit analysis will consider all costs and benefits from 2012 to 2059.
  - a. Sensitivity analysis can also be done to assess the impact of various study periods (e.g., longer).
2. Discount rate of 3 percent (real) consistent with USACE guidelines for waterway projects
  - a. Sensitivity analysis of 7 percent (real) based on other OMB guidelines (Office of Management and Budget (OMB) – “Circular No. A-94 – Guidelines and Discount Rates for BCA of Federal Programs”)

**Table 1: Summary of Cost Benefit Analysis Study Parameters**

General Inputs	Value	Notes
Study Period	2012-2059	Study period extends 30 years from completion of barriers
Base Year of Analysis	2011	
Year Costs/Benefits Start	2012	
Completion Year of Barriers	2029	Barriers are to be completed in line with TARP
End Year of Analysis	2059	
Discount Rate (Real)	3%	Sensitivity analysis using a 7% real discount rate

### Cost and Benefit Categories

The table below (Table 2) provides the proposed cost and benefit categories for assessing the three barrier alternatives relative to the base case. The specific impacts are based on a review of the literature, consultation with the project team and other stakeholders, and feedback from the RAP Session on August 3, 2011.

The cost and benefit categories or impacts have been separated by the following disciplines: prevention of AIS transfer, transportation, storm water management, and ecological health. The potential impact (cost or benefit) is displayed in the table along with a description of the impact and the stakeholders that would be affected.

For most impacts, there is an associated *structure and logic* diagram displaying how the impact will be calculated. In some instances, the mitigation measures for the alternative have been designed to fully offset a potential negative impact and therefore the impact is nullified but the cost of the mitigation is captured in the cost estimate for the alternative. In these cases, no structure and logic model is included.

The structure and logic diagrams are shown in the following section and list the barrier options applicable to each impact category.

**Table 2: Cost Benefit Analysis Cost and Benefit Categories**

#	Discipline	Impact Category	Potential Impact	Description	Stakeholder
1A	Prevention of AIS Transfer	AIS Risk	Benefit	Physical separation will reduce the risk of future transfers of AIS transfer in the Great Lakes and Mississippi River Basins through the CAWS resulting in the avoidance of economic costs and ecosystem damage of AIS. This is a multi-faceted impact, including: 1. Reduction in cost of prevention (base case); 2. Reduction in cost of control and eradication (post separation); 3. Use value - reduction in recreational use; 4. Commercial value; 5. Ecosystem value; 6. Option use.	Public
2A	Transportation	Shipping Costs - Cargo Handling	Cost	For cargo that continues to utilize the CAWS after separation, additional costs for shippers associated with the handling of cargo over the separation barrier from barge to barge. Included in these additional costs is the cost to barge operators of less efficient use of barge resources; physical separation will result in less efficient utilization of barge resources as barges will not be able to cross the physical separation barrier.	Shippers
2B	Transportation	Shipping Costs – Higher Shipping Rates After Modal Shift	Cost	Diversion of traditional cargoes from barge to other modes due physical separation will result in increased shipping costs.	Shippers



#	Discipline	Impact Category	Potential Impact	Description	Stakeholder
2C	Transportation	Emissions	Cost	Diversion of traditional cargoes from barge to other modes will result in increased emission levels. Emissions are a mode specific externality and are based on the net ton-miles diverted from barge to other modes and the change in emissions by mode on a grams per ton-mile basis.	Public
2D	Transportation	Accidents	Cost	Diversion of traditional cargoes from barge to other modes will result in additional accident-related costs. Accident costs are a mode specific externality and are calculated based on net ton-miles diverted and industry data on accident cost per ton-mile.	Public
2E	Transportation	Infrastructure Operating and Maintenance Costs	Cost	Diversion of traditional cargoes from barge to other modes will result in increases in operating and maintenance costs on other transportation facilities (e.g., highway, rail).	Public
2F	Transportation	Congestion	Cost	Diversion of traditional cargoes from barge to other modes will result in increased levels of traffic congestion. Traffic congestion is a mode specific externality and is a function of the capacity of the facility and total volume of traffic.	Public
3A	Transportation	New Cargo Potential – Reduced Shipping Costs	Benefit	The new port development at Calumet or Lake Michigan will facilitate the diversion of some cargo (e.g. container) that would have otherwise travelled overland to barge. This would result in a decrease in transportation costs associated with non-traditional (historically) cargoes moving through the CAWS facilitated by new port at the separation barrier.	Shippers
3B	Transportation	Emissions	Benefit	Diversion of new cargoes from other modes to barge will result in decreased emission levels. Change in emission costs will be calculated in the same manner as 2C.	Public

#	Discipline	Impact Category	Potential Impact	Description	Stakeholder
3C	Transportation	Accidents	Benefit	Diversion of new cargoes from other modes to barge will result in decreased accident-related costs. Change in accident costs will be calculated in the same manner as 2D.	Public
3D	Transportation	Infrastructure Operating and Maintenance Costs	Benefit	Diversion of new cargoes from other modes to barge will result in decreases in operating and maintenance costs on other transportation facilities (e.g., highway, rail). Change in operating and maintenance costs will be calculated in the same manner as 2E.	Public
3E	Transportation	Congestion	Benefit	Diversion of new cargoes from other modes to barge will result in decreased levels of traffic congestion. Change in traffic congestion will be calculated in the same manner as 2F.	Public
4A	Transportation	Recreational Boat Barrier Crossing	Cost	For recreational boaters that will use the lifts to cross the separation barrier and have the boat disinfected, there will be additional time costs for each transit (relative to the time to time to get through the locks).	Recreational Boaters
4B	Transportation	Recreational Boat Time Savings	Benefit	The Mid-River Alternative would allow the Chicago Lock to remain permanently open. This would reduce the annual time recreational boaters spend waiting to pass through the locks.	Recreational Boaters
4C	Transportation	Marina Relocation	Cost	Post separation, some boaters may relocate marinas to be lakeside. This may result in additional travel time costs and vehicle operating costs.	Recreational Boaters
4D	Transportation	Recreational Boat Servicing and Storage	Cost	Physical separation may impede access for recreational boaters to dry docks for servicing and storage. Additional costs have been assumed for new dry dock facilities to mitigate this impact.	

#	Discipline	Impact Category	Potential Impact	Description	Stakeholder
5A	Transportation	Water Taxi O&M	Cost	Physical separation may impede access for water taxi operators to dry docks where vessels are serviced and stored. Additional costs have been assumed for new dry dock facilities to mitigate this impact.	Water Taxi Operators
5B	Transportation	Additional Commercial Tour Vessels	Cost	The Near Lake Alternative would disrupt service for tour operators that traverse both the river and lake and they may require additional vessels to maintain level of service.	Commercial Tour Operators
5C	Transportation	Commercial Tour O&M	Cost	Physical separation may impede access for commercial tour operators to dry docks for servicing and storage. Additional costs have been assumed for new dry dock facilities to mitigate this impact.	Tour Operators
6A	Transportation	Additional Public Safety Vessels	Cost	The Mid-River and Near Lake Alternative would restrict the operation of emergency vessels and necessitate additional emergency vessels on both sides of separation barrier for Chicago Police and Fire Departments. The additional vessels may also require additional mooring, O&M, and staffing costs.	Public Agencies
7A	Transportation	Reduced Train Delay	Benefit	Reduction in rail delays associated with lift bridges spanning the Calumet River (pertains to Near Lake Alternative only).	Shippers/Rail Operators
8A	Stormwater Management	Flood Mitigation	Cost	Without mitigation, flooding and the number of CSOs will be impacted as a result of the barriers. Mitigation strategies and associated cost estimates have been developed to ensure that stormwater management is no worse off relative to the base case.	Public, Property Owners
9A	Ecological Health	Water Quality Mitigation / Improvement	Cost / Benefit	Water quality and ecological health may be impacted as a result of barriers. Mitigation measures and associated cost estimates have been developed to ensure that water quality is no worse off than the base case. However, some alternatives may improve water quality in some areas of the CAWS and may result in increased recreational uses	Public

#	Discipline	Impact Category	Potential Impact	Description	Stakeholder
				and species diversification.	
10A	Transportation	Enhanced Access to Lake	Benefit	Some barrier location options will enhance lake access, providing an opportunity to develop new harbors, marinas, and recreational fishing opportunities. <i>This may be capitalized through increased property values.</i>	Public
11A	General Infrastructure	Infrastructure Cost Avoidance	Benefit	Cost savings from not having to maintain and operate the displaced locks.	USACE
12A	General Infrastructure	Infrastructure Costs	Cost	Cost to construct, maintain and operate the separation barriers (including lifts, ports, etc.) plus all incremental costs associated with infrastructure costs including mitigating transportation, storm water, sediment mitigation, flow augmentation, ecological health, and WWTP upgrades relative to the base case.	Public

## **Cost and Benefit Category 1A: Treatment of AIS Impacts in CBA**

For including the benefit of the reduction in the economic and ecosystem damage from future AIS transfers, we propose to determine the benefit on a case study basis. Case studies will be selected to demonstrate the annual value (and value over the full study period of the cost benefit analysis) of preventing damage from AIS. This value can be compared against all the other impacts identified in the cost benefit analysis to assess whether in totality the benefits outweigh the costs based on a reasoned set of case studies. We have selected this case study based approach rather than developing independent forecasts of future damage from AIS transfers because existing quantitative research on the forecasted impact of economic and ecological damage of AIS and the future transfers of AIS between basins does not currently exist.

To illustrate, if we select as a case study the annual historical impact of AIS such as a Zebra Mussel, we would project the damage that a physical barrier could have been prevented based on what the recent empirical evidence has provided. If the historical annual cost of the zebra mussel is \$300M, prevention of a single AIS transfer with a similar damage profile would yield benefits of about \$5B over the full study lifecycle.

Providing a reasoned set of case studies can effectively demonstrate the value of preventing future AIS transfers.

## **Structure and Logic Diagrams**

Structure and logic (S&L) diagrams illustrate how an impact is quantified. S&L diagrams are the graphical representation of an equation, where each box is a variable (input, intermediate output, output) and the links between boxes are operations (add, multiply, divide, etc.) S&L diagrams differ from a flowchart, influence diagram, or decision tree, as they provide us with the framework to understand and calculate the potential impacts to be evaluated.

S&L diagrams allow the project team to think through a problem. They provide the ability to communicate with and seek feedback from others on the project team and peer reviewers. In this section, S&L diagrams have been included for all the impact categories shown in Table 1. For each set of diagrams, there is a legend showing which barrier combinations they are applicable to.

**1A - AIS Risk**

No AIS Risk structure and logic diagram.

**2 – Cargo Forecast (Base Case, Intermediate Calculation)**

**Baseline Bulk Cargo Forecast by Type by Barrier by Year**

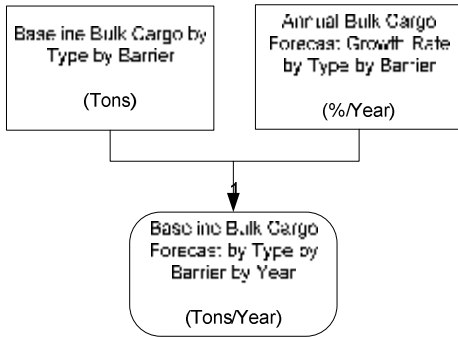

**Baseline Container Cargo Forecast by Type by Year (Regional Container Traffic)**

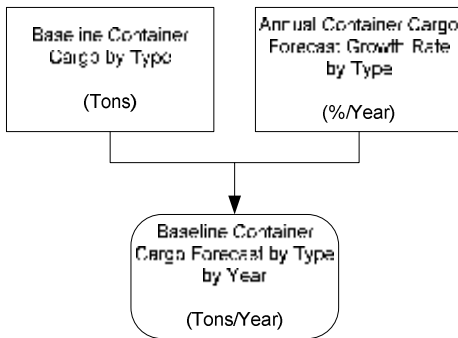

VALID FOR BARRIER COMBINATIONS	
Mid River Alternative	4/5,10,13,20
Near Lake Alternative	19&3,10,13,15
Down River Alternative	9/16

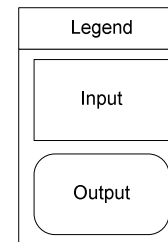



**2 – Cargo Diversion (After Separation, Intermediate Calculation)**

**Bulk Tons Diverted to Rail by Type by Year**

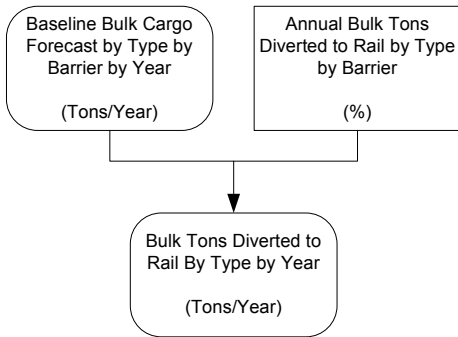

**Bulk Tons Diverted to Truck by Type by Year**

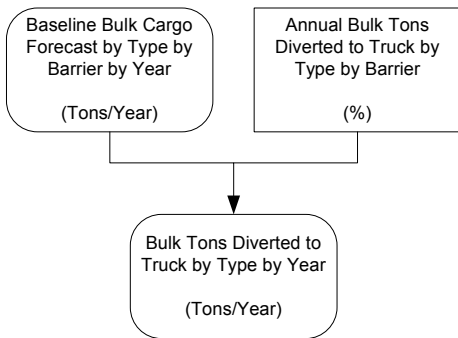

VALID FOR BARRIER COMBINATIONS	
Mid River Alternative	4/5,10,13,20
Near Lake Alternative	19&3,10,13,15
Down River Alternative	9/16

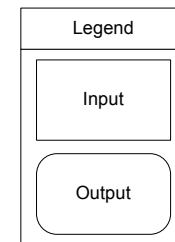

**2A – Shipping Costs - Cargo Handling**

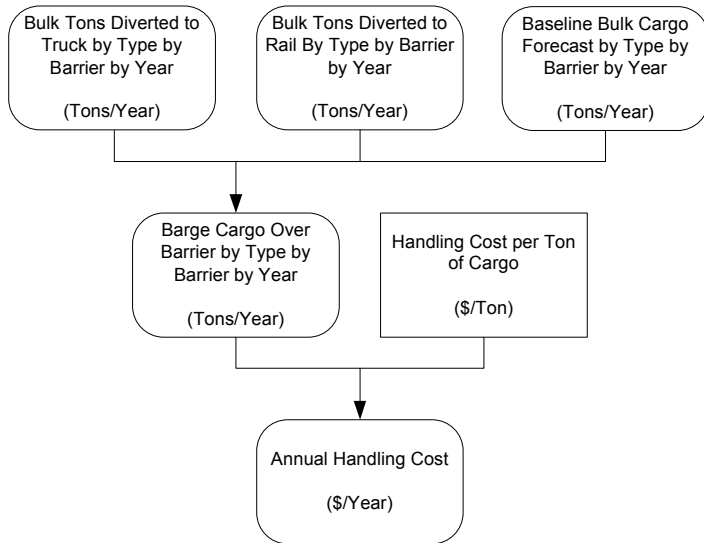

VALID FOR BARRIER COMBINATIONS	
Mid River Alternative	4/5,10,13,20
Near Lake Alternative	19&3,10,13,15
Down River Alternative	9/16

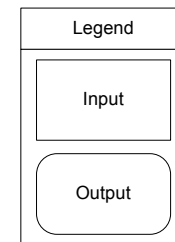

**2B – Shipping Costs – Higher Shipping Rates After Modal Shift**

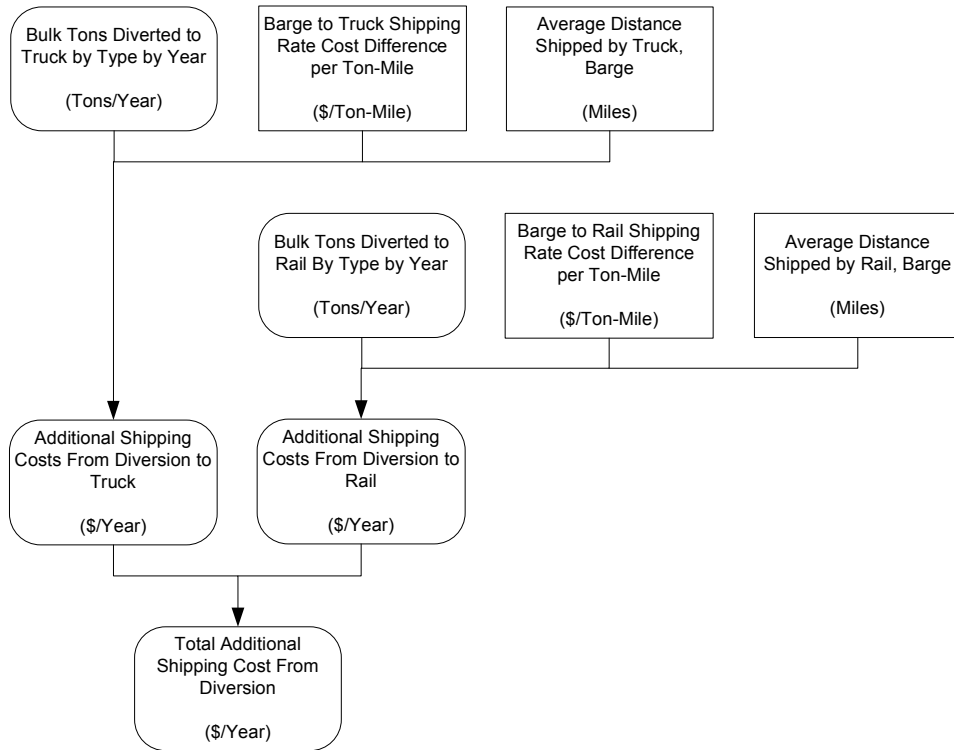

VALID FOR BARRIER COMBINATIONS	
Mid River Alternative	4/5,10,13,20
Near Lake Alternative	19&3,10,13,15
Down River Alternative	9/16

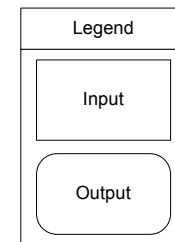

## 2C – Emissions

### Change in Rail Emission Cost From Diversion

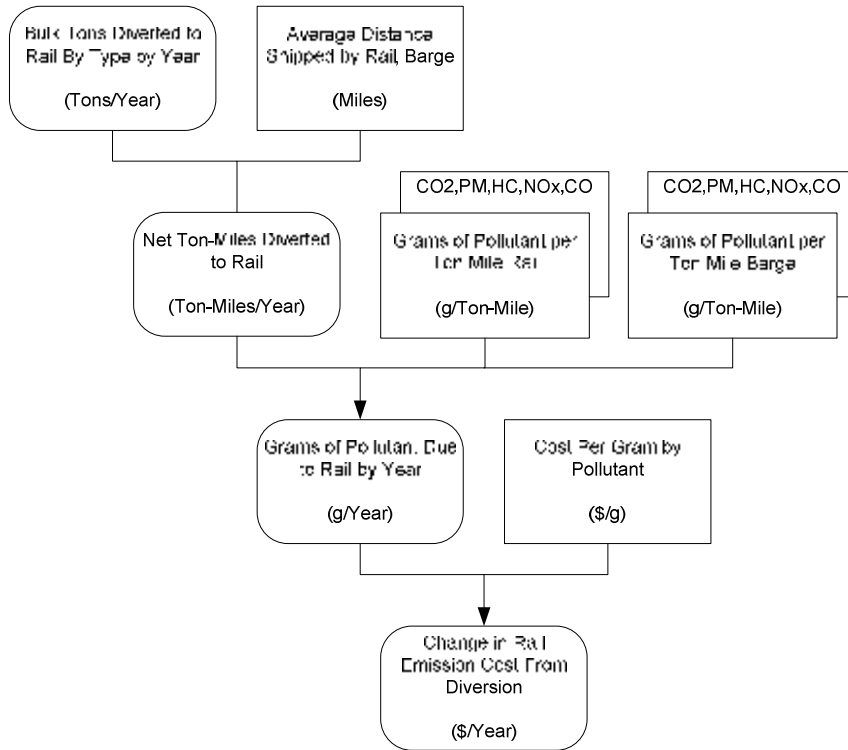

### Change in Truck Emission Cost From Diversion

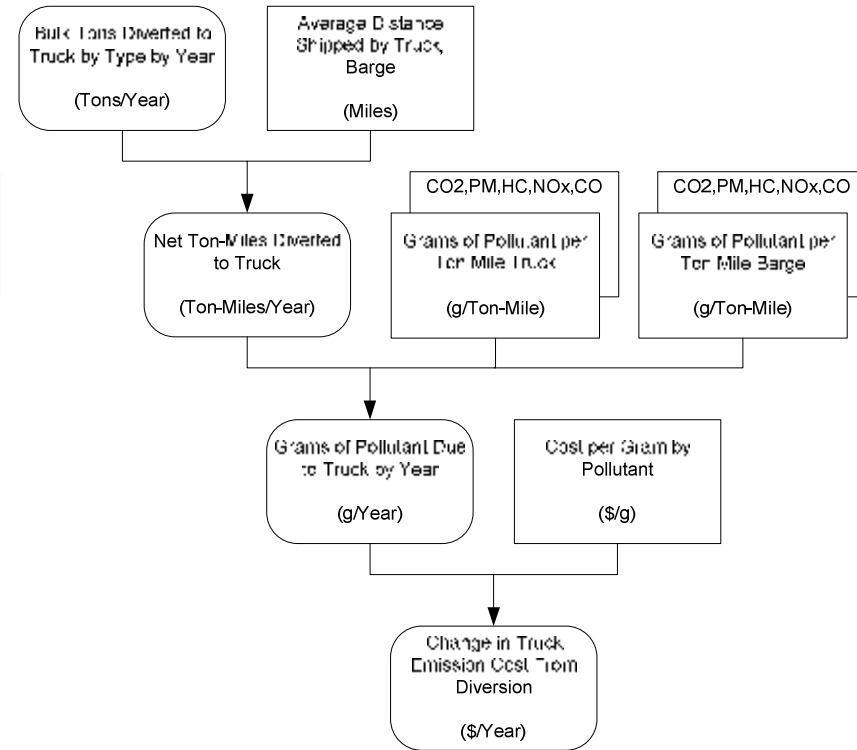

VALID FOR BARRIER COMBINATIONS	
Mid River Alternative	4/5,10,13,20
Near Lake Alternative	19&3,10,13,15
Down River Alternative	9/16

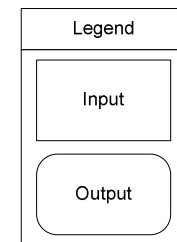

## 2D - Accidents

### Change in Rail Accident Cost From Diversion

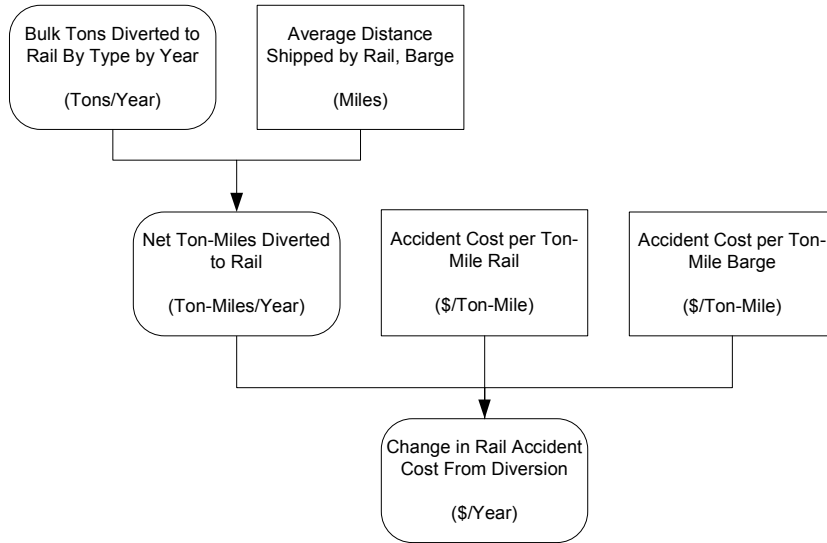

### Change in Truck Accident Cost From Diversion

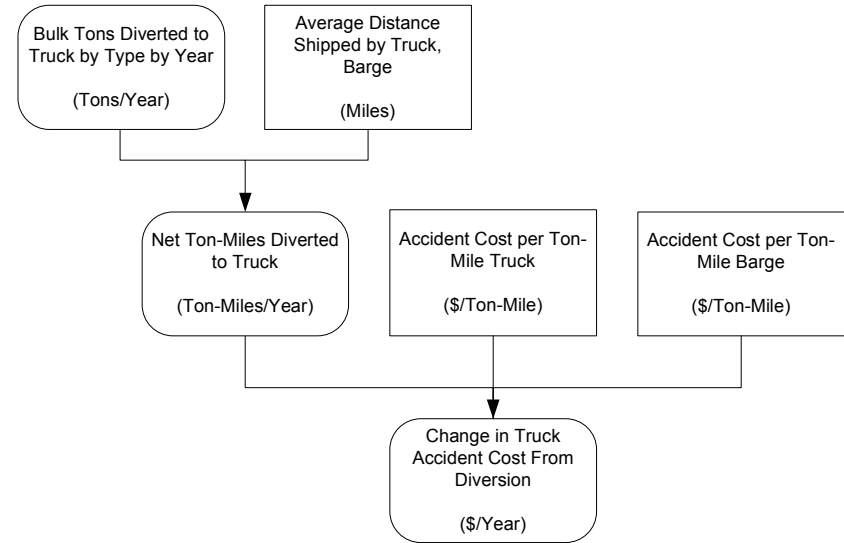

VALID FOR BARRIER COMBINATIONS	
Mid River Alternative	4/5,10,13,20
Near Lake Alternative	19&3,10,13,15
Down River Alternative	9/16

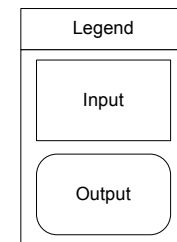

**2E – Infrastructure Operating and Maintenance Costs**

**Change in Rail Operating and Maintenance Cost From Diversion**

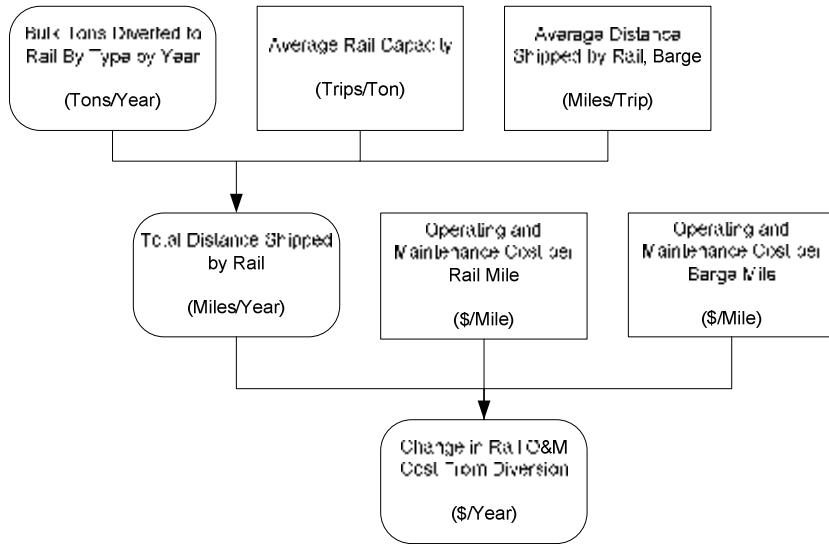

**Change in Truck Operating and Maintenance Cost From Diversion**

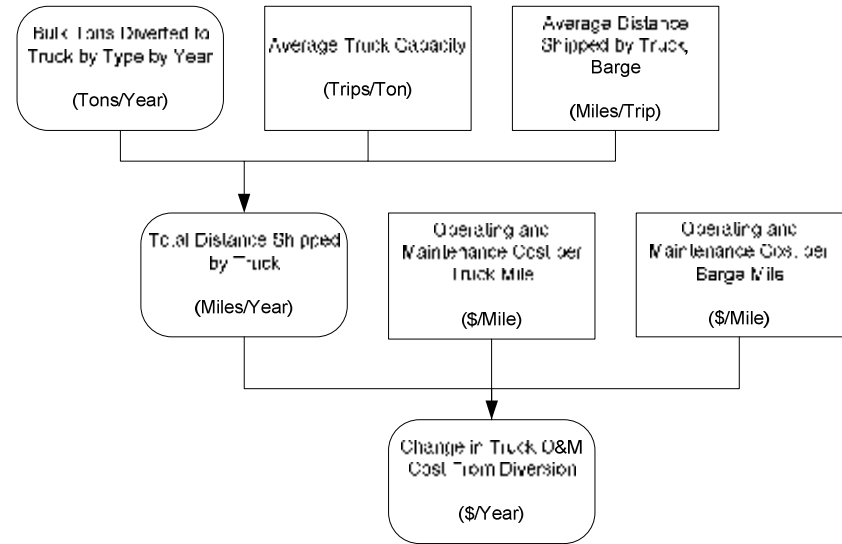

VALID FOR BARRIER COMBINATIONS	
Mid River Alternative	4/5,10,13,20
Near Lake Alternative	19&3,10,13,15
Down River Alternative	9/16

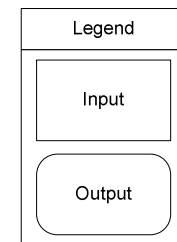



## 2F - Congestion

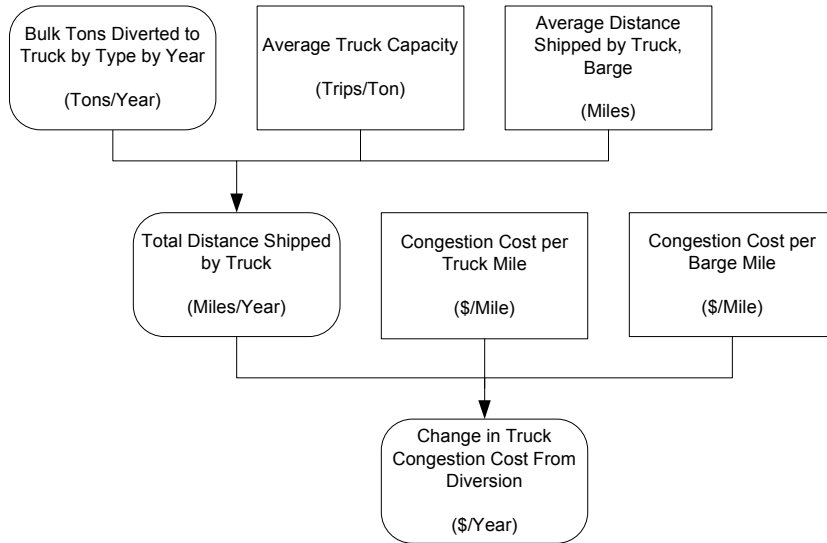

VALID FOR BARRIER COMBINATIONS	
Mid River Alternative	4/5,10,13,20
Near Lake Alternative	19&3,10,13,15
Down River Alternative	9/16

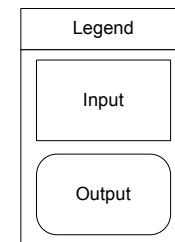

### 3A – New Cargo Potential – Reduced Shipping Costs

#### Barge Container On Board From Rail

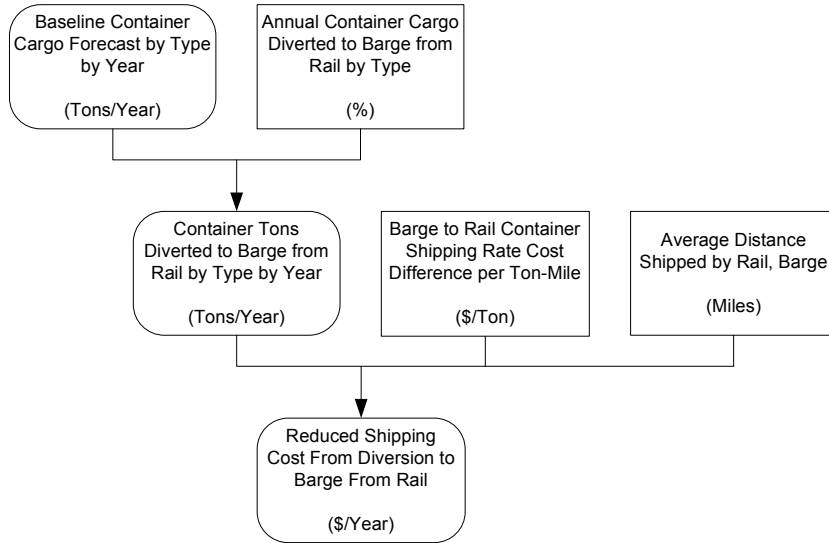

#### Barge Container On Board From Truck

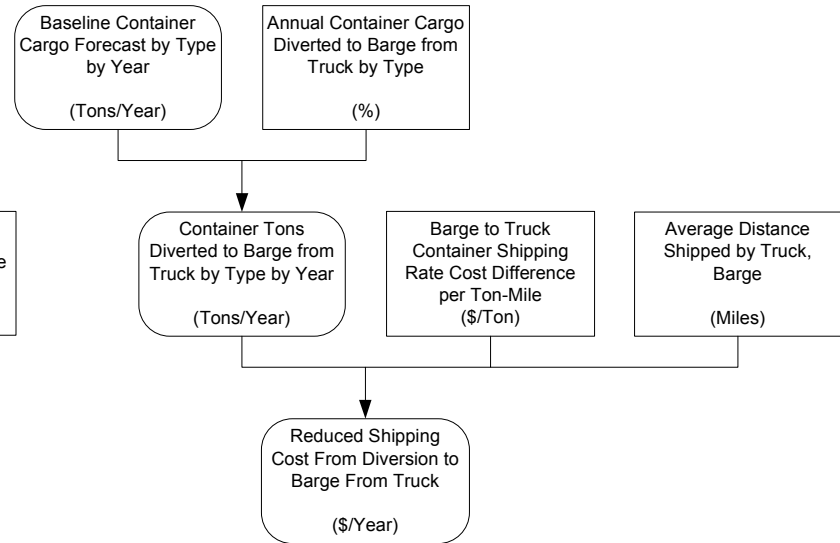

VALID FOR BARRIER COMBINATIONS	
Mid River Alternative	4/5,10,13,20
Near Lake Alternative	19&3,10,13,15
Down River Alternative	9/16

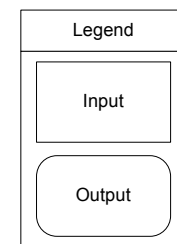

**3B - Emissions**

Calculated in the same manner as 2C.

**3C - Accidents**

Calculated in the same manner as 2D.

**3D – Infrastructure Operating and Maintenance Costs**

Calculated in the same manner as 2E.

**3E - Congestion**

Calculated in the same manner as 2F.

## 4A – Recreational Boat Barrier Crossing

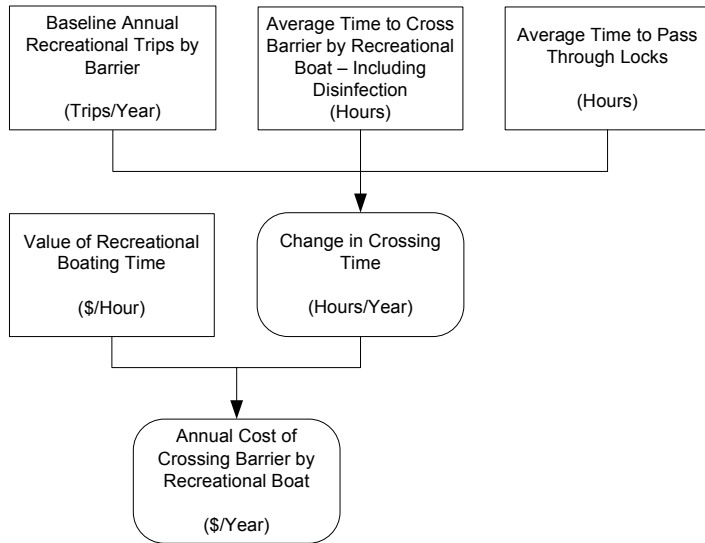

VALID FOR BARRIER COMBINATIONS	
Mid River Alternative	4/5,10,13,20
Near Lake Alternative	19&3,10,13,15
Down River Alternative	9/16

Legend
Input
Output

**4B – Recreational Boat Time Savings**

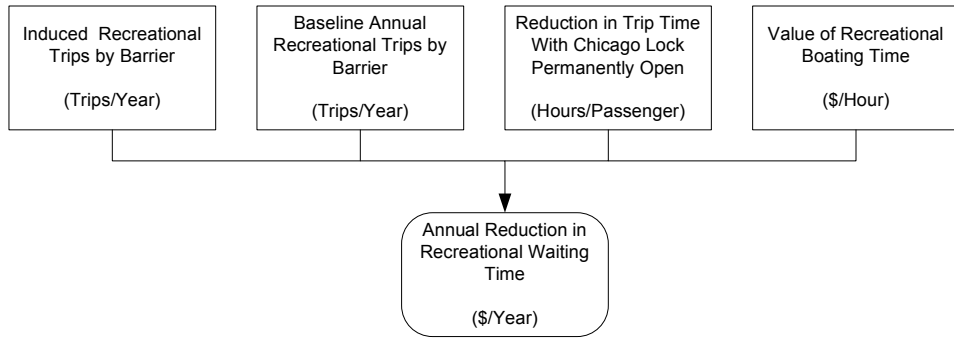

VALID FOR BARRIER COMBINATIONS	
Mid River Alternative	4/5,10,13,20
Down River Alternative	9/16

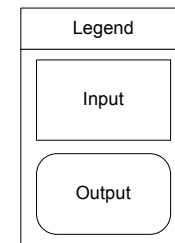

## 4C – Marina Relocation

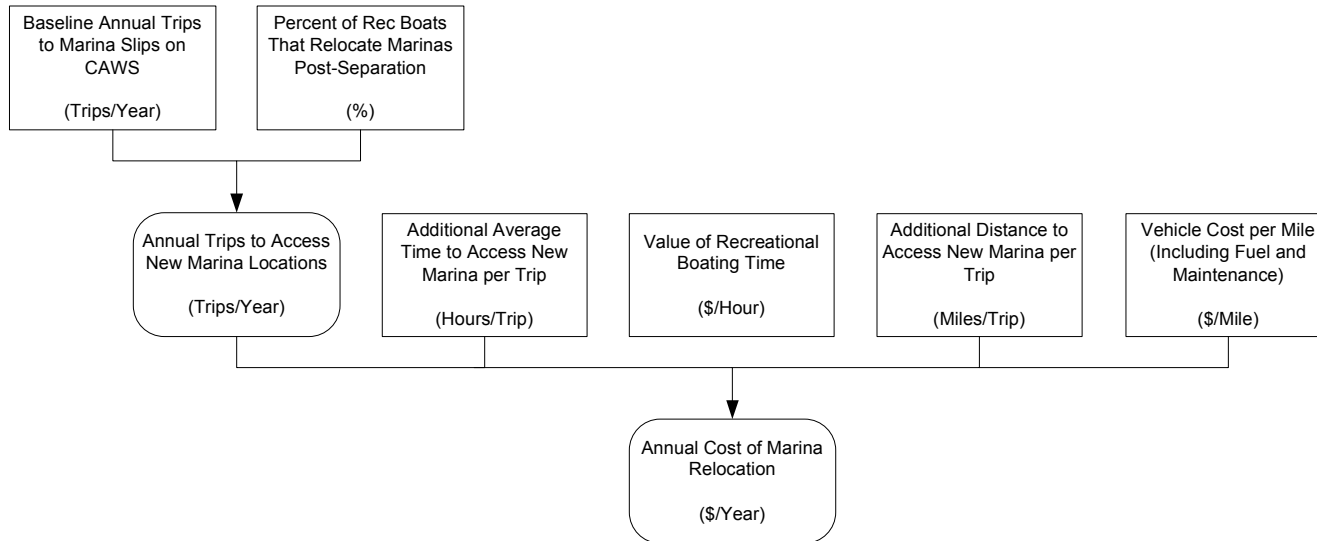

VALID FOR BARRIER COMBINATIONS	
Mid River Alternative	4/5,10,13,20
Near Lake Alternative	19&3,10,13,15

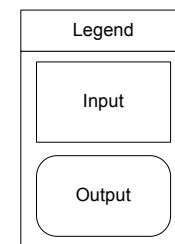



**4D – Recreational Boat Servicing and Storage**

No structure and logic diagram, costs have been captured in 12A Infrastructure Costs.

**5A – Water Taxi O&M**

No structure and logic diagram, costs have been captured in 12A Infrastructure Costs.

**5B – Additional Commercial Tour Vessels**

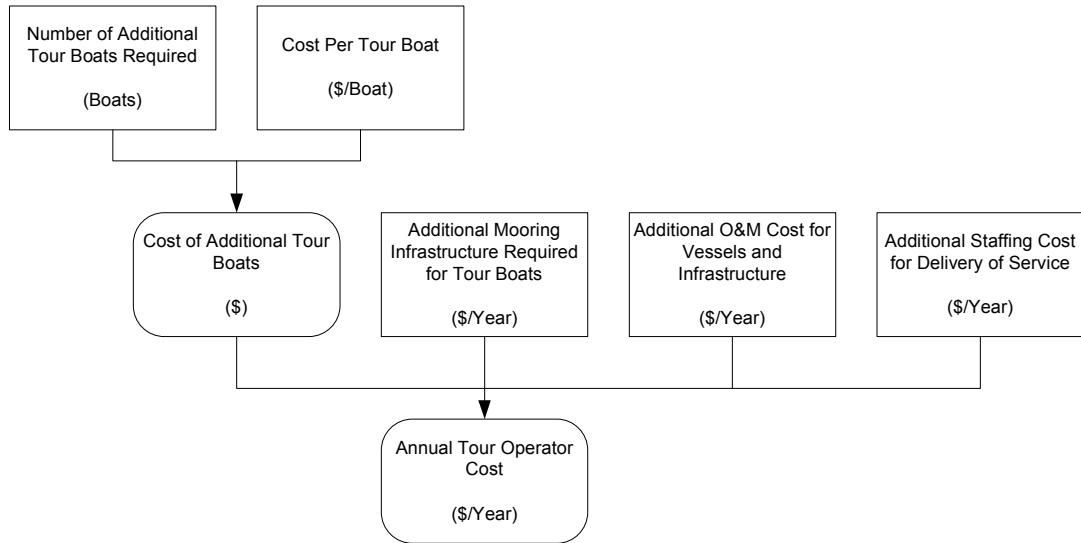

VALID FOR BARRIER COMBINATIONS	
Near Lake Alternative	19&3,10,13,15

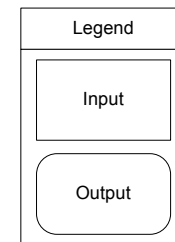

**5C – Commercial Tour O&M**

No structure and logic diagram, costs have been captured in 12A Infrastructure Costs.

**6A – Additional Public Safety Vessels**

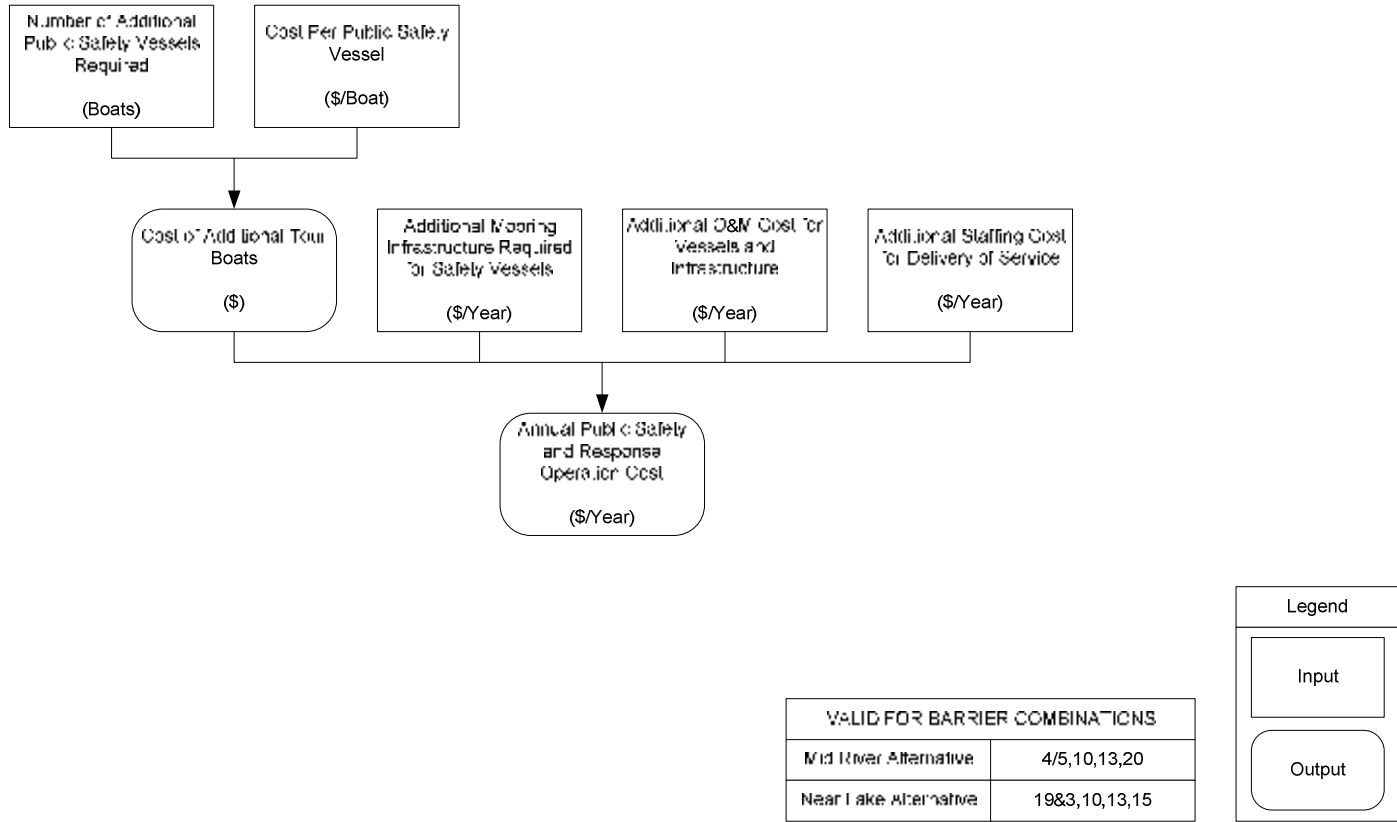

## 7A – Reduced Train Delay

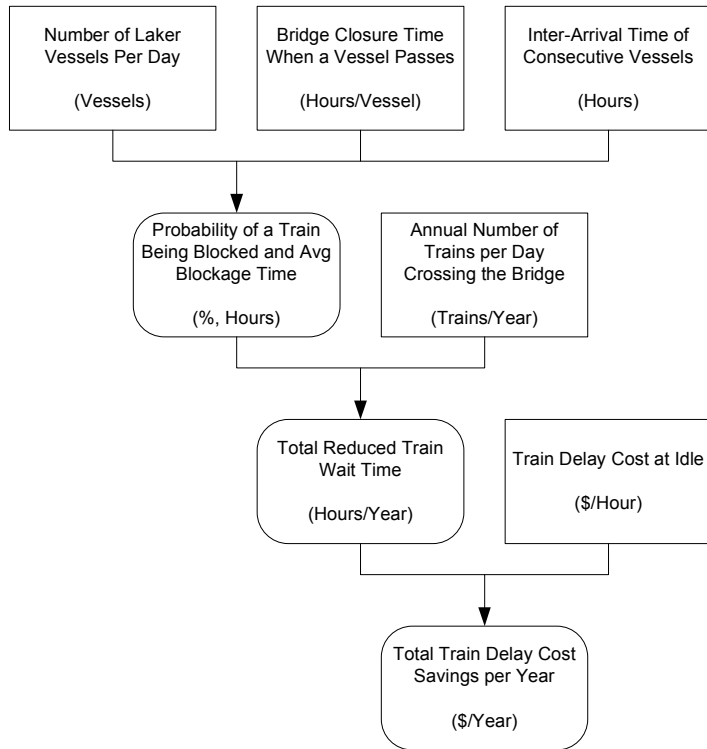

VALID FOR BARRIER COMBINATIONS	
Mid River Alternative	4/5,10,13,20

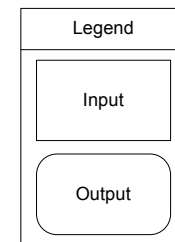

**8A – Flood Mitigation**

No structure and logic diagram, costs have been captured in 12A Infrastructure Costs.

**9A – Water Quality Mitigation/Improvement**

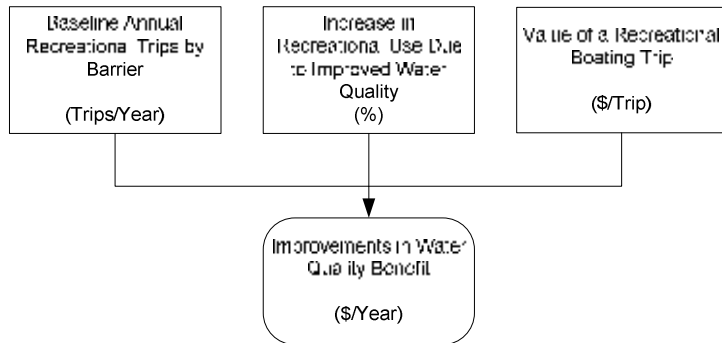

VALID FOR BARRIER COMBINATIONS	
Mid River Alternative	4/5,10,13,20
Down River Alternative	9/16

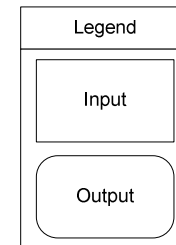

**10A – Increased Access to the Lake**

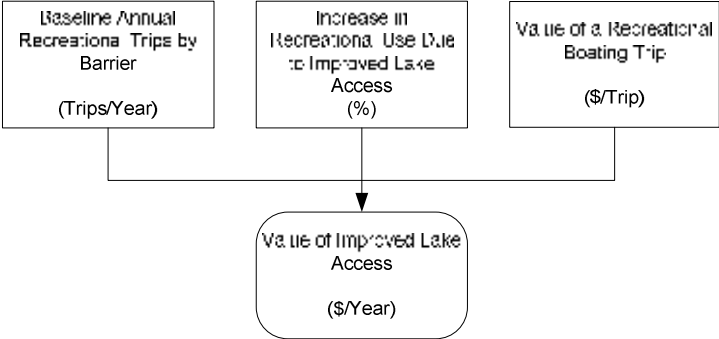

VALID FOR BARRIER COMBINATIONS	
Mic River Alternative	4/5,10,13,20
Down River Alternative	9/16

Legend

Input

Output



**11A – Infrastructure Cost Avoidance**

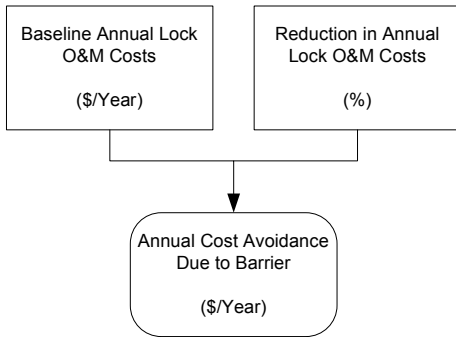

VALID FOR BARRIER COMBINATIONS	
Mid River Alternative	4/5,10,13,20
Near Lake Alternative	19&3,10,13,15
Down River Alternative	9/16

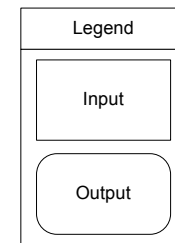

**12A – Infrastructure Costs**

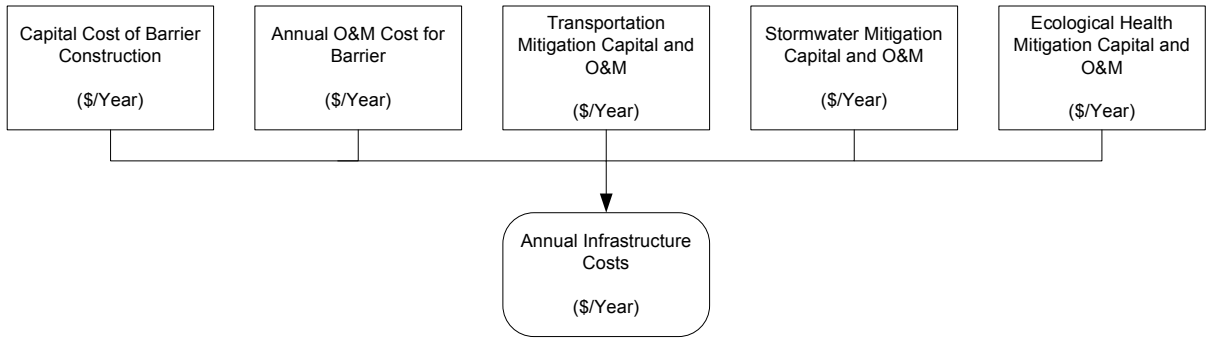

VALID FOR BARRIER COMBINATIONS	
Mid River Alternative	4/5,10,13,20
Near Lake Alternative	19&3,10,13,15
Down River Alternative	9/16

Legend
Input
Output

## Appendix I: Review of AIS Impact Studies

#	AIS	Annual Impact	Year of Cost	Location	Impacts Quantified	Study Approach	Notes	Reference
1	All Aquatic Invasives	N/A	2005	N/A	This paper is a literature review of economic impacts of aquatic invasive species and source for many of the numbers found below in this table.		<p>This paper reviews the economic literature on invasive species, focusing on estimates of the costs of aquatic invasives. The most obvious point of the paper is that the literature is still in its infancy. There are few theoretical and even fewer empirical, studies dealing with the economic costs of invasive species. The aquatic studies obtaining cost estimates reviewed above show values ranging from several hundreds of thousands of dollars a year to tens of millions of dollars a year. It seems apparent that a systematic approach is needed to develop a consistent method to estimate such costs.</p> <p>The second point the paper illustrates is the difficulty involved in obtaining such an estimate. Determining economic costs of environmental concerns is no easy task under the best of circumstances.</p> <p>Besides the common measurement problems and lack of observable data, measuring the economic costs of invasive species involve determining rates of biological propagation which don't always conform neatly with economic metrics (such as years or states). There are also the difficulties associated with assessing the risks of invasives. While few NIS actually become invasives and even fewer of those invasives cause significant harm, the harm caused by these few can be quite substantial. How to estimate the benefits associated with controlling such a process is a difficult task.</p>	Lovell, S. and Stone, S. 2005. The Economic Impacts of Aquatic Invasive Species: A Review of the Literature. National Center for Environmental Economics.

#	AIS	Annual Impact	Year of Cost	Location	Impacts Quantified	Study Approach	Notes	Reference
2	All Fish	\$4.5 billion	2005	Great Lakes	Sport and commercial fishing	Based on literature review. No information on quantitative approach.	Original source is from a speech made by International Joint Commission Chairman, the Honorable Dennis Schornack.	Pimentel, David. 2005. Aquatic Nuisance Species in the New York State Canal and Hudson River Systems and the Great Lakes Basin: An Economic and Environmental Assessment. Environmental Management. Vol. 35, No. 5.
3	All Fish	\$1 billion	2000	National	Losses and damages	Personal communication with an expert.	No information to the extent of losses and damages. Estimate is anecdotal.	Pimentel, David et al. 2000. Environmental and Economic Costs of Nonindigenous Species in the United States. BioScience. Vol. 30, No. 1.
4	Aquatic Weeds (Plant)	\$7.3 million	1991	Florida	Estimated benefits for residential damage control in 11 Florida counties	Based on literature review. No information on quantitative approach.		Rockwell, William. 2003. Summary of a Survey of the Literature on the Economic Impact of Aquatic Weeds. For the Aquatic Ecosystem Restoration Foundation.
5	Aquatic Weeds(Plant)	\$5,000-8,000 per acre	1992	Florida	Benefits of control programs to citrus production	Based on literature review. No information on quantitative approach.		Rockwell, William. 2003. Summary of a Survey of the Literature on the Economic Impact of Aquatic Weeds. For the Aquatic Ecosystem Restoration Foundation.
6	Aquatic Weeds (Plant)	\$300,000	1992	Florida	Benefits of control programs to vegetable production	Based on literature review. No information on quantitative approach.		Rockwell, William. 2003. Summary of a Survey of the Literature on the Economic Impact of Aquatic Weeds. For the Aquatic Ecosystem Restoration Foundation.

#	AIS	Annual Impact	Year of Cost	Location	Impacts Quantified	Study Approach	Notes	Reference
7	Aquatic Weeds (Plant)	\$1.35 million	1984	Three lakes in Illinois	Recreational benefit of aquatic weed control. See Notes column for author's take on valuation of recreational benefits.	From literature review. Calculated based on willingness-to-pay.	<p>The valuation of recreational values-at-risk is particularly problematic. Although the undesirability of weeds for some forms of aquatic recreation is clear and is a major impetus for weed control in many situations, the impact of moderate weed growth – or, for that matter, exotic versus native weed growth – on fisheries habitat and fishing is somewhat ambiguous.</p> <p>In current studies, the distinctions between transient and local recreators and shoreline residents are couched almost exclusively in terms of travel-cost and expenditure-pattern differences. These distinctions seem to miss the significance of “sunk costs” (for example, in housing) to the values-at-risk, and the implications for both valuation and strategy (like lake associations) also seem to have been missed.</p> <p>The most striking fact about our lack of knowledge of the total magnitude of harm, however, is not just that it is probably greater than we think. The larger problem is that existing control decisions are likely made by considering only the harm to be prevented within the jurisdiction making the decision, without considering the additional harm caused if plants spread to other jurisdictions.</p> <p>A more comprehensive national approach to problems would take into account the fact that early detection and treatment would have the benefit of preventing harm that would not otherwise develop, following the age-old maxim that “an ounce of prevention is worth a pound of cure”.</p>	Rockwell, William. 2003. Summary of a Survey of the Literature on the Economic Impact of Aquatic Weeds. For the Aquatic Ecosystem Restoration Foundation.
8	Aquatic Weeds (Plant)	\$480,000	1986	Florida	Recreational benefit of aquatic weed control	From literature review. Calculated based on willingness-to-pay.		Rockwell, William. 2003. Summary of a Survey of the Literature on the Economic Impact of Aquatic Weeds. For the Aquatic Ecosystem Restoration Foundation.

#	AIS	Annual Impact	Year of Cost	Location	Impacts Quantified	Study Approach	Notes	Reference
9	Aquatic Weeds (Plant)	\$5 million	1986	Florida	Recreational benefit of aquatic weed control	From literature review. Calculated based on total recreational expenditures.		Rockwell, William. 2003. Summary of a Survey of the Literature on the Economic Impact of Aquatic Weeds. For the Aquatic Ecosystem Restoration Foundation.
10	Aquatic Weeds (Plant)	\$10 million	1986	Florida	Recreational benefit of aquatic weed control	From literature review. Calculated based on economic impact.		Rockwell, William. 2003. Summary of a Survey of the Literature on the Economic Impact of Aquatic Weeds. For the Aquatic Ecosystem Restoration Foundation.
11	Aquatic Weeds (Plant)	\$900,000	1987	Florida	Recreational benefit of aquatic weed control	From literature review. Calculated based on total recreational expenditures.		Rockwell, William. 2003. Summary of a Survey of the Literature on the Economic Impact of Aquatic Weeds. For the Aquatic Ecosystem Restoration Foundation.
12	Aquatic Weeds (Plant)	\$176,000	1989	Florida	Recreational benefit of aquatic weed control	From literature review. Calculated based on willingness-to-pay.		Rockwell, William. 2003. Summary of a Survey of the Literature on the Economic Impact of Aquatic Weeds. For the Aquatic Ecosystem Restoration Foundation.
13	Aquatic Weeds (Plant)	\$1.7 million	1989	Florida	Recreational benefit of aquatic weed control	From literature review. Calculated based on total recreational expenditures.		Rockwell, William. 2003. Summary of a Survey of the Literature on the Economic Impact of Aquatic Weeds. For the Aquatic Ecosystem Restoration Foundation.



#	AIS	Annual Impact	Year of Cost	Location	Impacts Quantified	Study Approach	Notes	Reference
14	Aquatic Weeds (Plant)	\$85 million	1993	Sixteen lakes in British Columbia	Recreational benefit of aquatic weed control	From literature review. Calculated based on total recreational expenditures.		Rockwell, William. 2003. Summary of a Survey of the Literature on the Economic Impact of Aquatic Weeds. For the Aquatic Ecosystem Restoration Foundation.
15	Aquatic Weeds (Plant)	\$100 million	1995	Alabama	Recreational benefit of aquatic weed control	From literature review. Calculated based on total recreational expenditures.		Rockwell, William. 2003. Summary of a Survey of the Literature on the Economic Impact of Aquatic Weeds. For the Aquatic Ecosystem Restoration Foundation.
16	Aquatic Weeds (Plant)	\$1-10 billion	2003	National		Impact estimates are extrapolated from Florida estimates based on treatment costs for infested waters and a B/C ratio of 10:1.	These numbers are based on original control cost estimates for aquatic weeds from Florida from 1989. It would be difficult to justify these numbers, as many assumptions such as cost inflation, B/C ratio, and Florida cost vs. national cost have been made.	Rockwell, William. 2003. Summary of a Survey of the Literature on the Economic Impact of Aquatic Weeds. For the Aquatic Ecosystem Restoration Foundation.

#	AIS	Annual Impact	Year of Cost	Location	Impacts Quantified	Study Approach	Notes	Reference
17	Aquatic Weeds (Plant)	\$110 million	2000	National	Recreational losses and control costs	\$10 million per year are estimated in recreational losses in two Florida lakes due to hydrilla infestations and \$100 million are total invested annually in control of nonindigenous aquatic weed species.		Pimentel, David et al. 2000. Environmental and Economic Costs of Nonindigenous Species in the United States. BioScience. Vol. 30, No. 1.
18	Asian Carp (Fish)	\$6.89 billion	2004	Great Lakes	Fishing industry	Based on assumption that Great Lakes are transformed into a "Great Carp Pond" and all fishing industry is lost.	Assumes no viable market for the Asian carp. Assumes 100% loss of Great Lakes fishing industry.	White, Gwen et al. 2004. Ecosystem Shock: The Devastating Impacts of Invasive Species on the Great Lakes Food Web. National Wildlife Federation.
19	Asian River Clam (Mollusk)	\$1 billion	2002	National	Biofouling of complex power plant and industrial water systems, as well as irrigation canals, pipes, and drinking water supplies	Based on literature review. No information on quantitative approach.	Original source is: Isom BG. 1986. Rationale for Sampling and Interpretation of Ecological Data in the Assessment of Freshwater Ecosystems.	Corn, Lynne et al. 2002. Invasive Non-Native Species: Background and Issues for Congress. Congressional Research Service, The Library of Congress.

#	AIS	Annual Impact	Year of Cost	Location	Impacts Quantified	Study Approach	Notes	Reference
20	Green Crab (Arthropod)	\$44 million	1996	National	Losses and damages to softshell clam industry in New England and Maritime provinces	Estimated as an economic impact.	Green crab also destroys commercial shellfish beds and preys on large numbers of native oysters and crabs.	Pimentel, David et al. 2000. Environmental and Economic Costs of Nonindigenous Species in the United States. BioScience. Vol. 30, No. 1.
21	Ruffe (Fish)	\$24-214 million	1998	Great Lakes	Sport and commercial fishing	Annual reduction in consumer surplus from loss of recreational fishing and annual reduction in producer surplus from loss of commercial fishing. Uses values for angler day loss and scenario analysis for reduction in fish population.	Paper also calculates an NPV of \$105-931 million over 50 projection. 3% real discount rate.	Leigh, Peter. 1998. Benefits and Costs of the Ruffe Control Program for the Great Lakes Fishery. National Oceanic and Atmospheric Administration.

#	AIS	Annual Impact	Year of Cost	Location	Impacts Quantified	Study Approach	Notes	Reference
22	Ruffe (Fish)	\$89 million	1992	Great Lakes	Sport and commercial fishing	Assumed 88% decline, similar to that observed in Loch Lomond, Scotland. Based on estimated perch and walleye harvest value in Lake Erie of over \$101 million. Uses a \$/kg value for walleye and perch and a multiplier of 4x commercial price to estimate sport value. Total kg harvest values come from Ontario Ministry of Natural Resources - 1990.		Ruffe Task Force. 1992. Ruffe in the Great Lakes: A Threat to North American Fisheries. Great Lakes Fishery Commission.
23	Sea Lamprey (Fish)	\$10-15 million	2002	Great Lakes	For control of sea lamprey only	Based on literature review. No information on quantitative approach.		Corn, Lynne et al. 2002. Invasive Non-Native Species: Background and Issues for Congress. Congressional Research Service, The Library of Congress.

#	AIS	Annual Impact	Year of Cost	Location	Impacts Quantified	Study Approach	Notes	Reference
24	Sea Lamprey (Fish)	\$8 million	1992	Great Lakes	For control of sea lamprey only	Based on Great Lakes Fishery Commission fiscal year 1991 budget.		GAO. 1992. Great Lakes Fishery Commission: Actions Needed to Support an Expanded Program. United States General Accounting Office.
25	Sea Lamprey (Fish)	\$2.6-\$4.7 million	1998	St. Mary's River	Sport fishing	Estimates of the benefits of control to Michigan anglers, based on catch rates under 3 scenarios.	Dollar values are based on projected 2015 population in 1994\$	Lupi, Frank et al. 1998. A Partial Benefit-Cost Analysis of Sea Lamprey Treatment Options on the St. Marys River. Department of Agricultural Economics, Michigan State University. Submitted to Great Lakes Fishery Commission.
26	Sea Lamprey (Fish)	\$2-4 billion	2000	Great Lakes	Benefits of control programs	Based on literature review. No information on quantitative approach.		Sturtevant, R. et al. 2000. The Great Lakes at the Millenium: Priorities for Fiscal 2001. Prepared for the Northeast Midwest Institute, Washington, DC.
27	Zebra Mussel (Mollusk)	\$0.75-1 billion over 10 years	2002	National	Only for cleaning water intake pipes, filtration equipment, power generating equipment, etc. Not including damage to docks, recreational or commercial boats, or other problems.	Based on literature review. No information on quantitative approach.		Corn, Lynne et al. 2002. Invasive Non-Native Species: Background and Issues for Congress. Congressional Research Service, The Library of Congress.

#	AIS	Annual Impact	Year of Cost	Location	Impacts Quantified	Study Approach	Notes	Reference
28	Zebra Mussel (Mollusk)	\$300-500 million	2006	Great Lakes	Resource damage costs	Estimates are for annual damages during the 1990s. Based on literature review. No information on quantitative approach.	The damages caused by nuisance species are the benefits foregone (or opportunity costs incurred) as a consequence of degraded resources and desired services. Some impacts can be measured in dollars of damage done. Other impacts have no widely accepted economic measure, such as impacts that threaten and endanger species. These environmental impacts are typically measured in non-monetary units of some kind, such as species relative abundance. Lost benefits can include increased costs of barge-shipped goods, flood damages, electricity, water-based recreation, domestic water, and industrial goods dependent on water supply. They may also include the decreased value of property adjacent to projects and the decreased viability of species and the biotic communities they comprise. The record of damage assessments is spotty, however, and national estimates are approximate.	Cole, Richard. 2006. Freshwater Aquatic Nuisance Species Impacts and Management Costs and Benefits at Federal Water Resources Projects. Aquatic Nuisance Species Research Program.
29	Zebra Mussel (Mollusk)	\$100 million	1993	Great Lakes	Costs to approximately 46 power plants	Based on literature review. No information on quantitative approach.		Armour, A.F. et al. 1993. Zebra Mussels: The Industrial Impact. Third International Zebra Mussel Conference.
30	Zebra Mussel (Mollusk)	\$17 million	1995	35 States and 3 Provinces	Costs to facilities for monitoring, training, upgrades, prevention, control, etc.	Survey of 339 facilities to determine annual expenditures on zebra-mussel related impacts.	Facilities include: non-navigational water transport canals, aquarium theme parks, sewage treatment plants, golf courses, marinas, recreational areas, institutions, impoundments, hatcheries, navigational locks, shipping, scenic riverways, agencies, industries, dinking water and electrical plants.	O'Neill, Charles. 1997. Economic Impact of Zebra Mussels - Research Results of the 1995 National Zebra Mussel Information Clearinghouse Study. Great Lakes Research Review. Vol. 3, No. 1.
31	Zebra Mussel (Mollusk)	\$8.8 million	1994	Great Lakes	Research expenditures	Based on survey results.		Hushak, Leroy et al. 1997. Costs of Alternative Zebra Mussel Control Strategies: The Case of Great Lakes Surface Water Users. Ohio



#	AIS	Annual Impact	Year of Cost	Location	Impacts Quantified	Study Approach	Notes	Reference
								Sea Grant College Program.
32	Zebra Mussel (Mollusk)	\$30 million	1992-1994	Great Lakes	Monitoring and control costs	Based on survey results.	Zebra mussel treatment types: monitoring, retrofitting, physical removal, chemical treatment.	Park, Jaemin et al. 1999. Zebra Mussel Control Costs in Surface Water Using Facilities. Ohio Sea Grant College Program.



[www.hdrinc.com](http://www.hdrinc.com)

## MISSION

To be a superior professional firm known for vision, value, and service to our clients, our communities and our employees.

## TECHNICAL APPENDIX - ECONOMICS

### A. INTRODUCTION

This Appendix provides a summary of the economic analysis of the physical separation of the Great Lakes and Mississippi River Basins at the Chicago Area Waterway System. This part documents the economic methodology including structure & logic diagrams, inputs used in the models, sensitivity analysis, as well as background information, general comments, and conclusions.

### B. METHODOLOGICAL FRAMEWORK

The role of the current economic analysis is to guide the discussion of the impacts that separation will have on various segments of the economy and to provide a monetary estimate of those impacts, where possible. At this stage of the analysis, some legitimate impacts are not quantifiable in monetary terms due to the lack of supporting information. These impacts, while not quantifiable, can be important.

A sustainable return on investment (SROI) process for assessing the economics (for example, cost and benefit analysis, or CBA) of the alternatives for separation was used to quantify, in monetary terms, as many of the costs and benefits of separation as possible. *Benefits* are broadly defined. They represent the extent to which people are made better off, as measured by their own willingness to pay to prevent AIS transfer.

Central to CBA is the idea that people are best able to judge what is good for them and what improves their well-being. CBA also adopts the view that a net increase in well-being (as measured by the summation of individual welfare changes) is a good thing, even if some groups within society are made worse off. A project or proposal would be rated positively if the benefits to some are large enough to compensate the losses of others. Finally, CBA is typically a forward-looking exercise that seeks to anticipate the welfare impacts of a project or proposal over its entire lifecycle. Future welfare changes are weighted against today's changes through discounting, which is meant to reflect society's general preference for the present as well as broader inter-generational concerns.

The specific methodology developed for this study incorporates the above CBA principles. However, it also recognizes the limitations of the available data and detailed modeling for this study. Therefore, impacts are identified, but not all are quantifiable (especially benefits). In particular, the methodology involves:

- Establishing existing and future conditions under the separation and no-separation alternatives and considering three alternate separation scenarios (alternatives).
- Measuring incremental impacts.

- Measuring impacts in dollar terms whenever possible, expressing benefits and costs in a common unit of measurement, and qualifying the impacts where it is not possible to quantify impacts due to insufficient data or evidence. In some instances, examples or case studies are developed to demonstrate the potential scale of impacts.
- Not providing an estimate of the difference between total costs and total benefits, or net present value, because the largest benefits of the alternatives are not quantifiable using the data available for this study. However, some perspective is provided on the question.
- Relying on the existing sources of data only, including data that was made available by various stakeholders and literature reviews. Primary research such as “willingness to pay” (WTP) surveys, cargo origin-destination surveys, etc., was not a part of the scope of this study.
- Discounting future benefits and costs with the real discount rates that comply with USACE and federal guidelines.
- Conducting risk/sensitivity analysis and scenario analysis to assess the impacts of changes in key estimating assumptions.

## **C. PROJECT OVERVIEW**

The economic assessment compares each alternative to a “baseline conditions” option and identifies the relevant impacts.

### **1. BASELINE CONDITIONS**

The baseline conditions are defined as the “no-build” scenario. The baseline conditions include current and planned infrastructure investments. The baseline conditions include the following key elements by discipline:

- AIS Prevention:
  - There is no separation. Mitigation of AIS transfer is done through the existing electric barriers.
- Transportation:
  - CREATE: programmed and authorized investments under the program to provide critically needed capital improvements to increase the efficiency of the region's rail infrastructure: to reduce train and auto delays throughout the Chicago area by focusing rail traffic on four rail corridors that will be improved to handle passenger and freight traffic more efficiently.
  - Chicago Park District Marina: new marinas with additional slips will be developed lakeside at eight separate locations.
- Flood Management – Tunnel and Reservoir Project (TARP):

- The TARP project will be phased in per the currently established timeline to be completed in 2029. Improved conveyance is also assumed in accordance with TARP.
- Water Quality:
  - There will be disinfection at the North Side, Calumet and Stickney plants.
  - It is quite uncertain as to what WWTP effluent standards will be in the future. While it is believed that the wastewater treatment discharged to the Great Lakes System is anticipated to become more stringent than the current standard, the effluent standards on the Mississippi River are also likely to become more stringent over the study period. Predicting the standards and the timing of those standards is not a trivial undertaking nor is it within the scope of this study. Therefore alternative scenarios have been developed reflecting various regulatory requirements to deal with this uncertainty and provide some perspective on how different standards impact the project cost estimates.

## 2. SEPARATION ALTERNATIVES

The separation alternatives are defined as the “build” scenario. In total there are three different separation alternatives considered:

- **Down River Alternative** with a barrier near the confluence of CSSC and the Cal-Sag Channel.
- **Mid-System Alternative** with four barriers: upstream of Racine Avenue Pump Station, near Lake Calumet, and on the Grand and Little Calumet Rivers.
- **Near Lake Alternative** with five barriers: upstream of the North Side WWTP, at the Chicago River Controlling Works, at the Lake Michigan–Calumet River interface, and on the Grand and Little Calumet Rivers.

## D. GENERAL ASSUMPTIONS

Some of these key considerations are provided below:

- The analysis identifies impacts and measures benefits and costs, where feasible, through a period of analysis beginning at present and including 30 years of operations from barrier completion and including all mitigation. The period of analysis begins in 2011 and ends in 2059. It includes project development and construction years (2011-2028) and 30 years of operations (2029-2059).
- Input prices and monetized benefits and costs are estimated in 2010 dollars with future dollars discounted in compliance with USACE and Federal guidelines. A three percent real discount rate<sup>1</sup> is employed, plus a sensitivity analysis with a seven percent real rate<sup>2</sup>.

---

<sup>1</sup> The discount rate for Federal water resources planning for fiscal year 2011 is 4.125 percent.  
<http://www.federalregister.gov/articles/2010/12/29/2010-32801/change-in-discount-rate-for-water-resources-planning#p-3>

- The economic evaluation does not make any explicit assumption as to how the capital and operation and maintenance (O&M) associated with the infrastructure required for separation will be funded. It captures these project costs and assumes an appropriate opportunity cost for the use of these funds (e.g., through the discount rates noted above), but does not speculate on a specific funding source. Speculating on “user fees” etc. to help fund the infrastructure would influence user behavior and is not normally assumed in economic analysis unless rates are predetermined.
- The economic evaluation assumes that while there would be some modal shift from barge due to separation, it does not assume that separation would result in major industrial re-organization effects that would divert cargoes away from the Chicago area. The transportation investments associated with the alternatives are expected to provide timely transfers of cargo over the separation barrier resulting in cargoes continuing to move to and through the Chicago area.

---

This has been adjusted by the GDP deflator and the result is a real discount rate of about 3 percent.

<sup>2</sup> Office of Management and Budget, Circular No. A-94 Revised.



## E. COST BENEFIT MATRIX

The cost and benefit matrix in Table EA-1 lists and discusses the impacts of the separation alternatives.

**Table EA-1: Cost and Benefit Matrix**

Area	Impact Category	Potential Impact	Description	Stakeholder
<b>General Infrastructure</b>	Infrastructure Investments	Cost	Cost to construct, maintain, and operate the separation barriers (including lifts, ports, etc.) plus all incremental costs associated with infrastructure investments including mitigating transportation, stormwater, flow augmentation, ecological health, and WWTP upgrades relative to the baseline condition.	Public
<b>Reduce Risk of AIS Transfer</b>	AIS Risk Reduction	Benefit	Separation would reduce the risk of future transfers of AIS in the Great Lakes and Mississippi River basins through the CAWS, thereby avoiding the economic costs and ecosystem damage of AIS. This is a multifaceted impact that includes (1) reduction in cost of prevention and eradication (post-separation), (2) use value—reduction in recreational use, (3) commercial value, (4) ecosystem value, and (5) option use.	Public
<b>Transportation</b>	Shipping Costs – Cargo Handling	Cost	For cargo that continues to use the CAWS after separation, additional costs for shippers associated with handling cargo over the separation barrier from barge to barge. Included in these additional costs is the cost to barge operators of less-efficient use of barge resources; separation would result in less-efficient use of barge resources since barges would not be able to cross the separation barrier and operators might need additional barges.	Shippers
<b>Transportation</b>	Shipping Costs – Higher Shipping Rates after Modal Shift	Cost	Diverting some traditional cargoes from barge to other modes after separation would result in increased shipping costs.	Shippers
<b>Transportation</b>	Emissions (after Modal Shift)	Cost	Diverting some traditional cargoes from barge to other modes after separation would result in increased emission levels. Emissions are a mode-specific externality and are based on the net ton-miles diverted from barge to other modes and the change in emissions by mode on a grams-per-ton-mile basis.	Public
<b>Transportation</b>	Accidents (after Modal Shift)	Cost	Diverting some traditional cargoes from barge to other modes would result in additional accident-related costs. Accident costs are a mode-specific externality and are calculated based on net ton-miles diverted and industry data on accident cost per ton-mile.	Public

Area	Impact Category	Potential Impact	Description	Stakeholder
Transportation	Infrastructure Operating and Maintenance Costs (after Modal Shift)	Cost	Diverting some traditional cargoes from barge to other modes would increase O&M costs on other transportation facilities (such as highway and rail).	Public
Transportation	Congestion (after Modal Shift)	Cost	Diverting some traditional cargoes from barge to other modes would increase levels of truck traffic congestion. Traffic congestion is a mode-specific externality and is a function of the capacity of the facility and the total volume of traffic. Only incremental truck congestion is monetized as an externality in this study, since highways are public. Incremental rail congestion is internal to the private rail companies and would be reflected in the rail shipping rates.	Public
Transportation	New Cargo Potential (NCP) – Reduced Shipping Costs	Benefit	The new port development at Calumet or Lake Michigan would facilitate the diversion of some cargo (for example, container) to barge that otherwise would have traveled on overland modes. This would decrease transportation costs associated with non-traditional (historically) container cargoes moving through the CAWS facilitated by the new port at the separation barrier.	Shippers
Transportation	Emissions (NCP)	Benefit	Diverting new cargoes from other modes to barge would decrease emission levels. Change in emission costs is calculated in the same manner as regular cargo.	Public
Transportation	Accidents (NCP)	Benefit	Diverting new cargoes from other modes to barge would decrease accident-related costs. Change in accident costs is calculated in the same manner as for regular cargo.	Public
Transportation	Infrastructure Operating and Maintenance Costs (NCP)	Benefit	Diverting new cargoes from other modes to barge would decrease O&M costs on other transportation facilities (such as highway and rail). Change in operating and maintenance costs is calculated in the same manner as for regular cargo.	Public
Transportation	Congestion (NCP)	Benefit	Diverting new cargoes from other modes to barge would decrease levels of traffic congestion. Change in traffic congestion is calculated in the same manner as for regular cargo.	Public
Transportation	Recreational Boat Barrier Crossing	Cost	For recreational boaters who would use the lifts to cross the separation barrier and have the boat disinfected, there would be additional time costs for each transit (relative to the time to get through the locks).	Recreational Boaters
Transportation	Recreational Boat Time Savings	Benefit	The Mid-System Alternative ensemble would allow the Chicago Lock to remain permanently open. This would reduce the annual time that recreational boaters spend waiting to pass through the locks.	Recreational Boaters

Area	Impact Category	Potential Impact	Description	Stakeholder
Transportation	Marina Relocation	Cost	Post-separation, some boaters might relocate to marinas lakeside since the lifts would accommodate fewer crossings than the locks. In addition, this could result in additional travel time costs and vehicle operating costs since boaters might tow and launch rather than use marinas for mooring.	Recreational Boaters
Transportation	Enhanced Access to Lake	Benefit	Some barrier location options would enhance lake access, thereby providing an opportunity to develop new harbors, marinas, and recreational fishing opportunities.	Public
Transportation	Boat Servicing and Storage	Cost	Separation could impede access for recreational boaters, commercial tours, and water taxis to dry docks for servicing and storage. Additional costs have been assumed for investments for new dry dock facilities.	Recreational Boaters, Water Taxis, and Commercial Tour Operators
Transportation	Additional Commercial Tour Vessels	Cost	The Near Lake Alternative would disrupt service for tour operators who traverse both the river and lake, and they might require additional vessels to maintain the current level of service.	Commercial Tour Operators
Transportation	Additional Public Safety Vessels	Cost	The Mid-System and Near Lake Alternatives would restrict the operation of emergency vessels and would require one additional emergency vessel on each side of the separation barriers for the Chicago police and fire departments. The additional vessels might also result in additional mooring and staffing costs.	Public Agencies
Transportation	Reduced Train Delay	Benefit	Reduction in rail delays associated with lift bridges spanning the Calumet River (pertains to Near Lake Alternative only).	Shippers/Rail Operators
Ecological Health	Water Quality Improvement	Cost / Benefit	Water quality and ecological health could be reduced as a result of barriers. Measures and associated cost estimates have been developed to ensure that water quality is no worse off than under the baseline condition. The Mid-System and Down River Alternatives would improve water quality for those stretches of the CAWS that would have an open connection to Lake Michigan. For some of the scenarios considered, the improved water quality in the CAWS would increase species diversification, recreational use, and aesthetic value.	Public
Flood Management	Flood Management	Cost	Without investments, flooding and the number of CSOs would increase as a result of the barriers. Strategies and associated cost estimates have been developed to ensure that flood management is no worse off than under the baseline condition. These investments could provide local flood-reduction benefits.	Public, Property Owners
General Infrastructure	Infrastructure Cost Avoidance	Benefit	Cost savings from not having to maintain and operate the displaced locks. Cost savings from not having to deploy alternate AIS technologies.	USACE
Other	Lockport Powerhouse	Cost	Power generation at the Lockport Powerhouse would be reduced.	Public

## **F. DEMAND ASSUMPTIONS (BASELINE)**

For the purposes of estimating the costs and benefits of separation, the baseline conditions were developed for comparative purposes. Baseline conditions for the CAWS economic model take into account current and future bulk cargo demand, recreational boating demand, and container-on-barge demand (COB).

To establish the baseline conditions, data was collected from readily available and published sources. Much of the data gathered to establish the baseline conditions for bulk cargo, recreational boating, and COB demand comes from various USACE publications, which have CAWS-specific movement data.

### **BULK CARGO MOVEMENTS**

The CAWS system provides full connectivity between Chicago, the Great Lakes, and the Mississippi River. Waterborne freight in the Chicago region consists primarily of relatively heavy, low value bulk goods. In 2007, nearly 73 million tons of waterborne freight moved in the Chicago region through the CAWS.

Coal is the largest commodity moved on the CAWS, followed by metallic ores and non-metallic minerals. Mile Point data was obtained from USACE to describe the types of commodities being transported, the vessel type, the tonnage, and the direction at various mile markers along the CAWS system. Data indicate that the majority of barge traffic is shipping to destinations on the south CAWS or out to destinations on the Great Lakes, such as Indiana ports. Limited quantities, primarily sand and gravel, are shipped on the Chicago River. Most coal that is shipped on the CSSC is headed to the Crawford and Fisk plants. Volumes are highest on the Calumet River, passed the O'Brien Lock, and most of the cargo transported is coal and petroleum coke.

Cargo movement on the CAWS is driven primarily by industries that require bulk goods such as sand, gravel, coal, lignite, petroleum coke, and coal coke. With the exception of the Calumet River, which has the depth to accommodate self-propelled laker vessels, these bulk goods are transported by barge. Baseline cargo tonnage and annual trips through the CAWS are based on USACE Mile Point (MP) data, for barrier locations 9/16, 4/5, 20, and 15. USACE Navigation Data Centre (NDC) was used for barrier location 3 at the Chicago Lock. Figure EA-1 and Figure EA-2 shows the average MP cargo movements from 2005-2009.

The total baseline tonnages used in the economic model are based on an average of the last five years of available data. For the USACE MP data, this is 2005-2009, while for the USACE NDC data this is 2006-2010. The baseline annual cargo tonnage values used in the economic model are shown in Table EA-2.

Figure EA-1. Average Annual Cargo Movements Based on USACE Mile Point Data

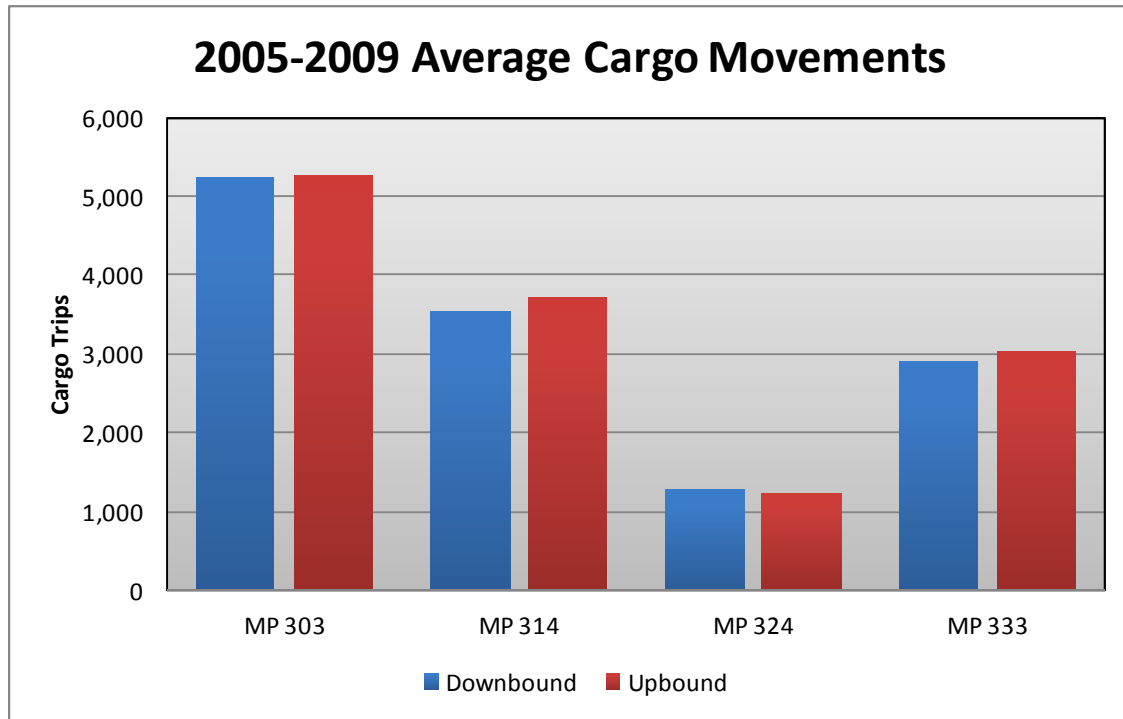
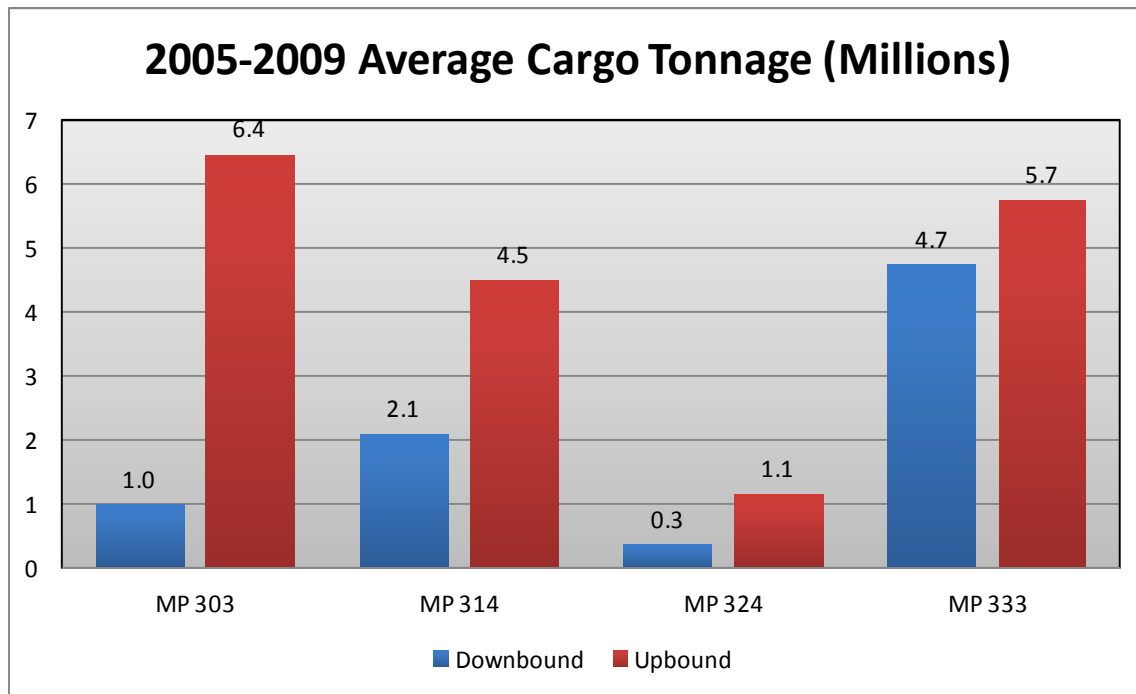

Figure EA-2. Average Annual Cargo Tonnage Based on USACE Mile Point Data

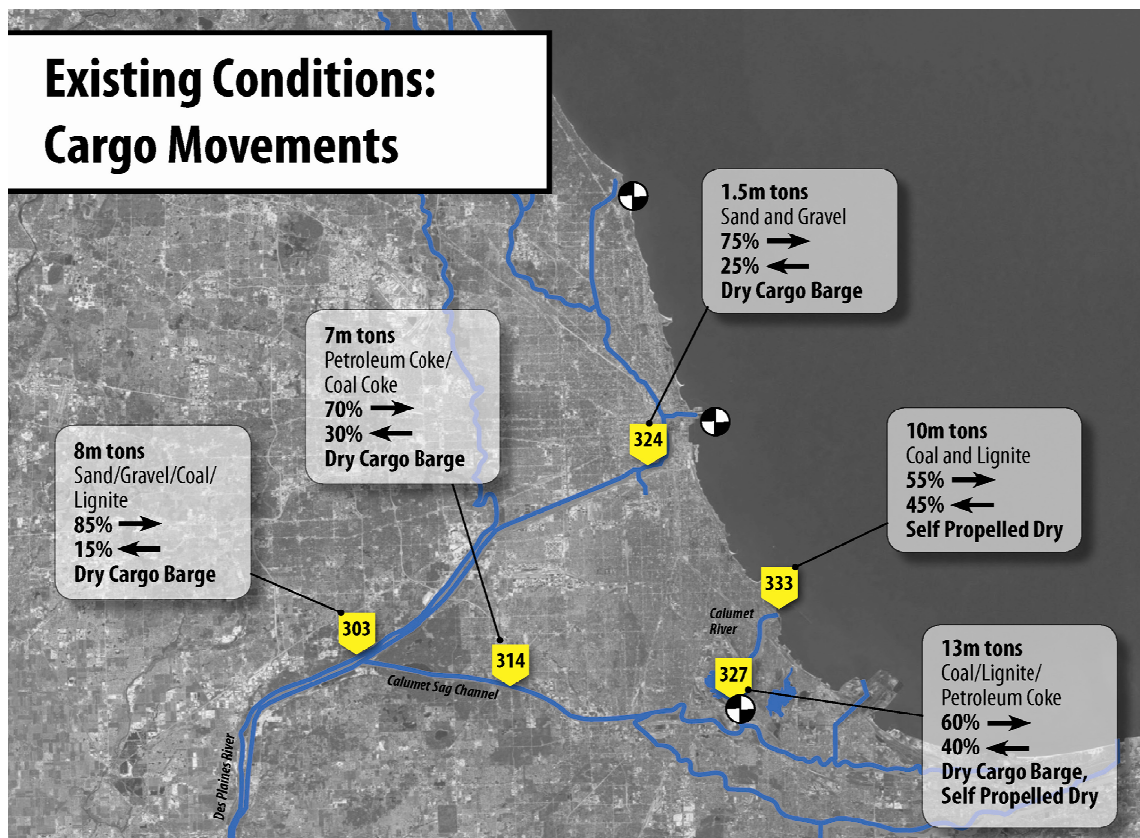

**Table EA-2. Average Annual Bulk Cargo Tonnage by Mile Point**

Location	Tons (Millions)	Data Source
MP 333	10.4	USACE NDC
MP 324	1.5	USACE NDC
MP 314	6.6	USACE NDC
MO 303	7.4	USACE NDC

Figure EA-3 shows the MP locations as well as major commodities transported at MP 303, 314, and 324. These MP locations represent data for physical barrier locations. These sections of the CAWS do not have the depth to handle the large self propelled laker vessels. Data for MP 333 at the mouth of the Calumet River represents mostly self propelled laker vessels coming from the Great Lakes and delivering bulk cargo to industry and transfer points on the Calumet River.

**Figure EA-3. CAWS Mile Point Data Location and Major Commodities Transported**



Baseline cargo forecasts are from a 2007 USACE Navigation and Ecosystem Sustainability Program economic evaluation study forecast of Illinois Waterway non-grain commodities for the timeframe 2005-2055.<sup>3</sup> The forecast was performed for non-grain commodities on the Illinois River from the confluence with the Mississippi River at MP 0 to the O'Brien Lock in Chicago at MP 327, including the Cal-Sag Channel, the CSSC, and the South Branch. Despite the forecast being a few years old, it was determined that longer-term regional growth rates would still be applicable.

**Figure EA-4. Illinois Waterway Non-grain Commodity Long Range Commodity Growth Rate Forecast**

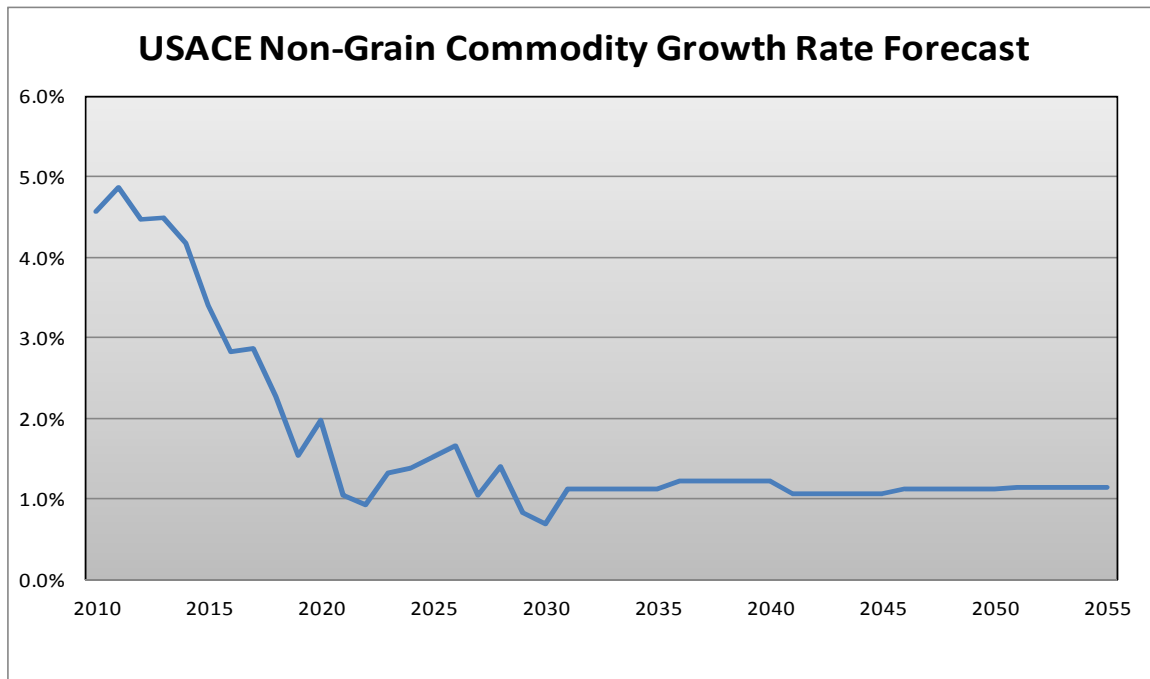

<sup>3</sup> USACE. NESP Economic Evaluation: Waterway Traffic Forecast for Non-Grain Commodities. The Louis Berger Group. November 2007.



### RECREATIONAL BOAT MOVEMENTS

The majority of the recreational traffic occurs between May and October. In 2010, over 23,000 recreational boats passed through the Chicago Lock, and over 12,000 through the O’Brien Lock.<sup>4</sup> Human-powered craft, canoes, kayaks, and sculls, almost exclusively remain within the river system. Approximately 2,550 boats (45% of boats moored in Lake Michigan Harbors) pass through the locks every spring and summer to gain access to boat slips and other mooring facilities on Lake Michigan. The remaining boats moored in Lake Michigan Harbors use marinas or boat ramps on the Lake Michigan shore in Illinois, Indiana or Wisconsin.

Baseline CAWS recreational vessels movement data was obtained from the latest USACE GLMRIS non-cargo baseline assessment report.<sup>5</sup> The movements were assessed as the total number of vessels passing through the three CAWS locks. The values used as inputs in the economic model are an average of the last five years of data (2006-2010) and are shown in Figure EA-5.

**Figure EA-5. 2006-2010 Baseline CAWS Average Recreational Lockage Values**

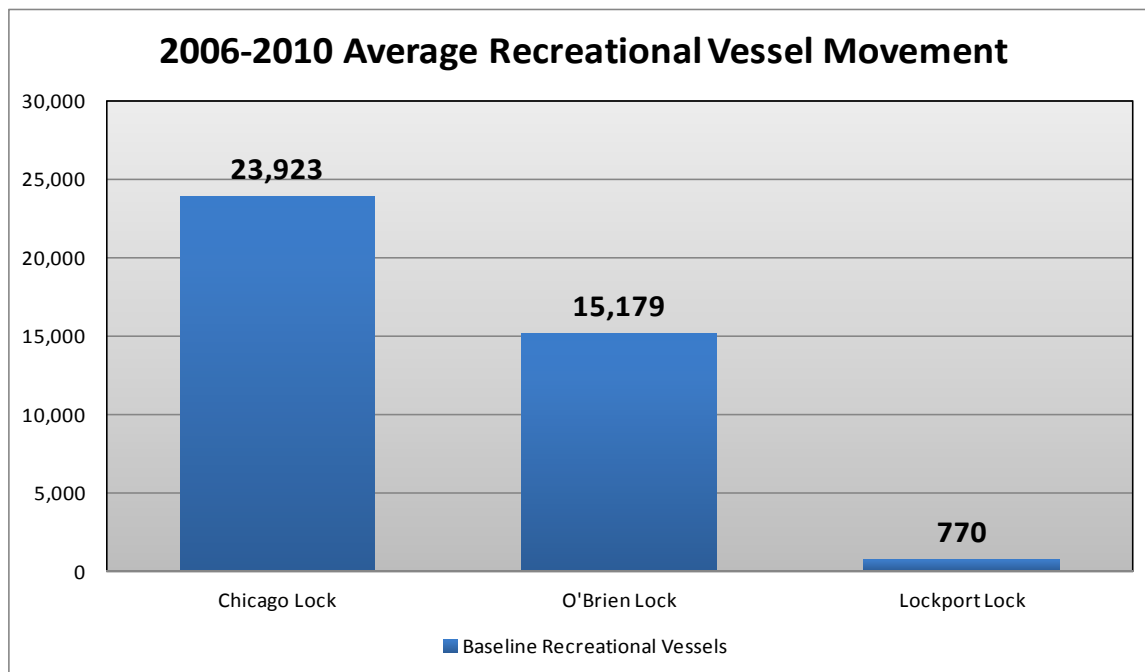

The GLMRIS figures show historical recreational boating traffic is greatest through the Chicago Controlling Works Lock, with an average annual lockage value of 23,923 vessels. These higher numbers are likely driven by the many amenities, tourist attractions and marinas on the Chicago River, as well as access to Lake Michigan from the Chicago River for boaters accessing

<sup>4</sup> GLMRIS. Baseline Assessment of Non-Cargo CAWS Traffic. USACE. September 2011.

<sup>5</sup> GLMRIS. Baseline Assessment of Non-Cargo CAWS Traffic. USACE. September 2011.

the lake for day trips. The Chicago Lock is also a draw to boaters wishing to experience the thrill of passing through the locks. Since there are many marina slips located lakeside of the Chicago River, several of these recreational boat movements are boaters that use these locks on a seasonal basis, to access off-lake dry docks/winter storage.

The O'Brien Lock has less recreational movement than the Chicago lock. This is likely due to fewer amenities and marinas on the Cal-Sag Channel in comparison to the Chicago River. Similar to the Chicago Lock, several of the recreational vessel movements are seasonal to access winter dry docks/winter storage. There is very little movement through the Lockport Lock relative to the other two locks. It is likely that these are either seasonal movements to access dry docks/winter storage or long-haul trips, for example from the Gulf Coast to the Chicago Region.

For the purposes of the baseline economic model, an annual recreational boat forecast growth rate of zero was used. This forecast growth rate was based on the declining trend in recreational movements on the CAWS. This trend can be seen in Figure EA-6, based on historical GLMRIS lockage data. Decline in the last three years 2008-2010, may be due to overall economic conditions. It was assumed that recreational vessel traffic would operate at the average value of the last five years and would remain stable at that level.

**Figure EA-6. Historical Annual Recreational Boat Movements on the CAWS**

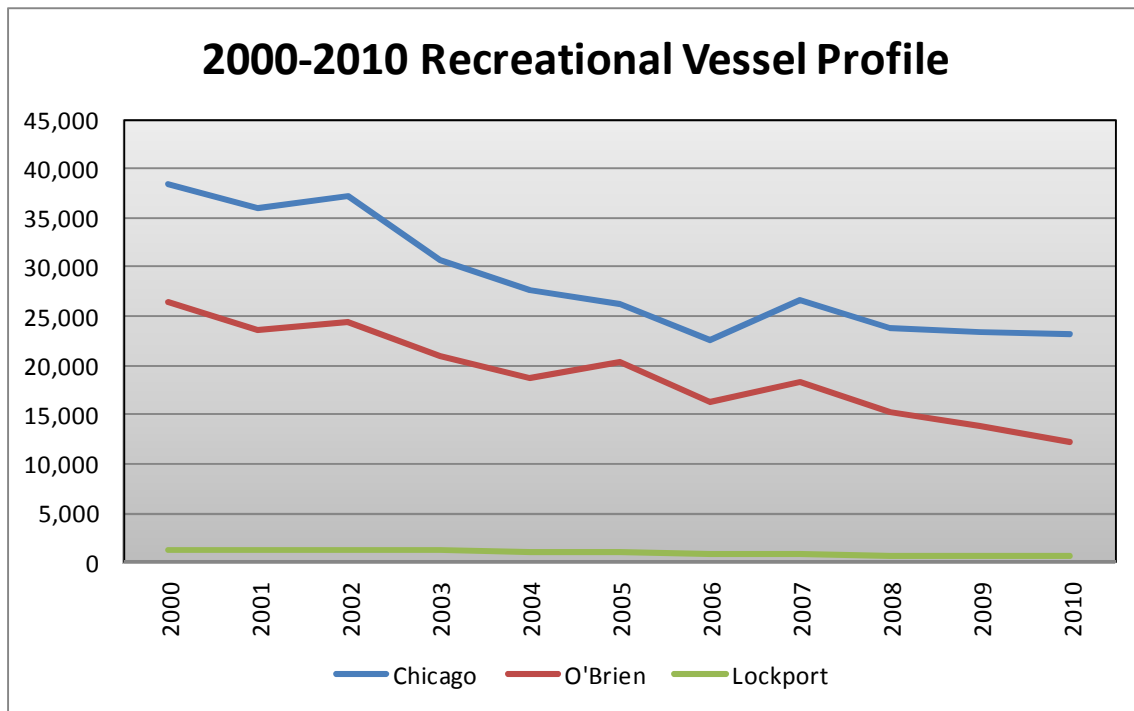

## **CONTAINER ON BARGE**

Baseline COB forecasts are from the USACE NESP economic evaluation study forecast of Illinois Waterway non-grain commodities.<sup>6</sup> The USACE study summarizes and forecasts a 50 year outlook for COB market on the Upper Mississippi and Illinois Waterways. At the time of the study, there was no COB on the Upper Mississippi River and only irregular COB on the Illinois River.

The Panama Canal will be expanded by 2015, and this expansion assumption is included in the baseline condition. With this expansion comes the opportunity for additional container cargo to be imported and exported from the U.S. The COB market is not currently served by the CAWS; however, the opportunity for this new market sector is possible.

The USACE NESP study estimates that under current conditions, baseline COB traffic through Chicago would reach roughly 6,000 TEU by 2015 due to a surge in international demand and expanded capacity at the Panama Canal. The study forecasts that under current baseline conditions, COB traffic through Chicago would be roughly 10,000 TEU by 2025 and 20,000 TEU by 2050. For the purposes of the economic model timeframe 2010-2059, the USACE COB forecast estimates were used to interpolate all COB forecast year estimates. The baseline COB forecasts and growth rates can be seen in Figure EA-7.

---

<sup>6</sup> USACE. NESP Economic Evaluation: Waterway Traffic Forecast for Non-Grain Commodities. The Louis Berger Group. November 2007.

Figure EA-7. 2010-2059 Baseline COB Forecast and Growth Rate

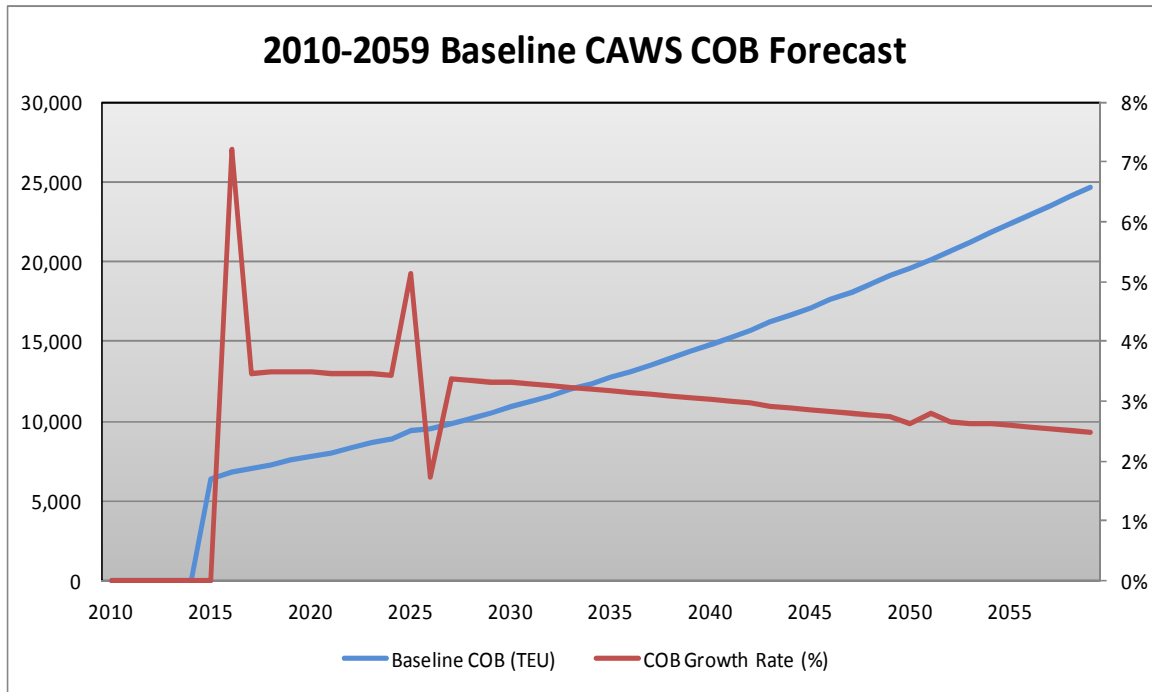

## G. ECONOMIC BENEFITS, DATA, ASSUMPTIONS AND RESULTS

Each of the separation alternatives would provide economic benefits, with the largest being the reduced risk of AIS transfer via the CAWS. The economic analysis identified a number of distinct benefits. Some of these benefits, while significant, are not directly quantifiable based on available data. The benefits are discussed below.

### REDUCED RISK OF AIS TRANSFER

Each of the separation alternatives would reduce the risk of future transfers of AIS in the Great Lakes and Mississippi River basins through the CAWS, thereby avoiding economic costs and ecosystem damage. Separation would reduce the risk of AIS transfer in two directions: from the Mississippi River to the Great Lakes and from the Great Lakes to the Mississippi River. The potential economic losses associated with AIS are multifaceted and include the following (Emerton and Howard, 2008):

- **Management Costs:**
  - Cost of prevention—the costs associated with working to reduce risk of AIS transfer.
  - Cost of control and eradication (after transfer).
- **Direct Values:** Reduction in recreational use; reduction in commercial value (for example, fish).

- **Indirect Values:** The ecological functions that maintain and protect natural and human systems and provide essential life support (for example, watershed protection).
- **Option Values:** The premium placed on maintaining ecosystems, landscapes, species, and genetic resources for future possible uses that have economic value.
- **Existence Values:** The value of ecosystem attributes and their component parts, regardless of current or future possibilities to use them. Ecosystems provide sites and landscapes, and contain a range of plant and animal species, that people value simply because they exist—not just because of the products and services they generate.

Monetizing the economic benefits associated with reducing the risk of AIS transfer requires several data elements for which data do not currently exist. To derive a specific estimate of the benefits of AIS risk reduction would require, at a minimum, forecasts by year of the following elements without separation:

- Number of species that would transfer between basins over time.
- The likelihood that species that do transfer would become established.
- The likelihood of species becoming invasive once established.
- The economic damage if the species is invasive.

While data do not exist at this time to allow the derivation of a reliable estimate of the potential benefits of separation related to AIS risk reduction, there is information available that provides some perspective.

**There are a number of high-risk species in both basins that could transfer between basins and become invasive.**

In its *Non-native Species of Concern and Dispersal Risk for the Great Lakes and Mississippi River Interbasin Study*, the USACE identified 254 alien aquatic species that are present in one or both basins or that are threatening to infiltrate a basin. From this initial list, the USACE assessed a total of 119 alien and native species for their potential adverse effects on ecosystems and the methods they use for dispersal. In turn, 39 species were identified as having a high level of risk according to two criteria: they have a high level of risk for transferring from one basin to another, and they have a high risk of moderately to severely affecting the invaded ecosystem type if they do disperse and colonize the ecosystem.

**The economic impact of individual or groups of AIS has been estimated for some species historically.**

Existing literature provides some estimates of the economic damage from AIS. The available economic literature on AIS in the Great Lakes and Mississippi River basins was reviewed. From this review and discussions with experts in this field, it is apparent that this body of literature is

still relatively small and the study domain is in its infancy. Very few empirical studies estimate the economic costs of AIS. The studies use a variety of methods to create the available estimates, resulting in a large variation in cost estimates from several hundred thousand to several billion dollars. Within the literature, it is broadly recognized that the economic impact of AIS is usually understated. For example, studies often ignore the value that society places on maintaining ecosystems for potential future uses.

**The harm caused by a single AIS can be substantial.**

Measuring the economic costs of AIS involves determining rates of biological propagation as well as assessing the risks of AIS. While few AIS have a high risk of becoming invasive, and even fewer of those would cause significant harm, the harm caused by these few can be substantial. Estimating the benefits associated with controlling the spread of AIS is difficult (Lovell and Stone, 2005).

While this area of study is in its infancy and existing economic impact estimates are based on varying approaches and degrees of rigor, the available studies can still provide some useful context for exploring the potential benefits of reducing the risk of AIS transfer.

**CASE STUDY ANALYSES**

To help put the potential benefits into context, a series of case studies have been constructed using a reasonable range of assumptions. The case studies are based on existing estimates of the economic damage caused by some individual species or group of species. Alternate studies could have been used with smaller or larger annual estimates of damage. These examples help demonstrate that preventing the transfer of even one AIS *could* have substantial benefits. The case studies or experiments are described using only the following three variables, which still result in many different permutations.

- Potential annual benefit from AIS prevention, or damage from AIS if transfer does occur:
  - \$12 million to \$18 million per year (based on sea lamprey) (Corn et al., 2002).<sup>7</sup>
  - \$150 million per year (based on all ballast-mediated invasives in the Great Lakes, excluding producer impacts) (Lodge, 2008).
  - \$300 million to \$500 million per year (based on zebra mussel) (Cole, 2006).
- Start date of benefits (2030, 2040, or 2050):
  - The year in which AIS prevention benefits start accruing. The alternatives would be fully completed by 2029, but benefits would not necessarily start accruing immediately, so different start dates are used.

---

<sup>7</sup> This is consistent with feedback from the Great Lakes Fishery Commission, which quotes costs for controlling sea lamprey to be about \$20 million per year.

- End date of benefits (2059 or perpetuity):
  - Once damage is done by an AIS, the impacts are generally ongoing and forever. In recognition of this, the time period for which benefits are measured is varied to reflect (1) the study period only or (2) to perpetuity.

These case studies are not intended to provide definite evidence about the benefits of separation. Rather, they illustrate and provide perspective on the magnitude of possible damage from AIS if transfer between basins is not addressed.

The case studies illustrate that stopping even a single AIS from transferring between basins could avoid billions of dollars in economic loss. Table EA-3 provides estimates of the potential benefits, or potential costs avoided, from preventing a single AIS transfer, measured as present value in billions of 2010 dollars, that were derived from these case studies using a discount rate of 3% real.

**Table EA-3. Potential Costs Avoided from Preventing a Single AIS Transfer, Present Value in Billions of 2010 Dollars**

<b>Annual Costs Avoided</b>	<b>Start: 2030 End: 2059</b>	<b>Start: 2040 End: 2059</b>	<b>Start: 2050 End: 2059</b>	<b>Start: 2030 End: Perpetuity</b>	<b>Start: 2040 End: Perpetuity</b>	<b>Start: 2050 End: Perpetuity</b>
<b>\$12 million</b>	\$0.14	\$0.08	\$0.03	\$0.23	\$0.17	\$0.13
<b>\$18 million</b>	\$0.21	\$0.12	\$0.05	\$0.34	\$0.26	\$0.19
<b>\$150 million</b>	\$1.73	\$0.98	\$0.42	\$2.85	\$2.12	\$1.58
<b>\$300 million</b>	\$3.45	\$1.95	\$0.83	\$5.70	\$4.24	\$3.16
<b>\$500 million</b>	\$5.76	\$3.25	\$1.39	\$9.51	\$7.07	\$5.26

While there is no way to definitively project the damage an AIS could do in the absence of separation, this analysis shows that the long-term benefits of preventing even a single AIS transfer can be significant.

#### **TRANSPORTATION (NEW CARGO POTENTIAL)**

The transportation investments and the development of the new port facilities with the Near Lake and Mid-System Alternatives could facilitate the movement of new cargoes through the CAWS in the form of shipping containers on barges (COB). Through the study process, there has been some debate about whether these new cargoes would actually cause new investments in



port facilities or whether these movements would have occurred anyway in the baseline condition. Regardless, the potential benefits of increased COB movements through the CAWS based on alternative demand projections in the USACE NETS cargo forecast report mentioned earlier have been estimated (USACE-NESP, 2007).

The USACE report forecasts a Radical Change COB scenario based on future use of specialized COB systems, which are currently used in other countries. The specialized COB systems would use deck barges instead of standard open hoppers, dedicated tows instead of general tows, and specialized terminals with container-lifting equipment and ship-to-barge capability.

The specialized terminals with container-lifting equipment and ship-to-barge capability are similar to what is being proposed at the Near Lake and Mid-System Alternative terminals. The specialized system at these terminals would allow greater COB traffic than what has been forecasted in the baseline condition. This Radical Change COB forecast has been used for the purposes of the economic model.

The baseline condition and Alternative Case COB forecasts are shown in Figure EA-8. It is assumed that these new COB movements would otherwise have been handled within the region by rail transportation. The forecasts spike upward in 2015 with the opening of the expanded Panama Canal.

**Figure EA-8. 2010-2059 Mid-System and Near Lake Alternative COB Forecast**

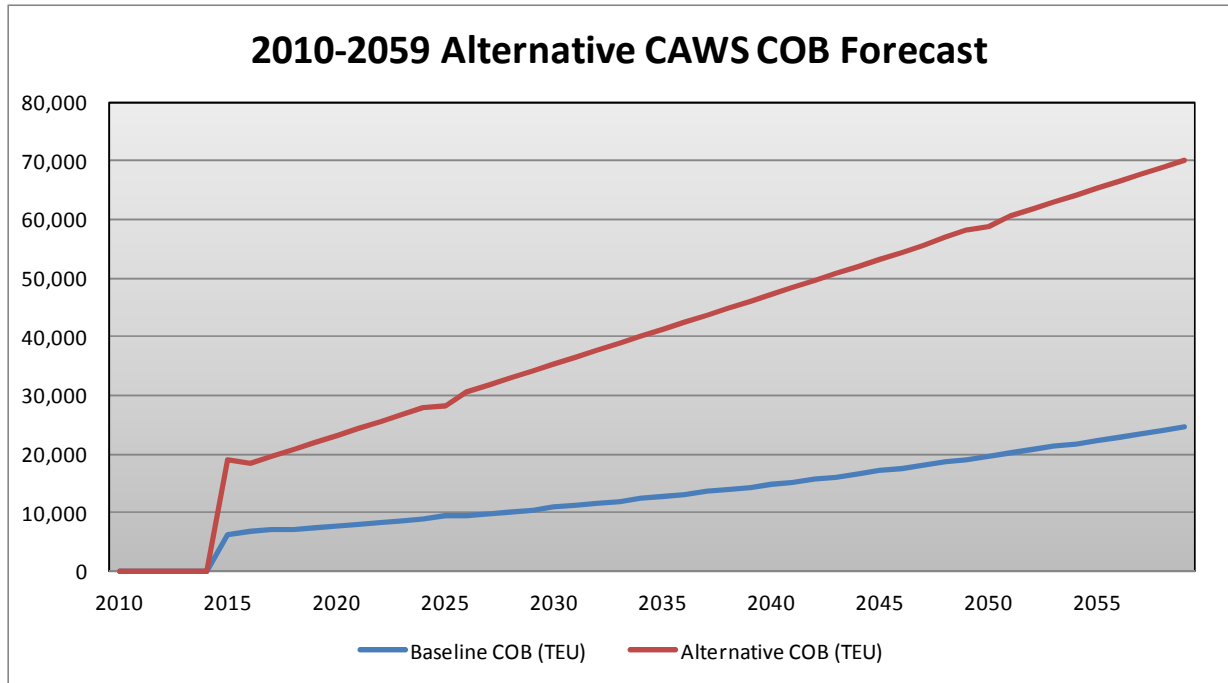

Similar to the modal shift discussion above, several impacts would occur with the cargoes diverted from other modes:

- Decreased shipping/transportation costs via COB;
- Decreased emission levels;
- Decreased accidents; and,
- Decreased operating and maintenance.

The Structure and Logic model, key assumptions and monetized impacts of these results over the study lifecycle are provided below.

**Figure EA-9. S&L for New Cargo Potential Reduced Shipping Costs**

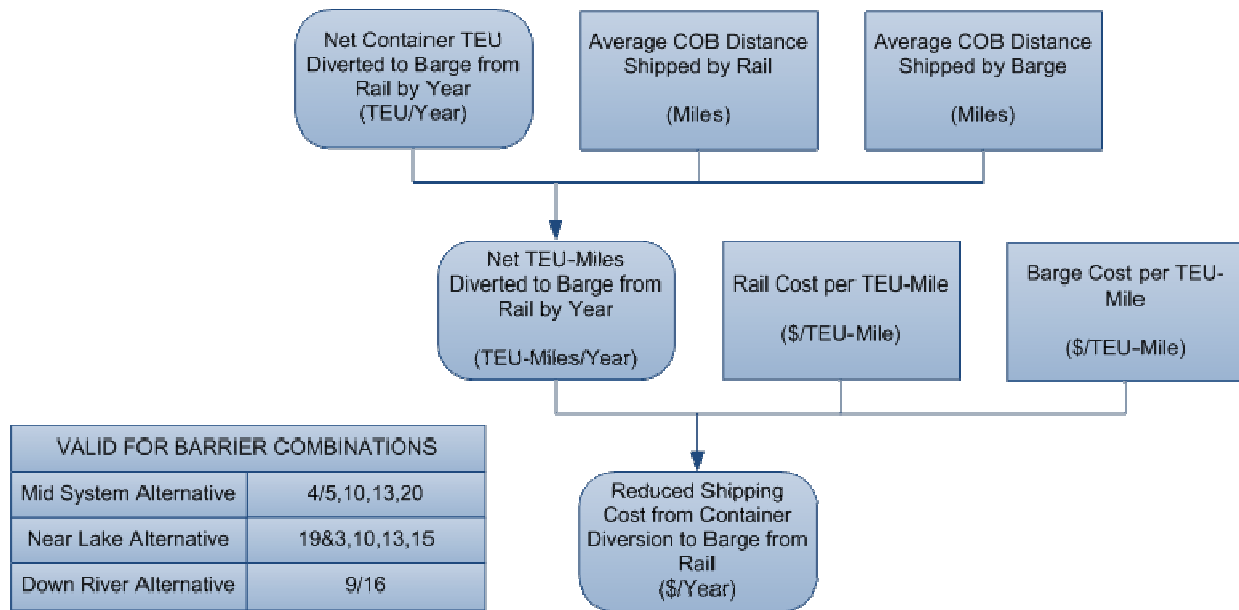

The magnitude of the benefits associated with new COB traffic potential through the CAWS is driven by two major factors: the level of incremental traffic and the rate of savings associated with shipping cargo via barge as opposed to rail. For this analysis, it was assumed that the percentage rate savings for barge over other transportation modes also applies to COB.

The key inputs for deriving the COB impacts are contained in Table EA-4. Additional variables used in the calculation of COB impacts are taken from bulk cargo movement assumptions

**Table EA-4. Input Assumptions for New Cargo Potential**

Variable Name	Unit	Value	Source
Rail Cost per TEU Mile	\$/TEU-Mile	1.25	HDR Estimate. TEU = Twenty-foot Equivalent Unit.
Barge Cost per TEU Mile	\$/TEU-Mile	0.53	HDR Estimate. TEU = Twenty-foot Equivalent Unit.
Average COB Distance Shipped by Rail	Miles	1091	UP 6000 Mileage Tariff mileage calculator.
Average COB Distance Shipped by Barge	Miles	1410	McDonough Marine distance calculator. Based on distance travelled from Chicago to New Orleans.

The potential benefit of new COB traffic moving through the CAWS is estimated to be about \$416 million over the study lifecycle for the Mid-System Alternative. The primary economic

benefit is the savings in transportation costs (for example, shipping rate) of almost \$300 million for the Mid-System Alternative.

**Table EA-5. New COB Cargo-Related Benefits, Mid-System and Down River Alternatives, Millions of 2010 Dollars**

Benefit	First-Year Impact (2023)	Present Value of Impact (\$ millions)	
		3% Discount Rate	7% Discount Rate
Shipping rate (from modal shift)	\$12	\$296	\$100
Emissions	\$1	\$29	\$10
Accidents	\$2	\$55	\$19
O&M	\$1	\$36	\$12
<b>Total</b>	<b>\$16</b>	<b>\$416</b>	<b>\$141</b>

**Table EA-6. New COB Cargo-Related Benefits, Near Lake Alternative, Millions of 2010 Dollars**

Benefit	First-Year Impact (2027)	Present Value of Impact (\$ millions)	
		3% Discount Rate	7% Discount Rate
Shipping rate (from modal shift)	\$14	\$265	\$82
Emissions	\$1	\$26	\$8
Accidents	\$3	\$49	\$15
O&M	\$2	\$32	\$9
<b>Total</b>	<b>\$16</b>	<b>\$372</b>	<b>\$115</b>

**REDUCED TRAIN AND AUTOMOBILE DELAY**

The Near Lake Alternative barrier ensemble would eliminate rail delays associated with lift bridges spanning the Calumet River that are raised when vessels from Lake Michigan traverse the river. Also, the Near Lake Alternative would seasonally eliminate automobile, pedestrian, and bicycle delays associated with the lift bridges spanning the Chicago River. These benefits are recognized but not monetized.

**WATER QUALITY**

The Mid-System and Down River Alternatives would improve water quality for those stretches of the CAWS with an open connection to Lake Michigan. The improved water quality, for some of the scenarios considered, in the CAWS would increase species diversification, recreational use, aesthetic value, and potentially property values.

It is broadly recognized in the economic literature that improved water quality provides significant economic benefits and that people have demonstrated a strong willingness to pay for such improvements. Numerous studies have demonstrated the economic benefits of water quality improvements, and the most frequently used methodology in these studies is “willingness to pay” using contingent valuation techniques. U.S. EPA used this technique to

determine the economic benefits of the Clean Water Act (CWA) in 2000, which were about \$11 billion per year.

The measure of value employed in this study is households' maximum willingness to pay (WTP) for the estimated improvements in water quality under the CWA. WTP is usually regarded as the best observable measure of the value that people place on the benefits of environmental quality improvements, and its use is consistent with governmental directives for conducting benefits analyses. Use of WTP implies a human-oriented perspective on the benefits of water quality improvements. For decision makers who believe that a more expanded view of the value of ecosystems should be the basis of public policy, WTP would, presumably, represent a lower bound on the value of the water quality improvements under the CWA (U.S. EPA, 2000).

Other studies have also provided useful context of willingness to pay for water quality improvements in the Chicago region.

- Boyle (2008): The value of disinfection at all three WWTPs in the CAWS was found to be about \$47 per household per year, or about \$1 billion over 20 years.
- Croke et al. (1986): The willingness to pay in Cook County for improving water for recreational use was found to range from \$33 to \$46 per year per household.
- The Brookings Institute (2007): The economic benefits of the federal-state Great Lakes Regional Collaboration (GLRC) Strategy were estimated to be about \$50 billion, or about two times the cost.

The economic valuation of water quality improvements is usually measured in terms of a "water quality ladder," which represents the degree to which people perceive that water is boatable, fishable, or swimmable. These steps in the ladder (for example, fishable) are tied to several specific water quality indicators such as levels of dissolved oxygen, fecal coliforms, etc., to derive an estimate of the economic benefits of improved water quality. While it is recognized that the Mid-System and Down River Alternatives would have water quality benefits with an economic value, specific measurements of water quality indicators are not available in the baseline condition and for each alternative. Therefore, an estimate of the water quality benefits for these two alternatives cannot be provided with the data and modeling available for this study.

## **FLOOD MANAGEMENT**

Each alternative includes significant investments related to flood management including sewer separation, floodplain storage, tunnels, conveyance, and green infrastructure for stormwater. While it is expected that these investments could provide some local flooding benefits relative to the baseline condition, the level of modeling analysis did not provide specific measures to

allow the team to quantify the flood-control benefits. The potential benefit for each alternative is recognized but is not quantified or monetized.

The alternatives also provide significant investments in green infrastructure that provide benefits over and above their primary objective of flood management. While it is recognized that investments in green infrastructure provide benefits related to reduced energy consumption and emissions, biological diversity, etc., these benefits have not been quantified.

### **COST AVOIDANCE**

There would be some cost avoidance benefits from each of the alternatives. Cost avoidance refers to costs that are expected to be incurred in the baseline condition that would not be incurred with each of the separation alternatives. The two sources of cost avoidance are:

- **Operation of the T.J. O’Brien and Chicago Locks:** After separation, neither lock would be operated by USACE, with a cost avoidance of about \$3 million annually.
- **AIS-Related Research and Prevention:** After separation, activities related to monitoring, research, and preventing the transfer of AIS between through the CAWS would no longer be required, with a cost avoidance of about \$5 million annually. It is noteworthy, however, that if future expenditures for initiatives like the Asian Carp Management are maintained in the long term at the level of appropriations in the last two fiscal years, the cost avoidance estimates could increase tenfold. The level of these future appropriations is not known at this time.

The impact of cost avoidance has been monetized to provide an order of magnitude estimate of the potential impact. The assumptions used in the calculation of cost avoidance impacts are shown below in Table EA-7.

**Table EA-7. Cost Avoidance Input Assumptions**

<b>Variable Name</b>	<b>Unit</b>	<b>Value</b>	<b>Source</b>
Annual Lock O&M Costs	\$/Year	\$3,000,000	HDR Estimate. \$1.5 M per lock for the Chicago and O'Brien Locks. Lockport Lock will remain operational.
AIS Control Cost	\$/Year	\$5,000,000	HDR Estimate. \$5 M per year in AIS cost avoidance due to research/other control measures.

**Table EA-8. Cost-Avoidance Impacts, Mid-System and Down River Alternatives, Millions of 2010 Dollars**

Benefit	First-Year Impact (2023)	Present Value of Impact (\$M)	
		3% Discount Rate	7% Discount Rate
Annual Lock O&M Costs	\$3.0	\$46.6	\$17.4
AIS-Related Research/Prevention Costs	\$5.0	\$77.7	\$29.1
<b>Total</b>	<b>\$8.0</b>	<b>\$124.3</b>	<b>\$46.5</b>

**Table EA-9. Cost-Avoidance Impacts, Near Lake Alternative, Millions of 2010 Dollars**

Benefit	First-Year Impact (2027)	Present Value of Impact (\$M)	
		3% Discount Rate	7% Discount Rate
Annual Lock O&M Costs	\$3.0	\$38.8	\$13.0
AIS-Related Research/Prevention Costs	\$5.0	\$64.7	\$21.6
<b>Total</b>	<b>\$8.0</b>	<b>\$103.5</b>	<b>\$34.6</b>

## H. PROJECT CAPITAL AND O&M COSTS

This part of the report summarizes the capital and operation and maintenance (O&M) costs associated with separation in the CAWS. Costs are summarized for each separation alternative. For each alternative, capital and O&M costs are summarized into three cost categories—flood management, water quality, and transportation—but each of these categories has layers of detail for various investment components.

Determining the future investments required for WWTPs is extremely difficult because there is significant uncertainty about future effluent standards. It is anticipated that the effluent standards for both Lake Michigan and the Mississippi River are likely to become more stringent over the study period, but the exact degree is unknown. The economic analysis is based on consideration of baseline condition scenarios and improvements that are required due to placing separation barriers.

A major cost factor is determining the baseline condition cost for upgraded treatment at the regional WWTPs. The baseline condition for WWTP effluent is to continue to assume that it discharges into the Mississippi River basin. It is anticipated that, within the study period for the separation project, nutrients will need to be reduced by some level. Two different levels of treatment for removing nutrients from effluent discharged to the CAWS were assumed for the baseline condition: a moderate level of treatment and a more stringent level of treatment.

These two baseline condition assumptions were then used to calculate the incremental costs of additional treatment required when discharging effluent to Lake Michigan due to placing separation barriers. Moderate and stringent levels of effluent treatment were assumed for Lake



Michigan to account for uncertainty in water quality permitting for discharges that reach the lake. Therefore, the most expensive option is to modify a WWTP that is currently designed to treat effluent to a moderate river standard to instead treat effluent to a stringent lake standard. The least expensive option would be if a plant will be mandated to meet a stringent river standard and now must upgrade to meet a moderate lake standard.

Therefore, cost estimates for three different scenarios were examined for WWTPs:

- The first and most likely scenario is the **Moderate River to Stringent Lake Scenario**. This scenario assumes that the effluent quality standards required for discharges to the CAWS/Mississippi River are moderate, while those standards for discharges to Lake Michigan are stringent. Therefore, the improvements in effluent quality required when a WWTP discharges to the lake instead of the river would be the most costly because the difference in standards would be the greatest. This scenario was assumed to be the most likely based on the best available information at the time of this study regarding potential wastewater quality standards and regulatory requirements for nutrient removal and the anti-degradation process. This scenario would also be the most costly.
- The second scenario, the **Moderate River to Moderate Lake Scenario**, assumes that both bodies of water require moderate effluent quality improvements. The resulting costs are due to the difference between the moderate river standard and the moderate lake standard; that is, the moderate lake standard is higher than the moderate river standard. This scenario would have costs that fall in between those of the other two scenarios.
- The third scenario, the **Stringent River to Stringent Lake Scenario**, assumes that both bodies of water require a similar stringent level of effluent quality improvement. This scenario would be the least costly.

## **PRESENTATION OF DATA**

All capital and O&M costs in this cost analysis are median cost values in billions of dollars. In the tables and graphs that follow, the estimated investments required for the project represent the sum of the median cost estimates for flood management, water quality, and transportation investments. The graphs and summary tables show the investments in present value format and reflect the capital and O&M costs over the project lifecycle. Capital cost components such as engineering design, permitting, sewer separation, green infrastructure, and National Environmental Policy Act (NEPA) analyses start occurring as early as 2012. Major construction capital costs end in 2029, in line with the barrier completion date. However, O&M costs for several project components extend to the study end date of 2059.

All values in the cost analysis are presented in constant 2010 dollars. Since all cost values are in constant dollars, a real discount rate has been applied to calculate the present value of the

project's capital and O&M costs. Project cost inputs have been developed based on a preliminary assessment of the requirements for each separation alternative.

- Flood-management costs include all costs associated with investments related to sewer separation, floodplain storage, tunnels, conveyance, and green infrastructure.
- Water quality costs include all costs associated with investments related to the upgrades of the Calumet, North Side, and Stickney WWTPs plus costs associated with flow augmentation.
- Transportation costs include all costs associated with investments related to new port development, facilitating cargo transfer over the barrier, lifting and disinfecting recreational boats, new dry dock facilities, and intermodal facilities.

The costs associated with the actual dam or barrier structures are identified separately.

#### **DOWN RIVER ALTERNATIVE**

Future effluent standards have a significant impact on the project costs for the Down River Alternative due to the costs associated with upgrades at the Stickney WWTP. The total investment for this alternative ranges from \$3.94 billion to \$9.50 billion depending on the scenario. Water quality investments are \$5.85 billion for the Moderate River to Stringent Lake Scenario, \$1.57 billion for the Moderate River to Moderate Lake Scenario, and \$0.29 billion for the Stringent River to Stringent Lake Scenario.

The Down River Alternative also requires significant flood-management investments of \$2.98 billion related to tunnels to the lake, green infrastructure, and other elements. At \$0.56 billion, transportation investments for this alternative are less than for the other alternatives since only one cargo transfer location is required. Barrier costs are \$0.11 billion.

The figures that follow summarize these expenditure profiles and additional detail by specific investments and year are provided in Attachment I.

**Figure EA-10. Investments by Category, Down River Alternative  
(Moderate River to Stringent Lake Scenario)**

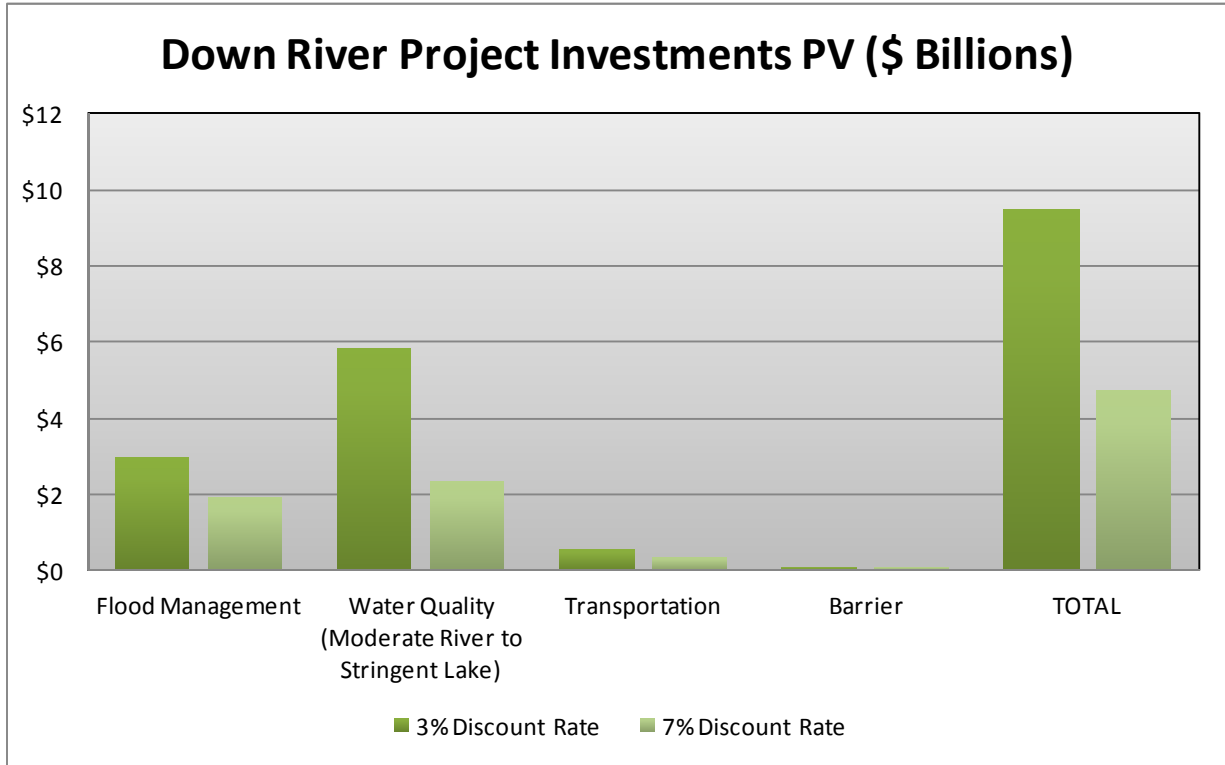

**Table EA-10. Investments by Category, Down River Alternative (Moderate River to Stringent Lake Scenario), Present Value in Billions of 2010 Dollars**

	<b>3%</b>	<b>7%</b>
Flood Management	\$2.98	\$1.94
Water Quality	\$5.85	\$2.35
Transportation	\$0.56	\$0.38
<b>Barrier</b>	<b>\$0.11</b>	<b>\$0.07</b>
<b>Total</b>	<b>\$9.50</b>	<b>\$4.74</b>

**Figure EA-11. Investments by Category, Down River Alternative  
(Moderate River to Moderate Lake Scenario)**

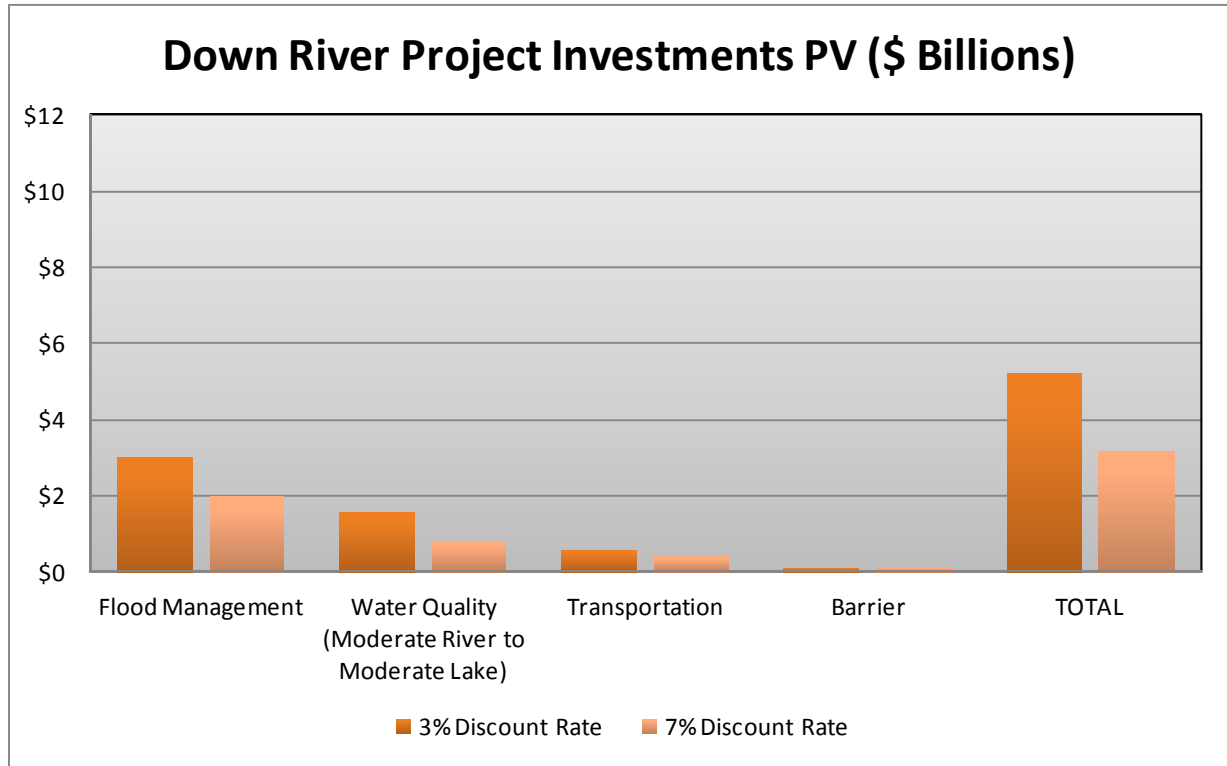

**Table EA-11. Investments by Category, Down River Alternative (Moderate River to Moderate Lake Scenario), Present Value in Billions of 2010 Dollars**

	<b>3%</b>	<b>7%</b>
Flood Management	\$2.98	\$1.94
Water Quality	\$1.57	\$0.78
Transportation	\$0.56	\$0.38
<b>Barrier</b>	\$0.11	\$0.07
<b>Total</b>	<b>\$5.22</b>	<b>\$3.17</b>

**Figure EA-12. Investments by Category, Down River Alternative (Stringent River to Stringent Lake Scenario)**

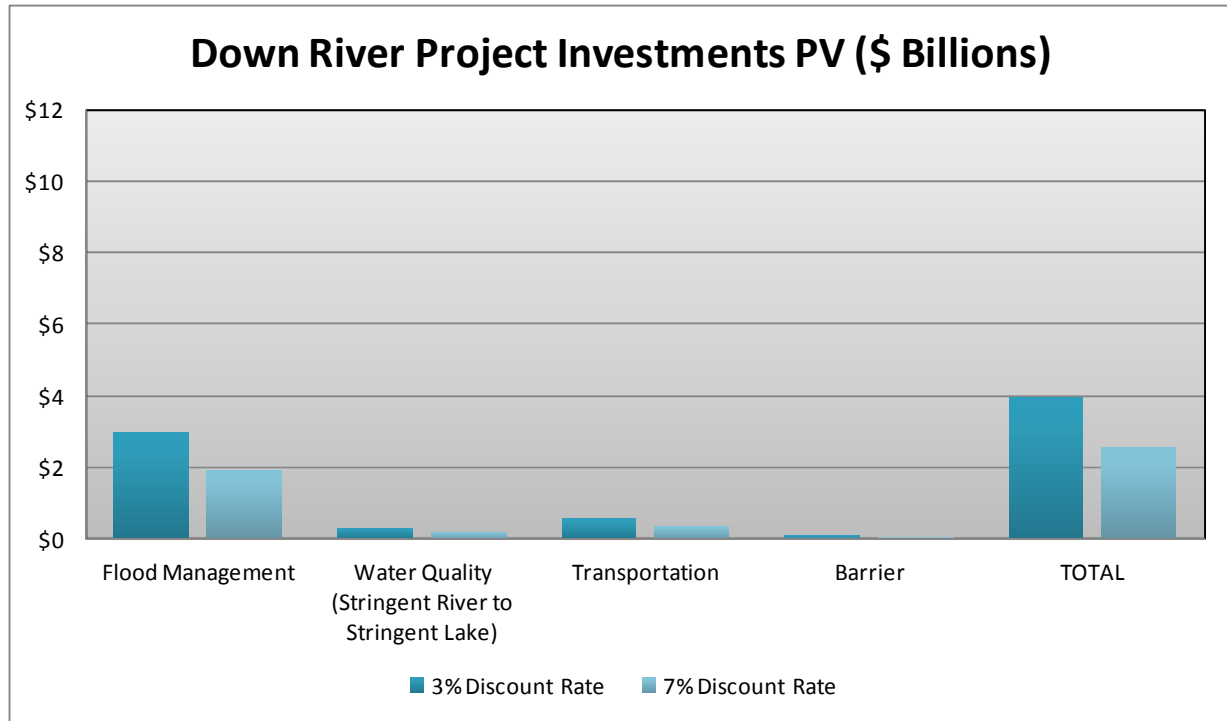

**Table EA-12. Investments by Category, Down River Alternative (Stringent River to Stringent Lake Scenario), Present Value in Billions of 2010 Dollars**

	<b>3%</b>	<b>7%</b>
Flood Management	\$2.98	\$1.94
Water Quality	\$0.29	\$0.19
Transportation	\$0.56	\$0.38
<b>Barrier</b>	<b>\$0.11</b>	<b>\$0.07</b>
<b>Total</b>	<b>\$3.94</b>	<b>\$2.58</b>

**Figure EA-13. Investment Breakdown, Down River Alternative, 3% Discount Rate**  
(Moderate River to Stringent Lake Scenario)

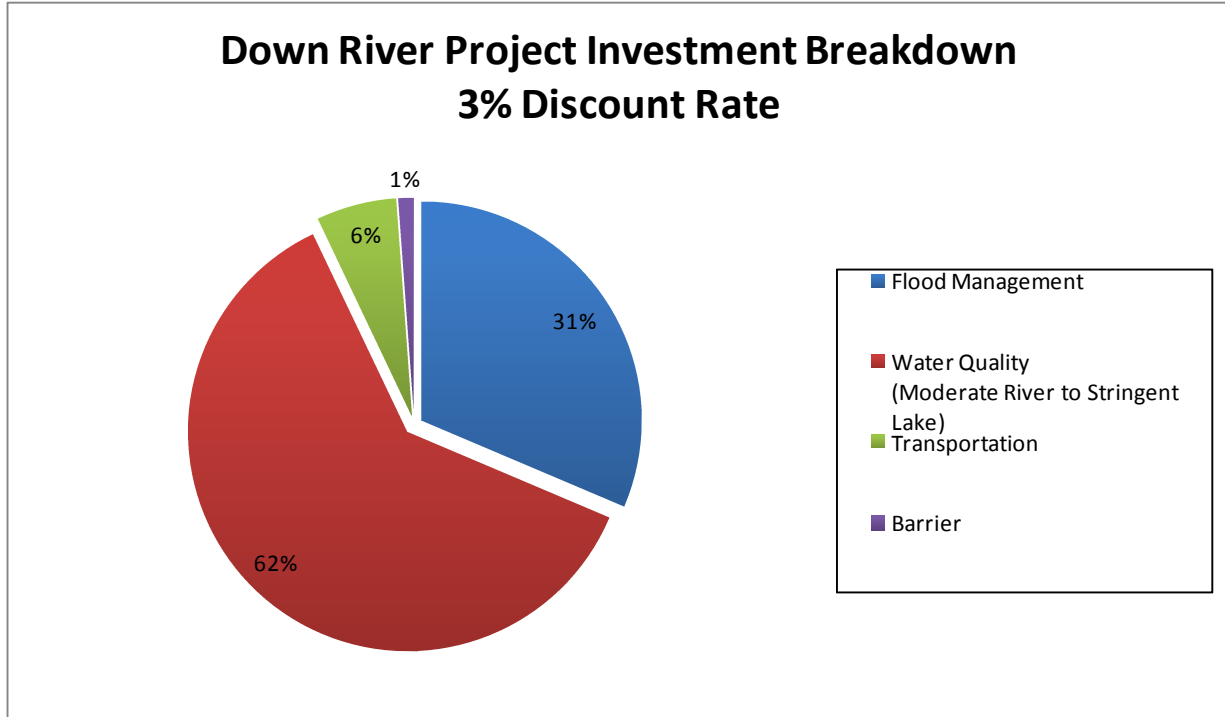

**MID-SYSTEM ALTERNATIVE**

The total investments for the Mid-System Alternative over the project lifecycle range from \$3.26 billion to \$4.27 billion, depending on what is assumed for the future effluent standards. The Mid-System Alternative has significant investments for flood management, water quality, and transportation. Flood-management investments are \$1.89 billion, and transportation investments are \$1.04 billion. Water quality investments range from \$0.18 billion to \$1.20 billion and primarily relate to WWTP upgrades at the North Side WWTP. Barrier costs are \$0.14 billion. The figures that follow summarize these expenditure profiles. Additional detail by specific investments and year are provided in Attachment I.

**Figure EA-14. Investments by Category, Mid-System Alternative  
(Moderate River to Stringent Lake Scenario)**

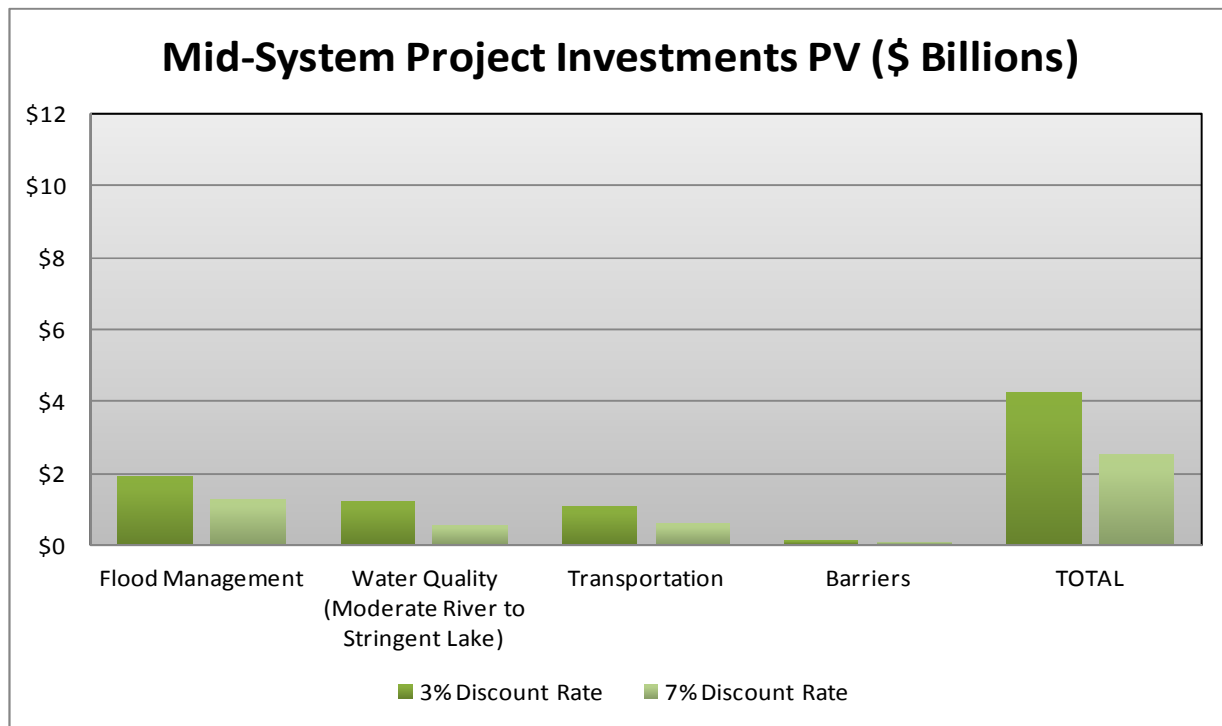
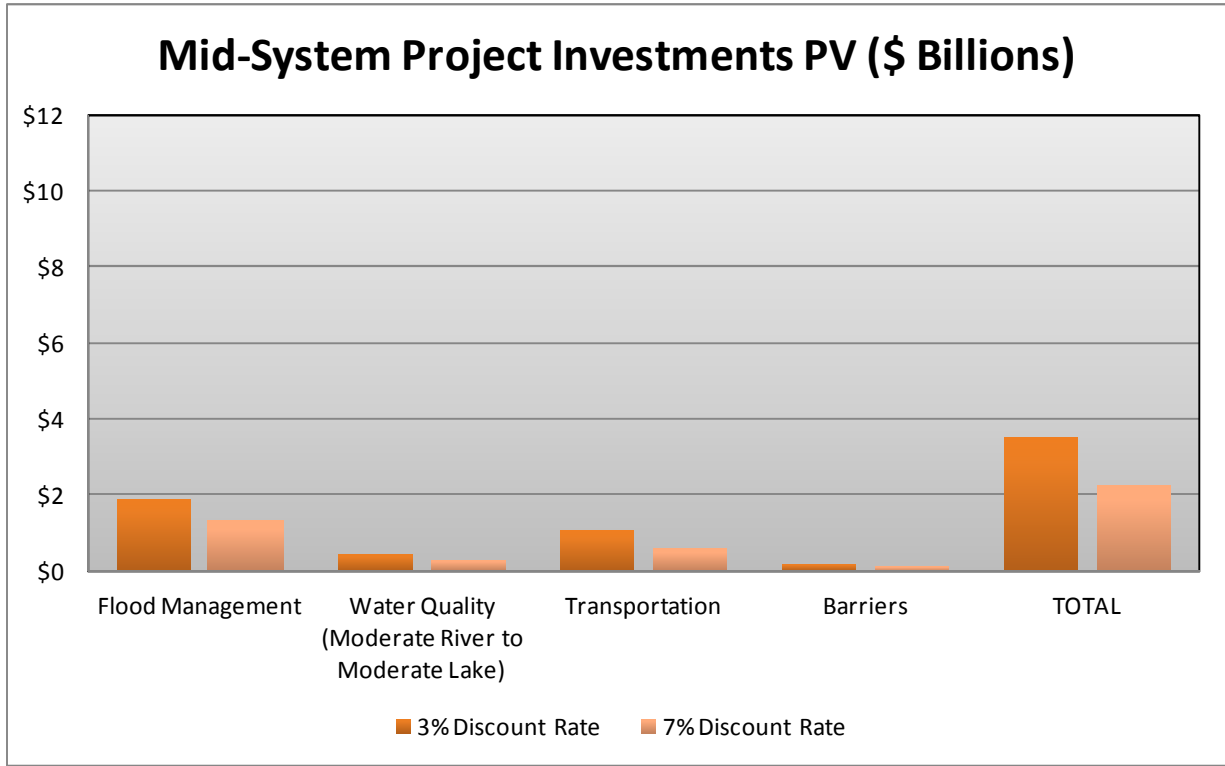

**Table EA-13. Investments by Category, Mid-System Alternative (Moderate River to Stringent Lake Scenario), Present Value in Billions of 2010 Dollars**

	<b>3%</b>	<b>7%</b>
Flood Management	\$1.89	\$1.29
Water Quality	\$1.20	\$0.52
Transportation	\$1.04	\$0.60
<b>Barrier</b>	<b>\$0.14</b>	<b>\$0.09</b>
<b>Total</b>	<b>\$4.27</b>	<b>\$2.52</b>



**Figure EA-15. Investments by Category, Mid-System Alternative  
(Moderate River to Moderate Lake Scenario)**



**Table EA-14. Investments by Category, Mid-System Alternative  
(Moderate River to Moderate Lake Scenario), Present Value in Billions of 2010 Dollars**

	<b>3%</b>	<b>7%</b>
Flood Management	\$1.89	\$1.29
Water Quality	\$0.45	\$0.25
Transportation	\$1.04	\$0.60
<b>Barrier</b>	\$0.14	\$0.09
<b>Total</b>	<b>\$3.52</b>	<b>\$2.24</b>

**Figure EA-16. Investments by Category, Mid-System Alternative (Stringent River to Stringent Lake Scenario)**

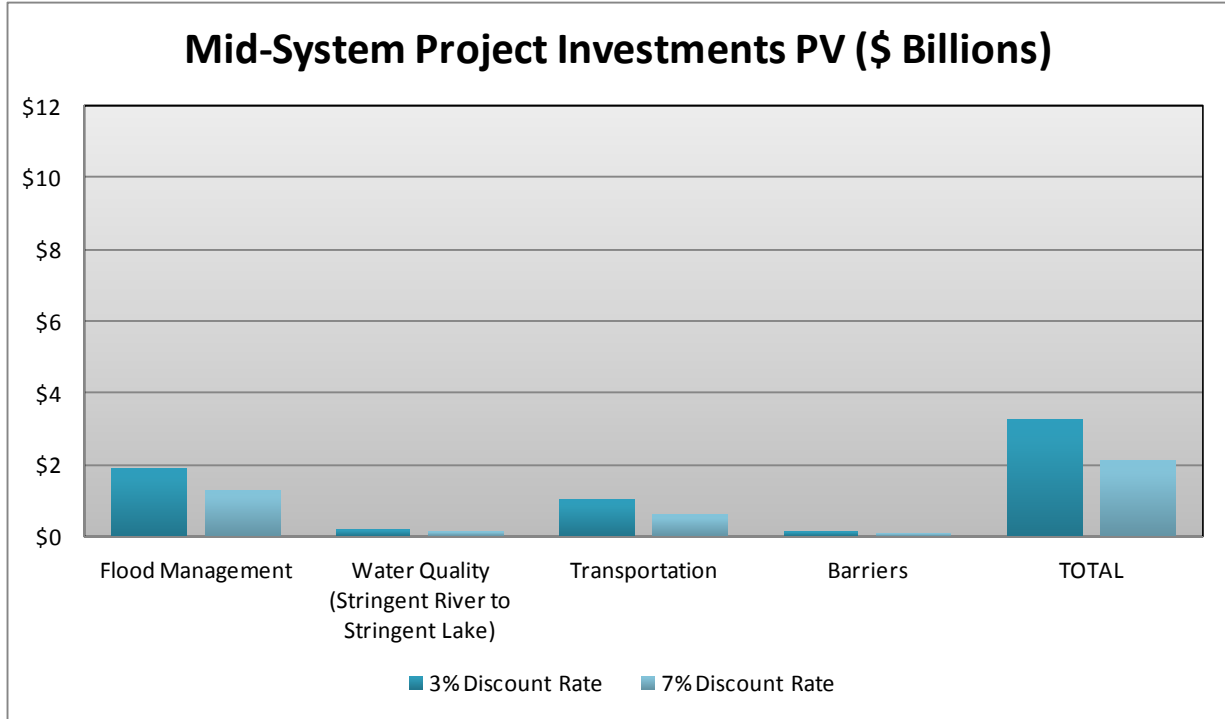

**Table EA-15. Investments by Category, Mid-System Alternative (Stringent River to Stringent Lake Scenario), Present Value in Billions of 2010 Dollars**

	3%	7%
Flood Management	\$1.89	\$1.29
Water Quality	\$0.18	\$0.12
Transportation	\$1.04	\$0.60
<b>Barrier</b>	<b>\$0.14</b>	<b>\$0.09</b>
<b>Total</b>	<b>\$3.26</b>	<b>\$2.11</b>

**Figure EA-17. Investment Breakdown, Mid-System Alternative, 3% Discount Rate  
(Moderate River to Stringent Lake Scenario)**

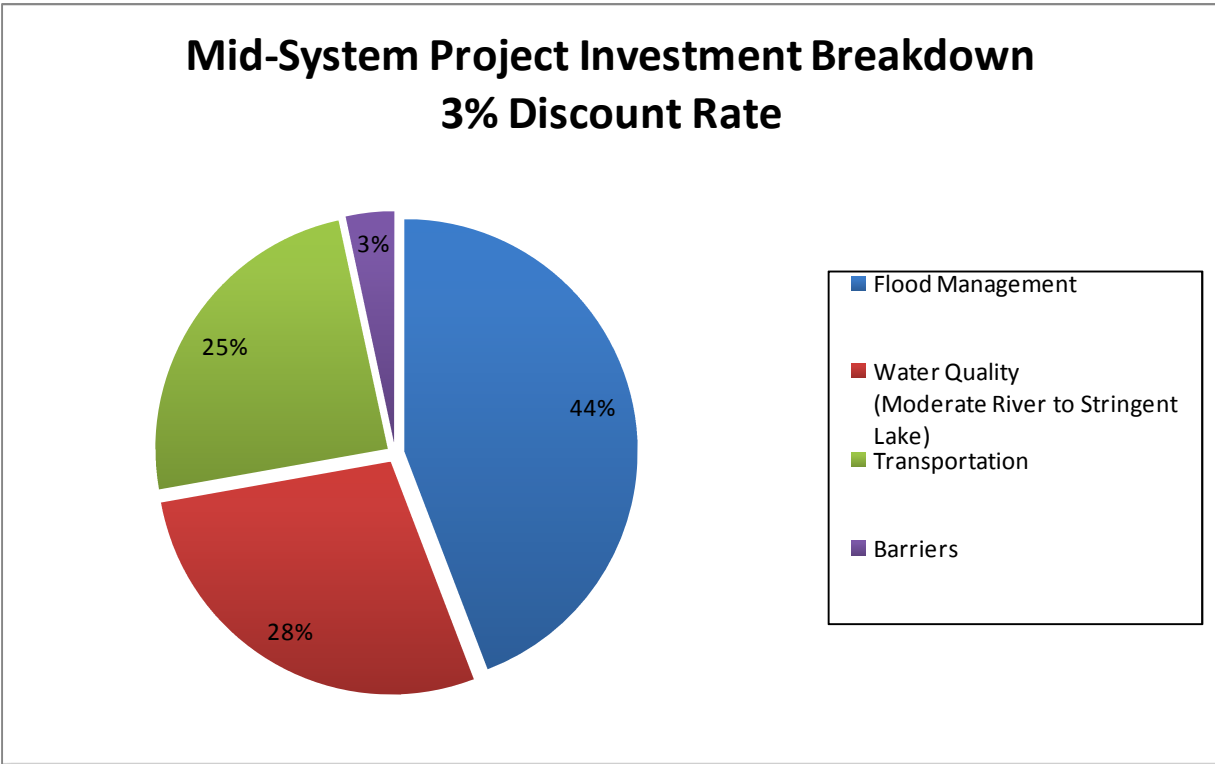

**NEAR LAKE ALTERNATIVE**

Because there would be no WWTP investments required, the total investments for the Near Lake Alternative are \$9.54 billion over the project lifecycle (for all scenarios involving possible changes to future effluent standards). For the Near Lake Alternative, transportation investments are the most significant investments at \$5.45 billion, primarily related to the development and operation of 18 shipping terminals that previously were on the Calumet River. There are also significant flood-management investments of \$3.82 billion for tunnel and reservoirs, green infrastructure, and other investments. There are minor water quality expenditures of \$0.12 billion required for flow augmentation, and barrier costs are \$0.14 billion.

The figures that follow summarize these expenditure profiles and additional detail by specific investments and year are provided in Attachment I.

**Figure EA-18. Investments by Category, Near Lake Alternative**

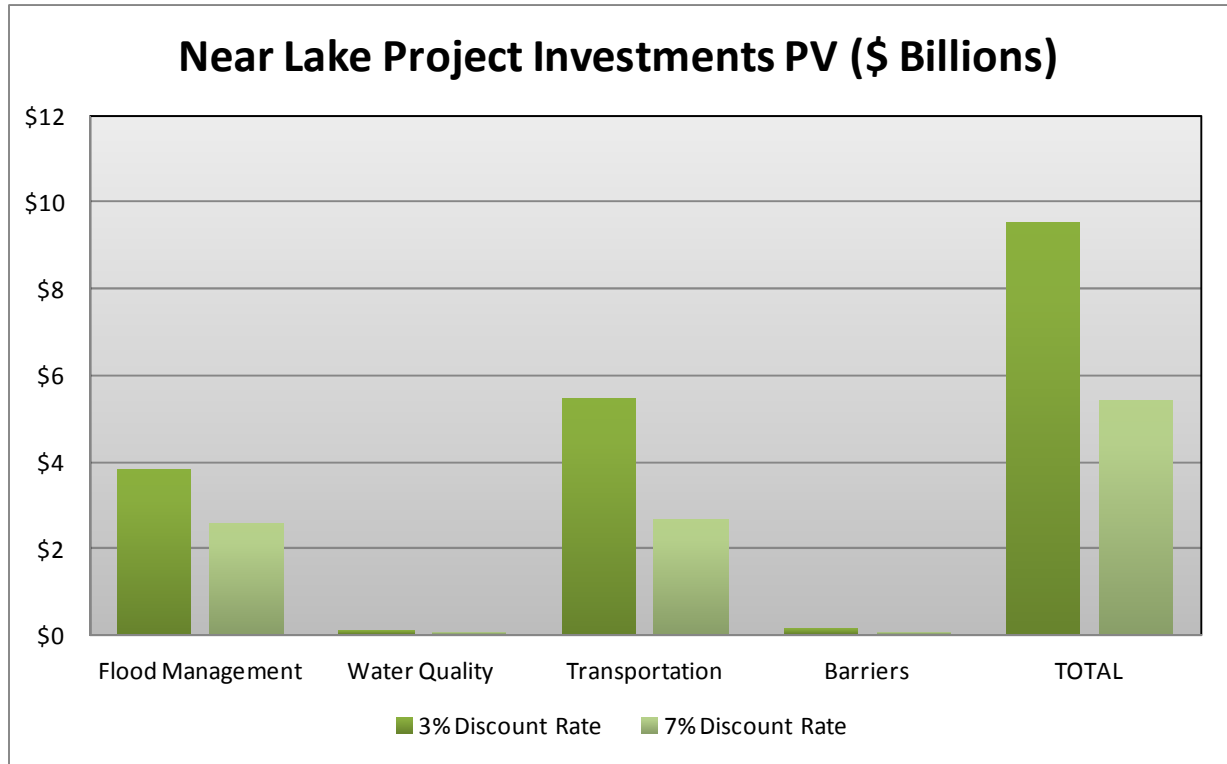

**Table EA-16. Investments by Category, Near Lake Alternative, Present Value in Billions of 2010 Dollars**

	<b>3%</b>	<b>7%</b>
Flood Management	\$3.82	\$2.58
Water Quality	\$0.12	\$0.07
Transportation	\$5.45	\$2.68
<b>Barrier</b>	\$0.14	\$0.08
<b>Total</b>	<b>\$9.54</b>	<b>\$5.40</b>

**Figure EA-19. Investment Breakdown, Near Lake Alternative, 3% Discount Rate**

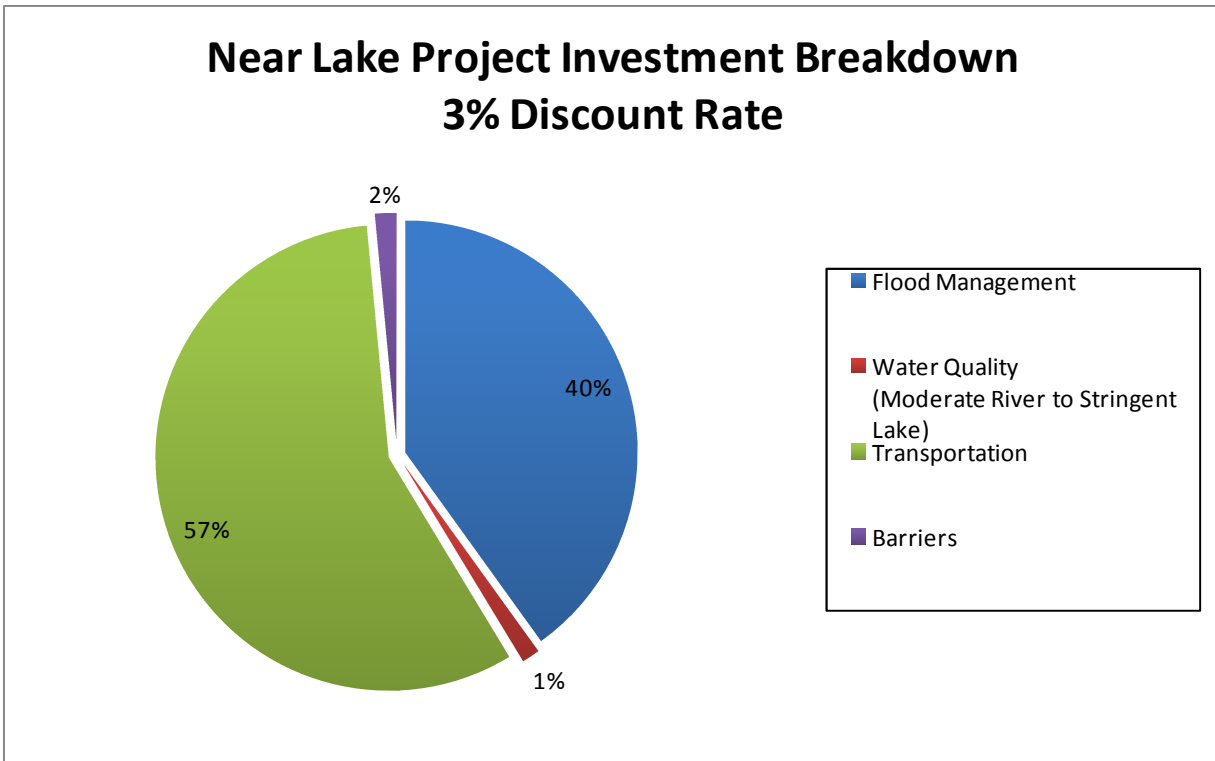

**SUMMARY OF COSTS ANALYSIS**

The estimated total project investment varies greatly depending on what is assumed for future WWTP effluent standards. Varying these assumptions can affect which separation alternative is determined to be the most cost-effective.

The determination of the most cost-effective alternative appears to be relatively straightforward under the Moderate River to Stringent Lake Scenario. The total project investments for the Mid-System Alternative of \$4.27 billion are less than half that of the other alternatives. However, under other scenarios, the difference in estimated investment levels between the Mid-System and Down River Alternatives is less significant. Still, the Mid-System Alternative’s estimated investments remain lower.

The Near Lake Alternative, with significant transportation investments to accommodate displaced Calumet River terminals, is expected to cost \$9.54 billion regardless of the water quality scenario.

The cost of the physical barriers is a small proportion of the total project investments and represents at most 3% of costs for all of the alternatives.

Figure EA-20. Total Project Investments, Present Value (PV) in Billions of Dollars

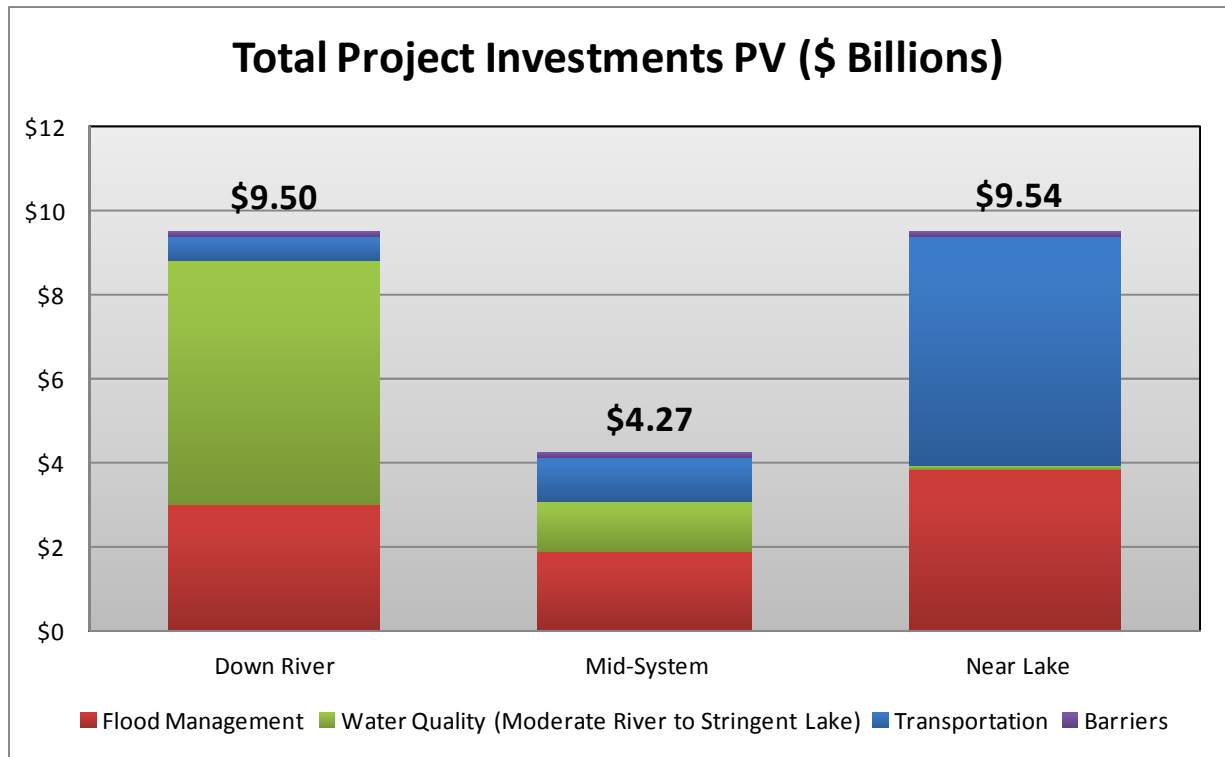
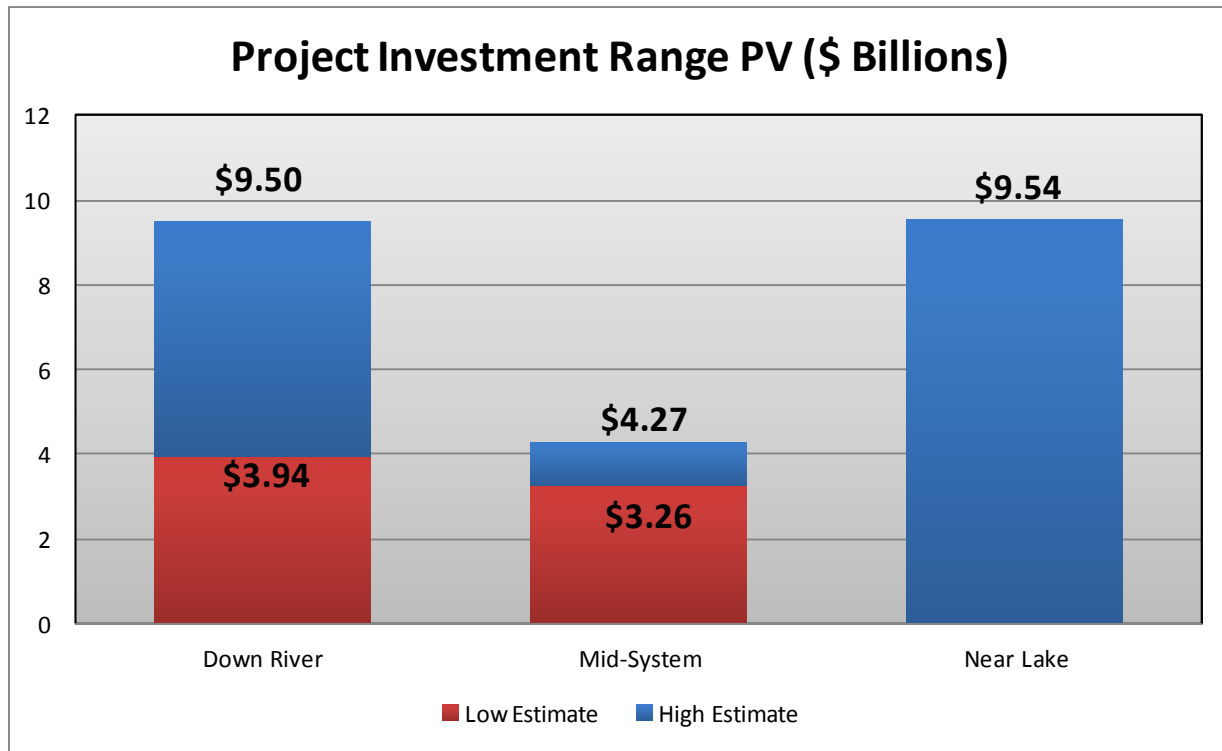

Figure EA-21 illustrates the range of project investments costs for the alternatives depending on the WWTP scenario. For the Down River Alternative, the required project investments range from \$3.94 billion (for the Stringent River to Stringent Lake Scenario) to \$9.50 billion (for the Moderate River to Stringent Lake Scenario). Similarly, Mid-System Alternative investments range from \$3.26 billion to \$4.27 billion.

**Figure EA-21. Project Investment Range, Present Value (PV) in Billions of Dollars**



**PRECISION OF PROJECT COST ESTIMATES**

The precision of the estimates should be considered when reviewing the overall project investments by alternative. The following list gives a general guide for the level of precision in these estimates for each area.

- Flood management: -50% to +100%
- Water quality: -50% to +100%
- Transportation: -25% to +50% for Mid-System and Down River
- Transportation: -50% to +100% for Near Lake

That is, for *total* water quality costs, the actual cost is expected to fall within -50% to +100% of the median estimate provided. For example, for a \$1-billion cost estimate, the potential range of estimates is \$500 million to \$2 billion.

Attachment II provides sensitivity and risk analysis on the results which illustrate the uncertainty involved in these cost estimates.



## I. OTHER ECONOMIC IMPACTS, DATA, ASSUMPTIONS AND RESULTS

This part describes the measurement approach used for each cost impact category identified and provides an overview of the associated methodology, assumptions, and estimates.

### PRESENTATION OF DATA

All impacts in this part are presented in millions of dollars. Unless otherwise stated, all impacts will be presented as positive values unless there is a number of different impacts and in that instance a cost impact will be presented as a negative value with beneficial impacts as positive values.

### TRANSPORTATION (CARGO MOVEMENT)

All of the separation alternatives being considered would affect the movement of cargo through the CAWS. In the baseline condition, cargo moves through the system and locks. With each of the separation alternatives, there are barriers in place that limit the physical movements of barges; it is not feasible to move barges over or around the barriers. However, the transportation investments provide the capability to move cargo over the barriers from barge to barge. In this way, the ability to use the CAWS for cargo movement via barge is maintained. Maintaining cargo movement through the system is important because the USACE estimates that *on average* it costs about \$24 per ton, or almost 60% less, to move cargo via barge than via other modes (USACE-NETS, 2007). Note that other studies that have examined the impact of separation on cargo movements have not assumed that cargo could be transferred over the proposed barrier.

While the transportation movements provide the ability to move cargo on the CAWS, the cost of barge transportation would increase due to additional time required for transferring cargo over the barrier to another barge, new logistical relationships with other barge operators for transferring cargo over the barrier, and the requirement for additional barges on each side of the barrier. Based on financial statement data from inland waterway operators and operational data from the USACE, the cost of barge operators and the rate for shippers could increase by about 10% and transit times by about 5%.

Using this cost data and demand elasticity with respect to price and transit time from USACE studies (USACE-NETS, 2007), an order-of-magnitude estimate of the proportion of cargo that would remain on the waterway (although at a higher cost of transport) and the amount of cargo that would switch to other modes can be determined. The rate and transit time demand elasticity are approximately -1 each, so the rate and transit time increases above would result in about a 15% modal shift. The simplifying assumption was made that all cargo would continue

to move one way or another and that shippers would not stop movements altogether because of the increased transportation costs.

Given these assumptions, the following impacts would occur:

- For cargo that continues to move through the CAWS on barge, there would be increased transportation/shipping costs.
- For cargo movements that change modes, there would be several different impacts:
  - Increased shipping/transportation costs via the other modes.
  - Increased emission levels from other modes (relative to barge).
  - Increased accidents from other modes (relative to barge).
  - Increased roadway congestion due to truck traffic.
  - Increased accidents (relative to barge).

In general, the approach to deriving the impact of each of the alternatives is similar, with the only difference being the amount of cargo that is affected by the various barrier locations.

Overall, the change in cargo transportation over the study lifecycle is estimated to have a range of additional economic costs between \$1.3 billion and \$1.5 billion for the various alternatives over the almost 50-year project lifecycle. The largest impact would occur with the Near Lake Alternative, since more cargo would be affected. The vast majority of this impact is related to additional transportation cost for any cargoes that change modes and the cost associated with the additional handling of cargo over the barrier for cargo that remains on the CAWS. The other impacts or externalities are also quantified, but these account for only about one-quarter of the overall impact.

The overall intent of this analysis is to provide an order-of-magnitude impact of the potential impacts. It is recognized that these overall results are sensitive to the assumptions used in the analysis, and varying these inputs can result in much smaller or much larger impacts. The estimates can be considered an upper bound of the impact for the following reasons: it is based on the assumption of forecasted growth of cargo movements through the CAWS, which is counter to the trend over the last several years; it does not reflect the potential for shutting down coal-fired power plants serviced by the CAWS in the future, which would lower the cost impact of cargo movements for the Down River Alternative; and it assumes that cargo that shifts modes reflects the average barge savings of \$24 per ton, while the cargo that switches modes might have lower-than-average rate savings by barge. Sensitivity analysis is provided in Attachment II to illustrate this further.

The Structure and Logic model, key assumptions and monetized impacts of these results over the project lifecycle are provided below.

**Figure EA-22. S&L for Cargo Handling Cost**

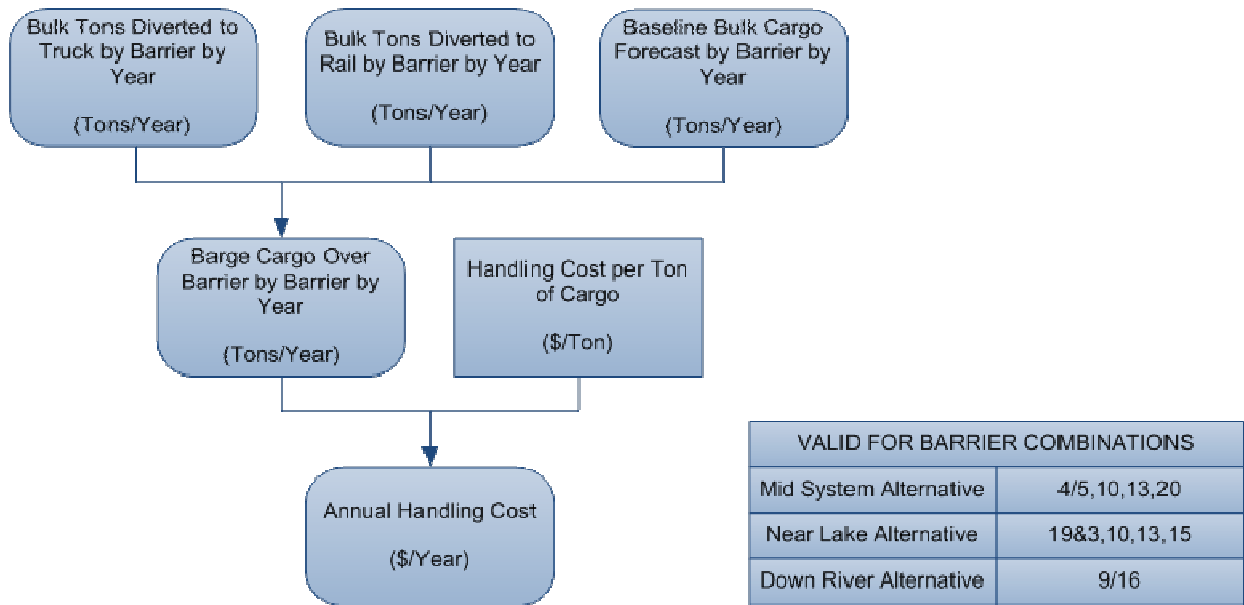

**Figure EA-23. S&L for Cargo Shipping Cost**

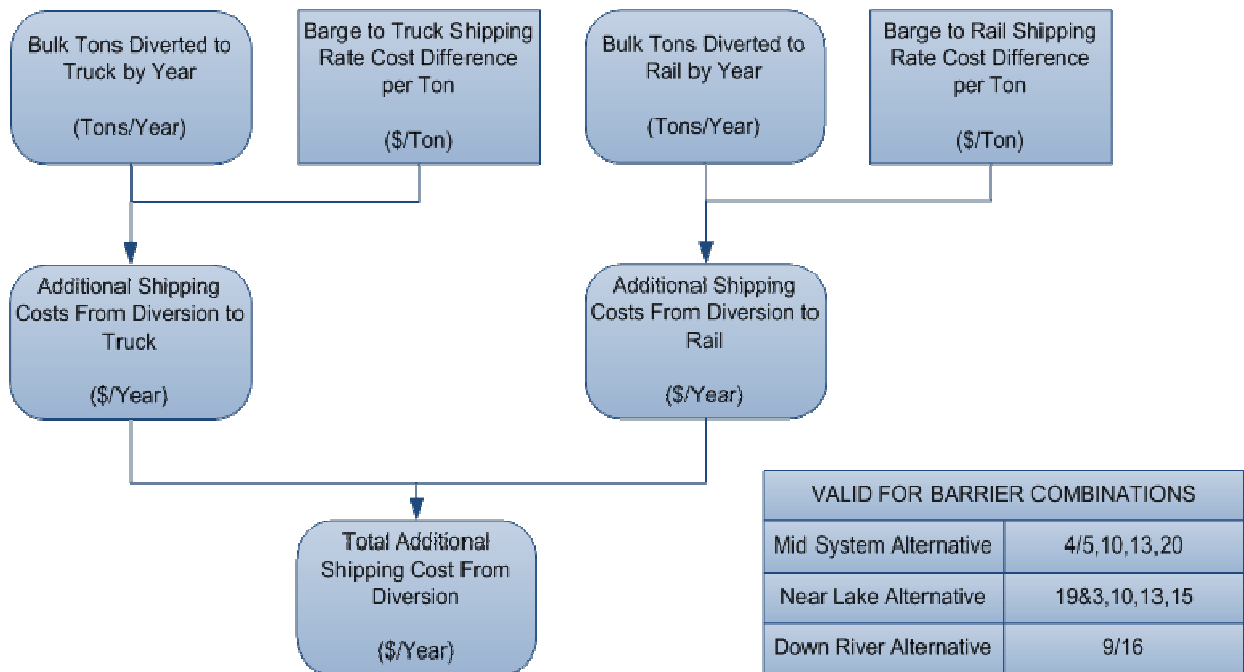

**Figure EA-24. Change in Rail Emission Cost from Diversion**

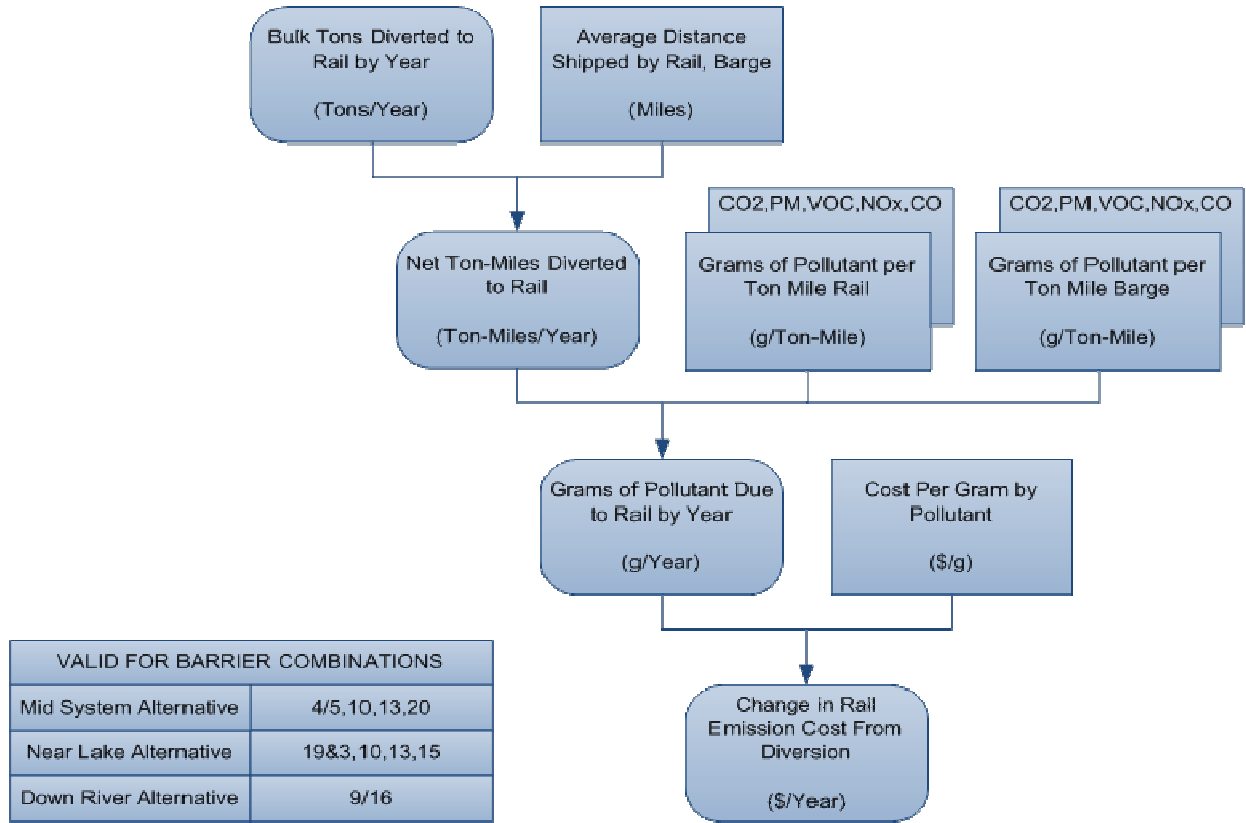

**Figure EA-25. S&L for Change in Truck Emission Cost from Diversion**

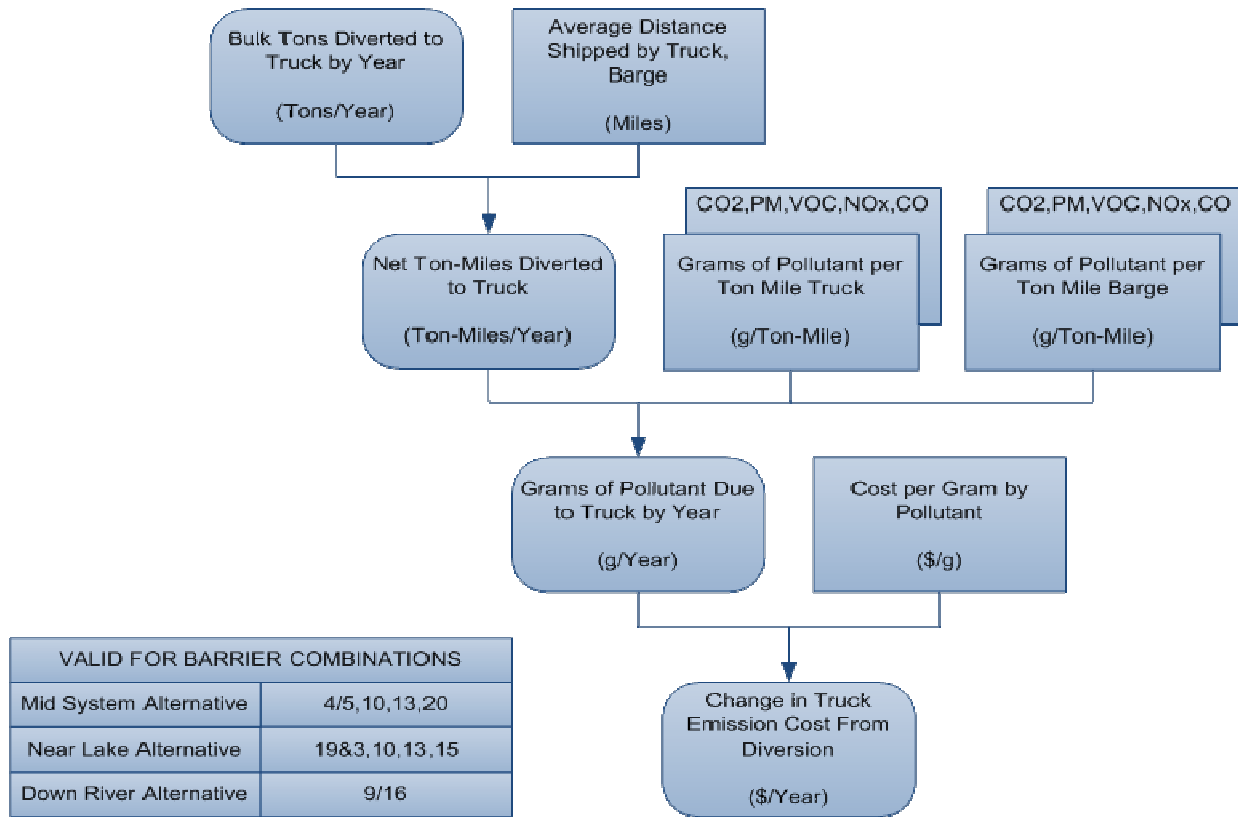

**Figure EA-26. S&L for Change in Rail Accident Cost from Diversion**

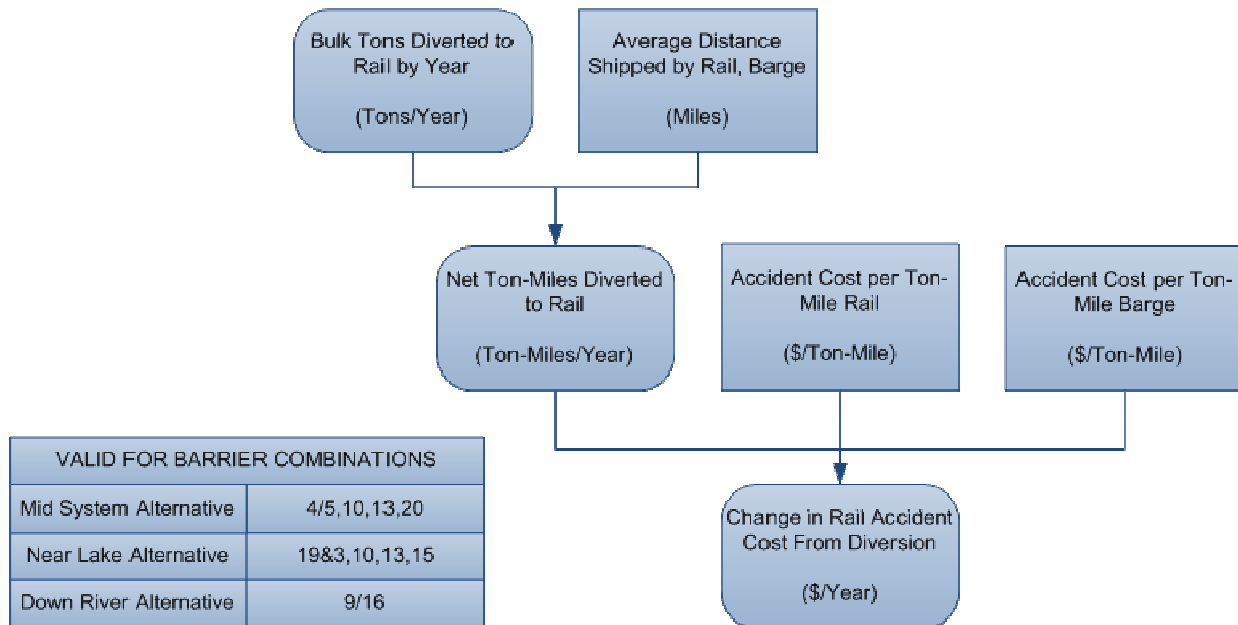

**Figure EA-27. S&L for Change in Truck Accident Cost from Diversion**

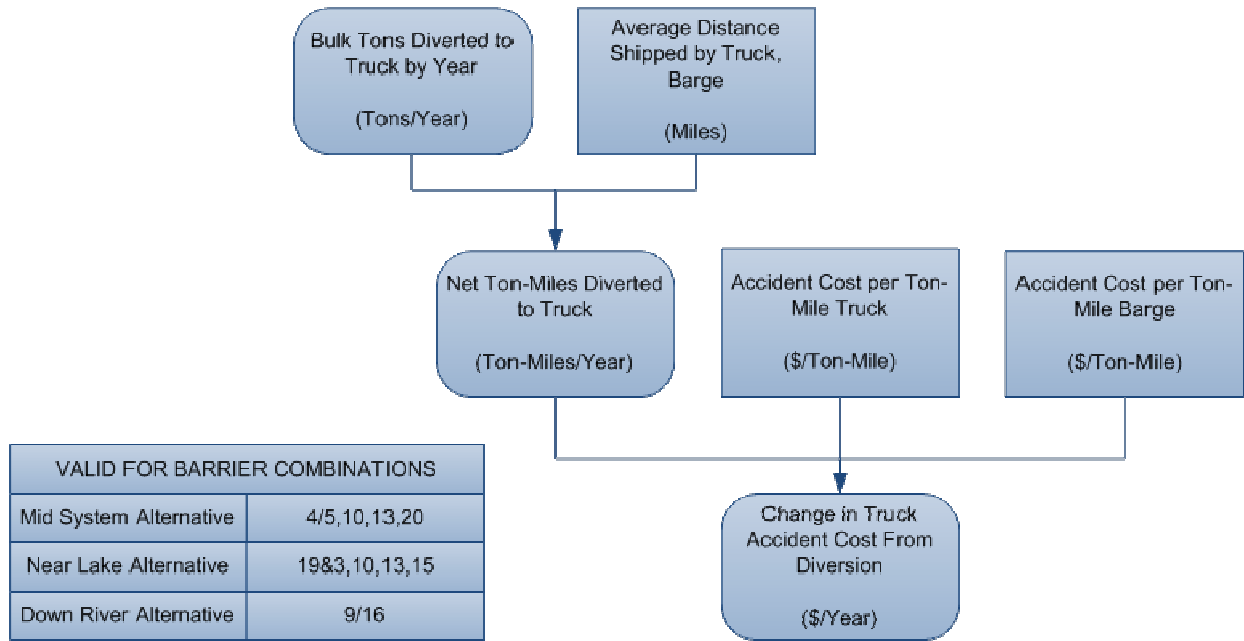

**Figure EA-28. S&L for the Change in Rail Operating and Maintenance Cost from Diversion**

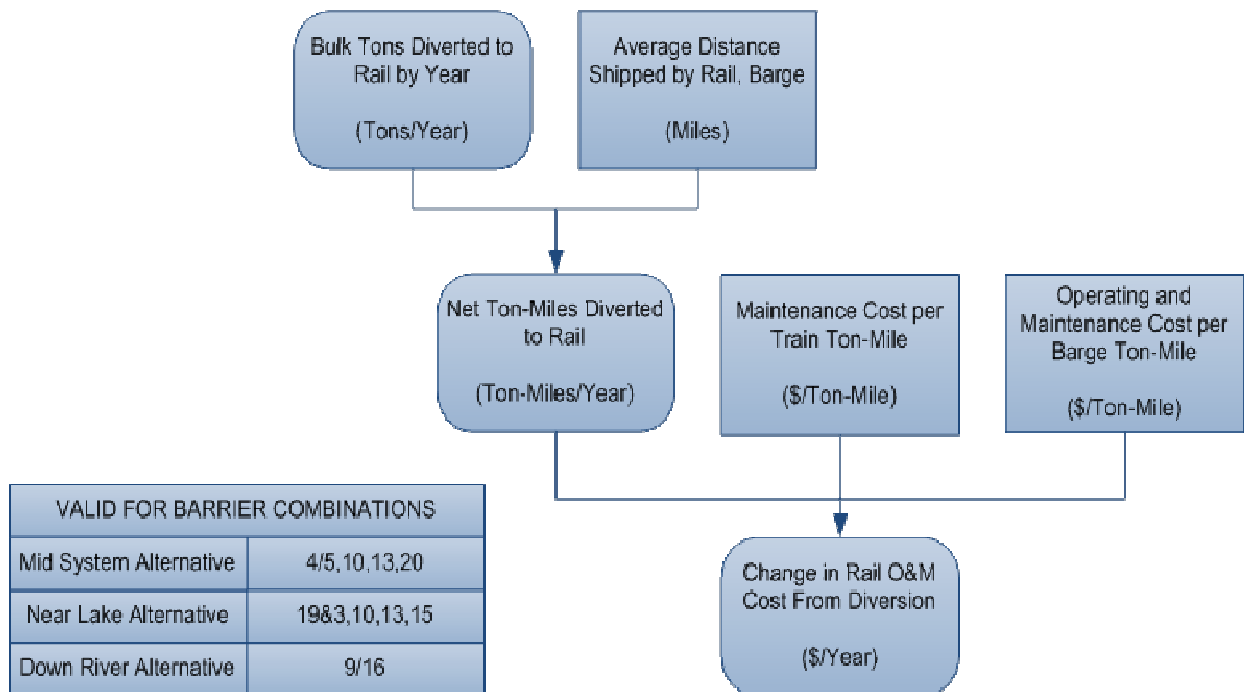

**Figure EA-29. S&L for the Truck Operating and Maintenance Cost from Diversion**

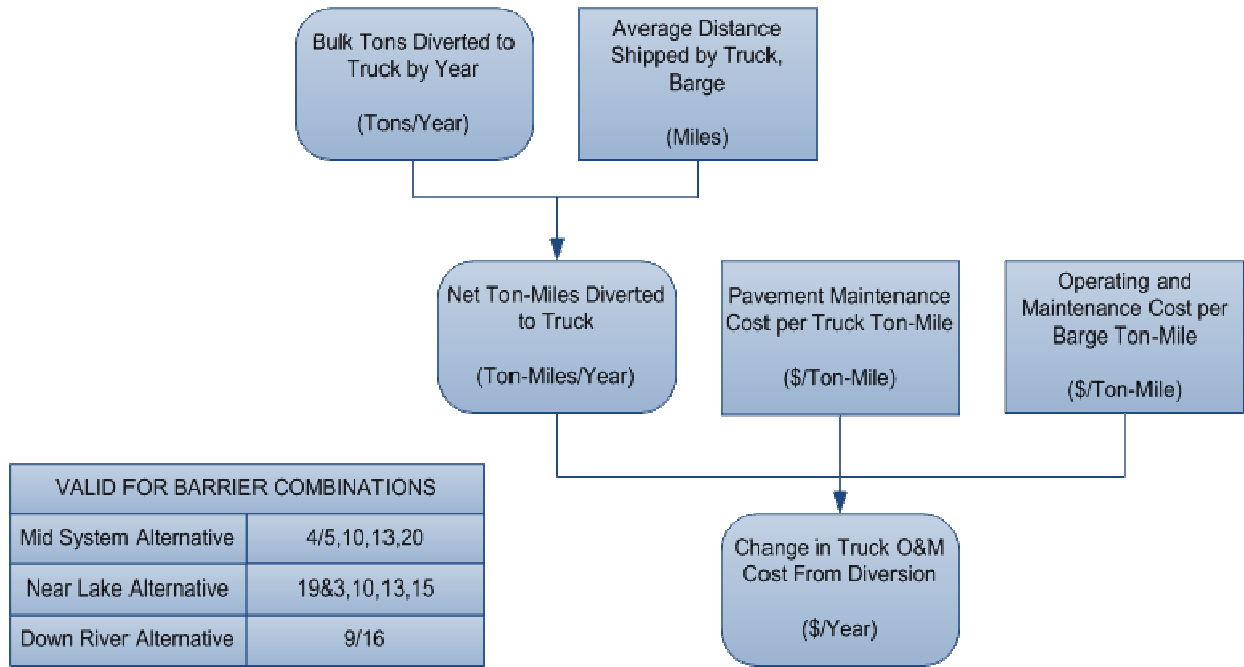

**Figure EA-30. S&L for the Change in Truck Congestion Cost from Diversion**

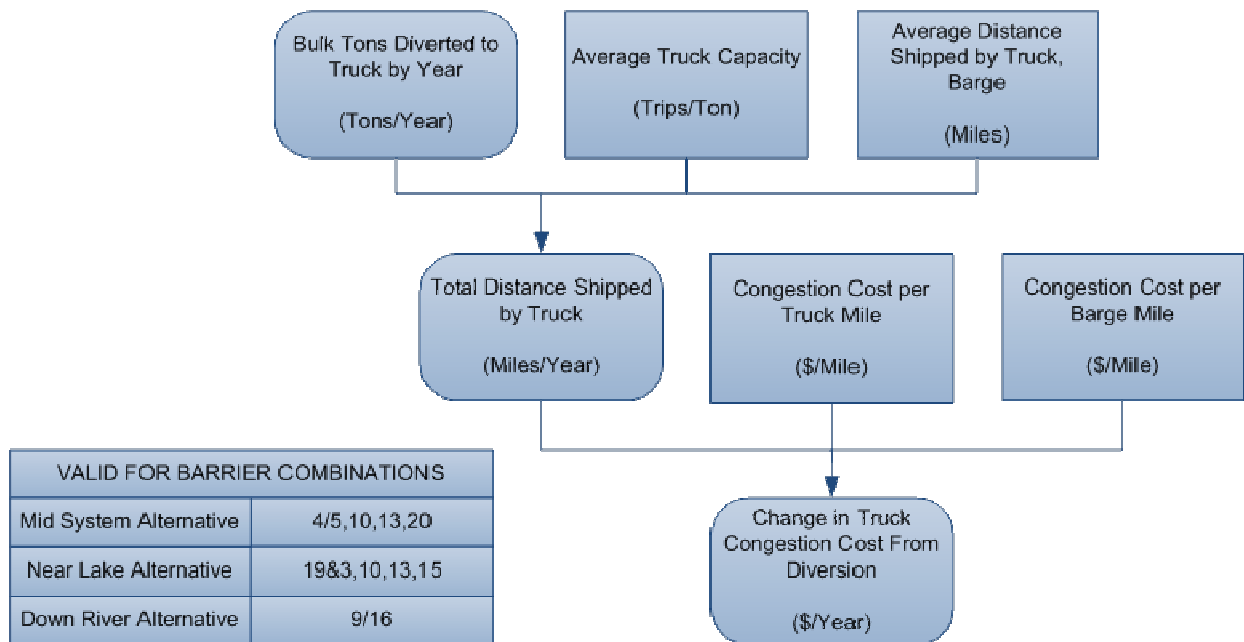



**Table EA-17. Input Assumptions for Cargo Movement Impacts**

Variable Name	Unit	Value	Source
Baseline Bulk Cargo - Barrier 15	Tons	10,446,697	USACE. Mile point 333 cargo tonnage data. Average of 2005 to 2009 annual tonnage values.
Baseline Bulk Cargo - Barrier 3	Tons	116,386	USACE. IWR Lockage data. Average of 2006 to 2010 annual tonnage values.
Baseline Bulk Cargo - Barrier 4/5	Tons	1,490,450	USACE. Mile point 324 cargo tonnage data. Average of 2005 to 2009 annual tonnage values.
Baseline Bulk Cargo - Barrier 20	Tons	6,565,551	USACE. Mile point 314 cargo tonnage data. Average of 2005 to 2009 annual tonnage values.
Baseline Bulk Cargo - Barrier 9/16	Tons	7,417,088	USACE. Mile point 303 cargo tonnage data. Average of 2005 to 2009 annual tonnage values.
Bulk Tons Diverted to Other Modes Due to Rate Increases	%	8.9%	Based on estimated 10% increase in barge related transportation costs. Forecasted switch based on average from NETS report.  NETS. Transportation Demand for the Movement of Non-Agricultural Commodities Pertinent to the Upper Mississippi and Illinois River Basin. May, 2007.
Bulk Tons Diverted to Other Modes Due to Transit Time Increases	%	5.6%	Based on estimated 5% increase in barge transit times due to additional handling process at barrier. Forecasted switch based on NETS report arc elasticities with respect to transit time increases.  NETS. Transportation Demand for the Movement of Non-Agricultural Commodities Pertinent to the Upper Mississippi and Illinois River Basin. May, 2007.
Bulk Tons Diverted to Rail	%	50%	HDR Estimate.
Bulk Tons Diverted to Truck	%	50%	HDR Estimate.
Additional Handling Cost per Ton of Cargo	\$/Ton	\$1.50	HDR Estimate. Based on 10% increase in barge related transportation costs and \$15/ton absolute value of barge shipping rate.
Barge to Rail Shipping Rate Cost Difference per Ton	\$/Ton	\$24.10	Based on shipping transportation rate savings at O'Brien and Chicago locks.  Declaration of Rebecca J. Moyer. Lead Economist in Great Lakes and Ohio River Division, USACE.

Variable Name	Unit	Value	Source
Barge to Truck Shipping Rate Cost Difference per Ton	\$/Ton	\$24.10	Based on shipping transportation rate savings at O'Brien and Chicago locks.  Declaration of Rebecca J. Moyer. Lead Economist in Great Lakes and Ohio River Division, USACE.
Average Distance Shipped by Rail, Barge	Miles	405	NETS. Transportation Demand for the Movement of Non-Agricultural Commodities Pertinent to the Upper Mississippi and Illinois River Basin. May, 2007.
Average Distance Shipped by Truck, Barge	Miles	368	
Average Distance Shipped by Barge, Barge	Miles	479	
Grams of NOx per Ton Mile Rail	g/Ton-Mile	0.653	TTI Study focuses on five pollutants that are tracked by the EPA: hydrocarbons (HC), carbon monoxide (CO), nitrogen oxide (NOx), particulate matter (PM10), and carbon dioxide (CO2).
Grams of CO2 per Ton Mile Rail	g/Ton-Mile	24.390	
Grams of PM10 per Ton Mile Rail	g/Ton-Mile	0.016	
Grams of CO per Ton Mile Rail	g/Ton-Mile	0.064	
Grams of HC per Ton Mile Rail	g/Ton-Mile	0.024	
Grams of VOC per Ton Mile Rail	g/Ton-Mile	0.025	
Grams of NOx per Ton Mile Barge	g/Ton-Mile	0.469	Texas Transportation Institute. A Modal Comparison of Domestic Freight Transportation Effects on the General Public. December 2007.
Grams of CO2 per Ton Mile Barge	g/Ton-Mile	17.480	
Grams of PM10 per Ton Mile Barge	g/Ton-Mile	0.012	
Grams of CO per Ton Mile Barge	g/Ton-Mile	0.046	
Grams of HC per Ton Mile Barge	g/Ton-Mile	0.017	
Grams of VOC per Ton Mile Barge	g/Ton-Mile	0.018	
Grams of NOx per Ton Mile Truck	g/Ton-Mile	0.732	
Grams of CO2 per Ton Mile Truck	g/Ton-Mile	64.960	
Grams of PM10 per Ton Mile Truck	g/Ton-Mile	0.018	
Grams of CO per Ton Mile Truck	g/Ton-Mile	0.136	
Grams of HC per Ton Mile Truck	g/Ton-Mile	0.020	HDR Inventory of Economic Values. CO2 cost per ton values have been provided until 2050 by the Interagency Working Group on Social Cost of Carbon. Dates 2051-2059 have been adjusted using a constant growth rate from year 2050.
Grams of VOC per Ton Mile Truck	g/Ton-Mile	0.021	
Cost per Ton of CO1	2010\$/Ton	\$23.59	
Cost per Ton of CO2	2010\$/Ton	\$24.14	
Cost per Ton of CO2	2010\$/Ton	\$24.69	
Cost per Ton of CO2	2010\$/Ton	\$25.13	
Cost per Ton of CO2	2010\$/Ton	\$25.68	
Cost per Ton of CO2	2010\$/Ton	\$26.24	
Cost per Ton of CO2	2010\$/Ton	\$26.79	
Cost per Ton of CO2	2010\$/Ton	\$27.34	
Cost per Ton of CO2	2010\$/Ton	\$27.89	
Cost per Ton of CO2	2010\$/Ton	\$28.44	
Cost per Ton of CO2	2010\$/Ton	\$28.99	
Cost per Ton of CO2	2010\$/Ton	\$29.76	
Cost per Ton of CO2	2010\$/Ton	\$30.42	
Cost per Ton of CO2	2010\$/Ton	\$31.20	
Cost per Ton of CO2	2010\$/Ton	\$31.86	
Cost per Ton of CO2	2010\$/Ton	\$32.63	
Cost per Ton of CO2	2010\$/Ton	\$33.29	
Cost per Ton of CO2	2010\$/Ton	\$34.06	
Cost per Ton of CO2	2010\$/Ton	\$34.72	

Variable Name	Unit	Value	Source
Cost per Ton of CO2	2010\$/Ton	\$35.38	
Cost per Ton of CO2	2010\$/Ton	\$36.16	
Cost per Ton of CO2	2010\$/Ton	\$36.82	
Cost per Ton of CO2	2010\$/Ton	\$37.59	
Cost per Ton of CO2	2010\$/Ton	\$38.25	
Cost per Ton of CO2	2010\$/Ton	\$39.02	
Cost per Ton of CO2	2010\$/Ton	\$39.68	
Cost per Ton of CO2	2010\$/Ton	\$40.45	
Cost per Ton of CO2	2010\$/Ton	\$41.12	
Cost per Ton of CO2	2010\$/Ton	\$41.78	
Cost per Ton of CO2	2010\$/Ton	\$42.55	
Cost per Ton of CO2	2010\$/Ton	\$43.21	
Cost per Ton of CO2	2010\$/Ton	\$43.87	
Cost per Ton of CO2	2010\$/Ton	\$44.53	
Cost per Ton of CO2	2010\$/Ton	\$45.08	
Cost per Ton of CO2	2010\$/Ton	\$45.75	
Cost per Ton of CO2	2010\$/Ton	\$46.41	
Cost per Ton of CO2	2010\$/Ton	\$46.96	
Cost per Ton of CO2	2010\$/Ton	\$47.62	
Cost per Ton of CO2	2010\$/Ton	\$48.28	
Cost per Ton of CO2	2010\$/Ton	\$48.94	
Cost per Ton of CO2	2010\$/Ton	\$49.49	
Cost per Ton of CO2	2010\$/Ton	\$50.05	
Cost per Ton of CO2	2010\$/Ton	\$50.62	
Cost per Ton of CO2	2010\$/Ton	\$51.19	
Cost per Ton of CO2	2010\$/Ton	\$51.77	
Cost per Ton of CO2	2010\$/Ton	\$52.35	
Cost per Ton of CO2	2010\$/Ton	\$52.95	
Cost per Ton of CO2	2010\$/Ton	\$53.54	
Cost per Ton of CO2	2010\$/Ton	\$54.15	
Cost per Ton of CO2	2010\$/Ton	\$54.76	
Cost per Ton of PM	\$/Ton	\$160,323	HDR Inventory of Economic Values.
Cost per Ton of VOC	\$/Ton	\$1,622	
Cost per Ton of NOx	\$/Ton	\$3,817	
Cost per Ton of CO	\$/Ton	\$479	HDR Inventory of Economic Values.
Accident Cost per Ton-Mile Truck	\$/Ton-Mile	\$0.03514	HDR Calculated.
Accident Cost per Ton-Mile Rail	\$/Ton-Mile	\$0.00354	HDR Calculated.
Accident Cost per Ton-Mile Barge	\$/Ton-Mile	\$0.00008	HDR Calculated.
Fatalities - Truck	Fatalities per Billion Ton-Miles	2.54	Government Accountability Office. A Comparison of the Costs of Road, Rail, and Waterways Freight Shipments That Are Not Passed on to Consumers. January 2011.
Fatalities - Rail	Fatalities per Billion Ton-Miles	0.39	
Fatalities - Barge	Fatalities per Billion Ton-Miles	0.01	

Variable Name	Unit	Value	Source
Injuries - Truck	Injuries per Billion Ton-Miles	56.05	
Injuries - Rail	Injuries per Billion Ton-Miles	3.32	
Injuries - Barge	Injuries per Billion Ton-Miles	0.05	
Cost of a Fatality	\$	\$6,098,417	U.S. Department of Transportation, Treatment of the Economic Value of a Statistical Life in Department Analyses. March 18, 2009. <a href="http://ostpxweb.dot.gov/policy/reports.htm">http://ostpxweb.dot.gov/policy/reports.htm</a>
Cost of a Injury - Serious Injury	\$	\$350,659	
Maintenance Cost per Train Ton-Mile	\$/Ton-Mile	\$0.0023	HDR Calculations based on George Avery Grimes, Ph.D., P.E.1; and Christopher P. L. Barkan, Ph.D. "Cost-Effectiveness of Railway Infrastructure Renewal Maintenance".
Pavement Maintenance Cost per Truck Ton-Mile	\$/Ton-Mile	\$0.0092	HDR Calculations based on the Addendum to the 1997 Federal Highway Cost Allocation Study, Final Report, U.S. Department of Transportation and Federal Highway Administration, May 2000. Assumes 90 percent rural truck traffic.
Capacity - Highway Truck Trailer	Tons	25	One tractor with a 53 ft trailer. Texas Transportation Institute. A Modal Comparison of Domestic Freight Transportation Effects on the General Public. December 2007.
Congestion Cost per Truck Mile	\$/Mile	\$0.1154	Values are for single unit trucks. Federal Highway Administration, 1997 Federal Highway Cost Allocation Study.

The overall impact of cargo transportation over the study lifecycle is estimated to be in the range of additional economic costs between \$1.3 billion and \$1.5 billion for various alternatives. The largest impact is at the Near Lake Alternative as more cargo is impacted. The vast majority of this impact is related to additional transportation costs for any cargoes that change modes and the costs associated with the additional handling of barge over the barrier for cargo that remains on the CAWS. The other impacts or externalities are also quantified but these account for only about one quarter of the overall impact.

The overall intent of this analysis is to provide an order of magnitude impact of the potential impacts. It is recognized that these overall results are quite sensitive to the assumptions

employed in the analysis and varying these inputs can result in much smaller and much larger impacts. Sensitivity analysis is provided in Attachment II to illustrate this further.

**Table EA-18. Cargo-Related Impacts (Costs), Down River Alternative, Millions of 2010 Dollars**

Cost	First-Year Impact (2023)	Present Value of Impact (\$ millions)	
		3% Discount Rate	7% Discount Rate
Cargo Handling	-\$14	-\$253	-\$91
Shipping Rate (from Modal Shift)	-\$37	-\$690	-\$248
Emissions	-\$2	-\$32	-\$12
Accidents	-\$11	-\$205	-\$74
O&M	-\$3	-\$61	-\$22
Congestion	-\$2	-\$27	-\$10
<b>Total</b>	<b>-\$68</b>	<b>-\$1,269</b>	<b>-\$455</b>

**Table EA-19. Cargo-Related Impacts (Costs), Mid-System Alternative, Millions of 2010 Dollars**

Cost	First-Year Impact (2023)	Present Value of Impact (\$ millions)	
		3% Discount Rate	7% Discount Rate
Cargo Handling	-\$20	-\$274	-\$98
Shipping Rate (from Modal Shift)	-\$56	-\$750	-\$269
Emissions	-\$3	-\$35	-\$13
Accidents	-\$17	-\$223	-\$80
O&M	-\$5	-\$67	-\$24
Congestion	-\$2	-\$29	-\$11
<b>Total</b>	<b>-\$74</b>	<b>-\$1,379</b>	<b>-\$495</b>

**Table EA-20. Cargo-Related Impacts (Costs), Near Lake Alternative, Millions of 2010 Dollars**

Cost	First-Year Impact (2027)	Present Value of Impact (\$ millions)	
		3% Discount Rate	7% Discount Rate
Cargo Handling	-\$20	-\$308	-\$99
Shipping Rate (from Modal Shift)	-\$56	-\$843	-\$272
Emissions	-\$3	-\$39	-\$13
Accidents	-\$17	-\$250	-\$81
O&M	-\$5	-\$75	-\$24
Congestion	-\$2	-\$33	-\$11
<b>Total</b>	<b>-\$103</b>	<b>-\$1,549</b>	<b>-\$499</b>

## **TRANSPORTATION (RECREATIONAL BOATING)**

All three separation alternatives would affect recreational boating on the CAWS. The three impact categories are:

- Additional time for recreational boats to cross the barriers.
- Time savings for recreational boaters after the locks are removed (Down River and Mid-System Alternatives) plus induced recreational boat trips due to open access between the Chicago River and Lake Michigan (Down River and Mid-System Alternatives).
- Marina relocation costs for recreational boaters who move to lakeside marinas to avoid lifts over the barriers.

Under the baseline condition with new marina developments lakeside, it is expected that most recreational boats would move to new marinas lakeside in the future, and therefore fewer recreational boats would cross separation barriers in the future. In some instances as well, once the barriers are in place, some recreational boats that would not have moved to lakeside marinas in the baseline condition would instead switch to a lakeside marina to avoid the boat lifts and disinfection process.

For those recreational boats that do cross the barriers, there would be additional time-related cost impacts with the Mid-System and Near Lake Alternatives due to additional delay from the increased time to cross barriers using boat lifts versus the baseline condition of passing through the locks. The GLMRIS non-cargo assessment report estimates the average time to pass through the Chicago and T.J. O'Brien Locks to be 15 minutes (USACE-GLMRIS, 2011). It is estimated that the boat lifts would take an additional 30 minutes beyond the current lockage time and would have the capacity to transfer about 3,000 boats per year.

With this information we were able to estimate the recreational boat barrier crossing impact, as shown in Figure EA-31.

**Figure EA-31. Recreational Boat Barrier Crossing**

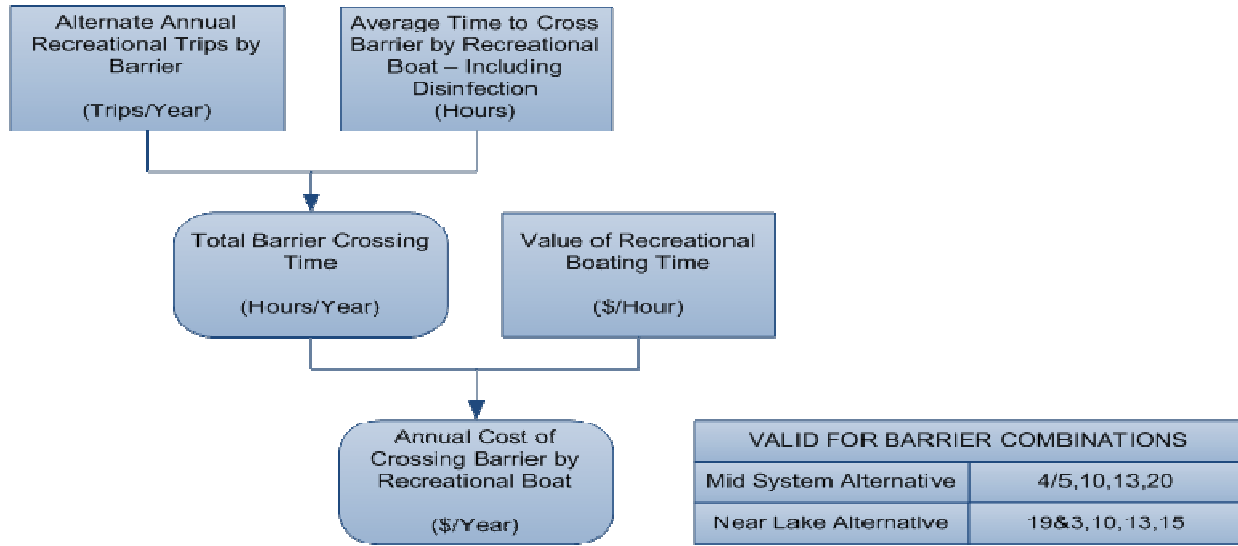

The time savings benefit for recreational boats monetizes the reduction in recreational travel time due to eliminating the current lockage times at the Chicago and T.J. O’Brien Locks. After separation, these locks would remain permanently open, thereby allowing quicker access to Lake Michigan and the CAWS. There would be no time savings benefit for recreational boats with the Near Lake Alternative, since these barriers would impede access to the lake.

The method used to estimate this impact is shown in Figure EA-32.

**Figure EA-32. Recreational Boat Time Savings**

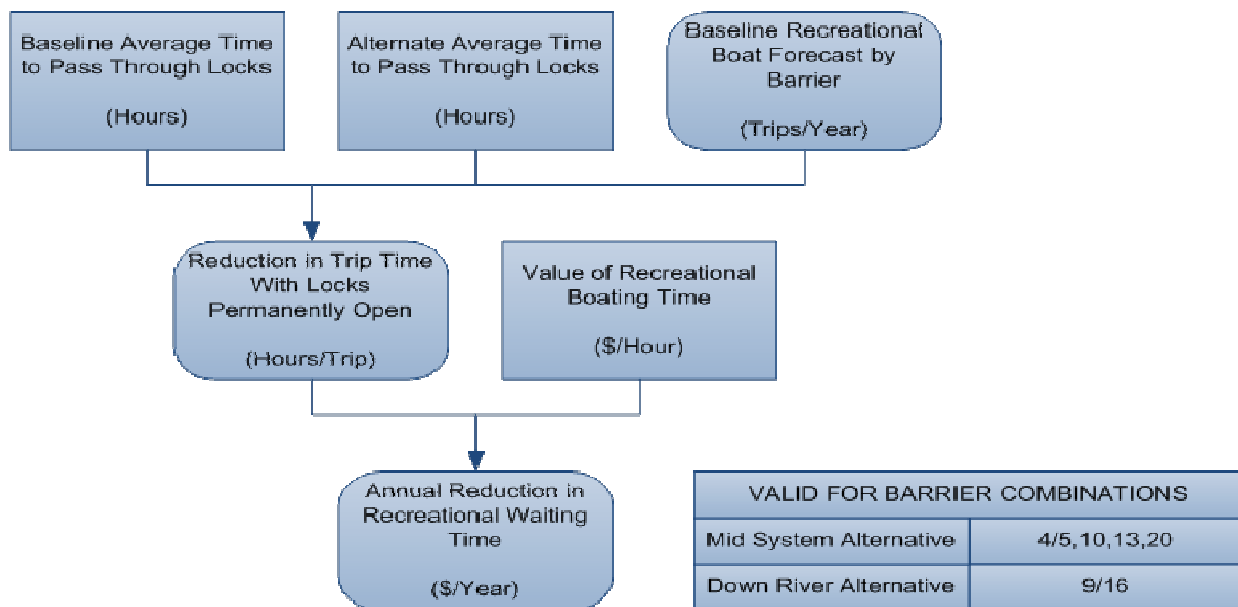



The open access between the Chicago River and Lake Michigan would induce some recreational boats to go into the Chicago River from Lake Michigan (and vice versa), thereby providing additional economic value. If the open access decreases recreational travel time by 30 minutes, and the average recreational boat trip time is 4 hours, this decreases trip time by 12.5%. Reduction in trip time can be taken as a cost saving to recreational boaters. Assuming a unitary price elasticity of demand for recreational activity, there would be an induced 12.5% increase in recreational boating trips on the CAWS. The induced economic benefit has been included in the time savings impact for recreational boats.

While the gates at the Wilmette Pump Station would remain open under the separation alternatives, the gates would not allow recreational boats to move between the river and the lake. Removing this structure would allow enhanced lake access and would potentially provide an opportunity to develop new harbors, marinas, and recreational fishing opportunities.

The cost impact for relocating the marina assumes that recreational boaters who are not willing or able to use the boat lifts would be required to relocate to marinas if they wish to continue to have access to Lake Michigan. It was assumed that the number of boaters affected would be equal to the total annual lockages through the Chicago and T.J. O’Brien Locks minus the total annual capacity of the boat lifts after separation. It was assumed that there would be no CAWS marinas downstream of the Lockport Lock, and, as a result, there would be no marina relocation impact with the Down River Alternative.

The methodology used to estimate this impact is shown in Figure EA-33.

**Figure EA-33. Marina Relocation Impact**

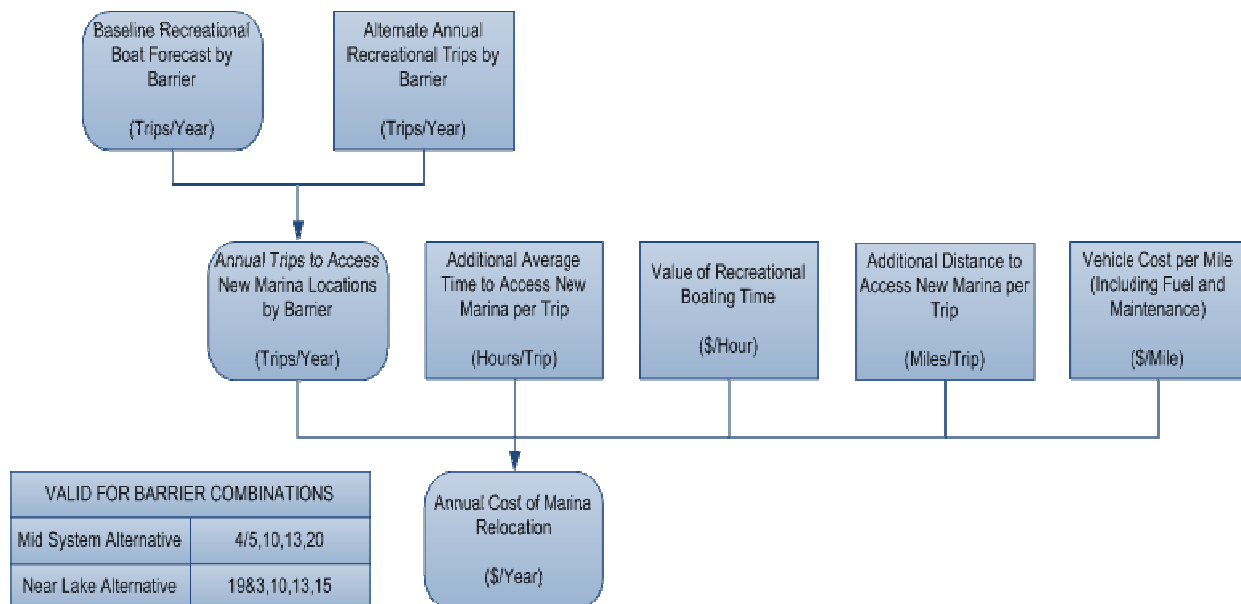

The assumptions used in the calculation of recreational boating impacts are shown below in Table EA-21.

**Table EA-21. Input Assumptions for Recreational Boating**

Variable Name	Unit	Value	Source
Baseline Annual Recreational Lockages - Chicago Lock	Trips/Year	23,923	HDR Calculated. Based on 2006-2010 average of lockage values.
Baseline Annual Recreational Lockages - O'Brien Lock	Trips/Year	15,179	GLMRIS. Baseline Assessment of Non-Cargo CAWS Traffic. USACE. September 2011.
Baseline Annual Recreational Lockages - Lockport Lock	Trips/Year	770	
Annual Recreational Boat Forecast Growth Rate	%	0%	HDR Estimate.
Alternate Annual Recreational Trips by Barrier	Trips/Year	3,000	Estimate provided by Vickerman.
Average Time to Cross Barrier by Recreational Boat - Including Disinfection	Hours	0.75	HDR Estimate. Based on RAP session notes. 30 minutes more than time to pass through the locks.
Average Time to Pass Through Locks	Hours	0.25	GLMRIS. Baseline Assessment of Non-Cargo CAWS Traffic. USACE. September 2011.
Value of Recreational Boating Time	\$/Hour	\$69	HDR Calculated. Based on average spending per boat day of \$275 for boats larger than 40 ft. Assumed 4 hour average recreational boat trip duration.  Great Lakes Recreational Boating's Economic Punch. Great Lakes Commission.
Additional Average Time to Access New Marina per Trip	Hours/Trip	0.75	HDR Estimate.
Additional Distance to Access New Marina per Trip	Miles/Trip	10	HDR Estimate.
Vehicle Cost per Mile (Including Fuel and Maintenance)	\$/Mile	\$0.114	FHWA. Asset Management: Highway Economics Requirements System. 1997. Adjusted to 2010 dollars.

In Table EA-22, Table EA-23 and Table EA-24, negative values represent a cost and positive values represent a benefit.

**Table EA-22. Recreational Boating Impacts, Down River Alternative, Millions of 2010 Dollars**

Impact	First-Year Impact (2023)	Present Value of Impact (\$ millions)	
		3% Discount Rate	7% Discount Rate
Recreational Boat Barrier Crossing	\$0.0	\$0.0	\$0.0
Recreational Boat Time Savings	\$0.8	\$11.8	\$4.4
Marina Relocation	\$0.0	\$0.0	\$0.0
<b>Total</b>	<b>\$0.7</b>	<b>\$11.8</b>	<b>\$4.4</b>

**Table EA-23. Recreational Boating Impacts, Mid-System Alternative, Millions of 2010 Dollars**

Impact	First-Year Impact (2023)	Present Value of Impact (\$ millions)	
		3% Discount Rate	7% Discount Rate
Recreational Boat Barrier Crossing	-\$0.2	-\$3.2	-\$1.2
Recreational Boat Time Savings	\$0.5	\$7.2	\$2.7
Marina Relocation	-\$1.7	-\$27.1	-\$10.2
<b>Total</b>	<b>-\$1.5</b>	<b>-\$23.9</b>	<b>-\$11.4</b>

**Table EA-24. Recreational Boating Impacts, Near Lake Alternative, Millions of 2010 Dollars**

Impact	First-Year Impact (2027)	Present Value of Impact (\$ millions)	
		3% Discount Rate	7% Discount Rate
Recreational Boat Barrier Crossing	-\$0.2	-\$2.7	-\$0.9
Recreational Boat Time Savings	\$0.0	\$0.0	\$0.0
Marina Relocation	-\$1.7	-\$22.6	-\$7.5
<b>Total</b>	<b>-\$1.9</b>	<b>-\$25.3</b>	<b>-\$8.4</b>

**TRANSPORTATION (COMMERCIAL TOURS)**

The Down River and Mid-System Alternatives would improve access to the lake for commercial tours, since the locks at the lakefront would no longer be necessary and the large amount of traffic could flow freely between the two bodies of water. There are also possible increases in traffic and revenues for the tour boat operators.

The Near Lake Alternative would disrupt service for tour operators that traverse both the river and the lake, and they might need additional vessels to maintain their current level of service. The locations of barriers with the Down River and Mid-System Alternatives are not expected to affect the routes of water taxis or commercial tour operators.

For the Near Lake Alternative, people taking tours of both the lake and the river would have to transfer from a riverside tour boat to a lakeside tour boat, but it is expected that the time involved would be similar to that of a lockage in the baseline condition. There might still be an inconvenience factor for people taking the tours. Water taxis should not be affected, since they do not go onto Lake Michigan.

The impact of the Near Lake Alternative has been monetized to provide an order of magnitude estimate of the potential impact on commercial tour operators.

**Figure EA-34. S&L for Additional Commercial Tour Vessels**

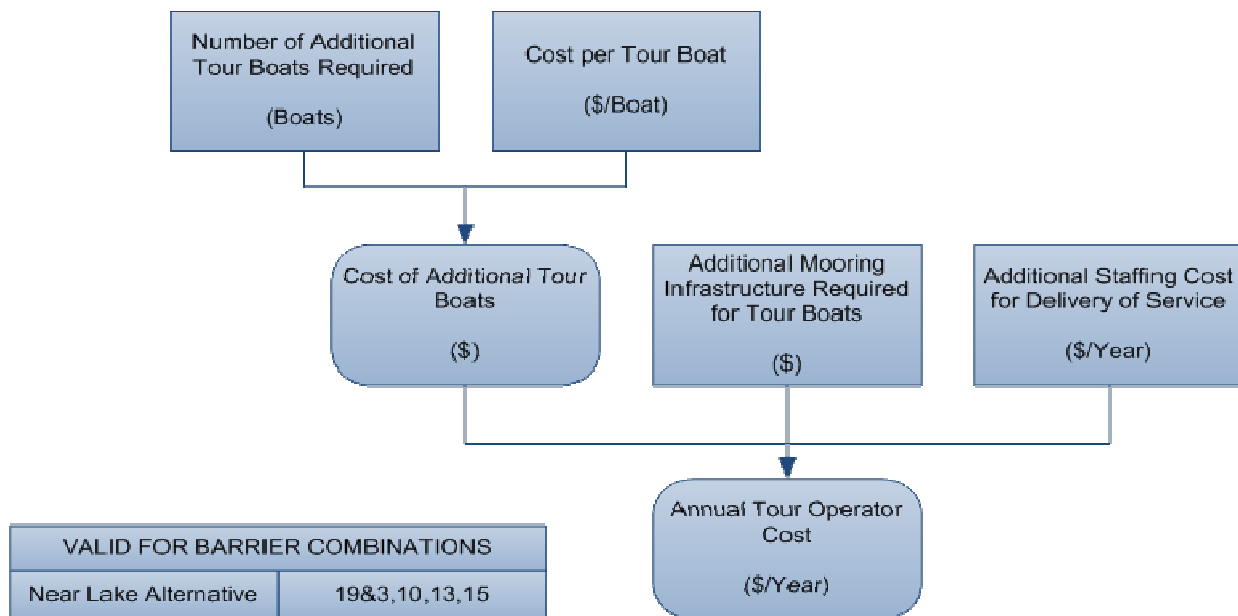

The impact of the Near Lake Alternative has been monetized (Table EA-26) to provide an order-of-magnitude estimate of the potential impact on commercial tour operators. The first-year impact on tour operators is significantly higher than for subsequent years, since it accounts for purchasing new tour vessels and additional mooring infrastructure. The following years until

2059 have only staffing costs for providing the tour service. The assumptions used in the calculation of commercial tour impacts are shown below in Table EA-25.

**Table EA-25. Input Assumptions for Commercial Tour Vessels**

Variable Name	Unit	Value	Source
Number of Additional Tour Boats Required	Boats	5	HDR Estimate. Based on assumption that each of the 5 tour operators in the Chicago area requires an additional tour boat.
Cost per Tour Boat	\$/Boat	\$3,000,000	Based on information provided by Mike Borgstrom at Wendella Tours.
Additional Mooring Infrastructure Required for Tour Boats	\$/Boat	\$150,000	Estimated to be same cost requirement as public safety vessel infrastructure cost from DePaul study.  DePaul University: An Analysis of the Economic Effects of Terminating Operations at the Chicago River Controlling Works and O'Brien Locks on the Chicago Area Waterway System. April 2010.
Additional Staffing Cost for Delivery of Service	\$/Boat	\$56,000	Based on 6 months of tour boat operation per year, one captain and one tour guide.  BLS. Transportation and Material Moving Occupations. Chicago-Naperville-Joliet, IL Metropolitan Division.

**Table EA-26. Commercial Tour Impacts (Costs), Near Lake Alternative, Millions of 2010 Dollars**

Cost	First-Year Impact (2027)	Present Value of Impact (\$M)	
		3% Discount Rate	7% Discount Rate
Annual Tour Operator Costs	-\$16.3	-\$13.2	-\$6.2
<b>Total</b>	<b>-\$16.3</b>	<b>-\$13.2</b>	<b>-\$6.2</b>

**TRANSPORTATION (PUBLIC SAFETY AND SECURITY)**

The Mid-System and Near Lake Alternatives would restrict the operation of emergency vessels and necessitate additional emergency vessels on each side of the separation barriers for the Chicago police and fire departments. However, with additional vessels on each side, the travel time to reach emergencies would decrease and more coverage would be provided for the area.

The impact of the Near Lake and Mid-System Alternatives has been monetized to provide an order of magnitude estimate of the potential impact on CPD and CFD using the S&L model in Figure EA-35. It has been assumed that there is no requirement for additional staffing and that there is only a cost impact in the first year of barrier implementation for additional vessels and mooring infrastructure.

**Figure EA-35. S&L for Additional Public Safety Vessels**

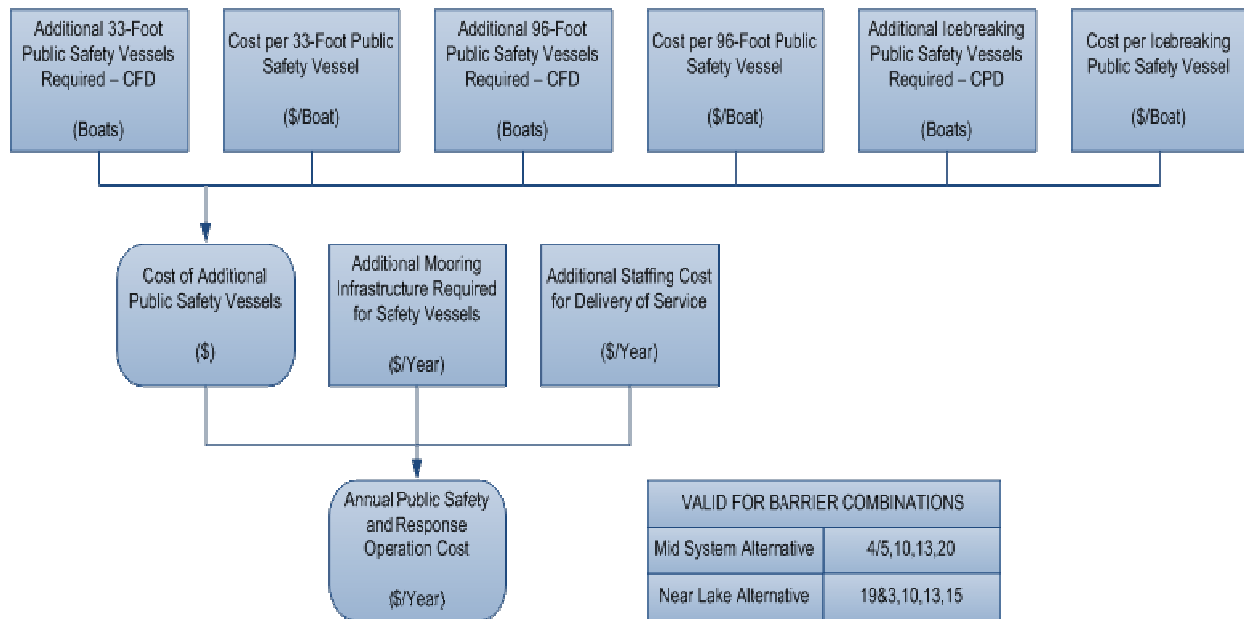

Assumptions for the public safety and security related impacts are provided in shown below in Table EA-27.

**Table EA-27. Public Safety and Response Input Assumptions**

Variable Name	Unit	Value	Source
Additional 33-Foot Public Safety Vessels Required - Chicago Fire Department	Boats	1	DePaul University: An Analysis of the Economic Effects of Terminating Operations at the Chicago River Controlling Works and O'Brien Locks on the Chicago Area Waterway System. April 2010.
Cost per 33-Foot Public Safety Vessel - CFD	\$	\$350,000	DePaul University: An Analysis of the Economic Effects of Terminating Operations at the Chicago River Controlling Works and O'Brien Locks on the Chicago Area Waterway System. April 2010. Cost of adding an additional 33-foot CFD vessel.
Additional 96-Foot Public Safety Vessels Required - Chicago Fire Department	Boats	1	
Cost per 96-Foot Public Safety Vessel - CFD	\$	\$2,760,000	DePaul University: An Analysis of the Economic Effects of Terminating Operations at the Chicago River Controlling Works and O'Brien Locks on the Chicago Area Waterway System. April 2010. Cost of adding an additional 96-foot CFD vessel.
Additional Icebreaking Public Safety Vessels Required - Chicago Police Department	Boats	1	
Cost per Icebreaking Public Safety Vessel - CPD	\$	\$1,000,000	DePaul University: An Analysis of the Economic Effects of Terminating Operations at the Chicago River Controlling Works and O'Brien Locks on the Chicago Area Waterway System. April 2010. Ice-breaking watercraft required due to barriers. Currently the CPD houses eight boats, including two 31-foot Defender Class safeboats. The CPD Marine unit patrols 81 miles of lakefront and 27 miles of the riverway within the city limits, and use the lock system several times a day.
Additional Mooring Infrastructure Required for Safety Vessels - Chicago Fire Department	\$	\$150,000	DePaul University: An Analysis of the Economic Effects of Terminating Operations at the Chicago River Controlling Works and O'Brien Locks on the Chicago Area Waterway System. April 2010.
Additional Mooring Infrastructure Required for Safety Vessels - Chicago Police Department	\$	\$150,000	Additional capital costs to prepare facilities for changes.



**Table EA-28. Impacts Related to Public Safety and Security (Costs), Mid-System Alternative, Millions of 2010 Dollars**

Cost	First-Year Impact (2023)	Present Value of Impact (\$M)	
		3% Discount Rate	7% Discount Rate
Annual Public Safety and Response Operation Cost	-\$4.4	-\$3.0	-\$1.8
<b>Total</b>	<b>-\$4.4</b>	<b>-\$3.0</b>	<b>-\$1.8</b>

**Table EA-29. Impacts Related to Public Safety and Security (Costs), Near Lake Alternative, Millions of 2010 Dollars**

Cost	First-Year Impact (2027)	Present Value of Impact (\$M)	
		3% Discount Rate	7% Discount Rate
Annual Public Safety and Response Operation Cost	-\$4.4	-\$2.7	-\$1.4
<b>Total</b>	<b>-\$4.4</b>	<b>-\$2.7</b>	<b>-\$1.4</b>

**LOCKPORT POWER IMPACTS**

Power generation potential at the Lockport Powerhouse will be reduced in each of the alternatives as there will be reduced flow downstream. The loss of power generation is monetized at \$3.75 million per year.

**Table EA-30. Input Assumptions for Lockport Power Impacts**

Variable Name	Unit	Value	Source
Impact on Lockport Power	\$/Year	\$3,750,000	HDR Estimate.

**Table EA-31. Lockport Power Generation Impacts (Costs), Mid-System and Down River Alternatives, Millions of 2010 Dollars**

Impact	First-Year Impact (2027)	Present Value of Impact (\$M)	
		3% Discount Rate	7% Discount Rate
Impact on Lockport Power	-\$3.8	-\$58.3	-\$21.8
<b>Total</b>	<b>-\$3.8</b>	<b>-\$58.3</b>	<b>-\$21.8</b>

**Table EA-32. Lockport Power Generation Impacts (Costs), Near Lake Alternative, Millions of 2010 Dollars**

Impact	First-Year Impact (2027)	Present Value of Impact (\$M)	
		3% Discount Rate	7% Discount Rate
Impact on Lockport Power	-\$3.8	-\$48.5	-\$16.2
<b>Total</b>	<b>-\$3.8</b>	<b>-\$48.5</b>	<b>-\$16.2</b>

## J. SUMMARY OF FINDINGS AND CBA OUTCOMES

Given the grouping of quantifiable and unquantifiable benefits, these benefits have been summarized in a *multiple accounts economics framework* (defined as an evaluation framework where the effects of a project are divided into “accounts” to show different perspectives). This may include qualitative and quantitative criteria. The relative importance of each criteria, and account, may be determined by decision makers.

The following are the *key highlights* of the economic analysis:

- The cost of constructing the physical barriers is a small portion (less than or equal to 3%) of the total project investments of the alternatives.
- In general, it appears that the Mid-System Alternative is the most cost-effective alternative for separation, with median costs of about \$3.3 billion to \$4.3 billion.
- Future effluent standards and regulations for WWTPs are uncertain and add considerable uncertainty to the actual investment levels required for implementing an alternative.
- The magnitude of potentially the largest expected benefit, reduced AIS risk and damage, is not quantifiable based on the data that is currently available. That being said, a basic case study analysis demonstrates that these benefits can be significant.
- Other potential benefits, such as reduced flood risk and water quality improvements, are also not quantifiable based on the available data and modeling available at this time, but they are important potential benefits.
- There are cost-avoidance benefits for each of the separation alternatives of more than \$100 million over the study lifecycle from closing locks and stopping AIS-related research and prevention once the barrier(s) is (are) in place.
- While there would be many different impacts from each alternative, the biggest impact would be on cargo that is currently moved on the CAWS via barge. Separation would result in extra handling of cargo and would likely shift some cargo to other modes of transportation at an economic cost of \$1.3 billion to \$1.5 billion over the life of the project, or about \$35 million to \$50 million per year. Even with a small modal shift, the economic impact can be large because barge transportation is much cheaper than other modes.
- The new port facilities could help facilitate economic benefits for the Chicago area in the future. The potential for container-on-barge benefits alone has been valued at \$400 million.
- Other impacts, such as recreational boating, commercial tour boats, and public safety, are relevant to the various stakeholders. However, the scale of these impacts is small *relative* to the major impacts identified above. The Near Lake Alternative would likely pose the greatest challenges for these stakeholders.

- In general, the investments required to implement any separation alternative would be localized in the Chicago area, while the benefits of reduced economic damage due to AIS would be broad-based and would span the Great Lakes and Mississippi River basins. This lack of symmetry between costs and benefits suggests a justification for supplementary regional, national, and/or international (Canadian) funding sources.

Table EA-33 summarizes the results of the cost and benefit analysis for each of the separation alternatives. Quoted estimates represent lifecycle impacts discounted at a 3% discount rate.

**Table EA-33. Summary of Cost and Benefit Impacts, Present Value over the Study Lifecycle Using a 3% Discount Rate**

Impact	Monetized or Qualified	Cost or Benefit	Down River	Mid-System	Near Lake
Benefits of reducing the risk of AIS transfer between both basins.	Q	B	The reduction of a single AIS transfer can potentially result in significant economic benefits of billions of dollars over the project lifecycle.		
Economic benefits associated with new COB potential associated with the new port developments.	M	B	\$0.4 billion	\$0.4 billion	\$0.4 billion
Benefits of eliminating the requirement for lift bridges to be raised, thereby reducing delay for trains, cars, and pedestrians.	Q	B	No impact	No impact	Reduced delay from lift bridges
For the areas of the CAWS that are opened to Lake Michigan, water quality would be improved (for the Moderate River to Stringent Lake Scenario and the Moderate River to Moderate Lake Scenario).	Q	B	Improved water quality	Improved water quality	No impact
Flood-management investments would provide local flooding benefits and green infrastructure-related benefits.	Q	B	Potential for local flood reduction and green infrastructure benefits.		
Cost avoidance associated with AIS monitoring and lock operations.	M	B	\$125 million	\$125 million	\$105 million
Project costs associated with all investments.	M	C	\$3.9 billion – \$9.5 billion	\$3.3 billion – \$4.3 billion	\$9.5 billion
Additional costs associated with modal shift from barge to other modes, and additional cargo handling for cargo that stays on the CAWS.	M	C	\$1.3 billion	\$1.4 billion	\$1.5 billion
Net additional costs associated with recreational boating: movements over the barrier, relocation of marinas to lakeside, time savings, and induced recreational boating trips.	M	C	\$10 million	\$25 million	\$25 million
The barriers for the Near Lake Alternative would disrupt commercial tours and cruises that provide tours that go on both the Chicago River and Lake Michigan.	M	C	No impact	No impact	\$15 million
The barriers for the Near Lake and Mid-System Alternatives would restrict access for public safety and security vessels, thereby requiring additional vessels.	M	C	No impact	\$5 million	\$5 million
Reduced power generation at Lockport Powerhouse.	M	C	\$60 million	\$60 million	\$50 million

Note: Estimates in millions are rounded to the nearest \$5-million increment.

## **K. OTHER ECONOMIC CONSIDERATIONS**

Other considerations are relevant to the discussion of the separation alternatives outside the context of the impacts discussed in the cost and benefit analysis. These are addressed below.

### **DIRECT, INDIRECT, AND INDUCED ECONOMIC IMPACT OF PROJECT INVESTMENTS**

While not considered in the CBA, separation would require significant investments in new infrastructure and a stimulus that would have impacts throughout the local, state, and national economies. The project investments would add jobs locally and throughout the United States related to the construction and ongoing operation and maintenance of the infrastructure investments. These jobs would reflect the impact of the direct investments plus the related economic spinoff and would represent full-time and part-time jobs created for a full year.

Over the project lifecycle, the Down River Alternative is estimated to generate about 360,000 person-years of employment, the Mid-System Alternative about 140,000 person-years of employment, and the Near Lake Alternative about 310,000 person-years of employment.<sup>8</sup> A person-year represents 1 year of employment for one person. These estimates, which should be considered order-of-magnitude estimates, are meant to provide a macro-level assessment of potential employment as a result of construction and ongoing operation and maintenance activities.

### **WILLINGNESS TO PAY FOR SEPARATION**

Two key observations of this economic analysis of separation alternatives in the CAWS are:

- The investments required for any of the separation alternatives and expenditures related to improving flood management, water quality, and transportation are easier to quantify than the benefits, even at an order-of-magnitude level of analysis. Quantifying benefits for major areas such as AIS risk reduction, flood management, and water quality require a level of primary research and detailed modeling that was not possible.
- The investments required for any of the separation alternatives and expenditures related to improving flood management, water quality, and transportation are local to the Chicago area. However, the largest expected benefit, AIS risk reduction, would occur primarily outside the Chicago area.

These two factors make it a challenge to assess the value to society of separation and the related improvements. A useful way of putting the overall investments in perspective or providing a “reasonableness” test is examining the project investments from the perspective of

---

<sup>8</sup> The Minnesota IMPLAN Group’s input-output model was used to estimate the direct, indirect, and induced effects.

what society would have to be willing to pay to reduce the risk of AIS transfer between the basins. If society is willing to pay an amount, in aggregate, that exceeds the cost of separation, then there is a net economic benefit based on how individuals value this reduced risk of AIS transfer.

Based on the estimate of project investments for each alternative, this analysis estimates what society (households) would have to be willing to pay annually to at least cover the investments associated with separation and the related improvements (Table EA-34). The annual willingness-to-pay figures for the regions that would receive project benefits, namely the Great Lakes and Mississippi River basins, are estimated. These figures provide an estimate of how much households would have to be willing to pay annually starting in 2012 in order to cover the project investments for each alternative.

**Table EA-34. Annual Willingness-to-Pay Estimates**

	Down River	Mid-System	Near Lake
Project Investments ( <i>Moderate River to Stringent Lake WWTP scenarios, which are highest cost</i> )	\$9.50 billion	\$4.27 billion	\$9.54 billion
<b>Annual Willingness to Pay Required by:</b>			
Great Lakes Basin Households Only to 2059	\$24.50	\$11.01	\$24.60
Great Lakes Basin Households to Perpetuity	\$18.57	\$8.35	\$18.65
Great Lakes and Mississippi River Basin Households to 2059	\$8.74	\$3.93	\$8.77
Great Lakes and Mississippi River Basin Households to Perpetuity	\$6.62	\$2.98	\$6.65

The analysis reveals that households in the Great Lakes basin (U.S. and Canada) would have to be willing to pay, on average, about \$1 a month or about \$11 annually from now through 2059 for the Mid-System Alternative. If the Mississippi River basin is included as well, households would have to be willing to pay about \$0.33 a month (or \$3.93 annually) in order for the alternative to provide net economic benefits. While it is not known at this time whether households are, in fact, willing to pay these amounts for AIS risk reduction, these estimates provide a reference point for discussion, and future studies can determine whether society is actually willing to pay these amounts.

Similarly, for the Near Lake and Down River Alternatives, households in the Great Lakes and Mississippi River basins would have to be willing to pay, on average, almost \$9 per year or about \$0.75 per month.

Conducting a study to determine how much society is willing to pay for separation to reduce the risk of AIS transfer between basins is a logical next step for decision-makers to consider.

ATTACHMENT I

**Table EA-35. Moderate River to Stringent Lake, Cash Flows for all Separation Alternatives**

Near Lake - Project Cash Flows (\$ Billions)	Annual Cost																					
	2012	2013	2014	2015	2016	2017	2018	2019	2020	2021	2022	2023	2024	2025	2026	2027	2028	2029	2030	2031	..	2059
Transportation	\$0.01	\$0.01	\$0.01	\$0.01	\$0.01	\$0.01	\$0.01	\$0.01	\$0.01	\$0.01	\$0.01	\$1.22	\$1.27	\$1.27	\$1.27	\$0.16	\$0.16	\$0.16	\$0.16	\$0.16	\$0.16	\$0.16
Flood Management	\$0.11	\$0.14	\$0.14	\$0.32	\$0.32	\$0.32	\$0.38	\$0.38	\$0.35	\$0.35	\$0.35	\$0.25	\$0.25	\$0.28	\$0.28	\$0.25	\$0.28	\$0.28	\$0.08	\$0.08	\$0.08	\$0.08
Water Quality (Moderate River to Stringent Lake)	\$0	\$0	\$0	\$0	\$0	\$0	\$0	\$0	\$0	\$0.06	\$0.06	\$0	\$0	\$0	\$0	\$0	\$0	\$0	\$0	\$0	\$0	\$0
Barriers	\$0	\$0	\$0	\$0	\$0	\$0	\$0	\$0	\$0	\$0	\$0	\$0	\$0.02	\$0.07	\$0.07	\$0.02	\$0.02	\$0.02	\$0	\$0	\$0	\$0
<b>TOTAL</b>	<b>\$0.12</b>	<b>\$0.16</b>	<b>\$0.16</b>	<b>\$0.33</b>	<b>\$0.33</b>	<b>\$0.33</b>	<b>\$0.39</b>	<b>\$0.39</b>	<b>\$0.36</b>	<b>\$0.42</b>	<b>\$0.42</b>	<b>\$1.48</b>	<b>\$1.54</b>	<b>\$1.62</b>	<b>\$1.62</b>	<b>\$0.43</b>	<b>\$0.46</b>	<b>\$0.46</b>	<b>\$0.24</b>	<b>\$0.24</b>	<b>\$0.24</b>	<b>\$0.24</b>

Mid-System - Project Cash Flows (\$ Billions)	Annual Cost																					
	2012	2013	2014	2015	2016	2017	2018	2019	2020	2021	2022	2023	2024	2025	2026	2027	2028	2029	2030	2031	..	2059
Transportation	\$0.01	\$0.01	\$0.01	\$0.01	\$0.01	\$0.01	\$0.01	\$0.18	\$0.18	\$0.25	\$0.25	\$0.02	\$0.02	\$0.02	\$0.02	\$0.02	\$0.02	\$0.02	\$0.02	\$0.02	\$0.02	\$0.02
Flood Management	\$0.09	\$0.13	\$0.13	\$0.13	\$0.13	\$0.13	\$0.19	\$0.19	\$0.17	\$0.22	\$0.23	\$0.08	\$0.08	\$0.08	\$0.08	\$0.08	\$0.08	\$0.08	\$0.08	\$0.08	\$0.08	\$0.08
Water Quality (Moderate River to Stringent Lake)	\$0	\$0	\$0	\$0	\$0	\$0.08	\$0.08	\$0	\$0	\$0	\$0	\$0.09	\$0.09	\$0.09	\$0.09	\$0.09	\$0.09	\$0.09	\$0.06	\$0.06	\$0.06	\$0.06
Barriers	\$0	\$0	\$0	\$0	\$0	\$0	\$0	\$0.02	\$0.06	\$0.08	\$0.08	\$0	\$0	\$0	\$0	\$0	\$0	\$0.01	\$0	\$0	\$0	\$0
<b>TOTAL</b>	<b>\$0.10</b>	<b>\$0.14</b>	<b>\$0.14</b>	<b>\$0.14</b>	<b>\$0.14</b>	<b>\$0.22</b>	<b>\$0.28</b>	<b>\$0.40</b>	<b>\$0.42</b>	<b>\$0.56</b>	<b>\$0.56</b>	<b>\$0.19</b>	<b>\$0.19</b>	<b>\$0.19</b>	<b>\$0.19</b>	<b>\$0.19</b>	<b>\$0.19</b>	<b>\$0.20</b>	<b>\$0.16</b>	<b>\$0.16</b>	<b>\$0.16</b>	<b>\$0.16</b>

Down River - Project Cash Flows (\$ Billions)	Annual Cost																					
	2012	2013	2014	2015	2016	2017	2018	2019	2020	2021	2022	2023	2024	2025	2026	2027	2028	2029	2030	2031	..	2059
Transportation	\$0.01	\$0.01	\$0.01	\$0.01	\$0.01	\$0.01	\$0.01	\$0.17	\$0.17	\$0.17	\$0.17	\$0.00	\$0.00	\$0.00	\$0.00	\$0.00	\$0.00	\$0.00	\$0.00	\$0.00	\$0.00	\$0.00
Flood Management	\$0.10	\$0.14	\$0.14	\$0.14	\$0.14	\$0.14	\$0.20	\$0.20	\$0.32	\$0.32	\$0.33	\$0.23	\$0.23	\$0.27	\$0.27	\$0.27	\$0.27	\$0.27	\$0.08	\$0.08	\$0.08	\$0.08
Water Quality (Moderate River to Stringent Lake)	\$0	\$0	\$0	\$0	\$0	\$0.13	\$0.13	\$0	\$0	\$0	\$0	\$0.43	\$0.43	\$0.43	\$0.43	\$0.43	\$0.43	\$0.43	\$0.33	\$0.33	\$0.33	\$0.33
Barriers	\$0	\$0	\$0	\$0	\$0	\$0	\$0	\$0.01	\$0.01	\$0.06	\$0.06	\$0	\$0	\$0	\$0	\$0	\$0	\$0.01	\$0	\$0	\$0	\$0
<b>TOTAL</b>	<b>\$0.11</b>	<b>\$0.14</b>	<b>\$0.14</b>	<b>\$0.14</b>	<b>\$0.15</b>	<b>\$0.27</b>	<b>\$0.33</b>	<b>\$0.38</b>	<b>\$0.51</b>	<b>\$0.55</b>	<b>\$0.56</b>	<b>\$0.66</b>	<b>\$0.66</b>	<b>\$0.70</b>	<b>\$0.70</b>	<b>\$0.71</b>	<b>\$0.71</b>	<b>\$0.72</b>	<b>\$0.42</b>	<b>\$0.42</b>	<b>\$0.42</b>	<b>\$0.42</b>



**Table EA-36. Moderate River to Moderate Lake, Cash Flows for all Separation Alternatives**

Near Lake - Project Cash Flows (\$ Billions)	Annual Cost																					
	2012	2013	2014	2015	2016	2017	2018	2019	2020	2021	2022	2023	2024	2025	2026	2027	2028	2029	2030	2031	..	2059
Transportation	\$0.01	\$0.01	\$0.01	\$0.01	\$0.01	\$0.01	\$0.01	\$0.01	\$0.01	\$0.01	\$0.01	\$1.22	\$1.27	\$1.27	\$1.27	\$0.16	\$0.16	\$0.16	\$0.16	\$0.16	\$0.16	\$0.16
Flood Management	\$0.11	\$0.14	\$0.14	\$0.32	\$0.32	\$0.32	\$0.38	\$0.38	\$0.35	\$0.35	\$0.35	\$0.25	\$0.25	\$0.28	\$0.28	\$0.25	\$0.28	\$0.28	\$0.08	\$0.08	\$0.08	\$0.08
Water Quality (Moderate River to Moderate Lake)	\$0	\$0	\$0	\$0	\$0	\$0	\$0	\$0	\$0	\$0.06	\$0.06	\$0	\$0	\$0	\$0	\$0	\$0	\$0	\$0	\$0	\$0	\$0
Barriers	\$0	\$0	\$0	\$0	\$0	\$0	\$0	\$0	\$0	\$0	\$0	\$0	\$0.02	\$0.07	\$0.07	\$0.02	\$0.02	\$0.02	\$0	\$0	\$0	\$0
<b>TOTAL</b>	<b>\$0.12</b>	<b>\$0.16</b>	<b>\$0.16</b>	<b>\$0.33</b>	<b>\$0.33</b>	<b>\$0.33</b>	<b>\$0.39</b>	<b>\$0.39</b>	<b>\$0.36</b>	<b>\$0.42</b>	<b>\$0.42</b>	<b>\$1.48</b>	<b>\$1.54</b>	<b>\$1.62</b>	<b>\$1.62</b>	<b>\$0.43</b>	<b>\$0.46</b>	<b>\$0.46</b>	<b>\$0.24</b>	<b>\$0.24</b>	<b>\$0.24</b>	<b>\$0.24</b>

Mid-System - Project Cash Flows (\$ Billions)	Annual Cost																					
	2012	2013	2014	2015	2016	2017	2018	2019	2020	2021	2022	2023	2024	2025	2026	2027	2028	2029	2030	2031	..	2059
Transportation	\$0.01	\$0.01	\$0.01	\$0.01	\$0.01	\$0.01	\$0.01	\$0.18	\$0.18	\$0.25	\$0.25	\$0.02	\$0.02	\$0.02	\$0.02	\$0.02	\$0.02	\$0.02	\$0.02	\$0.02	\$0.02	\$0.02
Flood Management	\$0.09	\$0.13	\$0.13	\$0.13	\$0.13	\$0.13	\$0.19	\$0.19	\$0.17	\$0.22	\$0.23	\$0.08	\$0.08	\$0.08	\$0.08	\$0.08	\$0.08	\$0.08	\$0.08	\$0.08	\$0.08	\$0.08
Water Quality (Moderate River to Moderate Lake)	\$0	\$0	\$0	\$0	\$0	\$0.08	\$0.08	\$0	\$0	\$0	\$0	\$0.05	\$0.05	\$0.05	\$0.05	\$0.05	\$0.05	\$0.05	\$0.01	\$0.01	\$0.01	\$0.01
Barriers	\$0	\$0	\$0	\$0	\$0	\$0	\$0	\$0.02	\$0.06	\$0.08	\$0.08	\$0	\$0	\$0	\$0	\$0	\$0	\$0.01	\$0	\$0	\$0	\$0
<b>TOTAL</b>	<b>\$0.10</b>	<b>\$0.14</b>	<b>\$0.14</b>	<b>\$0.14</b>	<b>\$0.14</b>	<b>\$0.22</b>	<b>\$0.28</b>	<b>\$0.40</b>	<b>\$0.42</b>	<b>\$0.56</b>	<b>\$0.56</b>	<b>\$0.15</b>	<b>\$0.15</b>	<b>\$0.15</b>	<b>\$0.15</b>	<b>\$0.15</b>	<b>\$0.15</b>	<b>\$0.16</b>	<b>\$0.11</b>	<b>\$0.11</b>	<b>\$0.11</b>	<b>\$0.11</b>

Down River - Project Cash Flows (\$ Billions)	Annual Cost																					
	2012	2013	2014	2015	2016	2017	2018	2019	2020	2021	2022	2023	2024	2025	2026	2027	2028	2029	2030	2031	..	2059
Transportation	\$0.01	\$0.01	\$0.01	\$0.01	\$0.01	\$0.01	\$0.01	\$0.17	\$0.17	\$0.17	\$0.17	\$0.00	\$0.00	\$0.00	\$0.00	\$0.00	\$0.00	\$0.00	\$0.00	\$0.00	\$0.00	\$0.00
Flood Management	\$0.10	\$0.14	\$0.14	\$0.14	\$0.14	\$0.14	\$0.20	\$0.20	\$0.32	\$0.32	\$0.33	\$0.23	\$0.23	\$0.27	\$0.27	\$0.27	\$0.27	\$0.27	\$0.08	\$0.08	\$0.08	\$0.08
Water Quality (Moderate River to Moderate Lake)	\$0	\$0	\$0	\$0	\$0	\$0.13	\$0.13	\$0	\$0	\$0	\$0	\$0.19	\$0.19	\$0.19	\$0.19	\$0.19	\$0.19	\$0.19	\$0.05	\$0.05	\$0.05	\$0.05
Barriers	\$0	\$0	\$0	\$0	\$0	\$0	\$0	\$0.01	\$0.01	\$0.06	\$0.06	\$0	\$0	\$0	\$0	\$0	\$0	\$0.01	\$0	\$0	\$0	\$0
<b>TOTAL</b>	<b>\$0.11</b>	<b>\$0.14</b>	<b>\$0.14</b>	<b>\$0.14</b>	<b>\$0.15</b>	<b>\$0.27</b>	<b>\$0.33</b>	<b>\$0.38</b>	<b>\$0.51</b>	<b>\$0.55</b>	<b>\$0.56</b>	<b>\$0.42</b>	<b>\$0.42</b>	<b>\$0.46</b>	<b>\$0.46</b>	<b>\$0.46</b>	<b>\$0.46</b>	<b>\$0.47</b>	<b>\$0.13</b>	<b>\$0.13</b>	<b>\$0.13</b>	<b>\$0.13</b>

**Table EA-37. Stringent River to Stringent Lake, Cash Flows for all Separation Alternatives**

Near Lake - Project Cash Flows (\$ Billions)	Annual Cost																					
	2012	2013	2014	2015	2016	2017	2018	2019	2020	2021	2022	2023	2024	2025	2026	2027	2028	2029	2030	2031	..	2059
Transportation	\$0.01	\$0.01	\$0.01	\$0.01	\$0.01	\$0.01	\$0.01	\$0.01	\$0.01	\$0.01	\$0.01	\$1.22	\$1.27	\$1.27	\$1.27	\$0.16	\$0.16	\$0.16	\$0.16	\$0.16	\$0.16	\$0.16
Flood Management	\$0.11	\$0.14	\$0.14	\$0.32	\$0.32	\$0.32	\$0.38	\$0.38	\$0.35	\$0.35	\$0.35	\$0.25	\$0.25	\$0.28	\$0.28	\$0.25	\$0.28	\$0.28	\$0.08	\$0.08	\$0.08	\$0.08
Water Quality (Stringent River to Stringent Lake)	\$0	\$0	\$0	\$0	\$0	\$0	\$0	\$0	\$0	\$0.06	\$0.06	\$0.00	\$0	\$0	\$0	\$0	\$0	\$0	\$0	\$0	\$0	\$0
Barriers	\$0	\$0	\$0	\$0	\$0	\$0	\$0	\$0	\$0	\$0	\$0	\$0	\$0.02	\$0.07	\$0.07	\$0.02	\$0.02	\$0.02	\$0	\$0	\$0	\$0
<b>TOTAL</b>	<b>\$0.12</b>	<b>\$0.16</b>	<b>\$0.16</b>	<b>\$0.33</b>	<b>\$0.33</b>	<b>\$0.33</b>	<b>\$0.39</b>	<b>\$0.39</b>	<b>\$0.36</b>	<b>\$0.42</b>	<b>\$0.42</b>	<b>\$1.48</b>	<b>\$1.54</b>	<b>\$1.62</b>	<b>\$1.62</b>	<b>\$0.43</b>	<b>\$0.46</b>	<b>\$0.46</b>	<b>\$0.24</b>	<b>\$0.24</b>	<b>\$0.24</b>	<b>\$0.24</b>

Mid-System - Project Cash Flows (\$ Billions)	Annual Cost																					
	2012	2013	2014	2015	2016	2017	2018	2019	2020	2021	2022	2023	2024	2025	2026	2027	2028	2029	2030	2031	..	2059
Transportation	\$0.01	\$0.01	\$0.01	\$0.01	\$0.01	\$0.01	\$0.01	\$0.18	\$0.18	\$0.25	\$0.25	\$0.02	\$0.02	\$0.02	\$0.02	\$0.02	\$0.02	\$0.02	\$0.02	\$0.02	\$0.02	\$0.02
Flood Management	\$0.09	\$0.13	\$0.13	\$0.13	\$0.13	\$0.13	\$0.19	\$0.19	\$0.17	\$0.22	\$0.23	\$0.08	\$0.08	\$0.08	\$0.08	\$0.08	\$0.08	\$0.08	\$0.08	\$0.08	\$0.08	\$0.08
Water Quality (Stringent River to Stringent Lake)	\$0	\$0	\$0	\$0	\$0	\$0.08	\$0.08	\$0	\$0	\$0	\$0	\$0.00	\$0.00	\$0.00	\$0.00	\$0.00	\$0.00	\$0.00	\$0.00	\$0.00	\$0.00	\$0.00
Barriers	\$0	\$0	\$0	\$0	\$0	\$0	\$0	\$0.02	\$0.06	\$0.08	\$0.08	\$0	\$0	\$0	\$0	\$0	\$0	\$0.01	\$0	\$0	\$0	\$0
<b>TOTAL</b>	<b>\$0.10</b>	<b>\$0.14</b>	<b>\$0.14</b>	<b>\$0.14</b>	<b>\$0.14</b>	<b>\$0.22</b>	<b>\$0.28</b>	<b>\$0.40</b>	<b>\$0.42</b>	<b>\$0.56</b>	<b>\$0.56</b>	<b>\$0.10</b>	<b>\$0.11</b>	<b>\$0.11</b>	<b>\$0.11</b>	<b>\$0.11</b>	<b>\$0.11</b>	<b>\$0.12</b>	<b>\$0.11</b>	<b>\$0.11</b>	<b>\$0.11</b>	<b>\$0.11</b>

Down River - Project Cash Flows (\$ Billions)	Annual Cost																					
	2012	2013	2014	2015	2016	2017	2018	2019	2020	2021	2022	2023	2024	2025	2026	2027	2028	2029	2030	2031	..	2059
Transportation	\$0.01	\$0.01	\$0.01	\$0.01	\$0.01	\$0.01	\$0.01	\$0.17	\$0.17	\$0.17	\$0.17	\$0.00	\$0.00	\$0.00	\$0.00	\$0.00	\$0.00	\$0.00	\$0.00	\$0.00	\$0.00	\$0.00
Flood Management	\$0.10	\$0.14	\$0.14	\$0.14	\$0.14	\$0.14	\$0.20	\$0.20	\$0.32	\$0.32	\$0.33	\$0.23	\$0.23	\$0.27	\$0.27	\$0.27	\$0.27	\$0.27	\$0.08	\$0.08	\$0.08	\$0.08
Water Quality (Stringent River to Stringent Lake)	\$0	\$0	\$0	\$0	\$0	\$0.13	\$0.13	\$0	\$0	\$0	\$0	\$0.00	\$0.00	\$0.00	\$0.00	\$0.00	\$0.00	\$0.00	\$0.00	\$0.00	\$0.00	\$0.00
Barriers	\$0	\$0	\$0	\$0	\$0	\$0	\$0	\$0.01	\$0.01	\$0.06	\$0.06	\$0	\$0	\$0	\$0	\$0	\$0	\$0.01	\$0	\$0	\$0	\$0
<b>TOTAL</b>	<b>\$0.11</b>	<b>\$0.14</b>	<b>\$0.14</b>	<b>\$0.14</b>	<b>\$0.15</b>	<b>\$0.27</b>	<b>\$0.33</b>	<b>\$0.38</b>	<b>\$0.51</b>	<b>\$0.55</b>	<b>\$0.56</b>	<b>\$0.24</b>	<b>\$0.24</b>	<b>\$0.28</b>	<b>\$0.28</b>	<b>\$0.28</b>	<b>\$0.28</b>	<b>\$0.29</b>	<b>\$0.09</b>	<b>\$0.09</b>	<b>\$0.09</b>	<b>\$0.09</b>

**Table EA-38. Flood Management, Present Value over Project Lifecycle, Down River**

Barrier	Description	PV (\$ millions)	
		3%	7%
	Design/Permitting	\$169	\$138
	Sewer Separation	\$361	\$248
	Floodplain Storage on North Branch	\$289	\$221
	Tunnels to Lake - Chicago & Calumet	\$981	\$573
	Pump Station - Chicago	\$121	\$64
	Conveyance - Little Calumet	\$223	\$153
	Sewer Separation - O&M	\$7	\$3
	Floodplain Storage on North Branch - O&M	\$6	\$3
	Investment in Green Infrastructure - Stormwater	\$722	\$495
	Green Infrastructure - Stormwater O&M	\$103	\$43
	<b>TOTAL</b>	<b>\$2,984</b>	<b>\$1,941</b>

**Table EA-39. Flood Management, Present Value over Project Lifecycle, Mid-System**

Barrier	Description	PV (\$ millions)	
		3%	7%
	Design/Permitting	\$102	\$83
	Sewer Separation	\$361	\$248
	Floodplain Storage on North Branch	\$289	\$221
	Conveyance - Little Calumet	\$223	\$153
	Channel Conveyance	\$71	\$46
	Sewer Separation - O&M	\$7	\$3
	Floodplain Storage on North Branch - O&M	\$6	\$3
	Investment in Green Infrastructure - Stormwater	\$722	\$495
	Green Infrastructure - Stormwater O&M	\$104	\$43
	<b>TOTAL</b>	<b>\$1,886</b>	<b>\$1,295</b>

**Table EA-40. Flood Management, Present Value over Project Lifecycle, Near Lake**

Barrier	Description	PV (\$ millions)	
		3%	7%
	Design/Permitting	\$212	\$174
	Sewer Separation	\$361	\$248
	Floodplain Storage on North Branch	\$289	\$221
	Tunnel and Reservoir	\$1,838	\$1,204
	Conveyance - Little Calumet	\$223	\$153
	Channel Conveyance	\$61	\$32
	Sewer Separation - O&M	\$7	\$3
	Floodplain Storage on North Branch - O&M	\$6	\$3
	Investment in Green Infrastructure - Stormwater	\$722	\$495
	Green Infrastructure - Stormwater O&M	\$104	\$43
	<b>TOTAL</b>	<b>\$3,824</b>	<b>\$2,575</b>

**Table EA-41. Water Quality Costs, Present Value over Project Lifecycle, Down River**

Barrier	Description	Moderate River Permit to Stringent Lake - PV (\$ millions)		Moderate River to Moderate Lake - PV (\$ millions)		Stringent River Permit to Stringent Lake - PV (\$ millions)	
		3%	7%	3%	7%	3%	7%
	WWTP Upgrades - Capital Costs	\$1,873	\$1,026	\$812	\$444	\$0	\$0
	WWTP Upgrades - O&M	\$3,689	\$1,132	\$469	\$144	\$0	\$0
Barrier 9/16	Capital Cost of Flow Augmentation	\$206	\$155	\$206	\$155	\$206	\$155
Barrier 9/16	O&M Cost of Flow Augmentation	\$79	\$34	\$79	\$34	\$79	\$34
Barrier 9/16	Cost for Mitigating Contaminated Sediments	\$0	\$0	\$0	\$0	\$0	\$0
	<b>TOTAL</b>	<b>\$5,847</b>	<b>\$2,346</b>	<b>\$1,566</b>	<b>\$777</b>	<b>\$285</b>	<b>\$188</b>

**Table EA-42. Water Quality Costs, Present Value over Project Lifecycle, Mid-System**

Barrier	Description	Moderate River Permit to Stringent Lake - PV (\$ millions)		Moderate River to Moderate Lake - PV (\$ millions)		Stringent River Permit to Stringent Lake - PV (\$ millions)	
		3%	7%	3%	7%	3%	7%
	WWTP Upgrades - Capital Costs	\$375	\$205	\$187	\$103	\$0	\$0
	WWTP Upgrades - O&M	\$637	\$196	\$78	\$24	\$0	\$0
Barrier 4/5	Capital Cost of Flow Augmentation of South Branch of Chicago River and CSSC	\$69	\$52	\$69	\$52	\$69	\$52
Barrier 4/5	O&M Cost of Flow Augmentation of South Branch of Chicago River and CSSC	\$28	\$12	\$28	\$12	\$28	\$12
Barrier 20	Capital Cost of Flow Augmentation of Calumet River and Little Calumet River	\$62	\$47	\$62	\$47	\$62	\$47
Barrier 20	O&M Cost of Flow Augmentation of Calumet River and Little Calumet River	\$26	\$11	\$26	\$11	\$26	\$11
Barrier 4/5/20	Cost for Mitigating Contaminated Sediments	\$0	\$0	\$0	\$0	\$0	\$0
	<b>TOTAL</b>	<b>\$1,197</b>	<b>\$522</b>	<b>\$450</b>	<b>\$248</b>	<b>\$185</b>	<b>\$121</b>

**Table EA-43. Water Quality Costs, Present Value over Project Lifecycle, Near Lake**

Barrier	Description	PV (\$ millions)	
		3%	7%
	WWTP Upgrades - Capital Costs	\$0	\$0
	WWTP Upgrades - O&M	\$0	\$0
Barrier 3	Capital Cost of Flow Augmentation of Chicago River	\$6	\$4
Barrier 3	O&M Cost of Flow Augmentation of Chicago River	\$2	\$1
Barrier 15	Capital Cost of Flow Augmentation of Calumet River	\$61	\$40
Barrier 15	O&M Cost of Flow Augmentation of Calumet River	\$23	\$9
Barrier 19	Capital Cost of Flow Augmentation of North Shore Channel	\$20	\$13
Barrier 19	O&M Cost of Flow Augmentation of North Shore Channel	\$7	\$3
Barrier 3/15/19	Cost for Mitigating Contaminated Sediments	\$0	\$0
	<b>TOTAL</b>	<b>\$120</b>	<b>\$69</b>

**Table EA-44. Transportation Costs, Present Value over Project Lifecycle, Down River**

Barrier	Description	PV (\$ millions)	
		3%	7%
Barrier 9/16	Dam Structure - Crane Rails	\$1	\$1
Barrier 9/16	Dam Structure - Lighting/Power/Utilities	\$3	\$2
Barrier 9/16	Dam Structure - Dam Equipment - Wash Down Stations	\$1	\$0
Barrier 9/16	Dam Structure - Dam Equipment - Travel Lift	\$1	\$0
Barrier 9/16	Dam Structure - Dam Equipment - Travel Lift Trestle	\$0	\$0
Barrier 9/16	Dam Structure - Dam Equipment - Rail Cranes (Bulk)	\$18	\$12
Barrier 9/16	Dam Structure - Dam Equipment - Rail Cranes (Container)	\$7	\$5
Barrier 9/16	Dam Structure - Dam Equipment - Rail Crane Power	\$2	\$1
Barrier 9/16	Intermodal Terminal - Wharf	\$51	\$34
Barrier 9/16	Intermodal Terminal - East Basin Wall	\$4	\$2
Barrier 9/16	Intermodal Terminal - Dock (Concrete Paving and Lighting)	\$21	\$14
Barrier 9/16	Intermodal Terminal - Basin Excavation (Non-Contaminated)	\$3	\$2
Barrier 9/16	Intermodal Terminal - Basin Dredging (Non-Contaminated)	\$12	\$8
Barrier 9/16	Intermodal Terminal - Truck/Rail Yard (Concrete Paving and Lighting)	\$14	\$9
Barrier 9/16	Intermodal Terminal - Rail	\$4	\$2
Barrier 9/16	Southern Wharf - Wharf Perimeter (South of Dam)	\$44	\$30
Barrier 9/16	Southern Wharf - Dredging	\$3	\$2
Barrier 9/16	Laydown Areas - ROW	\$29	\$20
Barrier 9/16	Laydown Areas - Automated Conveyor	\$15	\$10
Barrier 9/16	Dry Dock - Commercial Graving Dock Structure O&M	\$13	\$9
Barrier 9/16	Dry Dock - Moveable Cassion Structure O&M	\$3	\$2
Barrier 9/16	Dry Dock - Graving Dock Apron/Yard Facilities O&M	\$4	\$3
Barrier 9/16	Liquid Transfer/Conveyance	\$108	\$73
Barrier 9/16	Overhead and Miscellaneous - Engineering Design Phase Services	\$47	\$39
Barrier 9/16	Overhead and Miscellaneous - Materials Testing	\$12	\$8
Barrier 9/16	Overhead and Miscellaneous - Construction Observation/ Administration	\$20	\$13
Barrier 9/16	Overhead Miscellaneous - Contingency	\$100	\$67
	Operating and Maintenance	\$25	\$10
	<b>TOTAL</b>	<b>\$563</b>	<b>\$379</b>

**Table EA-45. Transportation Costs, Present Value over Project Lifecycle, Mid-System**

Barrier	Description	PV (\$ millions)	
		3%	7%
Barrier 4/5	Dam Structure - Crane Rails	\$1	\$1
Barrier 4/5	Dam Structure - Lighting/Power/Utilities	\$2	\$2
Barrier 4/5	Dam Structure - Dam Equipment - Wash Down Stations	\$1	\$0
Barrier 4/5	Dam Structure - Dam Equipment - Travel Lift	\$1	\$0
Barrier 4/5	Dam Structure - Dam Equipment - Travel Lift Trestle	\$0	\$0
Barrier 4/5	Dam Structure - Dam Equipment - Rail Cranes (Bulk)	\$11	\$7
Barrier 4/5	Dam Structure - Dam Equipment - Rail Crane Power	\$1	\$0
Barrier 4/5	Laydown Areas - ROW	\$14	\$9
Barrier 4/5	Laydown Areas - Automated Conveyor	\$7	\$5
Barrier 4/5	Dry Dock for Commercial Tour Vessels - Commercial Graving Dock Structure O&M	\$13	\$8
Barrier 4/5	Dry Dock for Commercial Tour Vessels - Moveable Cassion Structure O&M	\$3	\$2
Barrier 4/5	Dry Dock for Commercial Tour Vessels - Graving Dock Apron/Yard Facilities O&M	\$4	\$3
Barrier 4/5	Overhead and Miscellaneous Costs - Engineering Design Phase Services	\$12	\$10
Barrier 4/5	Overhead and Miscellaneous Costs - Materials Testing	\$3	\$2
Barrier 4/5	Overhead and Miscellaneous Costs - Construction Observation/ Administration	\$5	\$3
Barrier 4/5	Overhead Miscellaneous Costs - Contingency	\$24	\$16
	Operating and Maintenance	\$63	\$24
Barrier 20	Dam Structure - Crane Rails	\$1	\$1
Barrier 20	Dam Structure - Lighting/Power/Utilities	\$3	\$2
Barrier 20	Dam Structure - Dam Equipment - Wash Down Stations	\$1	\$0
Barrier 20	Dam Structure - Dam Equipment - Travel Lift	\$1	\$0
Barrier 20	Dam Structure - Dam Equipment - Travel Lift Trestle	\$0	\$0
Barrier 20	Dam Structure - Dam Equipment - Rail Cranes (Bulk)	\$18	\$12
Barrier 20	Dam Structure - Dam Equipment - Rail Cranes (Container)	\$7	\$5
Barrier 20	Dam Structure - Dam Equipment - Rail Crane Power	\$2	\$1
Barrier 20	Intermodal Terminal - Wharf	\$67	\$45
Barrier 20	Intermodal Terminal - East Basin Wall	\$4	\$2
Barrier 20	Intermodal Terminal - Dock (Concrete Paving and Lighting)	\$21	\$14
Barrier 20	Intermodal Terminal - Basin Excavation (Non-Contaminated)	\$6	\$4
Barrier 20	Intermodal Terminal - Basin Dredging (Non-Contaminated)	\$24	\$16
Barrier 20	Intermodal Terminal - Truck/Rail Yard (Concrete Paving and Lighting)	\$14	\$9
Barrier 20	Intermodal Terminal - Rail	\$4	\$2
Barrier 20	Southern Wharf - Wharf Perimeter (South of Dam)	\$44	\$30
Barrier 20	Southern Wharf - Boat Launches	\$1	\$0
Barrier 20	Southern Wharf - Dredging	\$3	\$2
Barrier 20	Laydown Areas - ROW	\$29	\$20
Barrier 20	Laydown Areas - Automated Conveyor	\$15	\$10
Barrier 20	Dry Dock - Commercial Graving Dock Structure O&M	\$13	\$9
Barrier 20	Dry Dock - Moveable Cassion Structure O&M	\$3	\$2
Barrier 20	Dry Dock - Graving Dock Apron/Yard Facilities O&M	\$4	\$3
Barrier 20	Liquid Transfer/Conveyance System	\$108	\$73
Barrier 20	Overhead and Miscellaneous - Engineering Design Phase Services	\$53	\$44
Barrier 20	Overhead and Miscellaneous - Materials Testing	\$13	\$9
Barrier 20	Overhead and Miscellaneous - Construction Observation/ Administration	\$22	\$15
Barrier 20	Overhead Miscellaneous - Contingency	\$112	\$76
	Operating and Maintenance	\$286	\$107
	<b>TOTAL</b>	<b>\$1,043</b>	<b>\$605</b>



**Table EA-46. Transportation Costs, Present Value over Project Lifecycle, Near Lake**

Barrier	Description	PV (\$ millions)	
		3%	7%
Barrier 15	Engineering and Permitting	\$166	\$129
Barrier 15	Intermodal Operations	\$64	\$36
Barrier 15	Dry Dock	\$18	\$10
Barrier 15	18 Terminals	\$2,493	\$1,438
Barrier 15	Contingency	\$662	\$382
	Operating and Maintenance	\$2,051	\$685
	<b>TOTAL</b>	<b>\$5,454</b>	<b>\$2,681</b>

**Table EA-47. Barrier Costs, Present Value over Project Lifecycle, Down River**

Barrier	Description	PV (\$ millions)	
		3%	7%
Barrier 9/16	Dam Structure w/Fenders, Dredging at Face	\$40	\$27
	Barrier/Bypass Structure	\$70	\$44
	<b>TOTAL</b>	<b>\$109</b>	<b>\$71</b>

**Table EA-48. Transportation Costs, Present Value over Project Lifecycle, Mid-System**

Barrier	Description	PV (\$ millions)	
		3%	7%
Barrier 4/5	Dam Structure - Dam w/Fenders, Dredging at Face	\$38	\$25
Barrier 20	Dam Structure w/Fenders, Dredging at Face	\$59	\$40
Barriers 10 and 13	Barrier/Bypass Structure	\$46	\$29
	<b>TOTAL</b>	<b>\$144</b>	<b>\$94</b>

**Table EA-49. Transportation Costs, Present Value over Project Lifecycle, Near Lake**

Barrier	Description	PV (\$ millions)	
		3%	7%
Barrier 15	Barrier	\$70	\$39
Barriers 19, 3, 10, 13	Barrier/Bypass Structure	\$74	\$40
	<b>TOTAL</b>	<b>\$143</b>	<b>\$78</b>

## ATTACHMENT II

The outcomes presented rely on a large number of assumptions and long-term projections; both of which are subject to considerable uncertainty.

The primary purpose of the sensitivity analysis is to help identify the variables and model parameters whose variations have the greatest impact on the outcomes: the “critical variables.”

The sensitivity analysis can also be used to:

- Evaluate the impact of changes in the critical variables, of reasonable departures from their “preferred” values; and,
- Assess the robustness of the analysis and evaluate, in particular, whether the conclusions reached under the “preferred” set of input values are significantly altered by reasonable departures from those values.

The outcomes of the quantitative analysis for the CAWS using a 3 and 7 percent discount rate are summarized in the tables below. The table provides the baseline condition as reference, and change in project PV associated with variations in variables or parameters listed, as indicated in the column headers.

**Table EA-50. Down River Quantitative Assessment of Sensitivity (\$ Millions)**

Category	Change in Parameter Value	Sensitivity PV (3% discounted)	Baseline Cost PV (3% discounted)	Change in Impact PV
Transportation (Cargo Movement)	0% Bulk Cargo Forecast Growth Rate	-\$739	-\$1,269	\$530
	5% Increase in Barge Related Transportation Costs, 2.5% Increase in Barge Transit Times	-\$642	-\$1,269	\$627
	20% Increase in Barge Related Transportation Costs, 10% Increase in Barge Transit Times	-\$2,448	-\$1,269	-\$1,179
	100% Diversion to Truck	-\$1,487	-\$1,269	-\$218
	100% Diversion to Rail	-\$1,033	-\$1,269	\$236
Transportation (New Cargo Potential)	75% Savings in Shipping Rate Versus Rail	N/A	N/A	N/A
Recreational Boating	2% Growth Rate	\$15	\$12	\$3
Commercial Tour	2 Additional Boats Required	N/A	N/A	N/A
Public Safety and Security	Additional Staffing Required (\$5.5 Million per Year)	N/A	N/A	N/A
AIS Research / Prevention	Increased Research / Prevention Cost (\$25 Million per year)	\$389	\$78	\$311
	Increased Research / Prevention Cost (\$50 Million per year)	\$777	\$78	\$699

**Table EA-51. Down River Quantitative Assessment of Sensitivity, Summary**

Category	Change in Parameter Value	Sensitivity PV (7% discounted)	Baseline Cost PV (7% discounted)	Change in Impact PV
Transportation (Cargo Movement)	0% Bulk Cargo Forecast Growth Rate	-\$277	-\$455	\$178
	5% Increase in Barge Related Transportation Costs, 2.5% Increase in Barge Transit Times	-\$230	-\$455	\$225
	20% Increase in Barge Related Transportation Costs, 10% Increase in Barge Transit Times	-\$878	-\$455	-\$423
	100% Diversion to Truck	-\$534	-\$455	-\$79
	100% Diversion to Rail	-\$370	-\$455	\$85
Transportation (New Cargo Potential)	75% Savings in Shipping Rate Versus Rail	N/A	N/A	N/A
Recreational Boating	2% Growth Rate	\$6	\$4	\$2
Commercial Tour	2 Additional Boats Required	N/A	N/A	N/A
Public Safety and Security	Additional Staffing Required (\$5.5 Million per Year)	N/A	N/A	N/A
AIS Research / Prevention	Increased Research / Prevention Cost (\$25 Million per year)	\$146	\$29	\$117
	Increased Research / Prevention Cost (\$50 Million per year)	\$291	\$29	\$262

**Table EA-52. Mid System Quantitative Assessment of Sensitivity (\$ Millions)**

Category	Change in Parameter Value	Sensitivity PV (3% discounted)	Baseline Cost PV (3% discounted)	Change in Impact PV
Transportation (Cargo Movement)	0% Bulk Cargo Forecast Growth Rate	-\$803	-\$1,379	\$576
	5% Increase in Barge Related Transportation Costs, 2.5% Increase in Barge Transit Times	-\$698	-\$1,379	\$681
	20% Increase in Barge Related Transportation Costs, 10% Increase in Barge Transit Times	-\$2,659	-\$1,379	-\$1,280
	100% Diversion to Truck	-\$1,615	-\$1,379	-\$236
	100% Diversion to Rail	-\$1,122	-\$1,379	\$275
Transportation (New Cargo Potential)	75% Savings in Shipping Rate Versus Rail	\$553	\$416	\$137
Recreational Boating	2% Growth Rate	-\$33	-\$24	-\$9
Commercial Tour	2 Additional Boats Required	N/A	N/A	N/A
Public Safety and Security	Additional Staffing Required (\$5.5 Million per Year)	-\$89	-\$3	-\$86
AIS Research / Prevention	Increased Research / Prevention Cost (\$25 Million per year)	\$389	\$78	\$311
	Increased Research / Prevention Cost (\$50 Million per year)	\$777	\$78	\$699

**Table EA-53. Mid System Quantitative Assessment of Sensitivity, Summary**

Category	Change in Parameter Value	Sensitivity PV (7% discounted)	Baseline Cost PV (7% discounted)	Change in Impact PV
Transportation (Cargo Movement)	0% Bulk Cargo Forecast Growth Rate	-\$301	-\$495	\$194
	5% Increase in Barge Related Transportation Costs, 2.5% Increase in Barge Transit Times	-\$250	-\$495	\$245
	20% Increase in Barge Related Transportation Costs, 10% Increase in Barge Transit Times	-\$954	-\$495	-\$459
	100% Diversion to Truck	-\$579	-\$495	-\$84
	100% Diversion to Rail	-\$402	-\$495	\$93
Transportation (New Cargo Potential)	75% Savings in Shipping Rate Versus Rail	\$187	\$141	\$46
Recreational Boating	2% Growth Rate	-\$12	-\$11	-\$1
Commercial Tour	2 Additional Boats Required	N/A	N/A	N/A
Public Safety and Security	Additional Staffing Required (\$5.5 Million per Year)	-\$34	-\$2	-\$32
AIS Research / Prevention	Increased Research / Prevention Cost (\$25 Million per year)	\$146	\$29	\$117
	Increased Research / Prevention Cost (\$50 Million per year)	\$291	\$29	\$262

**Table EA-54. Near Lake Quantitative Assessment of Sensitivity (\$ millions)**

Category	Change in Parameter Value	Sensitivity PV (3% discounted)	Baseline Cost PV (3% discounted)	Change in Impact PV
Transportation (Cargo Movement)	0% Bulk Cargo Forecast Growth Rate	-\$876	-\$1,549	\$673
	5% Increase in Barge Related Transportation Costs, 2.5% Increase in Barge Transit Times	-\$784	-\$1,549	\$765
	20% Increase in Barge Related Transportation Costs, 10% Increase in Barge Transit Times	-\$2,987	-\$1,549	-\$1,438
	100% Diversion to Truck	-\$1,815	-\$1,549	-\$266
	100% Diversion to Rail	-\$1,261	-\$1,549	\$288
Transportation (New Cargo Potential)	75% Savings in Shipping Rate Versus Rail	\$494	\$372	\$122
Recreational Boating	2% Growth Rate	-\$34	-\$25	-\$9
Commercial Tour	2 Additional Boats Required	-\$22	-\$13	-\$9
Public Safety and Security	Additional Staffing Required (\$5.5 Million per Year)	-\$74	-\$3	-\$71
AIS Research / Prevention	Increased Research / Prevention Cost (\$25 Million per year)	\$324	\$65	\$259
	Increased Research / Prevention Cost (\$50 Million per year)	\$647	\$65	\$582



**Table EA-55. Near Lake Quantitative Assessment of Sensitivity, Summary**

Category	Change in Parameter Value	Sensitivity PV (7% discounted)	Baseline Cost PV (7% discounted)	Change in Impact PV
Transportation (Cargo Movement)	0% Bulk Cargo Forecast Growth Rate	-\$293	-\$499	\$206
	5% Increase in Barge Related Transportation Costs, 2.5% Increase in Barge Transit Times	-\$253	-\$499	\$246
	20% Increase in Barge Related Transportation Costs, 10% Increase in Barge Transit Times	-\$963	-\$499	-\$464
	100% Diversion to Truck	-\$585	-\$499	-\$86
	100% Diversion to Rail	-\$406	-\$499	\$93
Transportation (New Cargo Potential)	75% Savings in Shipping Rate Versus Rail	\$153	\$115	\$38
Recreational Boating	2% Growth Rate	-\$11	-\$8	-\$3
Commercial Tour	2 Additional Boats Required	-\$11	-\$6	-\$5
Public Safety and Security	Additional Staffing Required (\$5.5 Million per Year)	-\$25	-\$1	-\$24
AIS Research / Prevention	Increased Research / Prevention Cost (\$25 Million per year)	\$108	\$22	\$86
	Increased Research / Prevention Cost (\$50 Million per year)	\$216	\$22	\$194

A sensitivity/risk analysis was conducted using Latin Hypercube sampling on the project cost estimates and the degree of precision in the estimates provided in Part H. For the purposes of this analysis, the Moderate River to Stringent Lake Scenario water quality scenario was utilized.

**Table EA-56. Simulation Results of Total Project Cost Estimates, PV in Billions of 2011 \$ Using 3% Discount Rate**

Alternative	Mean	10'th Percentile	50'th Percentile	90'th Percentile
Down River	\$11.3	\$7.5	\$11.2	\$15.4
Mid System	\$5.0	\$3.7	\$5.0	\$6.4
Near Lake	\$11.4	\$7.5	\$11.3	\$15.5

## APPENDIX C. PEER REVIEW MATERIALS

### **C1. PEER REVIEW I**

- MEETING AGENDA 5-9-2011
- MEETING MINUTES AND COMMENTS
- STUDY OVERVIEW PRESENTATION
- TRANSPORTATION PRESENTATION
- CAWS OPERATION PRESENTATION
- CAWS HYDRAULICS PRESENTATION

### **C2. PEER REVIEW II**

- MEETING AGENDA 8-31-2011
- MEETING MINUTES AND COMMENTS
- ECONOMIC ANALYSIS PRESENTATION



## **C1. PEER REVIEW I**

- MEETING AGENDA 5-9-2011
- MEETING MINUTES AND COMMENTS
- STUDY OVERVIEW PRESENTATION
- TRANSPORTATION PRESENTATION
- CAWS OPERATION PRESENTATION
- CAWS HYDRAULICS PRESENTATION



## *Peer Review Team Agenda / Schedule*

### *Envisioning a Chicago Area Waterway System for the 21st Century Project*

**May 9, 2011 – Day One**  
**10:00AM to 5:00PM**

**May 10, 2011 – Day Two**  
**8:00AM to 3:00 PM**

Welcome / Introductions	10:00	Welcome	8:00
Project History / Overview	10:15	Recap of Day One Discussions	8:15
Roles of GLC & Cities Initiative		HDR Presentation – Water Quantity	8:30
Role of Advisory Committee		Flooding Issues	
Purpose of Peer Review		CSO Control Issues	
Anticipated Outcomes		Low Flow Issues	
HDR Team Overview	10:30		
Project Flow Chart		Discussion of Water Quantity Issues	9:45
Project Limits – Boundary Map			
Key Assumptions		Lunch	11:30
HDR Presentation – Barrier Alternatives	11:00	HDR Presentation – Water Quality	12:00
Lunch / Discussion of Barrier Alternatives	12:00	WWTP Discharges	
		CSO Issues	
		Low Flow – Stagnation	
HDR Presentation – Transportation Issues	1:00		
Existing Limitations		Discussion of Water Quality Issues	1:00
Market Expectations			
Lake Based Issues		Peer Review Team Topics	2:00
River Based Issues			
Data Availability		Wrap-Up Discussions	2:45
Discussion of Transportation Issues	2:15		
HDR Presentation – Economic Analysis	3:30	Adjourn	3:00
Description of Tool			
Discussion of Economic Analysis Tools	4:00		
Wrap-Up Discussions	4:45		
Adjourn	5:00		



***Envisioning a Chicago Area Waterway System  
for the 21st Century Project***

**Peer Review Session One  
May 9 and 10, 2011**

**Introduction / Team Members**

On May 9<sup>th</sup> and 10<sup>th</sup> 2011 a Peer Review Team was convened to review the progress made to date by the HDR team. The session took place in the Chicago offices of HDR and was facilitated by staff from Environmental Consulting & Technology, Inc. [ECT]. A purposefully diverse group of experts was selected to provide input to the project from wide perspectives.

The purpose of the effort was to:

- Obtain objective, outside expert perspectives
- Raise questions early in the study – avoid ‘gotchas’
- Identify concerns that may be raised by others
- Validate the process being undertaken, and
- Bring new insights/direction to the effort early enough in the process to avoid delays in the completion date.

The desired outcomes as stated at the beginning of the session were:

- Pose specific technical questions to the HDR Team
- Allow HDR to interactively provide answers
- Raise issues/concerns that need to be considered prior to public review of the material
- Facilitate potential resolutions of the issues identified
- Propose any “redirection” that could improve acceptance of the final recommendations

The Peer Reviewers were selected from experts in the fields of engineering, water quality, transportation planning, and economics with specific knowledge of the Chicago metropolitan area and the Chicago Area Waterway System. Team members and their backgrounds are presented below.

**Frank H. Beal**

Frank Beal is the Executive Director of Metropolis Strategies (formerly Chicago Metropolis 2020). He previously served as president of Ryerson International Inc., an operating unit of the former Inland Steel Industries. Prior to joining Inland Steel, he served as director of the Illinois Department of Energy and Natural Resources under Governor Thompson, and, as the state’s first deputy director of the Institute for Environmental Quality under Governor Ogilvie.

Formerly with the American Planning Association, he has edited and published several books, articles and reports on urban affairs and land use planning. Mr. Beal was appointed to the Chicago Metropolitan Agency for Planning Board as one of five representatives for the City of Chicago. He serves both the Waste Water Committee and the Programming Coordinating Committee. Mr. Beal graduated from the University of Illinois with a Master’s degree in Urban Planning and has a Bachelor’s degree in Engineering from Antioch College.

**Josh Ellis**

Josh Ellis has been on the staff of the Metropolitan Planning Council (MPC) since 2006. His focus is on advancing MPC's environmental and economic goals through policy research, advocacy, and community engagement. He manages MPC's water resources protection initiatives, co-authored *Before the Wells Run Dry*, and now works with state, regional and local leaders on strategies to sustainably manage Illinois' finite water resources. Mr. Ellis has served in an advisory capacity to governmental bodies including the Illinois Environmental Protection Agency, Metropolitan Water Reclamation District of Greater Chicago, City of Chicago mayoral transition team, and Village of Lake Zurich, as they develop new policy, programs, and investments in water infrastructure. He blogs and is a frequent public speaker on northeastern Illinois's water challenges, and has been a resource for national and local media. Through the Community Building Initiative, he provides technical assistance on transit-oriented development, energy efficiency, water supply, and stormwater. He co-authored *Retail 1-2-3*, one of MPC's guidebooks for local elected officials and staff. He also manages MPC's internal GIS for geospatial analysis of environmental, economic and demographic trends. This work includes investigating the jobs-housing mismatch, opportunities for transit expansion, and federal investment patterns.

Mr. Ellis has the following degrees: M.P.P., Public Policy, University of Chicago; M.A., Middle Eastern Studies, University of Chicago; B.A., English Literature, College of William and Mary

**William Testa**

Bill Testa has written widely in the areas of economic growth and development, the Midwest economy and state-local public finance. He directed a comprehensive long-term study and forecast of the Midwest economy, *Assessing the Midwest Economy: Looking Back for the Future*. He serves in an advisory or director's capacity to a variety of professional journals, nonprofit organizations, advisory boards and economic development initiatives in the Midwest. He chairs the Board of Trustees of the Illinois Council on Economic Education and serves on the boards of the Global Chicago Center of the Chicago Council on Global Affairs and the Economic Development Council of Chicago.

Mr. Testa was a visiting faculty member in the economics department at Tulane University in New Orleans and a graduate research fellow at the Academy for Contemporary Problems in Columbus, Ohio. He currently lectures at DePaul University's College of Commerce. Testa received his undergraduate degree from Northwestern University and a Ph.D. in economics from the Ohio State University.

**Dr. Charles Melching**

Dr. Charles Melching is Professor of Civil and Environmental Engineering at Marquette University in Milwaukee, Wisconsin. His areas of expertise include surface-water hydrology, rainfall-runoff modeling, stream water-quality modeling and the application of risk, reliability, and uncertainty analysis to water-resources and environmental problems. He is the Director of the Institute for Urban Environmental Risk Management. He has nearly 20 years of experience working on the hydraulics and water quality in the Chicago Area Waterways (CAWS). This began while he worked for the U.S. Geological Survey (USGS) where he evaluated the flow record at the acoustic velocity meter on the Chicago Sanitary and Ship Canal at Romeoville. Also while working for the USGS he provided data and analysis in support of the 3<sup>rd</sup> and 4<sup>th</sup> Committees for the Review of the Lake Michigan Diversion at Chicago. Later while at Marquette University he served as the Hydrologic and Hydraulic Modeling Expert on the 5<sup>th</sup> and 6<sup>th</sup> Lake Michigan Diversion Review Committees. Beginning in 2000, Dr. Melching developed and applied a model of flow and water quality for the CAWS for the Metropolitan Water Reclamation District of Greater Chicago.

Dr. Melching has the following degrees: Ph.D., Civil Engineering, University of Illinois; M.S., Civil Engineering, University of Illinois; B.S.E., Civil Engineering, Arizona State University.

### Dale Bryson

Dale Bryson worked to protect clean water for 34 years at the U.S. EPA. He ended his career there as the director of EPA's Region 5 water division. Dale is also a former Board Chairman for the Alliance for the Great Lakes. He led the Alliance through its transition to a regional organization in 2005. A special fund to support Alliance interns in their work to keep Great Lakes water clean was established in Dale's honor after he retired from the board.

Mr. Bryson Has a Masters Degree in Civil Engineering from the University of Michigan and a B.S. in Civil Engineering from the South Dakota School of Mines and Technology.

### **Key Issues**

Certain key points emerged during the discussions that took place throughout the review sessions. These include

- 1 Is the project too ambitious or should we focus just on AIS prevention?
- 2 Have we limited the number of alternatives too much prior to the next Advisory Committee meeting?
- 3 Will GLC/Cities Initiative be able to garner sufficient Congressional support to launch the larger initiative?
- 4 Is the transportation plan and proposed harbor/port development too "ambitious" and is it too much of a "hard sell?"
- 5 New technology should be considered to address some of the most challenging aspects of water quality improvement.
- 6 Will WWTP discharge requirements be different between the two watersheds?
- 7 How will GLC/Cities Initiative present the "local costs" (those for which local municipalities are responsible vs. MWRD) for improving the collection/feeder systems to allow deeper water on the post-separation lakeside portions of the CAWS and transporting CSOs away from the lake to the CAWS?
- 8 How will the cost of expanding the flow transport capacity (should it be required) of the CAWS (i.e. widening and deepening) be shared among the benefiting parties.

### **Format**

The meeting began with an overview presentation of the project history. Roles of the Great Lakes Commission and the Great Lakes and St. Lawrence Cities Initiative were presented, and the scope of the HDR Team's effort was defined. HDR made an introductory presentation describing the scope and schedule of the effort; described the project's geographic limits; and outlined the key assumptions upon which the work is based. Over the remainder of the two days, HDR then made presentations to the team describing activities in the following key project areas:

- Alternative barrier locations (Monday)
- Transportation issues (Monday)
- Economic analysis methodology (Monday)
- Water Quantity issues (Tuesday)
- Water Quality issues (Tuesday)

Peer review team members were encouraged to actively interact with the presenters to question assumptions, provide input and make suggestions. Members were told that comments made would all be attributed to “the review team” – not to individual members – to promote an open and candid dialogue. The meeting progressed with detailed and probing discussions within each topic area.

The following pages present a compilation of notes taken over the two-day session. They are formatted generally with presentation materials left justified and Peer Reviewer comments *indented and italicized*. Copies of the PowerPoint presentations made by the HDR team are attached to this report.

## Day One Opening Comments

This project is examining the potential placement of barriers in the Chicago Area Waterway System (CAWS) to create a hydrologic separation between the Great Lakes and the Mississippi River basins. The project assumes hydrologic barriers will be in place and examines potential locations and impacts of those barriers on the chemical, physical and biological integrity of both watersheds as well as the economic and transportation infrastructure of the areas affected.

The project will identify three potential alternatives for constructing barriers that will prevent the exchange of water between Lake Michigan and the Mississippi River system, keeping Asian carp and other aquatic invasive species from entering the Great Lakes from the Mississippi River watershed as well as preventing the introduction of aquatic invasive species (AIS) into the Mississippi River watershed from the Great Lakes. The barriers will have impacts on water quality, flooding, stormwater management, ecological health, transportation, recreation (including recreational boating, beach health and tourism) and a host of other issues. As a result, a broad range of impacts resulting from construction of the barriers is being detailed and documented. The impacts resulting from separation, the benefits to Chicago-land and the broader Great Lakes region, and the opportunities to enhance uses of all parts of the system are all incorporated into the alternatives. The process and the product must be credible and withstand technical challenges.

The project final report will be available to the public in January 2012 and will contribute to and help shape discussions of separation options (and their impacts and costs) among the public and in Congress. Ultimately, this information is intended to help “move the ball down the field.” The product will be prepared and vetted in a manner that will allow the Army Corps of Engineers to readily accept it as a foundation for their ongoing efforts.

The Great Lakes Commission (GLC) and the Great Lakes and St. Lawrence Cities Initiative (Cities Initiative) are leading the effort and have a broad mandate to deal with a wide range of issues associated with hydrologic separation. The GLC is on record supporting separation as the best permanent, long-term option for preventing Asian carp from invading the Great Lakes via the CAWS and halting other future AIS transfer via this pathway, while taking into account existing important uses of the waterways. The potential entry of Asian carp into the Great Lakes is the highest profile issue in the Great Lakes right now. It has generated substantial interest in the media, Congress, environmental/conservation groups, and among the eight Great Lakes states. Among other developments, lawsuits have been filed against the Corps and others calling for closure of navigation locks. (The GLC and Cities Initiative are not engaged in nor do they have positions on the litigation.) The GLC is the formal grantee for the project in partnership with the Cities Initiative, receiving approximately \$2 million from several funders to support the effort.

The project Advisory Committee (AC) represents a broad array of stakeholders that are interested in or will be affected by separation (or the lack thereof) and are being given the opportunity to provide advice and input to the study effort. Approximately two-thirds of the AC are from the Chicago area or/and Northwest Indiana. The Mayor of Grand Rapids, the Governor of Ohio, the Governor of Illinois and the Mayor of Chicago serve on an Executive Committee that is guiding the overall effort.

The discussion began with a differentiation between the "existing conditions" and the "baseline conditions."

*The peer review team expressed the need to better understand the "baseline" conditions – specifically what costs would be attributable to separation versus other projects that would be required by the Clean Water Act (CWA) and other federal regulations. The proposed separation options should NOT assume (be accountable for) the costs of environmental compliance - both currently mandated projects and future projects that will be required whether separation is completed or not. The completed Tunnel and Reservoir Plan (TARP) is considered part of the baseline conditions. The issue of "technology forcing principle" was raised by one peer review member. In other words, the CWA requires compliance with the law and requires dischargers to be innovative in how they will achieve compliance. It was asked if we should rethink and increase the emphasis of green infrastructure and related BMPs to recognize their potential to have an impact on stormwater management. The idea is to force the issue of technology to get beyond status quo thinking. "If we think status quo, we are doomed to failure. It may be time to push the envelope in the CAWS system and be visionary."*

*The driver of the project is invasive species, but to address this, there is a need to look at the re-engineering (the water aspects) of metropolitan Chicago as it is currently configured and how this effort fits into that re-engineering. Chicago will likely look to Congress for several billion dollars. There is uncertainty regarding whether senators from Oklahoma, for example, will be willing to pay for a multi-billion dollar effort to keep Asian carp out of the Great Lakes.*

*One reviewer questioned the expansive scope of the project. He admired the ambitious nature but feared that the effort could collapse under its own weight. He noted that the main goal of the project was to prevent Asian carp from entering the Great Lakes. If carp make it into Lake Michigan, they will infest the entire Great Lakes region. He posed the rhetorical question, "Is this scenario compelling enough to drive the decision to separate the watersheds?" The larger group noted that this is not just about Asian carp, but also about long-term water management in the Chicago region, and AIS moving from the Great Lakes to the Mississippi River and beyond. Once the decision to address Asian carp is made, the region is forced to deal with other issues facing the system. The Chicago Sanitary and Ship Canal (CSSC) was built to protect drinking water from Lake Michigan for the City of Chicago and to build a better transportation waterway to move goods from the Great Lakes to the Mississippi River system and the Gulf of Mexico. However, in recent times, shipping volumes continue to decline while Chicago has become the major North American rail hub. Stormwater and flood management has become a major issue addressed through the CAWS system over the last 100 years. The goal of the barrier is to separate the two water systems with the primary goal of keeping AIS from entering each system. In doing so, it impacts the original purpose of the CAWS system, affecting water quality, transportation and stormwater. You can't address the carp issue without affecting these other issues. However, the system will change in the near future even if separation is not considered. The goal is to encourage the development of a coordinated approach to all of these challenges.*

*The reviewers noted that even if this project occurs, there are other vectors for carp (and other AIS) to enter the Great Lakes system. However, currently, the CAWS is the easiest and most likely point of entry into the system.*

*The peer reviewers concluded that there is a need to provide different messages to different people that reflect their needs and concerns as part of the broader vision. But, one reviewer did not support the concept of differing messages to different people. A reviewer supported looking at a new land ethic and moving away from engineered systems to more naturalized systems. "We messed with Mother Nature before and now we need to become more naturalized again, but that is not a simple issue."*

The HDR Team made a presentation showing maps of the CAWS and identifying a suite of potential barrier locations. [A representative map is included as an attachment to this report.] The presentation showed how combinations of barrier locations would be required to 'disconnect' the CAWS from multiple connections to Lake Michigan. Brief explanations of the impacts each barrier location on the system were presented. The complexity of the overall system and the fact that it acts as a network was apparent. A change to any one component of the network has direct impacts on all other components.

*There is a need for arrows on the maps that show the direction of water flow (including major inputs). There is also a need for individual maps that show the different options.*

*Why put Lake Calumet on the canal side (on some alternatives)?*

If an inland port is built, this is a place to turn around a lake carrier (to be discussed later during transportation section).

*Why are there no barriers on the Skokie River side? That is a potential risk because the lagoons are a bait bucket vector.*

There are many bait bucket vectors. It is less of a risk than other locations.

*There is a need to show more options to the Advisory Committee. Three may not give them an adequate sense of the options. The project team will need to show that some of them were readily viewed as not being viable.*

*Some reviewers thought the 4/5 option is best. Can see that barrier 20 has a lot of potential benefits as well. Goes beyond what a lot of people are thinking about but also is far more extensive than is currently envisioned in the near term.*

*Someone might look at this and say "you didn't look at some things that would be eliminated anyway." You need to show that you looked at many different alternatives and not just three. Some will be out of the running anyway, but you need to show that you looked at them. You don't have to do a comprehensive analysis, but just explain why some options were not examined in more detail. This will help in showing that the location selections are not arbitrary.*

*Consider blocking the CAWS at Lockport. What about it?*

This has been reviewed, but the complexities of the system make this extremely difficult.

*It is very likely that the message is going to be unpopular, but everyone needs to know that we have really thought it through. While there will be three final options, there will not be a preferred alternative. One reviewer felt that: "Not having a preferred alternative is a subtlety that misses the point. The argument won't be around which set of barriers to choose. That is an insiders game. The argument will be about whether we need to take this kind of action at all."*

*There is a need to look at social and other costs and benefits. Who will be affected?*



## Day One Transportation

The HDR Team gave a presentation on transportation trends that may affect what can be done with transportation challenges on the CAWS associated with separation. In general, there is a need for more data on transportation. The team outlined a series of options and issues facing transportation in the Chicago region. The widening of the Panama Canal may increase container traffic going through the canal and to the Port of New Orleans. This offers an opportunity to develop an "omni port" in Chicago where cargo in containers can be moved from barges on the Illinois River side to lake freighters or rail cars on the lake side near Lake Calumet.

*A reviewer noted that we need to have a focus group to find out what's shipping within the CAWS and that the project team should inform the Corps what information is needed so that they can look at it as part of that effort. It won't help the project team, but will be helpful to the overall process.*

It was noted that expectations from the projections indicate that water transportation will increase. The recent trends indicate that it is decreasing.

*Reviewers asked whether the projections are overly optimistic. It seems as though the impacts of this port concept will be marginal. It would incubate only an incremental bump in container traffic, but it may be of value.*

*The discussion of transportation raises the issue about what the study is really about. Is it taking on too much? Adding transportation is taking on another assignment that may be too much for what is needed. Building off of that, a reviewer asked whether this port concept is something that needs to happen absent construction of barriers. Is this part of the big picture?*

*Further, the question was raised regarding whether we are looking to **grow** waterborne transportation or **maintain** the existing system? How do we convince commercial interests that we can do something different/better than what they have now? If there is going to be growth in shipping, do we need to get ready for it? Is the "omni port" approach the best approach? As one reviewer stated "Growing the transportation system is only a benefit if the ultimate goal of AIS risk mitigation is met first."*

*It is critical that the private sector participate in the costs of the port/harbor development and financing. It would also require subsidies to develop. There are winners and losers out there. Generally, the winners are not here just yet; in contrast, the losers are already here, although some can be part of the winners if they position themselves correctly.*

*One reviewer was disappointed that there was not a lot more information and discussion about recreational boating.*

The HDR team asked who they should contact in the shipping community.

*The reviewers mentioned Mark Biel with the Chemical Industry Council of Illinois regarding shipping trends and the Chambers of Commerce. These groups are just now starting to think about visioning. This had not happened absent the AIS debate. There are opportunities now to look at a vision for where water traffic moves from this point. As it is, there is competition for a declining market on the river.*

Other general comments made by the peer review team concerning transportation included the following.

*The "omni port" approach does not appear to help with the four-day "black hole" rail congestion problem. This problem is too big to be addressed by a barge-to-carrier port. The carrier market would have real problems with any of the alternatives. The terminal operators like what they have, but may be interested in seeing public investment.*

*In general, the reviewers thought that the transportation and port/harbor recommendation was overly aggressive and promotional. Is this all about invasive species or a new Burnham Plan for the Chicago region? If you know transportation is important to Chicago and that it is "broken," this may be the way to go, but currently, rail is the driver for the region's transportation system. If we transfer goods to water, but still have rail congestion, are we really improving transportation? The public sector in Illinois is not paying attention to the region's transportation assets. Chicago is focused on rail and truck. Waterborne transportation is just a small part of the region's transportation.*

*One reviewer stated: "Water borne freight is a tiny fraction of what is transported by rail and truck in the region. You could increase by a factor of 10 the amount of water-borne traffic and no one would notice. Truck and rail infrastructure could absorb all of the water-borne freight."*

## Day One Economic Analysis

HDR made a presentation on the approach for developing a cost-benefit analysis for the impacts of the project. A key issue will be identifying and quantifying costs and benefits attributable to the separation project distinct from the costs and benefits of projects that are required by other regulations or that will occur regardless of whether separation is implemented.

*The peer reviewers noted that HDR presented an interesting approach to economic modeling.*

HDR noted that they are at the infancy of sustainable return on investment economic analysis, so the template for doing this is not yet set.

*Peer reviewers noted that it is important to develop the logic structure surrounding this analysis; otherwise it will appear to be disjointed. Be sure to quantify input data and assumptions, look at the probability ranges of impacts, and reflect uncertainty.*

HDR presented a table identifying certain items and categorized each as a cost or benefit. The initial structure identified more costs than benefits as of now. There is always frustration on the benefits side of the equation because the costs are always broken down to specifics, but the benefits are less amenable to being broken out because they are harder to pin down and therefore tend to be lumped together.

*An example is addressing degraded water quality. The benefits are not necessarily quantifiable, but they are listable.*

*Stopping the movement of AIS into the Mississippi River basin is a huge benefit, but we need to be more specific. A huge benefit can be quantified by showing what won't need to be done if AIS movement is prevented. This can be examined by looking at the "what if" that has already happened to show costs on both sides of the divide.*

The issue of whether freeing up water diversion allowed under the Supreme Court consent decree can be considered a benefit was discussed at some length.

*Peer reviewers felt that there were differing opinions within the "public" on how the "freed up water" would be distributed. Some think that freeing up more water for use in the western suburbs is a benefit. But other interests in the Great Lakes region may not see continuing a diversion that is currently half for use as drinking water and the other half for navigation/waste assimilation as a benefit. They might prefer to see the benefit of freeing up the allocation for return to the Great Lakes.*

The costs associated with TARP and how to include them in the economic analysis were discussed – interactively – between HDR staff and reviewers.

*TARP may be a cost because of a change in the base case, but that is unclear. The drivers are different. There may be costs associated with the incremental cost of meeting Great Lakes water quality guidelines. This may require substantial investment (e.g., a second tunnel) to deal with needs on the north side from having to meet Great Lakes water quality guidelines.*

*One reviewer noted that there is a "mix of causes and effects" listed rather than specific "benefits and costs" in some of the areas that were identified. For example: constructing the barrier is a cause; reduction of invasives is an effect.*

Other general comments made by the peer review team concerning the economic analysis included the following:

*The value (benefit or cost) of construction as measured by jobs created should be kept out of the analysis. This is a separate issue.*

*Why is property value a cost and benefit?*

It depends on what happens in different areas.

*Is it desirable to have common planning horizon targets?*

Yes. Our planning timing horizon is linked to TARP.

*The benefit of keeping AIS out is priceless.*

*Is the cost of a new port really a cost associated with separation? In the opinion of one reviewer it was not enhancing transportation per se. It did, however, enable new cargoes in the future. With or without the separation project, the shippers should be planning for the future of shipping. This project could help in setting the right conditions. Without the barrier can't you build a modern port that is prepared for the future of shipping? The answer is yes.*

*Don't bury the costs of the port and don't overstate the benefits*

*A number of questions were posed, mostly directed to the current transportation constraints and the ability of a new port to address those constraints. If you construct barriers, will it lead to more cargo on barges?*

No but a new port could be designed in preparation of additional containerized shipping.

*If the port traffic moves from overland shipment to CAWS system are modal diversions to increase traffic in the waterways considered a benefit? To whom? What about the costs to carriers who lose the cargo shipment on rail or truck? There may be winners and losers. Will there be a single cost or benefit or will it be broken down because there are winners and losers?*

*Does everyone have the same vision of the goals of the project?*

## **Day Two Additional Information**

Peer review team member Dr. Charles Melching made a presentation on work he has done to model the operation of the CAWS. The presentation focused on the large-scale physical constraints of the CAWS and the resulting backflows to Lake Michigan. The model (and supporting data) concludes that the transport capacity of the CAWS is insufficient to transport the peak flow from a major flood (without relief to Lake Michigan). He also noted that stormwater infiltration enters the shallow groundwater but then leaks into local sewage collection systems. Green infrastructure may not reduce inflow into these systems. Backflows into Lake Michigan are not affected by outflows at Lockport because the downstream portions of the CAWS

do not have sufficient conveyance capacity to rapidly pass the peak flows. He described the great complexity associated with the system that will be difficult to manage with new barriers. Small changes in the system will likely have anticipated and unanticipated effects.

*One reviewer stated that a cynical regulator might think that MWRD has been saying that the system is too complicated to implement minor changes and thereby claiming that they can't do anything about the continued dissolved oxygen and bacteria excursions. He wondered why MWRD isn't trying to do things that have been done in other areas of the Great Lakes region.*

The discussion continued on the complexities that are related to that question.

## Day Two Water Quantity -- Water Storage and Conveyance

HDR Team members made a presentation on the hydraulics of the CAWS, focusing on the size of peak flows, the areas with flooding concerns, and the areas that will drain combined sewer overflows (CSO) to both the CAWS and Lake Michigan. During many (smaller) rainfall events combined sewers overflow either to the CAWS or to the completed portion of TARP.

The HDR team and reviewers discussed at some length the schedule for TARP completion and the impact it will have on the magnitude, frequency and location of CSO discharges. With TARP (as *intended*) fully complete, the system designers predict that less than one CSO event per year will take place. Currently, there are limited CSOs going to the lake annually, which only occur during backflows. However, because of conveyance problems, TARP (as *expected*) may result in up to 10 CSOs per year. Depending on the separation alternative, some portion of this CSO will be discharged to Lake Michigan.

The discussion then focused on three questions: 1) How much additional treatment is expected to be required on CSOs discharged to Lake Michigan; 2) How much additional treatment is expected for CSOs that remain in the Mississippi watershed; and 3) What portion of the treatment costs is caused by the separation project and should therefore be considered a "project cost."

*Reviewers noted that it may be problematic for this study to raise the issue by saying TARP will not function as it is intended. Conveyance issues may be a local issue and that need to be addressed, and associated costs should not be attributed to the separation project. One reviewer stated "It may be appropriate for the study-report to state that TARP must meet the Federal and State requirements for the control of CSOs and that the cost of achieving those requirements is not a cost that should be attributed to the separation project."*

The project likely will assume that local projects will be implemented and that the quantity and number of locations of CSOs will decrease. Guidance is needed on whether we should follow TARP as *intended* or TARP as *expected*.

*After some discussion, there was consensus that both (TARP as intended and as expected) need to be shown, but that we should make clear that conveyance problems (for which local communities are responsible) will result in a TARP-as-expected scenario. That is to say, if the local conveyance system is sufficient to deliver all of the excess stormwater to the larger TARP tunnels, overflow occurrences will be very rare – as intended in the TARP design. This clarification will ensure that stakeholders recognize that failures in the existing collection system rather than the separation will cause the additional untreated CSOs to Lake Michigan.*

TARP is expected to overflow less than once a year. Many professionals working around metropolitan Chicago believe that even when completed, CSOs will occur more than 10 times per year. The additional occurrences are a result of constrictions in the local collection systems. The GLC/Cities Initiative wants to assure that any additional cost to improve those collection systems is not assumed to be a cost of separation. The cost of meeting TARP goals (getting from TARP as expected to TARP as intended) remains a cost of compliance with the Clean Water Act. There is additional local investment needed to transport excess sewage flows to TARP, where they become MWRD's responsibility. These costs are not associated with, and should not be "charged to" separation.

*Reviewers felt that the limitations of TARP as expected need to be disclosed in a manner that ensures that CSO impacts and mitigation costs are not perceived by the public as a cost of separation. Do not relegate TARP as expected to merely a footnote. There is a need to present it as a scenario.*

*There needs to be full disclosure of TARP's limitations. This will get the conversation going early on the issue of the system's limitations. The separation report needs to say that there may be additional mitigation costs related to separation that are due to TARP not acting as intended. Cost-benefit analysis – for separation -- should not take these costs into account.*

CSO impacts will be different if barriers are installed soon, as opposed to when TARP comes fully online in 2029. If the barriers are constructed now, it increases the frequency of lakeside CSOs. If separation waits until 2029, we will increase the risk of AIS movements, but decrease the frequency of CSOs.

*Water quality-related discussions at this time are summarized below.*

*The reviewers felt that there is a messaging issue for the Great Lakes. There is a wide disparity between the level of water quality protection offered in Chicago by MWRD and the requirements imposed on the rest of the region. The CWA requires fishable, swimmable waters. States must review and update standards every three years. Guidance under the CWA calls for less than four CSOs per year. Illinois is not addressing any of these federal requirements. The Illinois Pollution Control Board is considering this, but that*

*may continue to delay a decision. Until then, however, the decision of locations for separation should not be delayed until these requirements are imposed. Also, the cost of compliance with the CWA should not affect the decision of the separation location.*

There are risks of water quality violations (as a result of CSOs) and risks of flooding. Flooding is considered an immediate threat to life and thus will be given priority in this project. Barriers 4/5 are likely to be the best option for controlling flooding, but will lead to a larger combined sewer area draining to the lake with more frequent overflow events. Barriers 18/19 increase the risk of flooding, but decrease the frequency of CSOs to Lake Michigan.

*One reviewer stated that there is no enforceable schedule for TARP. Completion will not happen until a regulatory schedule is in place.*

GLC and HDR representatives pointed out that in a macro political sense, separation likely will require federal funding.

*Because of this, reviewers stressed that we need to come up with a plan that is acceptable to the Great Lakes region as a whole. The region will be amenable to a substantial federal commitment to control AIS. What about the other costs? If funding to deal with AIS is provided, the region will likely expect additional funding to address the other affected areas.*

*Should the federal government pay Chicago to do what they should have been doing anyway (i.e., CSO control and disinfection of treated effluent)? Does the Great Lakes region benefit because of lower risk of AIS movement? Should GLC/Cities Initiative work with suburban communities to identify their needs and input? The MWRD charter is to protect the drinking water source for the Greater Chicago area.*

*Adding a 100 square mile watershed back to Lake Michigan with associated runoff—how will that affect water quality in the lake? Will having the North Shore Channel go to the lake increase water quality treatment needs?*

*The interim and final products need to lay out the issues in a manner that allows the Advisory Committee to clearly identify the costs and opportunities of each alternative. Separation will not solve all problems, so each alternative must provide sufficient context to understand what the problems and impacts are, and which are related to separation and which are not. The messages conveyed on the options may emphasize different issues depending on which audiences are being addressed (e.g., a Great Lakes regional audience vs. a Chicago-area audience) and their respective concerns.*

*There is a need to include a scenario that presents the lowest risk of AIS transfer. What level of risk is acceptable? It is OK to put out straw man scenarios to show that GLC/Cities Initiative have examined a wide range of options?*



*Consider a one-barrier scenario where you cut off the CAWS at the confluence of the Cal-Sag Channel and the CSSC. This creates a total separation between the systems with a single barrier, with the need for upgraded treatment all the way to the lake. It would minimize AIS risk.*

*There is a question regarding whether the states would want to open up issues related to the consent decree related to diversion of Lake Michigan water. This has been a source of significant litigation caused by the creation of the canal in the first place. It is unclear what impact separation would have on the legal issues surrounding the consent decree. It was noted that the study effort did not intend to address the consent decree, diversion or related issues.*

## Day Two Water Quality and River Ecology

The HDR team gave a presentation outlining baseline conditions and potential ecological impacts of the different barrier alternatives being examined. There was discussion of using effluent to supplement flows for water quality to prevent stagnation.

*A question was raised regarding how much increased treatment would be necessary.*

The HDR team stated that the need for additional treatment will have to be addressed and that if you add flow, it's not much more cost to add oxygen which would be helpful to water quality.

*Reviewers raised the question of the need for additional treatment to remove nutrients-nitrogen and phosphorous- to better protect water quality in the almost stagnant waters and because of the impacts of nutrients all the way down to and including the Gulf of Mexico.*

While stagnant water may be a problem, one of the biggest ecological impairments is physical. There have been improvements in habitat over time and these changes would likely be part of a broader effort to increase ecological habitat.

## Days One and Two General Peer Review Comments

- *Need to determine if there is a difference in water quality requirements for effluent discharge into the two watersheds (Lake Michigan vs. the Chicago River).*
- *Some reviewers found the AIS separation project and CAWS improvement aspects difficult to conceptualize as a single comprehensive evaluation. They asked "What is it that you are taking on with the study? It seems like it takes on too much." There was*

*also a fundamental question/confusion about whether this is an AIS study or a CAWS improvement study (water quality, stormwater management, transportation, recreation, etc.).*

- *There seemed to be a sense of puzzlement for some reviewers on the framework for mitigating major impacts. There is little understanding regarding the cost-benefit analysis framework and how to grapple with the no-net impact case. The cost-benefit framework needs to be better developed and explained.*
- *Reviewers saw that there were two kinds of costs that are being addressed: TARP completion costs, which are distinct from separation costs; and costs associated with putting treatment plants on the lake side of barriers, requiring increased treatment to meet Lake Michigan standards (lake discharge vs. river discharge standards).*
- *There was general agreement that a variety of things will have to be done in the CAWS, or that should be done, regardless of whether separation is implemented. The costs for these actions should not be counted as part of the costs of separation.*
- *There was substantial discussion about how to consider, present and reflect costs associated with ensuring that TARP performs as intended, vs. how it currently is expected to perform. There was agreement that we should be clear and honest in noting that TARP currently is not expected to perform as intended, but that the costs required for it to perform as intended are NOT costs associated with separation. It was suggested that our options assume that TARP will not perform as intended.*
- *The question was posed on whether we should let CSOs and associated costs drive the location of the barriers. Barrier 4/5 likely is best to minimize the risk of flooding, but will be most costly for mitigating CSOs. Conversely, barriers 18/19 increases the risk of flooding but reduces costs associated with CSO mitigation.*
- *The report and the options it presents can't solve all the problems that confront – or will confront – CAWS, but it should be clear about the issues.*

### Follow Up Comments

Each of the members of the Peer Review Team was provided a draft copy of the above summary for their review and comment. Their relevant comments on the discussions during the two days have been incorporated above. Some of the reviewers provided additional thoughts upon reflecting on the effort.

These are provided below.

**Reviewer #1:**

*Everyone involved in this study has been told that the ultimate goal is preventing AIS movement between basins through the vector that is CAWS, and failing that, to reduce the risk of AIS movement as much as possible. Whether a proponent, opponent, or neutral/skeptic, that's the project that the stakeholder group has agreed to participate in.*

*The results – the scenarios – that were shown to us, certainly reduced risk, but did not eliminate the CAWS as a potential vector. Instead, they were chosen because they made the most sense from a transportation or a water management perspective. There was no scenario presented that 100% impeded AIS movement, even at the expense of substantial transportation and water management costs or harm, but I think for the validity of the study and for the stakeholder group to mean anything substantial, such a scenario must be presented, even if it is summarily rejected.*

*If shown scenarios that do not fully impede AIS movement, separation proponents will potentially deem the study a failure. At the same time, separation opponents will wonder why X, Y, Z costs must be paid in the transportation or a water management sectors for a non-solution to AIS. If the solution to AIS movement doesn't actually solve AIS movement, why do anything?*

*I am fully willing to believe that the risk of AIS movement cannot be reduced to zero without substantial cost or harm, and concede that some level of risk would likely need to continue to exist in order to prevent mass flooding and other problems. But I am also not a diehard separation proponent. Proponents in particular need to be asked questions along the lines of the following, and ultimately, GLC and GLSLCI and the stakeholder group should probably answer these as well:*

- *What costs/harm are acceptable in exchange for reducing AIS movement risk to 0%?*
- *What costs/harm are acceptable in exchange for reducing AIS movement risk to only in storm of X magnitude/frequency, what about Y magnitude/frequency?*
- *If, in order to prevent AIS movement during a storm, one had to poison outflow to the lake, what would be the acceptable magnitude/frequency of that storm?*

*Those are tough questions, and much harder to answer than ones being faced by opponents, which boil down to whether or not their baseline condition will be harmed or improved by efforts to reduce or eliminate AIS risk.*

**Reviewer #2:**

*Local conveyance problems of the trunk sewers feeding to the TARP drop shafts and deep tunnels probably are only half (or even less than half) of the hydraulic problems that will result in TARP not performing as intended. The conveyance limitations of the deep tunnel system itself are more likely to cause the TARP system to yield more overflows than intended. These conveyance limitations are similar to the hydraulic limitations of the CAWS itself, which was presented on May 10<sup>th</sup>. How can the high inflows to the deep tunnels on the north side of Chicago get 30 to 40 miles downstream to the McCook Reservoir fast enough so that the tunnels still have space for later inflows and CSOs can be avoided? Further, because of the direction of storm movement in the*

*Chicago area, the downstream portions of the TARP Mainstream tunnels will start filling earlier than the upstream (north side) areas blocking the north side flows from getting to McCook. The deep tunnel modeling project, which the University of Illinois is doing for the MWRDGC, seeks to develop a means for the storage and conveyance in the TARP system to be optimized so that the number and volumes of CSOs can be minimized. However, because of the distance from the north side to McCook Reservoir, CSOs more frequent than intended are likely in the region of the North Shore Channel and North Branch Chicago River that will discharge to Lake Michigan post-separation under Scenario 4/5. Without separation these post-TARP completion CSOs might not result in backflows to Lake Michigan, thus, the cost to bring these to Lake Michigan standards could be a cost of separation.*

*The new water-quality standards, proposed by the Illinois Environmental Protection Agency, which the Illinois Pollution Control Board (IPCB) is considering for the CAWS, would not meet the Lake Michigan water-quality standards except in that they would require disinfection at all the Water Reclamation Plants. Thus, regardless of the final decision of the IPCB it is likely that there will be a difference in the water-quality standards between water going to Lake Michigan and water going toward the Illinois River. The reason for the difference in water-quality standards is the result of known habitat limitations of the CAWS (such limitations are recognized by the CWA as reasons for reduced water uses). Such habitat-based differences in water-quality standards are not unique to Illinois in the Great Lakes region. The entire Kinnickinnic River in Milwaukee and the lower Milwaukee River are subject to variance standards in terms of dissolved oxygen (DO) and fecal coliforms because of habitat limitations. Similarly, Cuyahoga River and other rivers in Ohio draining to Lake Erie are designated Modified Warmwater Streams or Limited Resource Waters both of which have lower DO standards than for the General Use Waters of the State of Ohio. Thus, the cost of meeting Lake Michigan standards is a cost of separation.*

**Reviewer #3:**

*I think the framing still needs work. The starting point is constructing barriers to manage AIS. That is a good goal. Constructing barriers has impacts beyond the management of AIS. Will those impacts create benefits (beyond the principal purpose of AIS management) If the barriers cause negative things to happen, how can you ameliorate those negative things and what is the cost of amelioration.*

*When I read this summary and remember the conversation I begin to forget the premise, which is that I want to manage AIS and I have already decided to do so by constructing barriers. OK, that is a good starting point. My ultimate goal is NOT one of improving transportation, stopping flooding, improving water quality, enhancing supplies, and so on. Those are responsibilities of other institutions and organizations that already exist and are having various levels of success in doing their jobs. It is legitimate to ask if my barriers will make their jobs harder or easier.*

*It gets tricky, of course. Who is "in charge" of these things? Who speaks for commercial shipping? The State, the Corps, the barge operators, customers, and so on. I could make the argument that*

*we should phase out water-borne commerce and put an end to its slow death. Organized interests make the opposite point.*

*Because of the multiplicity of actors and dearth of clarity about our goals with respect to each issue, you end up trying to put yourself in their shoes. Who speaks for water quality? MWRD, U.S.EPA, Ill. EPA, the Sierra Club? You find yourselves trying to put together comprehensive plans for all these sub-systems, even though the responsible parties have been unable to do so themselves.*

**Reviewer #4:**

*The issue of property value is one of whether and how changes in property values are treated within the cost-benefit framework in response to "separation" and its attendant environmental benefits and costs. As of now, the comment on same is not accurately reported in the May 19 text. Correctly: changes in property values to reflect costs and benefits are often a useful and legitimate tool in cost-benefit analysis. Changes in property value often reflect the capitalized lifetime value of costs or benefits. However, care should be taken to avoid double counting of costs and benefits. In particular, and for example, if (e.g. recreational) costs of degraded water are counted once, then they should not be counted again in their affect on (lower) property values. Similarly, for example, if greater water quality is counted once as a benefit (e.g. in contingent valuation or survey), then they should not be counted again in enhanced property values (unless these benefits accrue to different parties).*

*There is a logical difficulty in how to treat the "new port" within the cost benefit framework. If the port is compensation to shipping interests, then it is a cost (for damages otherwise realized), and these costs should be made explicit. If instead, the port is self-funding and a good idea in and of itself, then it would seem to fall wholly outside of the cost-benefit framework of separation. Indeed, there may be many such ideas that are beneficial within the scope of transportation and recreation within the CAWS study area. Why focus on this one? To do so will strain credibility—perhaps of the entire study.*

*With regard to TARP and the interaction of CSOs and flooding with separation barriers; I agree that the additional costs associated with separation are not "separation's fault" because TARP may not function as intended. However, I do not know that you can leave the associated costs out of cost-benefit analysis.*

*Timing of barrier installation is everything. If you really believe that TARP will not and cannot be completed in a timely fashion, then you have no choice but to honestly enumerate the (added) costs of a separation barrier attendant to an unfinished TARP. Such costs would figure on the high side since they occur in the near future (e.g. they are not discounted very heavily). Alternatively, to plaintively bemoan that these costs should not be counted as a cost of separation, and to exclude them from the main scenarios, the study would be dishonest. That is because the barriers' immediate implementation would end up being very costly in its impacts. Such an approach is also*

*inconsistent in the sense that the study now claims to perform a holistic C-B of the CAWS basin. That is, by addressing all CAWS-related issues ranging from transportation to recreation, you are committing to compensate or "make whole" all of the major interests.....in other words to count them as costs. But if so, it would be inconsistent (and perhaps arbitrary and biased) to treat differently those interests that would be harmed by flooding, etc., from early installation of a separation barrier.*

HDR

## Envisioning a Chicago Area Waterway System for the 21st Century

External Peer Review #1

May 9, 2011

## Today's Questions

- What invasive species are at risk?
- What is the separation study?
- What is the project focus area?
- What are the challenges of the study?

**Participant Goal: General understanding of the project and area**

HDR

## Two Facts

1. Over 100 years ago, the flow direction of the Chicago River was reversed creating an open connection
2. There is a bidirectional movement of aquatic invasive species between basins

HDR

## Aquatic Invasive Species

Non-indigenous species, or "non-native", plants or animals that adversely affect the ecology of...

HDR

## What invasive species are a risk?

Zebra Mussels

Round Goby

Spiny Water Flea

Asian Carp

HDR

HDR

## What is the Separation Study?

Goal: Evaluate a physical separation of the Lake Michigan and Mississippi River Basins.

HDR

## Consultant Team

Great Lakes Commission and St. Lawrence Cities Initiative  
Project Managers: Tim Eder, Dave Ullrich

PRINCIPAL IN CHARGE: Dave Johnson

PROJECT MANAGER: Scott Stuewe

ASSISTANT PROJECT MGR: Duane Gapinski, P.E.

**DISCIPLINE LEADERS**

- Matt Cochran: Ecological & Fisheries Studies
- Dennis Bruce: Economic Benefit & Impact Analyses
- Marty Joyce, P.E.: Transportation, Maritime, & Recreation
- Dave Clark, P.E.: Water Quality & Sanitary Engineering
- Rich Christopher, Esq.: Legal & Policy Direction
- Bob Beduhn, P.E.: Engineering & Design
- Mark Forest, P.E., CFM: Hydrology, Hydraulics & Flood Control
- Peter Castles: Stakeholder Outreach & Public Involvement
- Jeanne Rene-Malone, LEED: Climate Change & Sustainability

**TECHNICAL ADVISORS/SPECIALISTS**

- Gregg Sass, PhD: Asian Carp
- Toby Frevert, P.E.: EPA Policy
- Phil Moy, PhD: Aquatic Invasive Species
- Ryan Kilpatrick: Stakeholder Outreach
- Bill Miles, P.E.: Locks, Dams, & Canals
- Peter Mulvaney: Water & Wastewater
- Julio Zyserman, PhD: Hydraulics & Coasta
- Irwin Polls: CAVS Hydraulics & Ecology
- John Vickerman, P.E., AIA: Intermodal & Ports
- John Andersen: Agency Coordination

**SUBCONSULTANT LEGEND:**

- Great Lakes Commission
- St. Lawrence Cities Initiative
- Stakeholder Outreach/Public Involvement
- Transportation/Maritime/Recreation
- Civil Engineering
- Geotechnical/Structural/Agency Coordination
- DHI - Hydraulics and Hydrology
- Waterman & Associates, LLC - Hydrology and Geotechnical
- Technical Engineering and Consulting (TEC) - Biology
- Environmental Consulting/Johnson

HDR

## Study Objectives

- Establish baseline conditions
- Provide at least three options for physical separation
- Estimate economic impact
- Provide summarized document

HDR



## Creating Robust Options

- Improve ecology by preventing the transfer of aquatic invasive species
- Improve water quality
- Improve transportation (i.e., movement of goods, materials and people)
- Improve stormwater management

HDR

## Study Process

1. Resource Group data gathering & information sharing
2. Review and Assess
3. **Option Development**
4. **Re-evaluate**
5. **Charrette – filter to 3 options**
6. **Full definition of 3 options**
7. **Analysis**
8. Final Report (December)

Guiding Principles  
Criteria Analysis

HDR

## Study Process

1. Resource Group data gathering & information sharing
2. Review and Assess
3. **Option Development – based on principles, data, AC insights**
4. **Re-evaluate**
  1. **New AC insight**
  2. **Additional data gathering**
  3. **Filter to 5 options and baseline**
5. **Charrette – filter to 3 options** 5 options + baseline
  1. **GLC 1<sup>st</sup> Peer review May 9**
6. **Full definition of 3 options** 3 options + baseline
  1. **AC meeting June 29**
7. **Analysis**
  1. **Criteria Application**
  2. **Option evaluation**
  3. **GLC 2<sup>nd</sup> Peer review August 30**
  4. **AC meeting September 20**
  5. **Draft Report October 30**
8. Final Report (December)

Guiding Principles  
Criteria Analysis

HDR

## Meeting Schedule



HDR

## Deliverables Schedule

- JAN**
  - Project Mgt Plan (Project Guide) – 1.31
  - Work Plan Schedule – 1.31
- MAR**
  - SG Meeting Agendas and Minutes – 3.4
  - Draft Benefit Cost Matrix – 3.16
  - Draft Structure and Logic Model – 3.18
- APR**
  - Baseline Conditions Technical Memo – 4.15
  - External Peer Review #1 Materials Review – 4.29
- MAY**
  - External Peer Review #1 Summary and Response Materials – 5.27
- JUNE**
  - SROI Logic Models – 6.15
  - Draft Summary of Three (3) Options – 6.15
  - AC Meeting #2 Read-aheads – 6.27

HDR

## Deliverables Schedule

- AUG**
  - External Peer Review #2 Materials Review – 8.17
  - Technical Summary Reports – 8.30
  - Updated Cost Benefit Matrix – 8.30
  - Risk Analysis Process Session Summaries – 8.30
  - Input Data Distribution Curves – 8.30
- SEPT**
  - AC Meeting #3 Read-aheads – 9.7
  - Public Meetings Summary – 9.10
  - External Peer Review #2 Summary/Response Materials – 9.12
- OCT**
  - Draft Integration Report – 10.31
  - CAWS-ET Run Report – 10.31
- NOV**
  - Integration Report – 11.30
- DEC**
  - Draft Summary Report – 12.5
  - Final Summary Report – 12.15
  - Presentation to GLC/CI – 12.20
  - CAWS-ET Tool – 12.30

HDR

## Resource Group Engagement

- ✓ Alliance for the Great Lakes
- ✓ American Waterways Operators
- ✓ CMAP
- ✓ Chicago Wilderness
- ✓ Chicago's First Lady Cruises
- ✓ Council of Great Lakes Governors
- ✓ Friends of Chicago River
- ✓ Great Lakes Fishery Commission
- ✓ GLNPO (EPA)
- ✓ Great Lakes Sport Fishing Council
- ✓ Illinois DNR
- ✓ Illinois EPA
- ✓ Illinois International Port District
- ✓ International Joint Commission

✓ Held Meeting • Scheduled ○ Scheduling

HDR

## Interest Group Engagement

- ✓ Metropolitan Planning Council
- ✓ MWRDGC
- ✓ Midwest Generation, LLC
- ✓ NRDC
- ✓ Ninth Coast Guard District
- ✓ Northwest Indiana Forum
- ✓ Office of the Mayor (Chicago)
- ✓ Ports of Indiana-Burns Harbor
- ✓ Reor Viridis
- ✓ The Nature Conservancy
- ✓ USACE, Chicago
- ✓ USACE, Rock Island
- ✓ US EPA 5
- ✓ US Fish and Wildlife
- ✓ US GS
- ✓ Westrech Marina

✓ Held Meeting • Scheduled ○ Scheduling

HDR

## What is the study focus area?

Chicago Area Waterway System  
“The CAWS” of “CAWS System”

HDR

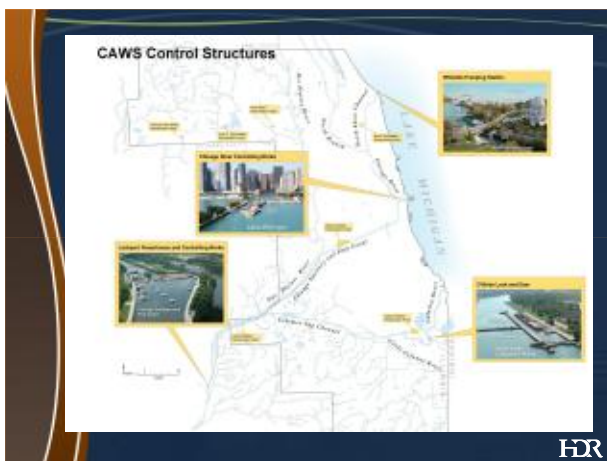
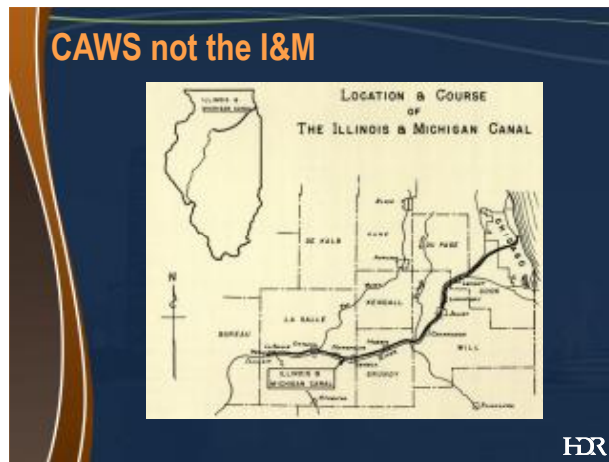
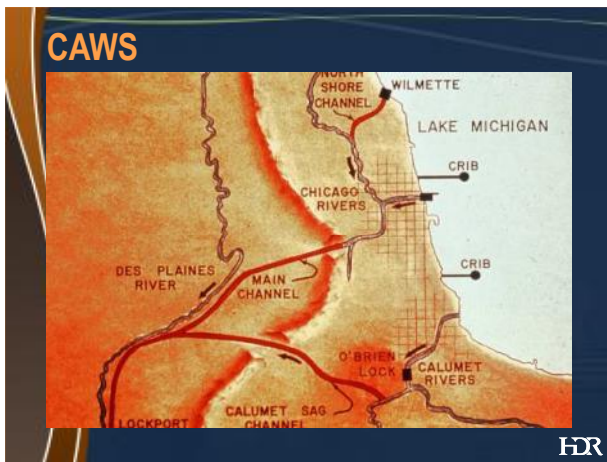
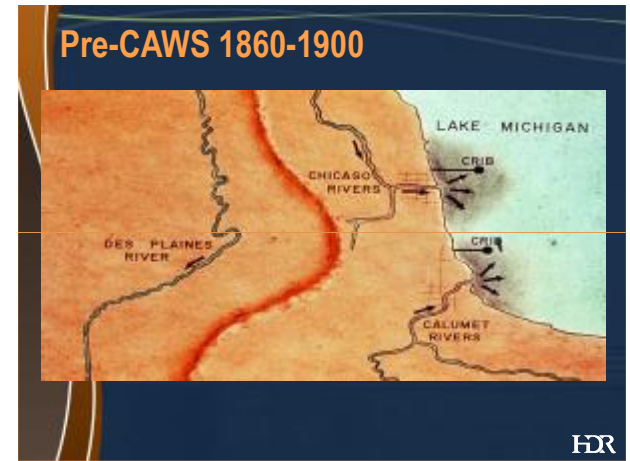
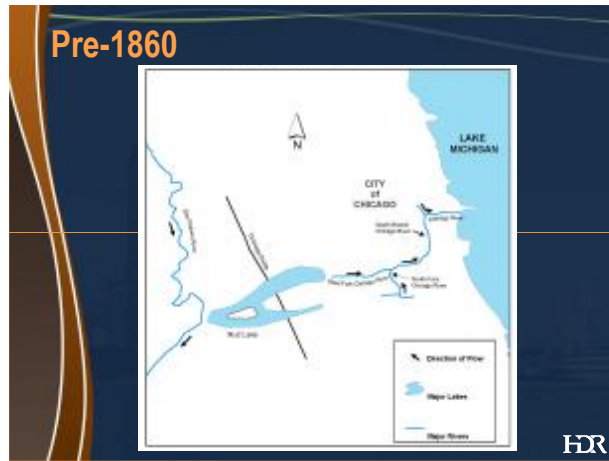

**What are the challenges of the study?**

- Transportation
- Stormwater Management
- Water Quality Standards
- Ecological Health

FDR

**Transportation Challenges**

- Traffic
- Recreational
- Commercial
- Industrial

FDR

## Inland Ports Defined A Convergence of Logistics Trends



Short Sea Shipping Technology



Intermodal Rail



Logistics



Automation



Distribution Center

HDR

## Transportation Information

- Rail (cargo in and out of Chicago region)
- Truck (cargo in and out of Chicago region)
- Water (cargo in and out of ports/CAWS)
- Passenger boats
- Recreational boaters
- Bridge locations
- Air quality
- Existing plans (e.g. CREATE, Calumet)

HDR

## Stormwater Management

- CSO
- Volume
- Flooding
- Water Quality



HDR

## Stormwater Information

- Flooding
- Water source flows/outlet flows
- Sewer atlas
- Backflow volumes to Lake Michigan
- CSO discharges
- Mathematical modeling (flow quantity)
- Existing plans (stormwater and CSOs)

HDR

## Water Quality and Ecology

- Water Quality Standards
- Ecological Habitat



HDR

## Water Quality Information

- Chemical water quality
- CSO discharges
- Industrial dischargers (NPDES)
- Backflow effects on water quality
- Existing water quality modeling
- Improvement plans ( e.g. wastewater)

HDR

## Ecological Information

- Physical habitat
- Water quality
- Biological communities
- Invasive species surveys
- Chemical sediment quality
- Climate change effects

HDR

## Questions?



HDR

HDR



## Re-writing History

- Challenging project
- Very unique study area
- Impacts millions of people
- Protect a \$7 billion fishery



HDR

## Sustainable Return on Investment (SROI) = Calculating The Triple Bottom Line

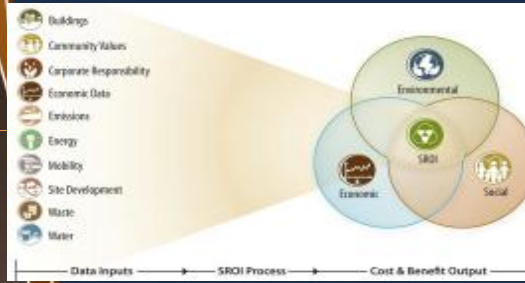

38

HDR

## North America's Inland Waterway System

(A Strategic Connection to the US Gulf Coast & St Lawrence)

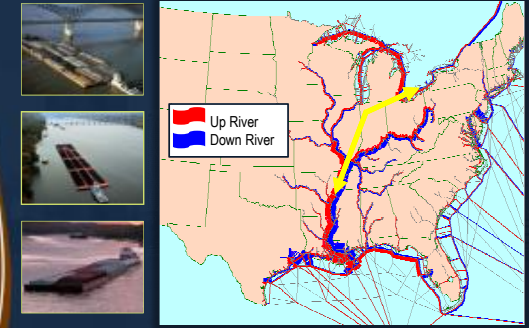

## North American Emerging Mega-Regions

(Future US Growth Areas)

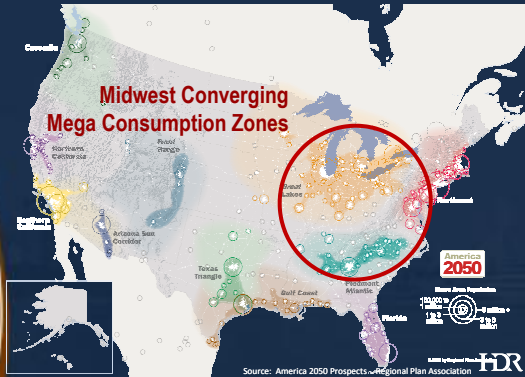

HDR

## Panama Canal Vessel Deployments Will Determine New US Logistics Patterns

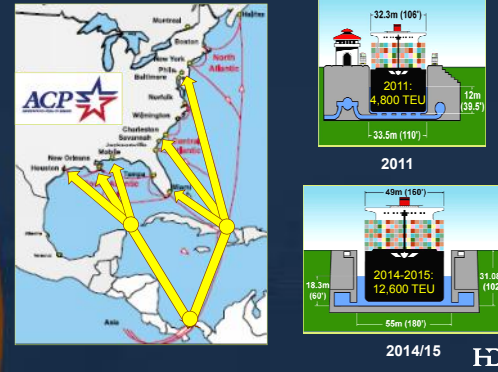

HDR

## CAWS & CREATE Systems Overlay



HDR

## Potential Inland Intermodal Port Logistics Centers as a Part of the AIS Separation Strategy



HDR

## Information Collection Categories

- Transportation
- Economics
- Water Quality
- Ecology
- Stormwater

HDR

## Data Collection has Value Beyond Project

- Inform Additional Studies (e.g. USACE GLMRIS)
- Resource Library to GLC/CI

HDR



### Study Process

1. Resource Group data gathering & information sharing
2. Review and Assess
3. **Option Development – based on principles, data, AC insights**
4. **Re-evaluate**
  1. **New AC insight**
  2. **Additional data gathering**
  3. **Filter to 5 options and baseline** 5 options + baseline
5. **Charrette – filter to 3 options**
  1. **GLC 1<sup>st</sup> Peer review May 9** 3 options + baseline
6. **Full definition of 3 options**
  1. **AC meeting June 29**

Guiding Principles  
Criteria Analysis

HDR

### Summary and Presentation

- Prepare a **Final Integration Report** for the GLC/CI by Dec. 15, 2011
  - Prepare a **Final Summary Report** geared toward a more public audience
- **Final Presentation** to GLC/CI Dec. 20, 2011

HDR



### Existing Regional Transportation Conditions

- Chicago is major U.S. transportation freight hub for trucking, air, rail, and waterways
  - Trucking system carries \$572 billion in goods each year
  - Over 500 trains operate daily carrying \$350 billion in goods each year
  - Full connectivity between Chicago, Great Lakes and Mississippi River system

Source: CMAP GoTo 2040

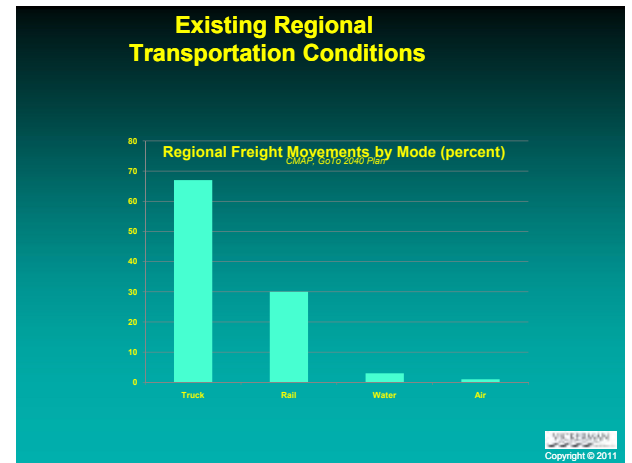

### Regional Transportation – Limitations & Challenges

- Interstate and truck routes congested
- Rail system slow operating speeds, bottlenecks
- Lock delay, channel conditions, deferred maintenance
- Total tonnage expected to increase substantially over next 30 years



### GoTo 2040 Recommendations

**Implement Regional Trucking Improvements:**

- Dedicated Truckways (proposed Illiana Expressway, I-55/Stevenson Expressway, connections between intermodal freight terminals)
- Expand Regional Truck Route System
- Explore Centralized Freight Distribution Nodes

**Establish Regional Freight Authority to Guide Policy and Funding Priorities**

### GoTo 2040 Recommendations

- Implement the Chicago Region Environmental and Transportation Efficiency (CREATE) Program & Begin Planning for Next Phase
  - Partnership between all of the Class I Railroads; the federal government; the State of Illinois; Metra; Amtrak; and the City of Chicago.

### Status of CREATE Projects (2/4/11)

**71 Projects, \$2.5 Billion**

- Tracks, switches and signal system upgrades
- Highway/Rail Separations
- Rail/Rail Separations
- Viaduct Improvements
- Crossing Improvements

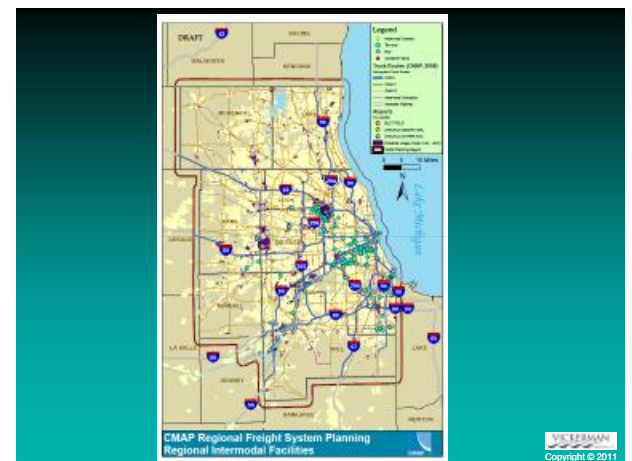





VILKERMAN  
Copyright © 2011

## CAWS System Existing Conditions

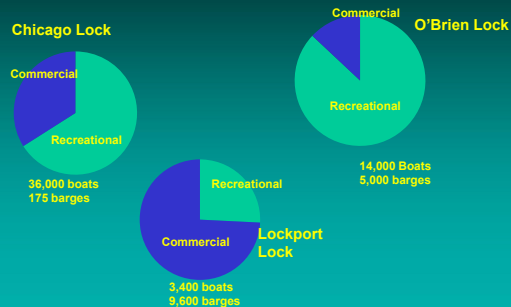

VILKERMAN  
Copyright © 2011

## Total Barge Traffic for 2010 (loaded plus empties)

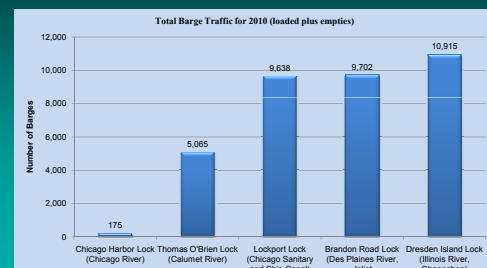

VILKERMAN  
Copyright © 2011

## Total Tonnage Trends for Chicago area locks

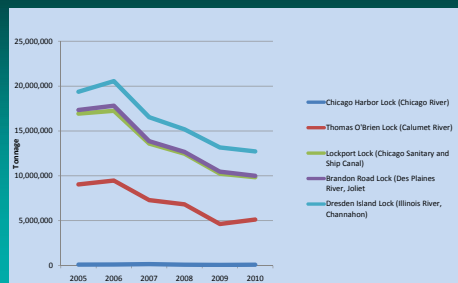

VILKERMAN  
Copyright © 2011

## Statistics for Chicago and T. J. O'Brien Locks Cargo, Commercial Passenger, and Recreation

Year	Cargo Tons		Commercial Passengers		Recreation Vessels	
	Chicago	O'Brien	Chicago	O'Brien	Chicago	O'Brien
2000	146,518	8,436,179	318,059	341	42,006	32,581
2001	140,547	6,373,306	377,605	741	39,510	29,790
2002	142,135	7,516,389	369,403	674	40,598	30,314
2003	144,842	6,312,080	315,116	1145	33,696	29,014
2004	89,795	5,074,828	305,266	719	30,606	29,522
2005	111,319	5,048,078	320,196	442	29,690	29,653
2006	127,600	5,462,367	306,400	202	25,540	20,744
2007	162,830	7,284,460	275,136	302	30,244	23,140
2008	105,191	5,000,000	260,000	230	27,614	29,205
2009	76,749	4,641,353	365,019	431	26,327	18,100
Average 2000-2009	122,737	7,677,196	701,817	605	32,551	25,062

98% Cargo

99% Pass.

Terminal Name	Commodity
OCCIDENTAL CHEMICAL	Calcium Chloride
IMPHRIAL OIL	Fuel Oils, Sulphur, Asphalt
MILWAUKEE BULK TERMINAL	Scrap Metals
GATX TERMINALS CORP	Chemicals
O'Brien Lock	
FOXON MOBIL	Petro. Crude, Bitumen, Asphalt
MORTON SALT	Sodium Chloride
SILVERDALE	Iron Ore
ST. MARY'S CEMENT	Portland Cement
DELTA BULK TERMINAL	Flat Rolled Products of Iron

Source: USACE - OMNI/LPMS Data

VILKERMAN  
Copyright © 2011

## 2009 Commodity Traffic Flows

Sections Included: Chicago Harbor, Chicago River, Chicago Sanitary and Ship Canal, Calumet-Sag Channel and Lake Calumet, IL, Calumet Harbor and River, IL and IN.

2009	All Traffic Types (Domestic & Foreign)				
	All Traffic Directions	Receipts	Shipments	Intraport	Total all Traffic
All Commodities	100%	45%	33%	21%	100%
Total Crude Materials, Inedible Except Fuels	36%	68%	16%	16%	100%
Total Coal, Lignite and Coal Coke	25%	1%	48%	51%	100%
Total Petroleum and Petroleum Products	18%	36%	52%	13%	100%
Total Primary Manufactured Goods	12%	75%	22%	3%	100%
Total Chemicals and Related Products	7%	73%	23%	4%	100%
Total Food and Farm Products	2%	17%	83%	0%	100%
Total All Manufactured Equipment, Machinery	0%	98%	2%	0%	100%

VILKERMAN  
Copyright © 2011

## CAWS System Statistics (2007)

- Chicago Harbor**
  - 1.7M tons shipped on the Main and North Branch of the Chicago River; 149K tons directly received through this harbor
- Calumet Harbor**
  - 14.6M tons shipped or received
  - connected to 154 commercial ports; ships to 74 ports, and receives from 80 ports
- Lake Calumet**
  - 3 transit sheds totaling over 315,000 sf; 3000 lf of ship and barge berthing space.
- Over 200 Barge Facilities on the CAWS**

VILKERMAN  
Copyright © 2011

## CAWS System Statistics

- 73 million tons of waterborne freight moved in the Chicago region in 2007

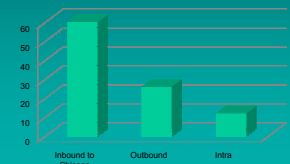

VILKERMAN  
Copyright © 2011



VILKERMAN  
Copyright © 2011



## Barrier Location 4/5- Transportation Analysis

- South Branch Chicago River, below Wolf Point
- The majority of industrial travel would not be impacted;
- Commercial traffic would maintain most of its activity.
- Recreational boaters would lose access to some dry dock and marinas, but few travel past this reach for recreation

## Barrier Location 12- Transportation Analysis

- Calumet River, upstream of Calumet Treatment Plant
- Barge traffic greatly impacted, separated from economic center and direct access to lakers.
  - Recreational traffic between the Calumet River and the Little Calumet or CalSag eliminated.

## Barrier Location 18/19 Transportation Analysis

- Chicago River (18) and North Shore Channel (19)
- Major impact to recreational, commercial and some industrial flow into the existing CAWS.
- Many marinas and dry docks would be inaccessible from the lake.
- Lakeside portion could become a new asset for marina or other recreational uses.
- No major impact to North Shore Channel

## Barrier Location 19 Transportation Analysis

- North Shore Channel above outfall from North Side WRP
- Primarily recreational uses, no major impact
- Lake oriented recreational opportunities and marinas may expand with the increased footage and access to Lake.

## Barrier Location 20 Transportation Analysis

- Calumet River – Lakeside of Lake Calumet confluence
- Upstream: Major industrial corridor. Barge traffic greatly impacted.
- Recreational traffic between the Calumet River and the Little Calumet or CalSag eliminated.
- Downstream: Barge and recreational traffic could operate up to the barrier, but would then need a different handling mechanism.

# BACKGROUND ON THE HYDRAULICS OF THE CHICAGO AREA WATERWAY SYSTEM

Charles S. Melching  
 Department of Civil and Environmental Engineering  
 Marquette University  
 Milwaukee, WI 53201-1881

# EVALUATION OF PROCEDURES TO PREVENT BACKFLOWS TO LAKE MICHIGAN FROM THE CHICAGO WATERWAY SYSTEM

Charles S. Melching and Emre Alp  
 Department of Civil and Environmental Engineering  
 Marquette University  
 Milwaukee, WI 53201-1881

Flow volume of backflow events (in million gallons) from 1990-2009.

Date	O'Brien	CRCW	Wilmette	Total
3/7-8/09			143.1	143.1
2/26-27/09			78.9	78.9
12/27/08			460.8	460.8
9/13-14/08	2669.2	5438.2	2941.7	11049.1
8/23-24/07			224.0	224.0
8/22/02		1296.4	455.4	1751.8
10/13/01			90.7	90.7
8/31/01			75.3	75.3
8/02/01		883.1	139.9	1023.0
6/13/99			9.7	9.7
8/16-17/97		402.0	157.0	559.0
2/20-22/97	1458.0	1947.0	774.0	4179.0

## DUFLOW Model Inflows

- Gravity CSO : Corps Flows (from HSPF, SCALP, and TNET) [hourly]
- Pump CSO : Estimated Flows (MWRD) [hourly]
- Upstream Flow Boundary: Columbus Drive, Wilmette, O'Brien L&D :USGS 5-min flow, MWRD Backflow (99-Wilmette: daily average, 97-Wilmette : Simulated hourly flow) (February/97-O'Brien: USGS estimated daily average flow)
- Downstream Stage Boundary: Lockport Controlling Works (MWRD) [hourly]
- Treatment Plants: Measured (MWRD) [hourly]
- Tributaries: Midlothian Creek, Tinley Creek, Little Calumet River (S), Calumet River, North Branch (at Albany Avenue): Measured (USGS) [15-min.]
- Ungaged tributaries : Estimated based on Midlothian Creek area-ratio basis [15-min.]

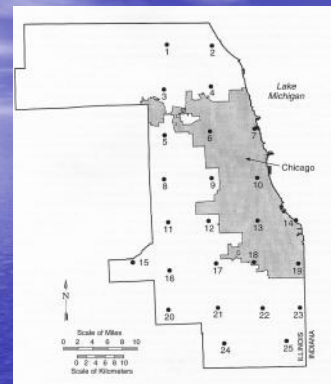

U.S. Army Corps of Engineers/Illinois State Water Survey  
 Raingage Network

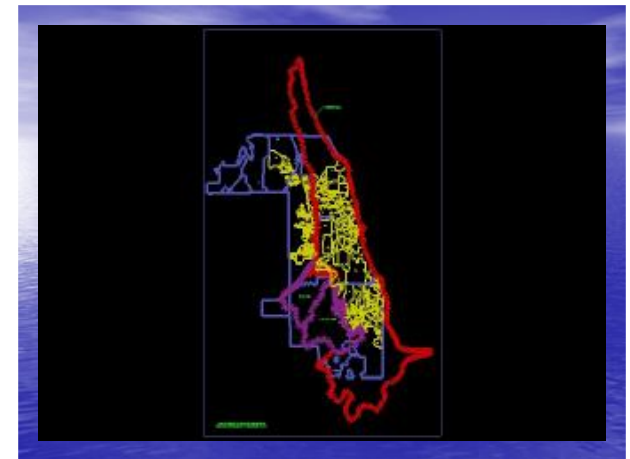

## U.S. Army Corps of Engineers Diversion Accounting Models

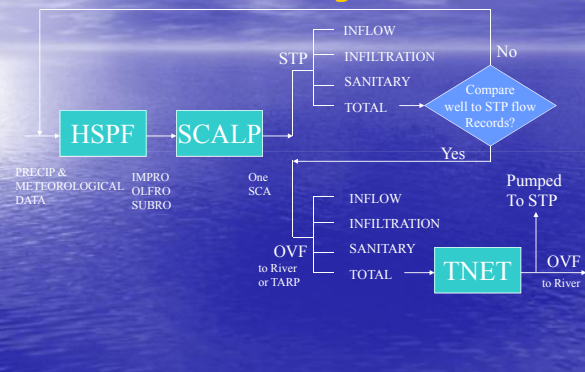

## Flow Model Results-August 1998-July 1999



Error relative to depth of water flow

Periods	Total no. of Stages	Western Av.		Willow		Cal Sag Junction		Romeoville	
		<±1%of D	<±2%of D	<±1%of D	<±2%of D	<±1%of D	<±2%of D	<±1%of D	<±2%of D
August	337	96.44	100	86.35	99.70	90.80	97.92	96.44	98.52
Aug_Sep	457	98.25	100	75.27	99.12	92.56	99.56	95.62	100
Sep_Dec	2665	96.19	100	83.90	99.06	84.09	99.17	91.18	99.85
Jan_Feb	673	94.95	100	88.86	100	78.75	100	87.37	99.85
Feb_May	2617	93.74	99.79	85.39	98.94	80.75	99.05	93.43	99.35
May_June	409	94.87	100	81.42	99.51	87.78	97.56	92.42	96.82
June_July	817	97.80	100	85.19	99.88	93.88	99.88	96.70	99.88
July	169	98.22	100	79.88	99.41	87.57	100	92.31	99.41

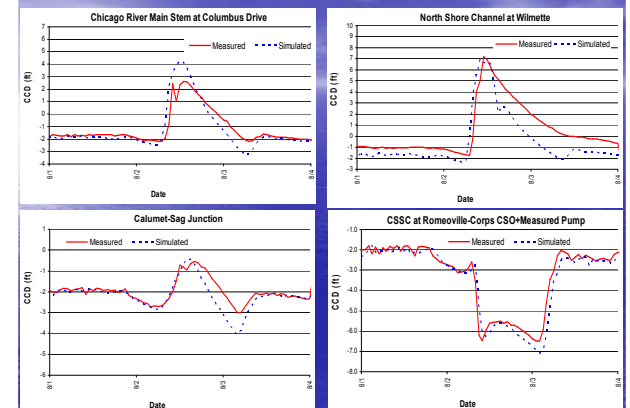
## 2001

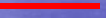

# Simulations

- Baseline  No Backflow during actual backflow event
- Measured 
- Gates open before/until CSO (Lockport Water-surface Level=-3ft, -5ft, -7ft for 3,5, 7 hrs)  Actual Gate Openings during event
- Gates open during CSO (Lockport Water-surface Level=-9ft for 6-12 hrs) 
- CRCW minimum water-surface level = -3 ft CCD
- Calumet-Sag Junction minimum water level = -4 ft CCD

# 2002

## Backflow Event:

August 22

- CRCW : 1296.4 million gallons
- Wilmette : 455.4 million gallons

# August 22, 2002

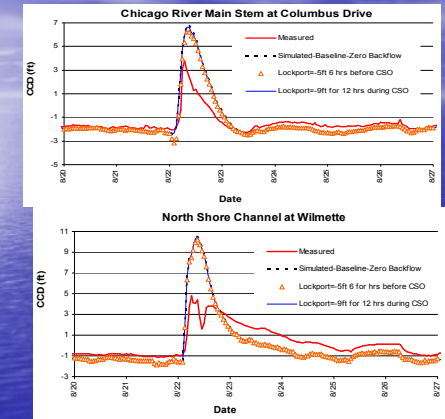

# August 22, 2002

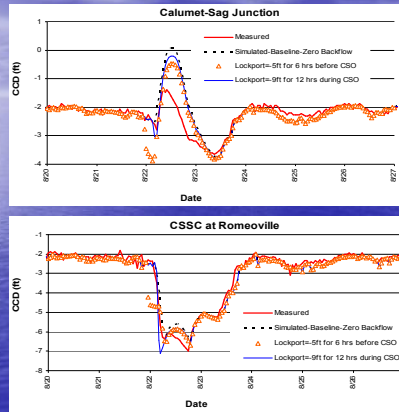

# August 22, 2002

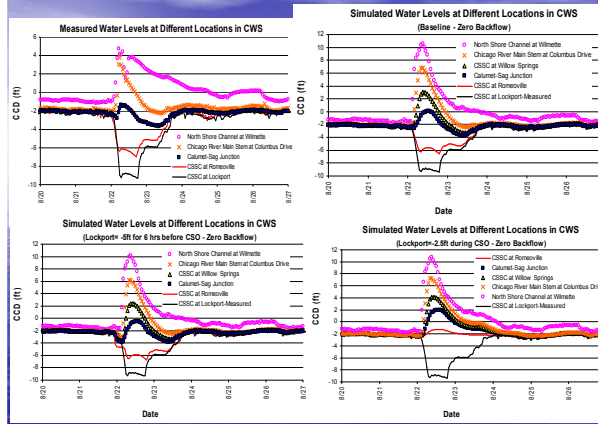

# Measured and Estimated Inflow to and Measured Outflow at Romeoville, IL, from the Chicago Waterway System, August 22-24, 2002

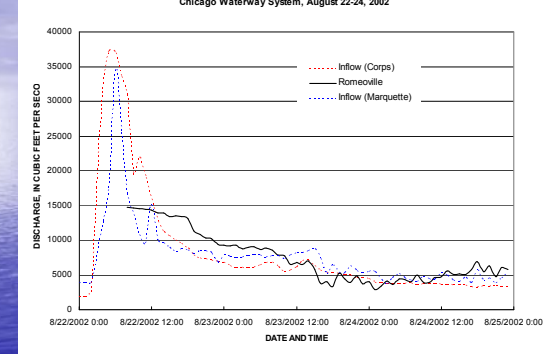

# August 22, 2002

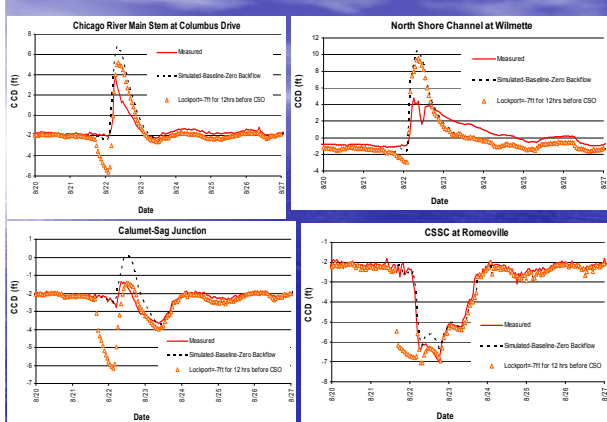

# 2001

## Backflow Events:

October 13

- Wilmette : 90.7 million gallons
- August 31
- Wilmette : 75.3 million gallons

August 2

- Wilmette : 139.9 million gallons
- CRCW : 883.1 million gallons

# August 2, 2001

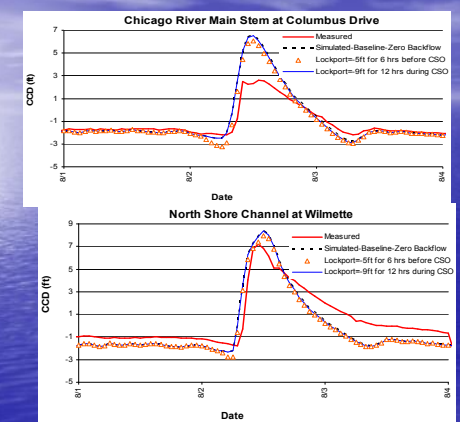



August 2, 2001

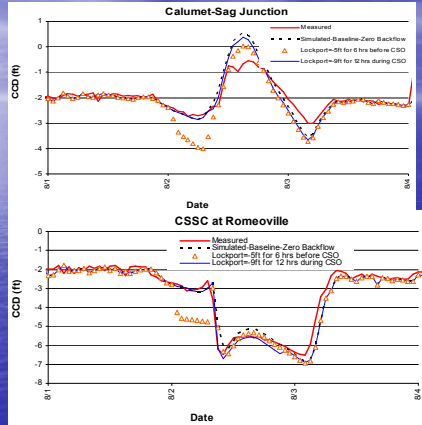

August 2, 2001

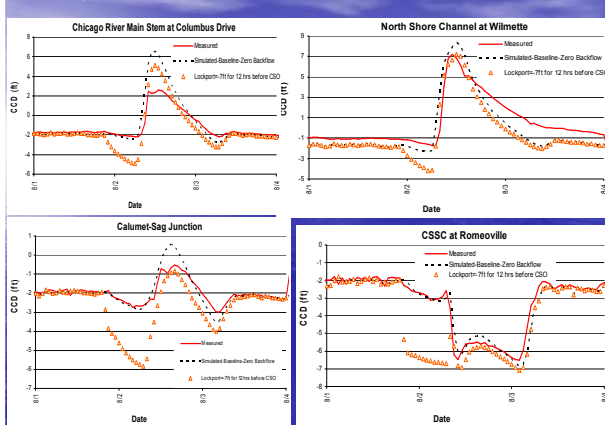

August 2, 2001

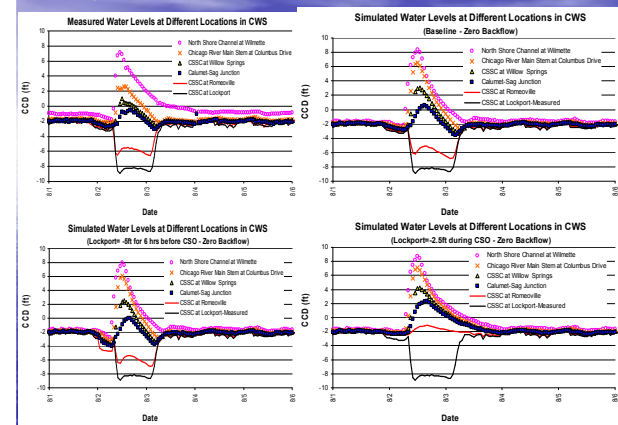

Measured and Estimated Inflow and Measured Outflow at Romeoville, IL, from the Chicago Waterway System, August 2-6, 2001

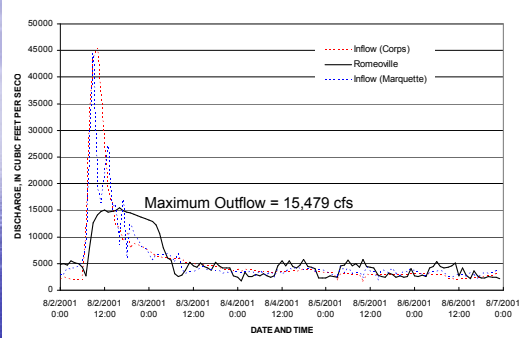

## Conclusions

- Changed operations of the gates at Lockport cannot prevent backflows to Lake Michigan because the flow capacity of the Chicago Waterway System (CWS) is not large enough to drain away high storm flows
- The high storm flows quickly fill the storage space created by lowering the CWS by opening the gates at Lockport in anticipation of a large storm, and water-surface elevations at the lakefront quickly rise necessitating backflows

## Conclusions—cont.

- There appears to be nothing that the Metropolitan Water Reclamation District of Greater Chicago can do to avoid future backflows until the reservoirs of TARP come on line and the volume of CSO flows is further reduced.

## Water-Surface Elevations on the Little Calumet River, Calumet River, and Calumet-Sag Channel during a flood.

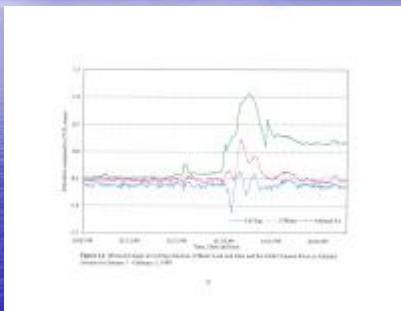

Simulated peak water-surface elevation for the Chicago River Main Stem, South Branch of the Chicago River, and Chicago Sanitary and Ship Canal from Columbus Drive for the simulated 50- and 100-year floods.

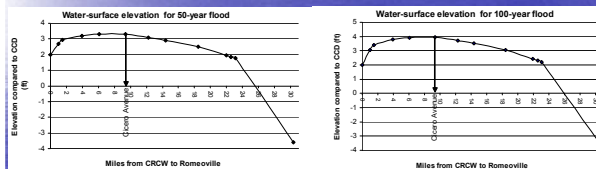

## What about real large events?

Westcott (2002) estimated that the August 2, 2001, event corresponded to:

- The 50-year storm at gage 10 (West 26th Street,
- The 25-year storm at gages 7, 12, and 13 (Broadway United Methodist Church, near Bedford Park – CP Hall, and Greune Coal Company, respectively), and
- The 2-year to 10-year storms at other locations in the network.

Measured water-surface elevations in the Chicago Waterway System during the flood of Aug 2, 2001.

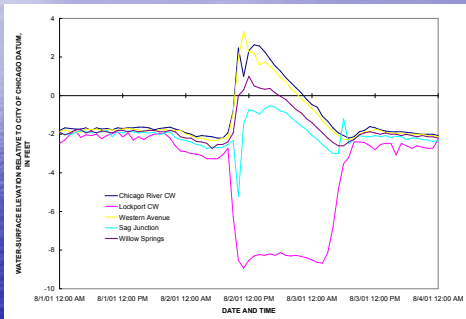

### Model Application – Navigation Make Up Water Study

In anticipation of storms the MWRDGC often draws down the CWS to provide storage space for runoff and increase the hydraulic gradient for moving flood water faster out of the CWS while maintaining water levels at or above -2 ft CCD at CRCW and O'Brien by taking water (called "navigation make up water") from Lake Michigan.

If the storm does not materialize or it is smaller than expected the MWRDGC must also take navigation make up water to refill the CWS.

### Model Application – Navigation Make Up Water Study

- Currently, the CFR requires that water levels at CRCW and O'Brien must be maintained at -2 ft (-0.610 m) relative to the City of Chicago Datum, CCD
- It has been proposed that a water level as low as -3 ft CCD (-0.914 m) be allowed during storm periods to reduce diversions from Lake Michigan.

### Model Application – Navigation Make Up Water Study

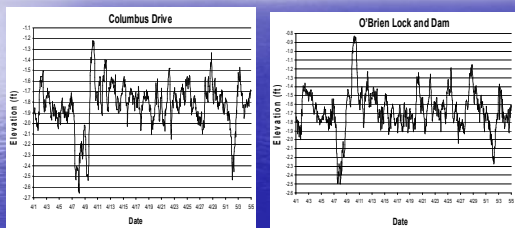

### Model Application – Navigation Make Up Water Study

Table 7 - Comparison of flows at the lake front controlling structures simulated with the measured water-surface elevations (calibrated model) and the water-surface elevations held at -2 ft City of Chicago Datum (scenario = -2ft)

		Columbus		O'Brien		Wilmette	
		Scenario=-2ft	Calibrated Model	Scenario=-2ft	Calibrated Model	Scenario=-2ft	Calibrated Model
April 7-9	Average (m <sup>3</sup> /s)	16.3	-7.6	9.5	7.9	-3.1	-1.4
May 1-3	Average (m <sup>3</sup> /s)	19.7	-4.1	12.8	13.4	1.0	2.0

### Model Application – Navigation Make Up Water Study

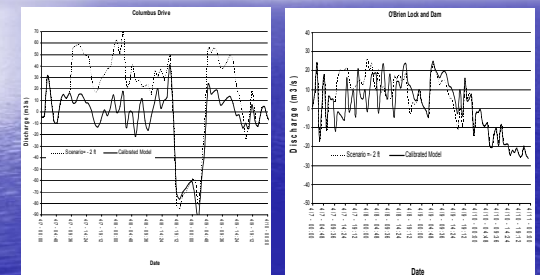

### Model Application – Navigation Make Up Water Study

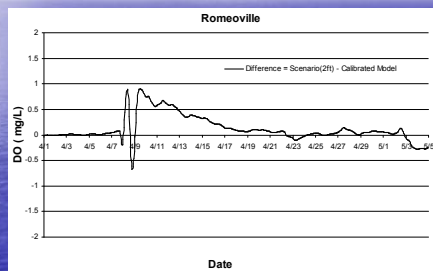

### Model Application – Navigation Make Up Water Study

Table 8 - Average change in dissolved oxygen concentration for the April 7-9 storm comparing the simulation holding water-surface elevations at the lake front at or above -2 ft City of Chicago Datum with the simulation using observed water-surface elevations at the lake front

Location	Average	River Mile	Water Course
Addison Street	0	40.3	North Branch Chicago River
Pullerton Avenue	0	38.4	North Branch Chicago River
Division Street	-0.1	36.3	North Branch Chicago River
Kinzie Street	-0.7	34.8	North Branch Chicago River
Jackson Boulevard	2	34	South Branch Chicago River
Cicero Avenue	1.2	26.3	Chicago Sanitary and Ship Canal
Baltimore and Ohio Railroad	0.5	21.3	Chicago Sanitary and Ship Canal
Route 83	0.4	13.1	Chicago Sanitary and Ship Canal
River Mile 11.6	0.4	11.6	Chicago Sanitary and Ship Canal
Romeoville	0.4	5.2	Chicago Sanitary and Ship Canal
Halsted Street	0.3	29.1	Little Calumet River (North)
Division Street	0.2	27.6	Calumet-Sag Channel
Kedzie Avenue	0.2	26.1	Calumet-Sag Channel
Cicero Avenue	0.2	24	Calumet-Sag Channel
Huffman Avenue	0.1	20.7	Calumet-Sag Channel
Southwest Highway	0.2	19.7	Calumet-Sag Channel
Route 83	0.2	13.3	Calumet-Sag Channel

### North Shore Channel—CSO/Drop Shaft Locations

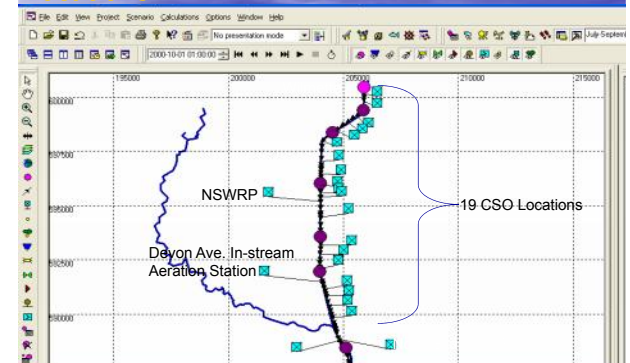

## Water Reclamation Plants

Characteristics of effluent from WRPs for May 1 to September 24, 2002

	DO (mg/L)	CBOD <sub>5</sub> (mg/L)	NH <sub>4</sub> (mg/L)	NO <sub>3</sub> (mg/L)	N <sub>org</sub> (mg/L)	P <sub>org</sub> (mg/L)	P <sub>in</sub> (mg/L)	SS (mg/L)
North Side WRP								
mean	7.23	5.86	0.53	6.88	1.12	0.08	1.18	4.53
STD	0.05	1.97	0.38	1.04	0.28	0.02	0.48	1.31
Stickney WRP								
mean	7.83	4.54	0.41	7.63	1.58	0.08	1.22	4.56
STD	0.76	1.82	0.45	1.55	0.46	0.03	0.74	1.93
Calumet WRP								
mean	7.53	3.43	0.11	6.66	1.48	0.07	3.12	4.14
STD	1.00	1.09	0.07	1.29	0.42	0.02	1.07	1.39
Lemont WRP								
mean	6.30	5.99	0.22	13.18	1.73	0.11	2.68	6.40
STD	0.66	4.72	0.23	2.42	0.52	0.09	0.61	5.28



[Comments](#)  
[Questions & Answers](#)

**HR**

## External Peer Review #1: Water Resources

May 9, 2011

Bob Beduhn, HDR  
Peter Mulvaney, Greenleaf Advisors  
Paul Dierking, HDR

## Discussion Outline

- Background
- Location Evaluation
- Flooding
- CSOs
- Mitigation

**HR**

## Background

### Understandings

- Historic peak flows are upper limits
- River elevations are factor in water in basements
- Minimum depths needed for navigation
- No "spill" is ultimate goal
- Interim goal is to limit "spill" to match existing flood risks

### Key Data

- Identify Inflows
  - Upper North Branch
  - Treatment plants
  - Pump Stations
  - Gravity CSOs
- Identify Outflows
  - Wilmette
  - Chicago
  - O'Brien
  - Channel Capacities

**HR**

## Location Evaluation

### General Process

- Bracket above and Below Key Inflows
- Evaluate Direction
- Evaluate Min & Max Flow Rates
- Consider Mitigation Implications

### Mitigation

- Storage
  - Priority to floodplains
  - Lowest priority to deep pumped storage
- Conveyance
  - Channel morphology
  - Additional Tunnel
- Inflow Reductions
  - Reducing impervious areas
- Flow & DO Augmentation

**HR**

## Barrier Water Resource Considerations

### Lakeside

- River Flows (Min, Max, Direction)
- River Depth
- Stormwater Volume
- Water Quality
  - Stagnation
  - CSO
  - Sediments
- Create Watershed

### Riverside

- River Flows (Min, Max, Direction)
- River Depth
- Stormwater Volume
- Water Quality
  - Stagnation
  - CSO
  - Sediments

**HR**

## Flooding Concerns

### Overbank / Water in Basements

- Peak Flows
- Max Volumes
- Timing
- River Elevations

### Water Quality

- Loading – Annual Volume
  - Nonpoint and CSO
- Assimilation
  - Single Large CSO event
  - Frequent CSOs
- Standards – Lake and River
- Social Perceptions

**HR**

## CSOs

- Understand the Basin
  - Area, pipe network
  - City Model (event based)
- Assume Frequency
  - ISWS report
  - U of I preliminary modeling
  - Professional Judgment
- Treatment (negotiated)
  - River and Lake standards
  - Frequency vs. treatment
  - Upper threshold of treatment
  - Bypass and degree "cleaned"
  - Human vs. ecological benefits

**HR**

## Backflow / CSO Frequency

Condition	Backflow	Lakeside CSO	Riverside CSO
Current	Up to once per year	ZERO	~20 times per year
With TARP as Intended	Less than once in 10 years	NA	Less than once per year
With TARP as Expected	Less than once per year	NA	Up to 10 times per year
EPA guidance < 4	What kind of treatment?	What kind of treatment?	What kind of treatment?

**HR**



## **C2. PEER REVIEW II**

- MEETING AGENDA 8-31-2011
- MEETING MINUTES AND COMMENTS
- ECONOMIC ANALYSIS PRESENTATION



***Peer Review Team Agenda / Schedule***  
***Envisioning a Chicago Area Waterway System for the 21st Century Project***

**August 31, 2011**  
**8:30 to 4:30PM**

Welcome / Introductions	8:30
GLC & Cities Initiative Comments	
Reminder: Purpose of Peer Review	8:45
Anticipated Outcomes	
HDR Presentation	
Progress since last meeting	9:00
HDR Presentation	
Barrier Options	9:15
Peer Review Team	
Discussion of Barrier Options	10:00
HDR Presentation	
Transportation Origin/Destination	11:00
Peer Review Team	
Discussion of Origin/Destination	11:15
Lunch	11:45
HDR Presentation	
Quantification of Benefits	12:30
Peer Review Team	
Discussion on Benefit Quantification	1:00
HDR Presentation	
Cost and Economic Analysis	1:30
Peer Review Team	
Discussion of Economic Analysis	2:45
Wrap-Up Discussions	4:00
Adjourn	4:30

***Envisioning a Chicago Area Waterway System  
for the 21st Century Project***

**Peer Review Session Two**

August 31, 2011

On August 31<sup>st</sup> 2011 a Peer Review Team was convened to review the progress made to date by the HDR team. The session took place in the Chicago offices of HDR and was facilitated by staff from Environmental Consulting & Technology, Inc. [ECT]. A purposefully diverse group of experts was selected to provide input to the project from wide perspectives.

The purpose of the effort was to:

- Obtain objective, outside expert perspectives
- Identify concerns that may be raised by others, and
- Validate the process being undertaken.

The desired outcomes as stated at the beginning of the session were:

- Pose specific technical questions to the HDR Team
- Allow HDR to interactively provide answers
- Raise issues/concerns that need to be considered prior to public review of the material
- Facilitate potential resolutions of the issues identified
- Propose any “redirection” that could improve acceptance of the final recommendations.

The Peer Review Team consisted of the same individuals that were convened for the first review session in May, 2011.

They are: **Frank Beal**, Executive Director of Metropolis Strategies (formerly Chicago Metropolis 2020); **Josh Ellis** of the Metropolitan Planning Council (MPC); **William Testa** who sits on the boards of the Illinois Council on Economic Education, Chicago Council on Global Affairs and the Economic Development Council of Chicago; **Dr. Charles Melching**, Professor of Civil and Environmental Engineering at Marquette University; and, **Dale Bryson** the former Director of EPA's Region 5 water division.

Matt Doss (representing GLC and the Cities Initiative) along with Jim Ridgway, John Bona and Jodi McCarthy from ECT were also in attendance.

One notable key point emerged that needs to have further discussion with the sponsors.

**Most reviewers felt that the effort as outlined wasn't “envisioning a waterway system for the 21<sup>st</sup> century”, but rather achieving separation while attempting to maintain the status quo with respect to water quality, flooding and transportation.**

Additional key points that emerged during the discussions that took place are shown below.

- No major concerns were expressed on economic analysis
- The analysis should identify which options provide the highest degree of security against AIS movement. Or if they are truly equal in protection make that point clear.
- The effort needs to be realistic about the declining use of shipping
- The transportation analysis should consider other options other than barge to move materials
- It was agreed that past case studies are to be used for the AIS benefit analysis
- Water quality should be added as a benefit category
- The analysis should discuss possibilities for using new approaches that will reduce flooding and improve water quality.

### Format

The meeting began with a brief review of the project's purpose and the role of the Peer Review. Roles of the Great Lakes Commission and the Great Lakes and St. Lawrence Cities Initiative were presented, and the scope of the HDR Team's effort was reviewed.

Peer review team members were encouraged to actively interact with the presenters to question assumptions, provide input and make suggestions. Members were reminded that comments made would all be attributed to "the review team" – not to individual members – to promote an open and candid dialogue.

The following pages present a compilation of notes taken over the day-long session. They are formatted generally with presentation materials left justified and Peer Reviewer comments *indented and italicized*. Copies of the PowerPoint presentations made by the HDR team are attached to this report.

### Opening Comments

The Great Lakes Commission (GLC) and the Great Lakes and St. Lawrence Cities Initiative (Cities Initiative) shared their appreciation for the time and contributions of this group. They are happy with the outcome of the previous peer review meeting. They continue to be amazed at how complex the issues are. As work proceeds new challenges continue to emerge. The HDR project team has narrowed down separation alternatives to three options for the combination of barrier locations from the original 20. The team has been developing timing, phasing, environmental impacts. They now need to analyze the cost / benefit and create a credible accounting of long term benefits and how to quantify those benefits. They want to make sure that benefits stated are credible

The final advisory committee meeting will be in October and the "preview" meetings start in 2 weeks (more informal meetings to acquaint people with the process / project) and there will be a series of public meetings in Chicago, Toronto, and Indiana. There is a series of Great Lakes meetings in Detroit in October and GLC will be presenting at that conference as well. The GLC and Cities Initiative are looking to keep the public and stakeholders engaged in the process. They will be looking to finalize the report and get out very early in 2012.

*The peer review team asked who is the target audience for the effort is and what do they hoped this audience takes away.*

Elected officials are one of the audience groups as they will make decisions, as well as a broader affected stakeholder groups (shipper, taxis, etc) that will be affected. People concerned about Asian carp and aquatic species getting into Lake Michigan are also an audience. The funding organizations felt that they now need credible information since there has been a calling for separation due to AIS movement issues.

*The peer review team asked what about the USACE?*

The team has been coordinating with them to make sure information is usable by them as they will have funding / permitting / other types of roles in the project. It is important that our study is useful for them.

*USACE takes 4-5 years, and the study shows gap in the timeline, is that accounting for the long USACE timeframe? Will this study be able to complete those tasks that the USACE are conducting more quickly?*

The aim is to provide credible issues and costs to the USACE. The Corps is providing interim products - such a study that identifies AIS that may be introduced into system. There are 40 or so species they have identified and this type of data is important because they are showing a broader range of issues, but their timeline is lengthy.

*The peer review team noted that the notebook provided needed additional detail concerning infrastructure costs and wondered if it is realistic to get credible numbers to fill in these blanks.*

The HDR team members indicated that they are currently producing those types of estimates. But they also noted that it is important to note that USACE may have different estimates. This study is speeding the USACE study up. The team has been working with them, and they are warming up to the idea that we are taking the some of the heat for them. HDR is making the economic analysis per the USACE standard, so this project can help them to move more quickly forward.

The HDR team has taken a commercial assessment of market and enhanced the methodology of the USACE (adding value). Infrastructure has a great deal of fidelity and detail in the HDR analysis. The USACE scope is much larger and we should respect their extended timeline.

It was noted that the project is utilizing existing data, while the Corps has to take the time to collect new data.

*The peer review team asked if cost estimates would soon be available.*

HDR indicated they would have additional cost data before October and will show preliminary numbers in September and adjust as necessary per peer review comments.

*The peer review team asked what would dictate the approach that would be taken. Is the goal to take the path of least cost mitigation, least political sensitivity, or another?*

*One peer review member noted that when realistically quantifying water quality mitigation costs, costs for the changes needed within the waterways to keep things from becoming anoxic will not be known for quite some time, so the costs used in this analysis will need to be conservative.*

*Some Peer Reviewers expressed concern about the title that had the word "envisioning" in it as some of them feel that what came through in the study was that limited to building on the "status quo" and accepting many of the "givens". Some of the reviewers felt that if the project is going to sell the public and elected officials on a "vision", it needs to show them something that is different and what we should "envision" what the CWS could be. They were disappointed by the continuation of building things as they currently are planned and wonder what can we do different to make things better.*

*One reviewer tempered the concept by suggesting that the project is a bitable chunk of what could be envisioned in the 21<sup>st</sup> century.*

*A reviewer felt that this report shows a way to stop invasives and then mitigate the damages from what has to be done. Envisioning a CWS system that is better is the same study, but in the reverse order by doing all the mitigation items first and putting in the barriers last. If we are talking about separation as long term solution, this may be a better solution. This study shows separation as first thing done, and then we fix up all other things.*

*A reviewer felt that the reason for urgency to get the barriers in is to protect from AIS.*

The HDR team pointed out that they had generated 100+ pages of a market assessment, and have had a response from the AC that envisioning any future is not a part of the study and this study needs to deal with mitigating impacts. The HDR team has made attempts at making the transportation infrastructure flexible. There has been no response from the AC as additional transportation types have been added as a part of this report since they don't feel is feasible.

*The peer reviewers reminded the team that their charge was to envision improved transportation, water quality, and stormwater while providing a barrier to AIS movement. They felt the project was providing the barrier and addressing the problems the barriers created to the other areas.*

*A reviewer asked: "Isn't some of that in tone and presentation?"*

*At least one reviewer felt that the Commission and Great Lakes Cities have learned a lot through the development of the study, and they should look back and see if they can say that goals may not have been realistic and be willing to reframe the goals of the project. It is okay to admit that this cannot be all done at the same time and that it cannot be done in the order that was originally proposed. Separation may need to be the last step as opposed to the first.*



### HDR Presentation - Progress since last meeting

A copy of the Review Materials provided to the Peer Review Team is included as **Attachment 1** to this report.

The team has incorporated comments from last peer review and addressed them as well as possible. The team is in the process of developing what the report will look like (through an outline format) and there are writers and assignments in place to make the study look good and understandable. Alternative write-ups are difficult to put into a format.

*A reviewer recommended not using the large fold out charts that were part of the material sent to the review team in the final report.*

It was pointed out that there will be several versions of the report, a very technical version and a shorter public version without all the technical detail. The technical report will have a huge appendix and detailed information will be available. The HDR team has had discussions with AIS experts to get a handle on the risks, what is the possibility for the AIS to become established, and how this would be quantified for the report. This task has been a huge challenge. The HDR team has also talked to author of the USACE white paper. They will look further into quantifying the potential for that risk because currently there are no values associated with AIS. The USACE is currently conducting an AIS study in which they are going through similar Mississippi basin habitats. If there is an overlap in community types, then they will look at the similar Great Lakes Basin communities and evaluate (but this is several years away from being completed).

Finally, the HDR team has come up with 3 different barrier alternatives. The team has received information pertaining to barge origin / destination data, but it is not the original comprehensive data set they requested as it is not available to the public since the USACE has been prohibited to distribute to public. The USACE cannot share data from commercial interests and there is also an upcoming congressional mandate.

*A reviewer noticed that in handout materials it states that there are 263 combined sewer outfalls, but he has been told it is more than 400 by MWRD. Which is correct?*

An HDR team member responded the 263 may be those that outlet to the project area, but the MWRD has more in their system that they maintain that are not tributary to the study area. The HDR team will confirm the correct number of outfalls.

### HDR Presentation and Peer Review Team Discussion of Barrier Options

Reference is made to the Preliminary Barrier Locations Map provided in the Review Materials (Attachment 1).

HDR Team - In past few months the team has tried not to focus so much on technically feasible options, but instead worked to frame options that do the most informing for the agencies and general public. Three alternatives have been selected; near lake (5 barriers), down river (single barrier), mid system (4 barriers). These scenarios are looking at a range of single barrier versus multiple barrier options to help get a clearer picture of the different issues that will come with each type of system. The impacts, mitigations, and costs will

be more obvious in terms of feasibility since the alternatives are on extreme sides of the spectrum from each other.

**Near Lake Option** – An advantage is that it is easier to mitigate for water quality, but stormwater and flood control are more difficult to deal with as they are losing outlets to lake. Transportation also has some issues.

**Down River Option** – There are significant impacts for all aspects and significant mitigation required.

The GLC and Cities Initiative felt it was important to look at this option since the public will question why it was not considered, and since the study will not be identifying a preferred option they want to inform the public as much as possible.

*The reviewers asked: Which combo gives best and widest range of AIS control? Where is greatest degree of security and it would it be useful? An overtopping evaluation is good, but we need to expand on it.*

HDR – Which direction of flow is worse? Some in this region may say river to lake is worse, but other people downriver would say the opposite. These concerns need to be weighted in the report equally.

*Reviewers felt there was a need to evaluate AIS probability between the lake and river for each barrier location. They also felt that since “overtopping” was a given for very large storm events the need to locate a “kill box” for the lock locations needs to be better articulated. Which way are the AIS going to travel and how would that transfer be stopped during an overtopping event? This needs to be better explained. If alternatives are structured to each provide identical AIS risk this should be so described.*

HDR noted that the near lake option can effectively seize the transportation system in the city, while the downriver alternative has less of an effect on existing transportation.

## **Near Lake**

### **North Shore Channel and Chicago Lock Timeline**

HDR Team - The existing electric barrier stays in place and AIS best management practices would continue on as well as some additional items that may need to be done (such as education and outreach). This timeline shows that a barrier would be implemented as quickly as possible, the lock and gate operations would stay as they currently are for the first 5 years and then the locks would be closed until other mitigation elements are in place (shown by the light gray bar). TARP is anticipated to be completed in 2029 (as shown by McCook reservoir timeline) and the barrier can be constructed sooner and the system kept closed. The final construction piece would be to open gates at 19 and 3. A flood tunnel would need to be built and an additional storage facility located somewhere by McCook to get stormwater out of the system.

*A reviewer asked about an existing quarry that is owned privately near McCook, this may be more cost effective to use than vacant land because it is already excavated rather than constructing a new reservoir for this project.*

The HDR team said they are choosing things for this study that are engineering oriented with factors they can control, and there was a history associated with that particular site that made it unattainable in the past .

*A reviewer expressed his frustration that 2029 is locked in concrete and it is accepted as a given. Dealing with the quantity of water in the combined sewer system is because of issues with the district: I&I is lousy and the region is behind on regulations for I&I. The Rouge project in Michigan has demonstrated that taking an existing system and making it offline to eliminate peak flows is very effective, but the district in this region has refused to implement that. He feels that we shouldn't accept what the district says, but instead explore those types of alternatives.*

HDR indicated that the team had to choose a singular management tool to cost and evaluate since they cannot control MWRD.

*The reviewer felt that the issues with MWRD need to come through in the report.*

*Another reviewer noted that most interceptors in the regional system do not belong to MWRD, but are privately owned (laterals). This issue can be politically sensitive and may not be feasible. But EPA has told MWRD they need to get on the backs of the municipalities to get on the backs of the residents.*

*A reviewer felt that the region is suffering from decisions made 20 years ago. Other communities have "bitten the bullet" to reduce I&I.*

HDR staff pointed out that ordinances have been written to help address these issues, but they have not passed the council.

*A reviewer felt with time, when you take stormwater out of the combined sewers, you will help solve many of the volume issues.*

*Another reviewer felt that the team has chosen very expensive engineering alternatives rather than picking potentially politically difficult options, when an expensive project may be very politically difficult in this type of economic climate.*

*A reviewer asked: "Are they considering pumping Lake Michigan water into the system and sending it back through the North Shore channel? This should be looked at."*

HDR Team members then spoke to the transportation aspects. In terms of transportation, there is a recreational and tour boat component since they would need to be lifted and disinfected. This includes dry dock and maintenance facilities

*A reviewer asked: "What percent of river and lake tours go through the locks?"*

HDR Team: A vast majority of them move both ways and go through the locks as a part of the tour. There is a proposed dry dock as a part of the project that was originally not there before.

*A reviewer asked for clarification on movement of base flow. When the barrier is put in place between now and 2029, it seems that it will allow movement of base flow through the barrier, but he was under the understanding that there was to be no flow.*

HDR will review.

HDR expressed concern that the timeline is extremely difficult to present, and they would like to hear suggestions on how to improve relaying this information.

HDR staff stated that if we look at the timeline over the next 20 years, the taxi and waterway industry is increasing, and the current proposal shows existing facilities being upgraded to accommodate the existing traffic. If you assume there is any growth in the industry, these proposed facilities will not be feasible with the barriers in the near lake location..

*A reviewer asked if building dry docks is a cost of the project.*

HDR staff stated that the project proposed to replace existing dry dock capabilities on each side of the barrier so boats have access like they currently have. They are mitigating for the existing capacity, not future.

*A reviewer asked if you mitigate the dry dock owner that you would put out of business by constructing this new facility.*

HRD staff said there is an opportunity for the government to step in and cooperate with the private industry.

*A reviewer pointed out that facilities can be considered an opportunity as well. It's a good thing and can be promoted and presented as one.*

*Another reviewer asked is this a public cost? Why not a private entrepreneur?*

HDR responded that they have not determined the percentage split between private and public, but the team is just counting it as a cost to the project at this point without costs assigned to a specific group.

*A reviewer asked to see a timeline with associated risk of flooding as was shown in the previous meetings.*

The HDR team pointed out that new direction given to the team was that flooding cannot get worse, so that is why the charts are as they are since the flooding risk is constant.

*A reviewer felt that the charts should show risk and include AIS movement, flooding, etc with different charts for each barrier.*

*A reviewer asked: "Are these actually real world timeframes?"*

HDR responded: Yes, these are preliminary design and construction timelines, but it does not include permitting.

*A reviewer pointed out that the charts are confusing since sometimes the lines are operational items, sometimes they are planning, and sometimes they are implementation [construction].*

With respect to scheduling, the team is assuming one massive environmental assessment and said that the cost estimates for each individual component did not include massive NEPA costs.

## **Near Lake**

### **Calumet River Timeline**

HDR Team - This timeline shows the same AIS adaptive management as previously shown. The thing driving the timeline on this chart is the additional flood mitigation elements that need to be in place as well as some transportation mitigation. Operations would continue "as is" through year 15. TARP is not a time constraint in this timeline, but there are reservoirs proposed (the flood reservoir is put in for security purposes at this time until further engineering could be completed needed for the AIS movement risk)

*A reviewer asked: AIS boat disinfection is not in place now?*

The HDR team is suggesting that this is done as a non-project cost since it should be done now. But boat transfer over the barrier is included in the cost, these costs are for people who are docking on small unmonitored docks and entering into the system. The AIS electric barrier is in place and will continue to operate, so it is not a cost to the project. The timeline also shows other AIS best practices that should be included as a part of the existing program.

*One reviewer looks at these AIS control measures as a way to envision a better system as opposed to everything hinging on the barriers.*

HDR Team stated that they envisioned flow augmentation from Lake Calumet – the team was hoping to have some flow between the river and lake to augment flow since water from the lake is a lower cost solution.

The HDR team spoke of the transportation aspects associated with this barrier location. The proposed intermodal port proposed in this timeline is a complete replacement of the existing ports in the system and constructing a port equivalent to LA's port, with rail and other transportation to it (it would replace more than 30 existing terminals). It would be a new international port. For the construction, we would need to create an island and connect to the mainland adjacent to the mouth where Calumet intersects Lake Michigan. They estimate about \$10 billion in today's costs (assuming to be built by 2025). The group suggested that the spoil from the TARP project could be utilized to build up this island. An Alternative Transportation Plan – constructs

smaller port that does not deter any current operations on the river or in the port of Chicago except for barge transfer. Have envisioned the port in here and in the previous alternative as being positioned adjacent to the barrier. Have met with organizations to discuss and confirmed that Lakers can self unload (2 berth facility) sized for 1000 ft Laker traffic. The cost could be about \$500 million. The local shipping groups feel this option is less problematic than other options. 30' deep water would be maintained on the lake side of the barrier, and the barrier would be placed exactly where transition from deep and shallow water occurs. Cost savings logistically from having to reload barges. These canals provide very large volumes of shipping, in millions of tons. They have "past the point data", 2000 to 2009; there has been a downward trend since 2006 / 2007. They cannot get data for when the barges passed, what they are hauling, and where they are coming from.

*A reviewer asked if the downward trend was because of the recession or because of different modes of transportation.*

HDR team felt that it was partially due to both.

HDR Team – This timeline shows the implementation of Green Infrastructure (GI), there is some potential storage in the Calumet / Lake Calumet system, but not enough to eliminate construction of an additional reservoir. This reservoir would still be needed to minimize flooding. The team is looking to push flow as much as possible back to the Cal Sag (Little Cal channel modification). The barrier cannot be constructed until the flood mitigations have been completed.

*A reviewer pointed out that if they were to impose a risk profile on this timeline, it would be short but very intense on the front end.*

The HDR team indicated that much of the volume of traffic through the Calumet River is going to Indiana ports, where there are 3 ports. There is a back door option in which they could dredge the Grand Calumet River, place a barrier, and allow cargo to come through the Grand Cal into the system. Have preliminarily priced that project at \$800-900 million as there are many crossings, and a project of this level may be near superfund qualified site. The team does not have a handle on how much cargo is distributed to each port. The lake surge can sometimes be so large that barges cannot operate on the lake, and this project could provide the opportunity to have another transportation option as well as allowing partnering opportunities.

*A reviewer stated that he had a job in the past with an industry along the south shore of Lake Michigan that utilized waterborne transportation. They were doing strategic plans years ago because they felt the shipping in this region was going to die. He thinks it will be impossible to get private funding. We are now trying to find things to promote the status quo, but we are not looking at just closing it off. Rail and deep water shipping are alternatives. Lack of investment, the changing nature of the movement of goods, and the promise of shipping through the St Lawrence Seaway that isn't happening are reasons that people in the industry are looking at alternatives.*

*Another reviewer felt that if the effort was a vision, and not just a mitigation document, then this backdoor option needs to be seriously considered, as it may be more conducive to achieving the project's goals than some in-river options.*

The HDR team said that when the team met with the American Waterways Operators (AWO), they were contributing information about their system.

*A reviewer asked: "What is annual revenue of operators on this waterway?"*

*Another reviewer asked: "If you can't get real numbers from the operators, can the team take general costs per ton of various materials moved and assign probable cost to this?"*

HDR indicated that they can do this.

The HDR team pointed out that there are two operational components to this transportation system - barge owners and terminals up and down the Calumet. The mid-system Lake Calumet port is a compromise between the two. There may be an opportunity for container on barge in the Great Lakes. The mid system port is a way of allowing transportation on the Calumet River to exist and build a new port smaller in scale (than the mega port previously described) and accomplish everything plus transport over barrier, but lake bound barge traffic would be severed. The barge to terminal / terminal to barge system is currently operating different types of barges on the rivers versus the lake.

*A reviewer asked: "Why not relocate the port to Indiana?"*

The HDR team said this was not evaluated because of an increased cost to transport the material by having to use rail, as well as the fact that it may not be politically good to put it in Indiana instead of Chicago.

*The reviewers felt that we can't play both sides, both political and best engineering alternative. So what is the best engineering solution?*

*A reviewer asked if there have been any thought of capturing floodwaters and reintroducing into aquifers through deep injection wells? Instead of building new reservoirs, could this be a beneficial solution.*

HDR responded that storage would still be needed because of limited pumping capabilities; and the wells would need to be very deep -- below tunnel system -- to prevent I&I and could be a major feat.

*The reviewer felt that they could take the water and distribute along system. Can potentially cost share with western suburbs who may be interested in recharging the aquifer as they are tapping the aquifer for their water supplies. He also felt that if other 'major feats' such as TARP 2 or a major port on an island in the lake are being proposed then something like this could be, also.*

## **Mid System**

### **Timeline**

HDR Team - AIS control ideas are the same as the previous timelines. This barrier allows flow from the lake to river in one direction. These permeable barriers would allow base flows. Operations would continue through a 10 year timeframe while they are completing upgrades to the North Side treatment plant. There is a secondary



period where the base flows would be sent back out to the lake as the reservoir is constructed. There are a number of options to prevent species transfer from the river to the lake. Flows would not be increased more than today. There would be overtopping only from the lake to the river in a catastrophic event. CSO's go into the waterway, but once the McCook Reservoir is finished, that is expected to occur at a very a low frequency. Up until the barrier is fully implemented and TARP is fully online, water would be passing through the barrier lakeside to riverside. Water would still be going to the lake during large events, and it is recognized that there would still be backflows to the lake.

*A reviewer asked what type of benefit would you have to just shave some flow off instead of making a big barrier.*

It was stated that one benefit is that it is stormwater (which has no carp).

*The reviewer commented that once the treatment plant is done, they should build full barrier rather than micromanage as in this scenario.*

The HDR team agreed, but additional treatment will be required of the CSO into the lake. They are permitted to discharge CSO's into the lake, and this is a much cheaper alternative than TARP.

The point of one way direction was to get as much AIS protection in place as soon as possible.

*The GLC and Cities Initiative are concerned about CSO discharges into lake and concerned about a headline that would state there is an increase to pollution to the Great Lakes because of this project. Could they justify that for a short period if they can reduce AIS transfer? The team needs to quantify the tradeoffs of this risk.*

*A reviewer stated his position that CSO's guarantee damage to the lakes, where as AIS movement prevention attempts are not a guarantee of prohibiting the transfer.*

HDR Team stated that in this option, there is not a proposal for any large conveyance system, reservoir, or large gray infrastructure. The dry weather flow bypass = a one way gate. Sediment remediation may be needed on the lake side of the barrier for areas at risk of being stirred up. Transportation is mostly recreational vessels except for maintenance and dry dock facilities.

A reviewer asked: "What is the envisioned future of the power plants?"

HDR responded: "Both plants are lakeside of the barrier and they are to be phasing out. There is a consent decree that says that they will both phase out, but may still need water for cooling. The team is looking to consider bringing water from lake for this."

HDR explained that when looking at storage capacity, the team was using a 7" storm (about 100 yr event) and built their storage model as illustrated below; building the different types of available storage elements up from the TARP – Tunnel storage to a new reservoir (if needed)

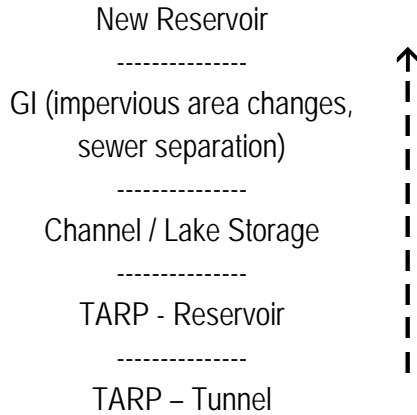

The HDR staff member thinks he is hearing from group, don't do to new reservoir, but instead try to find alternatives.

*A reviewer thinks the team needs to look to use existing reservoirs or injection wells.*

*A reviewer feels GI should be at the bottom [first to be implemented] of the storage model since getting stormwater out of the system is a rapid reduction of volume and provides benefit in smaller, more frequent storms, where TARP never needs to come in to play.*

*A reviewer thought that implementing new technology that is being used around the country that is currently not used in this area is another option.*

*A reviewer asked at what scale the team felt GI would impact?*

The HDR team is looking at land uses and assigning an amount that can be captured through the plans these areas / communities would implement.

*The GLC and Cities Initiative doesn't want to overpromise the inches that would be captured by GI.*

*A reviewer commented on the 'wetness' of the collection system in Chicago saying that, due to high I&I, anything in Chicago you put into the ground will go into the system.*

## Down River

### Timeline

HDR Team - There is an interim barrier for base flows to pass through, an upgrade to all 3 treatment plants and installation of reservoirs. The need for additional flood storage in a reservoir to accommodate the 7" rainfall discussed. There will need to be some conveyance tunnel to the reservoir. The system is open to the lake and getting circulation through the system will be difficult. Source water would most likely come from Stickney. Transportation could get barges up to the barrier (have to change the operations at the lock). A port or intermodal port would be needed and there would be a lack of downstream water.

HDR would like better guidance for how far into the future you envision a modification. It is possible to get these materials to Chicago by using a different port.

*A reviewer stated that he is more concerned at looking at the need to move commodities, as opposed to how we move them since the stated goal is to improve transportation, and is not mode specific. He would hate to get bogged down with a potentially dwindling transportation sector when we should be focusing on other things. It is like putting a really expensive band aide on something that is broken instead of putting the money towards something better for the area. It is possible that by moving the port to Indiana, there could be some benefits in the region (stormwater, recreation, etc).*

*A reviewer commented that earlier discussion summed it up best when the question of what the current barge operators' margin is every year....it may be cheaper to buy them out and find alternatives.*

*Another reviewer again pointed to the goals of overall project are that we want to improve things as Chicago is a black hole for rail transportation. He sees with changes, they could impact that and those things should be said. Then they are not protecting a small niche and instead can improve the whole area.*

*Another reviewer pointed out that the amount of freight and type of freight will not be affected by this.*

HDR pointed out that the Panama Canal has created competition and new intermodal transportation. Louisiana is proposing new transfer system since they believe the Mississippi River is the highway of least cost.

*A reviewer made the analogy that when looking at better options for mass transit, we don't care what taxi drivers say. This is similar and cares about the material getting there, not how it gets there*

A HDR team member stated that if that is the case, it may be better to ship into other ports. He was pleasantly surprised by data from the USACE, and before anybody designs anything, they need a better understanding of the commodity flow of origin / destination. The team can get data, but they would need to approach each industry for the information. We have tapped into the best info the USACE has to give to us, but it is not the entire picture.

If they were to develop a port at the mouth of the Calumet and cut off, it could increase the Laker traffic.

*A reviewer asked: "Why can't we build off of the 10 year data?"*

The HDR team said that they have the tonnage data, but they don't have what is passing by (have some commodity data, but not a full picture). This data is literally counting vessels, and there is no data to let us know if it is full, empty, backhaul, etc and this information cannot come from the USACE data. The key missing

in data is exact origin and destination. In general, there does not appear to be finished products being shipped from the area.

*A reviewer spoke to the apparent inequalities of treatment of transportation issues across the alternatives by saying that in this discussion, if you put barriers up it is going to have consequences for commercial shipping. There have been 3 scenarios to accommodate them; (1) a 'superport' that could cost billions but potentially make Chicago a new center for global water transportation interchange, (2) a port to accommodate current volume in mid area for a much lesser cost that is able to accommodate the existing, but declining, volume of traffic ; and (3) basically shutting down the barge shipping activities since "the, port district is more interested in golf than shipping as congress's investment has been subpar." Treating these 3 options equally seems to be a real contribution.*

*A reviewer felt that this report needs to be clear on the cost to accommodate existing traffic.*

The HDR team said that whatever would be coming to the Great Lakes in new container traffic is small stuff. Class 1 rail companies will not allow their infrastructure to be undercut by canal. Rail is a private investment, whereas water is public.

HDR staff asked the reviewers' opinion: If we were to assume commodities were to be transferred to other modes, would there need to be some other forms of investment in rail (public) to help offset?

*A reviewer felt that he did not agree that subsidies will be needed. And rails will only do it if it makes financial sense for them to do it. Railroads are investing in other parts of country and waiting for Chicago's public money.*

### **HDR Presentation on Quantification of Benefits and Economic Analysis**

A copy of the PowerPoint Presentation made by the HDR Team covering economic analysis is provided as **Attachment 2** to this report.

General Cost Benefit Analysis (CBA) Framework – many costs to be considered and all individual mitigations will be broken out. TARP to be completed by 2029, so this is for 30 years after that and then bring back to today's dollars.

HDR indicated that the economic analysis would be conducted using both the USACE recommended discount rate of 3% and the OMB guidance rate of 7%. These two rates will allow the sensitivity of costs to rate differences to be demonstrated.

*Key reviewers agreed this is a reasonable discount rate.*

HDR still needs to confirm the USACE rate. All costs are measured against the “base case”, which is no separation with completion of the TARP reservoirs and other currently approved projects. . The Chicago Park District Marina plans to put in additional 1,200 slips (not a project cost) and recreational boaters would move to these facilities. Water quality – no additional treatment needed. Pollution Control Board and EPA are supposed to act to put stricter nutrient loading restrictions on the water treatment, but it is not yet passed. Effluent at the plant is currently below lake standards for TSS and BOD, but ammonia and toxic metal standards will be very difficult to meet.

*A reviewer felt that they can reduce those numbers if they increase pretreatment standards for heavy metals.*

The GLC and Cities Initiative wondered if pretreatment standards were modified at last minute, and the implications are that we can reduce the cost of separation, would we want to revisit that as a cost.

*The reviewer felt that any changes could be months or years down the road, it is impossible to tell. The baseline will stay as is for now, but can be modified as needed in the future.*

The HDR team stated that cost adjustment could be done easily. The strategies are designed to minimize effects of the mitigation required.

*A reviewer felt that the team has to be very specific to what they call “mitigation” and what they are not calling mitigation since there will be impacts to small groups.*

The HDR team will call it out, but asked is mitigation a good term?

*The reviewer felt that it was okay, but we need to acknowledge that there are small groups / people that will suffer as part of this (e.g.. dry dock owners in Indiana).*

The HDR team spoke to Transfers – if all freight goes to truck, lost jobs from shipping will move to trucking. Overall, we are concentrating on the user's cost for shipping.

*A reviewer asked: “Is there a way to measure the employment?”*

HDR responded that CBA analysis won't specifically measure employment, but they could do based on the revenue industries. It is implicitly in there, but not specifically.

*A reviewer asked HDR to define “effect on social welfare.”*

HDR said that it is the impacts on users across the area. Cleaner world, less invasive species, etc translated into dollars. Basically considering if investments are making the world a better place. Monetizing effects when they can. When some impacts can't be quantified, the report will still speak to these impacts in the narrative and while they won't be in the numbers, it will be in the discussion. Water quality is one that is difficult to

quantify and can often be shortchanged. The HDR team has been struggling with placing a number on some of these items and those numbers becoming scrutinized.

*A reviewer felt strongly that articulating that this study is not focusing on jobs to the groups will take considerable tact since they are highly focused on.*

HDR spoke to changes in property values with barge operators, some terminals will be affected as it will cost more to ship from their terminal and the property values would go down, but HDR thinks this effect on property values would be already accounted for in the increased shipping costs from their terminal. There is the possibility that some locations could also be a benefit if abandoned and turned into mitigation area...but don't want to double count benefits or costs. From a public policy standpoint, reimbursement may be given, but it is not factored into this analysis.

*A reviewer felt that the team needs to come up with other examples of what areas have aspects that are difficult to quantify and show the public that reviews this report how "double counting" was eliminated...but that costs were appropriately assigned.*

HDR wanted the reviewers to understand that they can't take all commodities and evaluate them at the same unit cost (as was done in the DePaul Study).

HDR asked: "How does group feel about the DePaul study?"

*Reviewer: The author is credible, but it was done in haste and commissioned by chemical industry council as a response to the Taylor study for talking points to the press.*

*Reviewer: That study didn't look at a variety of things, it undersized infrastructure costs, and it didn't look at AIS movement impacts in long term.*

*Reviewer: They minimized AIS effects.*

HDR said that the Taylor study focused only on goods movement and that the goods would move by water until they reached the barriers and then would travel through a different mode of transportation for the last 25 or so miles. The study didn't look at any trans-loading costs over the barriers. The Lynn Muench (AWO) study said that infrastructure is not able to handle this in the short run and it will kill the barge industry. The USACE study is not done yet, but the numbers are very high. Potentially 800+ or thousands of trucks a day would be required to take the amount of load from barge shipping.

*A reviewer pointed out that rock salt goes onto a truck at the end anyway to take it to its final destination, and these estimates are assuming that it is taking it from the pile to the final destination instead of offloading at the barrier and driving to the final destination. The final destination is what needs to be known since the major amount of cost is offloading to the truck. Even though it may*

*take multiple trucks to carry the load on one barge, the 10 extra miles for these trucks to reach their final destination is minimal compared to shipping costs (other studies don't address this properly).*

HDR spoke to quantifying the costs associated with AIS transfer between watersheds. They pointed out that quantifying this requires many factors. They are consulting subject matter experts. The group feels putting a single number out there could potentially blow credibility since there is no number out there currently.

The GLC and Cities Initiative is concerned that a cost estimate of the impact of AIS movement may become the focal point of the study and don't want to distract from the broader point and purpose of study.

HDR said that one potential way to do the AIS cost benefit estimate is quantify all other impacts and then put these impacts into context of what has happened historically (zebra mussels) and try to put forth reasonable case studies of what could happen (how much it would cost) if something were to occur. Zebra mussels impact on Great Lakes was in the 300 to 500 million dollar range, then use that figure as a benchmark (consider also other AIS—e.g., lamprey, etc). Doing detailed analysis with this has produced a very large range, which is very hard to agree upon. Case studies could also have a large range of arguments, but 40 species are additive and that could show different ranges.

*A reviewer said that most of the other things have costs and benefits.*

HDR staff replied that this is true, but we are just trying to get back to where we are today, making sure that we don't worsen conditions. The concern is that when HDR runs the numbers, the number for AIS control is a very large benefit compared to others, and that is the number that is the most controversial. GI shows that there are benefits as well, but the costs associated with these improvements are not often the same as the amount taken to build the infrastructure.

*A reviewer thought that HDR needs to add water quality into the charts since it benefits not just the Great Lakes, but other regions.*

*Another reviewer again pointed out that the root of the problem is that we are not improving and envisioning, but we are instead getting back to where we are today.*

*Many of the reviewers have come to the realization that the main area we are getting benefits from is the area that is the most controversial and can be scrutinized the most. Basing the benefits of separation on an area that is not as easily quantifiable is unsettling.*

*Reviewers generally agreed that the scenario type of methodology is a more reliable form of analysis. Want to emphasize that we are protecting both the Great Lakes and Mississippi basins. In the report they can put those on separate bars on the chart to illustrate that it is a benefit for both basins.*



It was suggested that the team – and any interested peer review members -- have a discussion with GLC and Cities Initiative leadership to discuss how to address this item. The team needs a holistic view of the cost / benefit for a waterway and its functions. Water quality, transportation, and flooding will need to be explained.

*At least one reviewer opted that the GLC and Cities Initiative should change the title of the report to fit what it is currently stating. If they change the main goal to AIS control, then the other 3 (water quality, transportation, flooding) would be sub goals to keep the status quo.*

*Another reviewer thinks that there are many benefits that are minimized in this type of discussion. The Midwest / Chicago area is so far behind the rest of the country, and the district is getting a new look on how to address these issues. Opening up the waterways for use to the public and getting in compliance with the Clean Water Act are huge benefits that should be accounted for.*

Discussion continued on the “goal” of the effort as embodied by “Envisioning” in its title. Individual reviewer comments are summarized below:

*During flooding, water quality and flood control that occur during the smaller events are a large benefit that needs to be quantified.*

*I react negatively to the “do no harm” approach, and feel that envisioning is a different project.*

*Truly envisioning means everything is on the table, and that is not what was done.*

*I think what the group is saying is that we are over promising in the title and the first few pages.*

*We should acknowledge that this report was based on AIS control and use it as a baseline for future studies.*

*Envisioning can be a biteable chunk, it doesn't have to be utopia. It can be phased as well.*

*But at what cost? It means improving things over the status quo. The question isn't just the title, but what are they actually doing to improve and envision?*

*The “superport” is example, a way to envision and solve AIS issues above and beyond. This type of approach needs to be taken with each of the goal elements, and they need to have a “superport” for GI and stormwater elements as well.*

HDR expressed a need for clarification from their client on the direction to proceed. This information is out there, but what do we do about it? Do we just restate the ideas of others? The marching orders were to deal with AIS movement, and the team is torn on how to integrate these comments. What direction does the team take from here?

Are we looking at separation and looking at outcomes, or are we looking at doing all the things and then separation as an auxiliary outcome?

*A reviewer felt that we need to work backwards, in order to effectively separate, we would need to do a, b, c, and all the other mitigation strategies to get the proper state of nature, and end result would be separation.*

The GLC and Cities Initiative feels that one objective is to take the information and put into USACE GLMRIS study, but the bigger purpose is to inform the public as to what would need to be done to separate, including impacts, costs, etc. Our problem is that we have added the additional hurdle of improving all features (transportation, flooding, and water quality).

*A reviewer thought that it is an arbitrary 5 year deadline to install the barriers as the USACE won't be able to build these in 15-20 years. Instead, mitigation could be done in interim.*

HDR said that the 5 year deadline helps to lay out timeframe for discussion since the longer you wait to put in a barrier, the higher risk of AIS movement there is.

*A reviewer pointed out that the schedule for TARP has been held firm in the planning assumptions, but they don't have an enforceable schedule. A driving force that makes this not work is flooding, and that cannot be completed without TARP.*

A reviewer asked if the primary goal is to impede AIS movement, then you are stating that you are willing to sacrifice other things.

HDR replied that those are political judgments; our job is to present the decision makers with the data so they can make that judgment.

*Reviewers felt the need to have meeting among HDR, GLC Cities Initiative and peer review representatives either via phone or in person since decisions on goals/approach will affect the work product.*

HDR felt that even if a barrier goes in tomorrow, there will need to be vigorous AIS prevention. In the long term, can they continue to rely on non-structural approaches vs. nonseparation?

*A reviewer felt that it needs to be stressed that the phasing of barriers and other improvements is important as it affects the risks. He was thinking risks are more based on timing of the projects as opposed to location. Now that we have chosen 3 options that best illustrate varying impacts, and that these 3 options have generally equal AIS movement risk while the other risks fluctuate, it would have been interesting to look at timing with different phasing options (i.e. barrier installed at end and what do you have to do to keep AIS out).*

HDR commented that some timelines do address this as some of the elements do need to be implemented prior to the barrier.

*Reviewers felt that we need an approach that helps the readers to understand relative risks of timing*

HDR noted that ancillary benefits can be captured, and we can get all of these without a barrier.

HDR postulated that for transportation, it should be done on its own by its own merit. For example, why not a super port on its own instead of as a part of this project?

*A reviewer responded that it's because the market is choosing to abandon this method.*

The consensus of all at the meeting seemed to go with case study approach for AIS benefit quantification and move the project forward. Need to acknowledge the USACE approach, but it will take years to get their data.

*A reviewer felt that the correct approach depends on the audience, but that this approach is more understandable for general audience and the public.*

HDR said that as the USACE models further develop, the analysis will need to have compilation of impacts on whether separation will hinder or help habitat for other invasives.

HDR said that there is a quantifiable cost to degradation to the transportation element.

Other port authorities will pick up the slack, and the client needs to look at if they want to divert the tonnage per year as he thinks there is some viability since barge transport is by nature decaying with no mitigation or mitigation is to put them out of business and buy them out.

*A reviewer asked as to AIS movement prevention – What is on that bar and what are the benefits?*

HDR responded reduction in ecosystem costs that one invasive species would inflict (damage of AIS movement) through historical data and reasonable judgment. This estimate would be conservative and say it considers only one AIS, but the benefit could be cumulative across many AIS. The final report would point out that the USACE has identified 40 potential AIS and one could be catastrophic (thus, separation is like an insurance policy). An invasive, like Asian Carp, could create hazards to people, fishing industry, degraded aesthetics, recreation, etc. We do have numbers associated with zebra mussels and sea lamprey, damages, efforts to fight, and other costs, and these are costs that would be avoided in the future.

*A reviewer noted that zebra mussels would not have blocked the barriers, so we cannot talk about the damages of them in the lake since they were already there.*

HDR explained that they are just using them as an example of what an invasive can do. A list of costs and benefits is in the workbook for everyone to review. These line items do includes O&M.

*A reviewer commented that the cost of things drift upwards; and asked if the team was doing something to make them more credible?*

HDR responded that there is some contingency, stripping out and doing a distribution with a risk range. The ones included now are conservative.

*A reviewer asked if it was correct to list stormwater management as a cost. He felt that storm water management is a requirement across the country and because the CAWS area is behind in complying with current requirements it should not be a cost of this separation project*

HDR responded that this may need to change based upon discussions today. Costs were built up to provide situation where flooding impacts are no worse than today.

*A reviewer asked if internal plumbing is required to get a sewer to TARP standards will it be included as a baseline cost.*

HDR Team responded that, yes, it is in baseline.

*A reviewer asked: "In 9a (water quality mitigation improvement), are you only talking about pathogen of bacteria. Are they going to do any analysis of metals, or other water quality factors?"*

HDR responded: No, they do not plan to include these other costs.

*A reviewer asked: "Do we know barge is safer than everything else?"*

HDR responded: Yes there are statistics on it and they are accepted.

HDR asked the reviewers about sedimentation and the need to remove it. If it's not disturbed and if flows aren't increased, maybe we do not need to plan on removal?

*A reviewer suggested talking to Dr Garcia at the University of Illinois for his study at Bubbly creek. There is no way for some sediments to get out of North Branch now, but may be moved downstream if the Chicago River Controlling Works are opened up and flows and sediment can move into the lake.*

## Wrap-Up Discussions

On behalf of GLC and the Cities Initiative, Matt Doss thanked all for coming today. As new thoughts come down once notes are distributed, please make sure to include these new thoughts. These are some summary comments:

- Biggest take away message – There is a disconnect between “envisioning” and the big goals, and where we are now at achieving separation and getting back to the base scenario (status quo) in terms of flooding, water quality, and transportation. We need to either reconcile that or pull back and review the scope. Are we accommodating the status quo or taking it further to envision a new and better system?
- Some reviewers feel we should admit some of our goals aren’t achievable, and the analysis doesn’t show which options minimizes AIS movement risk, then the other 3 (flooding, water quality, and transportation) risks should be evaluated in relation to that.
- In a similar theme of envisioning, in this report as it is now we are merely accommodating the status quo as opposed to different approaches to managing things.
- The analysis doesn’t identify which options provide the highest degree of security against AIS movement.
- Right now, improvements are all contingent on the construction of the barriers, is this consistent with envisioning a better CWS?
- There are other options to moving materials, and we may not have to focus on keeping status quo.
- There is difficulty in evaluating the best engineering solutions versus the best political solutions
- The peer review team feels that we need to be realistic about the declining use of shipping, and we need to think about how much we want to mitigate for transportation impacts.
- Should look at quantifying the job impacts
- The group agreed that past case studies are to be used for the AIS benefit analysis
- How do we fully capture non-AIS related benefits of separation?
- We need to add water quality as a benefit category
- We need to look for ancillary benefits as opposed to just the base case
- Is there a middle ground between envisioning and separation?
- We need to discuss, before preview meetings, the question of “envisioning” versus the “do no harm” approach

*Reviewer: There is nothing wrong with the report focusing on getting back to the base case, but then we need to state it properly. If we do need to envision and improve, then we need to come up with better options for each scenario. He is also concerned about the graphical representations in the report and suggests getting some specialists to help convey the message graphically.*

*Reviewer: Capturing stormwater is different than managing stormwater. How do we quantify it? Is it by reducing flood risk, or looking at different stormwater management systems?*

*A second reviewer responded: Reducing flood risk.*

HDR's transportation team asked: Are we going to do a cost benefit analysis of full cargo diversion of the 15 m tons per year? None of the cases require it at this point. Divert 8 million tons south of Lockport? What is vision for 21st century for transportation? They are asking for some guidance from the GLC.

Consensus: No major concerns expressed on economic analysis.

*Reviewer: Will they be open to reconsidering 5 year deadline for putting in barriers since it may have more impacts / costs for mitigation?*

*Reviewer: Is this product the GLC's voice?*

GLC/Cities Initiative are not looking for an opinion, but instead an objective analysis of alternatives and costs / benefits associated.

*A reviewer believes the report is going to state an opinion since it is a policy document. Would they want to make the case that MWRD is poorly managed and needs to be restructured?*

*A reviewer commented on MWRD: In the past decisions were made and they were sacrificing water quality and using the river as dumping ground as to not have to directly discharge into the lake. Now the focus is to use waterways for other uses and is evolving. We need to ride the trend, and we can have those improvements without having to separate.*

*A reviewer wanted to make it clear that the Mississippi River Basin is just as important as the Lake Michigan watershed.*

The GLC/Cities Initiative opinion is that separation is the best prevention for AIS movement in both watersheds, but all stakeholders need to better understand the impacts, costs and benefits. The study is to give preliminary answers to these questions given that non-structural methods are not a long term solution to AIS movement. They don't want the result of the project to be viewed as opinion, but rather factual engineering findings. They want to find a way to accomplish physical separation of the basins without doing any harm.

*A reviewer asked if all were comfortable with the choice of the 3 options, any comments?*

The group is concurred with the options and locations.

*One reviewer asked for more analysis with the same locations; assuming that the barrier goes in later at an appropriate time when it won't increase flooding, impact water quality, etc, and cost / benefit analysis of those scenarios.*

It was stated that all current scenarios do not increase flooding and do not impede water quality (not sending CSO and treatment to lake without full TARP implementation).

The GLC/Cities Initiative believes that ultimately the decision makers will pick the option that makes the most sense, and there may be some very near term things that can be done toward implementation of the option. It is likely that the discussion will turn towards what the appropriate timing will be and that people need to be reminded that this will take a long time, but we need to be very vigilant to keep AIS out (such as carp) before these improvements are done.

HDR felt that there is a need for an emergency response plan in place and need to note it in report.

*A reviewer said that he envisioned this plan to be like Chicago Climate Action Plan that makes incremental progress towards the main goal. He feels mitigation steps towards separation would be the same as this plan.*

*A reviewer asked if the plan would have an implementation element.*

The GLC/Cities Initiative at this time feels that it will only identify the participants.

*A reviewer opted that if partners and funders buy into the different mitigation elements, the foundations can begin to set aside money for implementation to continue it moving along.*

The GLC/Cities Initiative hopes to keep all parties on board in moving forward. The main goal is to inform public discussion and let people know the impacts of separation.

*In closing, a reviewer commented that he is impressed with the complexities of the issue and impressed by way that CLC and the Cities Initiative has worked with their consultants to think through the numerous different dimensions. Framing the results is the difficult task that remains.*



## Follow Up Comments

Each of the members of the Peer Review Team was provided a draft copy of the above summary for their review and comment. Their relevant comments on the discussions during the two days have been incorporated above. Each of the reviewers provided additional thoughts upon reflecting on the effort.

These are provided below.

### *Reviewer One:*

*One thing that comes through in these review sessions is the interconnectedness of the systems, and the necessity of dealing with the issues as a systems opportunity. The CAWS relates to recreation, to commerce, to water quality, to water quantity, to flooding, and so on and so forth. You can't just construct a few barriers without addressing the full range of issues. You need to tell that story as effectively as possible. Since the various sub-systems are the "responsibility" of numerous different governments, and agencies within those governments, no one is articulating the public interest as it relates to the CAWS.*

*The summary suggested that there were no real issues with the economic analyses. I think that is true with respect to the suggested methodology. However, the devil is in the details. I don't think you can do a credible cost benefit analyses on water transport until you have the origin and destination data. For example, a comparison of barge costs from Lockport to the Port of Indiana with truck costs to the same port only makes sense if you know the cargo and the final destination. If the final destination is rock salt for Chicago, then trucking it from a port south of Lockport to Chicago might be cheaper than trucking it from Indiana. You can't just compare truck costs with barge costs.*

*In this same vein, the study has to ask the question as to whether or not the goal is to provide material to end users or to protect the interests of barge companies.*

*Because this is an engineering study, and one committed to completing a cost-benefit analysis, I fear that there is a bias toward engineering solutions that can be costed. As was suggested at the meeting, why not buy out the barge companies rather than build a barge transfer system. The answer, I fear, is that it is possible to cost a transfer station and we don't know how to cost a business purchase. The same is true for dealing with storm water. I thought I heard a bias toward more large scale retention systems (TARP II?) rather than a bias toward more aggressive use of natural systems of retention and use of I & I efforts because the latter were too "political". They are also more difficult to cost than another tunnel and quarry system.*

*The key point you make about "envisioning a waterway system for the 21st century" is correct, but I worry it will be misinterpreted. I know that we used the vision word a lot because it was in the title. However, I would not want the clients to feel that this was a "soft" approach we were recommending because it was too hard to do the "hard" job of a cost benefit analysis. When I think*

*of envisioning, I think of scenario planning, a technique developed by Royal Dutch Shell and used widely by large corporations and some large government agencies (the Department of Defense.) What Royal Dutch Shell and others have concluded is that when you are dealing with large, complex socio-political problems; long time horizons; and high costs (like building a billion dollar drilling rig) you can not use traditional planning and engineering techniques to develop an answer. You need to develop reasonable scenarios, based on existing conditions and emergent trends (like the change of leadership at MWRD, or the consistent decline in barge traffic, and so on.). This is all hard work that requires research, but is very different kind of work than engineering analysis. In other words, don't leave the impression that envisioning is a bunch a people sitting around a crystal ball coming up with nifty ideas.*

*Finally, I feel that the study is well down its path, and that doing a different approach is beyond the scope and cost of the project. I accept that, so the issue is what is the best way to present the terrific material that has been collected. My simplistic answer is to tell stories, paint pictures, acknowledge that we don't know what the future is going to be like, that 50 years is an eternity in a dynamic environment, and that we need a public debate about the possibilities, and that your value system would insist on a future that protects our water systems from invasive species, among other things. If there was a cost-benefit analysis for the Interstate Highway system, or the 1893 World's Fair, or for the building of the transcontinental rail system, no one remembers it today, and it was not what inspired people to act.*

**Reviewer Two:**

*I totally agree with Reviewer One's excellent comments. I want to add on to his point dealing with cost-benefit analysis. As we all know it is always very difficult to determine a monetary value of environmental benefits. Therefore cost-benefit discussions have pages and pages of discussion on costs with an impressive array of dollar amounts. When it comes to the discussion on benefits it tends to be short and very general and then maybe have some "guesstimate" dollar amounts. That often results in the economic environmental benefits getting short shrift in any subsequent discussions. I hope that will not be the case in this final report. The environmental problems from AIS are real and very costly to society. Somehow that has to come through in the discussion using real world examples such as the economic damage from zebra mussels, etc. to demonstrate the benefits of preventing the movement of AIS in to and out of the Great Lakes.*

*Reviewer One made some brilliant comments in his discussion of scenario planning. It may not always be possible to use traditional planning and engineering techniques to develop an answer. You need to develop reasonable scenarios, based on existing conditions and emergent trends (like the change of leadership at MWRD, or the consistent decline in barge traffic, and so on.). This is all hard work that requires research, but is very different kind of work than engineering analysis. In other words, don't leave the impression that envisioning is a bunch a people sitting around a crystal ball coming up with nifty ideas. " I totally agree with his astute comments!*

*And again I fully endorse what Reviewer One said in his final. His "simplistic answer" captures exactly what I have been wrestling with on how to portray this very complex separation issue.*

**Reviewer Three:**

*I agree with the other reviewers that the report should not be oversold as "envisioning"; the limits of the study focus should be acknowledged up front. Namely, that the working assumption is that separation is the only realistic approach to AIS mitigation, and that barriers are the interim engineering solution in the medium term (though long run re-engineering and other green modifications to our waste systems should be the ultimate goals that obviate even the need for barriers). However, I don't think that the report needs to be apologetic about its "envisioning" terminology. The report envisions feasible and cost effective pathways to achieving separation. It lights the way, and moves the ball forward in discussion by illustrating the positive cost-benefit outcomes of separation, which are arrived at through specific engineering solutions and which impose no major trade-offs that would achieve AIS goals only at the expense of the other major uses of the waterway. Time and resources of the project preclude full assessment and "visioning" of boosting the other social goals of the waterway--transportation and recreation, and ultra-improved water quality. Yet it is "envisioning" nonetheless. One can acknowledge that other studies may find ways to improve the other uses of the waterways in the future; the report believes that the separation avenues laid out will not be incompatible with those.*

*A few specifics:*

*The discount rate that is standard by the ACE was agreed on by the committee. Some will argue that benefits should be discounted by a higher rate. However, the low rate of return to capital that we are witnessing over the past 10 years in the Western Hemisphere suggests that higher discount rates are more and more dubious. That is, alternative uses of funds (versus the waterway improvements) will not likely achieve very high returns; hence the low discount rate is appropriate.*

*While I and the committee have not apparently read the previously prepared alternative studies of the Cost-Benefit ilk that estimate the costs of transportation disruption (if barriers are imposed), I think that we were emphatic that these 9 previous economic evaluations) were deeply flawed in their methods. I can see that, with the release of your report, these other (competing) studies will be trotted out, and presented to the public in a journalistic way that suggests that "there are many opinions". Accordingly, this report's analysis should probably spend some time and ink to disparage these reports as honorable but preliminary and deeply flawed.*

**Reviewer Four:**

*Envisioning vs. mitigating and the relationship to quantifying AIS associated costs*

*Option 1) If the goal of this project is to lay out options for reducing the risk of AIS movement by building a physical separation between the basins, with corresponding strategies for mitigating*

*possible negative effects in water quality, stormwater, etc., then I don't think you need to worry about trying to assess AIS costs, only the mitigation costs. You're saying that preventing AIS movement is of the utmost importance, that it is your goal, and that you are willing to pursue it even at the risk of imposing negative consequences on water quality, stormwater, etc. (albeit, some of those can be mitigated). It is my belief that the client believes reducing the risk of AIS movement is of singular importance (as informed by environmental ethics more than economics), that this goal is a "given," and that they would be willing to pursue it even at the expense of these other issue areas (i.e. "We will solve this problem no matter what it costs"). To go back to the point made by Reviewer One when the folks planning the Interstates, World's Fair, and continental railroad decided to do those things, it's because they believed that they were fundamentally important, and some harmful consequences were worth it (displacing landowners, for example). I continue to believe this what the client actually wants, and if so, they should say it. This is still "envisioning" – but it's envisioning an end to AIS movement.*

*Option 2) If the goal of this project is to envision the waterway system for the next century, trying to make everything about it better, then I think reducing the risk of AIS movement is one goal in competition with an array of other goals, and now you have to weigh the full set of costs and benefits against each other in all these other areas of concern. The danger here is that the costs associated with AIS movement, and the danger they present, and thus the benefit of prevention, may very well not be greater than the costs associated with altering the status quo in all the other issue areas. There are trade-offs inherently involved.*

*These seem to me to be two distinct projects. What we currently have is somewhere in the middle.*

#### *Political solutions vs. engineering solutions, inertia on "big ideas"*

*Akin to some of Reviewer One's comments, there has been a distinct bias toward engineering solutions throughout, with the argument that some things are just too political and cannot be controlled. All of this is going to be equally politically charged. Purchasing existing reservoirs, land swaps, buy-outs, etc., are all legitimate options consistent with the goals of the project, but seem to be getting dismissed. Additionally, some of the new "big ideas" we discussed (some of which are included in the non-engineering solutions), like well injections or the backdoor port in Indiana seem to have been marginalized as options as well, based on the argument that they would be "major undertakings." At the same time, a second TARP system and an island port in the lake have both been suggested... and would both be major undertakings. We can't let inertia get the better of us here. If this is a vision, and there are some big ideas and non-engineering ideas that would be consistent with reaching the client's goals, they need to be included.*

#### *Improving transportation vs. protecting barge owners*

*These are not the same thing. The focus should be on how we can best move commodities through the region, given changes in the waterways. The work to date proposes a series of investments whose only guaranteed benefit is mitigating negative responses from the barge owners as much as possible. I don't see a scenario other than the status quo that barge owners will like, so it would behoove the team not to constrain themselves to make the barge folks happy.*

**Reviewer Five:**

*I agree that the project scope definition was a key point that emerged during the meeting that needs to have further discussion with the sponsors."*

*Regarding the issue of Lake Michigan water diversion, I do not think it is likely that the other Great Lakes States will just stand back and let Illinois continue to take 3200 cfs from Lake Michigan annually if the separation allows, for example, the runoff from the North and South Branches and the treated effluent from the North Side Water Reclamation Plant to flow to the Lake and decrease the diversion (for the Mid-System Alternative). I have spent nearly 20 years working on Lake Michigan Diversion issues, first as a U.S. Geological Survey staffer supporting the U.S. Army Corps of Engineers and the 3<sup>rd</sup> and 4<sup>th</sup> Lake Michigan Diversion Review Committees and then as a member of the 5<sup>th</sup> and 6<sup>th</sup> Lake Michigan Diversion Review Committees, and I am sure that the other Great Lakes States would file to keep this water in the lakes and not let Illinois continue to divert the same amount. Part of the Supreme Court's view was that the diversion of runoff and effluent was needed to keep the Lake clean, and, thus, Illinois was allowed to divert this water. However, if the diversions are not to keep the Lake clean, but merely for water supply in northern Illinois they would probably eventually be subject to the terms of the Great Lakes Compact. So, I really do not think Illinois would get a water supply benefit, on the other hand the Great Lakes would get the benefit of more water returned to the Lakes. However, the benefit of additional water reaching the Lakes would be hard to quantify.*

*Some discussion of the extreme difficulty of estimating the costs for the additional flood mitigation and water-quality improvement measures must be included in the report. We do not really have a clear picture of the post-TARP reservoir completion flood risks and, especially, the post-TARP reservoir completion water quality in the CAWS (these estimates should be available next year in Marquette's GLMRIS study for the Corps). Thus, estimating the facilities necessary to maintain flood risks and water quality in the CAWS to these unknown post-TARP reservoir completion conditions is an extreme SWAG. This needs to be made completely clear up-front in the report, so that people do not get the idea that somehow the Corps could estimate these things right now, as some of the Peer Review Team members wondered during our August 31 Review Meeting.*

*Regarding the concept of injecting excess runoff into deep wells to replenish the aquifers, whereas this approach may have some value toward restoring water levels in aquifers the injection rates that are likely to be feasible will have little effect on flood volumes. The rates at which you can push water into aquifers is far, far smaller than flood runoff rates. Aquifer replenishment also would require substantially treated water before injection. Aquifer replenishment probably is a worthwhile goal, but it is not a flood reduction method.*

*Solving actual flooding issues is going to require some hard engineering solutions. Green Infrastructure and/or "natural systems of retention" generally are considered to be effective in reducing the volume of runoff for storms of two year return period (i.e. storms that occur once on average every two years) or less. Thus, these systems are great for helping reduce raw annual*

*pollutant loads and the total amount stored in and pumped out of TARP over a typical year, but they would not provide much flooding relief for downtown Chicago in a large storm for the Near Lake Alternative even with TARP fully on line because of difficulties in getting high flows from their source areas to the TARP reservoirs (TARP conveyance issues) and also the conveyance limitations of the waterways.*



## Envisioning a Chicago Area Waterway System for the 21st Century

# Cost-Benefit Analysis of Physical Separation Options Peer Review



ONE COMPANY | Many Solutions™

## Agenda

- CBA Considerations for CAWS Study
  - Approach
  - Study period
  - Discount rate
  - Base Case
  - Treatment of Mitigation Options
- Miscellaneous topics for this CBA
  - Transfers, jobs, property values, sunk costs
- Brief literature review for context

2

## Agenda (cont'd)

- Benefits and Costs of Separation
- Quantification Approach
- Integrating AIS impacts into the CBA
- Final Products - Economic Outputs

3

## General CBA Framework

Example of Benefits      Costs

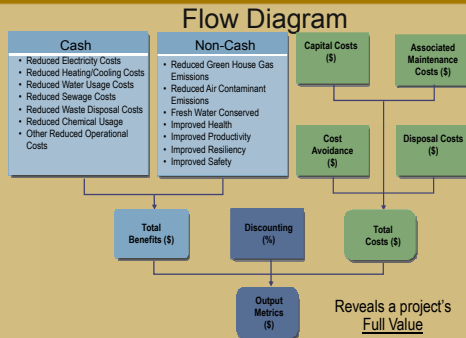

4

## CAWS CBA: Study Period

- Study period that extends 30 years from barrier completion (including mitigation)
- Sensitivity analysis can be done to assess the impact of various study periods (e.g., 50 years)
  - Residual value can be used to extract any remaining value from the barrier post the formal study period

5

## CAWS CBA – Discounting

- Recommend using various discount rates to be compliant with federal guidelines
  - 3% real (consistent with USACE)
  - Sensitivity: 7% real (OMB guidance)
  - Other sensitivities

6

## CAWS CBA

- Quantify the net public value of 3 alternatives for physical separation relative to a base case option
- Mitigation for transportation, ecological health and storm water management is included in each option consistent with overall study objectives
- Understand the relative importance of all potential costs and benefits (by stakeholder) for each alternative

7

## CAWS CBA: The Base Case

- The “Base Case” includes:
  - Mitigation of AIS transfer through electrification
  - Current and programmed and authorized infrastructure investments:
    - Transportation – CREATE, Chicago Park District Marina (1200 slips)
    - Storm Water Management – TARP
      - Phased in per timeline – 2029
      - Improved conveyance in accordance with TARP
    - Water Quality
      - Disinfection on North Side and Calumet Plants

8

## CAWS CBA: Options

- The Options includes separation barriers at:
  - Locations: Mid River
  - Locations: Near Lake
  - Locations: Down River

9



## CAWS CBA: Treatment of Mitigation Options

- Mitigation strategies have been designed to minimize the effects of physical separation
- The cost-benefit analysis includes the costs and benefits associated with these strategies consistent with project objectives
  - Example: storm water management strategies designed to ensure flooding no worse off than base case

10

## CAWS CBA: Transfers

- The CBA will assess the impact on “users”
- Physical separation will result in transfers of benefits from one entity to another (e.g., winners and losers)
- Example: Cargo transport
  - Some cargo that moves by barge in the base case will change transportation modes in the Alternate Case
  - The net impact in the CBA will be the difference in shipping costs between modes of transportation (+ externalities)
  - Barge operators will lose revenue; other transportation modes will gain revenue
- The CBA can highlight the “winners” and “losers” but the net effect is the difference/increase in shipping costs

11

## CAWS CBA: Jobs

- CBA analysis does not focus on “jobs” or “employment”
- CBA analysis focuses on the effect on social welfare
- CBA is different from economic impact analysis
  - EI analysis usually a marketing tool for an organization – focuses on jobs
- In many instances, reducing user costs entails reducing employment (and vice versa)
- The CAWS CBA analysis will not explicitly measure or include job impacts

12

## CAWS CBA: Property Values

- Changes in property values from an investment are often the result of other impacts
- Inclusion of property value changes may double-count these other effects
- Example:
  - Physical separation may increase shipping costs for some terminal operators making their site less attractive and decreasing property values
  - The increase in shipping costs captures this effect
  - The decrease in property values is the capitalization of these increased costs (over time)
  - To include both in a CBA would be double-counting

13

## CAWS CBA: Sunk Costs

- CBA's are forward-looking
- Costs and impacts considered are those that will happen in the future
- Past investments are not considered in a CBA
- For example:
  - Investments by terminal operators (that may be impacted by separation) in new facilities are not considered in CBA's
    - These costs are “sunk”
- These past investments may be considered by policy makers but are irrelevant in the CBA context

14

## Literature Review

15

## Economics Literature Review

- DePaul University Study, April 2010
  - Closure of Chicago and O'Brien Locks
  - Most comprehensive study on closures
  - NPV = - \$4.7 billion
- Key Findings
  - Existing shipper costs - \$89 million annually
    - \$12/ton cost difference for barge and other modes
  - Costs to intra-lake barge users = \$6 million annually
  - External Costs from modal shifts = \$27.5 million annually

16

## Economics Literature Review DePaul (cont'd)

- Key Impacts
  - Cost to recreational boaters - \$10M/yr
  - Commercial tours and cruises - \$20M/yr
  - Public protection - \$6M/yr
  - Storm water, flooding and water reclamation \$375M/yr for 8 years
  - Decline in property value = \$51M
    - From decline in water quality

17

## Economics Literature Review Taylor, 2010

- Taylor Affidavit, 2010
  - Assumed physical barriers at existing locks
  - Goods movements focus only
  - Goods transloaded to other modes near barrier site
  - Assumed all goods have either a local Origin or Destination within 25 miles
  - Additional shipping costs - \$9-\$10/ton or \$60-70M/yr
  - Affidavit does not consider possibility of transloading to rail or barge across barrier

18

## Economics Literature Review Muench, 2010

- Lynn Muench, 2010
  - Many businesses devastated by closure
    - cites many examples
  - Transfer of cargo to rail or truck before CAWS would require massive facility for loading and unloading that could not be built in short run
  - Restricted access to shipyards
  - Property values on Cal-Sag would drop
  - Lock closures would not stop AIS transfer
- Lynn Muench, 2011
  - Would destroy the existing industry

19

## Economics Literature Review TTI/USACE

- Texas Transportation Institute
  - Study for all inland waterway systems in U.S.
  - Examines congestion, emissions, safety, and infrastructure
  - \$11/ton cost difference of barge to other modes on average
- USACE (report not yet complete)
  - \$27/ton cost difference of barge to other modes

20

## Economics Literature Review GAO, 2011

### Comparison of External Transportation Cost

Table 4: Cross-Modal Comparisons of Externalities\*

Category	Type	Trucking	Railroad	Waterways	Trucking to rail ratio <sup>2</sup>	Trucking to waterways ratio
Air pollution <sup>1</sup>	Tons of particulate matter per million ton-miles, 2002	0.1194	0.0179	0.0192 <sup>3</sup>	6.7	10.2
	Tons of nitrogen oxide per million ton-miles, 2002	3.0193	0.6747	0.4691 <sup>3</sup>	4.5	6.4
	Tons of CO2 equivalents per million ton-miles, 2007	320.8	28.98	17.48	7.9	13.1
Accidents <sup>4</sup>	Fatalities per billion ton-miles, avg. 2003-2007	2.54	0.39	0.01	6.4	208.8
	Injuries per billion ton-miles, avg. 2003-2007	55.98	3.32	0.05	16.9	1,239.6
Congestion <sup>5</sup>	Cost of delay to road users in 2006, (in billions of constant 2010 dollars)	\$10.86	\$0.58	Not available	18.6	Not available

\*Source: GAO analysis of data from DOT, EPA, and the Texas Transportation Institute.

21

## Benefits and Costs of Separation

- Identified a number of costs and benefits of separation for quantification in the CBA
  - See RAP Workbook Table 2
- Developed a framework for quantifying these impacts
  - RAP Workbook Page 10

22

## Quantifying AIS Impacts: Available Data

- Quantification Requires Forecasts of:
  - species transfer between basins;
  - likelihood of species becoming established, if transferred;
  - likelihood of species becoming invasive, if established; and,
  - economic and environmental impacts, if invasive
- No explicit forecasts of future species transfer
- Studies do provide costs of AIS historically
- USACE starting a quantitative assessment for GLMRIS

23

## Quantifying AIS Impacts: Discussions with SME's

- Discussions held with SME's
  - Greg Sass, Phil Moy, Frank Veraldi
- Discussions confirm that no quantitative data exists on forecasting future AIS impacts
- SME's question value of developing an estimate in this study
  - “why go there?”
  - Potentially damage credibility of overall study

24

## Quantifying AIS Impacts: Integrating Into CBA

- Develop a case studies based on historical AIS impacts to assess potential damage impacts of AIS
  - Annual and over full study period
- Compare case study impacts to the other impacts quantified in the CBA to assess whether benefits outweigh costs

25

## Final CBA Products (other ppt)

26

## Next Steps

- Incorporate peer review feedback into economic framework
- Review economic framework with AC
- Populate model with inputs
  - Draft economic model programmed and most draft inputs collected
  - Need cost and cargo forecast data
- Preliminary results review at September RAP session

27



## APPENDIX D. ADVISORY COMMITTEE MEETING MATERIALS

- ADVISORY COMMITTEE MEMBERS
- RESOURCE GROUP MEMBERS

### **D1. AC MEETING 2-16-2011**

- MEETING AGENDA
- MEETING ATTENDEES
- MEETING MINUTES
- PROJECT UPDATE PRESENTATION
- STUDY OVERVIEW PRESENTATION
- EVALUATION CRITERIA

### **D2. AC MEETING 6-29-2011**

- MEETING AGENDA
- MEETING ATTENDEES
- MEETING MINUTES
- STUDY OVERVIEW PRESENTATION
- TRANSPORTATION PRESENTATION

### **D3. AC MEETING 10-19-2011**

- MEETING AGENDA
- MEETING ATTENDEES
- MEETING MINUTES
- PROJECT UPDATE PRESENTATION



# Envisioning a Chicago Area Waterway System for the 21st Century

---

## Project Advisory Committee Members

Updated January 5, 2012

### **Alliance for the Great Lakes**

Mr. Joel Brammeier  
President and CEO  
17 N. State St., Suite 1390  
Chicago, IL 60602  
Ph: 312-939-0838  
jbrammeier@greatlakes.org

### **American Waterways Operators**

Ms. Lynn Muench  
Senior Vice President – Regional  
Advocacy  
1113 Mississippi Avenue, Suite 108  
St. Louis, MO 63104  
314-308-0378  
lmuench@vesselalliance.com

### **Chemical Industry Council of Illinois**

Mr. Mark Biel  
Executive Director  
400 W. Monroe, Suite 205  
Springfield, IL 62704  
Ph: 217-522-5805  
mbiel@cicil.net

### **Chicago Metropolitan Agency for Planning**

Mr. Timothy Loftus  
Principal, Water Resources and  
Project Director  
NE IL Regional Water Supply  
Planning  
233 South Wacker Drive, Suite 800  
Chicago, IL 60606  
Ph: 312-386-8666  
tloftus@cmap.illinois.gov

### **Chicago Yachting Association**

Cdre. Richard Lauric  
Commodore  
3726 North Odell Avenue  
Chicago, IL 60634  
commodore@chicagoyachtingassociation.org

### **Chicago's First Lady Cruises**

Ms. Holly Agra  
President  
675 North Court, Suite 300  
Palatine, IL 60067  
Ph: 847-358-1330  
holly@cruisechicago.com

### **Council of Great Lakes Industries**

Mr. George Kuper  
President  
3600 Green Ct., Suite 710  
Ann Arbor, MI 48105  
Ph: 734-663-1944  
ghk@cgli.org

### **Environmental Law and Policy Center**

Mr. Howard Learner  
President and Executive Director  
35 East Wacker Drive, Suite 1600  
Chicago, IL 60601-2110  
Ph: 312-673-6500  
hlearner@elpc.org

### **Friends of the Chicago River**

Ms. Margaret Frisbie  
Executive Director  
28 East Jackson, Suite 1800  
Chicago, IL 60604-2272  
Ph: 312-939-0490, ext. 22  
mfrisbie@chicagoriver.org

### **Great Lakes Panel on Aquatic Nuisance Species**

Dr. Phil Moy  
Great Lakes Panel Chair  
University of Wisconsin Sea Grant  
Institute  
705 Viebahn Street  
Manitowoc, WI 54220-6699  
Ph: 920-683-4697  
pmoy@uwc.edu

### **Great Lakes Sport Fishing Council**

Mr. Dan Thomas  
President  
P.O. Box 297  
Elmhurst, IL 60126  
Ph: 630-941-1351  
dan@great-lakes.org

### **Great Lakes United**

Ms. Jen Nalbone  
c/o Daemen College  
4380 Main Street  
Amherst, NY 1422  
Ph: 716-213-0408  
jen@glu.org

### **Healing Our Waters – Great Lakes Coalition**

Mr. Andy Buchsbaum  
Executive Director, Great Lakes  
Regional Center  
National Wildlife Federation  
213 W. Liberty St., Suite 200  
Ann Arbor, MI 48104  
Ph: 734-887-7100  
buchsbaum@nwf.org

### **Illinois Chamber of Commerce**

Mr. Gideon Blustein  
300 S. Wacker Drive, Suite 1600  
Chicago, IL 60606  
Ph: 312-983-7100  
Gideon.blustein@gmail.com

### **Illinois Farm Bureau**

Mr. Kevin Rund  
Sr. Director of Local Government  
Illinois Agricultural Association  
P.O. Box 2901  
Bloomington, IL 61702-2901  
Ph: 309-557-3274  
KRund@ilfb.org

### **Illinois International Port District**

Mr. Anthony Ianello  
Executive Director  
3600 E. 95th Street  
Chicago, IL 60617-5193  
Ph: 773-646-4400  
IIPD@IIPD.com

### **Illinois River Carriers Association**

Mr. John Kindra  
President  
Kindra Lake Towing  
9864 Avenue N, Ste. 100  
Chicago, IL 60617  
Ph: 773-721-1180  
jkindra@kindralake.com

### **Lake Erie Charter Boat Association**

Mr. Rick Unger  
President  
735 Timber Ln  
Port Clinton, OH 43452  
Ph: 216-401-6231  
rungerchpd@aol.com

**Metropolitan Mayors Caucus**

Mr. David Bennett  
Executive Director  
177 North State Street, Suite 500  
Chicago, IL 60601  
Ph: 312-201-4505  
dbennett@mayorscaucus.org

**Metropolitan Planning Council**

Mr. Josh Ellis  
Project Manager  
140 S. Dearborn St., Suite 1400  
Chicago, IL 60603  
Ph: 312-863-6045  
jellis@metroplanning.org

**Metropolitan Water Reclamation  
District of Greater Chicago**

Mr. David St. Pierre  
Executive Director  
100 East Erie Street  
Chicago, IL 60611-3154  
david.stpierre@mwrdd.org

**Michigan Chamber of Commerce**

Mr. Doug Roberts  
Director of Environmental and  
Energy Policy  
600 S. Walnut Street  
Lansing, MI 48933  
Ph: 517-371-7673  
DRoberts@michamber.com

**Mid-West Truckers Association**

Mr. Don Schaefer  
Executive Vice President  
2727 North Dirksen Parkway  
Springfield, IL 62702  
Ph: 217-525-0310  
Dhscubs@aol.com

**Natural Resources Defense Council**

Mr. Henry Henderson  
Midwest Program Director  
2 N. Riverside Plaza, Suite 2250  
Chicago, IL 60606  
Ph: 312-663-9900  
hhenderson@nrdc.org

**Northeast Ohio Mayors & City  
Managers Assoc.**

The Honorable Debbie Sutherland  
City of Bay Village  
350 Dover Center Rd.  
Bay Village, OH 44140  
Ph: 440-899-3415  
dsutherland@cityofbayvillage.com

**Northwest Indiana Forum**

Ms. Kay Nelson  
Director of Environmental Affairs  
6100 Southport Road  
Portage, IN 46368  
Ph: 219-763-6303, ext.190  
knelson@nwiforum.org

**Ontario Federation of Anglers and  
Hunters**

Dr. Terry Quinney  
OFAH Provincial Manager, Fish and  
Wildlife Services  
P.O. Box 2800  
Peterborough, Ontario K9J 8L5  
Ph: 705-748-6324  
terry\_quinney@ofah.org

**Prairie Rivers Network**

Ms. Glynnis Collins  
Executive Director  
1902 Fox Drive, Suite G  
Champaign, IL 61820  
Ph: 217-344-2371  
gcollins@prairierivers.org

**Sierra Club - Illinois Chapter**

Mr. Jack Darin  
Director  
70 East Lake Street, Suite 1500  
Chicago, IL 60601  
Ph: 312-251-1680  
jack.darin@sierraclub.org

**Wendella Boats**

Mr. Michael Borgstrom  
President  
405 W. Wabash, Suite P2E  
Chicago, IL 60611  
Ph: 312-205-4044  
msb@wendellaboats.com

**West Michigan Strategic Alliance**

Mr. Greg Northrup  
President  
P.O. Box 68046  
Grand Rapids, MI 49516-8046  
Ph: 616-356-6060  
northrupg@wm-alliance.org



## **D1. AC MEETING 2-16-2011**

- MEETING AGENDA
- MEETING ATTENDEES
- MEETING MINUTES
- PROJECT UPDATE PRESENTATION
- STUDY OVERVIEW PRESENTATION
- EVALUATION CRITERIA



# Envisioning a Chicago Area Waterway System for the 21st Century

---



*A joint project of the Great Lakes Commission  
and the Great Lakes & St. Lawrence Cities Initiative*



## **Project Advisory Committee Meeting**

*Wednesday, February 16, 2011*

*Chicago Cultural Center - Garland Room, Fifth Floor*

*78 E. Washington St., Chicago, Illinois*

### **MEETING AGENDA**

10:00 a.m.	<b>Welcome, Introductions and Agenda Review</b>	Tim Eder, Executive Director, Great Lakes Commission Dave Ullrich, Executive Director, Great Lakes & St. Lawrence Cities Initiative
10:10 a.m.	<b>Remarks from Project Executive Committee</b>	Marc Miller, Director, Illinois Dept. of Natural Resources Joe Deal, Office of the Mayor, City of Chicago Haris Alibasic, City of Grand Rapids
10:20 a.m.	<b>Project Update and Meeting Purpose</b>	Tim Eder, Great Lakes Commission
10:30 a.m.	<b>Presentation by Phase II Consulting Team</b>	HDR Engineering, Inc. and Team (Greenleaf Advisors, Bergmann Associates, Vickermann & Associates, Ecological Monitoring and Assessment, DHI, and Carolyn Grisko & Associates)
11:30 a.m.	<b>Questions and Discussion with HDR Team</b>	All Participants
12:15 p.m.	<b>Lunch</b>	
1:15 p.m.	<b>Developing Criteria for Selecting Separation Options</b>	Dave Ullrich, Great Lakes & St. Lawrence Cities Initiative All Participants
2:45 p.m.	<b>Break</b>	
3:00 p.m.	<b>Additional Comments and Discussion</b>	Advisory Committee and Resource Group
3:45 p.m.	<b>Action Items and Next Steps</b>	Tim Eder, Great Lakes Commission Dave Ullrich, Great Lakes & St. Lawrence Cities Initiative Jim Ridgway, Environmental Consulting and Technology, Inc.
4:00 p.m.	<b>Adjourn</b>	



*Envisioning a Chicago Area Waterway System for the 21st Century*  
**Project Advisory Committee Meeting**  
*Wednesday, February 16, 2011*

**Morning Session**

General discussion and Introduction of HDR – Lead Consultant

- 1) Opening comments and encouragement by Executive Committee
- 2) GLC/CI reiterated Purpose and Progress to Date
  - a. \$2 Million funding secured – Contractor selected – On track – Within budget
  - b. Encouraged continued input from all stakeholders
  - c. Two more AC meetings. Tentative dates – June 29 & Sept 20
  - d. Added public meetings throughout GL region
  - e. Added two peer review sessions
  - f. The entire process will be open and inclusive!
    - i. Realize we will not get consensus
    - ii. When conflicting views are presented, we still want open and transparent discussion
  - g. Will identify three alternatives plus a “baseline”
  - h. Not just an invasive species project
  - i. Very happy with 1<sup>st</sup> meeting – Requested that all participants keep discussion lively but civil
  - j. To encourage free discussion, there will be no minutes – no attribution
- 3) HDR presented Project Team – Introduced members
  - a. Explanation of Study Process - Mechanics of receiving input, distilling information, identify a large number of options, distill to five, peer review, share with AC, further distill to three, peer review, share with AC, write final report
  - b. Economic Analysis – Based on cost benefit analysis but include public value (both social and environmental) - Will identify risks and uncertainties
  - c. Transportation – Must be market driven – Accommodate current customers – Maximize use of existing capabilities – then and only then, recommend new facilities
  - d. Project must align micro-economic trends with macro-economic trends – Followed by discussion of expected long term trade patterns and the potential impact of an expanded Panama Canal with particular interest in the impact to Class 1 railroads
- 4) Resource & Interest Group
  - a. Discussion on on-going and future stakeholder interviews
  - b. “not the end of the discussions”
  - c. Will continue to identify and rely on the individuals with the best information
  - d. Truly appreciate the cooperation shared by all stakeholders
- 5) Project Summary / Presentation
  - a. Final Integration Report (12/15/2011)
  - b. Final Report Summary
- 6) Deliverables

- a. Will provide “read ahead material” for all meetings including the two future AC meetings
- 7) Closing Comments
- a. Study will be fluid
  - b. HDR committed to “listen to all stakeholders throughout the process”

Questions Posed by AC members

- 1) How will we know that “we have been heard”?  
*Project will continuously request input – all input will be available on the website – written comments welcome – Copies of all materials and slides available on line - summaries of all stakeholder interviews are available on line*
- 2) What will be done with unsubstantiated claims by stakeholders?  
*Information will be taken and evaluated by project team – GLC/CI must provide leadership – GLC/CI will “attach the appropriate weight” to these and all matters.*
- 3) How can we share information with the people that we represent?  
*GLC/CI will provide read-ahead material that can be shared with your constituents.*
- 4) How do you plan to quantify those “difficult to quantify” aspects of the project?  
*That is difficult to define today. The HDR team will lay out the entire scope for this process and seek input from AC members. Weighting will be applied to all assumptions. As an example, there are numerous (and widely varying) estimates for the economic impact of recreational fishing. It is our job to pick the best estimate, assign an estimate of uncertainty, and share these assumptions with the AC and general public. The process will also focus on the most important driving forces and limit analysis on less important variables.*
- 5) Who is the “relevant, current, incumbent user”? How can we identify new industries?  
*That’s our job (this claim will be discussed later). Plan must look 20 years out – in convergence there will be winners and losers – rising tide lifts **most** boats.*
- 6) Will copies of interviews be available?  
*Yes*
- 7) Will copies of slides be available?  
*Yes*
- 8) Will details of risk analysis be available?  
*Yes*
- 9) Will safety concerns associated with transferring hazardous chemical from barge to trucks be considered?

*Yes*

10) What will be done to address the hydrology/hydraulics associated with each scenario?

*Will use current models available through MWRD/Universities/USACE – Future model runs may be required – simple calculations using USGS information will be performed – Project does not intend any “new” model development or modeling - will rely on existing modeling and expertise.*

11) Will climate change be incorporated?

*Project will address impact of lower water levels as well as impact of more frequent and larger storms.*

12) The HDR team was invited to include the impact on tribal fisheries and other tribal industries.

13) Is GLC/CI seeking additional resources?

*No*

14) Would GLC/CI welcome help in hosting the additional meetings–

*Yes*

15) Will the study include recreational users?

*Yes*

16) Will the “No Action” alternative be similar to USACE “no action” process?

*No – This was a recurring question throughout the day and will require further discussions with members of the AC. Basically, the intent is to define the “baseline case” as one that would include all activities that would happen with or without the separation project. Because several major projects are expected to occur in the near future (completion of TARP – possible disinfection of some wastewater discharges), these costs could be included in the baseline case, all four cases, or a subset of the four options.*



*Envisioning a Chicago Area Waterway System for the 21st Century*  
**Project Advisory Committee Meeting**  
*Wednesday, February 16, 2011*

**Afternoon Session**

**Discussion on General Principles**

**General:**

- 1) Are the suggested principles really principles? When asked for potential principles the following were offered:
  - a. First –do no harm
  - b. All data will be validated and/or annotated
  - c. Fear (should not drive the project)
  - d. Economic efficiency
  - e. Reduce energy use
- 2) Are Principles to pertain to CAWS or to a larger geography?

**Guiding Principles** – The following notes on the Guiding Principles are taken from discussions throughout the day. Some conflict with one another but are included for completeness.

**I) Preventing the transfer of aquatic invasive species (suggested new name – Prevent and/or Reduce aquatic invasive species):**

- Transfer of AIS, means transfer both ways
- Prevention vs. reduce risk? Which are we trying to accomplish?
- Limit the scope to prevention of transfer of AIS through the CAWS by means of a separation
- Invasive species threats will change as a result of climate change
- How many species are moving before and after separation

**II) Improve water quality (suggested new name – Environmental Quality and Ecology or Improve Ecosystem Integrity):**

- Include environmental quality in CAWS and Lake Michigan
- Include ecological integrity
- Clarify geographic scope (e.g., CAWS and Lake Michigan? Other?)
- Identify and limit activities that have a negative effect on water quality
- CAWS must meet federal clean water standards. Compliance with Clean Water Act is an independent guarantee for citizens
- Water quality improvement can be measured by evaluating the improvement in the ecological integrity of the CAWS. Include air quality as well as water quality
- Use the SOLEC 87 Indicators – the 87 most important indicators identified by State of the Lakes Conference
- Alternatively – stick with the CWA – Physical/Chemical/Biological standards
- Define geographic scope
- Geographic boundaries should match “decision making” boundaries
- Identify impact on desired AIS control on adjacent land uses
- Develop specific criteria based on different watersheds
- Use established water quality standards, including as they may be looked at in the future

### **III) Improve transportation (i.e., movement of goods, materials and people):**

- Cost is the critical factor
- Include reliability/competitive rates/speed
- Include improvements in freight mobility
- Include the impacts of lower water levels
- Include financial impacts of shifts in mode of transportation – Barges set market pricing
- Include impact of additional truck traffic; air pollution, congestion, traffic safety
- How it meshes with existing traffic planning (CREATE ??)
- Impact on existing commerce
- Impact on jobs
- Reliability, cost, competitive rates, speed
- Freight mobility improvements
- Ability to adapt to climate change – i.e., lower/ higher water levels and more frequent/intense precipitation events
- Impact to other modes of transportation and their impact on air quality
- Waterways are typically the lowest cost alternative and tend to set rates
  - Can't assume other modes will have the same capacity to handle it or will take it at the same rate (which could drive costs up)
- Reliability – barge vs. truck reliability are different
- Impact on highways, roads
- Energy use, especially in terms of long term sustainability (may apply to other principles as well)
- Regional capability
- Impact on commercial navigation customers

### **IV) Improve storm water management:**

- Reduce storm water runoff
- Reduce treatment costs
- Reduce flooding
  - Basement flooding
  - Localized flooding
  - Large scale flooding
- Consider climate change adaptation to more frequent storms
- Need to consider the impact to Northwest Indiana residents as a result of flooding, storm water control in the CAWS
- Green infrastructure: what is it supposed to be doing, e.g., reduced treatment costs? Instead of looking at the extent to which it's being used
- Effect on berms, levies, and FEMA certification for those systems
- Social impacts of increased/reduced flooding
- Looking at different kinds of flooding and reducing incidents and severity (e.g., basement flooding versus CSOs)

### **V) Other potential principles (Suggested New Name – (Support Sustainable Development in Great Lakes – or - Cross-Cutting Issues) :**

- Support sustainable development in the Great Lakes basin
- Support sustainable economy in the Chicago area and the Great Lakes region
- Analyzed under each of the existing four principles
- Improve “quality of life”
  - Lifestyles, opportunities, etc.
  - Fatalities, congestion, stress

- Reduce air pollution, evaluate each alternative to differing “scale of benefit.”
  - Immediate downtown Chicago
  - Service Area of MWRD
  - CAWS
  - Great Lakes and Mississippi water system
- Consider changes to energy use
- Consider how recommendations fit with federal and state priorities
- Consider fundability of each proposed project

**General comments** (These comments were collected throughout the meeting but are not assigned to a specific Principle):

- Need to clarify geographic scope
- What purpose do the principles serve? i.e., how to conduct the study or outcomes that we desire?
- These are more objectives/goals, haven’t really heard anything that are “principles”
- Consider adding “without inhibiting existing commerce” to each of the four principles
- Don’t think anyone is dissenting to the general principles, but need to discuss how to account for them
- AIS does not need to be part of the principles, because it’s the purpose of the project – principles need to shape the criteria and the things we need to guide the process

# Envisioning a Chicago Area Waterway System for the 21<sup>st</sup> Century

A Joint Project of the  
Great Lakes Commission and the  
Great Lakes and St. Lawrence Cities Initiative



Tim Eder, Executive Director  
Great Lakes Commission  
734-971-9135 • teder@glc.org

Dave Ullrich, Executive Director  
Great Lakes and St. Lawrence Cities Initiative  
312-201-4516 • david.ullrich@gslcities.org



## Envisioning a Chicago Area Waterway System for the 21<sup>st</sup> Century

### Project Update

- Secured full project budget of \$2 million
  - Thanks to C.S. Mott Foundation, Frey Foundation, Great Lakes Fishery Trust, Great Lakes Protection Fund, Joyce Foundation, Wege Foundation
- Completed Phase I
  - Established Executive Committee, Advisory Committee & Resource Group
  - Hired HDR Engineering, Inc. to lead Phase II consultant team
    - Study approach & work plan



Tim Eder, Executive Director  
Great Lakes Commission  
734-971-9135 • teder@glc.org

Dave Ullrich, Executive Director  
Great Lakes and St. Lawrence Cities Initiative  
312-201-4516 • david.ullrich@gslcities.org



## Envisioning a Chicago Area Waterway System for the 21<sup>st</sup> Century

### Project Schedule

- **Phase I:** Hire consulting team and establish executive committee and advisory committee (July-Dec. 2010)
- **Phase II:** Identify options and scenarios for separation (Jan.-Oct. 2011)
- **Phase III:** Narrow options, evaluate scenarios, run models and prepare final reports (Oct.-Dec. 2011)

**Final outcomes by January 2012**



Tim Eder, Executive Director  
Great Lakes Commission  
734-971-9135 • teder@glc.org

Dave Ullrich, Executive Director  
Great Lakes and St. Lawrence Cities Initiative  
312-201-4516 • david.ullrich@gslcities.org



## Envisioning a Chicago Area Waterway System for the 21<sup>st</sup> Century

### Phase II Schedule

#### Overview

- January-April: Data collection & criteria development
- April-June: Develop preliminary options
- July-August: Options testing & analysis
- August-October: Options refinement & additional analysis

#### Important Dates (proposed)

- June 29: Advisory Committee Meeting
  - Provide input on preliminary options
- July 13: Public meeting in Chicago
- Sept. 12-15: Public meetings around the basin
- Sept. 20: Advisory Committee Meeting
  - Provide input on options and analyses



Tim Eder, Executive Director  
Great Lakes Commission  
734-971-9135 • teder@glc.org

Dave Ullrich, Executive Director  
Great Lakes and St. Lawrence Cities Initiative  
312-201-4516 • david.ullrich@gslcities.org



## Envisioning a Chicago Area Waterway System for the 21<sup>st</sup> Century

### Advisory Committee Meeting February 16, 2011

#### Meeting Purpose

- Introduce Phase II Consulting Team
- Review and Discuss Phase II Approach & Work Plan
- Initiate Development of Criteria for Evaluation of Separation Options



Tim Eder, Executive Director  
Great Lakes Commission  
734-971-9135 • teder@glc.org

Dave Ullrich, Executive Director  
Great Lakes and St. Lawrence Cities Initiative  
312-201-4516 • david.ullrich@gslcities.org



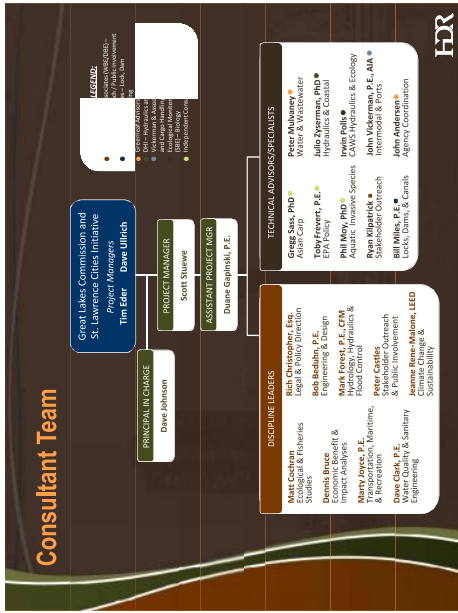
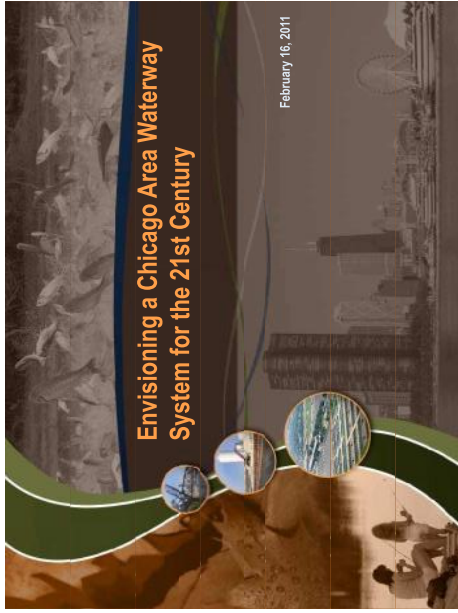

- ### Study Process
1. Resource Group data gathering & information sharing
  2. Review and Assess
  3. Option Development – based on principles, data, AC insights
  4. Re-evaluate
    - 1. New AC insight
    - 2. Additional data gathering
  5. Charrette – filter to 3 options
    - 1. GLC 1<sup>st</sup> Peer review May 9
    - 2. Full definition of 3 options
  6. AC meeting June 29
    - 1. AC meeting June 29
    - 2. Criteria Application
    - 3. Option evaluation
    - 4. GLC 2<sup>nd</sup> Peer review August 30
    - 5. AC meeting September 20
    - 6. Draft Report October 30
  7. Analysis
    - 1. Criteria Application
    - 2. Option evaluation
    - 3. GLC 2<sup>nd</sup> Peer review August 30
    - 4. AC meeting September 20
    - 5. Draft Report October 30
  8. Final Report (December)
- Guiding Principles  
Criteria Analysis

- ### Study Process
1. Resource Group data gathering & information sharing
  2. Review and Assess
  3. Option Development – based on principles, data, AC insights
  4. Re-evaluate
    - 1. New AC insight
    - 2. Additional data gathering
  5. Charrette – filter to 3 options
    - 1. GLC 1<sup>st</sup> Peer review May 9
    - 2. Full definition of 3 options
  6. AC meeting June 29
    - 1. AC meeting June 29
    - 2. Criteria Application
    - 3. Option evaluation
    - 4. GLC 2<sup>nd</sup> Peer review August 30
    - 5. AC meeting September 20
    - 6. Draft Report October 30
  7. Analysis
    - 1. Criteria Application
    - 2. Option evaluation
    - 3. GLC 2<sup>nd</sup> Peer review August 30
    - 4. AC meeting September 20
    - 5. Draft Report October 30
  8. Final Report (December)
- Guiding Principles  
Criteria Analysis

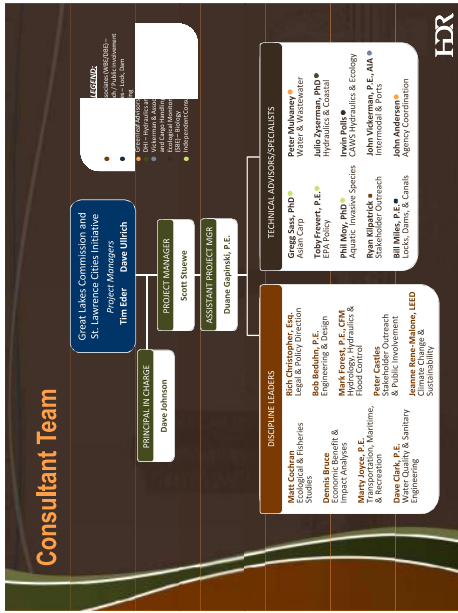

- ### Study Process
1. Resource Group data gathering & information sharing
  2. Review and Assess
  3. Option Development – based on principles, data, AC insights
  4. Re-evaluate
    - 1. New AC insight
    - 2. Additional data gathering
  5. Charrette – filter to 3 options
    - 1. GLC 1<sup>st</sup> Peer review May 9
    - 2. Full definition of 3 options
  6. AC meeting June 29
    - 1. AC meeting June 29
    - 2. Criteria Application
    - 3. Option evaluation
    - 4. GLC 2<sup>nd</sup> Peer review August 30
    - 5. AC meeting September 20
    - 6. Draft Report October 30
  7. Analysis
    - 1. Criteria Application
    - 2. Option evaluation
    - 3. GLC 2<sup>nd</sup> Peer review August 30
    - 4. AC meeting September 20
    - 5. Draft Report October 30
  8. Final Report (December)
- Guiding Principles  
Criteria Analysis

- ### Study Process
1. Resource Group data gathering & information sharing
  2. Review and Assess
  3. Option Development – based on principles, data, AC insights
  4. Re-evaluate
    - 1. New AC insight
    - 2. Additional data gathering
  5. Charrette – filter to 3 options
    - 1. GLC 1<sup>st</sup> Peer review May 9
    - 2. Full definition of 3 options
  6. AC meeting June 29
    - 1. AC meeting June 29
    - 2. Criteria Application
    - 3. Option evaluation
    - 4. GLC 2<sup>nd</sup> Peer review August 30
    - 5. AC meeting September 20
    - 6. Draft Report October 30
  7. Analysis
    - 1. Criteria Application
    - 2. Option evaluation
    - 3. GLC 2<sup>nd</sup> Peer review August 30
    - 4. AC meeting September 20
    - 5. Draft Report October 30
  8. Final Report (December)
- Guiding Principles  
Criteria Analysis

- ### Study Process
1. Resource Group data gathering & information sharing
  2. Review and Assess
  3. Option Development – based on principles, data, AC insights
  4. Re-evaluate
    - 1. New AC insight
    - 2. Additional data gathering
  5. Charrette – filter to 3 options
    - 1. GLC 1<sup>st</sup> Peer review May 9
    - 2. Full definition of 3 options
  6. AC meeting June 29
    - 1. AC meeting June 29
    - 2. Criteria Application
    - 3. Option evaluation
    - 4. GLC 2<sup>nd</sup> Peer review August 30
    - 5. AC meeting September 20
    - 6. Draft Report October 30
  7. Analysis
    - 1. Criteria Application
    - 2. Option evaluation
    - 3. GLC 2<sup>nd</sup> Peer review August 30
    - 4. AC meeting September 20
    - 5. Draft Report October 30
  8. Final Report (December)
- Guiding Principles  
Criteria Analysis

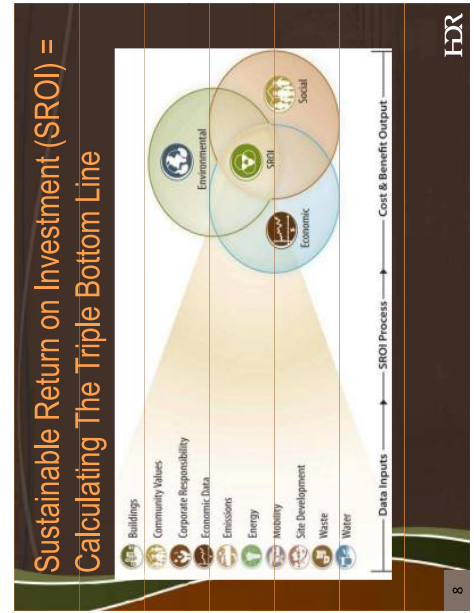
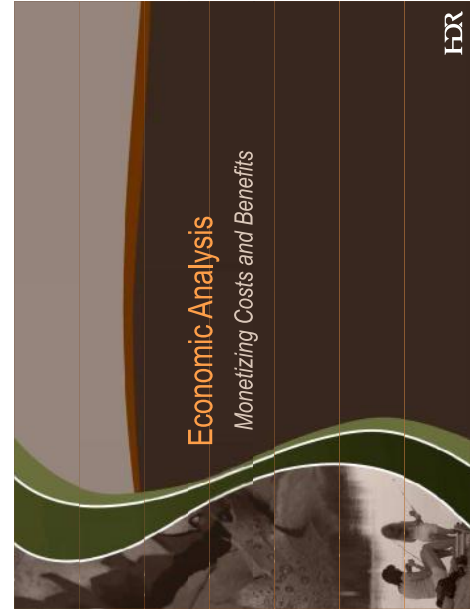

### Sample SROI Output: Net Benefits

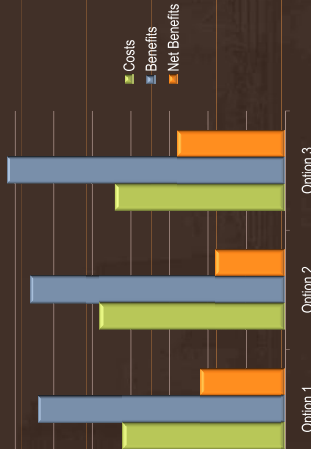

Benefits and costs will be identified and quantified by option



### Sample SROI Output: Benefits

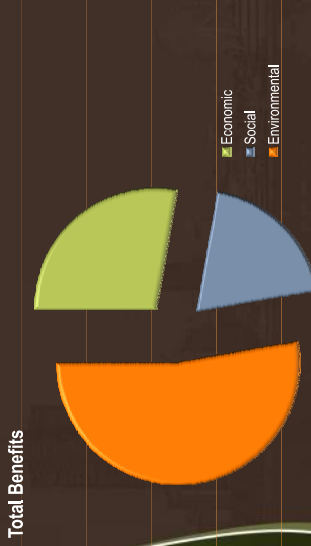

Benefits can be categorized by economic, social and environmental.



### Sample SROI Output: Benefits

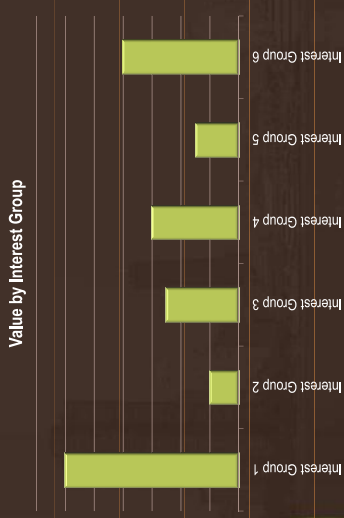

Process allows examination of potential trade-offs by interest group.



### Sample SROI Output: Total Cost

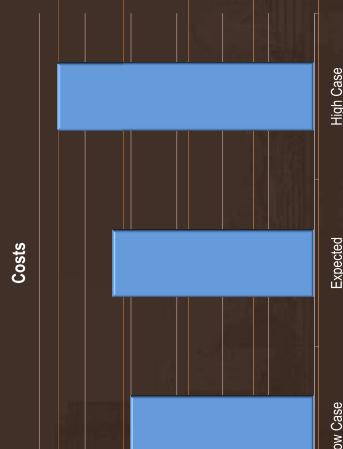

The estimates of benefits and cost reflect uncertainty.



## Ports and Intermodal Transportation



### Keys to a Successful Port & Intermodal Development Plan

- Above all be **market driven**
- Ensure the plan **meets current customer's needs**: They drive the revenue... Then pursue synergistic future industry trends & opportunities.
- **Maximize the use of existing capabilities first**: Focus on management, operations, information technology and pricing
- **Finally Invest in new facilities** only after all other practical options have been successfully pursued and explored



### North America's Inland Waterway System

(A Strategic Connection to the US Gulf Coast & St Lawrence)



### San Pedro Bay (POLA+POLB) Container Volume Forecast

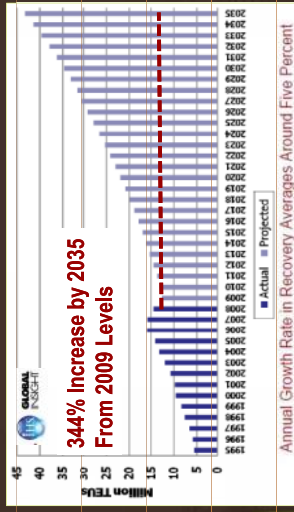

Source: HIS Global Insight 2010 Forecast



### North American Emerging Mega-Regions

(Future US Growth Areas)



Source: America 2050 Prospects, Regional Plan Association





## Panama Canal Vessel Deployments Will Determine New US Logistics Patterns



HDR

## Potential Inland Intermodal Port Logistics Centers as a Part of the AIS Separation Strategy



HDR

## Resource Group Engagement

- ✓ Alliance for the Great Lakes
  - Great Lakes Fishery Commission
  - American Waterways Operators
    - ✓ GLNPO (EPA)
    - ✓ Great Lakes Sport Fishing Council
    - CMAP
  - Illinois DNR
- ✓ Chicago Wilderness
  - ✓ Illinois EPA
  - Chicago's First Lady Cruises
  - Illinois International Port District
- ✓ Council of Great Lakes Governors
  - ✓ International Joint Commission
- ✓ Friends of Chicago River

✓ Held Meeting • Scheduled ○ Scheduling

HDR

## Inland Ports Defined A Convergence of Logistics Trends



HDR

## Resource and Interest Group Engagement

HDR

## Interest Group Engagement

- ✓ Metropolitan Planning Council
  - ✓ Reor Viridis
- ✓ MWRDGC
  - The Nature Conservancy
  - USACE, Chicago
- Midwest Generation, LLC
  - USACE, Rock Island
- NRDC
  - ✓ Ninth Coast Guard District
  - ✓ US EPA 5
- ✓ Northwest Indiana Forum
  - ✓ US Fish and Wildlife
  - Office of the Mayor (Chicago)
    - ✓ US GS
  - Ports of Indiana-Burns Harbor
    - ✓ Westrech Marina

✓ Held Meeting • Scheduled ○ Scheduling

HDR

## CAWS & CREATE Systems Overlay



HDR

## Information Collection Categories

- Transportation
- Economics
- Water Quality
- Ecology
- Stormwater

HDR

## Information Gathering Summary

- 27 of 30 interviews complete/scheduled
- Over 90 information resources identified
- Provide follow-up summary for gap identification

HDR



## Data Collection has Value Beyond Project

- Inform Additional Studies (e.g. USACE GLMRIS)
- Resource Library to GLC/CI

HDR

## Summary and Presentation

- Prepare a Final Integration Report for the GLC/CI by Dec. 15, 2011
- Prepare a Final Summary Report geared toward a more public audience
- Final Presentation to GLC/CI Dec. 20, 2011

HDR

## Final Project Documentation

*Document Preparation and Presentations*

HDR

## Deliverables and Meetings

*Schedule for Project Deliverables and Meetings*

HDR

## Deliverables Schedule



HDR

## Meeting Schedule



HDR

## Deliverables Schedule



HDR

## Closing Comments



## Envisioning a Chicago Area Waterway System for the 21<sup>st</sup> Century

### ***Criteria for Developing and Evaluating Separation Options***

#### **Introduction**

The document presents draft criteria for developing and evaluating separation options and reflects feedback received at the February 16, 2011 Project Advisory Committee meeting. It contains the project purpose, overarching goals and draft criteria. Comments and additional feedback from the Advisory Committee and Resource Group are welcome before March 25, 2008. (Instructions for providing comments are contained in the cover e-mail.)

#### **Project Purpose**

Develop and evaluate options for separating the Mississippi River watershed from the Great Lakes and St. Lawrence watershed to prevent the transfer of aquatic invasive species via the Chicago Area Waterway System (CAWS) while improving transportation, water quality and flood management, and thereby protecting both watersheds.

#### **Project Goals**

- Goal #1: Prevent the movement of aquatic invasive species between the Great Lakes and Mississippi River watersheds via the Chicago Area Waterway System.
- Goal #2: Improve the ecological health of the Chicago Area Waterway System.
- Goal #3: Improve stormwater management within the Chicago Area Waterway System.
- Goal #4: Improve transportation within, to, and from the Chicago Area Waterway System.

#### **Draft Criteria**

**Goal #1: Prevent the movement of aquatic invasive species between the Great Lakes and Mississippi River watersheds via the Chicago Area Waterway System**

[Geographic Scope: Chicago waterway drainage area in Northeast Illinois and Northwest Indiana]

#### Criteria for Goal #1:

- Impacts on the movement of aquatic invasive species between the basins in the CAWS
- Impacts on the ability to respond, control or eradicate invasions within the CAWS
- Achieving Goals 2-4 will not interfere with achieving Goal #1

**Goal #2: Improve the ecological health of the Chicago Area Waterway System**

[Geographic Scope: Chicago waterway drainage area in Northeast Illinois and Northwest Indiana]

Criteria for Goal #2:

- Impacts on compliance with Clean Water Act standards.
  - Dissolved oxygen
  - Water temperature
  - Nitrite-nitrate nitrogen
  - Total phosphorus
  - Total mercury
  - Fecal coliform/E. coli
  - Other
- Impacts on biotic factors.
  - Number and diversity of species (species richness); fish and all biota (benthic, amphibians, etc.)
  - Number of water quality tolerant species (plants and animals)
  - Number of water quality intolerant species (plants and animals)
  - Other
- Impacts on legacy materials (sediment chemistry).
  - Metals
  - Total PCBs
  - Total PAHs
  - Other
- Synergy with existing and planned water quality improvements.

**Goal #3: Improve stormwater management within the Chicago Area Waterway System**

[Geographic Scope: Chicago waterway drainage area in Northeast Illinois and Northwest Indiana]

Criteria for Goal #3:

- Impacts on flooding events.
  - Basement flooding
  - Localized flooding
  - Large scale flooding
- Synergy with existing and planned regional land use and stormwater management plans (TARP, other).

**Goal #4: Improve transportation within, to, and from the Chicago Area Waterway System.**

[Geographic Scope: Transportation network of Northeast Illinois and Northwest Indiana]

Criteria for Goal #4:

- Impacts on navigation.
  - Freight
  - Recreational boating
  - Commercial (tour boats, existing users)
  - Emergency vessels
  - Other
- Impact on transportation efficiency.
  - Cost
  - Road, rail and waterway congestion
  - Safety
  - Air quality (emissions)
  - Reliability
  - Timeliness
  - Other
- Synergy with existing and planned regional transportation plans (e.g., CREATE).

**Other General Criteria**

The project will consider several other general criteria as options for separation are developed and evaluated. These criteria will include feasibility; cost-effectiveness; sustainability and climate readiness; and timeliness. The project team recognizes that these concepts, while needing further definition, will be important to developing credible options for separation.

## **D2. AC MEETING 6-29-2011**

- MEETING AGENDA
- MEETING ATTENDEES
- MEETING MINUTES
- STUDY OVERVIEW PRESENTATION
- TRANSPORTATION PRESENTATION



# Envisioning a Chicago Area Waterway System for the 21st Century



A joint project of the Great Lakes Commission  
and the Great Lakes & St. Lawrence Cities Initiative



## Project Advisory Committee Meeting

Wednesday, June 29, 2011

*Garden Room  
Hilton Garden Inn Chicago Downtown/Magnificent Mile  
10 E. Grand Avenue, Chicago, Illinois 60611 ~ (312) 595-0000*

### MEETING AGENDA

9:00 a.m.	<b>Welcome, Introductions and Agenda Review</b>	Tim Eder, Great Lakes Commission Dave Ullrich, Great Lakes & St. Lawrence Cities Initiative
9:10 a.m.	<b>Remarks from Project Executive Committee</b>	Hon. George Heartwell, Mayor, City of Grand Rapids, Michigan Todd Main, Illinois Dept. of Natural Resources
9:30 a.m.	<b>Study Overview and Potential Separation Locations</b>	Tim Eder, Great Lakes Commission Dave Ullrich, Great Lakes & St. Lawrence Cities Initiative Scott Stuewe, HDR Engineering Paul Dierking, HDR Engineering
10:15 a.m.	<b>Questions &amp; Discussion</b>	
10:45 a.m.	<b>Break</b>	
11:00 a.m.	<b>Flooding, Water Quantity and Water Quality Aspects of Separation</b>	Paul Dierking, HDR Engineering Pete Mulvaney, Greenleaf Advisors
11:30 a.m.	<b>Questions and Discussion</b>	
12:15 p.m.	<b>Lunch</b>	
12:45 p.m.	<b>Transportation Aspects of Separation</b>	John Vickerman, Vickerman & Associates, LLC
1:15 p.m.	<b>Questions and Discussion</b>	
2:00 p.m.	<b>Break</b>	
2:15 p.m.	<b>Issues for Consideration in Defining Separation Options</b>	Paul Dierking, HDR Engineering Pete Mulvaney, Greenleaf Advisors
2:30 p.m.	<b>Discussion on Separation Options</b>	
3: 45 p.m.	<b>Wrap-up and Next Steps</b>	Tim Eder, Great Lakes Commission Dave Ullrich, Great Lakes & St. Lawrence Cities Initiative
4:00 p.m.	<b>Adjourn</b>	



## Envisioning a Chicago Area Waterways System for the 21st Century

*Attendance List for Project Advisory Committee Meeting, June 29, 2011*

Sal	First	Last	Member Organization	June 29 - AC Mtg
Mr.	Joshua	Anderson	Aide to MWRD Commissioner Debra Shore	x
LTC	David	Berczek	U.S. Army Corps of Engineers	x
Mr.	Mark	Biel	Chemical Industry Council of Illinois	x
Mr.	Gideon	Blustein	Illinois Chamber of Commerce	x
Mr.	Bill	Bolen	U.S. Environmental Protection Agency	x
Mr.	Michael	Borgstrom	Wendela Sightseeing Co. Inc.	x
Mr.	Marc	Boucher	Government of Quebec	x
Mr.	Joel	Brammeier	Alliance for the Great Lakes	x
Mr.	Dale	Bryson	Alliance for the Great Lakes	x
Mr.	Andy	Buchsbaum	Healing Our Waters–Great Lakes Coalition	x
Mr.	Clark	Bullard	Prairie Rivers Network	x
Mr.	Mark	Burrows	International Joint Commission	x
Mr.	Thom	Cmar	Natural Resources Defense Council	x
Ms.	Sue	Davis	U.S. Army Corps of Engineers	x
Mr.	John	Dettmers	Great Lakes Fishery Commission	x
Mr.	Paul	Dierking	HDR Engineering, Inc.	x
Mr.	Jim	Duncker	U.S. Geological Survey	x
Mr.	Josh	Ellis	Metropolitan Planning Council	x
Mr.	Tony	Everson	HDR Engineering, Inc.	x
Ms.	Molly	Flanagan	The Joyce Foundation	x
Ms.	Margaret	Frisbie	Friends of the Chicago River	x
Mr.	Marc	Gaden	Great Lakes Fishery Commission	x
Mr.	Duane	Gapinski	HDR Engineering, Inc.	x
Mr.	Chris	Goddard	Great Lakes Fishery Commission	x
Mr.	John	Goss	Council on Environmental Quality	x
Mr.	Greg	Gould	Natural Resources Defense Council	x
Mr.	Robert	Hirschfeld	Prairie Rivers Network	x
Ms.	Leah	Konrady	Northeast Midwest Institute	x
Mr.	Frank	Kudrna	Illinois International Port District	x
Mr.	Dick	Lanyon	Metropolitan Water Reclamation District of Greater Chicago	x
Cdre.	Richard	Lauric	Chicago Yachting Association	x
Mr.	Timothy	Loftus	Chicago Metropolitan Agency for Planning	x
Mr.	Todd	Main	Illinois Dept. of Natural Resources	x
Dr.	Phil	Moy	Great Lakes Panel on Aquatic Nuisance Species	x
Mr.	David	Murtaugh	Regional Dir., NW Indiana, U.S. Senator Dan Coats	x
Mr.	Dave	Naftzger	Council of Great Lakes Governors	x
Ms.	Jen	Nalbone	Great Lakes United	x
Ms.	Kay	Nelson	Northwest Indiana Forum	x
Mr.	Gary	O'Keefe	U.S. Army Corps of Engineers	x
Mr.	Irwin	Polls	Ecological Monitoring & Assessment	x
Dr.	Terry	Quinney	Ontario Federation of Anglers and Hunters	x
Mr.	Kevin	Rund	Illinois Farm Bureau	x
Mr.	Joe	Schuessler	Metropolitan Water Reclamation District of Greater Chicago	x
Ms.	Laura	Seaman	Council of Great Lakes Governors	x
Ms.	Leslie	Shad	National Wildlife Federation	x
Mr.	Ed	Staudacher	Metropolitan Water Reclamation District of Greater Chicago	x
Mr.	Scott	Stuewe	HDR Engineering, Inc.	x
Ms.	Rachel	Sudimack	Illinois Dept. of Natural Resources	x
Mayor	Debbie	Sutherland	Northeast Ohio Mayors & City Managers Assoc.	x
Mr.	Jared	Teutsch	Alliance for the Great Lakes	x
Mr.	Dave	Ullrich	Great Lakes & St. Lawrence Cities Initiative	x
Mr.	Rick	Unger	Lake Erie Charter Boat Association	x
Mr.	John	Vickerman	Vickerman & Associates, LLC	x

## Envisioning a Chicago Area Waterways System for the 21st Century

*Attendance List for Project Advisory Committee Meeting, June 29, 2011*

Mr.	Dave	Wethington	U.S. Army Corps of Engineers	x
Ms	Lynn	Muench	American Waterways Operators	x
Mr.	David	Reese	Metropolitan Water Reclamation District of Greater Chicago	x
Mr.	Simon	Belisle	Great Lakes & St. Lawrence Cities Initiative	x
Mr.	Lindsay	Chadderton	The Nature Conservancy	x
Mr.	Marc	Smith	National Wildlife Federation	x
Mr.	Toby	Frevert	HDR Engineering, Inc.	x
Mr.	Doug	Yeskis	U.S. Geological Survey	x
Mr.	Matt	Doss	Great Lakes Commission	x
Mr.	Tim	Eder	Great Lakes Commission	x
Ms.	Pam	Kaput	Great Lakes & St. Lawrence Cities Initiative	x
Mr.	Jim	Ridgway	ECT, Inc.	x
Mr.	John	Andersen	Greenleaf Advisors, LCC	
Mr.	Bob	Beduhn	HDR Engineering, Inc.	
Mr.	David	Bennett	Metropolitan Mayors Caucus	
Mr.	Dennis	Bruce	HDR Engineering, Inc.	
Mr.	Matt	Cochran	HDR Engineering, Inc.	
Mr.	Jack	Darin	Sierra Club - Illinois Chapter	
Mr.	Kevin	Fitzpatrick	Metropolitan Water Reclamation District of Greater Chicago	
Ms.	Lisa	Frede	Chemical Industry Council of Illinois	
Mayor	George	Heartwell	City of Grand Rapids	
Mr.	Howard	Learner	Environmental Law and Policy Center	
Mr.	Peter	Mulvaney	Greenleaf Advisors, LCC	
Ms.	Janice	Reid	HDR Engineering, Inc.	
Mr.	John	Rogner	Illinois Dept. of Natural Resources	
Mr.	Don	Schaefer	Mid-West Truckers Association	
Mr.	David	St. Pierre	Metropolitan Water Reclamation District of Greater Chicago	
Ms.	Evelyn	Strader	Council of Great Lakes Industries	
Mr.	Dan	Thomas	Great Lakes Sport Fishing Council	
Ms.	Jumana	Vasi	C.S. Mott Foundation	
Mr.	Delbert	Wilkins	Canal Terminal Company	

- RSVP'd but did not sign the sign-in sheet

# Envisioning a Chicago Area Waterway System for the 21st Century

---



A joint project of the Great Lakes Commission  
and the Great Lakes & St. Lawrence Cities Initiative



## **Project Advisory Committee Meeting**

**Wednesday, June 29, 2011**

*Garden Room*

*Hilton Garden Inn Chicago Downtown/Magnificent Mile  
10 E. Grand Avenue, Chicago, Illinois 60611 ~ (312) 595-0000*

## **MEETING NOTES**

### **Welcome, Introductions and Agenda Review**

Dave and Tim do welcome and review project status. Halfway through; at point where we need to give guidance to our consultants on the three options to be analyzed.

### **Remarks from Project Executive Committee**

Mayor Heartwell: Function of the sacred is to infuse hope into the present. Give hope to people that we can change the world for the better. If I can convince my 10 year old grandson that he will be able to catch a 14 inch native brown trout with his grandson, I am engaged in the work of the sacred. What we are doing at its heart, at its essence, is about the sacred.

John Rogner: We have an opportunity to re-imagine our own backdoor – the ecological and environmental health of our inland waterway system.

Dave Ullrich: Project is all about getting to a better solution, quicker. We don't have the luxury of time.

### **Study Overview and Potential Separation Locations**

Scott review project objective and goals.

See data gaps that Scott mentions in presentation.

Paul: Challenges – stormwater management; ecological health; transportation.

Reviews process of coming up with potential barrier locations, and key data.

Discussion:

- Can we learn from the temporary separation on the Grand Cal where the river is blocked off for the sediment cleanup project? Bill Bolen says they can find out from the Legacy Act staff.
- Andy: which locations would not be significant barriers during flood events, and which would? With most locations you could address flooding events with mitigation. Which locations would require less mitigation. The closer you get to the lake, the more significant flood control concerns are. With barriers farther into the system, on the south branch, flood concerns would be less since you would have outlets at

Chicago and at Wilmette. In the south CAWS, main concern re. flooding is on the Little Calumet. Jim R. notes that TARP, when completed, will have a significant impact on flood control and mitigation.

- Generally, the closer the barriers are to the lake, the greater the flood control concerns; the farther the barriers are from the lake, the less the flood control concerns and the greater the water quality concerns to the lake.
- Dave N: Is it realistic to think it will be possible to have no spills with significant wet weather events? You could design barriers to certain rain events, but with catastrophic events, you might not design to this level and there would always be the potential for spilling or over-topping. You could accommodate larger rain events as you incorporate more mitigation and TARP is implemented. Dave N: we should be candid that we will get varying levels of protection, but probably not 100% certainty and protection.
- What is your scope of study? Just the CAWS. How do you incorporate impacts on transportation outside of the CAWS? John V. will address this.
- Frank Kadrna: Given the number of people who get drinking water from the lake, is it realistic to expect that we could get approval to discharge wastewater to the lake? Not a regulator, but notes that other cities on the lakes discharge to the lake and take drinking water from the lake, so it can be done.
- Is it feasible to consider other outlets for treatment plants? Yes, you can consider this as part of a mitigation strategy? We looked at this, such as building a pipeline to move the outlet.
- Jen N. What are the various timelines that we're looking at – TARP, EPA-mandated treatment upgrades, carp movement, GL Initiative, etc? How do these affect the timeline of separation and feasibility of options? Yes, are many rules and regs that would have to change if you change how the system operates. Kay Nelson mentions GL Initiative and anti-degradation regs, permits, approval of other states, etc.
- Tom Cmar, can you discuss role of green infrastructure and role as mitigation option and potential effectiveness? GI has utility for first flush capture for smaller rain events, but studies show that applying that at a large scale and large flood events it has less of an impact.
- Dick Lanyon: Some pollutants in wastewater are not currently regulated, but could be in the future, so this could be a "game changer" in the future.
- Josh Ellis: need to discuss what you're putting into the baseline.
- Andy B: are there places that become unviable if carp move into certain locations? Paul discusses fencing to separation the DesPlaines and S&S canal. Corps reviews 13 mile of barriers between Desplaines River and S&S canal. Build to 100 year flood event plus three years. Will stop adult carp, but not eggs and larvae.
- Consider over 100 years when combined sewers will become separated sewers. Will this increase capacity in the TARP? TARP is designed to capture CSOs, so there's not a lot of current plans to separate combined sewers, but if they were separated this would create storage in TARP (but not in the CAWS itself).
- What is timeline for TARP completion; could this be accelerated? Quarry excavation is driving factor.
- Is the AIS risk higher if the barriers are closer to the lake vs. farther away? Yes (clarify this – didn't fully capture the response).
- Clarification from Kay Nelson: Clarifies that the GL initiative does NOT prohibit new discharges to the GL; but it does have a high bar that you must meet to get approval for this.
- Dave U. notes that there are many collateral considerations associated with separation options, with varying degrees of difficulty and complications.
- Tim responds to Q about public availability of our information: we request and appreciate your not divulging this info to the media or the general public. We have avoided releasing information to the media.

### **Flooding, Water Quantity and Water Quality Aspects of Separation**

- Discusses six key points about flooding and water quality issues/concerns.
- Re. CSOs, concerned about using current EPA guidance on allowable number of CSO events vs. full compliance with the CWA (zero CSO events).
- Concern about turnover of water in southern Lake Michigan and potential accumulation of loadings from treatment plants. Haven't looked into this pending where barrier locations will be.
- Frank K: Costs for capital cost for improving local conveyance: rough benchmark is \$3 B looking at comparable TARP costs.

- Concern about emphasis on building more storage vs. separating current combined systems. Response: We're not necessarily recommending this. Regardless of separation, you will still have a given volume of water to convey.
- Andy B: Have you looked at standards and timetable that EPA has set for discharges to CAWS and compared them to standards for Great Lakes discharges? We haven't done the analysis yet, but are aware of the issues and will look at them. What is the timeline for complying with EPA standards and requirements? This affects the baseline conditions – what WWTPs have to do anyway and by when. Important to get a handle on this.
- Water quality issues on the horizon – nutrient loadings, disinfection, etc.
- Could WWTP be put in TARP system to mitigate loadings to Lake MI. Interesting idea.
- Joel: How detailed will your analysis go re. upgrading conveyance in specific communities? Do you have the scope to do that? Response: unsure about scope, but process is underway in Chicago to examine flood risks with and without TARP and conveyance improvements. Cites City of Chicago reports and models. I don't think we'll be able to get to a level of detail that determines specific, project or community level conveyance needs that will be required to reduce CSOs.
- Josh: (look at Pam's notes).
- Jen N. Q. about storage gains in south CAWS by 2015 as TARP comes online. System is different and conveyance issues aren't as severe in the south CAWS – so CSOs are expected to be below EPA guidance.
- Dan I: All water brought in improves water quality – not just that which is brought in for discretionary flow.
- Tom Cmar: Talk more about green infrastructure. He has heard greater impacts on stormwater from green infrastructure. Response: varying numbers depending on storm event. We are looking at a major storm event that would overtop barriers. As storm event increases, the amount that green infrastructure can capture decreases. Also, green infrastructure is a passive approach – it captures the first part of the storm, but not the peak of the storm. At that point, your green infrastructure is already saturated and can't hold more water. So, therefore, not very effective for large storm events. Can be useful for pollutants in first flush of storm event. Put this issue in the parking lot.
- Frank K: Are you assessing risk of AIS transfer during even less frequent spills during large wet weather events? Yes, we'll look at this.
- Margaret F: Will you be looking at timing of various improvements and possibility that some things may need to happen sooner in conjunction with implementation of separation? Response: We'll discuss this in the context of options definition.

### **Transportation Aspects of Separation**

- Does Westec new proposed marina include both summer and winter storage? Response: I believe, yes.
- What do you do about large vessels that go from the GL to the MS river system? We believe we could have the crane capability and AIS decontamination ability to accommodate these larger vessels. Richard Lauric expresses concerns about liability for moving large boats. Vickerman: We don't have all the answers and need to work with you to find solutions.
- Joel B: Question about downward trend in traffic through the O'Brien lock – have you done a regression analysis of this trend? No, but we are talking with local businesses and others. Are you looking at trends in development of marinas on Lake MI? Response: We're using publically available information.
- Lynn M: How are you capturing through products? Response: We're using Corps data and publically available data. We have poor or unavailable origin-destination data on through product movement. Notes that NRDC is exploring this with another consultant. This information is proprietary information that businesses don't want to divulge. Notes that he's looking for opportunity to work collaboratively to collect data. We need help with this. Thinks that the Corps-GLMRIS study will have trouble collecting this data. Lynn questions whether the data to be collected by the Corps will answer this question. John V. suggests collaboration with NRDC, Corps, American Waterway Operators and others to develop confidentiality agreement to collect data. Lynn asks about what you do about privately owned property and businesses. Concern about how to make room for barge movement and loading and unloading and associated equipment. Also concern about how to move passenger vessels. Response: there are solutions that can be pursued, but it won't solve everyone's problems and issues. Next phase of our work is in-depth analysis of issues that have been raised in context of specific options.

- Dave U: Is there some way to get information on barge traffic that is perhaps somewhat less than the detailed origin-destination information. For example, can we find out how many barges actually go into the lake.
- Frank K: when talking about disinfection of rec boats, are you talking about surface cleansing or bilge water. Response: talking about surface disinfection.
- Andy B: Are there things you could do to enhance commercial navigation? Even without separation, you could do things to take advantage of increased traffic up the MS River with growing traffic through the Panama Canal.
- Molly F: Have you assessed the seasonality of the system and whether rail infrastructure needs to be upgraded? Response: seasonality is a concern, but there is a multi-modal capability that can overcome this. Suggests partnership between inland waterway system and rail operators. What's your vision for rail and would there need to be an investment in rail? Response: Main investment would be an intermodal facility.
- Would it help avoid impacts to existing businesses if you moved the barrier downstream? Concern about lack of data and setting up large growth in commercial movements in the future as the base case and then comparing impacts of alternative barrier locations against this. Seems to be concerned that this puts interests of rec boaters at a disadvantage if they are pitted against an overly optimistic future scenario for growth in commercial navigation.
- Kay Nelson: Questions whether she could get additional origin-destination data when the scenario still will require significant infrastructure improvements. Response: I am now going to include analysis of impacts on neighboring states.
- Have you looked at barge-to-barge opportunities in other areas of the system? We have looked at this?
- Are there proven technologies for disinfection of boats? Are you looking at potential problems with bridges? At site 20 we looked a different configurations, some that would require lifting bridges and some that wouldn't. Re. disinfection of boats, there are technologies, but it will be difficult. Will also have to be an education component on AIS prevention and control. You can't achieve 100% treatment, so public education will be key.
- Lyndsey C: How much goods are being moved through Chicago harbor? They say that, if separation was put on the Calumet River, it would cut off 70-80% of the port's commercial traffic. Kay notes that Grand and Little Cal are non-navigable.
- There are a number of reasons to project growth in waterborne commercial navigation.
- Joel B: Sees a need for a better definition of the baseline condition. Also, would be useful to know which rec boat lockages are for rec activities vs. seasonal storage. Richard Lauric suggested that 8000 of the 25,000 lockages on the O'Brien are for storage.
- Josh Ellis: Thinks it would be good to look at other barrier locations besides option 20. We need to understand issues associated with other barrier locations.

### **Issues for Consideration in Defining Separation Options**

Pete's presentation:

- Baseline: relevant factors to include

[ See slide ]

Option definition – grouping of barriers into ensembles and then include other considerations, such as mitigation strategies. Barrier characteristics (timing, spillway, scale, etc.) to be attached to each barrier location; plus mitigation choices (habitat, floodplain, port, etc.). With all this (location, character, and mitigation) will give us our options. With this, we can do our full analysis. We want to define as well as possible our option.

Discussion sequencing as a barrier characteristic – barrier before mitigation, which reduces AIS risk sooner but increases flooding risk in the near term before mitigation is implemented. In contrast, you could build the barrier after mitigation, which minimizes flooding risk in the near term but maintains or increases AIS risk.

- Joel: Ask for explanation of why 2029 date is important re. completion of TARP. Dick explains that mining of rock on the McCook Reservoir is a huge undertaking that will take time to complete. It's being mined at the rate at which it can be absorbed into the market.
- Frank: I don't think you can make a call between increased flood risk vs. AIS risk without more specifics on what this will entail, it's implications. Response: will be different degrees of risk of flooding for each location.
- Andy B: You could also show flood risk and water quality risk. Seems to be a tradeoff with these two. Will you be mapping these parameters together? Eventually, needs to be some decision that we'll be leaving some level of risks and costs on the table regardless of which option we identify. Also, what are the definition of enhancements that can go beyond mitigation, and will you consider this? Response: Some of the benefits and risks will come out in the analysis. Andy notes that research shows that the GL are very sensitive to nutrients. How do you cost this out? There's a value judgment on how much additional nutrients to Lake MI is acceptable. You can't cost this out. Response: I agree – we need your input on where we place our values so we can appropriately evaluate options.
- Kay expresses concerns about getting consensus from the AC on an option that can be implemented by 2017. Doesn't think this is realistic. Tim responds that we aren't looking for consensus, but guidance on how to define the options and balance risks.
- Rick Unger: It's a huge leap of faith that the carp won't move and doesn't think the electrical barrier will stop them. Our mission #1 is to stop carp and the sooner we move the better.
- Jen N: Has MWRD considered ways to expedite completion of TARP, such as subsidizing the sale of rocks. Dick responds with problems with expediting quarrying of rock. ISSUE: We want to explore ways to accelerate pace of implementation of TARP.
- Suggestions: have consultants identify 3-4 locations for separation, quantify impacts, and then come back to AC to discuss 3-4 tangible visions and then narrow it down to the final options. Also, suggests putting barriers at or near treatment plants, so discharge can be easily switched to respond to unanticipated developments. Response: sees value in building redundancy and flexibility into the options process?
- Is there any ability to build new TARP tunnels and could we build interim barriers that would remove most AIS to get us through the interim period. Response: Yes, we have considered new TARP tunnels. Regarding interim, less than 100% effective barriers, we have taken this off the table because we want a fully impervious barrier.
- Seems that the economic, c/b analysis should be used to narrow the options down to the final three, rather than selecting three and then doing the economic, c/b analysis.
- Dave Bennett: Need to look at issue through politics of it. References TARP process; many politicians have vested interest in TARP. Believes that any option that increases flooding will NOT be politically feasible. Thus, mitigation should come first, and then separation.
- Joel: a few vexing questions are coming to the surface – large new flows of treated effluent going to Lake MI. So make sure one of the options includes this. Another one is the interruption of good going through O'Brien to Lake MI – include this in one of the options. Make sure the options highlight the key, vexing issues so these are fully evaluated.
- Jack D: Need a timeline that solves all the difficult problems together.
- Josh Ellis: Conceptual model is good – look for options that have tradeoffs on spikes in risks in different areas. It should not be this studies' responsibility to take on accelerating the completion of TARP. We should get bogged down with this, which is the responsibility of other stakeholders.

Tim asks to focus on two ensembles on the upper CAWS, with different implications on flooding vs. water quality impacts to Lake MI. One option is 18 and 19; and 4/5.

Pete shows 18-19 ensemble. Walk through the pros and cons.

4/5 – concerns from MWRD about conveyance capacity river side of barrier to accommodate flow from Racine pump station and Stickney.

Some question the conveyance capacities that they show.

Andy suggests taking discharge from Northside Plant and sending them via a tunnel to the Desplaines River.



Tim suggests two basic choices: 18-19, which would minimize water quality impacts to Lake MI, but increase flooding risk and transportation impacts; and 4/5 – which decreases flooding risks because of two outlets to lake, but increases water quality impacts to Lake MI, since you have WWTP discharge to the lake. Less transportation impacts.

Dave shifts to Grand Cal and Little Cal: less concern about water quality and transportation in this area, but more concern about flooding. Asks if there are any specific concerns about locations? Paul mentions the Corps flood control project and positioning barrier in collaboration with this. More flexibility on Grand Cal since flood control isn't a major concern. Probably look for the natural drainage divide. Kay notes that Hammond WWTP isn't designed to meet GL standards. If Hammond goes west, you'll have flooding issues; if it goes east it will have to upgrade to meet Lake standards.

Dick L talks about the need to maintain required depths in channels and address times when lake levels are lowers.

Dave N: Use same format in scoring baseline as we do for the options to use it as a comparative tool.

Lynn M: Talks about options for improvements in the system that have been explored that we should be mindful of.

Joel: Doesn't think any option that might include overland flooding is politically feasible.

Josh: What is the level of risk we're willing to accept and how much will it cost?

Dave N. talks about adjusting our tolerance of risks in different areas – AIS risk vs. flooding risk vs. water quality impacts to Lake MI.

Tim talks about interim barrier with spillway to use during interim period while mitigation is implemented.

Joel: Wants to be clear about timeline for implementation.

Seems to be consensus that increased flood risk is not politically acceptable.

For options, start with outcomes first, and then look for location. Look at ensemble options and work backwards.

Lynn: Concern about risks of AIS from other vectors. We can't get to zero risk, so what are we trying to do. We should be clear about our scope and what we are NOT going to resolve (other AIS vectors).

There were requests that the AC be informed about schedule for public meetings and consider the AC's involvement. Joel suggests that public information materials be vetted with AC for feedback.

Josh suggests additional public meetings in Chicago, NW Indiana.

## **Discussion on Separation Options**

## **Wrap-up and Next Steps**



## Envisioning a Chicago Area Waterway System for the 21st Century

Advisory Committee Meeting - Overview

June 29, 2011

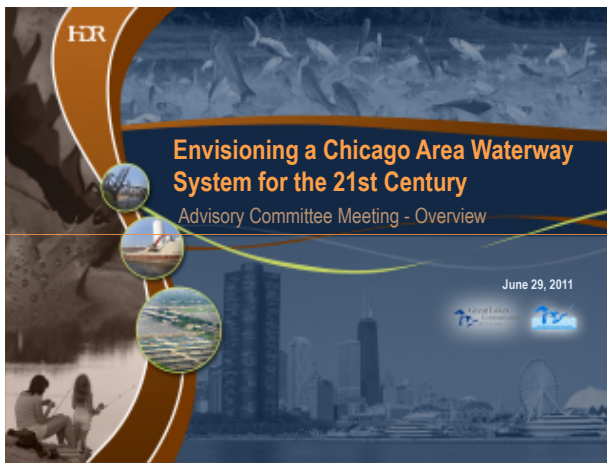

## What is the Separation Study?

Purpose: Develop and evaluate options for separating the Great Lakes and Mississippi River watersheds.



## Project Goals

- Prevent the transfer of aquatic invasive species via the Chicago Area Waterway System (CAWS)
- Improve ecological health
- Improve stormwater management
- Improve transportation (i.e., movement of goods, materials and people)



## Study Objectives

- Establish baseline conditions
- Provide at least three options for physical separation
- Estimate economic cost and benefits
- Provide summarized document



## Study Process

1. Resource Group data gathering & information sharing
2. Review and Assess
3. **Option Development**
4. **Charrette – to evaluate options**
5. **Peer Review**
6. **Full definition of 3 options**
7. **Analysis**
8. Final Report (December)



## Information and Data Gaps

- Transportation
  - Intra-system movement of cargo – CAWS and Great Lakes/St. Lawrence
  - Origin/Destination of cargo



## What are the challenges of the study?

- Stormwater Management
- Ecological Health
- Transportation



## Stormwater Management

- Flooding
- CSOs
- Water Quality

## Ecological Health

- Ecological Habitat
- CSOs
- Contaminated Sediment
- Water Quality Standards



## Transportation Challenges

- Waterway Traffic
  - Commercial
  - Industrial
  - Recreational
- Influence on other modes



HDR

## Barrier Location Evaluation

### General Process

1. Bracket above and Below Key Inflows
  2. Evaluate Impacts
  3. Consider Mitigation Implications
- No "spill" is ultimate goal → Interim goal is to limit "spill" to match existing flood risks

### Key Data

- Identify Inflows
  - Upper North Branch
  - Treatment plants
  - Pump Stations
  - Gravity CSOs
- Identify Outflows
  - Lockport
  - Wilmette
  - Chicago
  - O'Brien

HDR



HDR



HDR

## What are the Potential Separation Locations?

Focused on key infrastructure and geographic locations



HDR

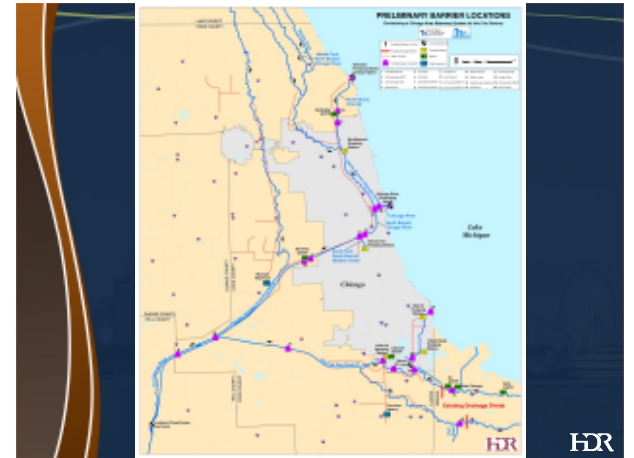

HDR

## Questions and Discussion



HDR

**Envisioning a Chicago Area Waterway System for the 21st Century**  
Advisory Committee Meeting – Flooding/Water Quantity  
June 29, 2011

## Overview

- Standard of Care
- CAWS Water Management
  - Types of Floods
  - Flood Management
- Flooding & AIS Risk

HDR



## Standard of Care

- Risk Tolerance
- Economic Cost/Benefit
- Regulatory Compliance

HDR

## CAWS Water Management

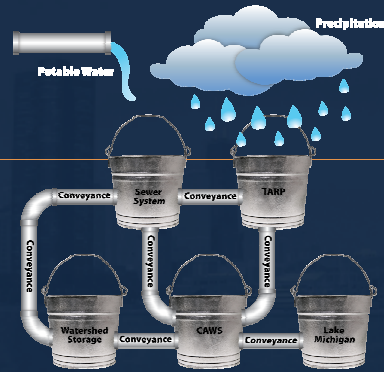

HDR

## Types of Floods

- Water in Basement/Street
- Lack of conveyance capacity
- Influenced by river/lake elevation
- Impacts lakeside/riverside of barrier
- Overbank Flooding
- River inflows exceed the outlet capacity

HDR

## Overbank Floodwater Composition

- Origin
  - Dominated by CSOs - mixed untreated storm and sanitary water
- Destination
  - Mississippi River Basin (Lockport)
  - Lake Michigan

HDR

## Flood Management

- Inflow Reduction
- Conveyance Capacity
- Storage Capacity

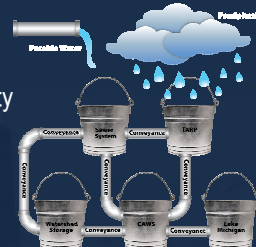

HDR

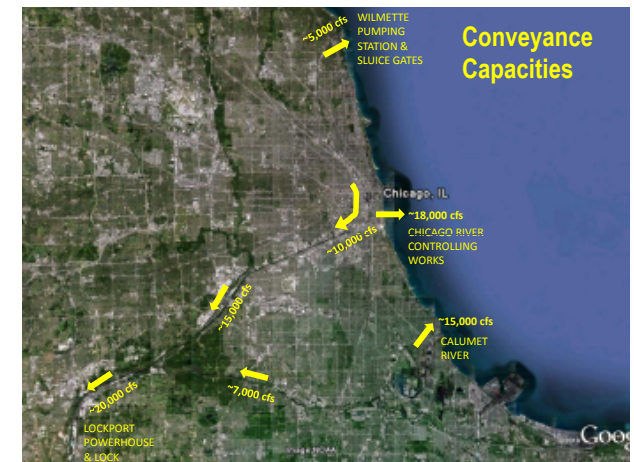

## TARP CSO Storage Volume Timeline



Slide from MWRD, May 2010 M&O Lecture Series

HDR

## Overbank Flood Risk & AIS Risk

- Barriers have risks of over flow
- AIS risk biased by location
  - To Lake
  - To Mississippi
- River bank is general barrier height limitation

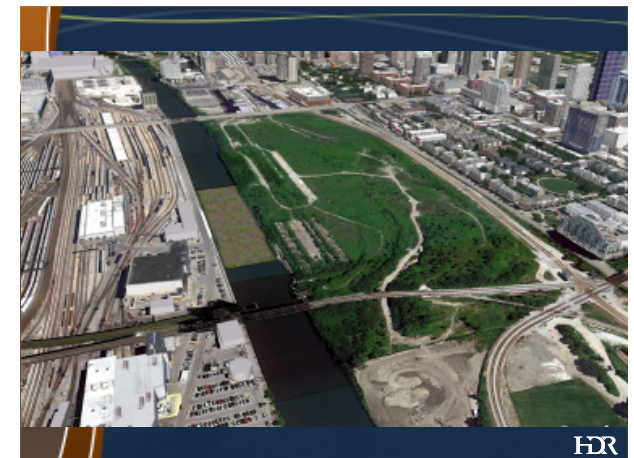

HDR



HDR



## Questions and Discussion

## Envisioning a Chicago Area Waterway System for the 21st Century

Advisory Committee Meeting – Water Quality

June 29, 2011



### Water Quality – Dry Weather

- Lose Discretionary Flow from Lake
  - Create stagnant water at barrier
- WWTP Discharge
  - Potentially shifts to lake
  - Permit process determines loading
- Sediment Pollution Movement
  - Suspension
  - Solubility

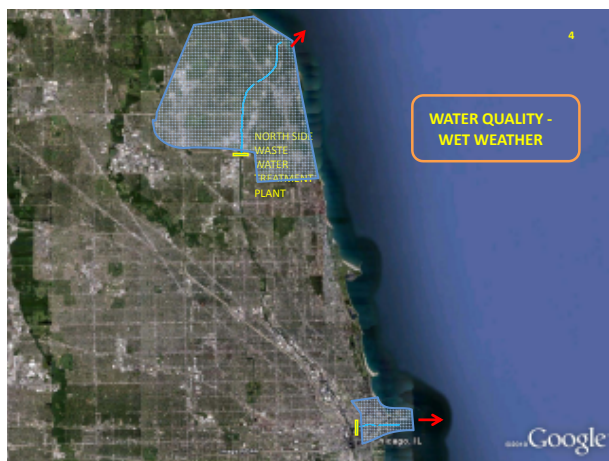
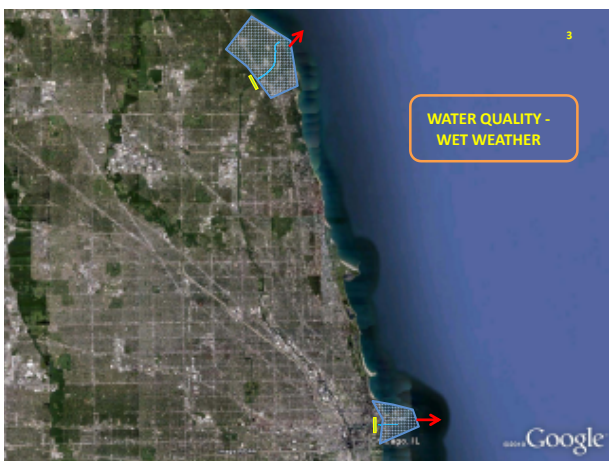

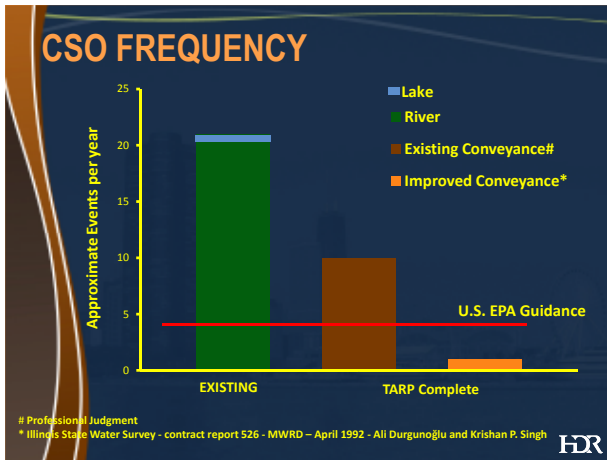
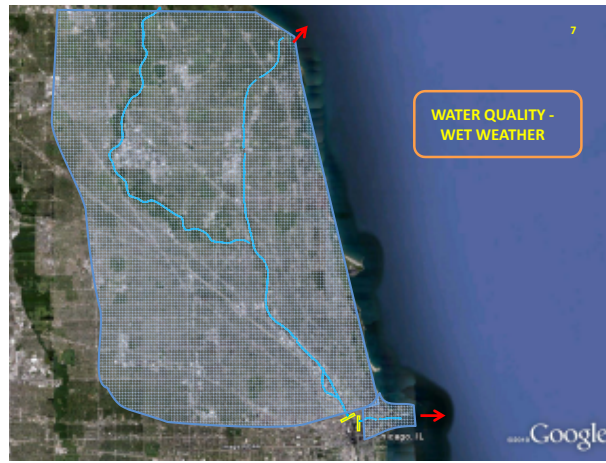

- ### Why Do We Care about CSOs?
- Flooding
  - Human Health
    - Risk of exposure
  - Ecological Health
  - Commerce impacts
    - Treatment - industrial / commercial / potable
    - Recreational
    - Tourism
    - Property
  - Utility regulations

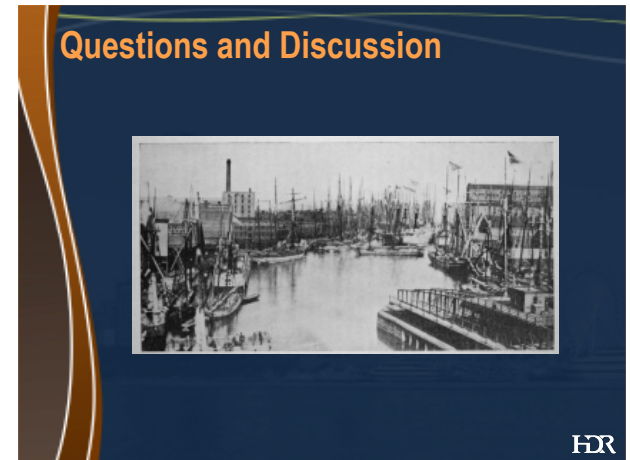

## Envisioning a Chicago Area Waterway System for the 21st Century

Advisory Committee Meeting - Option Definition

June 29, 2011

- ### Option Definition
- Economics on THREE "Options" compared to baseline
- Baseline  
Relevant factors to be included must be:
1. Existing Conditions
  2. Programmed and authorized improvements
- Option  
Ensemble of Barrier Locations with:
1. Defined mitigation strategy and
  2. Defined barrier characteristics
  3. Sequencing of implementation

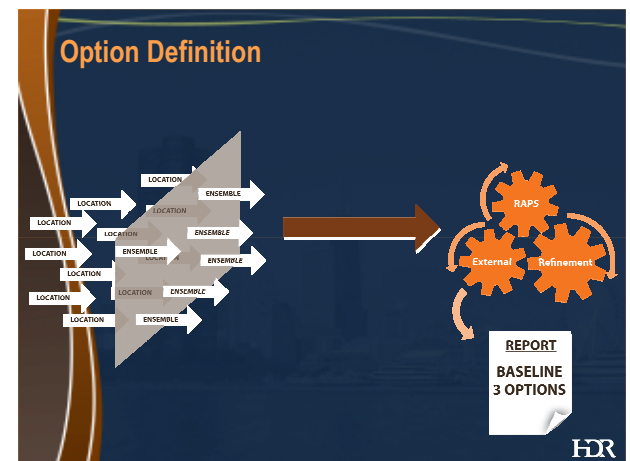

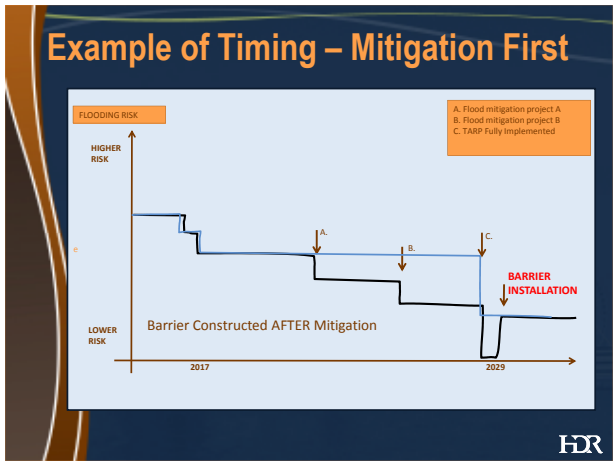
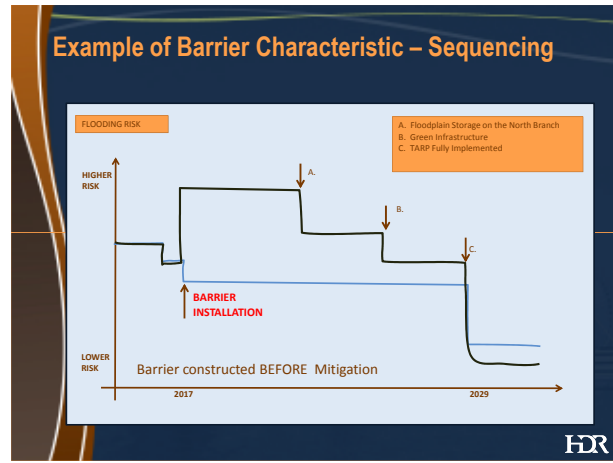
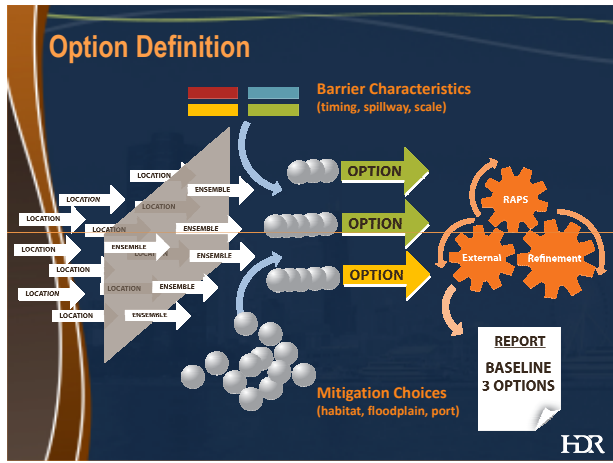
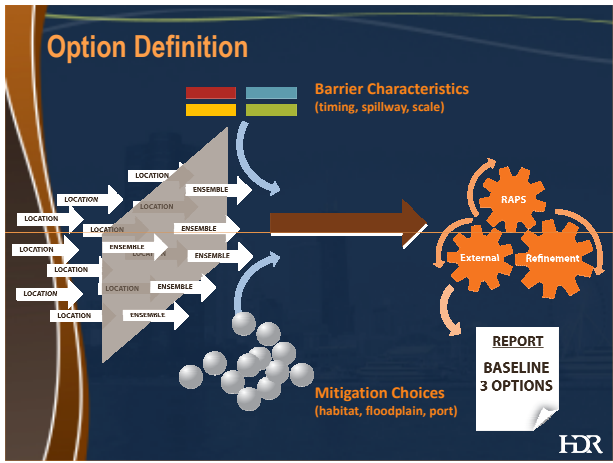

### Envisioning a Chicago Area Waterway System for the 21st Century

Advisory Committee Meeting – Barrier Comparisons

June 29, 2011

HDR

### Example Application – #9 (Upstream of Lockport)

	Opportunities	Challenges
Eco Health/ Water Quality	<ul style="list-style-type: none"> <li>Maximum elimination of diversions</li> <li>Water management policy</li> <li>Increase in local responsibility</li> <li>Habitat Creation</li> </ul>	<ul style="list-style-type: none"> <li>WWTP and CSO loadings to lake</li> <li>Impacts downstream water users</li> <li>Increase in local responsibility</li> <li>Stagnation/source water</li> </ul>
Transportation	<ul style="list-style-type: none"> <li>Geographical shift in transportation operations</li> <li>Open access between CAWS/Lake</li> </ul>	<ul style="list-style-type: none"> <li>Geographical shift in transportation operations</li> <li>Lose access to Mississippi</li> </ul>
Stormwater	<ul style="list-style-type: none"> <li>Gain Lake Outlets</li> </ul>	<ul style="list-style-type: none"> <li>Lose outlet to Mississippi</li> <li>CAWS elevation controlled by Lake elevation</li> </ul>

HDR

### Example Application – #15 (Calumet River at Lake)

	Opportunities	Challenges
Eco Health/ Water Quality	<ul style="list-style-type: none"> <li>Reduces lake pollutant exposure (returns no water to Lake)</li> </ul>	<ul style="list-style-type: none"> <li>Increases pollutant exposure to CAWS</li> <li>Stagnation/source water</li> </ul>
Transportation	<ul style="list-style-type: none"> <li>Barge traffic moves within CAWS</li> <li>Barge traffic moves between Mississippi and Calumet</li> <li>Separating Lakers from recreational boats</li> </ul>	<ul style="list-style-type: none"> <li>Laker traffic kept from deep draft water</li> <li>Barge traffic blocked from Lake</li> <li>Blocking recreational boat access to Lake</li> </ul>
Stormwater	<ul style="list-style-type: none"> <li>Access to storage in Calumet channel</li> </ul>	<ul style="list-style-type: none"> <li>Lose outlet to Lake</li> </ul>

HDR

### Example Application - #4/5 (South Branch Chicago River)

	Opportunities	Challenges
Eco Health/ Water Quality	<ul style="list-style-type: none"> <li>Reduces diversions from Lake</li> <li>Water management policy</li> <li>Increase in local responsibility</li> </ul>	<ul style="list-style-type: none"> <li>WWTP and CSO loadings to lake</li> <li>Moderate impact to downstream water users</li> <li>Increase in local responsibility</li> <li>Stagnation/source water</li> </ul>
Transportation	<ul style="list-style-type: none"> <li>Most activity maintained</li> </ul>	<ul style="list-style-type: none"> <li>Limits movement to/from Mississippi</li> </ul>
Stormwater	<ul style="list-style-type: none"> <li>Gain Lake outlets and maintain Mississippi outlet</li> </ul>	<ul style="list-style-type: none"> <li>CAWS elevation controlled by Lake elevation</li> </ul>

HDR

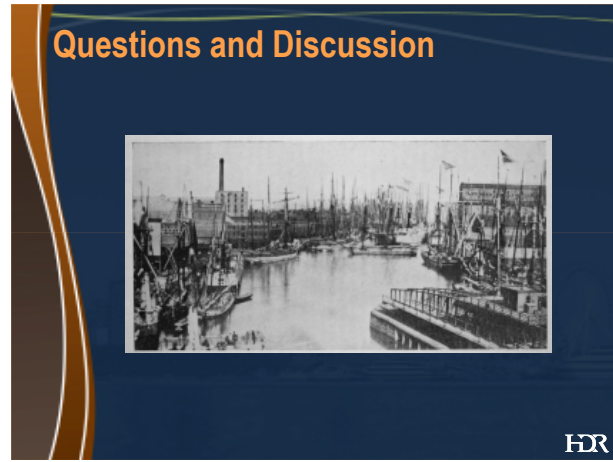



**Advisory Committee & Resource Group Meeting**  
 Hilton Garden Inn, Downtown Chicago  
 June 29, 2011

**CAWS Inland Waterway Transportation Calumet Area Planning Concepts**

VICKERMAN CONSULTANTS

Development of Separation Options

**CAWS Transport System Overview & Potential Agenda**

- ✓ CAWS System Current Conditions
- ✓ Container On Barge (COB) Potential
- ✓ Emerging Cargo Trends
- ✓ Terminal Market Approach
- ✓ Lake Calumet Site Port Development Scenarios (5 layouts)
  - Scenario A
  - Scenario B (East and West Configurations)
  - Scenario C (With & Without Vessel Turning Basin)

**Advisory Committee & Resource Group Meeting**  
 June 29, 2011

**CAWS Inland Waterway Transportation Current Conditions**

VICKERMAN CONSULTANTS

Development of Separation Options

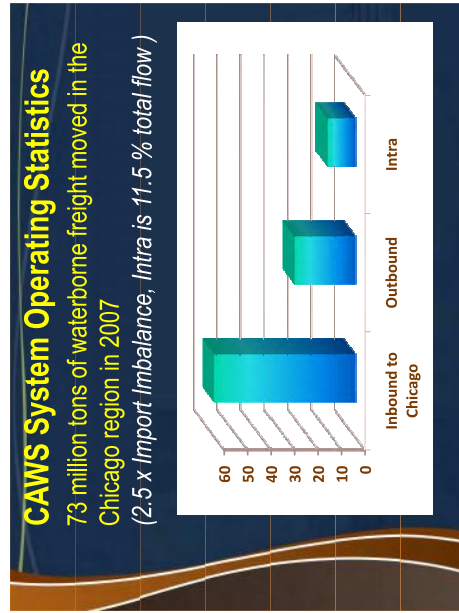
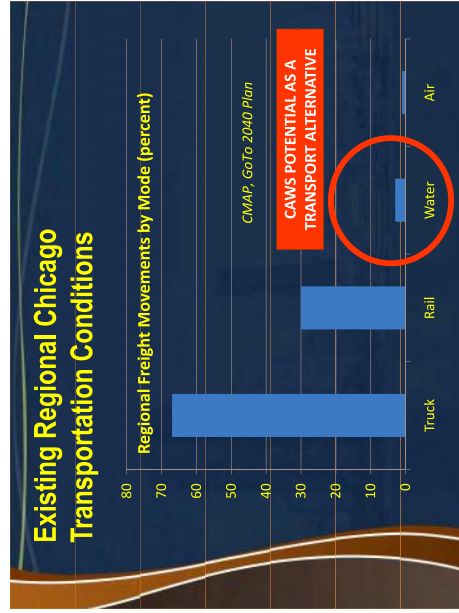

**2009 CAWS Commodity Traffic Flows**

Sections Included: Chicago Harbor, Chicago River, Chicago Sanitary and Ship Canal, Calumet-Sag Channel and Lake Calumet, IL, Calumet Harbor and River, IL and IN.

2009	All Traffic Types (Domestic & Foreign)		
	All Traffic Discharge	Receipts	Shipment
All Commodities	100%	45%	33%
Total Crude Materials, Inedible Except Fuels	36%	68%	16%
Total Coal, Lignite and Coal Coke	25%	1%	48%
Total Petroleum and Petroleum Products	18%	36%	52%
Total Primary Manufactured Goods	12%	75%	22%
Total Chemicals and Related Products	7%	73%	23%
Total Food and Farm Products	2%	17%	83%
Total All Manufactured Equipment, Machinery	0%	98%	2%
Total all Traffic	100%	21%	100%
		16%	100%
		51%	100%
		13%	100%
		3%	100%
		4%	100%
		0%	100%
		0%	100%

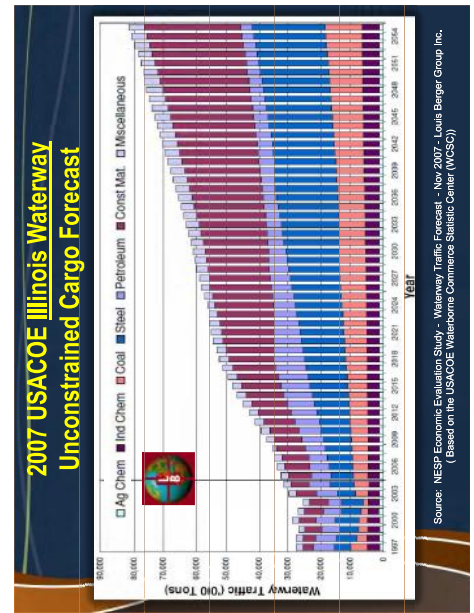
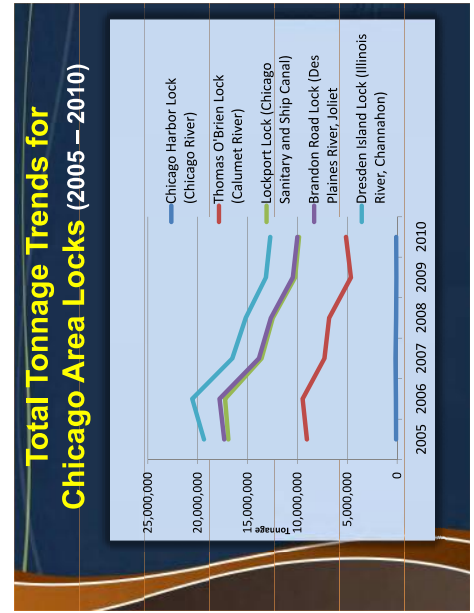



### Statistics for Chicago and T. J. O'Brien Locks

Year	Cargo Tons	Commercial Passengers	Recreation Levels
2000	186,518	818,059	42,008
2001	160,547	6,775,309	28,160
2002	159,665	6,775,309	35,548
2003	159,665	6,775,309	35,548
2004	74,842	6,975,080	61,454
2005	86,705	9,674,529	33,696
2006	111,319	9,046,078	719
2007	127,800	9,482,367	442
2008	167,800	7,294,880	292
2009	78,748	4,641,365	30,244
2010	122,707	7,877,195	505
2011	170,000	7,018,171	32,551
2012	170,000	7,018,171	25,082

98% Cargo      99% Pass

**Chicago Locks**  
 CARGO: CARGO TERMINALS CORP, COLUMBIAN CHEMICAL, FERTILISERS, CHEMICALS  
**O'Brien Lock**  
 PAPER, COKE, STEEL, ANTIKIL, SOYBEAN OIL, STEEL, CHEMICALS, FERTILISERS, CHEMICALS, PAPER, COKE, STEEL, ANTIKIL, SOYBEAN OIL, STEEL, CHEMICALS, FERTILISERS, CHEMICALS, PAPER, COKE, STEEL, ANTIKIL, SOYBEAN OIL, STEEL, CHEMICALS, FERTILISERS, CHEMICALS

Source: LSACE - CMN/PLMS Data

### Advisory Committee & Resource Group Meeting

June 29, 2011

## CAWS Inland Waterway Transportation Container On Barge Potential

Development of Separation Options

### "Deck" Barge Loaded with Containers

### "Hopper" Barge Loaded with Containers

Source: USDOT Maritime Administration MARAD

### North American Class I Railroad System Near Term Growth

If Chicago was a Port, it would be the largest in North America

Legend:  
 2009: 2009-2010  
 2015: 2015-2016

### BNSF Logistics Park, Joliet, IL

A New Model For Freight Logistics Centers

## Wal-Mart's New 3.4 million SF (78 acres under roof) Import Distribution Center

The Cost of This Import Distribution Center was Paid for by the Savings in Truck Drayage Between the Warehouse & the Intermodal Rail Terminal

### Inland Ports Defined

A Convergence of Logistics Trends

### Example of an Automated Bridge Crane Barge Terminal - Europe

Gottwaldkranne Ludwigshafen Luftaufnahme  
Gottwald Port Technology

### Advisory Committee & Resource Group Meeting

June 29, 2011

## CAWS Inland Waterway Transportation Emerging Cargo Trends

Development of Separation Options

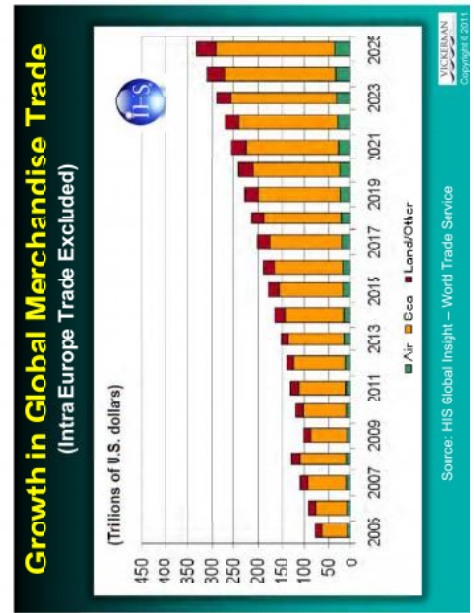



# North American Emerging Mega-Regions

Future US Growth Areas



Source: America 2050 Prospects - Regional Plan Association

# Panama Canal Current Environment



# Panama Canal Third Lane Expansion

Circa December 2014/January 2015



The Panama Canal will more than Double its Capacity by 2014

# Southeast Asian Manufacturing Centroid Shift

Current Inbound U.S. Cargo Flow



# Advisory Committee & Resource Group Meeting

June 29, 2011

Lake Calumet Area Port Development Opportunities Separation Site # 20



Development of Separation Options

# Calumet Potential AIS Separation Scenarios

(At the Calumet River Channel Junction)

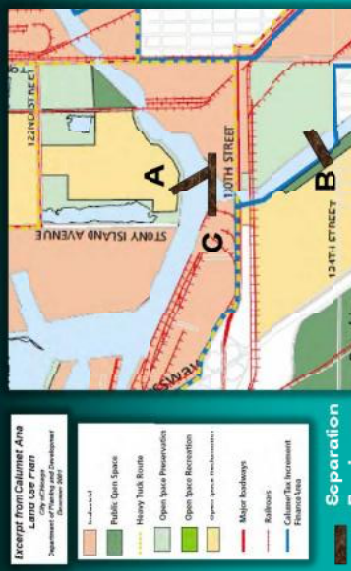

# Calumet Area Industrial Land Use Plan

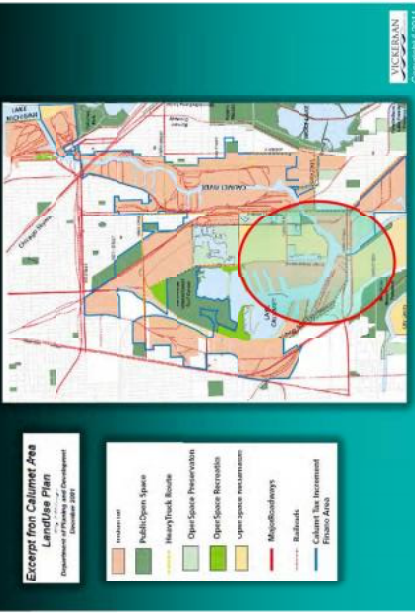

# Site # 20 – Scenario Overview



**Scenario A:** Lake Calumet & CalumetSAG Directly Linked. Port Chicago access to Lake Michigan Severed.  
**Scenario B: (East and West Configuration):** Port Chicago Deep Draft Vessel Traffic to Lake Michigan Maintained.  
**Scenario C: ( With & Without Vessel Turning Basin):** Port Chicago Deep Draft Vessel Traffic to Lake Michigan Maintained.

# Advisory Committee & Resource Group Meeting

June 29, 2011

Lake Calumet Area Port Development SITE # 20 - SCENARIO C

(With & Without Vessel Turning Basin)



Development of Separation Options



**GLC CAWS Peer Review**  
**Transportation Section**  
 Briefing

**SCENARIO C - With Vessel Turning Basin**  
 (Port of Chicago Access to the Great Lakes Maintained)

**Basic Design Criteria**

- Laker Max+ Seaway Max Access downriver Only
- River max (Calumet - Sag) upriver from dam
- Direct River to Laker Loading
- Turning Basin Capacity
- Multiple Large Vessel Capacity
- Efficient Terminal Operations
- Multimodal Capability

**Site #20 North with Vessel Turning Basin**

**Preliminary Conceptual Port Terminal Plan**

Approved: Port Authority, 26th February 2011  
 DRAFT Schematic Port Terminal Concepts - Revised May 11, 2011

**GLC CAWS Peer Review**  
**Transportation Section**  
 Briefing

**SCENARIO C - Without Vessel Turning Basin**  
 (Port of Chicago Access to the Great Lakes Maintained)

**Basic Design Criteria**

- Laker Max+ Seaway Max Access downriver Only
- River max (Calumet - Sag) upriver from dam
- Direct River to Laker Loading
- Turning Basin Capacity
- Multiple Large Vessel Capacity
- Efficient Terminal Operations
- Multimodal Capability

**Site #20 North without vessel turning Basin**

**Preliminary Conceptual Port Terminal Plan**

Approved: Port Authority, 26th February 2011  
 DRAFT Schematic Port Terminal Concepts - Revised May 11, 2011

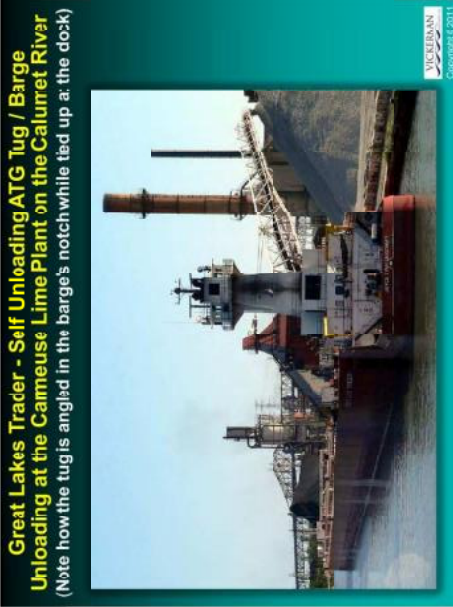

**Self-Unloading Lake Bulk Carrier Loading at KCBK**  
 (Capable of carrying 33,800 tons at her maximum draft of 30 feet 7 inches. Length = 680 ft. Beam = 73 ft. The self-unloading conveyor system feeds a 25) foot boom that can be swung left or right a maximum of 105 degrees.)

**Possible Ship to Barge Direct Transfer**

VICKERMAN CONSULTING



### **D3. AC MEETING 10-19-2011**

- MEETING AGENDA
- MEETING ATTENDEES
- MEETING MINUTES
- PROJECT UPDATE PRESENTATION





# Envisioning a Chicago Area Waterway System for the 21st Century

---



A joint project of the Great Lakes Commission  
and the Great Lakes & St. Lawrence Cities Initiative



## Advisory Committee Meeting

Wednesday, October 19, 2011

9:00 a.m. – 3:30 p.m.

*Gleacher Center – Room 621, Executive Dining Room  
450 North Cityfront Plaza Drive  
Chicago, Illinois 60611 ~ (312) 464-8787*

### Agenda

- |                          |   |  |
|--------------------------|---|--|
| 9:00 a.m.                | <b>Welcome, Introductions and Agenda Review</b>   | Tim Eder, Great Lakes Commission<br>Dave Ullrich, Great Lakes & St. Lawrence Cities Initiative |
| 9:10 a.m.                | <b>Remarks from Executive Committee</b>   |  |
| 9:20 a.m.                | <b>Project Update and Meeting Purpose</b>   | Tim Eder and Dave Ullrich  |
| 9:30 a.m.                | <b>Down-River Separation</b> <ul style="list-style-type: none"><li>• Questions and Discussion</li></ul>   | HDR Engineering, Inc.<br>All Participants  |
| 10:45 a.m.               | <b>Break</b>  |  |
| 11:00 a.m.               | <b>Mid-River Separation</b> <ul style="list-style-type: none"><li>• Questions and Discussion</li></ul>  | HDR Engineering, Inc.<br>All Participants  |
| 12:00 p.m.               | <b>Lunch</b><br><i>Located in the Café on the Lobby Level</i>   |  |
| 1:00 p.m.                | <b>Near Lake Separation</b> <ul style="list-style-type: none"><li>• Questions and Discussion</li></ul>  | HDR Engineering, Inc.<br>All Participants  |
| 2:00 p.m.                | <b>Base Case and Economic Evaluation</b> <ul style="list-style-type: none"><li>• Questions and Discussion</li></ul>   | Dennis Bruce, HDR Engineering, Inc.<br>Jim Ridgway, ECT, Inc.<br>All Participants              |
| 2:45 p.m.                | <b>Vision for the Future and Wrap-up</b> <ul style="list-style-type: none"><li>• Questions and Discussion</li></ul>   | Tim Eder and Dave Ullrich<br>All Participants  |
| 3:30 p.m.                | <b>Adjourn</b>  |  |
| 5:00 p.m. -<br>7:00 p.m. | <b>Reception hosted by the Sierra Club</b><br><i>Please join us for a reception at the offices of the Sierra Club located at:<br/>70 E. Lake St., Ste. 1500<br/>Chicago, IL 60601</i> |  |
- Please RSVP to Tess Wendel, Phone: 312-251-1680 x120, Email: [tess.wendel@sierraclub.org](mailto:tess.wendel@sierraclub.org)**

## Envisioning a Chicago Area Waterways System for the 21st Century

*RSVP List for Project Advisory Committee Meeting and Boat Tour - June 28-29, 2011*

Sal	First	Last	Member Organization	Oct 19 2011
Mr.	John	Andersen	Greenleaf Advisors, LCC	1
Mr.	Dave	Bennett	Metropolitan Mayors Caucus	1
Mr.	Mark	Biel	Chemical Industry Council of Illinois	1
Mr.	George	Bramm	Illinois International Port District	1
Mr.	Joel	Brammeier	Alliance for the Great Lakes	1
Mr.	Dennis	Bruce	HDR Engineering, Inc.	1
Mr.	Clark	Bullard	Prairie Rivers Network	1
Mr.	Lindsay	Chadderton	The Nature Conservancy	1
Mr.	Thom	Cmar	Natural Resources Defense Council	1
Mr.	Joe	Deal	City of Chicago	1
Mr.	Paul	Dierking	HDR Engineering, Inc.	1
Mr.	Matt	Doss	Great Lakes Commission	1
Mr.	Jim	Duncker	U.S. Geological Survey	1
Mr.	Tim	Eder	Great Lakes Commission	1
Mr.	Josh	Ellis	Metropolitan Planning Council	1
Mr.	Tony	Everson	HDR Engineering, Inc.	1
Ms.	Molly	Flanagan	The Joyce Foundation	1
Ms.	Lisa	Frede	Chemical Industry Council of Illinois	1
Ms.	Margaret	Frisbie	Friends of the Chicago River	1
Mr.	Duane	Gapinski	HDR Engineering, Inc.	1
Mr.	John	Goss	Council on Environmental Quality	1
Mr.	David	Hamilton	The Nature Conservancy	1
Mr.	Robert	Hirschfeld	Prairie Rivers Network	1
Mr.	Dan	Injerd	Illinois Dept. of Natural Resources	1
Ms.	Vriti	Jain	City of Chicago	1
Mr.	Pete	Johnson	Council of Great Lakes Governors	1
Mr.	John	Kindra	Illinois River Carriers	1
Ms.	George	Kuper	Council of Great Lakes Industries	1
Mr.	Dick	Lanyon	Metropolitan Water Reclamation District of Greater Chicago	1
Cdre.	Richard	Lauric	Chicago Yachting Association	1
Mr.	Ted	Lawrence	Great Lakes Fishery Commission	1
Mr.	Howard	Learner	Environmental Law & Policy Center	1
Mr.	Tim	Loftus	Chicago Metropolitan Agency for Planning	1
Ms.	Stacy	Meyers	Openlands	1
Dr.	Phil	Moy	Great Lakes Panel on Aquatic Nuisance Species	1
Mr.	Peter	Mulvaney	Greenleaf Advisors, LCC	1
Mr.	David	Murtogh	Office of Senator Coats	1
Mr.	Dave	Naftzger	Council of Great Lakes Governors	1
Ms.	Jen	Nalbone	Great Lakes United	1
Ms.	Ann	Navaro	U.S. Army Corps of Engineers	1
Ms.	Kay	Nelson	Northwest Indiana Forum	1
Mr.	Gary	O'Keefe	U.S. Army Corps of Engineers	1
Mr.	Irwin	Polls	Ecological Monitoring & Assessment	1
Mr.	Gregg	Pupecki	Wendella Sightseeing Co. Inc.	1
Dr.	Terry	Quinney	Ontario Federation of Anglers and Hunters	1
Ms.	Janice	Reid	HDR Engineering, Inc.	1
Mr.	Jim	Ridgway	ECT, Inc.	1
Mr.	Kevin	Rund	Illinois Farm Bureau	1
Ms.	Kim	Sabo	U.S. Army Corps of Engineers	1
Mr.	Joe	Schuessler	Metropolitan Water Reclamation District of Greater Chicago	1
Ms.	Laura	Seaman	Council of Great Lakes Governors	1
Ms.	Leslie	Shad	National Wildlife Federation	1
Ms.	Cindy	Skrukrud	Sierra Club - Illinois Chapter	1
Mr.	Marc	Smith	National Wildlife Federation	1
Mr.	David	St. Pierre	Metropolitan Water Reclamation District of Greater Chicago	1
Mr.	Scott	Stuewe	HDR Engineering, Inc.	1
Mayor	Debbie	Sutherland	Northeast Ohio Mayors & City Managers Assoc.	1
Mr.	Jared	Teutsch	Alliance for the Great Lakes	1
Mr.	Dave	Ullrich	Great Lakes & St. Lawrence Cities Initiative	1
Mr.	Rick	Unger	Lake Erie Charter Boat Association	1
Mr.	John	Vickerman	Vickerman & Associates, LLC	1
Ms.	Tess	Wendel	Sierra Club - Illinois Chapter	1
Mr.	Dave	Wethington	U.S. Army Corps of Engineers	1
Mr.	Doug	Yeskis	U.S. Geological Survey	1
Mr.	Jim	Yurik	Metropolitan Water Reclamation District of Greater Chicago	1
			<b>Total</b>	<b>65</b>

# Envisioning a Chicago Area Waterway System for the 21st Century

---



A joint project of the Great Lakes Commission  
and the Great Lakes & St. Lawrence Cities Initiative



## **Project Advisory Committee Meeting**

**Wednesday, October 19, 2011**

*Gleacher Center – Room 621, Executive Dining Room  
Chicago, Illinois*

## **MEETING NOTES**

### **Welcome and Introductions**

### **Remarks from Executive Committee**

Joe Deal offers mayor Emanuel's support for the project and congratulates us on staying on an aggressive schedule. Reviews recent announcement of new public private partnership to build new boathouses to continue to drive people to the river. In recent budget the mayor proposes increase in water rates. Notes that city has low rates. All revenue will go into water infrastructure – new water mains, sewer improvements, etc. While these issues aren't necessarily aligned with the project, there is overlap and opportunities for mutual support. Great basis for optimism.

Dave Ullrich notes that what's become evident is the importance of looking at project in broader context of CAWS and new and exciting future for the system. Tim notes that we've been encouraged to consider how our proposals fit in with the broader proposals and plans for the river and the system.

### **Project Update and Meeting Purpose**

Tim provides update. Have conducted second peer review process. HDR presented their work to a panel of outside experts. Summary report just sent to AC and RG. Had preview meetings at Joyce Foundation. Also had some ongoing stakeholder input. Comments on vision for future of the waterway has stimulated much discussion. HDR has had ongoing discussions with the Corps and the waterway operators to get more information on commercial traffic. Ongoing communications with the Corps, exchanged data in both directions to help with GLMRIS study. Tim is also on the executive steering committee of the GLMRIS study.

Re. vision for the future: We'll discuss this but won't be able to do it justice today. Peer reviewers challenged us to live up to title of study to articulate a vision for the future of the CAWS. We have reaffirmed that this is, indeed, what this project is about – vision for the system consistent with plans and vision of the City of Chicago, NW Indiana, and the region as a whole. We are sticking with the title and our goals. Look at separation but also improvements to address existing problems and challenges.

### **Introduction and Overview of Process to Date on Development of Separation Options**

Existing conditions: Reviews stormwater conveyance and current restrictions. Water quality: how we maintain adequate water quality in the system by diverting Lake MI water into the system. Recreational movements: Relied on lock passage information from the Corps. Shows 10 year average. Passenger numbers

are trending up. Requested help from the Corps in identifying cargo volumes/movements. Received pass the point information to look at barge traffic that moves through the system. Working to verify these numbers

Separation definition: Directed to develop at least three options. Base case drives much of economic analysis. We have identified existing conditions; we know what the programmed and planned improvements. Also need to consider WWTP upgrades that we can anticipate. For separation options went through a process of considering multiple sites and came up with ensembles of sites.

Base case assumptions: We're still working on this.

- Ongoing AIS control measures, such as electric barrier, rapid response, monitoring
- Current, programmed and authorized infrastructure investments, such as completion of TARP, improved conveyance in accordance with TARP; water quality improvements, such as new mandated improvements to WWTPs (disinfection); transportation improvements.

Separation elements and timelines; interaction of elements; phased implementation, including one-way barrier. Timeline drivers. Possibility of one-way movement of water from lake side to river side.

Initially identified 20 potential locations for barriers. Assessed internally and have tried to be as transparent as possible with preview meetings and other efforts. Ultimately worked down to three alternatives – that highlight issues and show how the system could be over time.

Questions:

From George Kuper: Did you look at projections on various things, such as commercial traffic, recreational uses, etc? Scott: Yes, we did. We used a 10 year timeframe, 2000-2010 to look at trends.

Brameier: Re. pass the point data, was it only barge traffic? Yes, although we did try to identify ship traffic going into the Calumet River. Did we include lakers coming into the Calumet River? Yes, looked at 20 year forecast and looked at all vessels and some scenario forecasting. Do we have number of vessels for the past the points: yes. We don't have origin-destination, but we have complete synopsis of vessel numbers, tonnage, type, etc. Scott adds that we got some data from individual shippers, too, to back up what we got from the Corps.

Kay: Why no steel in the tonnage? John V: there was some, but that level of detail isn't shown. We show the majority of commodity flows – the top flows. Percentage of vessel movements, but we can show it by commodity or weight, too.

Dick: Has number of outfalls been clarified? Yes, this has been clarified. On near-lake options, the one in the north could be closer to the lake – why not? Resp. to address water quality and habitat.

Tonnage at Calumet River: have you segregated by barge and ship? John V: yes, we've segregated this to show Calumet River traffic of ships vs. barges.

Kuper: You got us really excited by possibility of regional transportation improvements. Has this big picture been incorporated into the alternatives? John V.: Yes, our vision hasn't waned. We have embedded this vision into the alternatives. Vision is full intact and full empowered.

## Down River Separation

Chose alternatives that illustrate varying impacts and opportunities. Sort of bookend the alternatives.

Key elements:

- Single barrier, some elegance in this.
- Stormwater: plugging primary outlet, but gain a lot of interaction between the river and the lake. Also poses challenges.
- Water quality: Concerns about WWTPs that now will interact with the lake, sediments.
- Transportation: increases distance from barrier to destination of commercial traffic on Calumet River.
- Timeline: largely driven by flood control projects; major one is TARP. Also shows need for additional stormwater management projects.

All WWTPs will need major upgrades so they can discharge to Lake MI. Also need to create flow to keep river healthy.

Improvements: see slide with improvements in different categories.

Shows timelines of major elements, barriers and investments in stormwater, water quality, etc. Includes initial one-way barrier in conjunction with transportation investments. Also, continued investments in stormwater and water quality that will occur over time. Once those are in place you can convert barrier to complete, two way barrier. Phase 1 end is 2022 and end of Phase II is 2029. Shows more detailed timeline.

Phase I - Stormwater: Sewer separation within one mile of river. Green infrastructure. Floodplain storage. Reservoirs. Maintain backflows to maintain access to lake even when we have one-way barrier. Tunnel to lake.

Phase I – Water Quality: WWTP upgrades.

Phase I – Transportation: Intermodal transfer facility.

Phase II – Stormwater: Tunnel system to lake to compensate for lack of flow in river. Doesn't rely on large storage reservoir; relies on lake as storage.

Phase II – Water Quality: Increasing interaction between river and lake, so need to address sediments, augment flows with outflow from Stickney, split outflow both upstream and downstream. Upgrade WWTPs, since all three plants will now flow to the lake. Working to conserve reservoir capacity by using green infrastructure and getting stormwater into the river.

Key points: Losing outlet but gaining interaction to lake. Exposing sediments. Losing flows. Losing commercial passage but gain opportunity for intermodal facility. Timeline driven by stormwater and water quality improvements.

What's the difference between current floodplain storage on north branch vs. what we propose. We looked at current plans with focus on regional benefits, but not necessarily local benefits.

What about tunnel from Little Cal to the lake? Worked with Corps to understand flood dynamics in this area. Tunnel is to create siphon from Corps flood storage area to the lake – get flows out of the system and give high water flows chance to escape to the lake.

Is there capacity storage in Lake Calumet and Lake George? We considered this, but capacity isn't large, but provides some buffering capability. Not really a large storage volume.

Dick Lanyon: With high lake levels and winds, tunnels might not work well. They need to be carefully designed. Yes, we realize this. This is a challenge, and the alternatives are useful in illustrating the respective challenges that we will face under various scenarios.

Dick: What about unregulated compounds getting into Lake MI. There currently are about 3 million people who discharge to Lake MI. With separation you add 5 million dischargers. Discharge of unregulated compounds could make it so we can't drink Lake MI water. We're aware of this challenge.

Kay notes that tunnel from Little Cal to Lake MI is right where their drinking water intake is; need to be mindful of this in how this is presented.

Kay: wherever you're going to put the intermodal transportation facility, you have to consider other transportation infrastructure upgrades that would be required, including air attainment. John V. notes that we're aware of these. In this alternative it's in a somewhat remote area, so not as much of a challenge. More of a challenge in other, more congested areas.

Tim: why sewer separation program, challenges and limitations, etc. Also why green infrastructure?

Response: Good to have water going into the ground through green infrastructure. Looked at private sector and public sector. Looked at City's stormwater infrastructure and its impacts, and extrapolated into the future for impacts on private sector. Also looked at rational ways to improve the stormwater ordinance to generate increase in stormwater infiltration. On private side used existing rules. Looked at right of way opportunities, roads, curb to curb, etc. looking at max opportunity for green infrastructure. But also looked at opportunities using more traditional grey solution. Ended up with a blended solution that looks at historical investments in road improvements, and add green infrastructure to all of these. Incorporated new miles of improvements that will come from the major's new announcement.

With sewer separation, looked at how far back from the river can we go and maintain a slope. Looked at topography and roadways around the river and analyzed what we can fit. Shows that we can fit roughly a mile of sewer separation – strictly on the right of way. Just curb to curb right of way street runoff, but not runoff from homes. Plan arterial separation with residential streets connecting to it.

Did you account for intake of powerplant at Romeoville? Would be loss of flows to the powerplant. There are key downstream users who will be impacted.

Jen N: Will the barrier be any more or less effective once completed than the other barriers. Resp. risk difference is in the timing. Once fully completed they will be equally effective. Timing for building out two-way barrier varies by alternative.

Dan Injerd: What sort of lake levels are you assuming? Lake levels will drive river elevation. Also inputs within the system. We envision the river level fluctuating with the lake. However, you could close the gates/locks and pump out the system to the lake if the lake is high.

Dick L: clarifies plans for intermodal facility. Resp. attempting to keep commodities on the water where it's most cost effective. However, we recognize that there may be opportunities for transfer to other modes.

When accounting for what Chicago is doing to reduce stormwater volumes, are you also looking at MWRD's efforts in this area? We're aware of this, but didn't directly factor them into our calculations, but did consider them in calculation that looked at the city's ordinance. Looked at case study reports of other cities and impacts of green infrastructure.

Dave U: What about contaminated sediments – how extensive? Resp. large issue with sediments with this alternative. Erwin says they will recommend two studies: comprehensive survey to determine volume, location and toxicity of sediments; and sediment transport model analysis to determine the risk of them getting into the lake. Where and when would they get into the lake. Explains that we have a number of monitoring stations in the system, but would need more under separation scenario. Lot of waterway that would have to be evaluated. Kay: How long would the studies take? Resp. we estimate that assessment and removal could take up to ten years. Not sure where the sediments would be removed to. Could be some in-situ or capping.

Sewer separation: clarify – one mile on either side of the river.

Biel: Does the timeline consider delays due to legal challenges, environmental reviews, etc? Not explicitly, but we do include some buffer in the design process. But yes, it's an aggressive timeline. We show a best case scenario.

Dave N: to clarify, you're envisioning some transfer of water across the barrier, with some degree of AIS risk? In phase I, there would be one-way transfer from lake to downriver past the barrier. In phase II, all flow would be treated wastewater. And we'd still have interaction between the Desplains and CAWS during wet weather. Would there be potential for species to move up river into the system from the south? Would have to move through a pumped system and through the WWTP. Also, the water being diverted downriver past the barrier is rain water from the land, not lake water.

Kay: Would you add more lake water in addition to what's currently used for drinking water and other uses? Only in phase I; in phase II you'd have full separation with no flow of Lake MI water past barrier.

### **Mid-River Separation**

Talking about four potential barrier locations.

Key elements: see slides.

Still interaction between CAWS and lake, but less. Only one WWTP on lake side. Still need for flow augmentation. Still need for sediment remediation, although less. For transportation, maintains connection between lake and Calumet River, port of Chicago, and Lake Calumet. Timelines driven by flood control and stormwater control measures under TARP in north; in south timeline driven by port construction.

Improvements: see slides

Timelines: For Chicago system timeline is driven by stormwater improvements. One-way barrier by 2022, but need transportation improvements. Water quality improvements proceed with completion of TARP, sediment remediation, etc.

For Calumet system, can have full barriers by 2022 concurrent with improvements.

John V. does his review of transportation improvements, especially on the Calumet River.

### **Questions and Discussion**

Is the Corps' projected \$24/ton increase in cost for transfer to land-based modes high? Resp. my estimate is that it would be \$15-\$24/ton increase. The Corps figure of \$24/ton isn't necessarily high, but it will vary by commodity.



Is the barrier at the confluence of the Calumet and Cal Sag? Yes. Don't anticipate changing turning basin.

Re. increase cost of transfer, we believe the incremental cost could be limited to time delay. Believe a full barge tow could be done in 6-8 hrs. Cost increment would be 10%, or \$2-\$5 per ton. Five cranes per barrier.

Who pays for cranes on barriers? We haven't specifically identified the cost responsibilities. However, in my opinion it would be a public-private partnership. References new IL law that allows IL DOT to form public-private partnerships. Envisions a public port authority with both public and private operators.

Chicago Yacht Association rep: Who's going to pay for movement of recreational boats? Unclear on costs and who would pay. However, we are confident that this can be done. Concerns about costs and impacts on recreational boating. What do you consider a larger vessels. 250 tons.

Clark Bullard: When can we see realistic depictions of intermodal transfer facilities at each location? We've shown plan views, but could show illustrations. My vision is a major, intermodal transfer facility. It's important that you show an accurate depiction of what the facility will look like.

Kuper: Where is the future? Where is the excitement? What will there be that pulls in people to our region? Exciting is just off of the rendering. Notes that Detroit is working to take advantage of increase cargo flows emerging from expansion of the Panama Canal. Notes that, under certain parameters, flows to Chicago port will increase. Excitement is that some of the intermodal flow can be put on water and save money, reduce air pollution, and reduce congestion if it's part of a broader plan and system. We have an opportunity to look at commodity flows in Chicago in a different way. Looking for 1 + 1=3 opportunity. We aren't the only ones looking at this opportunity.

But, all this can occur without separation.

Andy B: Notes that Chicago has an opportunity to enlist support from Congress to support this, as long as it's done with separation. Without separation, you're on your own.

Ted Lawrence: How are you accounting for the economic benefits? And what about the benefits to the GL region of preventing AIS transfer?

Joel: Why do you need sewer separation in areas that are downstream of the barriers? Because we want to conserve storage space in TARP. We also want to add low flow to support water quality.

Dave U: Can you quantify what additional storage capacity the sewer separation would provide? Yes, we can – roughly 500 million gallons with green infrastructure.

Frisbee: Have we looked at how to speed up McCook? How do we know that the 2029 deadline for TARP is accurate?

Kay: Is anti degradation for WWTPs included in the timelines? Yes, but we did use a best-case scenario. Add a line in detailed timeline for anti-deg. Where would the Grand Cal barrier be? There is flexibility on where the barrier on the Grand Cal would be located. Probably in between the two WWTPs. Probably close to the natural watershed divide.

Guy from Wendella Boats: When you transfer boats over the barrier isn't there the risk of AIS movement? Notes that rec boat movements would only be on a seasonal basis, and would include some form of disinfection of hulls to remove AIS. Dave U. notes that there are AIS on both sides and separation is intended to prevent movement in both directions and protect both water bodies.

## Near Lake Separation

Key elements: see slides. Totally cuts off lake from river, so need to manage all stormwater.

Questions:

Dick L: Why isn't the barrier on the north right next to the lake. Notes 16 CSO outfalls in the reach between where we have the barrier and Lake MI. Suggests that barrier be put at lakefront.

Joel: Why is the barrier on the Little Cal located where it is on Hartz Ditch. Response is that it's near a large Corps flood control/levy district.

Clark Bullard: Why is a stagnant area necessarily bad?

Dan Injerd: What's up with flow augmentation at Jardine water plant. And how will you handle transfer of rec boats and larger tour boats. Needed to create flow in river to maintain flow. Would be able to move smaller vessels, but not larger ones. Would look at moving people across the barrier to get from one tour boat to another.

Will there be a flooding risk if you can't control river levels. Proposing that stormwater volumes would be stored.

Dick L. expresses concern about using potable water for flow augmentation. Doesn't seem like a good use of treated water. Perhaps you could pump treated wastewater down for flow augmentation.

How would relocation of port facilities on Calumet River to Lake Michigan work? Response: this is a large undertaking. Moving 30 terminals and adding new port with road and rail access. Moving all terminals using deep draft vessels. Would be one of the largest port development projects in the US. It would be at the mouth of the Calumet River at Lake MI.

What would happen to the terminals/real estate on the Cal River once they are cut off from Lake MI? We've noted this, but haven't really considered alternative uses.

What is the cost of 2020 mast plan for LA-Long Beach? About \$5.5 billion and took 20 years.

What is the plan for moving people through the Chicago lock/barrier? There's 750,000 people who pass through this. We don't have a detailed design, but envision docking on either side with passenger friendly facilities.

If Fisk and Crawford electric power plants are shut down, does that affect the movement of coal moving in both directions? Yes. Anticipates that there will be more clarity soon about the future of these plants.

Clark Bullard: Will the final report have analysis showing that we aren't just optimizing barge-to-barge operations? Response: it is difficult for this team, within the confines of our scope, to do a rigorous analysis of potential modal shifts and future commodity flows. We will use professional judgment, but likely won't have the analytical rigor behind them. He expresses concern about lack of rigor about future trends in commodity flows, locations, modes, etc. Notes that we seem to have greater knowledge of impacts on commodity flows from the expansion of the Panama Canal than future trends with local commodity flows. John V. says we need detailed, econometric study of future trends in commodity flows, but this is expensive and beyond our current scope. Scott S. notes that we've based our study just on existing data.

## Base Case and Economic Evaluation

Dave notes that we had hoped to farther along on this, but we aren't. Has proven more difficult than we imagined. Is particularly difficult estimating benefits.

Jim Ridgway: Notes that he assembled the peer review, and received diverse opinions on how to calculate benefits, ascribe costs, etc. We want your input to them on this. There are some costs and benefits that may occur with or without separation. There are some treatment cost on the books and coming up that may occur with or without separation. Treatment standards are likely to become more stringent over time, especially for discharges to the Mississippi River basin. What are baseline costs; what can be anticipated in the near term and long term. Suggests three pots: 1) treatment practices currently underway across the region, including disinfection. We've concluded that these are baseline costs. 2) Anticipated treatment costs currently expected across the basin, such as nutrient removal (phosphorous). Could also be increased treatment costs for discharges to the MS river (nitrogen). He believes that within the project period WWTPs discharging to the MS river will required to remove nutrients, and this likely will be similar to nutrient removal costs for discharges to the Great Lakes. 3) Removal of toxics, like mercury and PCBs. WWTP don't have ability to treat for these pollutants, and doesn't expect that this capability will occur within the project period. Currently, other systems address this through pre-treatment/source reduction programs. So what will the costs be in the CAWS for this?

Also, what will costs for stormwater management and flood control be? In CAWS, this mostly revolves around completing TARP. Costs for TARP rest with MWRD. However, if TARP were completed tomorrow there are still costly projects that will be required to get stormwater TO TARP. There is a considerable investment required in this are by local units of government to get excess stormwater and sewage to TARP. As this proceeds, green infrastructure and partial sewer separation could minimize excess stormwater and maximize the abilities of TARP. So, there are investments that will be required whether they go with conveyance to TARP, or rely on sewer separation and/or green infrastructure. He argues that these are local costs and not project costs or cost attributable to eco separation. Also suggests that partial sewer separation will also have water quality benefits by adding flow, so this is an added benefit.

We encourage you to consider these issues and provide your input.

Dennis' presentation: Cost Benefit Analysis of Physical Separation Options. (see slides).

One other thought from Tim: We want to have time to discuss the vision for the future of the CAWS. This is tied to the discussion of the base case, how you account for costs, and what's attributable to the base case vs. separation. We need to decide which column to list costs in, and some of this is based on our vision for the future of the CAWS. Being based in Michigan, I suggest a vision with great humility. However, part of this vision has been articulated by other actors, such as Mayor Emanuel, Friends of the Chicago River, transportation stakeholders, etc. So our vision is tied to the base case and how we account for costs of separation vs. costs of things that will have to happen anyway. We strongly encourage feedback after today to help illuminate this discussion.

Frisbee: Our vision is that it is a natural, beneficial amenity for the benefit of everyone (get their vision). Means that we want to drive people to the river, meaning that we need water quality, sediments cleaned up, etc.

Clark Bullard: Transportation future should be pretty straight forward. Water quality is more difficult and will require some subjective decisions. We have the CWA on the books, with same goals for all water bodies: fishable, swimmable, and drinkable. Are local constraints, but ultimately this is where we're headed. Clean Water Act compliance should be in both the with and without separation scenarios. With this, you don't

need to parse out property value increases along the waterway, since they will be the same under both scenarios.

Joel: What I would NOT want to see in the base case is an assessment based just on current permits. There needs to be a standard of reasonableness that you need to exercise. For example, projecting the closure of coal burning power plants falls within the realm of reasonableness. There's a consent decree coming out related to MWRD. There's also our 1-t expectations re. CSO controls. The team should be able to express a reasonable projection of what this will look like based on what other jurisdictions across the country are required to do.

Kay Nelson: Much of this project is based on eliminating risk of AIS transfer, both carp and other AIS. Now, the discussions today are great, but are way beyond what the public is expecting from this report. We have gotten SO into other aspects, we've gotten away from what the general public is expecting from this study. I'm a little concerned because we're not considering whether we are eliminating the risk of carp, or just reducing the risk.

George Kuper: We are looking for improvements in many areas. Your base case appears to assume these improvements will be pursued. Thus, the synergy is combining all of these things simultaneously. This requires a level of analysis that assesses relative benefits of four areas separately and in combination. We also need an analysis of other alternatives for getting these benefits and AIS risk reduction to support the synergistic value.

Ontario Federation of Anglers and Hunters: Where does anyone see an analysis conducted on the null hypothesis – if you do NOT separate, what are the costs and benefits of this approach? In the absence of this, I'm having difficulty evaluating your results.

Dave's response: Notes that Canada is doing a risk assessment on Asian carp invading and becoming established in the Great Lakes. This will inform the impacts on the Great Lakes. I hope that what we're doing is over-delivering on an under-estimation. We don't have the luxury of looking only at one issue at a time. For example, we can't look at all the potential invading species one at a time. So, if we can dramatically reduce the risk (I don't believe we can get to zero risk), that's good, recognizing that eco separation has the highest probability of getting the most risk reduction. Regarding other issues, we can't responsibly NOT examine other issues.

George: You're doing the right thing, but more. You need to highlight individual benefits, but also the synergistic benefits of all of them combined.

Dick Lanyon: This effort has shown that we're dealing with a much more complicated set of issues than many of us believed. Whatever we come up with will be the first step in the discussion, and much more detailed analysis is needed. Notes that the tunnel (?) was included in the original 1972 Corps plan and then dropped. Much more will be required.

Dave U. notes that we didn't expect that we would generate a plan that would lead immediately to implementation. We hope our plan increases the public's understanding of the complexity of the issues and accelerate progress toward decisions that lead to implementing solutions.

Joel: Have you considered including in the base case the behavior of decision makers outside of the Chicago region, such as Congress? There are actions and decisions that may influence how our report moves forward. Tim: not sure how we can predict what the Corps, Congress, attorneys general will do. Perhaps acknowledge this, but how do we incorporate this into the base case? Joel: You can look at the budget for GLMRIS.

Regardless what you include in the base case, it would be beneficial to the public to include a cost benefit analysis of what hasn't occurred yet. Dave: this goes beyond the scope of what we can reasonably do. Notes that some things will be required by law under the CWA. Must look at what is most likely to happen, but not necessarily what the individual costs and benefits will be.

Dick Lanyon: Agrees that we shouldn't second guess requirements of the CWA. We've been waiting for decisions from EPA. It's not necessary to worry about costs and benefits of these actions. However, what we should consider are the issues that will be here generations from now – such as unregulated compounds and what we need to do – be precautionary to protect the lakes. Our vision should on Lake MI as a resource for future generations. Also include a vision for Lake MI.

Dave: what can we do or say in the short term to help us define the vision for the future of the CAWS. Says that protecting water quality in Lake MI shouldn't be contingent on having a barrier; implementing green infrastructure; improving movement of good shouldn't be contingent on a barrier. There's a whole host of things that should be happening regarding of whether there is eco separation. Present a scenario with an array of positive and necessary components and who is responsible for them, is a major benefit for the region. Then can include barriers, but don't tie them to barriers and eco separation.

Dave's question to CMAP: Recognizing that we can't do a Burnham Plan for the Chicago River, how can we generate a longer term vision that will be beneficial. Resp: there's ample opportunity for improvement in the three areas you've identified. The report will do the region a favor by looking at these things together. Agree that, when it comes to Lake MI, we still have an outdated mentality related to "solution to pollution is dilution." We need to not only consider benefits to CAWS, but also to Lake Michigan.

Dave notes that the farther out you go, people mostly care about carp, and when they see the dates for barrier implementation, they will say "no way are we going to wait that long."

Stacy, Open Lands: Gives me hear that Burnham's plan took over a decade to develop. There are at least two audiences: in Chicago we are re-inventing ourselves. Carp can help us examine our region. So, re-envisioning our waterway is already happening, and this forum provides a great opportunity to do this. The bus is leaving the station with or without us, so it's in our interests to get in front of this and consider all the issues together.

Dave notes the need to connect the dots and achieve some synergy from considering all the issues together.

Joel: Speaking now as a Great Laker and how this is perceived outside of the region, we're asking a lot of people outside of the region to understanding the complexity of the CAWS and our issues. We should be considered how all the institutions can integrate AIS prevention into their plans and discussions. We should show that we're thinking of getting to a sustainable water supply system that also keeps AIS out of the Great Lakes.

Josh: We have the Chicago Climate Action Plan, which is comparable. You're proposing a coordinated plan under which you recognize that every time you do something, you are incrementally closer to AIS prevention. However, each of these things needs to have benefits on their own, in addition to moving us in the right direction in terms of AIS prevention.

George: There will much suspicion on whatever we do.

Dick Lanyon: Perhaps you could ease the fears of those outside Chicago by noting that carp aren't in the lakes and we're working to keep them out. Note that it won't happen tomorrow. Re. vision for the CAWS, there are two issues: legacy sediments that have to be dealt with; also habitat. The CAWS is habitat limited, because it's mostly a man-made waterway system. We need to adapt our thinking to this in terms of

articulating a vision for the future. Dave notes that there are some habitat opportunities that can be pursued. Suggests that we should think more broadly beyond water quality to ecological quality.

Clark Bullard: When people say we aren't moving fast enough, remind them that this isn't just about Chicago and the Great Lakes Basin; there are at least 22 other states that already have AIS, and they don't want more. So, if our region wants to speed things up, we will need help.

Jen Nalbene: How do we get to the point where we have an investment in separation? To the extent that any one of the alternatives can have an investment in separation, that is important. The sooner we have an investment, vs. just a plan, the better.

Frisbee: Make sure we don't present CAWS as devoid of life. Need to make this part of our message that we have ?? species of fish; otters are coming back, etc.

Josh: To motivate the Chicago region to take the next step in developing a contingency plan should Congress or the Supreme Court, we should do this if the decision is made by someone else. Would require us to think about HOW we would do this, not WHETHER we should do it. How do we DO it and maintain our region's interests.

Dick Lanyon: Governance – what about local levels: Chicago, MWRD, local jurisdictions, etc. There's anarchy in dealing with water in the region. Could use a regional authority to oversee water. We could use a better form of governance for water.

### **Vision for the Future and Wrap Up**

Do you want additional time for comment? Kay says yes. Howard also suggests we send out an email with summary of economic models for review.

Do we get a chance to weigh in on the final report? Tim: probably not. Haven't figured out how to do this; we'll discuss this. Perhaps a briefing upon release. We're not going to distribute a draft report. We won't attribute any of our finding and conclusions to the AC.

Will final report have ballpark costs of alternatives? Yes.

**HDR**

# Envisioning a Chicago Area Waterway System for the 21st Century

Advisory Committee Meeting

October 19, 2011

## Agenda

- Existing Conditions
- Alternatives
  - Key Elements
  - Timeline
  - Improvements

**HDR**

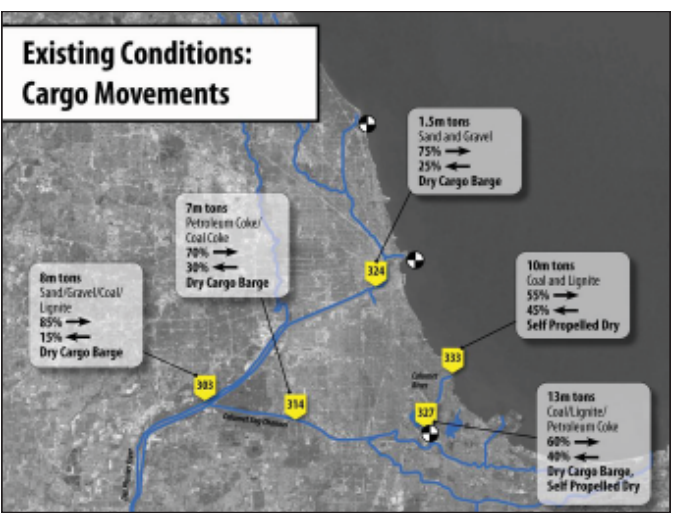
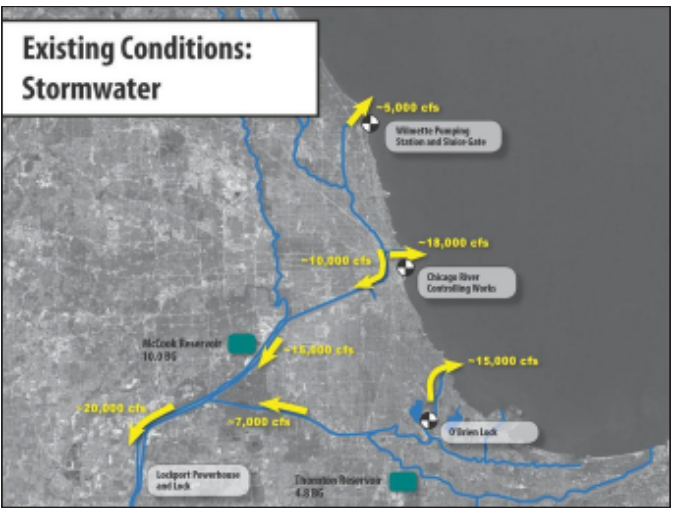

## Separation Definition

Cost-Benefit Analysis of THREE "Separations" compared to base case

**Base Case**  
Relevant factors to be included must be:

- Existing Conditions
- Programmed and authorized improvements\*  
\*Anticipated and emerging WWTP upgrades TBD

**Separations**  
Ensemble of Barrier Locations with:

- Strategies and vision for improvements
- Sequencing of implementation

**HDR**

## Base Case Assumptions

- Ongoing AIS control measures
- Current, programmed and authorized infrastructure investments:
  - Storm Water Management
    - TARP completed
    - Improved conveyance in accordance with TARP
  - Water Quality
    - Disinfection at North Side and Calumet WWTPs
    - Anticipated and emerging WWTP upgrades TBD
  - Transportation
    - CREATE
    - Chicago Park District Marinas

**HDR**

## Separation Elements and Timeline

- Interaction of Elements
- Phased Implementation
  - 1-way and Complete Barrier
  - Timeline Drivers

**HDR**



## Potential Separation Locations

Focused on key infrastructure and geographic locations



HDR

## Selected Barrier Separations

Focused on illustrating range of issues



HDR

HDR

## Questions



Great Lakes  
Commission

HDR

## Down River Separation

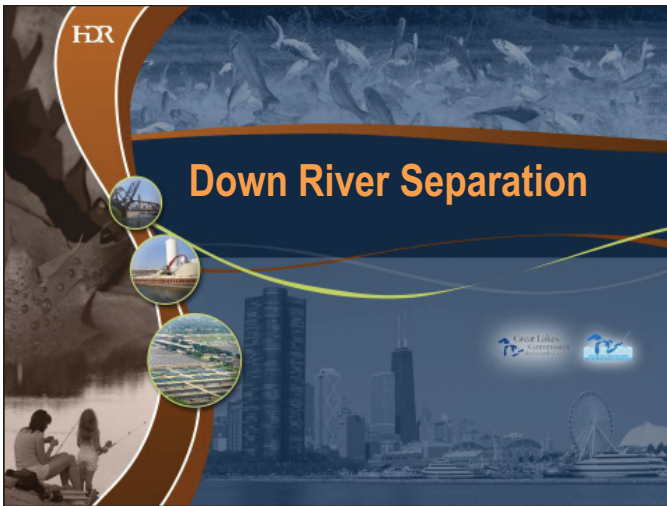

Great Lakes  
Commission

## Down River Separation

Completed Barrier

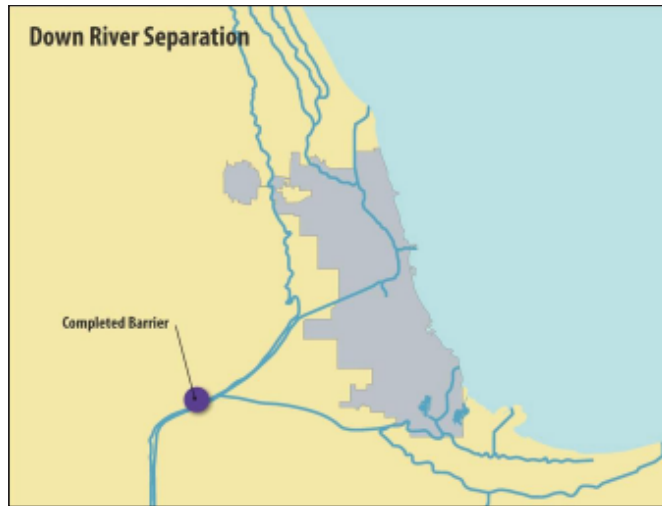

## Down River - Key Elements

- 1 Barrier Location
- Stormwater
  - Connects CAWS and Lake MI
  - Lose downstream conveyance outlet
- Water Quality
  - 3 major WWTPs require upgrades
  - Downstream Flow Reduction
  - Flow augmentation
  - Sediment remediation needed within CAWS
- Transportation
  - Maintains movements within CAWS
  - Prevents movement of barges in CSSC → cargo transferred
- Timeline
  - Driven by TARP

HDR

## Down River Separation: Stormwater

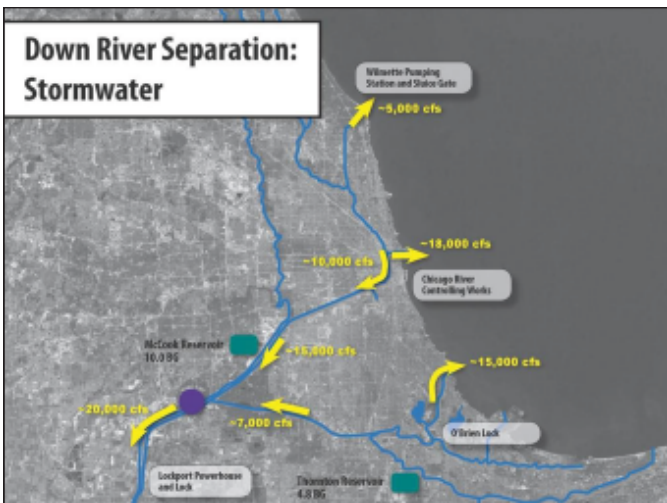

## Down River Separation: Water Quality



## Down River Separation: Transportation

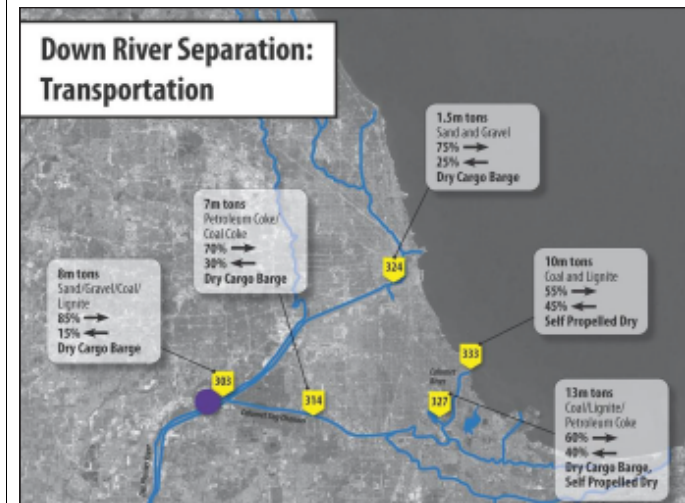

## Down River Separation - Improvements

- Stormwater
  - Additional Conveyance/Storage
  - Green Infrastructure and Sewer Separations
  - Emergency Barrier Bypass
- Water Quality
  - 3 WWTP Upgrades (Northside, Calumet, Stickney)
  - Flow Augmentation
  - Sediment Remediation
- Transportation
  - Bulk cargo transfer
  - Intermodal transfer facilities
  - Recreational boat lift
  - Dry dock/maintenance facilities

HDR

## Down River Timeline

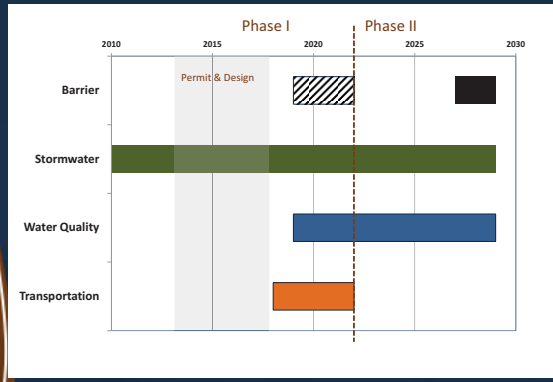

HDR

## Down River Detailed Timeline

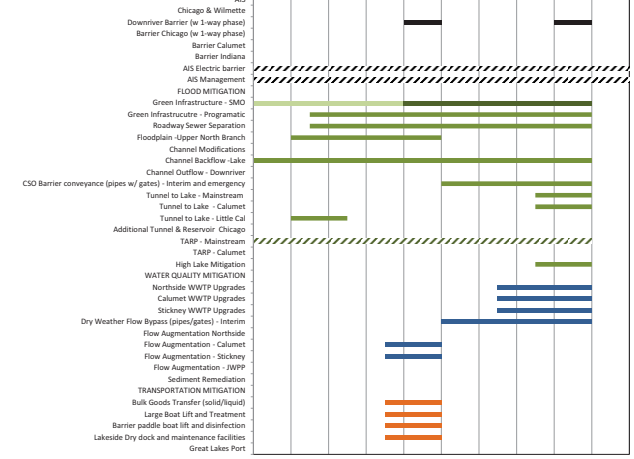

HDR

## Down River Separation - Phase I

### Down River Separation Stormwater

PHASE I: through 2022

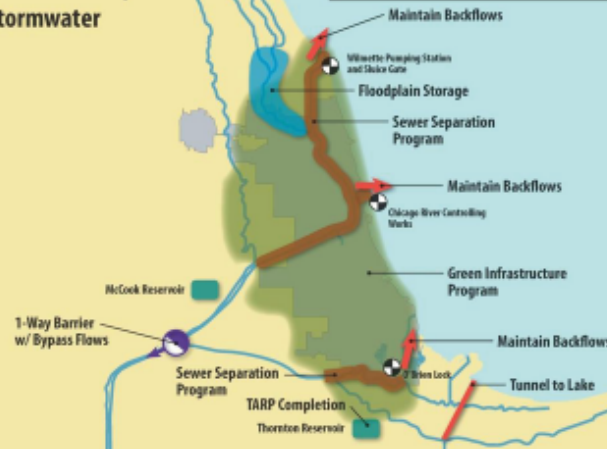

### Down River Separation Water Quality

PHASE I: through 2022



### Down River Separation Transportation

PHASE I: through 2022



HDR

## Down River Separation - Phase II

### Down River Separation Stormwater

PHASE II: through 2029





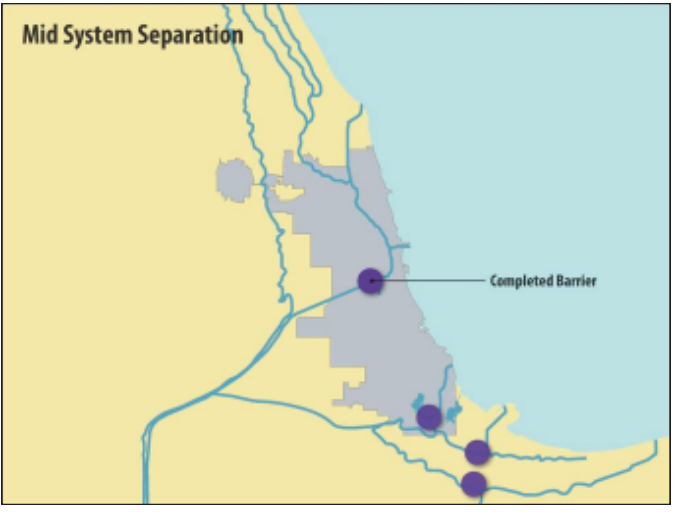
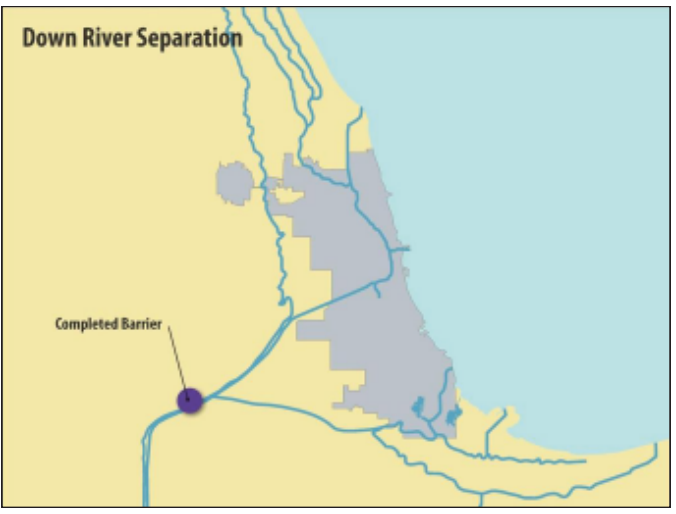

- ### Mid System - Key Elements
- 4 Barrier Locations
  - Stormwater
    - Connects CAWS and Lake MI
    - Lose downstream conveyance outlet at Bubbly Creek
  - Water Quality
    - Northside WWTP upgrades required
    - Flow augmentation
    - Sediment remediation needed in Chicago River system
  - Transportation
    - Maintains connection between Calumet area and Lake MI
    - Prevents vessel movement between Calumet area and Illinois Waterway System → cargo transferred
    - Minimize impacts on waterborne vessels in Chicago River area
  - Timelines
    - Chicago River: driven by TARP
    - Calumet System: driven by port construction
- HDR

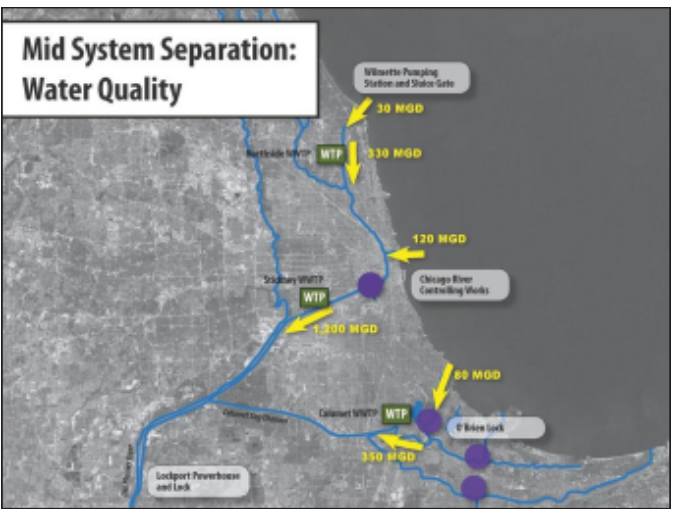
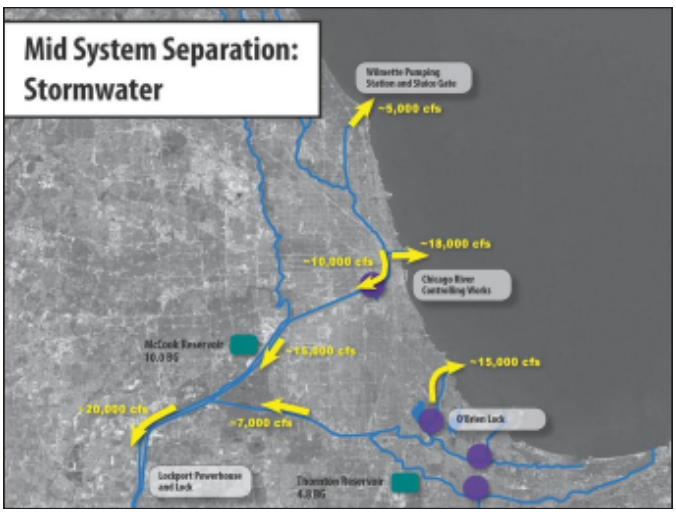

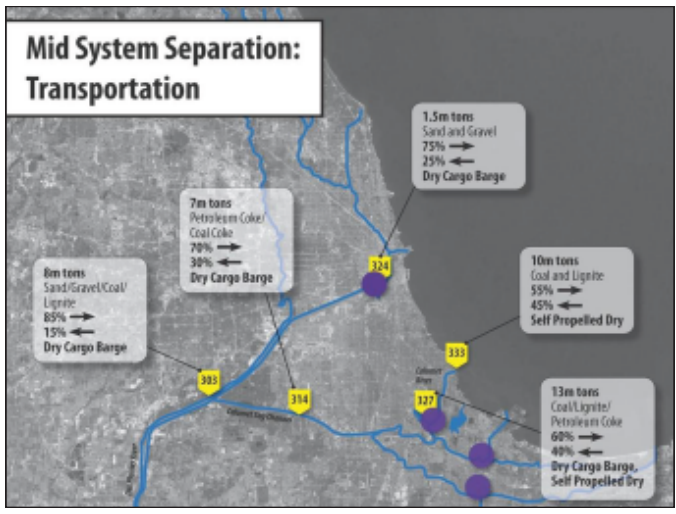

- ### Mid System Separation - Improvements
- Stormwater
    - Additional Conveyance/Storage
    - Green Infrastructure and Sewer Separations
    - Emergency Barrier Bypass
  - Water Quality
    - Northside WWTP Upgrades
    - Flow Augmentation
    - Sediment Remediation
  - Transportation
    - Bulk cargo transfer
    - Intermodal transfer facilities
    - Recreational boat lift
    - Dry dock/maintenance facilities

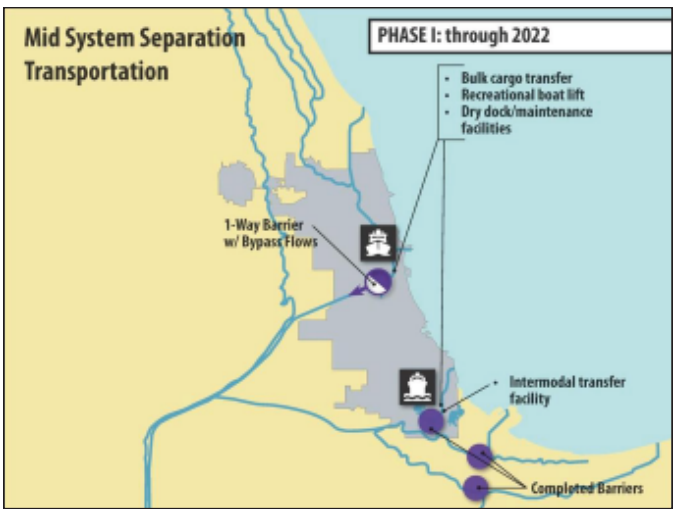
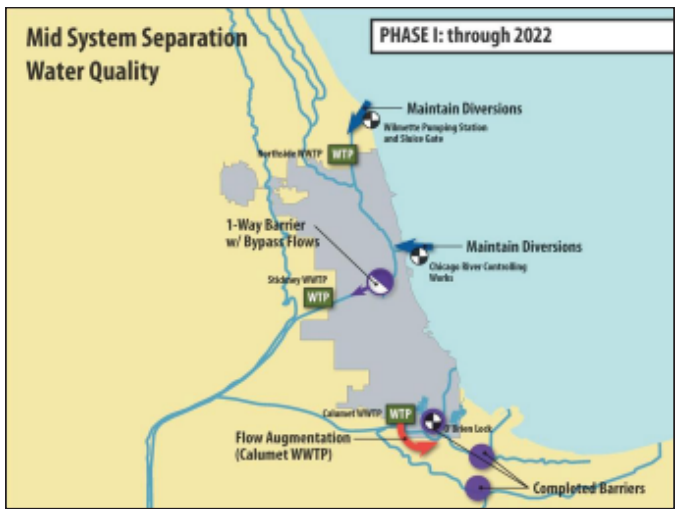
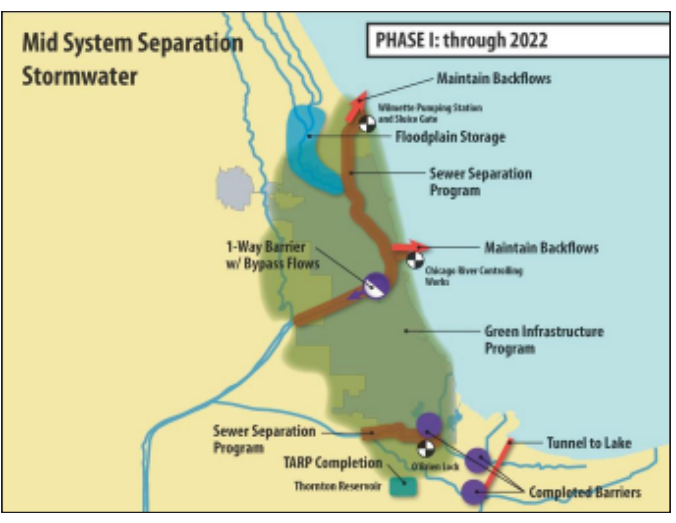
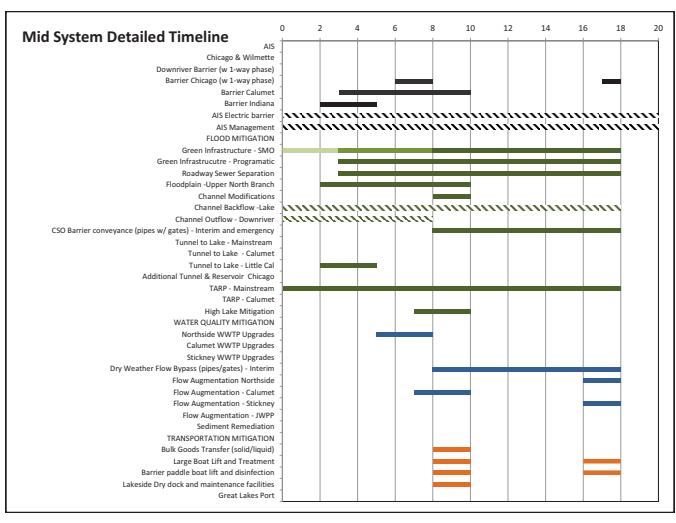
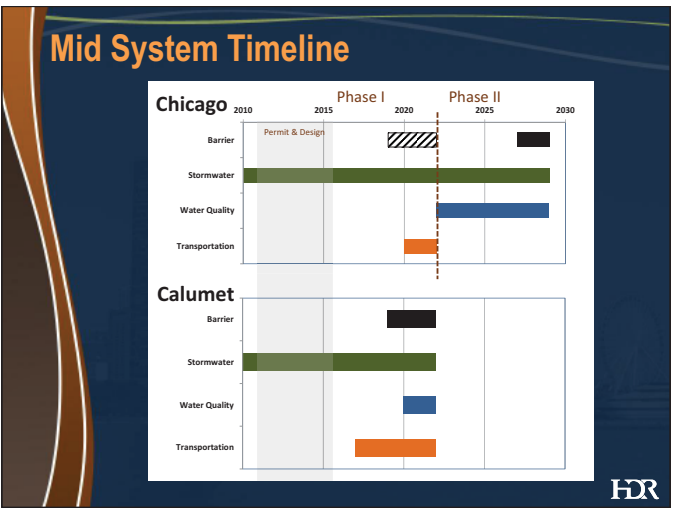



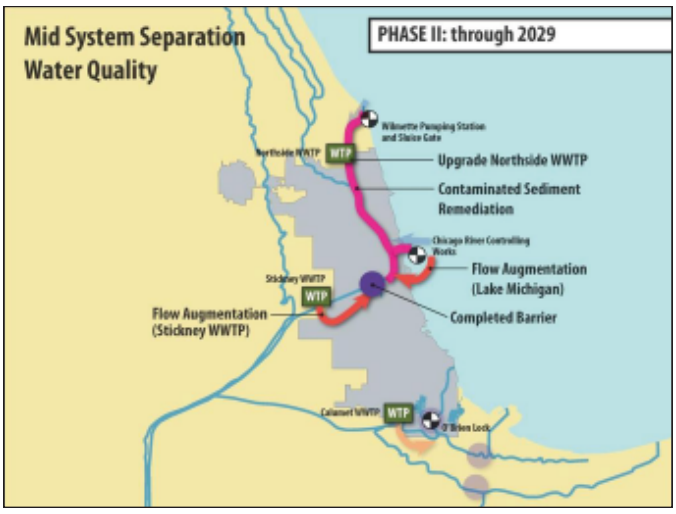
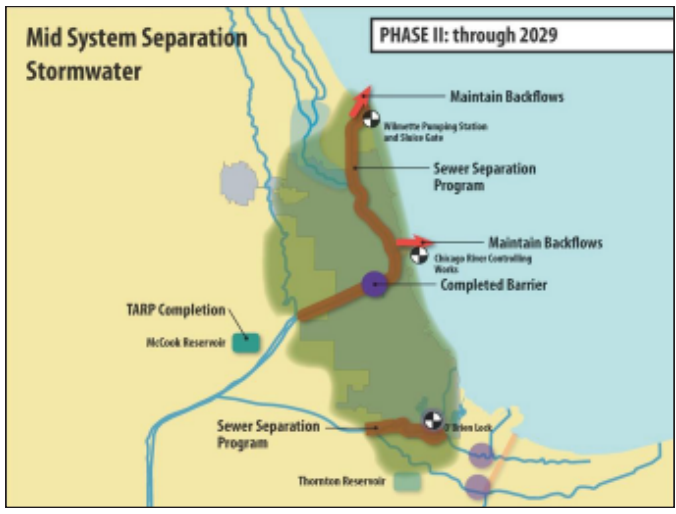

## Mid System Separation – Completed Barriers

Great Lakes Commission

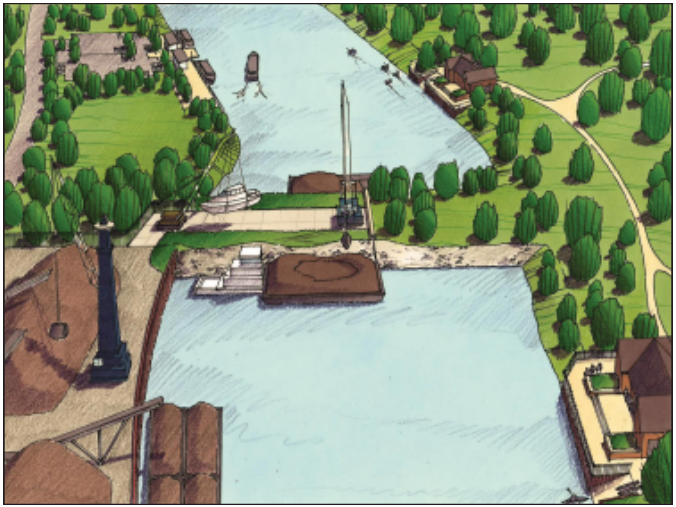
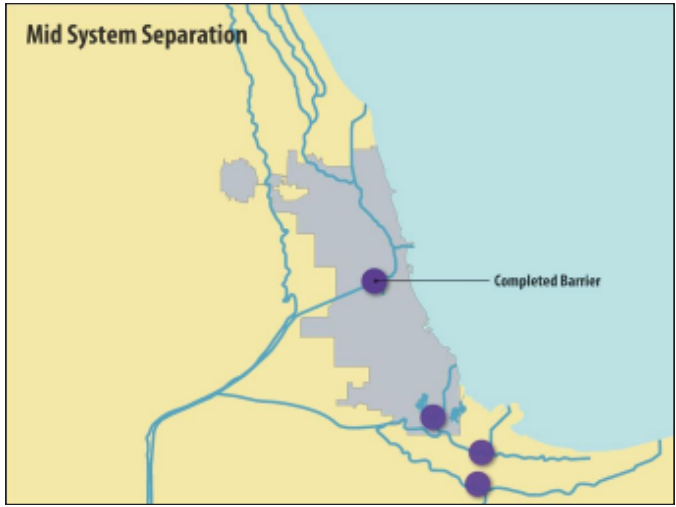

### 82 ton Liebherr Flexible Cargo Harbour Mobile Crane

(Wide commodity mix capability including dry bulks, metals and containers handled by barge)

VICKERMAN  
Copyright © 2011

### Gottwald HSK Portal Harbour Cranes Fitted with 4-rope Grab System

**Four-rope-grab crane** for handling capacities of up to **1,850 tons per hour**. Gottwald. CommTrac is a **Dry Bulk Terminal Management System** providing all the functionality to assure efficient and reliable Dry Bulk Terminal Operation.

GOTTWALD part technology

VICKERMAN  
Copyright © 2011

### High Capacity Dry Bulk Crane with Active Dust-Protection System

(Continuous-duty bulk-handling operation, demanding handling rates of up to 1,500-1,800 tons/hour)

GOTTWALD part technology

VICKERMAN  
Copyright © 2011



## Wide Span Gantry at the River Terminal in Aschaffenburg, Germany

(For unloading coal and containers and simultaneously managing the storage yard)



VICKERMAN  
Copyright © 2011

## Great Lakes Trader - Self Unloading ATG Tug / Barge Unloading at the Carmeuse Lime Plant on the Calumet River



VICKERMAN  
Copyright © 2011

## Self-Unloading Lake Bulk Carrier Loading at KCBX

The self-unloading conveyor system feeds a 250 foot boom that can be swung left or right a maximum of 105 degrees.)



VICKERMAN  
Copyright © 2011



## Questions & Discussion

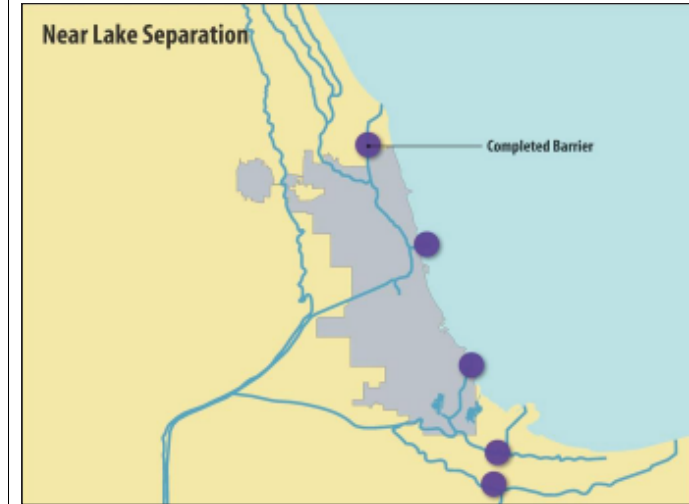

### Near Lake Separation - Key Elements

- 5 Barrier Locations
- Stormwater
  - Reduces backflows to Lake MI
- Water Quality
  - Eliminates diversions from Lake MI
  - Maintain current WWTP operations
  - Flow augmentation
  - Limited contaminated sediment remediation
- Transportation
  - Maintains connection between Calumet area and Illinois Waterway System
  - Prevents vessel movement between Calumet area and Lake MI → cargo transferred
  - Prevents vessel movement at Chicago Lock → cargo transferred
- Timeline
  - Chicago River: driven by TARP and stormwater elements
  - Calumet System: driven by port construction

HDR

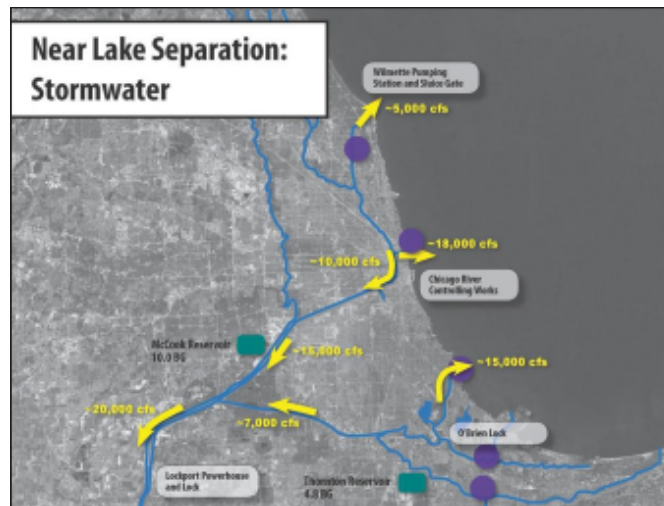



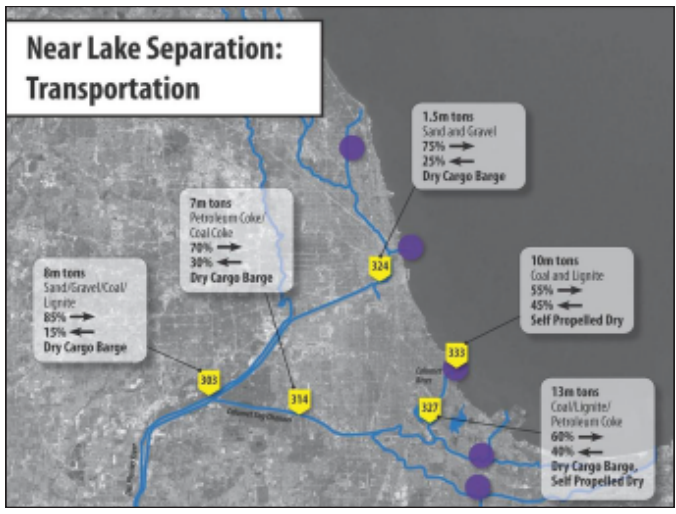

- ### Near Lake Alternative
- Stormwater
    - Additional Conveyance/Storage
    - Green Infrastructure and Sewer Separations
    - Emergency Barrier Bypass
  - Water Quality
    - Flow Augmentation
    - Sediment Remediation
  - Transportation
    - Replacement port/terminal facilities
    - Bulk cargo transfer
    - Intermodal transfer facilities
    - Recreational boat lift
    - Dry dock/maintenance facilities

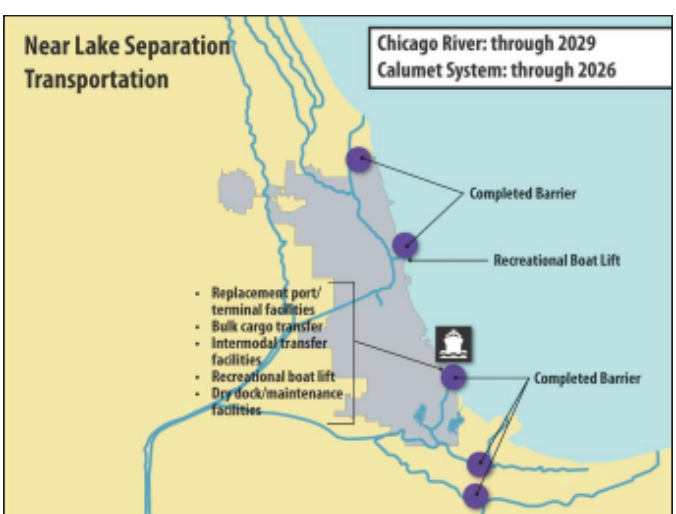
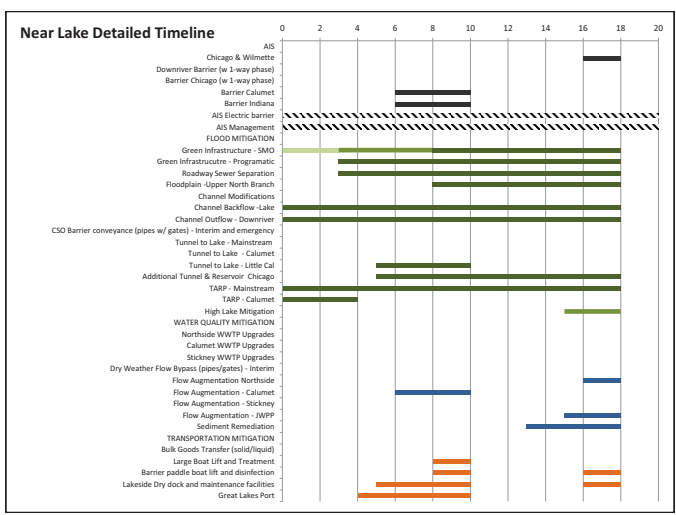
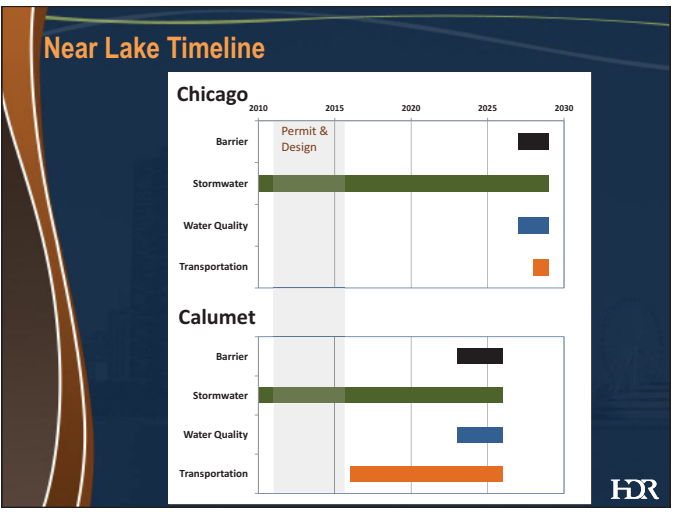



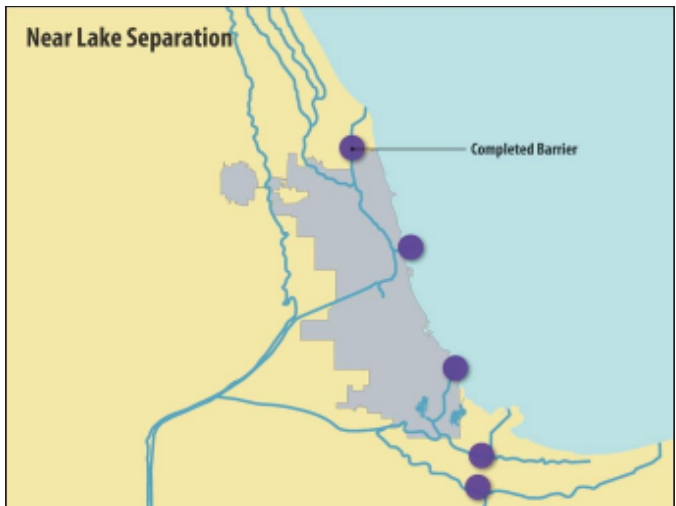

## Envisioning a Chicago Area Waterway System for the 21st Century

### Cost Benefit Analysis of Physical Separation Options

#### AC Meeting

ONE COMPANY | Many Solutions™

## Cost Benefit Analysis Objectives

- Quantify the net public value of separation alternatives
- Address economics related to:
  - AIS
  - Transportation
  - Water quality
  - Stormwater management
- Identify relative magnitude of cost and benefit (by sector) for each alternative
- Identify qualitative costs and benefits as well

2

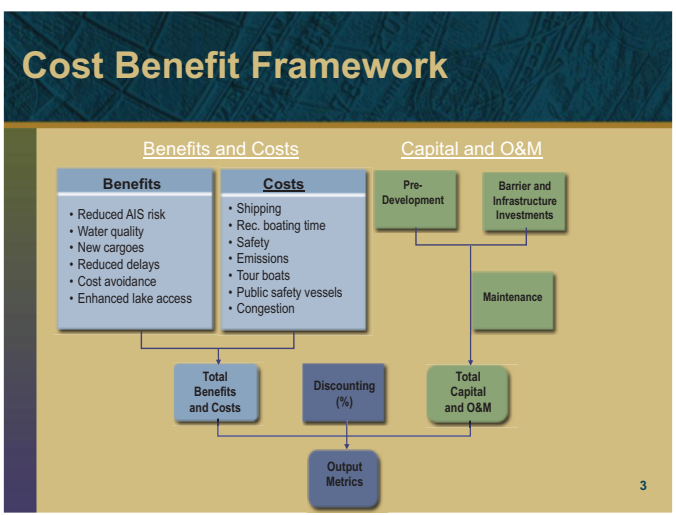

## Costs of Separation Alternatives

Category	Description
Regulatory	Environmental, permitting processes.
Infrastructure Capital and O&M	Barriers, transportation, stormwater management, water quality.
Modal shift from barge	Shipping and related costs (e.g., emissions, accidents, congestion). Reduced barge revenues.
Recreational boating	Inconvenience of lift and marina relocation. Reduced access to existing drydocks/storage.
Tour operators and water taxis	Additional vessels, operations and passenger time. Reduced access to existing drydocks.
Public Safety	Additional emergency vessels on both sides of separation barrier.

4

## Benefits of Separation Alternatives

Category	Description
Reduced AIS Risk	Reduced costs associated with AIS transfers.
Water quality	Increased recreational uses / property values.
Lake access	Recreational opportunities and development.
New cargoes	Increased barge revenues. Reduced shipping costs.
Reduced delays	Reduction in rail/auto delays at lift bridges.
Cost avoidance	Reduced O&M from displaced locks.
Green Infrastructure	Stormwater management plus other benefits.
Land uses	Expands options for future developments.

5

## Valuation of Effects

- Modal shift
  - Transportation solution minimizes modal shift
  - Increase in transit times, costs will result in some modal shift
- Water Quality
  - Leverage willingness to pay studies for valuing water quality improvement
- AIS
  - Case studies based on historical AIS impacts to assess potential \$ impacts of AIS

6

## Cost Benefit Next Steps

- Complete quantification of cost and benefit inputs
- Finalize "base case" definition
- Finalize timing of infrastructure investments
- Complete economic analysis and public value assessment

7





30 N. LASALLE STREET  
SUITE 3220  
CHICAGO, IL 60602  
PHONE: 312.443.4900  
WWW.HDRINC.COM

