



EPA/625/R-00/008

February 2002

# **Onsite Wastewater Treatment Systems Manual**

Office of Water  
Office of Research and Development  
U.S. Environmental Protection Agency



## Notice

This document has been reviewed in accordance with U.S. Environmental Protection Agency policy and approved for publication. Mention of trade names or commercial products does not constitute endorsement or recommendation for use.

## Foreword

The U.S. Environmental Protection Agency is pleased to publish the “Onsite Wastewater Treatment Systems Manual”. This manual provides up-to-date information on onsite wastewater treatment system (OWTS) siting, design, installation, maintenance, and replacement. It reflects significant advances that the expert community has identified to help OWTSs become more cost-effective and environmentally protective, particularly in small suburban and rural areas.

In addition to providing a wealth of technical information on a variety of traditional and new system designs, the manual promotes a performance-based approach to selecting and designing OWTSs. This approach will enable States and local communities to design onsite wastewater programs that fit local environmental conditions and communities’ capabilities. Further details on the proper management of OWTSs to prevent system failures that could threaten ground and surface water quality will be provided in EPA’s forthcoming “Guidelines for Management of Onsite/Decentralized Wastewater Systems”. EPA anticipates that the performance-based approach to selecting and managing appropriate OWTSs at both the watershed and site levels will evolve as States and communities develop programs based on resources that need protection and improvement.

Robert H. Wayland III, Director  
Office of Wetlands, Oceans and Watersheds

E. Timothy Oppelt, Director  
National Risk Management Research Laboratory





## Table of Contents

Notice .....	ii
Foreword .....	iii
List of Figures .....	vii
List of Tables .....	ix
Acknowledgments .....	xi
Introduction .....	xiii
<b>Chapter 1. Background and use of onsite wastewater treatment systems .....</b>	<b>1-1</b>
1.1 Introduction .....	1-1
1.2 History of onsite wastewater treatment systems .....	1-2
1.3 Regulation of onsite wastewater treatment systems .....	1-3
1.4 Onsite wastewater treatment system use, distribution, and failure rate .....	1-4
1.5 Problems with existing onsite wastewater management programs .....	1-5
1.6 Performance-based management of onsite wastewater treatment systems .....	1-10
1.7 Coordinating onsite system management with watershed protection efforts .....	1-11
1.8 USEPA initiatives to improve onsite system treatment and management .....	1-12
1.9 Other initiatives to assist and improve onsite management efforts .....	1-15
<b>Chapter 2. Management of onsite wastewater treatment systems .....</b>	<b>2-1</b>
2.1 Introduction .....	2-1
2.2 Elements of a successful program .....	2-3
2.3 Types of management entities .....	2-6
2.4 Management program components .....	2-13
2.5 Financial assistance for management programs and system installation .....	2-41
<b>Chapter 3. Establishing treatment system performance requirements .....</b>	<b>3-1</b>
3.1 Introduction .....	3-1
3.2 Estimating wastewater characteristics .....	3-1
3.3 Estimating wastewater flow .....	3-2
3.4 Wastewater quality .....	3-8
3.5 Minimizing wastewater flows and pollutants .....	3-10
3.6 Integrating wastewater characterization and other design information .....	3-20
3.7 Transport and fate of wastewater pollutants in the receiving environment .....	3-20
3.8 Establishing performance requirements .....	3-40
3.9 Monitoring system operation and performance .....	3-53
<b>Chapter 4. Treatment processes and systems .....</b>	<b>4-1</b>
4.1 Introduction .....	4-1
4.2 Conventional systems and treatment options .....	4-2
4.3 Subsurface wastewater infiltration .....	4-2
4.4 Design considerations .....	4-6
4.5 Construction management and contingency options .....	4-34
4.6 Septic tanks .....	4-37
4.7 Sand/media filters .....	4-48
4.8 Aerobic treatment units .....	4-52

## Table of Contents, Cont'd.

### Onsite wastewater treatment systems technology fact sheets

1	Continuous-Flow, Suspended-Growth Aerobic Systems (CFSGAS) .....	TFS-1
2	Fixed-film processes .....	TFS-7
3	Sequencing batch reactor systems .....	TFS-13
4	Effluent disinfection processes .....	TFS-17
5	Vegetated submerged beds and other high-specific-surface anaerobic reactors .....	TFS-23
6	Evapotranspiration and evapotranspiration/infiltration .....	TFS-31
7	Stabilization ponds, FWS constructed wetlands, and other aquatic systems .....	TFS-37
8	Enhanced nutrient removal—phosphorus .....	TFS-41
9	Enhanced nutrient removal—nitrogen .....	TFS-45
10	Intermittent sand/media filters .....	TFS-53
11	Recirculating sand/media filters .....	TFS-61
12	Land treatment systems .....	TFS-71
13	Renovation/restoration of subsurface wastewater infiltration systems (SWIS) .....	TFS-77

### Onsite wastewater treatment systems special issues fact sheets

1	Septic tank additives .....	SIFS-1
2	High-organic-strength wastewaters (including garbage grinders) .....	SIFS-3
3	Water softeners .....	SIFS-7
4	Holding tanks and hauling systems .....	SIFS-9

<b>Chapter 5. Treatment system selection .....</b>	<b>5-1</b>
5.1 Factors for selecting appropriate system design and size .....	5-1
5.2 Design conditions and system selection .....	5-1
5.3 Matching design conditions to system performance .....	5-1
5.4 Design boundaries and boundary loadings .....	5-3
5.5 Evaluating the receiving environment .....	5-9
5.6 Mapping the site .....	5-24
5.7 Developing the initial system design .....	5-24
5.8 Rehabilitating and upgrading existing systems .....	5-32

## Figures

Figure 1-1.	Conventional onsite wastewater treatment system .....	1-1
Figure 1-2.	Typical single-compartment septic tank .....	1-3
Figure 1-3.	Onsite treatment system distribution in the United States .....	1-5
Figure 1-4.	Fate of water discharged to onsite wastewater treatment systems .....	1-7
Figure 1-5.	The watershed approach planning and management cycle .....	1-13
Figure 1-6.	Large-capacity septic tanks and other subsurface discharges .....	1-14
Figure 2-1.	Onsite wastewater management overlay zones example .....	2-18
Figure 2-2.	Process for developing onsite wastewater management .....	2-20
Figure 3-1.	Distribution of mean household daily per capita indoor water use .....	3-5
Figure 3-2.	Indoor water use percentage, including leakage, for 1,188 data logged homes .....	3-6
Figure 3-3.	Daily indoor water use pattern for single-family residence .....	3-7
Figure 3-4.	Peak wastewater flows for single-family home .....	3-8
Figure 3-5.	Average hourly distribution of total unfiltered BOD <sub>5</sub> .....	3-10
Figure 3-6.	Typical graywater reuse approach .....	3-19
Figure 3-7.	Strategy for estimating wastewater flow and composition .....	3-21
Figure 3-8.	Plume movement through the soil to the saturated zone .....	3-22
Figure 3-9.	An example of effluent plume movement .....	3-25
Figure 3-10.	Soil treatment zones .....	3-26
Figure 3-11.	Zinc sorption by clay as a function of pH .....	3-38
Figure 3-12.	Example of compliance boundaries for onsite wastewater treatment systems .....	3-40
Figure 3-13.	Input and output components of the MANAGE assessment method .....	3-44
Figure 3-14.	Probability of environmental impact decision tree .....	3-50
Figure 4-1.	Conventional subsurface wastewater infiltration system .....	4-2
Figure 4-2.	Lateral view of conventional SWIS-based system .....	4-5
Figure 4-3.	Subsurface infiltration system design versus depth to a limiting condition .....	4-7
Figure 4-4.	Raising the infiltration surface with a typical mound system .....	4-9
Figure 4-5.	Schematic of curtain drain construction .....	4-9
Figure 4-6.	Capacity chart for subsurface drains .....	4-11
Figure 4-7.	Pathway of subsoil reaeration .....	4-16
Figure 4-8.	Distribution box with adjustable weir outlets .....	4-19
Figure 4-9.	Serial relief line distribution network and installation detail .....	4-19
Figure 4-10.	Drop box distribution network .....	4-21

## Figures, Cont'd.

Figure 4-11.	Various gravelless systems .....	4-21
Figure 4-12.	Placement of leaching chambers in typical application .....	4-22
Figure 4-13.	Typical pressurized distribution system layout .....	4-23
Figure 4-14.	Pressure manifold detail .....	4-24
Figure 4-15.	Horizontal design for pressure distribution .....	4-25
Figure 4-16.	Rigid pipe pressure distribution networks with flushing cleanouts .....	4-26
Figure 4-17.	Pressure manifold and flexible drip lines prior to trench filling .....	4-28
Figure 4-18.	Emitter discharge rates versus in-line pressure .....	4-29
Figure 4-19.	Dripline layout on a site with trees .....	4-31
Figure 4-20.	Pumping tank (generic) .....	4-32
Figure 4-21.	Profile of a single-compartment septic tank with outlet screen .....	4-38
Figure 4-22.	Two-compartment tank with effluent screen and surface risers .....	4-40
Figure 4-23.	Examples of septic tank effluent screens/filters .....	4-41
Figure 4-24.	Tongue and groove joint and sealer .....	4-43
Figure 4-25.	Underdrain system detail for sand filters .....	4-48
Figure 4-26.	Schematics of the two most common types of sand media filters .....	4-50
Figure 5-1.	Preliminary design steps and considerations .....	5-2
Figure 5-2.	Performance (design) boundaries associated with onsite treatment systems .....	5-4
Figure 5-3.	Subsurface wastewater infiltration system design/performance boundaries .....	5-5
Figure 5-4.	Effluent mounding effect above the saturated zone .....	5-8
Figure 5-5.	General considerations for locating a SWIS on a sloping site .....	5-13
Figure 5-6.	Landscape position features (see table 5-6 for siting potential) .....	5-14
Figure 5-7.	Conventional system layout with SWIS replacement area .....	5-15
Figure 5-8.	Site evaluation/site plan checklist .....	5-16
Figure 5-9.	Soil textural triangle .....	5-19
Figure 5-10.	Types of soil structure .....	5-20
Figure 5-11.	Potential evaporation versus mean annual precipitation .....	5-24
Figure 5-12.	Development of the onsite wastewater system design concept .....	5-25
Figure 5-13.	Onsite wastewater failure diagnosis and correction procedure .....	5-33

## Tables

Table 1-1.	Typical pollutants of concern from onsite wastewater treatment systems .....	1-2
Table 1-2.	Census of housing tables: sewage disposal, 1990 .....	1-6
Table 1-3.	Estimated onsite treatment system failure rates in surveyed states .....	1-7
Table 2-1.	Organizational approaches for managing onsite systems .....	2-7
Table 2-2.	Survey of state certification and licensing programs .....	2-33
Table 2-3.	Components of an onsite system regulatory program .....	2-36
Table 2-4.	Compliance assurance approaches .....	2-38
Table 2-5.	Example of functional responsibilities matrix .....	2-42
Table 2-6.	Funding options .....	2-43
Table 2-7.	Advantages and disadvantages of various funding sources .....	2-47
Table 3-1.	Summary of average daily residential wastewater flows .....	3-3
Table 3-2.	Comparison of daily per capita indoor water use for 12 study sites .....	3-4
Table 3-3.	Residential water use by fixture or appliance .....	3-5
Table 3-4.	Typical wastewater flow rates from commercial sources .....	3-7
Table 3-5.	Typical wastewater flow rates from institutional sources .....	3-8
Table 3-6.	Typical wastewater flow rates from recreational facilities .....	3-9
Table 3-7.	Constituent mass loadings and concentrations .....	3-11
Table 3-8.	Residential wastewater pollutant contributions by source .....	3-11
Table 3-9.	Wastewater flow reduction methods .....	3-13
Table 3-10.	Flow rates and flush volumes before and after U.S. Energy Policy Act .....	3-14
Table 3-11.	Wastewater flow reduction: water-carriage toilets and systems .....	3-14
Table 3-12.	Wastewater flow reduction: non-water-carriage toilets .....	3-15
Table 3-13.	Wastewater flow reduction: showering devices and systems .....	3-15
Table 3-14.	Wastewater flow reduction: miscellaneous devices and systems .....	3-16
Table 3-15.	Reduction in pollutant loading achieved by eliminating garbage disposals .....	3-18
Table 3-16.	Typical wastewater pollutants of concern .....	3-23
Table 3-17.	Examples of soil infiltration system performance .....	3-23
Table 3-18.	Case study: septic tank effluent and soil water quality .....	3-28
Table 3-19.	Wastewater constituents of concern and representative concentrations .....	3-29
Table 3-20.	Waterborne pathogens found in human waste and associated diseases .....	3-32
Table 3-21.	Typical pathogen survival times at 20 to 30 °C .....	3-33
Table 3-22.	MCLs for selected organic chemicals in drinking water .....	3-35
Table 3-23.	Case study: concentration of metals in septic tank effluent .....	3-36
Table 3-24.	MCLs for selected inorganic chemicals in drinking water .....	3-37
Table 3-25.	Treatment performance requirements for New Shoreham, Rhode Island .....	3-45

## Tables, Cont'd.

Table 3-26.	Resource listing, value ranking, and wastewater management schematic .....	3-46
Table 3-27.	Proposed onsite system performance standards in various control zones .....	3-48
Table 3-28.	Treatment performance standards in various control zones .....	3-48
Table 3-29.	Nitrogen loading values used in the Buttermilk Bay assessment .....	3-52
Table 3-30.	Typical laboratory costs for water quality analysis .....	3-61
Table 4-1.	Commonly used treatment processes and optional treatment methods .....	4-3
Table 4-2.	Characteristics of typical SWIS applications .....	4-5
Table 4-3.	Suggested hydraulic and organic loading rates for sizing infiltration surfaces .....	4-12
Table 4-4.	Geometry, orientation, and configuration considerations for SWISs .....	4-16
Table 4-5.	Distribution methods and applications .....	4-18
Table 4-6.	Dosing methods and devices .....	4-23
Table 4-7.	Pressure manifold sizing .....	4-25
Table 4-8.	Contingency options for SWIS malfunctions .....	4-34
Table 4-9.	Operation, maintenance, and monitoring activities .....	4-36
Table 4-10.	Characteristics of domestic septic tank effluent .....	4-38
Table 4-11.	Average septic tank effluent concentrations for selected parameters .....	4-39
Table 4-12.	Average septic tank effluent concentrations from various commercial establishments .....	4-39
Table 4-13.	Septic tank capacities for one- and two-family dwellings .....	4-40
Table 4-14.	Watertightness testing procedure/criteria for precast concrete tanks .....	4-43
Table 4-15.	Chemical and physical characteristics of domestic septage .....	4-46
Table 4-16.	Single pass and recirculating filter performance .....	4-53
Table 5-1.	Types of mass loadings to subsurface wastewater infiltration systems .....	5-6
Table 5-2.	Potential impacts of mass loadings on soil design boundaries .....	5-7
Table 5-3.	Types of mass loadings for point discharges to surface waters .....	5-9
Table 5-4.	Types of mass loadings for evapotranspiration systems .....	5-9
Table 5-5.	Site characterization and assessment activities for SWIS applications .....	5-11
Table 5-6.	SWIS siting potential vs. landscape position features .....	5-14
Table 5-7.	Practices to characterize subsurface conditions through test pit inspection .....	5-18
Table 5-8.	Example of a total cost summary worksheet to compare alternatives .....	5- 31
Table 5-9.	Common onsite wastewater treatment system failures .....	5-32
Table 5-10.	General OWTS inspection and failure detection process .....	5-35
Table 5-11.	Response of corrective actions on SWIS boundary mass loadings .....	5-35

## Acknowledgments

This update of the 1980 *Design Manual: Onsite Wastewater Treatment and Disposal Systems* (see <http://www.epa.gov/ORD/NRMRL/Pubs/625180012/625180012.htm>) was developed to provide supplemental and new information for wastewater treatment professionals in both the public and private sectors. This manual is not intended to replace the previous manual, but rather to further explore and discuss recent developments in treatment technologies, system design, and long-term system management.

The information in the chapters that follow is provided in response to several calls for a more focused approach to onsite wastewater treatment and onsite system management. Congress has expressed interest in the status of site-level approaches for treating wastewater, and the Executive Branch has issued directives for moving forward with improving both the application of treatment technologies and management of the systems installed.

The U.S. Environmental Protection Agency (USEPA) responded to this interest by convening a team of subject matter experts from public agencies, private organizations, professional associations, and the academic community. Two representatives from the USEPA Office of Water and a representative from the Office of Research and Development coordinated the project team for this document. Close coordination with the USEPA Office of Wastewater Management and other partners at the federal, state, and local levels helped to ensure that the information in this manual supports and complements other efforts to improve onsite wastewater management across the nation.

The principal authors of the document are Richard Otis of Ayres Associates; Jim Kreissl, Rod Frederick, and Robert Goo of USEPA; Peter Casey of the National Small Flows Clearinghouse; and Barry Tanning of Tetra Tech, Inc. Other persons who made significant contributions to the manual include Robert Siegrist of the Colorado School of Mines; Mike Hoover of North Carolina State University; Jean Caudill of the Ohio Department of Health; Bob Minicucci of the New Hampshire Department of Environmental Services; Tom Groves of the New England Interstate Water Pollution Control Commission; Tom Yeager of Kennedy/Jenks Consultants; Robert Rubin of North Carolina State University; Pio Lombardo of Lombardo Associates; Dov Weitman and Joyce Hudson of USEPA; Lisa Brown, Seldon Hall, Richard Benson, and Tom Long of the Washington Department of Health; David Pask and Tricia Angoli of the National Small Flows Clearinghouse; James Davenport of the National Association of Counties; Jim Watson of the Tennessee Valley Authority; John Austin of the U.S. Agency for International Development; Pat Fleming of the U.S. Bureau of Land Management; James Jacobsen of the Maine Department of Human Services; Richard Barror of the Indian Health Service; Glendon Deal of the U.S. Department of Agriculture; Lisa Knerr, Jonathan Simpson, and Kay Rutledge of Tetra Tech; Kenneth Pankow of Pankow Engineering; Linda Stein of Eastern Research Group; Robert Adler, Charles Pycha, Calvin Terada, and Jonathon Williams of USEPA Region 10; Richard Carr of the World Health Organization; Ralph Benson of the Clermont County, Ohio, General Health District; Rich Piluk of the Anne Arundel, Maryland, county government; Jerry Nonogawa of the Hawaii Department of Health; Tony Smithson of the Lake County, Illinois, Health Department; Conrad G. Keyes, Jr., and Cecil Lue-Hing of the EWRI of ASCE; Robert E. Lee of the National Onsite Wastewater Recycling Association; Anish Jantrania, private consultant; Larry Stephens of Stephens Consultants; Bruce Douglass and Bill Heigis of Stone Engineering; Alan Hassett of Oak Hill Co.; Steven Braband of Biosolutions, Inc.; Matt Byers of Zoeller Co.; Carl Thompson, Infiltrator Systems, Inc.; Alex Mauck of EZ Drain; Bob Mayer of American Manufacturing; Rodney Ruskin of Geoflow; Fred Harned of Netafim; Don Canada of the American Decentralized Wastewater Association, and Michael Price, Norweco, Inc.

Graphics in the manual were provided by John Mori of the National Small Flows Clearinghouse, Ayres Associates, and other sources. Regina Scheibner, Emily Faalasli, Krista Carlson, Monica Morrison, Liz Hiatt, and Kathryn Phillips of Tetra Tech handled layout and production; Martha Martin of Tetra Tech edited the manual. The cover was produced by the National Small Flows Clearinghouse.



## Review Team Members for the Onsite Wastewater Treatment Systems Manual

Robert Goo, USEPA, Office of Wetlands (OW), Oceans and Watersheds

Rod Frederick, USEPA, OW, Oceans and Watersheds

Eric Slaughter, USEPA, OW, Oceans and Watersheds

Jim Kreissl, USEPA, Office of Research and Development (ORD)

Don Brown, USEPA, ORD

Robert Bastian, USEPA, Office of Wastewater Management (OWM)

Charlie Vanderlyn, USEPA, OWM

Steve Hogue, USEPA, OWM

Joyce Hudson, USEPA, OWM

Joel Salter, USEPA, Office of Science and Technology

Philip Berger, USEPA, Office of Ground Water and Drinking Water (OGWDW)

Howard Beard, USEPA, OGWDW

Robert Adler, USEPA Region 1

Charles Pycha, USEPA Region 5

Ernesto Perez, USEPA Region 6

Calvin Terada, USEPA Region 10

Danny Averett, U.S. Army Corps of Engineers

Ed Smith, USACE Research Laboratory

Rick Scholz, USACE Research Laboratory

John Austin, U.S. Agency for International Development

Patrick Fleming, National Park Service

Rick Barror, U.S. Public Health Service

Gary Morgan, USDA Rural Development Administration

Andree Duvarney, USDA Natural Resources Conservation Service

Phil Mummert, Tennessee Valley Authority

Raymond Reid, Pan American Health Organization

Homero Silva, Organización Mundial de la Salud, Costa Rica

Dennis Warner, World Health Organization

Tom Groves, New England Interstate Water Pollution Control Commission

Paul Chase, DuPage County (Illinois) Health Department

Douglas Ebelherr, Illinois Department of Public Health

Randy Clarkson, Missouri Department of Natural Resources

Anish Janrania, Virginia Department of Health

Steve Steinbeck, North Carolina Department of Health and Natural Resources

Ron Frey, Arizona Department of Environmental Quality

Mark Soltman, Washington State Department of Health

Alex Campbell, Ontario Ministry of Environment and Approvals

Jerry Tyler, University of Wisconsin

Mike Hoover, North Carolina State University

Ruth Alfasso, Massachusetts Department of Environmental Protection

Jerry Nunogawa, Hawaii Department of Health

Robert Siegrist, Colorado School of Mines

Rick Piluk, Anne Arundel County (Maryland) Health Department

Gary Eckler, Erie County (Ohio) Sanitary Engineering Department

Janet Rickabaugh, Clermont County (Ohio) Health District

Jay Harrell, Mohave County (Arizona) Environmental Health Division

Dan Smith, Coconino County (Arizona) Environmental Health Services

Tom Yeager, Kennedy/Jenks Consultants

Richard Otis, Ayres Associates

Robert Mayer, American Manufacturing Co.

Hamilton Brown, National Association of Towns and Townships

Larry Markham, National Environmental Health Association

Robert Rubin, Water Environment Federation

Thomas McLane, American Society of Civil Engineers

Dan MacRitchie, American Society of Civil Engineers

Don Canada, American Decentralized Wastewater Association

Naomi Friedman, National Association of Counties

Peter Casey, National Small Flows Clearinghouse

Tricia Angoli, national Small Flows Clearinghouse

Thomas Bruursema, National Sanitation Foundation



## Introduction

### Background and Purpose

The U.S. Environmental Protection Agency (USEPA) first issued detailed guidance on the design, construction, and operation of onsite wastewater treatment systems (OWTSs) in 1980. *Design Manual: Onsite Wastewater Treatment and Disposal Systems* (USEPA, 1980) was the most comprehensive summary of onsite wastewater management since the U.S. Public Health Service had published a guidance on septic tank practice in 1967 (USPHS, 1967). The 1980 manual focused on both treatment and “disposal” of wastewater in general accordance with the approach and terminology in use at the time. The 1980 design manual stressed the importance of site-specific soil, landscape, ground water, and effluent characterization and included soil percolation tests as one of several site evaluation tools to be used in system design and placement. The manual’s discussion of water conservation to reduce hydraulic flows, pollutant reduction to minimize contaminant loading, and management programs to oversee the full range of treatment activities was especially important to the developing field of onsite wastewater treatment in the United States and other countries.

Technologies explored in the 1980 manual include the conventional system (a septic tank with a subsurface wastewater infiltration system), alternating leach fields, uniform distribution systems, intermittent sand filters, aerobic units, disinfection technologies, and evapotranspiration systems. The original manual also contains guidance on dosing chambers, flow diversion methods for alternating beds, nutrient removal, and disposal of residuals. Although much of that information is still useful, advances in regional planning, improvements in ground water and surface water protection, and new technologies and management concepts necessitate further guidance for public health districts, water quality agencies, planning boards, and other audiences. In addition, the growing national emphasis on management programs that establish performance requirements rather than prescriptive codes for the design, siting, installation, operation, and maintenance of onsite systems underscores the importance of revising the manual to

address these emerging issues in public health and water resource protection.

USEPA is committed to elevating the standards for onsite wastewater management practice and removing barriers that preclude widespread acceptance of onsite treatment technologies. The purpose of this update of the 1980 manual is to provide more comprehensive information on management approaches, update information on treatment technologies, and describe the benefits of performance-based approaches to system design. The management approaches suggested in this manual involve coordinating onsite system planning and management activities with land use planning and watershed protection efforts to ensure that the impacts of onsite wastewater systems are considered and controlled at the appropriate scale. The management approaches described in this manual support and are consistent with USEPA’s draft *Guidelines for Management of Onsite/Decentralized Wastewater Systems* (USEPA, 2000). The incorporation of performance standards for management programs and for system design and operation can help ensure that no onsite system alternative presents an unacceptable risk to public health or water resources.

This manual contains overview information on treatment technologies, installation practices, and past performance. It does not, however, provide detailed design information and is not intended as a substitute for region- and site-specific program criteria and standards that address conditions, technologies, and practices appropriate to each individual management jurisdiction. The information in the following chapters provides an operational framework for developing and improving OWTS program structure, criteria, alternative designs, and performance requirements. The chapters describe the importance of planning to ensure that system densities are appropriate for prevailing hydrologic and geologic conditions, performance requirements to guide system design, wastewater characterization to accurately predict waste strength and flows, site evaluations that identify appropriate design and performance boundaries, technology selection to

ensure that performance requirements are met, and management activities that govern installation, operation, maintenance, and remediation of failed systems.

This manual is intended to serve as a technical guidance for those involved in the design, construction, operation, maintenance, and regulation of onsite systems. It is also intended to provide information to policy makers and regulators at the state, tribal, and local levels who are charged with responsibility for developing, administering, and enforcing wastewater treatment and management program codes. The activities and functions described herein might also be useful to other public health and natural resource protection programs. For example, properly planned, designed, installed, operated, and maintained onsite systems protect wellhead recharge areas, drinking water sources, watershed, estuaries, coastal zones, aquatic habitat, and wetlands.

Finally, this manual is intended to emphasize the need to improve cooperation and coordination among the various health, planning, zoning, development, utility, and resource protection programs operated by public and private organizations. A watershed approach to protecting public health and environmental resources requires an integrated operational framework that encourages independent partners to function cooperatively while each retains the ability to satisfy internal programmatic and management objectives. Integrating onsite wastewater management processes with other activities conducted by public and private entities can improve both the effectiveness and the efficiency of efforts to minimize the risk onsite systems might present to health and ecological resources.

## **Overview**

Onsite wastewater treatment systems collect, treat, and release about 4 billion gallons of treated effluent per day from an estimated 26 million homes, businesses, and recreational facilities nationwide (U.S. Census Bureau, 1997). These systems, defined in this manual as those serving fewer than 20 people, include treatment units for both individual buildings and small clusters of buildings connected to a common treatment system. Recognition of the impacts of onsite systems on ground water and surface water quality (e.g., nitrate and bacteria contamination, nutrient inputs to surface waters) has increased interest in optimizing the systems' performance. Public health and environmental protection officials now acknowledge that onsite systems are not just

temporary installations that will be replaced eventually by centralized sewage treatment services, but permanent approaches to treating wastewater for release and reuse in the environment. Onsite systems are recognized as potentially viable, low-cost, long-term, decentralized approaches to wastewater treatment if they are planned, designed, installed, operated, and maintained properly (USEPA, 1997). NOTE: In addition to existing state and local oversight, decentralized wastewater treatment systems that serve more than 20 people might become subject to regulation under the USEPA's Underground Injection Control Program, although EPA has proposed not to include them (64FR22971:5/7/01).

Although some onsite wastewater management programs have functioned successfully in the past, problems persist. Most current onsite regulatory programs focus on permitting and installation.

Few programs address onsite system operation and maintenance, resulting in failures that lead to unnecessary costs and risks to public health and water resources. Moreover, the lack of coordination among agencies that oversee land use planning, zoning, development, water resource protection, public health initiatives, and onsite systems causes problems that could be prevented through a more cooperative approach. Effective management of onsite systems requires rigorous planning, design, installation, operation, maintenance, monitoring, and controls.

## **Public health and water resource impacts**

State and tribal agencies report that onsite septic systems currently constitute the third most common source of ground water contamination and that these systems have failed because of inappropriate siting or design or inadequate long-term maintenance (USEPA, 1996a). In the 1996 Clean Water Needs Survey (USEPA, 1996b), states and tribes also identified more than 500 communities as having failed septic systems that have caused public health problems. The discharge of partially treated sewage from malfunctioning onsite systems was identified as a principal or contributing source of degradation in 32 percent of all harvest-limited shellfish growing areas. Onsite wastewater treatment systems have also contributed to an overabundance of nutrients in ponds, lakes, and coastal estuaries, leading to the excessive growth of algae and other nuisance aquatic plants (USEPA, 1996b). In addition, onsite systems contribute to contamination of drinking water sources. USEPA estimates that 168,000 viral illnesses and 34,000 bacterial illnesses occur each year as a result of con-

sumption of drinking water from systems that rely on improperly treated ground water. Malfunctioning septic systems have been identified as one potential source of ground water contamination (USEPA, 2000).

### **Improving treatment through performance requirements**

Most onsite wastewater treatment systems are of the conventional type, consisting of a septic tank and a subsurface wastewater infiltration system (SWIS). Site limitations and more stringent performance requirements have led to significant improvements in the design of wastewater treatment systems and how they are managed. Over the past 20 years the OWTS industry has developed many new treatment technologies that can achieve high performance levels on sites with size, soil, ground water, and landscape limitations that might preclude installing conventional systems. New technologies and improvements to existing technologies are based on defining the performance requirements of the system, characterizing wastewater flow and pollutant loads, evaluating site conditions, defining performance and design boundaries, and selecting a system design that addresses these factors.

Performance requirements can be expressed as numeric criteria (e.g., pollutant concentration or mass loading limits) or narrative criteria (e.g., no odors or visible sheen) and are based on the assimilative capacity of regional ground water or surface waters, water quality objectives, and public health goals. Wastewater flow and pollutant content help define system design and size and can be estimated by comparing the size and type of facility with measured effluent outputs from similar, existing facilities. Site evaluations integrate detailed analyses of regional hydrology, geology, and water resources with site-specific characterization of soils, slopes, structures, property lines, and other site features to further define system design requirements and determine the physical placement of system components.

Most of the alternative treatment technologies applied today treat wastes after they exit the septic tank; the tank retains settleable solids, grease, and oils and provides an environment for partial digestion of settled organic wastes. Post-tank treatment can include aerobic (with oxygen) or anaerobic (with no or low oxygen) biological treatment in suspended or fixed-film reactors, physical/chemical treatment, soil infiltration, fixed-media filtration, and/or disinfection. The application and sizing of treatment units based on these technologies are defined by perfor-

mance requirements, wastewater characteristics, and site conditions.

### **Toward a more comprehensive approach**

The principles of the 1980 onsite system design manual have withstood the test of time, but much has changed over the past 20 years. This manual incorporates much of the earlier guide but includes new information on treatment technologies, site evaluation, design boundary characterization, and especially management program functions. The manual is organized by functional topics and is intended to be a comprehensive reference. Users can proceed directly to relevant sections or review background or other information (see Contents).

Although this manual focuses on individual and small, clustered onsite systems, state and tribal governments and other management entities can use the information in it to construct a framework for managing new and existing large-capacity decentralized systems (those serving more than 20 people), subject to regulation under state or local Underground Injection Control (UIC) programs. The UIC program was established by the Safe Drinking Water Act to protect underground sources of drinking water from contamination caused by the underground injection of wastes. In most parts of the nation, the UIC program, which also deals with motor vehicle waste disposal wells, large-capacity cesspools, and storm water drainage wells, is managed by state or tribal water or waste agencies with authority delegated by USEPA.

The Class V UIC program and the Source Water Protection Program established by the 1996 amendments to the federal Safe Drinking Water Act are bringing federal and state drinking water agencies into the field of onsite wastewater treatment and management. Both programs will likely require more interagency involvement and cooperation to characterize wastewater impacts on ground water resources and to develop approaches to deal with real or potential problems. States currently have permit-by-rule provisions for large-capacity septic systems.

### **Overview of the revised manual**

The first two chapters of this manual present overview and management information of special interest to program administrators. Chapters 3, 4, and 5 contain technical information on wastewater characterization, site evaluation and selection, and treatment technologies and how to use them in develop-

ing a system design. Those three chapters are intended primarily for engineers, soil scientists, permit writers, environmental health specialists, site evaluators, and field staff. Summaries of all the chapters appear below. The level of detail provided in this manual is adequate for preliminary

system design and development of a management program. References are provided for additional research and information on how to incorporate local characteristics into an optimal onsite management program.

### **Overview of the Onsite Wastewater Treatment Systems Manual**

Chapter 1, Background and use of onsite wastewater treatment systems	Review of the history and current use of onsite treatment systems, introduction of management concepts, and brief discussion of alternative technologies.
Chapter 2, Management and regulation of onsite wastewater treatment systems	Discussion of methods to plan, institutionalize, and manage OWTS programs, including both prescriptive and performance-based approaches. If prescriptive-based management programs are used, parts of this chapter will not apply because the basic functions of prescriptive-based management are more simplified.
Chapter 3, Establishing treatment system performance requirements	Discussion of methods for estimating wastewater flow and composition, identifying pollutants of concern and their transport and fate in the environment, establishing performance requirements, and estimating watershed-scale impacts.
Chapter 4, Treatment processes and systems	Identification of conventional and alternative OWTS technologies, pollutant removal effectiveness, design parameters, operation and maintenance requirements, costs, and special issues.
Chapter 5, Treatment system selection	Discussion of strategies for establishing site-specific performance requirements and performance boundaries based on wastewater flow and composition and site characteristics, selection of treatment alternatives, and analysis of system failure and repair or replacement alternatives.
Glossary	Definitions of terms used in the manual.
Resources	Selected reference documents and Internet resources.

# Chapter 1:

## Background and use of onsite wastewater treatment systems

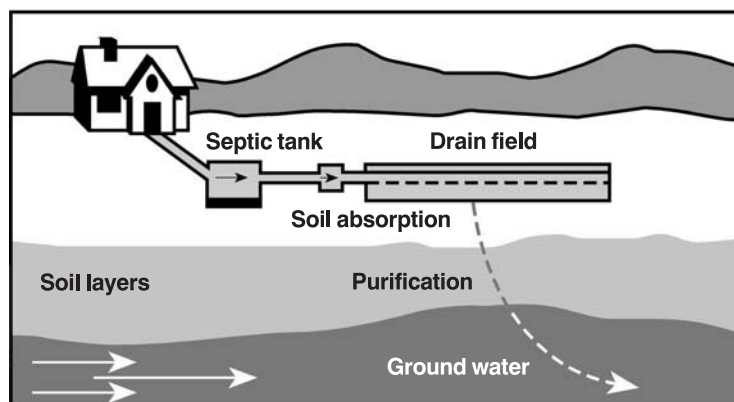
- 1.1 Introduction
- 1.2 History of onsite wastewater treatment systems
- 1.3 Regulation of onsite wastewater treatment systems
- 1.4 Onsite wastewater treatment system use, distribution, and failure rate
- 1.5 Problems with existing onsite wastewater management programs
- 1.6 Performance-based management of onsite wastewater treatment systems
- 1.7 Coordinating onsite system management with watershed protection efforts
- 1.8 USEPA initiatives to improve onsite system treatment and management
- 1.9 Other initiatives to assist and improve onsite management efforts

### 1.1 Introduction

Onsite wastewater treatment systems (OWTSs) have evolved from the pit privies used widely throughout history to installations capable of producing a disinfected effluent that is fit for human consumption. Although achieving such a level of effluent quality is seldom necessary, the ability of onsite systems to remove settleable solids, floatable grease and scum, nutrients, and pathogens from wastewater discharges defines their importance in protecting human health and environmental resources. In the modern era, the typical onsite system has consisted primarily of a septic tank and a soil absorption field, also known as a subsurface wastewater infiltration system, or SWIS (figure 1-1). In this manual, such systems are referred to as *conventional systems*. Septic tanks remove most settleable and floatable material and function as an anaerobic bioreactor that promotes partial digestion of retained organic matter. Septic tank effluent, which contains significant concentrations of pathogens and nutrients, has traditionally been discharged to soil, sand, or other media absorption fields (SWISs) for further treatment through biological processes, adsorption, filtration, and infiltration into underlying soils. Conventional systems work well if they are installed in areas with appropriate soils and hydraulic capacities; designed to treat the incoming waste load to meet public health, ground water, and surface water performance standards; installed properly; and maintained to ensure long-term performance.

These criteria, however, are often not met. Only about one-third of the land area in the United States has soils suited for conventional subsurface soil absorption fields. System densities in some areas exceed the capacity of even suitable soils to assimilate wastewater flows and retain and transform their contaminants. In addition, many systems are located too close to ground water or surface waters and others, particularly in rural areas with newly installed public water lines, are not designed to handle increasing wastewater flows. Conventional onsite system installations might not be adequate for minimizing nitrate contamination of ground water, removing phosphorus compounds, and attenuating pathogenic organisms (e.g., bacteria, viruses). Nitrates that leach into ground

Figure 1-1. Conventional onsite wastewater treatment system



Source: NSFC, 2000.



water used as a drinking water source can cause methemoglobinemia, or blue baby syndrome, and other health problems for pregnant women. Nitrates and phosphorus discharged into surface waters directly or through subsurface flows can spur algal growth and lead to eutrophication and low dissolved oxygen in lakes, rivers, and coastal areas. In addition, pathogens reaching ground water or surface waters can cause human disease through direct consumption, recreational contact, or ingestion of contaminated shellfish. Sewage might also affect public health as it backs up into residences or commercial establishments because of OWTS failure.

Nationally, states and tribes have reported in their 1998 Clean Water Act section 303(d) reports that designated uses (e.g., drinking water, aquatic habitat) are not being met for 5,281 waterbodies because of pathogens and that 4,773 waterbodies are impaired by nutrients. Onsite systems are one of many known contributors of pathogens and nutrients to surface and ground waters. Onsite wastewater systems have also contributed to an overabundance of nutrients in ponds, lakes, and coastal estuaries, leading to overgrowth of algae and other nuisance aquatic plants.

Threats to public health and water resources (table 1-1) underscore the importance of instituting management programs with the authority and resources to oversee the full range of onsite system activities—planning, siting, design, installation, operation, monitoring, and maintenance. EPA has issued draft *Guidelines for Management of Onsite/Decentralized Wastewater Systems* (USEPA, 2000)

to improve overall management of OWTSs. These guidelines are discussed in more detail in chapter 2.

## 1.2 History of onsite wastewater treatment systems

King Minos installed the first known water closet with a flushing device in the Knossos Palace in Crete in 1700 BC. In the intervening 3,700 years, societies and the governments that serve them have sought to improve both the removal of human wastes from indoor areas and the treatment of that waste to reduce threats to public health and ecological resources. The Greeks, Romans, British, and French achieved considerable progress in waste removal during the period from 800 BC to AD 1850, but removal often meant discharge to surface waters; severe contamination of lakes, rivers, streams, and coastal areas; and frequent outbreaks of diseases like cholera and typhoid fever.

By the late 1800s, the Massachusetts State Board of Health and other state health agencies had documented links between disease and poorly treated sewage and recommended treatment of wastewater through intermittent sand filtration and land application of the resulting sludge. The past century has witnessed an explosion in sewage treatment technology and widespread adoption of centralized wastewater collection and treatment services in the United States and throughout the world. Although broad uses of these systems have vastly improved public health and water quality in urban areas, homes and businesses without centralized collection and treatment systems often con-

Table 1-1. Typical pollutants of concern in effluent from onsite wastewater treatment systems

Pollutant	Public health or water resource impacts
Pathogens	Parasites, bacteria, and viruses can cause communicable diseases through direct or indirect body contact or ingestion of contaminated water or shellfish. Pathogens can be transported for significant distances in ground water or surface waters.
Nitrogen	Nitrogen is an aquatic plant nutrient that can contribute to eutrophication and dissolved oxygen loss in surface waters, especially in nitrogen-limited lakes, estuaries, and coastal embayments. Algae and aquatic weeds can contribute trihalomethane (THM) precursors to the water column that might generate carcinogenic THMs in chlorinated drinking water. Excessive nitrate-nitrogen in drinking water can cause methemoglobinemia in infants and pregnancy complications.
Phosphorus	Phosphorus is an aquatic plant nutrient that can contribute to eutrophication of phosphorus-limited inland surface waters. High algal and aquatic plant production during eutrophication is often accompanied by increases in populations of decomposer bacteria and reduced dissolved oxygen levels for fish and other organisms.

tinue to depend on technologies developed more than 100 years ago. Septic tanks for primary treatment of wastewater appeared in the late 1800s, and discharge of tank effluent into gravel-lined subsurface drains became common practice during the middle of the 20<sup>th</sup> century (Kreissl, 2000).

Scientists, engineers, and manufacturers in the wastewater treatment industry have developed a wide range of alternative technologies designed to address increasing hydraulic loads and water contamination by nutrients and pathogens. These technologies can achieve significant pollutant removal rates. With proper management oversight, alternative systems (e.g., recirculating sand filters, peat-based systems, package aeration units) can be installed in areas where soils, bedrock, fluctuating ground water levels, or lot sizes limit the use of conventional systems. Alternative technologies typically are applied to the treatment train beyond the septic tank (figure 1-2). The tank is designed to equalize hydraulic flows; retain oils, grease, and settled solids; and provide some minimal anaerobic digestion of settleable organic matter. Alternative treatment technologies often provide environments (e.g., sand, peat, artificial media) that promote additional biological treatment and remove pollutants through filtration, absorption, and adsorption. All of the alternative treatment technologies in current use require more intensive management and monitoring than conventional OWTs because of mechanical components, addi-

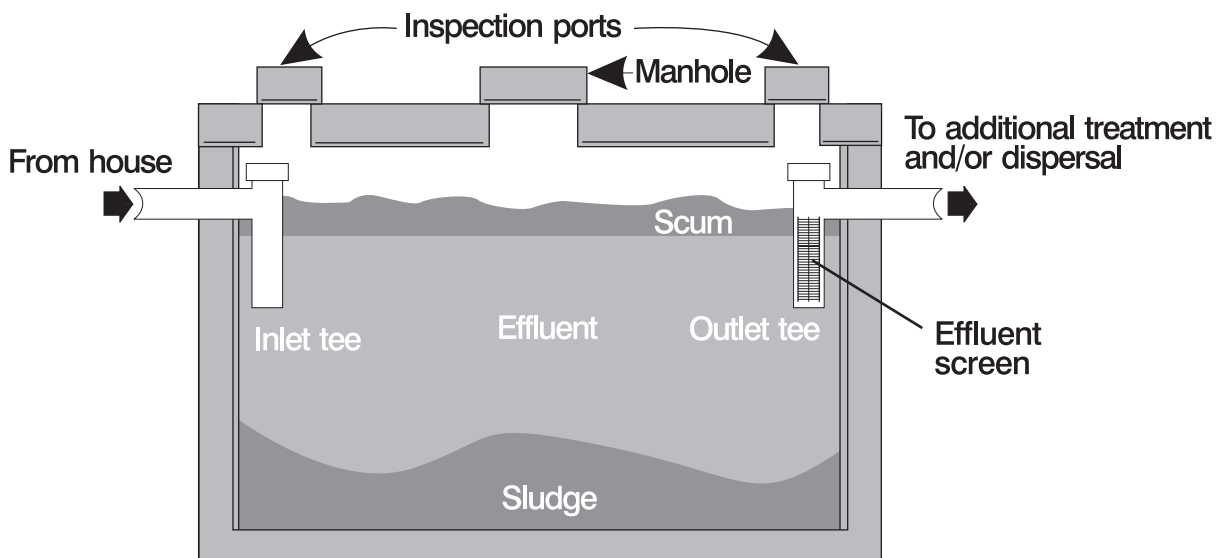
tional residuals generated, and process sensitivities (e.g., to wastewater strength or hydraulic loading).

Replacing gravity-flow subsurface soil infiltration beds with better-performing alternative distribution technologies can require float-switched pumps and/or valves. As noted in chapter 4, specialized excavation or structures might be required to house some treatment system components, including the disinfection devices (e.g., chlorinators, ultraviolet lamps) used by some systems. In addition, it is often both efficient and effective to collect and treat septic tank effluent from clusters of individual sources through a community or cluster system driven by gravity, pressure, or vacuum. These devices also require specialized design, operation, and maintenance and enhanced management oversight.

### 1.3 Regulation of onsite wastewater treatment systems

Public health departments were charged with enforcing the first onsite wastewater “disposal” laws, which were mostly based on soil percolation tests, local practices, and past experience. Early codes did not consider the complex interrelationships among soil conditions, wastewater characteristics, biological mechanisms, and climate and

Figure 1-2. Typical single-compartment septic tank with at-grade inspection ports and effluent screen



Source: NSFC, 2000.

prescribed standard designs sometimes copied from jurisdictions in vastly different geoclimatic regions. In addition, these laws often depended on minimally trained personnel to oversee design, permitting, and installation and mostly untrained, uninformed homeowners to operate and maintain the systems. During the 1950s states began to adopt laws upgrading onsite system design and installation practices to ensure proper functioning and eliminate the threats posed by waterborne pathogens (Kreissl, 1982). Despite these improvements, many regulations have not considered cumulative ground water and surface water impacts, especially in areas with high system densities and significant wastewater discharges.

Kreissl (1982) and Plews (1977) examined changes in state onsite wastewater treatment regulations prompted by the publication of the first U.S. Public Health Service *Manual of Septic-Tank Practice* in 1959. Plews found significant code revisions under way by the late 1970s, mostly because of local experience, new research information, and the need to accommodate housing in areas not suited for conventional soil infiltration systems. Kreissl found that states were gradually increasing required septic tank and drainfield sizes but also noted that 32 states were still specifying use of the percolation test in system sizing in 1980, despite its proven shortcomings. Other differences noted among state codes included separation distances between the infiltration trench bottom and seasonal ground water tables, minimum trench widths, horizontal setbacks to potable water supplies, and maximum allowable land slopes (Kreissl, 1982).

Although state lawmakers have continued to revise onsite system codes, most revisions have failed to address the fundamental issue of system performance in the context of risk management for both a site and the region in which it is located. Prescribed system designs require that site conditions fit system capabilities rather than the reverse and are sometimes incorrectly based on the assumption that centralized wastewater collection and treatment services will be available in the future. Codes that emphasize prescriptive standards based on empirical relationships and hydraulic performance do not necessarily protect ground water and surface water resources from public health threats. Devising a new regime for protecting public health and the environment in a cost-effective manner will require increased focus on system performance, pollutant

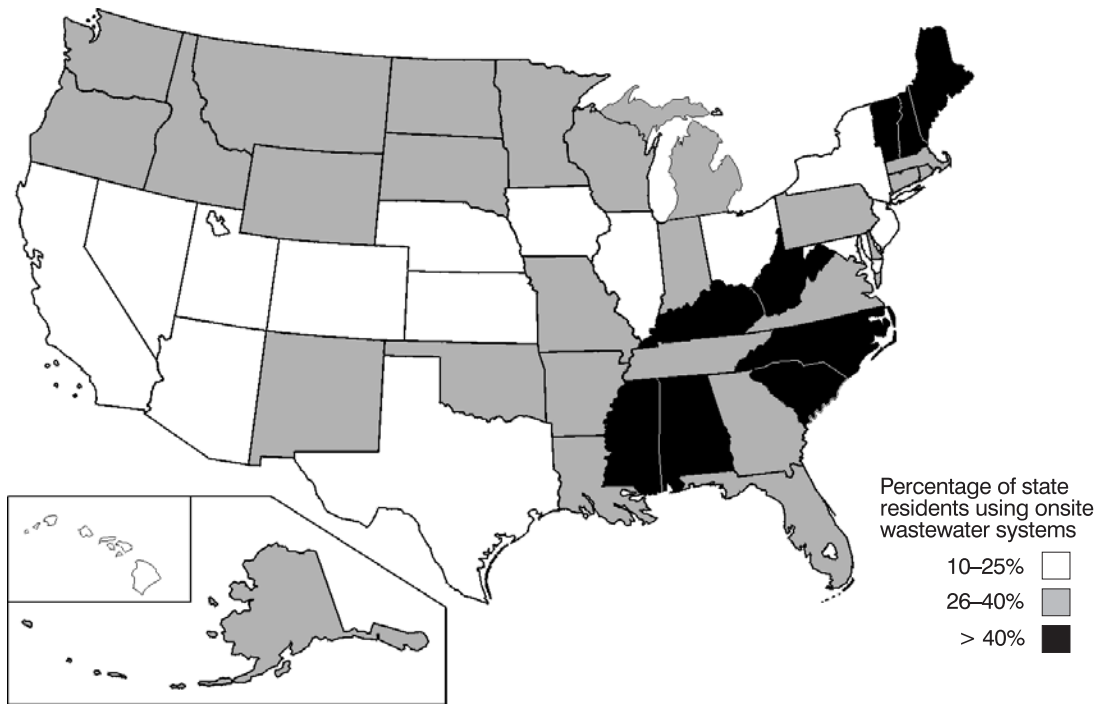
transport and fate and resulting environmental impacts, and integration of the planning, design, siting, installation, maintenance, and management functions to achieve public health and environmental objectives.

### 1.4 Onsite wastewater treatment system use, distribution, and failure rate

According to the U.S. Census Bureau (1999), approximately 23 percent of the estimated 115 million occupied homes in the United States are served by onsite systems, a proportion that has changed little since 1970. As shown in figure 1-3 and table 1-2, the distribution and density of homes with OWTs vary widely by state, with a high of about 55 percent in Vermont and a low of around 10 percent in California (U.S. Census Bureau, 1990). New England states have the highest proportion of homes served by onsite systems: New Hampshire and Maine both report that about half of all homes are served by individual wastewater treatment systems. More than a third of the homes in the southeastern states depend on these systems, including approximately 48 percent in North Carolina and about 40 percent in both Kentucky and South Carolina. More than 60 million people depend on decentralized systems, including the residents of about one-third of new homes and more than half of all mobile homes nationwide (U.S. Census Bureau, 1999). Some communities rely completely on OWTs.

A number of systems relying on outdated and underperforming technologies (e.g., cesspools, drywells) still exist, and many of them are listed among failed systems. Moreover, about half of the occupied homes with onsite treatment systems are more than 30 years old (U.S. Census Bureau, 1997), and a significant number report system problems. A survey conducted by the U.S. Census Bureau (1997) estimated that 403,000 homes experienced septic system breakdowns within a 3-month period during 1997; 31,000 reported four or more breakdowns at the same home. Studies reviewed by USEPA cite failure rates ranging from 10 to 20 percent (USEPA, 2000). System failure surveys typically do not include systems that might be contaminating surface or ground water, a situation that often is detectable only through site-





**Figure 1-3. Onsite treatment system distribution in the United States**

level monitoring. Figure 1-4 demonstrates ways that effluent water from a septic system can reach ground water or surface waters.

Comprehensive data to measure the true extent of septic system failure are not currently collected by any single organization. Although estimates of system failure rates have been collected from 28 states (table 1-3), no state had directly measured its own failure rate and definitions of failure vary (Nelson et al., 1999). Most available data are the result of incidents that directly affect public health or are obtained from homeowners' applications for permits to replace or repair failing systems. The 20 percent failure rate from the Massachusetts time-of-transfer inspection program is based on an inspection of each septic system prior to home sale, which is a comprehensive data collection effort. However, the Massachusetts program only identifies failures according to code and does not track ground water contamination that may result from onsite system failures.

In addition to failures due to age and hydraulic overloading, OWTs can fail because of design, installation, and maintenance problems. Hydraulically functioning systems can create health and

ecological risks when multiple treatment units are installed at densities that exceed the capacity of local soils to assimilate pollutant loads. System owners are not likely to repair or replace aging or otherwise failing systems unless sewage backup, septage pooling on lawns, or targeted monitoring that identifies health risks occurs. Because ground and surface water contamination by onsite systems has rarely been confirmed through targeted monitoring, total failure rates and onsite system impacts over time are likely to be significantly higher than historical statistics indicate. For example, the Chesapeake Bay Program found that 55 to 85 percent of the nitrogen entering an onsite system can be discharged into ground water (USEPA, 1993). A 1991 study concluded that conventional systems accounted for 74 percent of the nitrogen entering Buttermilk Bay in Massachusetts (USEPA, 1993).

## 1.5 Problems with existing onsite wastewater management programs

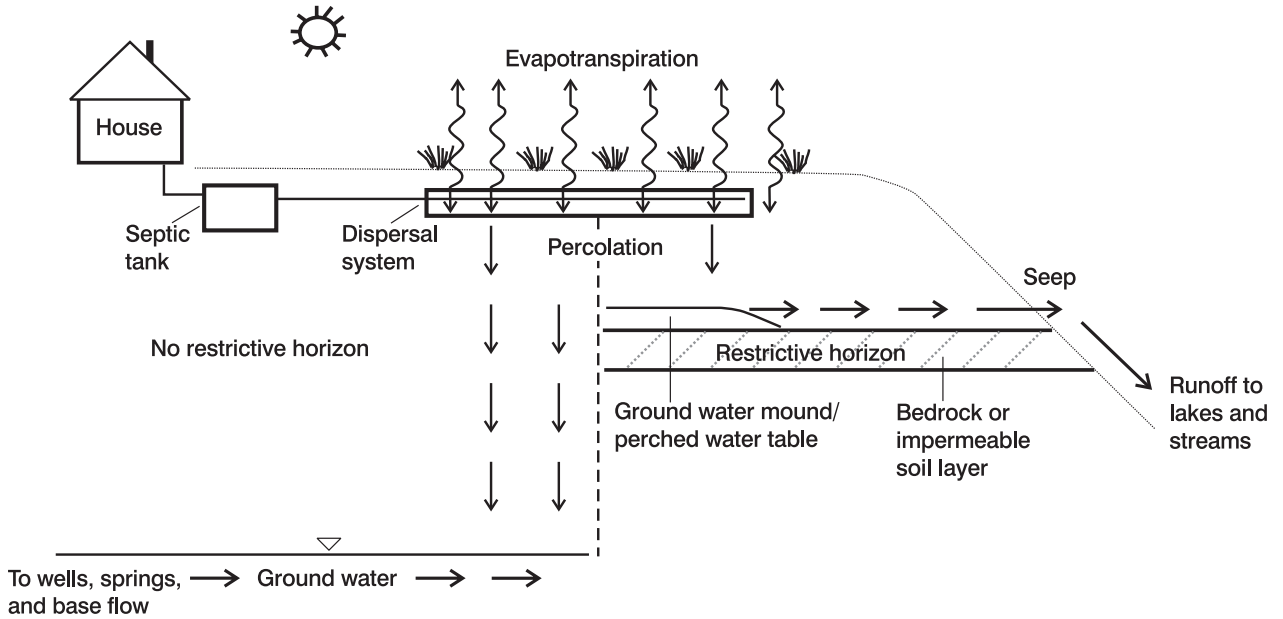
Under a typical conventional system management approach, untrained and often uninformed system owners assume responsibility for operating and

**Table 1-2. Census of housing tables: sewage disposal, 1990**

	Public sewer		Septic tank or cesspool		Other means	
	Number	Percent	Number	Percent	Number	Percent
United States	76,455,211	74.8	24,670,877	24.1	1,137,590	1.1
Alabama	910,782	54.5	728,690	43.6	30,907	1.9
Alaska	144,905	62.3	59,886	25.7	27,817	12.0
Arizona	1,348,836	81.3	282,897	17.0	27,697	1.7
Arkansas	601,188	60.1	382,467	38.2	17,012	1.7
California	10,022,843	89.6	1,092,174	9.8	67,865	0.6
Colorado	1,283,186	86.9	183,817	12.4	10,346	0.7
Connecticut	935,541	70.8	378,382	28.6	6,927	0.5
Delaware	212,793	73.4	74,541	25.7	2,585	0.9
District of Columbia	276,481	99.3	575	0.2	1,433	0.5
Florida	4,499,793	73.8	1,559,113	25.6	41,356	0.7
Georgia	1,638,979	62.1	970,686	36.8	28,753	1.1
Hawaii	312,812	80.2	72,940	18.7	4,058	1.0
Idaho	264,618	64.0	142,879	34.6	5,830	1.4
Illinois	3,885,689	86.2	598,125	13.3	22,461	0.5
Indiana	1,525,810	67.9	703,032	31.3	17,204	0.8
Iowa	869,056	76.0	264,889	23.2	9,724	0.9
Kansas	847,767	81.2	187,398	17.9	8,947	0.9
Kentucky	849,491	56.4	600,182	39.8	57,172	3.8
Louisiana	1,246,678	72.6	442,758	25.8	26,805	1.6
Maine	266,344	45.4	301,373	51.3	19,328	3.3
Maryland	1,533,799	81.1	342,523	18.1	15,595	0.8
Massachusetts	1,803,176	72.9	659,120	26.7	10,415	0.4
Michigan	2,724,408	70.8	1,090,481	28.3	33,037	0.9
Minnesota	1,356,520	73.4	467,936	25.3	23,989	1.3
Mississippi	585,185	57.9	387,406	38.3	37,832	3.7
Missouri	1,617,996	73.6	532,844	24.2	48,289	2.2
Montana	218,372	60.5	135,371	37.5	7,412	2.1
Nebraska	534,692	80.9	117,460	17.8	8,469	1.3
Nevada	456,107	87.9	60,508	11.7	2,243	0.4
New Hampshire	250,060	49.6	246,692	49.0	7,152	1.4
New Jersey	2,703,489	87.9	357,890	11.6	13,931	0.5
New Mexico	452,934	71.7	161,068	25.5	18,056	2.9
New York	5,716,917	79.1	1,460,873	20.2	49,101	0.7
North Carolina	1,403,033	49.8	1,365,632	48.5	49,528	1.8
North Dakota	204,328	73.9	66,479	24.1	5,533	2.0
Ohio	3,392,785	77.6	940,943	21.5	38,217	0.9
Oklahoma	1,028,594	73.1	367,197	26.1	10,708	0.8
Oregon	835,545	70.0	349,122	29.3	8,900	0.7
Pennsylvania	3,670,338	74.3	1,210,054	24.5	57,748	1.2
Rhode Island	293,901	70.9	118,410	28.6	2,261	0.5
South Carolina	825,754	58.0	578,129	40.6	20,272	1.4
South Dakota	207,996	71.1	78,435	26.8	6,005	2.1
Tennessee	1,213,934	59.9	781,616	38.6	30,517	1.5
Texas	5,690,550	81.2	1,266,713	18.1	51,736	0.7
Utah	528,864	88.4	65,403	10.9	4,121	0.7
Vermont	115,201	42.5	149,125	55.0	6,888	2.5
Virginia	1,740,787	69.7	707,409	28.3	48,138	1.9
Washington	1,387,396	68.3	630,646	31.0	14,336	0.7
West Virginia	427,930	54.8	318,697	40.8	34,668	4.4
Wisconsin	1,440,024	70.0	580,836	28.3	34,914	1.7
Wyoming	151,004	74.2	49,055	24.1	3,352	1.6

Source: U.S. Census Bureau, 1990.

Figure 1-4. Fate of water discharged to onsite wastewater treatment systems.



Source: Adapted from Venhuizen, 1995.

Table 1-3. Estimated onsite treatment system failure rates in surveyed states

State	Estimated system failure rate (percentage)	Failure definition
Alabama	20	Not given
Arizona	0.5	Surfacing, backup, surface or ground water contamination
California	1-4	Surfacing, backup, surface or ground water contamination
Florida	1-2	Surfacing, backup, surface or ground water contamination
Georgia	1.7	Public hazard
Hawaii	15-35	Improper construction, overflow
Idaho	20	Backup, surface or ground water contamination
Kansas	10-15	Surfacing, nuisance conditions (for installations after 1980)
Louisiana	50	Not given
Maryland	1	Surfacing, surface or ground water contamination
Massachusetts	25	Public health
Minnesota	50-70	Cesspool, surfacing, inadequate soil layer, leaking
Missouri	30-50	Backup, surface or ground water contamination
Nebraska	40	Nonconforming system, water quality
New Hampshire	<5	Surfacing, backup
New Mexico	20	Surfacing
New York	4	Backup, surface or ground water contamination
North Carolina	15-20	Not given
North Dakota	28	Backup, surfacing
Ohio	25-30	Backup, surfacing
Oklahoma	5-10	Backup, surfacing, discharge off property
Rhode Island	25	Not given
South Carolina	6-7	Backup, surface or ground water contamination
Texas	10-15	Surfacing, surface or ground water contamination
Utah	0.5	Surfacing, backup, exceed discharge standards
Washington	33	Public health hazard
West Virginia	60	Backup, surface or ground water contamination
Wyoming	0.4	Backup, surfacing, ground water contamination

<sup>a</sup> Failure rates are estimated and vary with the definition of failure.

Source: Nelson et al., 1999.

maintaining their relatively simple, gravity-based systems. Performance results under this approach can vary significantly, with operation and maintenance functions driven mostly by complaints or failures. In fact, many conventional system failures have been linked to operation and maintenance failures. Typical causes of failure include unpumped and sludge-filled tanks, which result in clogged absorption fields, and hydraulic overloading caused by increased occupancy and greater water use following the installation of new water lines to replace wells and cisterns. Full-time or high use of vacation homes served by systems installed under outdated practices or designed for part-time occupancy can cause water quality problems in lakes, coastal bays, and estuaries. Landscape modification, alteration of the infiltration field surface, or the use of outdated technologies like drywells and cesspools can also cause contamination problems.

Newer or “alternative” onsite treatment technologies are more complex than conventional systems and incorporate pumps, recirculation piping, aeration, and other features (e.g., greater generation of residuals) that require ongoing or periodic monitoring and maintenance. However, the current management programs of most jurisdictions do not typically oversee routine operation and maintenance activities or detect and respond to changes in wastewater loads that can overwhelm a system. In addition, in many cases onsite system planning and siting functions are not linked to larger ground water and watershed protection programs. The challenge for onsite treatment regulators in the new millennium will be to improve traditional health-based programs for ground water and surface water protection while embracing a vigorous role in protecting and restoring the nation’s watersheds.

The challenge is significant. Shortcomings in many management programs have resulted in poor system performance, public health threats, degradation of surface and ground waters, property value declines, and negative public perceptions of onsite treatment as an effective wastewater management option. (See examples in section 1.1.) USEPA (1987) has identified a number of critical problems associated with programs that lack a comprehensive management program:

- Failure to adequately consider site-specific environmental conditions.

- Codes that thwart adaptation to difficult local site conditions and are unable to accommodate effective innovative and alternative technologies.
- Ineffective or nonexistent public education and training programs.
- Failure to include conservation and potential reuse of water.
- Ineffective controls on operation and maintenance of systems, including residuals (septage, sludge).
- Failure to consider the special characteristics and requirements of commercial, industrial, and large residential systems.
- Weak compliance and enforcement programs.
- These problems can be grouped into three primary areas: (1) insufficient funding and public involvement; (2) inappropriate system design and selection processes; and (3) poor inspection, monitoring, and program evaluation components. Management programs that do not address these problems can directly and indirectly contribute to significant human health risks and environmental degradation.

### 1.5.1 Public involvement and education

Public involvement and education are critical to successful onsite wastewater management. Engaging the public in wastewater treatment issues helps build support for funding, regulatory initiatives, and other elements of a comprehensive program. Educational activities directed at increasing general awareness and knowledge of onsite management efforts can improve the probability that simple, routine operation and maintenance tasks (e.g., inspecting for pooled effluent, pumping the tank) are carried out by system owners. Specialized training is required for system managers responsible for operating and maintaining systems with more complex components. Even conventional, gravity-based systems require routine pumping, monitoring, and periodic inspection of sludge and scum buildup in septic tanks. Failing systems can cause public health risks and environmental damage and are expensive to repair. System owners should be made aware of the need for periodically removing tank sludge, maintaining system compo-

nents, and operating systems within their design limitations to help maximize treatment effectiveness and extend the life of the systems.

Information regarding regular inspections, pumping, ground water threats from chemicals, hydraulic overloading from roof runoff or other clear water sources, pollutant loads from garbage disposal units, drain field protection, and warning signs of failing systems can be easily communicated. Flyers, brochures, posters, news media articles, and other materials have proven effective in raising awareness and increasing public knowledge of onsite wastewater management issues (see Resources section). Meetings with stakeholders and elected officials and face-to-face training programs for homeowners can produce better results when actions to strengthen programs are required (USEPA, 1994). Public involvement and education programs are often overlooked because they require resources, careful planning, and management and can be labor-intensive. However, these efforts can pay rich dividends in building support for the management agency and improving system performance. Public education and periodic public input are also needed to obtain support for developing and funding a wastewater utility or other comprehensive management program (see chapter 2).

### 1.5.2 Financial support

Funding is essential for successful management of onsite systems. Adequate staff is required to implement the components of the program and objectively enforce the regulations. Without money to pay for planning, inspection, and enforcement staff, these activities will not normally be properly implemented. Financial programs might be needed to provide loans or cost-share grants to retrofit or replace failing systems. Statewide public financing programs for onsite systems like the PENNVEST initiative in Pennsylvania provide a powerful incentive for upgrading inadequate or failed systems (Pennsylvania Infrastructure Investment Authority, 1997). Regional cost-share programs like the Triplett Creek Project in Kentucky, which provided funding for new septic tanks and drain field repairs, are also effective approaches for addressing failed systems (USEPA, 1997). Chapter 2 and the Resources section provide more information on funding options for onsite systems and management programs.

Managing onsite systems is particularly challenging in small, unincorporated communities without paid staff. Programs staffed by trained volunteers and regional “circuit riders” can help deliver technical expertise at a low cost in these situations. Developing a program uniquely tailored to each community requires partnerships, ingenuity, commitment, and perseverance.

### 1.5.3 Support from elected officials

In most cases the absence of a viable oversight program that addresses the full range of planning, design, siting, permitting, installation, operation, maintenance, and monitoring activities is the main reason for inadequate onsite wastewater system management. This absence can be attributed to a number of factors, particularly a political climate in which the value of effective onsite wastewater management is dismissed as hindering economic development or being too restrictive on rural housing development. In addition, low population densities, low incomes, underdeveloped management entities, a history of neglect, or other unique factors can impede the development of comprehensive management programs. Focusing on the public health and water resource impacts associated with onsite systems provides an important perspective for public policy discussions on these issues.

Sometimes state and local laws prevent siting or design options that could provide treatment and recycling of wastewater from onsite systems. For example, some state land use laws prohibit using lands designated as resource lands to aid in the development of urban uses. Small communities or rural developments located near state resource lands are unable to use those lands to address onsite problems related to space restrictions, soil limitations, or other factors (Fogarty, 2000).

The most arbitrary siting requirement, however, is the minimum lot size restriction incorporated into

*Note:* This manual is not intended to be used to determine appropriate or inappropriate uses of land. The information the manual presents is intended to be used to select appropriate technologies and management strategies that minimize risks to human health and water resources in areas that are not connected to centralized wastewater collection and treatment systems.



many state and local codes. Lot size limits prohibit onsite treatment system installations on nonconforming lots without regard to the performance capabilities of the proposed system. Lot size restrictions also serve as an inappropriate but de facto approach to land use planning in many localities because they are often seen as establishing the allowable number of housing units in a development without regard to other factors that might increase or decrease that number.

When developing a program or regulation, the common tendency is to draw on experience from other areas and modify existing management plans or codes to meet local needs. However, programs that are successful in one area of the country might be inappropriate in other areas because of differences in economic conditions, environmental factors, and public agency structures and objectives. Transplanting programs or program components without considering local conditions can result in incompatibilities and a general lack of effectiveness. Although drawing on the experience of others can save time and money, local planners and health officials need to make sure that the programs and regulations are appropriately tailored to local conditions.

Successful programs have site evaluation, inspection, and monitoring processes to ensure that regulations are followed. Programs that have poor inspection and monitoring components usually experience low compliance rates, frequent complaints, and unacceptable performance results. For example, some states do not have minimum standards applicable to the various types of onsite systems being installed or do not require licensing of installers (Suhler, 2000). Standards and enforcement practices vary widely among the states, and until recently there has been little training for local officials, designers, or installers.

USEPA has identified more effective management of onsite systems as a key challenge for efforts to improve system performance (USEPA, 1997). In its *Response to Congress on Use of Decentralized Wastewater Treatment Systems*, USEPA noted that “adequately managed decentralized wastewater treatment systems can be a cost-effective and long-term option for meeting public health and water quality goals, particularly for small towns and rural areas.”

In addition, the Agency found that properly managed onsite systems protect public health and water quality, lower capital and maintenance costs for low-density communities, are appropriate for varying site conditions, and are suitable for ecologically sensitive areas (USEPA, 1997). However, USEPA identified several barriers to the increased use of onsite systems, including the lack of adequate management programs. Although most communities have some form of management program in place, there is a critical lack of consistency. Many management programs are inadequate, underdeveloped, or too narrow in focus, and they might hinder widespread public acceptance of onsite systems as viable treatment options or fail to protect health and water resources.

### 1.6 Performance-based management of onsite wastewater treatment systems

Performance-based management approaches have been proposed as a substitute for prescriptive requirements for system design, siting, and operation. In theory, such approaches appear to be both irresistibly simple and inherently logical. In practice, however, it is often difficult to certify the performance of various treatment technologies under the wide range of climates, site conditions, hydraulic loads, and pollutant outputs they are subjected to and to predict the transport and fate of those pollutants in the environment. Despite these difficulties, research and demonstration projects conducted by USEPA, the National Small Flows Clearinghouse, the National Capacity Development Project, private consultants and engineering firms, academic institutions, professional associations, and public agencies have collectively assembled a body of knowledge that can provide a framework for developing performance-based programs. Performance ranges for many alternative systems operating under a given set of climatic, hydrological, site, and wastewater load conditions have been established. The site evaluation process is becoming more refined and comprehensive (see chapter 5) and has moved from simple percolation tests to a more comprehensive analysis of soils, restrictive horizons, seasonal water tables, and other factors. New technologies that incorporate lightweight media, recirculation of effluent, or disinfection processes have been developed based on performance.

A performance-based management program makes use of recent developments to select and size system technologies appropriate for the estimated flow and strength of the wastewater at the site where treatment is to occur. For sites with appropriate soils, ground water characteristics, slopes, and other features, systems with subsurface wastewater infiltration systems (SWISs) might be the best option. Sites with inadequate soils, high seasonal water tables, or other restrictions require alternative approaches that can achieve performance objectives despite restrictive site features. Selecting proven system designs that are sized to treat the expected wastewater load is the key to this approach. Installing unproven technologies on provisional sites is risky even if performance monitoring is to be conducted because monitoring is often expensive and sometimes inconclusive.

### 1.6.1 Prescriptive management programs

Onsite system management has traditionally been based on prescriptive requirements for system design, siting, and installation. Installation of a system that “complies” with codes is a primary goal. Most jurisdictions specify the type of system that must be installed and the types and depth of soils that must be present. They also require mandatory setbacks from seasonally high water tables, property lines, wells, surface waters, and other landscape features. Some of these requirements (e.g., minimum setback distances from streams and reservoirs) are arbitrary and vary widely among the states (Curry, 1998). The prescriptive approach has worked well in some localities but has severely restricted development options in many areas. For example, many regions do not have appropriate soils, ground water tables, slopes, or other attributes necessary for installation of conventional onsite systems. In Florida, 74 percent of the soils have severe or very severe limitations for conventional system designs, based on USDA Natural Resources Conservation Service criteria (Florida HRS, 1993).

### 1.6.2 Hybrid management programs

Some jurisdictions are experimenting with performance-based approaches while retaining prescriptive requirements for technologies that have proven effective under a known range of site conditions.

These prescriptive/performance-based or “hybrid” programs represent a practical approach to onsite system management by prescribing specific sets of technologies or proprietary systems for sites where they have proven to be effective and appropriate. Regulatory entities review and evaluate alternative systems to see if they are appropriate for the site and the wastewater to be treated. Performance-based approaches depend heavily on data from research, wastewater characterization processes, site evaluations, installation practices, and expected operation and maintenance activities, and careful monitoring of system performance is strongly recommended. Programs that allow or encourage a performance-based approach must have a strong management program to ensure that preinstallation research and design and postinstallation operation, maintenance, and monitoring activities are conducted appropriately.

Representatives from government and industry are supporting further development of management programs that can adequately oversee the full range of OWTS activities, especially operation and maintenance. The National Onsite Wastewater Recycling Association (NOWRA) was founded in 1992 to promote policies that improve the market for onsite wastewater treatment and reuse products. NOWRA has developed a model framework for onsite system management that is based on performance rather than prescriptive regulations. The framework endorses the adoption and use of alternative technologies that achieve public health and environmental protection objectives through innovative technologies and comprehensive program management. (NOWRA, 1999)

## 1.7 Coordinating onsite system management with watershed protection efforts

During the past decade, public and private entities involved in protecting and restoring water resources have increasingly embraced a watershed approach to assessment, planning, and management. Under this approach, all the land uses and other activities and attributes of each drainage basin or ground water recharge zone are considered when conducting monitoring, assessment, problem targeting, and remediation activities (see figure 1-5). A watershed

approach incorporates a geographic focus, scientific principles, and stakeholder partnerships.

Because onsite systems can have significant impacts on water resources, onsite/decentralized wastewater management agencies are becoming more involved in the watershed protection programs that have developed in their regions. Coordinating onsite wastewater management activities with programs and projects conducted under a watershed approach greatly enhances overall land use planning and development processes. A cooperative, coordinated approach to protecting health and water resources can achieve results that are greater than the sum of the individual efforts of each partnering entity. Onsite wastewater management agencies are important components of watershed partnerships, and their involvement in these efforts provides mutual benefits, operating efficiencies, and public education opportunities that can be difficult for agencies to achieve individually.

## 1.8 USEPA initiatives to improve onsite system treatment and management

In 1996 Congress requested USEPA to report on the potential benefits of onsite/decentralized wastewater treatment and management systems, the potential costs or savings associated with such systems, and the ability and plans of the Agency to implement additional alternative wastewater system measures within the current regulatory and statutory regime. A year later USEPA reported that properly managed onsite/decentralized systems offer several advan-

tages over centralized wastewater treatment facilities (USEPA, 1997; see <http://www.epa.gov/owm/decent/response/index.htm>). The construction and maintenance costs of onsite/decentralized systems can be significantly lower, especially in low-density residential areas, making them an attractive alternative for small towns, suburban developments, remote school and institutional facilities, and rural regions. Onsite/decentralized wastewater treatment systems also avoid potentially large transfers of water from one watershed to another via centralized collection and treatment (USEPA, 1997).

USEPA reported that both centralized and onsite/decentralized systems need to be considered when upgrading failing systems. The report concluded that onsite/decentralized systems can protect public health and the environment and can lower capital and maintenance costs in low-density communities. They are also appropriate for a variety of site conditions and can be suitable for ecologically sensitive areas (USEPA, 1997). However, the Agency also cited several barriers to implementing more effective onsite wastewater management programs, including the following:

- Lack of knowledge and public misperceptions that centralized sewage treatment plants perform better, protect property values, and are more acceptable than decentralized treatment systems.
- Legislative and regulatory constraints and prescriptive requirements that discourage local jurisdictions from developing or implementing effective management and oversight functions.

### Model framework for onsite wastewater management

- ✓ Performance requirements that protect human health and the environment.
- ✓ System management to maintain performance within the established performance requirements.
- ✓ Compliance monitoring and enforcement to ensure system performance is achieved and maintained.
- ✓ Technical guidelines for site evaluation, design, construction, and operation and acceptable prescriptive designs for specific site conditions and use.
- ✓ Education/training for all practitioners, planners, and owners.
- ✓ Certification/licensing for all practitioners to maintain standards of competence and conduct.
- ✓ Program reviews to identify knowledge gaps, implementation shortcomings, and necessary corrective actions.

Source: NOWRA, 1999.

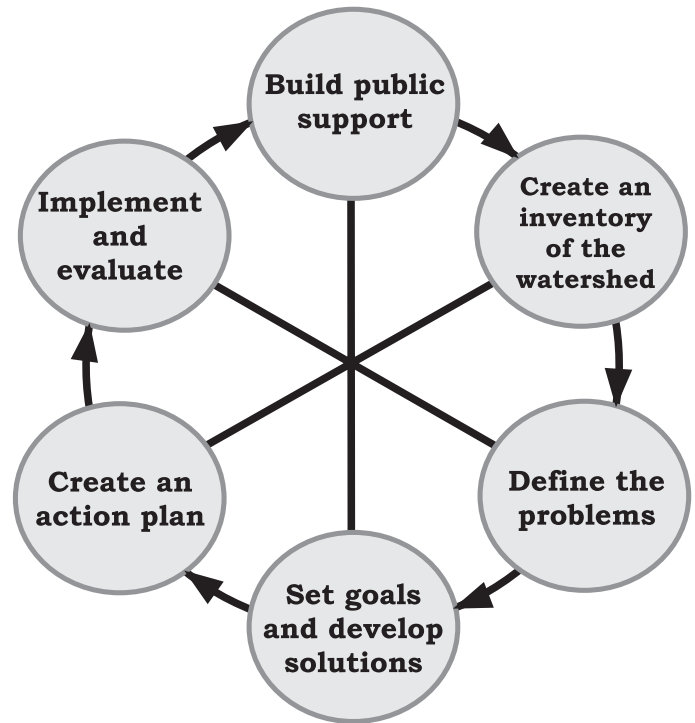


- Splitting of regulatory authority, which limits the evaluation of alternatives, and a lack of management programs that consolidate planning, siting, design, installation, and maintenance activities under a single entity with the resources and authority to ensure that performance requirements are met and performance is maintained.
- Liability laws that discourage innovation, as well as cost-based engineering fees that discourage investment in designing innovative, effective, low-cost systems.
- Grant guidelines, loan priorities, and other financial or institutional barriers that prevent rural communities from accessing funds, considering alternative wastewater treatment approaches, or creating management entities that span the jurisdictions of multiple agencies.

USEPA is committed to elevating the standards of onsite wastewater management practice and removing barriers that preclude widespread acceptance of onsite treatment technologies. In addition, the Agency is responding to calls to reduce other barriers to onsite treatment by improving access to federal funding programs, providing performance information on alternative onsite wastewater treatment technologies through the Environmental Technology Verification program (see <http://www.epa.gov/etv/>) and other programs, partnering with other agencies to reduce funding barriers, and providing guidance through cooperation with other public agencies and private organizations. USEPA supports a number of efforts to improve onsite treatment technology design, application, and funding nationwide. For example, the National Onsite Demonstration Project (NODP), funded by USEPA and managed by the National Small Flows Clearinghouse at West Virginia University, was established in 1993 to encourage the use of alternative, decentralized wastewater treatment technologies to protect public health and the environment in small and rural communities (see <http://www.nesc.wvu.edu>).

In addition, USEPA is studying ground water impacts caused by large-capacity septic systems, which might be regulated under the Class V Underground Injection Control (UIC) program. Large-capacity septic systems serve multiple dwellings, business establishments, and other facilities and are used to dispose of sanitary and other wastes through

Figure 1-5. The watershed approach planning and management cycle

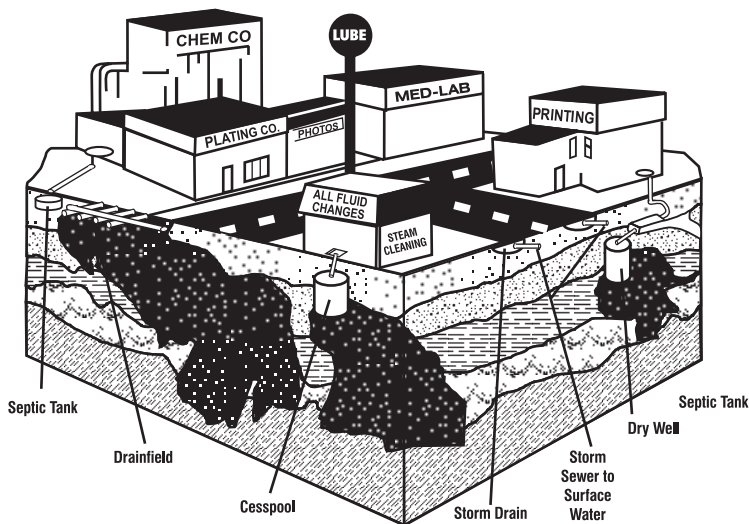


Source: Ohio EPA, 1997.

subsurface application (figure 1-6). Domestic and most commercial systems serving fewer than 20 persons are not included in the UIC program (see <http://www.epa.gov/safewater/uic/classv.html> for exceptions and limitations), but some commercial facilities serving fewer than 20 people may be regulated. States and tribes with delegated authority are studying possible guidance and other programs that reduce water resource impacts from these systems. USEPA estimates that there are more than 350,000 large-capacity septic systems nationwide.

USEPA also oversees the management and reuse or disposal of septic tank residuals and septage through the Part 503 Rule of the federal Clean Water Act. The Part 503 Rule (see <http://www.epa.gov/owm/bio/503pe/>) established requirements for the final use or disposal of sewage sludge when it is applied to land to condition the soil or fertilize crops or other vegetation, deposited at a surface disposal site for final disposal, or fired in a biosolids incinerator. The rule also specifies other requirements for sludge that is placed in a municipal solid waste landfill under Title 40 of the Code of Federal Regulations (CFR), Part 258. The Part 503 Rule is designed to protect public health

Figure 1-6. Large-capacity septic tanks and other subsurface discharges subject to regulation under the Underground Injection Control Program and other programs



and the environment from any reasonably anticipated adverse effects of certain pollutants and contaminants that might be present in sewage sludge, and it is consistent with USEPA's policy of promoting the beneficial uses of biosolids.

USEPA has also issued guidance for protecting wellhead recharge areas and assessing threats to drinking water sources under the 1996 amendments to the Safe Drinking Water Act (see <http://>

[www.epa.gov/safewater/protect.html](http://www.epa.gov/safewater/protect.html) and <http://www.epa.gov/safewater/whpnp.html>). State source water assessment programs differ because they are tailored to each state's water resources and drinking water priorities. However, each assessment must include four major elements:

- Delineating (or mapping) the source water assessment area
- Conducting an inventory of potential sources of contamination in the delineated area
- Determining the susceptibility of the water supply to those contamination sources
- Releasing the results of the determinations to the public

Local communities can use the information collected in the assessments to develop plans to protect wellhead recharge areas and surface waters used as drinking water sources. These plans can include local or regional actions to reduce risks associated with potential contaminant sources, prohibit certain high-risk contaminants or activities in the source water protection area, or specify other management measures to reduce the likelihood of source water contamination. Improving the performance and management of onsite treatment systems can be an important component of wellhead and source water protection plans in areas where nitrate contamination, nutrient inputs, or microbial

### Integrating public and private entities with watershed management

In 1991 the Keuka Lake Association established a watershed project to address nutrient, pathogen, and other pollutant loadings to the upstate New York lake, which provides drinking water for more than 20,000 people and borders eight municipalities and two counties. The project sought to assess watershed conditions, educate the public on the need for action, and foster interjurisdictional cooperation to address identified problems. The project team established the Keuka Watershed Improvement Cooperative as an oversight committee composed of elected officials from the municipalities and counties. The group developed an 8-page intermunicipal agreement under the state home rule provisions (which allow municipalities to do anything collectively that they may do individually) to formalize the cooperative and recommend new laws and policies for onsite systems and other pollutant sources.

Voters in each municipality approved the agreement by landslide margins after an extensive public outreach program. The cooperative developed regulations governing onsite system permitting, design standards, inspection, and enforcement. The regulations carry the force of law in each town or village court and stipulate that failures must be cited and upgrades required. Inspections are required every 5 years for systems within 200 feet of the lake, and alternative systems must be inspected annually. The cooperative coordinates its activities with state and county health agencies and maintains a geographic information system (GIS) database to track environmental variables and the performance of new technologies. The program is financed by onsite system permit fees, some grant funds, and appropriations from each municipality's annual budget.

Source: Shephard, 1996.

contaminants are identified as potential risks to drinking water sources.

## 1.9 Other initiatives to assist and improve onsite management efforts

Financing the installation and management of onsite systems can present a significant barrier for homeowners and small communities. USEPA and other agencies have developed loan, cost-share, and other programs to help homeowners pay for new systems, repairs, or upgrades (see chapter 2). Some of the major initiatives are the Clean Water State Revolving Fund (CWSRF), the Hardship Grant Program, the Nonpoint Source Pollution Program, USDA Rural Development programs, and the Community Development Block Grant (CDBG) program.

The *CWSRF* is a low-interest or no-interest loan program that has traditionally financed centralized, publicly owned treatment works across the nation (see <http://www.epa.gov/owm/finan.htm>). The program guidance, issued in 1997, emphasizes that the fund can be used as a source of support for the installation, repair, or upgrading of OWTSSs in small-town, rural, and suburban areas. The CWSRF programs are administered by states and the territory of Puerto Rico and operate like banks. Federal and state contributions are used to capitalize the fund, which makes low- or no-interest loans for important water quality projects. Funds are then repaid to the CWSRFs over terms as long as 20 years. Repaid funds are recycled to support other water quality projects. Projects that might be eligible for CWSRF funding include new system installations and replacement or modification of existing systems. Also covered are costs associated with establishing a management entity to oversee onsite systems in a region, including capital outlays (e.g., for pumper trucks or storage buildings). Approved management entities include city and county governments, special districts, public or private utilities, and private for-profit or nonprofit corporations.

The *Hardship Grant Program* of the CWSRF was developed in 1997 to provide additional resources for improving onsite treatment in low-income regions experiencing persistent problems with onsite treatment because of financial barriers. The

new guidance and the grant program responded to priorities outlined in the Safe Drinking Water Act Amendments of 1996 and the Clean Water Action Plan, which was issued in 1998.

The *Nonpoint Source Pollution Program* provides funding and technical support to address a wide range of polluted runoff problems, including contamination from onsite systems. Authorized under section 319 of the federal Clean Water Act and financed by federal, state, and local contributions, the program provides cost-share funding for individual and community systems and supports broader watershed assessment, planning, and management activities. Demonstration projects funded in the past have included direct cost-share for onsite system repairs and upgrades, assessment of watershed-scale onsite wastewater contributions to polluted runoff, regional remediation strategy development, and a wide range of other projects dealing with onsite wastewater issues. (See <http://www.epa.gov/OWOW/NPS> for more information.)

The USEPA *Office of Wastewater Management* supports several programs and initiatives related to onsite treatment systems, including development of guidelines for managing onsite and cluster systems (see <http://www.epa.gov/own/bio.htm>). The disposition of biosolids and septage pumped from septic tanks is also subject to regulation by state and local governments (see chapter 4).

The *U.S. Department of Agriculture* provides grant and loan funding for onsite system installations through USDA *Rural Development* programs. The Rural Housing Service program (see [http://www.rurdev.usda.gov/rhs/Individual/ind\\_splash.htm](http://www.rurdev.usda.gov/rhs/Individual/ind_splash.htm)) provides direct loans, loan guarantees, and grants to low or moderate-income individuals to finance improvements needed to make their homes safe and sanitary. The Rural Utilities Service (<http://www.usda.gov/rus/water/programs.htm>) provides loans or grants to public agencies, tribes, and nonprofit corporations seeking to develop water and waste disposal services or decrease their cost.

The *U.S. Department of Housing and Urban Development* (HUD) operates the *Community Development Block Grant Program*, which provides annual grants to 48 states and Puerto Rico. The states and Puerto Rico use the funds to award grants for community development to small cities

and counties. CDBG grants can be used for numerous activities, including rehabilitation of residential and nonresidential structures, construction of public facilities, and improvements to water and sewer facilities, including onsite systems. USEPA is working with HUD to improve system owners' access to CDBG funds by raising program awareness, reducing paperwork burdens, and increasing promotional activities in eligible areas. (More information is available at <http://www.hud.gov/cpd/cdbg.html>.)

The *Centers for Disease Control and Prevention* (CDC) of the U.S. Public Health Service (see <http://www.cdc.gov>) conduct research and publish studies on waterborne infectious disease outbreaks and illness linked to nitrate contamination of ground water, both of which have been linked to OWTSS, among other causes. Disease outbreaks associated with contaminated, untreated ground water and recreational contact with water contaminated by pathogenic organisms are routinely reported to the CDC through state and tribal infectious disease surveillance programs.

Individual *Tribal Governments* and the *Indian Health Service* (IHS) handle Indian wastewater management programs. The IHS *Sanitation Facilities Construction Program*, within the Division of Facilities and Environmental Engineering of the Office of Public Health, is supported by engineers, sanitarians, technicians, clerical staff, and skilled construction workers. Projects are coordinated through the headquarters office in Rockville, Maryland, and implemented through 12 area offices across the nation. The program works cooperatively with tribes and tribal organizations, USEPA, HUD, the USDA's Rural Utilities Service, and other agencies to fund sanitation and other services throughout Indian Country (see <http://www.ihs.gov/nonmedicalprograms/dfec/reports/rpt1998.pdf>).

## References

Curry, D. 1998. *National Inventory of Key Activities Supporting the Implementation of Decentralized Wastewater Treatment*. Fact Sheet No. 3-2. Research conducted by the U.S. Environmental Protection Agency, Office of Wastewater Management. Available from Tetra Tech, Inc., Fairfax, VA.

Florida Department of Health and Rehabilitative Services (Florida DHRS). 1993. *Onsite Sewage Disposal System Research in Florida: An Evaluation of Current OSDS Practices in Florida*. Report prepared for the Florida Department of Health and Rehabilitative Services, Environmental Health Program, by Ayres Associates, Tallahassee, FL.

Fogarty, S. 2000. Land Use and Zoning Laws. *Small Flows Quarterly* 1(1):13.

Hoover, M.T., A.R. Rubin, and F. Humenik. 1998. *Choices for Communities: Wastewater Management Options for Rural Areas*. AG-585. North Carolina State University, College of Agriculture and Life Sciences, Raleigh, NC.

Kreissl, J.F. 1982. Evaluation of State Codes and Their Implications. In *Proceedings of the Fourth Northwest On-Site Wastewater Disposal Short Course*, September, University of Washington, Seattle, WA.

Kreissl, J.F. 2000. Onsite Wastewater Management at the Start of the New Millennium. *Small Flows Quarterly* 1(1):10-11.

National Onsite Wastewater Recycling Associations (NOWRA). 1999. *Model Framework for Unsewered Wastewater Infrastructure*. National Onsite Wastewater Recycling Association. July 1999. <<http://www.nowra.org/Sept99/article-frame.html>>. Accessed March 29, 2000.

Nelson, V.I., S.P. Dix, and F. Shepard. 1999. *Advanced On-Site Wastewater Treatment and Management Scoping Study: Assessment of Short-Term Opportunities and Long-Run Potential*. Prepared for the Electric Power Research Institute, the National Rural Electric Cooperative Association, and the Water Environment Research Federation.

Ohio Environmental Protection Agency (Ohio EPA). 1997. *A Guide to Developing Local Watershed Action Plans in Ohio*. Ohio Environmental Protection Agency, Division of Surface Water, Columbus, OH.

Otis, J. 2000. Performance management. *Small Flows Quarterly* 1(1):12.



- Parsons Engineering Science. 2000. Septic System Failure Summary. Prepared for U.S. Environmental Protection Agency, Office of Water, under Contract 68-C6-0001. June 13, 2000.
- Pennsylvania Infrastructure Investment Authority (PENNVEST). 1997. *A Water, Sewer, and Stormwater Utility's Guide to Financial and Technical Assistance Programs*. Pennsylvania Infrastructure Investment Authority, Harrisburg, PA.
- Plews, G.D. 1977. The Adequacy and Uniformity of Regulations for Onsite Wastewater Disposal—A State Viewpoint. In *Proceedings of the National Conference on Less Costly Treatment Systems for Small Communities*. U.S. Environmental Protection Agency, Cincinnati, OH.
- Shephard, F.C. 1996, April. *Managing Wastewater: Prospects in Massachusetts for a Decentralized Approach*. Prepared for the ad hoc Task Force for Decentralized Wastewater Management. Marine Studies Consortium and Waquoit Bay National Estuarine Research Reserve.
- Suhrer, T. 2000. NODP II at Work in the Green Mountain State. *Small Flows Quarterly* 1(1):12. Published by the National Small Flows Clearinghouse, Morgantown, WV.
- Tchobanoglous, G. 2000. Decentralized Wastewater Management: Challenges and Opportunities for the Twenty-First Century. In *Proceedings of the Southwest On-Site Wastewater Management Conference and Exhibit*, sponsored by the Arizona County Directors of Environmental Health Services Association and the Arizona Environmental Health Association, Laughlin, Nevada, February 2000.
- U.S. Census Bureau. 1990. *Historical Census of Housing Tables: Sewage Disposal*. <<http://www.census.gov/hhes/www/housing/census/historic/sewage.html>>.
- U.S. Census Bureau. 1999. 1997 *National Data Chart for Total Occupied Housing Units*. <<http://www.census.gov/hhes/www/housing/ahs/97dtchrt/tab2-6.html>>.
- U.S. Environmental Protection Agency (USEPA). 1980b. *Planning Wastewater Management Facilities for Small Communities*. EPA-600/8-80-030. U.S. Environmental Protection Agency, Office of Research and Development, Wastewater Research Division, Municipal Environmental Research Laboratory, Cincinnati, OH.
- U.S. Environmental Protection Agency (USEPA). 1980a. *Design Manual: Onsite Wastewater Treatment and Disposal Systems*. EPA 625/1-80/012. U.S. Environmental Protection Agency, Washington, DC.
- U.S. Environmental Protection Agency (USEPA). 1987. *It's Your Choice: A Guidebook for Local Officials on Small Community Wastewater Management Options*. USEPA Office of Municipal Pollution Control (WH-595).
- U.S. Environmental Protection Agency (USEPA). 1993. *Guidance Specifying Management Measures for Sources of Nonpoint Pollution in Coastal Waters*. EPA840-B-92-002. U.S. Environmental Protection Agency, Office of Water, Washington, DC.
- U.S. Environmental Protection Agency (USEPA). 1994. *Environmental Planning for Small Communities: A Guide for Local Decision-Makers*. EPA/625/R-94/009, U.S. Environmental Protection Agency, Office of Research and Development, Office of Regional Operations and State/Local Relations, Washington, DC.
- U.S. Environmental Protection Agency (USEPA). 1996a. *National Water Quality Inventory Report to Congress*. [305b Report.] EPA 841-R-97-008. U.S. Environmental Protection Agency, Washington, DC.
- U.S. Environmental Protection Agency (USEPA). 1996b. *Clean Water Needs Survey Report to Congress*. <<http://www.epa.gov/owm/toc.htm>>.
- U.S. Environmental Protection Agency (USEPA). 1997. *Response to Congress on Use of Decentralized Wastewater Treatment Systems*. EPA 832-R-97-001b. U.S. Environmental Protection Agency, Washington, DC.
- U.S. Environmental Protection Agency (USEPA). 1998. *Guidelines for Ecological Risk Assessment*. EPA 630-R-95-002F. U.S. Environmental Protection Agency, Office of

Research and Development, Risk Assessment Forum, Washington, DC.

- U.S. Environmental Protection Agency (USEPA). 2000. *Draft EPA Guidelines for Management of Onsite/Decentralized Wastewater Systems*. U.S. Environmental Protection Agency, Office of Wastewater Management, Washington, DC. *Federal Register*, October 6, 2000, 65(195): 59840-59841.
- U.S. Public Health Service (USPHS). 1967. (Updated from 1959 version.) *Manual of Septic Tank Practice*. U.S. Public Health Service Publication No. 526. U.S. Department of Health, Education and Welfare.
- Venhuizen, D. 1995. *An Analysis of the Potential Impacts on Ground Water Quality of On-Site Watershed Management Using Alternative Management Practices*. <<http://www.venhuizen-ww.com>>.
- Water Environment Research Foundation (WEF). 1998. *Watershed-Scale Ecological Risk Assessment—Watersheds*. Final report, Project 93-IRM-4(A). Water Environment Research Foundation, Alexandria, VA.

# Chapter 2:

## Management of Onsite Wastewater Treatment Systems

- 2.1 Introduction
- 2.2 Elements of a successful program
- 2.3 Types of management entities
- 2.4 Management program components
- 2.5 Financial assistance for management programs and system installation

### 2.1 Introduction

Effective management is the key to ensuring that the requisite level of environmental and public health protection for any given community is achieved. It is the single most important factor in any comprehensive wastewater management program. Without effective management, even the most costly and advanced technologies will not be able to meet the goals of the community. Numerous technologies are currently available to meet a broad range of wastewater treatment needs. Without proper management, however, these treatment technologies will fail to perform as designed and efforts to protect public health and the environment will be compromised.

In recognition of the need for a comprehensive management framework that communities can use in developing and improving OWTS management programs, USEPA is publishing *Guidelines for Management of Decentralized Wastewater Systems* (see <http://www.epa.gov/owm/decent/index.htm>). At the time of the publication of this manual, the final guidelines and accompanying guidance manual are almost complete. USEPA envisions that tribes, states, local governments, and community groups will use the management guidelines as a reference to strengthen their existing onsite/decentralized programs. The guidelines include a set of recommended program elements and activities and model programs that OWTS program managers can refer to in evaluating their management programs.

The literature on OWTSs is replete with case studies showing that adequate management is critical to ensuring that OWTSs are sited, designed, installed, and operated properly. As USEPA pointed out in its *Response to Congress on Use of*

*Decentralized Wastewater Treatment Systems* (1997), “Few communities have developed organizational structures for managing decentralized wastewater systems, although such programs are required for centralized wastewater facilities and for other services (e.g., electric, telephone, water, etc).”

Good planning and management are inseparable. The capacity of the community to manage any given technology should be factored into the decision-making process leading to the planning and selection of a system or set of systems appropriate for the community. As Kreissl and Otis noted in *New Markets for Your Municipal Wastewater Services: Looking Beyond the Boundaries* (1999), appropriate technologies should be selected based on whether they are affordable, operable, and reliable. The selection of individual unit processes and systems should, at a minimum, be based on those three factors. Although managing OWTSs is obviously far more complicated than assessing whether the systems are affordable, operable and reliable, an initial screening using these criteria is a critical element of good planning.

Historically, the selection and siting of OWTSs has been an inconsistent process. Conventional septic tank and leach field systems were installed based on economic factors, the availability of adequate land area, and simple health-based measures aimed only at preventing direct public contact with untreated wastewater. Little analysis was devoted to understanding the dynamics of OWTSs and the potential impacts on ground water and surface waters. Only recently has there been an understanding of the issues and potential problems associated with

failing to manage OWTs in a comprehensive, holistic manner.

Many case studies and reports from across the country provide documentation that a significant number of OWTs lack adequate management oversight, which results in inadequate pollutant treatment (USEPA, 2000). The lack of system inventories in many communities makes the task of system management even more challenging.

As a result of the perception that onsite/decentralized systems are inferior, old-fashioned, less technologically advanced, and not as safe as centralized wastewater treatment systems from both an environmental and public health perspective, many communities have pursued the construction of centralized systems (collection systems and sewage treatment plants). Centralized wastewater collection and treatment systems, however, are not the most cost-effective or environmentally sound option for all situations (e.g., sewage treatment plants can discharge high point source loadings of pollutants into receiving waters). They are costly to build and operate and are often infeasible or cost-prohibitive, especially in areas with low populations and dispersed households. Many communities lack both the revenue to fund these facilities and the expertise to manage the treatment operations. In addition, centralized treatment systems can contribute to unpredicted growth and development that might threaten water quality.

As development patterns change and increased development occurs in rural areas and on the urban fringe, many communities are evaluating whether they should invest in centralized sewage treatment plants or continue to rely on OWTs. The availability of innovative and alternative onsite technologies and accompanying management strategies now provides small communities with a practical, cost-effective alternative to centralized treatment plants. For example, analysis included in USEPA's *Response to Congress on Use of Decentralized Wastewater Treatment Systems* (1997) shows that the costs of purchasing and managing an OWT or a set of individual systems can be significantly (22 to 80 percent) less than the cost of purchasing and managing a centralized system.

Regardless of whether a community selects more advanced decentralized systems, centralized sys-

tems, or some combination of the two, a comprehensive management program is essential. As USEPA noted in *Wastewater Treatment/Disposal for Small Communities* (1992), effective management strategies depend on carefully evaluating all feasible technical and management alternatives and selecting appropriate solutions based on the needs of the community, the treatment objectives, the economic capacity, and the political and legislative climate.

The management tasks listed have become increasingly complex, especially given the need to develop a management strategy based on changing priorities primarily driven by new development activities. Rapid urbanization and suburbanization, the presence of other sources that might discharge nutrients and pathogens, water reuse issues, increasingly stringent environmental regulations, and recognition of the need to manage on a watershed basis increase the difficulty of this task. Multiple objectives (e.g., attainment of water quality criteria, protection of ground water, efficient and affordable wastewater treatment) now must be achieved to reach the overarching goal of maintaining economically and ecologically sound communities. Investment by small communities in collection and treatment systems increases taxes and costs to consumers—costs that might be reduced substantially by using decentralized wastewater treatment systems. From a water resource perspective achieving these goals means that public health, contact recreation activities, fisheries, shellfisheries, drinking water resources, and wildlife need to be protected or restored. From a practical standpoint, achieving these goals requires that the management entity develop and implement a program that is consistent with the goal of simultaneously meeting and achieving the requirements of the Safe Drinking Water Act, the Clean Water Act, the Endangered Species Act, and other applicable federal, state, tribal, and local requirements.

Changing regulatory contexts point to scenarios in which system selection, design, and replacement will be determined by performance requirements tied to water quality standards or maximum contamination limits for ground water. Cumulative effects analyses and antidegradation policies might be used to determine the level of technology and management needed to meet the communities' resource management goals. Comprehensive



coordinated management programs are needed to meet this challenge. These programs require interdisciplinary consultations among onsite system management entities, water quality agencies, land use planners, engineers, wildlife biologists, public health specialists, and others to ensure that these goals and objectives are efficiently achieved with a minimum of friction or program overlap.

Fortunately, there are solutions. Technologies that can provide higher levels of pollutant reduction than were practical in the past appear to be emerging. Better monitoring and assessment methods are now available to determine the effectiveness of specific technologies. Remote sensing is possible to help monitor and understand system operation, and more sophisticated inspection tools are available to complement visual septic tank/SWIS inspections.

## 2.2 Elements of a successful program

The success or failure of an onsite wastewater management program depends significantly on public acceptance and local political support; adequate funding; capable and trained technical and field staff; and clear and concise legal authority, regulations, and enforcement mechanisms (Ciotoli and Wiswall, 1982). Management programs should include the following critical elements:

- Clear and specific program goals
- Public education and outreach
- Technical guidelines for site evaluation, design, construction, and operation/maintenance
- Regular system inspections, maintenance, and monitoring
- Licensing or certification of all service providers
- Adequate legal authority, effective enforcement mechanisms, and compliance incentives
- Funding mechanisms
- Adequate record management
- Periodic program evaluations and revisions

Although all of these elements should be present in a successful management program, the responsibility for administering the various elements might fall on a number of agencies or entities. Regardless of the size or complexity of the program, its components

must be *publicly accepted, politically feasible, fiscally viable, measurable, and enforceable*.

Many of the program elements discussed in this chapter are described in more detail in the other chapters of this manual. The elements described in detail in this chapter are those essential to the selection and adoption of a management program.

### 2.2.1 Clear and specific program goals

Developing and meeting program goals is critical to program success. Management programs typically focus on two goals—*protection of public health* and *protection of the environment*. Each onsite system must be sited, designed, and managed to achieve these goals.

Public health protection goals usually focus on preventing or severely limiting the discharge of pathogens, nutrients, and toxic chemicals to ground water. Surface water bodies, including rivers, lakes, streams, estuaries, and wetlands, can also be adversely affected by OWTSS. Program goals should be established to protect both surface and ground water resources.

#### Public participation opportunities during program planning and implementation

- Agreement on basic need for program
- Participation on committees, e.g., finance, technical, educational
- Selection of a consultant or expert (request for proposal, selection committee, etc.)
- Choosing the most appropriate options from the options identified by a consultant or expert
- Obtaining financing for the preferred option
- Identifying and solving legal questions and issues
- Providing input for the enforcement/compliance plan
- Implementation and construction

## 2.2.2 Public education and outreach

### Public education

Public participation in and support for planning, design, construction, and operation and maintenance requirements are essential to the acceptance and success of an onsite wastewater management program. Public meetings involving state and local officials, property owners, and other interested parties are an effective way to garner support for the program. Public meetings should include discussions about existing OWTS problems and cover issues like program goals, costs, financing, inspection, and maintenance. Such meetings provide a forum for identifying community concerns and priorities so that they can be considered in the planning process. Public input is also important in determining management and compliance program structure, defining the boundaries of the program, and evaluating options, their relative requirements and impacts, and costs.

### Public outreach

Educating homeowners about the proper operation and maintenance of their treatment systems is an essential program activity. In most cases, system owners or homeowners are responsible for some portion of system operation and maintenance or for ensuring that proper operation and maintenance occurs through some contractual agreement. The system owner also helps to monitor system performance. Increased public support and program effectiveness can be promoted by educating the public about the importance of OWTS management in protecting public health, surface waters, ground water resources, and property values.

Onsite system owners are often uninformed about how their systems function and the potential for ground water and surface water contamination from poorly functioning systems. Surveys show that many people have their septic tanks pumped only after the system backs up into their homes or yards. Responsible property owners who are educated in proper wastewater disposal and maintenance practices and understand the consequences of system failure are more likely to make an effort to ensure their systems are in compliance with operation and maintenance requirements. Educational

materials for homeowners and training courses for designers, site evaluators, installers, inspectors, and operation/maintenance personnel can help reduce the impacts from onsite systems by reducing the number of failing systems, which potentially reduces or eliminates future costs for the system owner and the management program.

## 2.2.3 Technical guidelines for site evaluation, design, and construction

The regulatory authority (RA) should set technical guidelines and criteria to ensure effective and functioning onsite wastewater systems. Guidelines for site evaluation, system design, construction, operation/maintenance, and inspection are necessary to maintain performance consistency. Site evaluation guidelines should be used to determine the site's capability to accept the expected wastewater volume and quality. Guidelines and standards on system design ensure the system compatibility with the wastewater characteristics to be treated and its structural integrity over the life of the system. Construction standards should require that systems conform to the approved plan and use appropriate construction methods, materials, and equipment.

## 2.2.4 Regular system operation, maintenance, and monitoring

An OWTS should be operated and maintained to ensure that the system performs as designed for its service life. Both individual systems and sets of systems within a delineated management area should be monitored to ensure proper performance and the achievement of public health and environmental goals. A combination of visual, physical, bacteriological, chemical, and remote monitoring approaches can be used to assess system performance. Specific requirements for reporting to the appropriate regulatory agency should also be defined in a management program. The right to enter private property to access and inspect components of the onsite system is also an essential element of an effective management program.

### **2.2.5 Licensing or certification of service providers**

Service providers include system designers, site evaluators, installers, operation/maintenance personnel, inspectors, and septage pumpers/haulers. A qualifications program that includes certification or licensing procedures for service providers should be incorporated into a management program. Licensing can be based on examinations that assess basic knowledge, skills, and experience necessary to perform services. Other components include requirements for continuing education, defined service protocols, and disciplinary guidelines or other mechanisms to ensure compliance and consistency. Many states already have, or are planning, certification programs for some service providers. These and other existing licensing arrangements should be incorporated when they complement the objectives of the management program.

### **2.2.6 Adequate legal authority, effective enforcement mechanisms, and compliance incentives**

Onsite wastewater management programs need a combination of legal authorities, enforcement mechanisms, and incentives to ensure compliance and achievement of program goals. To ensure program effectiveness, some program mechanisms should be enforceable. Although the types of mechanisms management entities use will vary by program, the following mechanisms should be enforceable: construction and operating permits, requirements for performance bonds to ensure proper construction or system operation and maintenance, and licensing/certification requirements to ensure that service providers have the necessary skills to perform work on treatment systems. Management entities should also have the authority to carry out repairs or replace systems and, ultimately, to levy civil penalties. Enforcement programs, however, should not be based solely on fines if they are to be effective. Information stressing public health protection, the monetary benefits of a clean environment, and the continued functioning of existing systems (avoidance of system replacement costs) can provide additional incentives for compliance. Finally, it should be recognized that the population served by

the management program must participate in and support the program to ensure sustainability.

### **2.2.7 Funding mechanisms**

Funding is critical to the functioning of an effective OWTS management program. Management entities should ensure that there is adequate funding available to support program personnel, education and outreach activities, monitoring and evaluation, and incentives that promote system upgrades and replacement. Funding might also be needed for new technology demonstrations and other program enhancements.

### **2.2.8 Adequate record management**

Keeping financial, physical, and operational records is an essential part of a management program. Accurate records of system location and type, operation and maintenance data, revenue generated, and compliance information are necessary to enhance the financial, operational, and regulatory health of the management program. Electronic databases, spreadsheets, and geographic information systems can help to ensure program effectiveness and appropriate targeting of program resources. At a minimum, program managers should maintain records of system permits, design, size, location, age, site soil conditions, complaints, inspection results, system repairs, and maintenance schedules. This information should be integrated with land use planning at a watershed or wellhead protection zone scale.

### **2.2.9 Periodic program evaluations and revisions**

Management programs for onsite systems are dynamic. Changing community goals, resources, environmental and public health concerns, development patterns, and treatment system technologies require that program managers—with public involvement—regularly evaluate program effectiveness and efficiency. Program managers might need to alter management strategies because of suburban sprawl and the close proximity of centralized collection systems. Resource and staff limitations might also necessitate the use of service providers or designated management entities to

### Twelve problems that can affect OWTS management programs

1. Failure to adequately consider site-specific environmental conditions (site evaluations)
2. Codes that thwart system selection or adaptation to difficult local site conditions and that do not allow the use of effective innovative or alternative technologies
3. Ineffective or nonexistent public education and training programs
4. Failure to include water conservation and reuse
5. Ineffective controls on operation and maintenance of systems
6. Lack of control over residuals management
7. Lack of OWTS program monitoring and evaluation, including OWTS inspection and monitoring
8. Failure to consider the special characteristics and requirements of commercial, industrial, and large residential systems
9. Weak compliance and enforcement programs
10. Lack of adequate funding
11. Lack of adequate legal authority
12. Lack of adequately trained and experienced personnel

Source: Adapted from USEPA, 1986.

ensure that systems in a jurisdiction are adequately managed.

## 2.3 Types of management entities

Developing, implementing, and sustaining a management program requires knowledge of the political, cultural, and economic context of the community, the current institutional structure, and available technologies. Also required are clearly defined environmental and public health goals and adequate funding. A management program should be based on the administrative, regulatory, and operational capacity of the management entity and the goals of the community. In many localities, partnerships with other entities in the management area (watershed, county, region, state, or tribal lands) are necessary to increase the capacity of the management program and ensure that treatment systems do not adversely affect human health or water resources. The main types of management entities are federal, state, and tribal agencies; local government agencies; special-purpose districts and public utilities; and privately owned and operated management entities. Descriptions of the various types of management entities are provided in the following subsections.

### 2.3.1 Federal, state, tribal, and local agencies

Federal, state, tribal, and local governments have varying degrees of authority and involvement in the development and implementation of onsite wastewater management programs. In the United States, tribal, state, and local governments are the main entities responsible for the promulgation and enforcement of OWTS-related laws and regulations. Many of these entities provide financial and technical assistance. Tribal, state, and local authority determines the degree of control these entities have in managing onsite systems. General approaches and responsibilities are shown in table 2-1.

At the federal level, USEPA is responsible for protecting water quality through the implementation of the Clean Water Act (CWA), the Safe Drinking Water Act (SDWA), and the Coastal Zone Act Reauthorization Amendments (CZARA). Under these statutes, USEPA administers a number of programs that affect onsite system management. The programs include the Water Quality Standards Program, the Total Maximum Daily Load Program, the Nonpoint Source Management Program, the National Pollutant Discharge Elimination System (NPDES) Program, the Underground Injection Control (UIC) Program, and the Source Water Protection Program. Under the CWA and the



Table 2-1. Organizational approaches, responsibilities, and other considerations for managing onsite systems

	State Agency	County	Municipality	Special district	Improvement district	Public authority	Public nonprofit corporation	Private nonprofit corporation	Private for-profit corporation
<b>Responsibilities</b>	Enforcement of state laws and regulations	Enforcement of state codes, county ordinances	Enforcement of municipal ordinances; might enforce state/county codes	Powers defined; might include code enforcement (e.g., sanitation district)	State statutes define extent of authority	Fulfilling duties specified in enabling instrument	Role specified in articles of incorporation (e.g., homeowner association)	Role specified in articles of incorporation (e.g., homeowner association)	Role specified in articles of incorporation
<b>Financing capabilities</b>	Usually funded through appropriations and grants.	Able to charge fees, assess property, levy taxes, issue bonds, appropriate general funds	Able to charge fees, assess property, levy taxes, issue bonds, appropriate general funds	Able to charge fees, assess property, levy taxes, issue bonds	Can apply special property assessments, user charges, other fees; can sell bonds	Can issue revenue bonds, charge user and other fees	Can charge fees, sell stock, issue bonds, accept grants/loans	Can charge user fees, accept grants/loans	Can charge fees, sell stock, accept some grants/loans
<b>Advantages</b>	Authority level and code enforceability are high; programs can be standardized; scale efficiencies	Authority level and code enforceability are high; programs can be tailored to local conditions	Authority level and code enforceability are high; programs can be tailored to local conditions	Flexible; renders equitable service (only those receiving services pay); simple and independent approach	Can extend public services without major expenditures; service recipients usually supportive	Can provide service when government unable to do so; autonomous, flexible	Can provide service when government unable to do so; autonomous, flexible	Can provide service when government unable to do so; autonomous, flexible	Can provide service when government unable to do so; autonomous, flexible
<b>Disadvantages</b>	Sometimes too remote; not sensitive to local needs and issues; often leaves enforcement up to local entities	Sometimes unwilling to provide service, conduct enforcement; debt limits could be restrictive	Might lack administrative, financial, other resources; enforcement might be lax	Can promote proliferation of local government, duplication/fragmentation of public services	Contributes to fragmentation of government services; can result in administrative delays	Financing ability limited to revenue bonds; local government must cover debt	Local governments might be reluctant to apply this concept	Services could be of poor quality or could be terminated.	No enforcement powers; company might not be fiscally viable; not eligible for major grant/loan programs

Source: Ciotoli and Wiswall, 1982.



SDWA, USEPA has the authority to directly regulate specific categories of onsite systems under the UIC and NPDES programs. The CZARA section 6217 Coastal Nonpoint Source Program requires the National Oceanic and Atmospheric Administration (NOAA) and USEPA to review and approve upgraded state coastal nonpoint source programs to meet management measures for new and existing OWTSs. These measures address siting, designing, installing, maintaining, and protecting water quality. See chapter 1 for additional information and Internet web sites.

State and tribes might manage onsite systems through various agencies. Typically, a state or tribal public health office is responsible for managing onsite treatment systems. Regulation is sometimes centralized in one state or tribal government office and administered from a regional or local state office. In most states, onsite system management responsibilities are delegated to the county or municipal level. Where such delegation occurs, the state might exercise varying degrees of local program oversight.

Leadership and delegation of authority at the state level are important in setting technical, management, and performance requirements for local programs. In states where local governments are responsible for managing onsite systems, state authority often allows flexibility for local programs to set program requirements that are appropriate for local conditions and management structures as long as the local program provides equal or greater protection than that of state codes. Statewide consistency can be promoted by establishing

- Administrative, managerial, and technological requirements
- Performance requirements for natural resource and public health protection
- Requirements for monitoring and laboratory testing
- Education and training for service providers
- Technical, financial, and administrative support
- Periodic program reviews and evaluations
- Enforcement of applicable regulations

Many states set minimum system design and siting requirements for onsite systems and are actively involved in determining appropriate technologies. Other states delegate some or all of this authority to

local governments. Some states retain the responsibility for the administrative or technical portions of the onsite management program; in these states, the local governments' primary role is to implement the state requirements.

### **2.3.2 Local government agencies**

In many states, local governments have the responsibility for onsite wastewater program management. These local management programs are administered by a variety of municipal, county, or district-level agencies. The size, purpose, and authority of county, township, city, or village government units vary according to each state's statutes and laws. Depending on the size of the jurisdiction and the available resources, an onsite wastewater management program can be administered by a well-trained, fully staffed environmental or public health agency or by a board composed of local leaders. In some states, some or most of the responsibility for onsite system management is delegated by the legislature to local governments. In states with "home rule" provisions, local units of government have the authority to manage onsite systems without specific delegation by the state legislature. Some local home rule governments also have the power to enter into multiple agency or jurisdictional agreements to jointly accomplish any home rule function without any special authority from the state (Shephard, 1996).

County governments can be responsible for a variety of activities regarding the management of onsite systems. A county can assume responsibility for specific activities, such as OWTS regulation, within its jurisdiction, or it can supplement and support existing state, city, town, or village wastewater management programs with technical, financial, or administrative assistance. Counties can provide these services through their normal operational mechanisms (e.g., a county department or agency), or they can establish a special district to provide designated services to a defined service area. County agency responsibilities might include

- Adoption of state minimal requirements or development of more stringent requirements
- Planning, zoning, and general oversight of proposed development
- Review of system designs, plans, and installation practices

- Permitting of systems and construction oversight
- Inspection, monitoring, and enforcement
- Reports to public and elected officials

Township, city, or village governments can be responsible for planning, permitting, and operating onsite wastewater facilities and enforcing applicable regulations. The precise roles and responsibilities of local governments depend on the preferences, capabilities, and circumstances of each jurisdiction. Because of the variability in state enabling legislation and organizational structures, the administrative capacity, jurisdiction, and authority of local entities to manage onsite wastewater systems vary considerably.

### 2.3.3 Special-purpose districts and public utilities

The formation of special-purpose districts and public utilities is usually enabled by state law to provide public services that local governments do not or cannot provide. A special-purpose district or public utility is a quasigovernmental entity established to provide specific services or to conduct activities specified by the enabling legislation. Special districts (e.g., sanitation

districts) provide single or multiple services, such as managing planning and development activities, conducting economic development programs, improving local conditions, and operating drinking water and wastewater treatment facilities. The territory serviced by this entity is variable and can include a single community, a portion of a community, a group of communities, parts of several communities, an entire county, or a regional area. State enabling legislation usually outlines the authority, structure, and operational scope of the district, including service area, function, organizational structure, financial authority, and performance criteria.

Special-purpose districts and public utilities are usually given sufficient financial authority to apply for or access funds, impose service charges, collect fees, impose special assessments on property, and issue revenue or special assessment bonds. Some special-purpose districts have the same financing authority as municipalities, including the authority to levy taxes and incur general obligation debt. These districts are usually legal entities that might enter into contracts, sue, or be sued. There might be situations where eminent domain authority is needed to effectively plan and implement onsite programs. Special-purpose districts and public

#### Sanitation district management of onsite systems: New Mexico

Onsite systems in the community of Peña Blanca, New Mexico, are managed by the Peña Blanca Water and Sanitation District, which is organized under state statutes that require a petition signed by 25 percent of the registered voters and a public referendum before a district may be formed. Once formed, water and sanitation districts in New Mexico are considered subdivisions of the state and have the power to levy and collect *ad valorem* taxes and the right to issue general obligation and revenue bonds.

Residents and public agency officials in Peña Blanca sought to improve the management of systems in the community after a 1985 study found that 86 percent of existing systems required upgrades, repair, or replacement. The water and sanitation district was designated as the lead agency for managing OWTSS because it already provided domestic water service to the community and had an established administrative structure. The sanitation district relies on the New Mexico Environment Department to issue permits and monitor installation, while the district provides biannual pumping services through an outside contractor for a monthly fee of \$10.64 for a 1,000-gallon tank. The district also supervises implementation of the community's onsite system ordinance, which prohibits untreated and unauthorized discharges, lists substances that might not be discharged into onsite systems (e.g., pesticides, heavy metals), and provides for sampling and testing. Penalties for noncompliance are set at \$300 per violation and not more than 90 days imprisonment. Liens might be placed on property for nonpayment of pumping fees.

The program has been in operation since 1991 and serves nearly 200 homes and businesses. Septage pooling on ground surfaces, a problem identified in the 1985 study, has been eliminated.

Source: Rose, 1999.

utilities will most likely have to work closely with state or local authorities when program planning or implementation requires the use of this authority.

Special districts and public utilities can be an effective option for managing onsite systems. The special district and public utility models have been adopted successfully in many states. A good example is the creation of water districts and sanitation districts, which are authorized to manage and extend potable water lines and extend sewerage service in areas near centralized treatment plants. The development of onsite system management functions under the authority of existing sanitation districts provides support for planning, installation, operation, maintenance, inspection, enforcement, and financing of these programs. Traditional onsite management entities (e.g., health departments) can partner with sanitation or other special districts to build a well-integrated program. For example, a health department could retain its authority to approve system designs and issue permits while the sanitation district could assist with regional planning and conduct inspection, maintenance, and remediation/repair activities.

In some areas, special districts or public utilities have been created to handle a full range of management activities, from regional planning and system permitting to inspection and enforcement. In 1971 the City of Georgetown, California, developed and implemented a comprehensive, community-wide onsite management program in the Lake Auburn Trails subdivision (Shephard, 1996). The district does not own the onsite systems in the subdivision but is empowered by the state and county governments to set performance requirements, review and approve system designs, issue permits, oversee construction, access treatment system sites to conduct monitoring, and provide routine maintenance. The initial permit fees were approximately \$550. Annual fees in 1995 were approximately \$170 per dwelling and \$80 for undeveloped lots (Shephard, 1996).

Onsite management districts or public utilities, whether wholly or partially responsible for system oversight, can help ensure that treatment systems are appropriate for the site and properly planned, designed, installed, and maintained. Typical goals for the management district or utility might include

- Providing appropriate wastewater collection/treatment service for every residence or business
- Integrating wastewater management with land use and development policies
- Managing the wastewater treatment program at a reasonable and equitable cost to users

Management districts and public utilities generally are authorized to generate funds from a variety of sources for routine operation and maintenance, inspections, upgrades, and monitoring and for future development. Sources of funds can include initial and renewable permit fees, monthly service charges, property assessments, and special fees. Onsite wastewater management districts that are operated by or closely allied with drinking water supply districts can coordinate collection of system service charges with monthly drinking water bills in a manner similar to that used by centralized wastewater treatment plants. Although some homeowners might initially resist fees and other charges that are necessary to pay for wastewater management services, outreach information on the efficiencies, cost savings, and other benefits of cooperative management (e.g., financial support for system repair, upgrade, or replacement and no-cost pumping and maintenance) can help to build support for comprehensive programs. Such support is especially needed if a voter referendum is required to create the management entity. When creating a new district, public outreach and stakeholder involvement should address the following topics:

- Proposed boundaries of the management district
- Public health and natural resource protection issues
- Problems encountered under the current management system
- Performance requirements for treatment systems
- Onsite technologies appropriate for specific site conditions
- Operation and maintenance requirements for specific system types
- Septage treatment and sewage treatment plant capacity to accept septage
- Cost estimates for management program components
- Program cost and centralized system management cost comparisons

- Potential program partners and inventory of available resources
- Proposed funding source(s)
- Compliance and enforcement strategies
- Legal, regulatory, administrative, and managerial actions to create, develop, or establish the management entity

Another type of special district is the public authority. A public authority is a corporate body chartered by the state legislature with powers to own, finance, construct, and operate revenue-producing public facilities. A public authority can be used in a variety of ways to construct, finance, and operate public facilities, including OWTSs.

It should be noted that some state codes restrict or disallow a managed group of special districts from managing onsite systems. In other cases, clear legal authority for program staff to enter private property to perform inspections and correct problems has not been provided. These limitations can be addressed through special legislation authorizing the creation of entities with explicit onsite management responsibilities. Laws and regulations can also be changed to provide special districts the authority to manage onsite systems and to conduct inspection, maintenance, and remediation activities.

### 2.3.4 Privately owned and operated management entities

Private sector management entities are another option for ensuring OWTS are properly managed. These entities are often responsible for system design, installation, operation, and maintenance. In some cases, these private firms also serve as the sole management entity; for example, a firm might manage an onsite system program for a residential subdivision as a part of a public-private partnership. Several options exist for public/private partnerships in the management of onsite systems. OWTS management programs can contract with private firms to perform clearly defined tasks for which established protocols exist, such as site evaluation, installation, monitoring/inspection, or maintenance. An example of such an arrangement would be to contract with a licensed/certified provider, such as a trained septage pumper/hauler who could be responsible for system inspection, maintenance, and record keeping. Another example would be the case where treatment systems in residential subdivisions are serviced by a private entity and operated under a contract with the subdivision or neighborhood association.

Private for-profit corporations or utilities that manage onsite systems are often regulated by the state public utility commission to ensure continu-

#### Development company creates a service district in Colorado

The Crystal Lakes Development Company has been building a residential community 40 miles northwest of Fort Collins, Colorado, since 1969. In 1972 the company sponsored the creation of the Crystal Lakes Water and Sewer Association to provide drinking water and sewage treatment services. Membership in the association is required of all lot owners, who must also obtain a permit for onsite systems from the Larimer County Health Department. The association enforces county health covenants, aids property owners in the development of onsite water and wastewater treatment systems, monitors surface and ground water, and has developed guidelines for inspecting onsite water and wastewater systems. System inspections are conducted at the time of property transfer.

The association conducts preliminary site evaluations for proposed onsite systems, including inspection of a backhoe pit excavated by association staff with equipment owned by the association. The county health department has also authorized the association to design proposed systems. The association currently manages systems for more than 100 permanent dwellings and 600 seasonal residences. Management services are provided for all onsite systems in the development, including 300 holding tanks, 7 community vault toilets, recreational vehicle dump stations, and a cluster system that serves 25 homes on small lots and the development's lodge, restaurant, and office buildings. The association is financed by annual property owner dues of \$90 to \$180 and a \$25 property transfer fee, which covers inspections.

Source: Mancl, 1999.



### Responsibilities of a Comprehensive Onsite Wastewater Management Program

- Power to propose legislation and establish and enforce program rules and regulations
- Land use planning involvement, review and approval of system designs, permit issuance
- Construction and installation oversight
- Routine inspection and maintenance of all systems
- Management and regulation of septage handling and disposal
- Local water quality monitoring
- Administrative functions (e.g., bookkeeping, billing)
- Grant writing, fund raising, staffing, outreach
- Authority to set rates, collect fees, levy taxes, acquire debt, issue bonds, make purchases
- Authority to obtain easements for access to property, enforce regulations, require repairs
- Education, training, certification, and licensing programs for staff and contractors
- Record keeping and database maintenance

Source: NSFC, 1996.

ous, acceptable service at reasonable rates. Service agreements are usually required to ensure private organizations will be financially secure, provide adequate service, and be accountable to their customers. These entities can play a key role in relieving the administrative and financial burden on local government by providing system management services. It is likely that in the future private firms will build, own, and operate treatment systems and be subject only to responsible administrative oversight of the management entity.

### 2.3.5 Regulatory authorities and responsible management entities

Most regulatory authorities (e.g., public health departments and water quality authorities) lack adequate funding, staff, and technical expertise to develop and implement comprehensive onsite system management programs. Because of this lack of resources and trained personnel, program managers across the country are considering or implementing alternative management structures that delegate responsibility for specified management program elements to other entities. Hoover and Beardsley (2000) recommend that management entities develop alliances with public and private organizations to establish environmental quality goals, evaluate treatment system performance information, and promote activities that ensure

onsite system management programs meet performance requirements.

English and Yeager (2001) have proposed the formation of responsible management entities (RMEs) to ensure the performance of onsite and other decentralized (cluster) wastewater treatment systems. RMEs are defined as legal entities that have the technical, managerial, and financial capacity to ensure viable, long-term, cost-effective centralized management, operation, and maintenance of all systems within the RME's jurisdiction. Viability is defined as the capacity of the RME to protect public health and the environment efficiently and effectively through programs that focus on system performance rather than adherence to prescriptive guidelines (English and Yeager, 2001). RMEs can operate as fully developed management programs under existing oversight programs (e.g., health departments, sanitation districts) in states with performance-based regulations, and they are usually defined as comprehensive management entities that have the managerial, technical, and financial capacity to ensure that proposed treatment system applications will indeed achieve clearly defined performance requirements. System technology performance information can be ranked along a continuum that gives greater weight to confirmatory studies, peer-reviewed assessments, and third party analysis of field applications. Under this approach, unsupported performance assertions by vendors and results from limited field studies



receive less emphasis in management entity evaluations of proposed treatment technologies (Hoover and Beardsley, 2001).

Management responsibilities can be assigned to an entity designated by the state or local government to manage some or all of the various elements of onsite wastewater programs. The assignment of management responsibilities to a comprehensive RME or to some less-comprehensive management entity (ME) appears to be a practical solution to the dilemma of obtaining adequate funding and staffing to ensure that critical management activities occur. The use of an RME, however, makes developing and implementing an onsite management program more complex. Increased coordination and planning are necessary to establish an effective management program. All of the management program activities described below can be performed by an RME; some may be executed by a management entity with a smaller scope of capabilities. In jurisdictions where management program responsibilities are delegated to an RME, the regulatory authority (RA; e.g., local health department) must oversee the RME to ensure that the program achieves the comprehensive public health and environmental goals of the community. Depending on state and local codes, a formal agreement or some other arrangement between the RME and the RA might be required for RME execution of some program elements, such as issuing permits.

The accompanying text insert, adapted from the National Small Flows Clearinghouse (1996), contains an example of activities that a comprehensive RME typically must incorporate into its management program. It should be noted that the involvement of an ME to perform some management program tasks or an RME to perform the full range of management tasks should be tailored to each local situation. Given the evolving nature of onsite wastewater management programs, activities in some cases might be performed by an RME, such as an onsite system utility or private service provider. In other cases, these responsibilities might be divided among several state or local government agencies, such as the local public health department, the regional planning office, and the state water quality agency. Changes in management strategies (movement toward performance-based approaches, institution of model management structures) have resulted in the addition of other

responsibilities, which are discussed later in this section.

When a less-comprehensive ME conducts a specified set of these activities, the RA usually retains the responsibility for managing some or all of the following activities:

- Defining management responsibilities for the RA and the ME
- Overseeing the ME
- Issuing permits
- Inspecting onsite systems
- Responding to complaints
- Enforcement and compliance actions
- Monitoring receiving water quality (surface and ground water)
- Regulation of septage handling and disposal
- Licensing and certification programs
- Keeping records and managing databases for regulatory purposes
- Coordinating local and regional planning efforts

The RA, however, will often delegate to the ME the responsibility for implementing some of the activities listed above. The activities delegated to the ME will be determined by the capacity of the ME to manage specific activities, the specific public health and environmental problems to be addressed by the ME, and the RA's legal authority to delegate some of those activities. For example, if the ME is an entity empowered to own and operate treatment systems in the service area, the ME typically would be responsible for all aspects of managing individual systems, including setting fees, designing and installing systems, conducting inspections, and monitoring those systems to ensure that the RA's performance goals are met. Otis, McCarthy, and Crosby (2001) have presented a framework appropriate for performance management that illustrates the concepts discussed above.

## 2.4 Management program components

Developing and implementing an effective onsite wastewater management program requires that a systematic approach be used to determine necessary program elements. Changes and additions to the

management program should be based on evaluations of the program to determine whether the program has adequate legal authorities, funding, and management capacity to administer both existing and new OWTs and respond to changing environmental and public health priorities and advances in OWT technologies.

The management program elements described in the following sections are common to the most comprehensive onsite management programs (e.g., RMEs). USEPA recognizes that states and local governments are at different stages along the continuum of developing and implementing comprehensive management programs that address their communities' fiscal, institutional, environmental, and public health goals.

### **2.4.1 Authority for regulating and managing onsite treatment systems**

Onsite wastewater program managers should identify all legal responsibilities of the RA that

might affect the implementation of an effective program. Legal responsibilities can be found in state and local statutes, regulations, local codes, land use laws, and planning requirements. Other legal mechanisms such as subdivision covenants, private contracts, and homeowner association rules might also affect the administration of the program. In many jurisdictions, legal authorities that do not specifically refer to onsite programs and authorities, such as public nuisance laws, state water quality standards, and public health laws, might be useful in implementing the program. A typical example would be a situation where the public health agency charged with protecting human health and preventing public nuisances interprets this mandate as sufficient authorization to require replacement or retrofit of onsite system that have surface seepage or discharges.

The extent and interpretation of authority assigned to the RA will determine the scope of its duties, the funding required for operation, and the personnel necessary to perform its functions. In many jurisdictions, the authority to perform some of these activities might be distributed among multiple RAs.

#### **Typical Authorities of a Regulatory Authority**

- Develop and implement policy and regulations
- Provide management continuity
- Enforce regulations and program requirements through fines or incentives
- Conduct site and regional-scale evaluations
- Require certification or licensing of service providers
- Oversee system design review and approval
- Issue installation and operating permits
- Oversee system construction
- Access property for inspection and monitoring
- Inspect and monitor systems and the receiving environment
- Finance the program through a dedicated funding source
- Charge fees for management program services (e.g., permitting, inspections)
- Provide financial or cost-share assistance
- Issue and/or receive grants
- Develop or disseminate educational materials
- Provide training for service providers and staff
- Conduct public education and involvement programs
- Hire, train, and retain qualified employees

Where this is the case, the organizations involved should have the combined authority to perform all necessary activities and should coordinate their activities to avoid program gaps, redundancy, and inefficiency. In some cases, the RA might delegate some of these responsibilities to an ME. When a comprehensive set of responsibilities are delegated to an RME, the RA should retain oversight and enforcement authority to ensure compliance with legal, performance, and other requirements.

Each state or local government has unique organizational approaches for managing onsite wastewater systems based on needs, perceptions, and circumstances. It is vitally important that the authorizing legislation, regulations, or codes allow the RAs and MEs to develop an institutional structure capable of fulfilling mandates through adoption of appropriate technical and regulatory programs. A thorough evaluation of authorized powers and capabilities at various levels and scales is necessary to determine the scope of program authority, the scale at which RAs and MEs can operate, and the processes they must follow to enact and implement the management program. Involving stakeholders who represent public health entities, environmental groups, economic development agencies, political entities, and others in this process can ensure that the lines and scope of authority for an onsite management program are well understood and locally supported. In some cases, new state policies or regulations must be implemented to allow for recognition of onsite MEs.

### **2.4.2 Onsite wastewater management program goals**

Developing and implementing an effective management program requires first establishing program goals. Program goals should be selected based on public health, environmental, and institutional factors and public concerns. Funding availability, institutional capability, and the need to protect consumers and their interests typically affect the selection of program goals and objectives. One or more entities responsible for public health and environmental protection, such as public health and water quality agencies, can determine the goals. The development of short- and long-term comprehensive goals will most likely require coordination among these entities. Community development and planning agencies as well as residents should also

play a role in helping to determine appropriate goals.

Traditionally, the main goals of most onsite management programs have been to reduce risks to public health (e.g., prevent direct public contact with sewage and avoid pathogenic contamination of ground water and surface waters); abate public nuisances (e.g., odors from pit privies and cess-pools); and provide cost-effective wastewater treatment systems and management programs. More recently, there has been an increased focus on preventing OWTS-related surface and ground water quality degradation and impacts on aquatic habitat. Program goals have been expanded to address nutrients, toxic substances, and a broader set of public health issues regarding pathogens. Onsite wastewater-related nutrient enrichment leading to algae blooms and eutrophication or low dissolved oxygen levels in surface waters is of concern, especially in waters that lack adequate assimilative capacity, such as lakes and coastal embayments or estuaries. The discharge of toxic substances into treatment systems and eventually into ground water has also become a more prominent concern, especially in situations where onsite/ decentralized treatment systems are used by commercial or institutional entities like gasoline service stations and nursing homes. The potential impacts from pathogens discharged from OWTS on shellfisheries and contact recreation activities have also moved some OWTS program managers to adopt goals to protect these resources.

Historically, in many jurisdictions the public health agency has had the primary role in setting program goals. Without documented health problems implicating onsite systems as the source of problem(s), some public health agencies have had little incentive to strengthen onsite management programs beyond the goals of ensuring there was no direct public contact with sewage or no obvious drinking water-related impacts, such as bacterial or chemical illnesses like methemoglobinemia (“blue baby syndrome”). The availability of more advanced assessment and monitoring methodologies and technologies and a better understanding of surface water and ground water interactions, however, has led to an increased focus on protecting water quality and aquatic habitat. As a result, in many states and localities, water quality agencies have become more involved in setting onsite

program goals and managing onsite wastewater programs. Some water quality agencies (e.g., departments of natural resources), however, lack direct authority or responsibility to regulate onsite systems. This lack of authority points to the need for increased coordination and mutual goal setting among health agencies that have such authority. Regardless of which agency has the legal authority to manage onsite systems, there is the recognition that both public health and water quality goals need to be incorporated into the management program's mission. Achievement of these goals requires a comprehensive watershed-based approach to ensure that all of the program's goals are met. Partnerships with multiple agencies and other entities are often required to integrate planning, public health protection, and watershed protection in a meaningful way. Because of the breadth of the issues affecting onsite system management, many programs depend on cooperative relationships with planning authorities, environmental protection and public health agencies, universities, system manufacturers, and service providers to help determine appropriate management goals and objectives.

### 2.4.3 Public health and resource protection goals

OWTS programs should integrate the following types of goals: public health protection, abatement of nuisances, ground and surface water resource protection, and aquatic ecosystem protection. Setting appropriate program goals helps onsite program managers determine desired performance goals for treatment systems and influence siting, design, and management criteria and requirements. Examples of more detailed goals follow.

#### *Public health protection goals:*

- Reduce health risk due to sewage backup in homes.
- Prevent ground water and well water contamination due to pathogens, nitrates, and toxic substances.
- Prevent surface water pollution due to pathogens, nutrients, and toxic substances.
- Protect shellfish habitat and harvest areas from pathogenic contamination and excessive nutrients
- Prevent sewage discharges to the ground surface to avoid direct public contact.

- Minimize risk from reuse of inadequately treated effluent for drinking water, irrigation, or other uses.
- Minimize risk from inadequate management of septic tank residuals.
- Minimize risk due to public access to system components.

#### *Public nuisance abatement goals:*

- Eliminate odors caused by inadequate plumbing and treatment processes.
- Eliminate odors or other nuisances related to transportation, reuse, or disposal of OWTS residuals (septage).

#### *Environmental protection goals:*

- Prevent and reduce adverse impacts on water resources due to pollutants discharged to onsite systems, e.g., toxic substances.
- Prevent and reduce nutrient overenrichment of surface waters.
- Protect sensitive aquatic habitat and biota

### 2.4.4 Comprehensive planning

Comprehensive planning for onsite systems has three important components: (1) establishing and implementing the management entity, (2) establishing internal planning processes for the management entity, and (3) coordination and involvement in the broader land-use planning process. Comprehensive

The Department of Environmental Resources and Health Department in Maryland's Prince George's County worked together to develop geographic information system (GIS) tools to quantify and mitigate nonpoint source nutrient loadings to the lower Patuxent River, which empties into the Chesapeake Bay. The agencies developed a database of information on existing onsite systems, including system age, type, and location, with additional data layers for depth to ground water and soils. The resulting GIS framework allows users to quantify nitrogen loadings and visualize likely impacts under a range of management scenarios. Information from GIS outputs is provided to decision makers for use in planning development and devising county management strategies.

Source: County Environmental Quarterly, 1997.



planning provides a mechanism to ensure that the program has the necessary information to function effectively.

It is necessary to ensure that onsite management issues are integrated into decisions regarding future growth and development. An effective onsite wastewater management program should be represented in the ongoing land use planning process to ensure achievement of the goals of the program and to assist planners in avoiding the shortcomings of past planning efforts, which generally allowed the limitations of conventional onsite technologies to drive some land use planning decisions. Such considerations are especially important in situations where centralized wastewater treatment systems are being considered as an alternative or adjunct to onsite or cluster systems. Comprehensive planning and land use zoning are typically interrelated and integrated: the comprehensive planning process results in the development of overarching policies and guidance, and the land use zoning process provides the detailed regulatory framework to implement the comprehensive plan. Honachefsky (2000) provides a good overview of comprehensive planning processes from an ecological perspective. In general, the comprehensive plan can be used to set the broad environmental protection goals of the community, and the zoning ordinance(s) can be used to

- Specify performance requirements for individual or clustered systems installed in unsewered areas, preferably by watershed and/or subwatershed.
- Limit or prevent development on sensitive natural resource lands or in critical areas.
- Encourage development in urban growth areas serviced by sewer systems, if adequate capacity exists.
- Factor considerations such as system density, hydraulic and pollutant loadings, proximity to water bodies, soil and hydrogeological conditions, and water quality/quantity into planning and zoning decisions.
- Restore impaired resources.

Integrating comprehensive planning and zoning programs with onsite wastewater program management also can provide a stronger foundation for determining and requiring the appropriate level of treatment needed for both the individual site and the surrounding watershed or subwatershed. The integrated approach thus allows the program manager to manage both existing and new onsite systems from a cumulative loadings perspective or performance-based approach that is oriented toward the protection of identified resources. Local health departments (regulatory authorities) charged with administering programs based on prescriptive codes typically have not had the flexibility or the re-

### Comprehensive planning program elements

- Define management program boundaries.
- Select management entity(ies).
- Establish human health and environmental protection goals.
- Form a planning team composed of management staff and local stakeholders.
- Identify internal and external planning resources and partners.
- Collect information on regional soils, topography, rainfall, and water quality and quantity.
- Identify sensitive ecological areas, recreational areas, and water supply protection areas.
- Characterize and map past, current, and future development where OWTs are necessary.
- Coordinate with local sewage authorities to identify current and future service areas and determine treatment plant capacity to accept septage.
- Identify documented problem areas and areas likely to be at risk in the future.
- Prioritize and target problem areas for action or future action.
- Develop performance requirements and strategies to deal with existing and possible problems.
- Implement strategy; monitor progress and modify strategy if necessary.



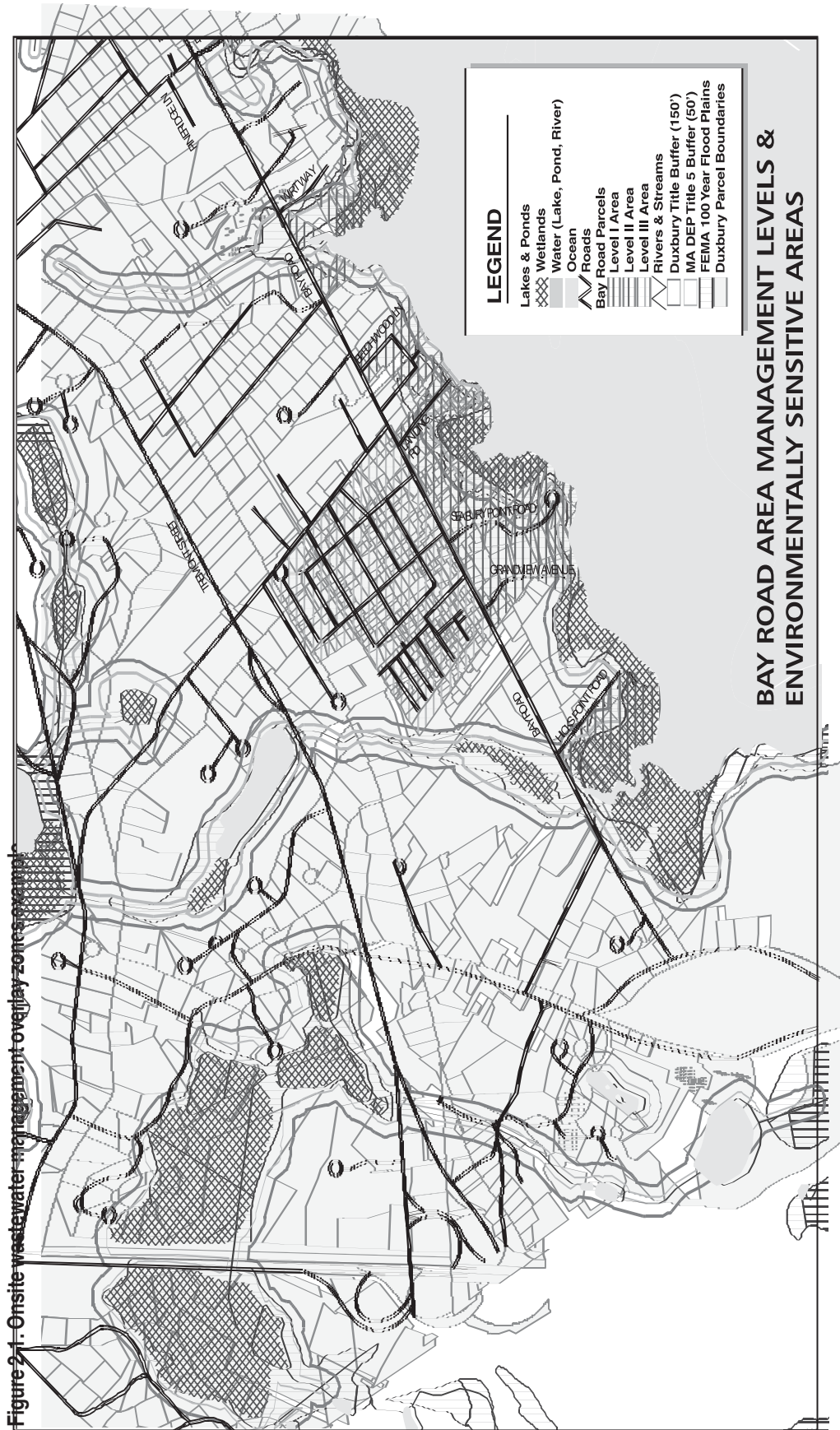


Figure 2-1: Onsite wastewater management overlay zones overlaid on the map.

Source: Heigis and Douglas, 2000.

sources to deviate from zoning designations and as a result often have had to approve permits for developments where onsite system-related impacts were anticipated. Coordinating onsite wastewater management with planning and zoning activities can ensure that parcels designated for development are permitted based on a specified level of onsite system performance that considers site characteristics and watershed-level pollutant loading analyses. To streamline this analytical process, some management programs designate overlay zones in which specific technologies or management strategies are required to protect sensitive environmental resources. These overlay zones may be based on soil type, topography, geology, hydrology, or other site characteristics (figure 2-1). Within these overlay zones, the RA may have the authority to specify maximum system densities, system design requirements, performance requirements, and operation/maintenance requirements. Although the use of overlay zones may streamline administrative efforts, establishing such programs involves the use of assumptions and generalizations until a sufficient number of site-specific evaluations are available to ensure proper siting and system selection.

Internally, changes in program goals, demographics, and technological advances require information and coordination to ensure that the short- and long-term goals of the program can continue to be met. Many variables affect the internal planning process, including factors such as the locations and types of treatment systems within the jurisdictional area, the present or future organizational and institutional structure of the management entity, and the funding available for program development and implementation.

The box “Performance-based program elements” (page 2-21) provides guidance for planning processes undertaken by an onsite/decentralized wastewater management entity. At a minimum, the onsite management entity should identify and delineate the planning region, develop program goals, and coordinate with the relevant public health, resource protection, economic development, and land-use planning agencies.

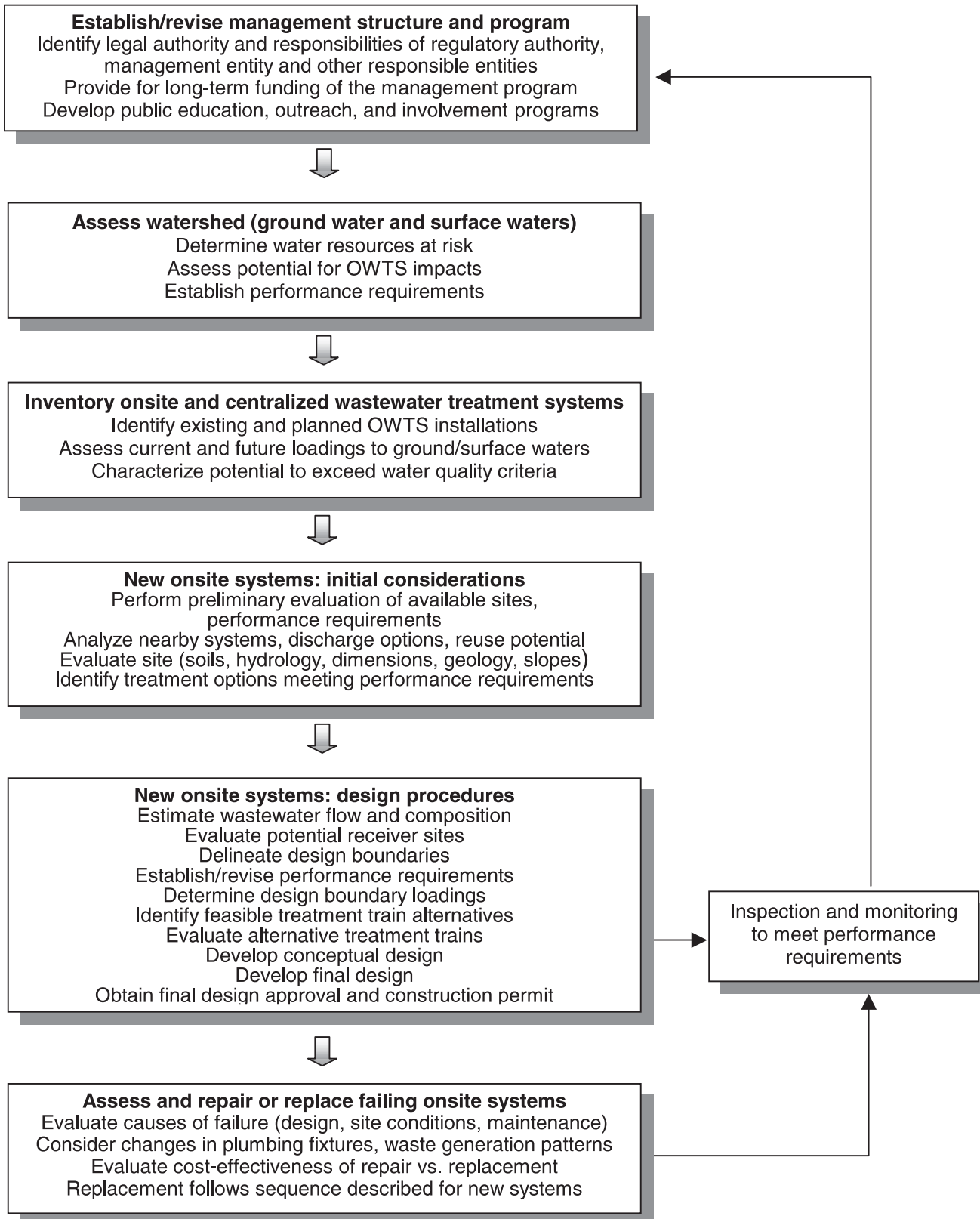
Figure 2-2 shows a process that might be useful in developing and implementing a performance-based program whose objectives are to protect specific resources or achieve stated public health objectives.

## 2.4.5 Performance requirements

Many state and local governments are currently adopting or considering the use of performance requirements to achieve their management goals. The management entity can use performance requirements to establish specific and measurable standards for the performance of onsite systems that are necessary to achieve the required level of environmental or public health protection for an identified management area and resource. All onsite wastewater management programs are based to varying degrees on this concept. Traditional programs have elected to use prescriptive siting, design, and setback requirements to dictate where and when conventional septic tank/SWIS systems are appropriate. The prescriptive standards were based on the presumption that systems sited and designed to these standards would protect public health. In most cases, this assumption provided an adequate level of protection, but the prescriptions often were based on standards adopted by others and not based on scientific evaluations of the site conditions of the community using them. As a result, many programs based on prescriptive requirements do not adequately protect the resource. (See chapter 5 for more detailed information about performance-based approaches.) The *NOWRA Model Framework for Unsewered Wastewater Infrastructure*, discussed in chapter 1, also provides a model for the development of performance-based programs (Walsh et al., 2001; see <http://www.nowra.org>).

Performance requirements provide the onsite system regulatory agency with an objective basis to oversee siting, system selection and design, installation, maintenance, and monitoring of OWTS in order to protect an identified resource or achieve a stated public health goal. In jurisdictions where performance requirements are used, the regulatory agency should not conduct site evaluations and specify system designs because of potential conflict of interest issues regarding enforcement and compliance; that is, the agency would be evaluating the performance of systems it designed and sited. The role of the regulatory agency in such a situation should be to establish performance requirements and provide oversight of management, operation, maintenance, and other activities conducted by private contractors or other entities.

Figure 2-2. Process for developing onsite wastewater management



Where appropriate, prescriptive guidelines for siting, design, and operation that are accepted by the management entity as meeting specific performance requirements for routine system applications can be appended to local codes or retained to avoid cost escalation and loss of qualified service providers (Otis et al., 2001). Designating performance requirements for areas of a management district with similar environmental sensitivities and site conditions can provide property owners with valuable information on performance expectations and their rationale (Otis et al., 2001). Performance standards can be determined based on the need to protect a site-specific resource, such as residential drinking wells, or they can be based on larger-scale analyses intended to manage cumulative OWTS pollutant loadings (e.g., to protect a lake or estuary from nutrient enrichment).

Implementation of performance-based programs might result in increased management expenditures due to the need for staff to conduct site or areawide (e.g., watersheds, subwatersheds, or other geographic areas) evaluations, inspect, and monitor system performance as necessary. Service provider training, the evaluation and approval of new or alternative system designs, public outreach efforts to establish public support for this approach, and new certification/licensing or permit programs will also increase program costs. These increases can usually be recovered through permit/license fees. Also, system owners will be responsible for operation and maintenance costs. The following

box contains a recommended list of elements for a performance-based program.

### 2.4.6 Performance requirements and the watershed approach

USEPA encourages the use of performance requirements on a watershed, subwatershed, or source water protection zone basis. These are useful natural units on which to develop and implement performance-based management strategies. In situations where jurisdictional boundaries cross watershed, subwatershed, or source water recharge boundaries, interagency coordination might be needed. Setting performance requirements for individual watersheds, subwatersheds, or source water areas allows the program manager to determine and allocate cumulative hydraulic and pollutant loads to ensure that the goals of the community can be met. To do so, an analysis to determine whether the cumulative pollutant or hydraulic loadings can be assimilated by the receiving environment without degrading the quality of the resource or use is necessary. There is some uncertainty in this process, and program managers should factor in a margin of safety to account for errors in load and treatment effectiveness estimates. (Refer to chapter 3 for more information on estimating treatment effectiveness.)

Onsite systems are typically only one of many potential sources of pollutants that can negatively affect ground or surface waters. In most cases other

#### Performance-based program elements

- Obtain or define legal authority to enact management regulations.
- Identify management area.
- Identify program goals.
- Identify specific resource areas that need an additional level of protection, e.g., drinking water aquifers, areas with existing water quality problems, and areas likely to be at risk in the future.
- Establish performance goals and performance requirements for the management area and specific watersheds, subwatersheds, or source water protection areas.
- Define performance boundaries and monitoring protocols.
- Determine and set specific requirements for onsite systems based on protecting specific management areas and achieving of a specified level of treatment (e.g., within a particular subbasin, there will be no discharge that contains more than 1.0 mg/L of total phosphorus).
- Develop or acquire information on alternative technologies, including effectiveness information and operation and maintenance requirements (see chapter 4).
- Develop a review process to evaluate system design and system components (see chapter 5).



### Establishing performance requirements at a watershed scale

Establishing performance requirements involves a sequential set of activities at both the landscape level and the site level. The following steps describe the general process of establishing performance requirements for onsite systems:

- Identify receiving waters (ground water, surface waters) for OWTS effluent.
- Define existing and planned uses for receiving waters (e.g., drinking water, recreation, habitat).
- Identify water quality standards associated with designated uses (check with state water agency).
- Determine types of OWTS-generated pollutants (e.g., nutrients, pathogens) that might affect use.
- Identify documented problem areas and areas likely to be at risk in the future.
- Determine whether OWTS pollutants pose risks to receiving waters.
- If there is a potential risk,
  - Estimate existing and projected OWTS contributions to total pollutant loadings.
  - Determine whether OWTS pollutant loadings will cause or contribute to violations of water quality or drinking water standards.
  - Establish maximum output level (mass or concentration in the receiving water body) for specified OWTS effluent pollutants based on the cumulative load analysis of all sources of pollutant(s) of concern.
  - Define performance boundaries for measurement of OWTS effluent and pollutant concentrations to achieve watershed- and site-level pollutant loading goals.

sources of OWTS-generated pollutants (primarily nutrients and pathogens), such as agricultural activities or wildlife, are also present in the watershed or subwatershed. To properly calculate the cumulative acceptable OWTS-generated pollutant loadings for a given watershed or subwatershed, all other significant sources of the pollutants that might be discharged by onsite systems should be identified. This process requires coordination between the onsite program manager and the agencies responsible for assessing and monitoring both surface waters and ground water. Once all significant sources have been identified, the relative contributions of the pollutants of concern from these sources should be determined and pollutant loading allocations made based on factors the community selects. State water quality standards and drinking source water protection requirements are usually the basis for this process. Once loading allocations have been made for all of the significant contributing sources, including onsite systems, the OWTS program manager needs to develop or revise the onsite program to ensure that the overall watershed-level goals of the program are met. Cumulative loadings from onsite systems must be within the parameters set under the loading allocations, and public health must be protected at the

site level; that is, the individual OWTS must meet the performance requirements at the treatment performance boundary or the point of compliance.

It should be noted that the performance-based approach is a useful program tool both to prevent degradation of a water resource and to restore a degraded resource. Additional information on antidegradation is available in USEPA's *Water Quality Standards Handbook*. (See <http://www.epa.gov/waterscience/library/wqstandards/handbook.pdf>. For general information on the USEPA Water Quality Standards Program, see <http://www.epa.gov/OST/standards/>.) The Clean Water Act Section 303(d) program (Total Maximum Daily Load [TMDL] program) has published numerous documents and technical tools regarding the development and implementation of pollutant load allocations. This information can be found at <http://www.epa.gov/owow/tmdl/>. (NOTE: The identification of other pollutant sources and the analyses of loadings and modeling related to TMDL are beyond the scope of this document.)

The text above contains a list of steps that the OWTS program manager should consider in developing performance requirements at a watershed scale.



The use of a watershed-based approach also affords the water quality and onsite program managers some flexibility in determining how to most cost-effectively meet the goals of the community. Given the presence of both onsite systems and other sources of pollutants of concern, evaluations can be made to determine the most cost-effective means of achieving pollutant load reductions. For example, farmer or homeowner nutrient management education might result in significant loading reductions of nitrogen that could offset the need to require expensive, more technically advanced onsite systems designed for nitrogen removal.

Watershed-level evaluations, especially in cases where new and refined monitoring methods are employed, might also negate the need for system upgrade or replacement in some watersheds. For example, new genetic tracing methods can provide the water quality program manager with a reliable tool to differentiate between human sources of fecal coliform and animal contributions, both domestic and wild (see chapter 3). The use of these new methods can be expensive, but they might provide onsite program managers with a means of eliminating onsite systems as a significant contributing source of pathogens.

Onsite program managers have legitimate concerns regarding the adoption of a performance-based approach. The inherent difficulty of determining cumulative loadings and their impacts on a watershed, the technical difficulties of monitoring the impacts of OWTS effluent, the evaluation of new technologies and the potential costs, staffing and expertise needed to implement a performance-based program can make this option more costly and difficult to implement. (NOTE: In general, the RA should not have the responsibility for monitoring systems

### Performance requirements in Texas

In 1996 Texas eliminated percolation test requirements for onsite systems and instituted new performance requirements for alternative systems (e.g., drip systems, intermittent sand filters, leaching chambers). Site evaluations in Texas are now based on soil and site analyses, and service providers must be certified. These actions were taken after onsite system installations nearly tripled between 1990 and 1997.

Source: Texas Natural Resource Conservation Commission, 1997.

### Arizona's performance-based technical standards

In 2001 Arizona adopted a rule containing technical standards for onsite systems with design flows less than 24,000 gallons per day (Arizona Administrative Code, Title 18, Chapters 5, 9, 11, and 14). Key provisions of the rule include site investigation requirements, identification of site limitations, design adjustments for better-than-primary treatment to overcome site limitations, and design criteria and nominal performance values for more than 20 treatment or effluent dispersal technologies. Applications for proposed systems are required to contain wastewater characterization information, technology selections that address site limitations, soil treatment calculations, and effluent dispersal area information. Technology-specific general ground water discharge permits required under the new rule specify design performance values for TSS, BOD, total coliforms, and TN. Products with satisfactory third-party performance verification data might receive additional credits for continuing performance improvement. The Arizona rule contains important elements of performance-based and hybrid approaches through adoption of performance values and specific use criteria for certain systems.

Source: Swanson, 2001.

other than conducting random quality assurance inspections. Likewise, the RA should not have the primary responsibility of evaluating new or alternative technologies. Technologies should be evaluated by an independent entity certified or licensed to conduct such evaluations, such as an RME.)

Prescriptive regulatory codes that specify technologies for installation under a defined set of site conditions have worked reasonably well in the past in many localities. The use of this approach, in which baseline design requirements and treatment effectiveness are estimated based on the use of the specified technology at similar sites, will continue to be a key component of most management programs because it is practical, efficient, and easy to implement. Programs based purely on prescriptive requirements, however, might not consistently provide the level of treatment needed to protect community water resources and public health. Many programs using prescriptive requirements are based on empirical relationships that do not necessarily result in appropriate levels of treatment. Site-specific factors can also result in inadequate treatment of OWTS effluent where a prescriptive approach is used. Political pressure to approve specific types of systems for use on sites where

### Florida's performance-based permit program

Florida adopted provisions for permitting residential performance-based treatment systems in September 2000. The permit regulations, which can be substituted for provisions governing the installation of onsite systems under existing prescriptive requirements, apply to a variety of alternative and innovative methods, materials, processes, and techniques for treating onsite wastewaters statewide. Discharges under the performance-based permit program must meet treatment performance criteria for secondary, advanced secondary, and advanced wastewater treatment, depending on system location and the proximity of protected water resources. Performance requirements for each category of treatment are as follows:

- *Secondary treatment:* annual arithmetic mean for BOD and TSS  $\leq 20$  mg/L, annual arithmetic mean for fecal coliform bacteria  $\leq 200$  cfu/100 mL.
- *Advanced secondary treatment:* annual arithmetic mean for BOD and TSS  $\leq 10$  mg/L, annual arithmetic mean for total nitrogen  $\leq 20$  mg/L, annual arithmetic mean for total phosphorus  $\leq 10$  mg/L, annual arithmetic mean for fecal coliform bacteria  $\leq 200$  cfu/100 mL.
- *Advanced wastewater treatment:* annual arithmetic mean for BOD and TSS  $\leq 5$  mg/L, annual arithmetic mean for total nitrogen  $\leq 3$  mg/L, annual arithmetic mean for total phosphorus  $\leq 1$  mg/L, fecal coliform bacteria count for any one sample  $\leq 25$  cfu/100 mL.

Operation and maintenance manuals, annual operating permits, signed maintenance contracts, and biannual inspections are required for all performance-based systems installed under the new regulation. The operating permits allow for property entry, observation, inspection, and monitoring of treatment systems by state health department personnel.

Source: Florida Administrative Code, 2000.

prescriptive criteria are not met is another factor that leads to the installation of inadequate systems.

#### 2.4.7 Implementing performance requirements through a hybrid management approach

RAs often adopt a “hybrid” approach that includes both prescriptive and performance elements. To set appropriate performance requirements, cumulative load analyses should be conducted to determine the assimilative capacity of the receiving environment(s). This process can be costly, time-consuming, and controversial when water resource characterization data are incomplete, absent, or contested. Because of these concerns, jurisdictions might elect to use prescriptive standards in areas where it has been determined that onsite systems are not a significant contributing source of pollutants or in areas where onsite systems are not likely to cause water quality problems. Prescriptive designs might also be appropriate and practical for sites where previous experience with specified OWTS designs has resulted in the demonstration of adequate performance (Ayres Associates, 1993).

In those areas where problems due to pollutants typically found in OWTS discharges have been identified and in areas where there is a significant threat of degradation due to OWTS discharges (e.g., source water protection areas, recreational swimming areas, and estuaries), performance requirements might be appropriate. The use of a performance-based approach allows jurisdictions to prioritize their resources and efforts to target collections of systems within an area or subwatershed or individual sites within a jurisdictional area.

#### 2.4.8 Developing and implementing performance requirements

OWTS performance requirements should be developed using risk-based analyses on a watershed or site level. They should be clear and quantifiable to allow credible verification of system performance through compliance monitoring. Performance requirements should at a minimum include stipulations that no plumbing backups or ground surface seepage may occur and that a specified level of ground/surface water quality must be maintained at some performance boundary, such as the terminus of the treatment train, ground water

surface, property line, or point of use (e.g., water supply well, recreational surface water, aquatic habitat area; see chapter 5).

If prescriptive designs are allowed under a performance-based program, these systems should be proven capable of meeting the same performance requirements as a system specifically designed for that site. Under this approach, the management entity should determine through experience (monitoring and evaluation of the prescribed systems on sites with similar site characteristics) that the system will perform adequately to meet stated performance requirements given sufficiently frequent operating inspections and maintenance.

Performance monitoring might be difficult and costly. Although plumbing backups and ground surface seepage can be easily and inexpensively observed through visual monitoring, monitoring the receiving environment (surface receiving waters and ground water) might be expensive and complicated. Monitoring of ground water is confounded by the difficulty of locating and sampling subsurface effluent plumes. Extended travel times, geologic factors, the presence of other sources of ground water recharge and pollutants, and the dispersal of OWTS pollutants in the subsurface all complicate ground water monitoring.

To avoid extensive sampling of ground water and surface waters, especially where there are other contributing sources of pollutants common to OWTS discharges, performance requirements can be set for the treated effluent at a designated performance boundary before release into the receiving environment (refer to chapters 3 and 5). Adjustments for the additional treatment, dispersion, and dilution that will occur between the performance boundary and the resource to be protected should be factored into the performance requirements. For example, pretreated wastewater is typically discharged to unsaturated soil, through which it percolates before it reaches ground water. The performance requirement should take into account the treatment due to physical (filtration), biological, and chemical processes in the soil, as well as the dispersion and dilution that will occur in the unsaturated soil and ground water prior to the point where the standard is applied.

As a practical matter, performance verification of onsite systems can be relaxed for identified types of

systems that the RA knows will perform as anticipated. Service or maintenance contracts or other legal mechanisms might be prerequisites to waiving or reducing monitoring requirements or inspections. The frequency and type of monitoring will depend on the management program, the technologies employed, and watershed- and site-specific factors. Monitoring and evaluation might occur at or near the site and include receiving environment or water quality monitoring and monitoring to ascertain hydraulic performance and influent flows. In addition, the OWTS management program needs to be evaluated to ascertain whether routine maintenance is occurring and whether individual systems and types of systems are operating properly.

Chapter 4 contains descriptions of most of the onsite wastewater treatment processes currently in use. OWTS program managers developing and implementing performance-based programs will often need to conduct their own site-specific evaluations of these treatment options. The text box that follows documents one approach used to cooperatively evaluate innovative or alternative wastewater treatment technologies. Many tribal, state, and local programs lack the capability to continually evaluate new and innovative technology alternatives and thus depend on regional evaluations and field performance monitoring to provide a basis on which to develop their programs.

### **2.4.9 Public education, outreach, and involvement**

Public education and outreach are critical aspects of an onsite management program to ensure public support for program development, implementation, and funding. In addition, a working understanding of the importance of system operation and maintenance is necessary to help ensure an effective program. In general the public will want to know the following:

- How much will it cost the community and the individual?
- Will the changes mean more development in my neighborhood? If so, how much?
- Will the changes prevent development?
- Will the changes protect our resources (drinking waters, shellfisheries, beaches)?

### A cooperative approach for approving innovative/alternative designs in New England

The New England Interstate Water Pollution Control Commission is a forum for consultation and cooperative action among six New England state environmental agencies. NEIWPC has adopted an interstate process for reviewing proposed wastewater treatment technologies. A technical review committee composed of representatives from New England state onsite wastewater programs and other experts evaluates innovative or alternative technologies or system components that replace part of a conventional system, modify conventional operation or performance, or provide a higher level of treatment than conventional onsite systems.

Three sets of evaluation criteria have been developed to assess proposed replacement, modification, or advanced treatment units. Review teams from NEIWPC assess the information provided and make determinations that are referred to the full committee. The criteria are tailored for each category but in general include:

- Treatment system or treatment unit size, function, and applicability or placement in the treatment train.
- Structural integrity, composition, durability, strength, and corresponding independent test results.
- Life expectancy and costs including comparisons with conventional systems/units.
- Availability and cost of parts, service, and technical assistance.
- Test data on prior installations or uses, test conditions, failure analysis, and tester identity.

Source: *New England Interstate Water Pollution Control Commission, 2000.*

- How do the proposed management alternatives relate to the above questions?

A public outreach and education program should focus on three components—program audience, information about the program, and public outreach media. An effective public outreach program makes information as accessible as possible to the public by presenting the information in a nontechnical format. The public and other interested parties should be identified, contacted, and consulted early in the process of making major decisions or proposing significant program changes. Targeting the audience of the public outreach and education program is important for both maximizing public participation and ensuring public confidence in the management program. For onsite wastewater system management programs, the audiences of a public outreach and education program can vary and might include:

- Homeowners
- Manufacturers
- Installers
- System operators and maintenance contractors
- Commercial or industrial property owner
- Public agency planners
- Inspectors
- Site evaluators
- Public
- Students

- Citizen groups and homeowner neighborhood associations
- Civic groups such as the local Chamber of Commerce
- Environmental groups

Onsite management entities should also promote and support the formation of citizen advisory groups composed of community members to build or enhance public involvement in the management program. These groups can play a crucial role in representing community interests and promoting support for the program.

Typical public outreach and education program information includes:

- Promoting water conservation
- Preventing household and commercial/industrial hazardous waste discharges
- Benefits of the onsite management program

Public outreach and education programs use a variety of media options available for information dissemination, including:

- Local newspapers
- Radio and TV
- Speeches and presentations
- Exhibits and demonstrations
- Conferences and workshops
- Public meetings



**Site evaluation program elements**

- Establish administrative processes for permit/site evaluation applications.
- Establish processes and policies for evaluating site conditions (e.g., soils, slopes, water resources).
- Develop and implement criteria and protocols for wastewater characterization.
- Determine level of skill and training required for site evaluators.
- Establish licensing/certification programs for site evaluators.
- Offer training opportunities as necessary.

- School programs
- Local and community newsletters
- Reports
- Direct mailings, e.g., flyers with utility bills

**2.4.10 Site evaluation**

Evaluating a proposed site in terms of its environmental conditions (climate, geology, slopes, soils/landscape position, ground water and surface water aspects), physical features (property lines, wells, hydrologic boundaries structures), and wastewater characteristics (anticipated flow, pollutant content, waste strength) provides the information needed to size, select, and site the appropriate wastewater treatment system. In most cases (i.e., under current state codes and lower-level management entity structures) RAs issue permits—legal authorizations to install and operate a particular system at a specific site—based on the information collected and analyses performed during the site evaluation. (NOTE: Detailed wastewater characterization procedures are discussed in chapter 3; site evaluation processes are presented in section 5.5.)

**2.4.11 System design criteria and approval process**

Performance requirements for onsite systems can be grouped into two general categories—numeric requirements and narrative criteria. Numeric requirements set measurable concentration or mass loading limits for specific pollutants (e.g., nitrogen or pathogen concentrations). Narrative requirements describe acceptable qualitative aspects of the

wastewater (e.g., sewage surface pooling, odor). A numerical performance requirement might be that all septic systems in environmentally sensitive areas must discharge no more than 5 pounds of nitrogen per year, or that concentrations of nitrogen in the effluent may be no greater than 10 mg/L. Some of the parameters for which performance requirements are commonly set for OWTSS include:

- Fecal coliform bacteria (an indicator of pathogens)
- Biochemical oxygen demand (BOD)
- Nitrogen (total of all forms, i.e., organic, ammonia, nitrite, nitrate)
- Phosphorus (for surface waters)
- Nuisance parameters (e.g., odor, color)

Under a performance-based approach, performance requirements, site conditions, and wastewater characterization information drive the selection of treatment technologies at each site. For known technologies with extensive testing and field data, the management agency might attempt to institute performance requirements prescriptively by designating system type, size, construction practices, materials to be used, acceptable site conditions, and siting requirements. For example, the Arizona Department of Environmental Quality has adopted a rule that establishes definitions, permit requirements, restrictions, and performance criteria for a wide range of conventional and alternative treatment systems. (Swanson, 2001). Alaska requires a 2-foot-thick sand liner when the receiving soil percolates at a rate faster than 1 minute per inch (Alaska Administrative Code, 1999). At a minimum, prescriptive system design criteria

**Performance requirements and system design in Massachusetts**

Massachusetts onsite regulations identify certain wellhead protection areas, public water supply recharge zones, and coastal embayments as nitrogen-sensitive areas and require OWTSS in those areas to meet nitrogen loading limitations. For example, recirculating sand filters or equivalent technologies must limit total nitrogen concentrations in effluent to no more than 25 mg/L and remove at least 40 percent of the influent nitrogen load. All systems in nitrogen-sensitive areas must discharge no more than 440 gallons of design flow per acre per day unless system effluent meets a nitrate standard of 10 mg/L or other nitrogen removal technologies or attenuation strategies are used.

*Source: Massachusetts Environmental Code, Title V.*



should consider the following. (See chapter 5 for details.)

- Wastewater characterization and expected effluent volumes.
- Site conditions (e.g., soils, geology, ground water, surface waters, topography, structures, property lines).
- System capacity, based on estimated peak and average daily flows.
- Location of tanks and appurtenances.
- Tank dimensions and construction materials.
- Alternative tank effluent treatment units and configuration.
- Required absorption field dimensions and materials.
- Requirements for alternative soil absorption field areas.
- Sizing and other acceptable features of system piping.
- Separation distances from other site features.
- Operation and maintenance requirements (access risers, safety considerations, inspection points).
- Accommodations required for monitoring.

#### 2.4.12 Construction and installation oversight authority

A comprehensive construction management program will ensure that system design and specifications are followed during the construction process. If a system is not constructed and installed properly, it is unlikely to function as intended. For

##### Simplified incorporation of system design requirements into a regulatory program: the Idaho approach

Idaho bypasses cumbersome legislative processes when making adjustments to its onsite system design guidelines by referencing a technical manual in the regulation that is not part of the state regulation. Under this approach, new research findings, new technologies, or other information needed to improve system design and performance can be incorporated into the technical guidance without invoking the regulatory rulemaking process. The regulations contain information on legal authority, responsibilities, permit processes, septic tanks, and conventional systems. The reference guidance manual outlines types of alternative systems that can be installed, technical and design considerations, soil considerations, and operation and maintenance requirements.

Source: Adapted from NSFC, 1995b.

##### Construction oversight program elements

- Establish preconstruction review procedure for site evaluation and system design.
- Determine training and qualifications of system designers and installers.
- Establish designer and installer licensing and certification programs.
- Define and codify construction oversight requirements.
- Develop certification process for overseeing and approving system installation.
- Arrange training opportunities for service providers as necessary

example, if the natural soil structure is not preserved during the installation process (if equipment compacts infiltration field soils), the percolation potential of the infiltration field can be significantly reduced. Most early failures of conventional onsite systems' soil absorption fields have been attributed to hydraulic overloading (USEPA, 1980). Effective onsite system management programs ensure proper system construction and installation through construction permitting, inspection, and certification programs.

Construction should conform to the approved plan and use appropriate methods, materials, and equipment. Mechanisms to verify compliance with performance requirements should be established to ensure that practices meet expectations. Typical existing regulatory mechanisms that ensure proper installation include reviews of site evaluation procedures and findings and inspections of systems during and after installation, i.e., before cover-up and final grading. A more effective review and inspection process should include

- Predesign meeting with designer, owner, and contractor
- Preconstruction meeting with designer, owner, and contractor
- Field verification and staking of each system component
- Inspections during and after construction
- Issuance of a permit to operate system as designed and built

Construction oversight inspections should be conducted at several stages during the system installation process to ensure compliance with regulatory requirements. During the construction process, inspections before and after backfilling should verify compliance with approved construction documents and procedures. An approved (i.e., licensed or certified) construction oversight inspector, preferably the designer of the system, should oversee installation and certify that it has been conducted and recorded properly. The construction process for soil-based systems must be flexible to accommodate weather events because construction during wet weather can compact soils in the infiltration field or otherwise alter soil structure.

### 2.4.13 Operation and maintenance requirements

A recurring weakness of many existing OWTS management programs has been the failure to ensure proper operation and maintenance of installed systems. Few existing oversight agencies conduct inspections to verify basic system performance, and many depend on uninformed, untrained system owners to monitor tank residuals buildup, schedule pumping, ensure that flow distribution is occurring properly, check pumps and float switches, inspect filtration media for clogging, and perform other monitoring and maintenance tasks. Complaints to the regulatory authority or severe and obvious system failures often provide the only formal notification of problems under present codes. Inspection and other programs that monitor system performance (e.g., Critical Point Monitoring; see chapter 3) can help reduce the risk of

premature system failure, decrease long-term investment costs, and lower the risk of ground water or surface water contamination (Eliasson et al., 2001; Washington Department of Health, 1994).

Various options are available to implement operation and maintenance oversight programs. These range from purely voluntary (e.g., trained homeowners responsible for their system operation and maintenance activities) to more sophisticated operating permit programs and ultimately to programs administered by designated RMEs that conduct all management/maintenance tasks. In general, voluntary maintenance is possible only where systems are nonmechanical and gravity-based and located in areas with very low population densities. The level of management should increase if the system is more complex or the resource(s) to be protected require a higher level of performance.

Alarms (onsite and remote) should be considered to alert homeowners and service providers that system malfunction might be occurring. In addition to simple float alarms, several manufacturers have developed custom-built control systems that can program and schedule treatment process events, remotely monitor system operation, and notify technicians by pager or the Internet of possible problems. New wireless and computer protocols, cellular phones, and personal digital assistants are being developed to allow system managers to remotely monitor and assess operation of many systems simultaneously (Nawathe, 2000), further enhancing the centralized management of OWTSs in outlying locations. Using such tools can save considerable travel and inspection time and focus

#### Operation, maintenance, and residuals management program elements

- Establish guidelines or permit program for operation and maintenance of systems.
- Develop reporting system for operation and maintenance activities.
- Circulate operation and maintenance information and reminders to system owners.
- Develop operation and maintenance inspection and compliance verification program.
- Establish licensing/certification programs for service providers.
- Arrange for training opportunities as necessary.
- Establish procedures for follow-up notices or action when appropriate.
- Establish reporting and reminder system for monitoring system effluent.
- Establish residuals (septage) management requirements, manifest system, and disposal/use reporting.

### Onsite system disclosure requirements in Minnesota

Minnesota law requires that before signing an agreement to sell or transfer real property, a seller must disclose to a buyer in writing the status and location of all septic systems on the property, including existing or abandoned systems. If there is no onsite treatment system on the property, the seller can satisfy the disclosure requirement by making such a declaration at the time of property transfer. The disclosure must indicate whether the system is in use and whether it is, to the seller's knowledge, in compliance with applicable laws and rules. A map indicating the location of the system on the property must also be included. A seller who fails to disclose the existence or known status of a septic system at the time of sale and who knew or had reason to know the existence or known status of a system might be liable to the buyer for costs relating to bringing the system into compliance, as well as reasonable attorney's fees incurred in collecting the costs from the seller. An action for collection of these sums must be brought within 2 years of the closing date.

Source: *Minnesota Statutes, 2000.*

field personnel on systems that require attention or regular maintenance. Telemetry panels at the treatment site operating through existing or dedicated phone lines can be programmed to log and report information such as high/low water alarm warnings, pump run and interval times, water level readings in tanks/ponds, amperage drawn by system pumps, and other conditions. Operators at a centralized monitoring site can adjust pump run cycles, pump operation times, alarm settings, and high-level pump override cycles (Stephens, 2000).

Some management entities have instituted comprehensive programs that feature renewable/revocable operating permits, mandatory inspections or disclosure (notification/inspection) upon property transfer (e.g., Minnesota, Wisconsin, Massachusetts), and/or periodic monitoring by licensed inspectors. Renewable operating permits might require system owners to have a contract with a certified inspection/maintenance contractor or otherwise demonstrate that periodic inspection and maintenance procedures have been performed for permit renewal (Wisconsin Department of Commerce, 2001). Minnesota, Wisconsin, Massachusetts, and some counties (e.g., Cayuga and other counties in New York, Washtenaw County in Michigan) require that sellers of property disclose or verify system performance (e.g., disclosure statement, inspection by the local oversight entity or other approved inspector) prior to property transfer. Financial incentives usually aid compliance and can vary from small fines for poor system maintenance to preventing the sale of a house if the OWTS is not functioning properly. Inspection fees might be one way to cover or defray these program costs. Lending institutions nationwide have influenced the adoption of a more aggressive approach toward requiring

system inspections before home or property loans are approved. In some areas, inspections at the time of property transfer are common despite the absence of regulatory requirements. This practice is incorporated into the loan and asset protection policies of local banks and lending firms.

RAs, however, should recognize that reliance on lending institutions to ensure that proper inspections occur can result in gaps. Property transfers without lending institution involvement might occur without inspections. In addition, in cases where inspections are conducted by private individuals reporting to the lending agents, the inspectors might not have the same degree of accountability that would occur in jurisdictions that have mandatory requirements for state or local licensing or certification of inspectors. RAs should require periodic inspections of systems based on system design life, system complexity, and changes in ownership.

Wisconsin's new Private Onsite Wastewater Treatment System rule (see <http://www.commerce.state.wi.us/SB/SB-POWTSProgram.html>) requires management plans for all onsite treatment systems. The plans must include information and procedures for maintaining the systems in accordance with the standards of the code as designed and approved. Any new or existing system that is not maintained in accordance with the approved management plan is considered a human health hazard and subject to enforcement actions. The maintenance requirements are specified in the code. All septic tanks are to be pumped when the combined sludge and scum volume equals one-third of the tank volume. Existing systems have the added requirement of visual inspections every 3 years for

### Requiring pump-outs to ensure proper maintenance

Periodic pumping of septic tanks is now required by law in some jurisdictions and is becoming established practice for many public and private management entities. In 1991 Fairfax County, Virginia, amended its onsite systems management code to require pumping at least every 5 years. The action, which was based on provisions of the Chesapeake Bay Preservation Act, was accompanied by public outreach notices and news articles. System owners must provide the county health department with a written notification within 10 days of pumpout. A receipt from the pumpout contractor, who must be licensed to handle septic tank residuals, must accompany the notification.

Source: Fairfax County Health Department, 1995.

wastewater ponding on the ground surface. Only persons certified by the department may perform the inspections or maintenance. Systems requiring maintenance more than once annually require signed maintenance contracts and a notice of maintenance requirements on the property deed. The system owner or designated agent of the owner must report to the department each inspection or maintenance action specified in the management plan at its completion (Wisconsin Department of Commerce, 2001).

### 2.4.14 Residuals management requirements

The primary objective of residuals management is to establish procedures and rules for handling and disposing of accumulated wastewater treatment system residuals to protect public health and the environment. These residuals can include septage removed from septic tanks and other by-products of the treatment process (e.g., aerobic-unit-generated sludge). When planning a program a thorough knowledge of legal and regulatory requirements regarding handling and disposal is important. In general, state and local septage management programs that incorporate land application or burial of septage must comply with Title 40 of the U.S. Code of Federal Regulations (CFR), Parts 503 and 257. Detailed guidance for identifying, selecting, developing, and operating reuse or disposal sites for septage can be found in the USEPA *Process Design Manual: Land Application of Sewage Sludge and Domestic Septage* (USEPA, 1995c), which is posted on the Internet at <http://www.epa.gov/ORD/WebPubs/sludge.pdf>. Additional information is provided in *Domestic Septage Regulatory Guidance* (USEPA, 1993b), posted at <http://www.epa.gov/oia/tips/scws.htm>. Another document useful to practitioners and small communities is the *Guide to Septage Treatment and Disposal* (USEPA, 1994).

States and municipalities typically establish other public health and environmental protection regulations for residuals handling, transport, treatment, and reuse/disposal. In addition to regulations, practical

### Installer and designer permitting in New Hampshire

Onsite system designers and installers in New Hampshire have been required to obtain state-issued permits since 1979. The New Hampshire's Department of Environmental Services Subsurface Systems Bureau issues the permits, which must be renewed annually. Permits are issued after successful completion of written examinations. The designer's test consists of three written sections and a field test for soil analysis and interpretation. The installers must pass only one written examination.

The tests are broad and comprehensive, and they assess the candidate's knowledge of New Hampshire's codified system design, regulatory setbacks, methods of construction, types of effluent disposal systems, and new technology. Completing the three tests designers must take requires about 5 hours. The passing grade is 80 percent. The field test measures competency in soil science through an analysis of a backhoe pit, determination of hydric soils, and recognition of other wetland conditions. The 2-hour written exam for installers measures understanding of topography, regulatory setbacks, seasonal high water table determination, and acceptable methods of system construction.

Sources: Bass, 2000; New Hampshire Department of Environmental Services, 1991.



**RA/ME activities for training, certifying, and licensing service providers**

- Identify tasks that require in-house or contractor certified/licensed professionals.
- Develop certification and/or licensing program based on performance requirements.
- Establish process for certification/licensing applications and renewals if necessary.
- Develop database of service providers, service provider qualifications and contact information.
- Establish education, training, and experience requirements for service providers.
- Develop or identify continuing training opportunities for service providers.
- Circulate information on available training to service providers.
- Update service provider database to reflect verified training participation/performance.

limitations such as land availability, site conditions, buffer zone requirements, hauling distances, fuel costs, and labor costs play a major role in evaluating septage reuse/disposal options. These options generally fall into three basic categories—land application, treatment at a wastewater treatment plant, and treatment at a special septage treatment plant (see chapter 4). The initial steps in the residuals reuse/disposal decision-making process are characterizing the quality of the septage and determining potential adverse impacts associated with various reuse/disposal scenarios. In general, program officials strive to minimize exposure of humans, animals, ground water, and ecological resources to the potentially toxic or

hazardous chemicals and pathogenic organisms found in septage. Other key areas of residuals management programs include tracking or manifest systems that identify septage sources, pumps, transport equipment, final destinations, and treatment methods, as well as procedures for controlling human exposure to residuals, including vector control, wet weather runoff management, and limits on access to disposal sites. (Refer to chapter 4 for more details.)

**2.4.15 Certification and licensing of service providers and program staff**

Certification and licensing of service providers such as septage haulers, designers, installers, and maintenance personnel can help ensure management program effectiveness and compliance and reduce the administrative burden on the RA. Certification and licensing of service providers is an effective means of ensuring that a high degree of professionalism and experience is necessary to perform specified activities. Maine instituted a licensing program for site evaluators in 1974 and saw system failure rates drop to insignificant levels (Kreissl, 1982). The text box that follows provides a list of activities that management entities should consider in setting up certification and licensing programs or requirements.

RAs should establish minimum criteria for licensing/certification of all service providers to ensure protection of health and water resources. Maine requires that site evaluators be licensed (certified) and that designers of systems treating more than

**Statewide training institute for onsite professionals in North Carolina**

North Carolina State University and other partners in the state developed the Subsurface Wastewater System Operator Training School (see <http://www.soil.ncsu.edu/swetc/subsurface/subsurface.htm>) in response to state rules requiring operators of some systems (e.g., large systems and those using low-pressure pipe, drip irrigation, pressure-dosed sand filter, or peat biofilter technologies) to be certified. The school includes classroom sessions on wastewater characteristics, laws, regulations, permit requirements, and the theory and concepts underlying subsurface treatment and dispersal systems. Training units also cover the essential elements of operating small and large mechanical systems, with field work in alternative system operation at NCSU's field laboratory. Participants receive a training manual before they arrive for the 3-day training course. Certification of those successfully completing the educational program is handled by the Water Pollution Control System Operators Certification Commission, an independent entity that tests and certifies system operators throughout North Carolina.

Source: NCSU, 2001



2,000 gallons per day or systems with unusual wastewater characteristics be registered professional engineers. Prerequisites for applying for a site evaluator permit and taking the certification examination are either a degree in engineering,

soils, geology, or a similar field plus 1 year of experience or a high school diploma or equivalent and 4 years of experience (Maine Department of Human Services, 1996). State certification and licensing programs are summarized in table 2-2.

Table 2-2. Survey of state certification and licensing programs

State	Contractors	Installers	Inspectors	Pumpers	Designers	Engineers	Geologists	Operators
Alabama	Y	Y	Y	Y	N	Y	Y	Y
Alaska	Y	Y	NA	NA	NA	Y	NA	NA
Arizona	Y	Y	NA	Y	NA	Y	Y	NA
Arkansas	N	Y	N	Y	Y	N	N	N
California	N	N	N	N	N	N	N	N
Colorado	N	N	N	N	N	Y	N	Y
Connecticut	NA	Y	Y	Y	NA	Y	NA	NA
Delaware	Y	Y	N	Y	Y	Y	Y	Y
Florida	Y	Y	Y	Y	N	N	N	N
Georgia	Y	Y	Y	Y	N	N	N	N
Hawaii	N	N	N	N	N	Y	N	Y
Idaho	N	Y	Y	Y	N	N	N	N
Illinois	Y	Y	NA	Y	NA	NA	NA	NA
Indiana	N	N	N	N	N	N	N	N
Iowa	N	N	N	Y	N	N	N	N
Kansas	NA	NA	NA	NA	NA	Y	Y	Y
Kentucky	Y	Y	Y	Y	N	N	N	N
Louisiana	NA	Y	NA	NA	NA	NA	NA	NA
Maine	N	Y	Y	N	Y	Y	Y	N
Maryland	N	Y	Y	N	N	N	N	N
Massachusetts	Y	Y	Y	Y	Y	Y	N	Y
Michigan	N	N	N	N	N	N	N	N
Minnesota	NA	Y	Y	Y	Y	NA	NA	Y
Mississippi	NA	Y	Y	Y	NA	NA	NA	NA
Missouri	Y	N	N	Y	N	Y	N	N
Montana	N	N	N	N	N	N	N	N
Nebraska	N	N	N	N	N	N	N	N
Nevada	NA	NA	NA	NA	NA	NA	NA	NA
New Hampshire	N	Y	N	N	Y	Y	N	Y
New Jersey	N	N	N	N	N	N	N	N
New Mexico	Y	Y	N	N	N	N	N	N
New York	N	N	N	Y	N	N	N	N
North Carolina	N	N	Y	Y	N	N	N	Y
North Dakota	Y	Y	Y	N	N	N	N	N
Ohio	N	N	N	N	N	N	N	N
Oklahoma	Y	Y	N	Y	Y	N	N	Y
Oregon	Y	Y	Y	Y	Y	Y	Y	Y
Pennsylvania	N	N	Y	N	N	Y	Y	N
Rhode Island	Y	Y	Y	N	Y	Y	N	Y
South Carolina	Y	Y	NA	Y	NA	NA	NA	NA
South Dakota	N	Y	N	N	N	N	N	N
Tennessee	N	Y	N	Y	N	Y	Y	Y
Texas	N	Y	Y	Y	N	N	N	Y
Utah	N	N	N	N	N	N	N	N
Vermont	N	N	N	N	Y	N	N	Y
Virginia	N	N	N	N	N	Y	Y	Y
Washington	N	N	Y	N	Y	N	N	N
West Virginia	N	Y	N	Y	N	N	N	N
Wisconsin	N	Y	Y	Y	Y	Y	Y	N
Wyoming	N	N	N	N	Y	Y	Y	N

Source: Noah, 2000.

### 2.4.16 Education and training programs for service providers and program staff

Onsite system RAs, RMEs, and service provider staff should have the requisite level of training and experience to effectively assume necessary program responsibilities and perform necessary activities. Professional programs are typically the mechanism for ensuring the qualifications of these personnel. They usually include licensing or certification elements, which are based on required coursework or training; an assessment of knowledge, skills, and professional judgment; past experience; and demonstrated competency. Most licensing programs require continuing education through recommended or required workshops at specified intervals. For example, the Minnesota program noted previously requires 3 additional days of training every 3 years. Certification programs for inspectors, installers, and septage haulers provide assurance that systems are installed and maintained properly. States are beginning to require such certification for all service providers to ensure that activities the providers conduct comply with program requirements. Violation of program requirements or poor performance can lead to revocation of certification and prohibitions on installing or servicing onsite systems. This approach, which links professional performance with economic incentives, is highly effective in maintaining compliance with onsite program requirements. Programs that simply

register service providers or fail to take disciplinary action against poor performers cannot provide the same level of pressure to comply with professional and technical codes of behavior.

Some certification and licensing programs for those implementing regulations and performing site evaluations require higher educational achievement. For example, Kentucky requires a 4-year college degree with 24 hours of science coursework, completion of a week-long soils characterization class, and another week of in-service training for all permit writers and site evaluators (Kentucky Revised Statutes, 2001). Regular training sessions are also important in keeping site evaluators, permit writers, designers, and other service personnel effective. For example, the Minnesota Cooperative Extension Service administers 3-day workshops on basic and advanced inspection and maintenance practices, which are now required for certification in 35 counties and most cities in the state (Shephard, 1996). Comprehensive training programs have been developed in other states, including West Virginia and Rhode Island.

Sixteen states have training centers. For more information on training programs for onsite wastewater professionals, including a calendar of planned training events and links to training providers nationwide, visit the web site of the National Environmental Training Center for Small Communities at West Virginia University at <http://www.estd.wvu.edu/netc/>

#### **NSF onsite wastewater inspector accreditation program**

NSF International has developed an accreditation program designed to verify the proficiency of persons performing inspections of existing OWTs. The accreditation program includes written and field tests and provides credit for continuing education activities. Inspectors who pass the tests and receive accreditation are listed on the NSF International web site and in the NSF Listing Book, which is circulated among industry, government, and other groups.

The accreditation process includes four components. A written examination, conducted at designated locations around the country, covers a broad range of topics related to system inspections, including equipment, evaluation procedures, troubleshooting, and the NSF International Certification Policies. The field examination includes an evaluation of an existing OWT. An ethics statement, required as part of the accreditation, includes a pledge by the applicant to maintain a high level of honesty and integrity in the performance of evaluation activities. Finally, the continuing education component requires requalification every 5 years through retesting or earning requalification credits by means of training or other activities.

To pass the written examination, applicants must answer correctly at least 75 of the 100 multiple-choice questions and score at least 70 percent on the field evaluation. A 30-day wait is required for retesting if the applicant fails either the written or field examination.

Source: Noah, 2000.

### Inspection and monitoring program elements

- Develop/maintain inventory of all systems in management area (e.g., location, age, owner, type, size).
- Establish schedule, parameters, and procedures for system inspections.
- Determine knowledge level required of inspectors and monitoring program staff.
- Ensure training opportunities for all staff and service providers.
- Establish licensing/certification program for inspectors.
- Develop inspection program (e.g., owner inspection, staff inspection, contractor inspection).
- Establish right-of-entry provisions to gain access for inspection or monitoring.
- Circulate inspection program details and schedules to system owners.
- Establish reporting system and database for inspection and monitoring program.
- Identify existing ground water and surface water monitoring in area and determine supplemental monitoring required.

#### Providing legal access for inspections in Colorado

Colorado regulations state that “the health officer or his/her designated agent is authorized to enter upon private property at reasonable times and upon reasonable notice . . . to conduct required tests, take samples, monitor compliance, and make inspections.”

Source: NSFC, 1995a.

[NETCSC\\_curricula.html](#). For links to state onsite regulatory agencies, codes, and other information, visit <http://www.estd.wvu.edu/nsfc/>  
[NSFC\\_links.html](#).

#### 2.4.17 Inspection and monitoring programs to verify and assess system performance

Routine inspections should be performed to ascertain system effectiveness. The type and frequency of inspections should be determined by the size of the area, site conditions, resource sensitivity, the complexity and number of systems, and the resources of the RA or RME. The RA should ensure that correct procedures are followed.

Scheduling inspections during seasonal rises in ground water levels can allow monitoring of performance during “worst case” conditions. A site inspection program can be implemented as a system owner training program, an owner/operator contract program with certified operators, or a routine program performed by an RME. A combination of

visual, physical, bacteriological, chemical, and remote monitoring and modeling can be used to assess system performance. Specific requirements for reporting to the appropriate regulatory agency should be clearly defined for the management program. Components of an effective inspection, monitoring, operation, and maintenance program include

- Specified intervals for required inspections (e.g., every 3 months, every 2 years, at time of property transfer or change of use).
- Legal authority to access system components for inspections, monitoring, and maintenance.
- Monitoring of overall operation and performance, including remote sensing and failure reporting for highly mechanical and complex systems.
- Monitoring of receiving environments at compliance boundaries to meet performance requirements.
- Review of system use or flow records, (e.g., water meter readings).
- Required type and frequency of maintenance for each technology.
- Identification, location, and analysis of system failures.
- Correction schedules for failed systems through retrofits or upgrades.
- Record keeping on systems inspected, results, and recommendations.

Inspection programs are often incorporated into comprehensive management programs as part of a

seamless approach that includes planning site evaluation, design, installation, operation, maintenance, and monitoring. For example, the Town of Paradise, California, established an onsite wastewater management program in Butte County in 1992 after voters rejected a sewage plant proposal for a commercial area (NSFC, 1996). The program manages 16,000 systems through a system of installation permits, inspections, and operating permits with terms up to 7 years. Operating permit fees are less than \$15 per year and are included in monthly water bills. Regular inspections, tank pumping, and other maintenance activities are conducted by trained, licensed service providers, who report their activities to program administra-

tors. Paradise is one of the largest unsewered incorporated towns in the nation.

Outreach programs to lending institutions on the benefits of requiring system inspections at the time of property transfer can be an effective approach for identifying and correcting potential problems and avoiding compliance and enforcement actions. Many lending institutions across the nation require system inspections as part of the disclosure requirements for approving home or property loans. For example, Washington State has disclosure provisions for realtors at the point of sale, and many lending institutions have incorporated onsite system performance disclosure statements into their loan approval processes (Soltman, 2000)

<b>Regulatory component</b>	<b>Description/function</b>
Legal authority	State and local laws, regulations, ordinances, and the like that assign authority to enact specific onsite wastewater system management regulations and operate management program.
Administration	Processes, procedures, and operational practices for system planning, design approval, permitting, inspection, reporting, enforcement, and other functions. Includes licensing, certification, or registration of service providers, training requirements, and so forth.
Definitions	Definitions of the terms used in the regulations.
Location/separation guidelines	Guidelines for siting system components at specified minimum distances from wells, residences, property lines, surface waters, and ground water (e.g., perched water tables, seasonal high water table).
Site evaluation	Analyses and evaluations of soil classification, depth, and structure. Assessment of hydrogeology, slopes, vegetation, and other features for each site proposed for system installation.
System selection and design criteria	Criteria for proposed systems based on site conditions, wastewater characterization, anticipated flow, public health and resource protection goals, and treatment technologies.
Construction and permitting	Mandatory approval processes for constructing a designated system at a particular site. Based on site evaluation and system design and selection criteria (see above).
Performance requirements	Numeric or narrative requirements for system effluent discharges. Based on health and resource protection goals.
Operation and maintenance	Requirements for proper operation (e.g., no solvent discharges to onsite system) and maintenance (e.g., tank pumped every 3 years) of system components.
Enforcement	Incentives (e.g., operating permit renewed) and disincentives (e.g., fines, water service suspended) to ensure compliance with onsite system regulations.
Licensing and certification	Training, licensing, and certification programs for system designers and service providers, especially those operating and servicing alternative or mechanized systems
Septage disposal	Requirements for licensing/registration of pumpers and haulers, storage and handling of septage, disposal or reuse of septage.

Source: Adapted from Ciotoli and Wiswall, 1982; USEPA, 2000.

**Table 2-3. Components of an onsite system regulatory program**

### 2.4.18 Compliance, enforcement, and corrective action programs

Requiring corrective action when onsite systems fail or proper system maintenance does not occur helps to ensure that performance goals and requirements will be met. Compliance and enforcement measures are more acceptable to system owners and the public when the RA is clear and consistent regarding its mission, regulatory requirements, and how the mission relates to public health and water resource protection. An onsite wastewater compliance and enforcement program should be based on reasonable and scientifically defensible regulations, promote fairness, and provide a credible deterrent to those who might be inclined to skirt its provisions. Regulations should be developed with community involvement and provided in summary or detailed form to all stakeholders and the public at large through education and outreach efforts. Service provider training programs are most effective if they are based on educating contractors and staff on technical and ecological approaches for complying with regulations and avoiding known and predictable enforcement actions. Table 2-3 describes the components of a regulatory program for onsite/decentralized systems.

Various types of legal instruments are available to formulate or enact onsite system regulations. Regulatory programs can be enacted as ordinances, management constituency agreements, or local or state codes, or simply as guidelines. Often, local health boards or other units of government can modify state code requirements to better address local conditions. Local ordinances that promote performance-based approaches can reference

#### Corrective action program elements

- Establish process for reporting and responding to problems (e.g., complaint reporting, inspections).
- Define conditions that constitute a violation of program requirements.
- Establish inspection procedures for reported problems and corrective action schedule.
- Develop a clear system for issuing violation notices, compliance schedules, contingencies, fines, or other actions to address uncorrected violations.

technical design manuals for more detailed criteria on system design and operation. Approaches for enforcing requirements and regulations of a management program can include

- Response to complaints
- Performance inspections
- Review of required documentation and reporting
- Issuance of violation notices
- Consent orders and court orders
- Formal and informal hearings
- Civil and criminal actions or injunctions
- Condemnation of systems and/or property
- Correcting system failures
- Restriction of real estate transactions (e.g., placement of liens)
- Issuance of fines and penalties

Some of these approaches can become expensive or generate negative publicity and provide little in terms of positive outcomes if public support is not present. Involvement of stakeholders in the development of the overall management program helps ensure that enforcement provisions are appropriate for the management area and effectively protect human health and water resources. Stakeholder involvement generally stresses restoration of performance compliance rather than more formal punitive approaches.

Information on regional onsite system performance, environmental conditions, management approaches by other agencies, and trends analyses might be needed if regulatory controls are increased. Most states establish regulatory programs and leave enforcement of these codes up to the local agencies. Table 2-4 contains examples of enforcement options for onsite management programs.

A regulatory program focused on achieving performance requirements rather than complying with prescriptive requirements places greater responsibilities on the oversight/permitting agency, service providers (site evaluator, designer, contractor, and operator), and system owners. The management entity should establish credible performance standards and develop the competency to review and approve proposed system designs that a manufacturer or engineer claims will meet established standards. Continuous surveillance of the performance of newer systems should occur



Collection method	Description	Advantages	Disadvantages
Liens on property	Local governing entity (with taxing powers) might add the costs of performing a service or past unpaid bills as a tax on the property.	Has serious enforcement ramifications and is enforceable.	Local government might be reluctant to apply this approach unless the amount owed is substantial.
Recording violations on property deed	Copies of violations can, through administrative or legislature requirement, be attached to the property title (via registrar of deed).	Relatively simple procedure. Effectively limits the transfer of property ownership.	Can be applied to enforce sanitary code violations; might be ineffective in collecting unpaid bills.
Presale inspections	Inspections of onsite wastewater systems are conducted prior to transfer of property or when property use changes significantly	Notice of violation might be given to potential buyer at the time of system inspection; seller might be liable for repairs	Can be difficult to implement because of additional resources needed. Inspection fees can help cover costs.
Termination of public services	A customer's water, electric, or gas service might be terminated (as applicable).	Effective procedure, especially if management entity is responsible for water supply.	Termination of public services poses potential health risks. Cannot terminate water service if property owner has well.
Fines	Monetary penalties for each day of violation, or as a surcharge on unpaid bills.	Fines can be levied through local judicial system as a result of enforcement of violations.	Effectiveness will depend on the authority vested in the entity issuing the fine.

Source: Ciotoli and Wiswall, 1982.

**Table 2-4. Compliance assurance approaches** and compliance program. The service providers should be involved in such programs to ensure that they develop the knowledge and skills to successfully design, site, build, and/or operate the treatment system within established performance standards. Finally, the management entity should develop a replicable process to ensure that more new treatment technologies can be properly evaluated and appropriately managed.

### 2.4.19 Data collection, record keeping, and reporting

Onsite wastewater management entities require a variety of data and other information to function effectively. This information can be grouped in the following categories:

- *Environmental assessment information:* climate, geology, topography, soils, slopes, ground water and surface water characterization data (including direction of flow), land use/land cover information, physical infrastructure (roads, water lines, sewer lines, commercial development, etc.).
- *Planning information:* existing and proposed development, proposed water or sewer line extensions, zoning classifications, population trends data, economic information, information regarding other agencies or entities involved in onsite wastewater issues.
- *Existing systems information:* record of site evaluations conducted and inventory of all existing onsite systems, cluster systems, package plants, and wastewater treatment plants, including location, number of homes/facilities served and size (e.g., 50-seat restaurant, 3-bedroom

### Record keeping and reporting program elements

Establish a database structure and reporting systems, at a minimum, for

- Environmental assessments
- Planning and stakeholder involvement functions
- Existing systems
- Staff, service providers, financial, and other administrative functions
- Inspection and monitoring program, including corrective actions required
- Septage and residuals management, including approved haulers, disposal sites, and manifest system records

home), system owner and contact information, location and system type, design and site drawings (including locations of property lines, wells, water resources), system components (e.g., concrete or plastic tank, infiltration lines or leaching chambers), design hydraulic capacity, performance expectations or effluent requirements (if any), installation date, maintenance records (e.g., last pumpout, repair, complaints, problems and actions taken, names of all service providers), and septage disposal records. Many states and localities lack accurate

system inventories. USEPA (2000) recommends the establishment and continued maintenance of accurate inventories of all OWTSS within a management entity's jurisdiction as a basic requirement of all management programs.

- *Administrative information:* personnel files (name, education/training, work history, skills/expertise, salary rate, job review summaries), financial data (revenue, expenses, debts and debt service, income sources, cost per unit of service estimates), service provider/vendor data (name, contact information, certifications, licenses, job performance summaries, disciplinary actions, work sites, cost record), management program initiatives and participating entities, program development plans and milestones, septage management information, and available resources.

Data collection and management are essential to program planning, development, and implementation. The components of a management information system include database development, data collection, data entry, data retrieval and integration, data analysis, and reporting. A variety of software is commercially available for managing system inventory data and other information. Electronic databases can increase the ease of collecting, storing, retrieving, using, and integrating data after the initial implementation and learning curve have been overcome. For example, if system locations

### Use of onsite system tracking software in the Buzzards Bay watershed

The Buzzards Bay Project is a planning and technical assistance initiative sponsored by the state environmental agency's Coastal Zone Management Program. The Buzzards Bay Project was the first National Estuary Program in the country to develop a watershed Comprehensive Conservation and Management Plan, which the Governor and USEPA approved in 1991. The primary focus of the Buzzards Bay management plan is to provide financial and technical assistance to Buzzards Bay municipalities to address nonpoint source pollution and facilitate implementation of Buzzards Bay Management Plan recommendations. The Buzzards Bay Project National Estuary Program provided computers and a software package to municipal boards of health in the watershed to enable better tracking of septic system permits, inspection results, and maintenance information. The software, along with the user's manual and other information, can be downloaded from the Internet to provide easy access for jurisdictions interested in its application and use (see <http://www.buzzardsbay.org/septrfct.htm>). This approach is designed to help towns and cities reduce the time they spend filing, retrieving, and maintaining information through a system that can provide—at the click of a mouse—relevant data on any lot in the municipality. The software program can also help towns respond to information requests more effectively, process permit applications more quickly, and manage new inspection and maintenance reporting requirements more efficiently.

Source: Buzzards Bay Project National Estuary Program, 1999.

are described in terms of specific latitude and longitude coordinates, a data layer for existing onsite systems can be created and overlaid on geographic information system (GIS) topographic maps. Adding information on onsite wastewater hydraulic output, estimated mass pollutant loads, and transport times expected for specified hydrogeomorphic conditions can help managers understand how water resources become contaminated and help target remediation and prioritization actions. Models can also be constructed to predict impacts from proposed development and assist in setting performance requirements for onsite systems in development areas.

System inventories are essential elements for management programs, and most jurisdictions maintain databases of new systems through their permitting programs. Older systems (those installed before 1970), however, are often not included in the system inventories. Some onsite management programs or other entities conduct inventories of older systems when such systems are included in a special study area. For example, Cass County and Crow Wing County in Minnesota have developed projects to inventory and inspect systems at more than 2,000 properties near lakes in the north-central part of the state (Sumption, personal communication, 2000). The project inventoried systems that were less than 5 years old but did not inspect them unless complaint or other reports indicated possible problems. Costs for inventorying and inspecting 234 systems in one lake watershed totaled \$9,000, or nearly \$40 per site (Sumption, personal communication, 2000). Mancl and Patterson (2001) cite a cost of \$30 per site inspection at Lake Panorama, Iowa.

Some data necessary for onsite system management might be held and administered by other agencies. For example, environmental or planning agencies often collect, store, and analyze land and water resource characterization data. Developing data sharing policies with other entities through cooperative agreements can help all organizations involved with health and environmental issues improve efficiency and overall program performance. The management agency should ensure that data on existing systems are available to health and water resource authorities so their activities and analyses reflect this important aspect of public health and environmental protection.

## 2.4.20 Program evaluation criteria and procedures

Evaluating the effectiveness of onsite management program elements such as planning, funding, enforcement, and service provider certification can provide valuable information for improving programs. A regular and structured evaluation of any program can provide critical information for program managers, the public, regulators, and decision makers. Regular program evaluations should be performed to analyze program methods and procedures, identify problems, evaluate the potential for improvement through new technologies or program enhancements, and ensure funding is available to sustain programs and adjust program goals. The program evaluation process should include

- A tracking system for measuring success and for evaluating and adapting program components
- Processes for comparing program achievements to goals and objectives
- Approaches for adapting goals and objectives if internal or external conditions change
- Processes for initiating administrative or legal actions to improve program functioning
- An annual report on the status, trends, and achievements of the management program
- Venues for ongoing information exchange among program stakeholders

A variety of techniques and processes can be used to perform program evaluations to assess administrative and management elements. The method chosen for each program depends on local circumstances, the type and number of stakeholders involved, and the level of support generated by management agencies to conduct a careful, unbiased, detailed review of the program's success in protecting health and water resources. Regardless of the method selected, the program evaluation should be performed at regular intervals by experienced staff, and program stakeholders should be involved.

A number of state, local, and private organizations have implemented performance-based management programs for a wide range of activities, from state budgeting processes to industrial production operations. The purpose of these programs is

### Performance-based budgeting in Texas

Since 1993 state agencies in Texas have been required to develop a long-term strategic plan that includes a mission statement, goals for the agency, performance measures, an identification of persons served by the agency, an analysis of the resources needed for the agency to meet its goals, and an analysis of expected changes in services due to changes in the law. Agency budget line items are tied to performance measures and are available for review through the Internet. Information on the budgeting process in Texas is available from the Texas Legislative Budget Board at <http://www.lbb.state.tx.us>.

*Source: Texas Senate Research Center, 2000.*

twofold: linking required resources with management objectives and ensuring continuous improvement. Onsite management programs could also ask partnering entities to use their experience to help develop and implement in-house evaluation processes.

## 2.5 Financial assistance for management programs and system installation

Most management programs do not construct or own the systems they regulate. Homeowners or other private individuals usually pay a permit fee to the agency to cover site evaluation and permitting costs and then finance the installation, operation, maintenance, and repair of their systems themselves. During recent years, however, onsite management officials and system owners have become increasingly supportive of centralized operation, maintenance, and repair services. In addition, some management programs are starting to provide assistance for installation, repair, or replacement in the form of cost-share funding, grants, and low-interest loans. Some communities have elected to make a transition from individual systems to a clustered approach to capitalize on the financial and other benefits associated with the joint use of lagoons, drain fields, and other system components linked by gravity, vacuum, or low-pressure piping. Developers of cluster systems, which feature individual septic tanks and collective post-tank treatment units, have been particularly creative and aggressive in obtaining financing for system installation.

Funding for site evaluation, permitting, and enforcement programs is generally obtained from permit fees, property assessments (e.g., health district taxes), and allocations from state legislatures for environmental health programs. However, many jurisdictions have discovered that these funding sources do not adequately support the full range of planning, design review, construction oversight, inspection and monitoring, and remediation functions that constitute well-developed onsite management programs. Urbanized areas have supplemented funding for their management programs with fees paid by developers, monthly wastewater treatment service fees (sometimes based on metered water use), property assessment increases, professional licensing fees, fines and penalties, and local general fund appropriations. This section includes an overview of funding options for onsite system management programs.

### 2.5.1 Financing options

Two types of funding are usually necessary for installation and management of onsite wastewater systems. First, initial funding is required to pay for any planning and construction costs, which include legal, administrative, land acquisition, and engineering costs. Once the construction is complete, additional funding is needed to finance the ongoing operation and maintenance, as well as to pay for the debt service incurred from borrowing the initial funds. Table 2-6 lists potential funding sources and the purposes for which the funds are typically used. As indicated in the table, each funding source has advantages and disadvantages. Decision makers must choose the funding sources that best suit their community.

Primary sources of funds include

- Savings (capital reserve)
- Grants (state, federal)
- Loans (state, federal, local)
- Bond issues (state, local)
- Property assessments

Publicly financed support for centralized wastewater treatment services has been available for decades from federal, state, and local sources. Since 1990 support for public funding of onsite treatment systems has been growing. The following section summarizes the most prominent sources of



### Suggested approach for conducting a formal program evaluation

**Form a program evaluation team** composed of management program staff, service providers, public health agency representatives, environmental protection organizations, elected officials, and interested citizens.

**Define the goals, objectives, and operational elements** of the various onsite management program components. This can be done simply by using a checklist to identify which program components currently exist. Table 2-5 provides an excellent matrix for evaluating the management program.

**Review the program components checklist and feedback** collected from staff and stakeholders to determine progress toward goals and objectives, current status, trends, cost per unit of service, administrative processes used, and cooperative arrangements with other entities.

**Identify program components or elements in need of improvement**, define actions or amount and type of resources required to address deficient program areas, identify sources of support or assistance, discuss proposed program changes with the affected stakeholders, and implement recommended improvement actions.

**Communicate suggested improvements to program managers** to ensure that the findings of the evaluation are considered in program structure and function.

Table 2-5. Example of Functional Responsibilities Matrix

	State health departments	County health departments	Towns	Homeowners	Private firms	Comments
<b>Planning/Administration</b>						
Plan preparation			X			
Plan review coordination	X	X	X			
Research and development	X					
Office and staff management		X				
<b>Site Evaluation</b>						
Guidelines and criteria	X					
Evaluation certification		X				
Site sustainability analysis					X	
<b>System Design</b>						
Standards and criteria	X					
Designer certification						Not done
System design					X	
* Design review		X				
Permit Issuance		X				
<b>Installation</b>						
* Construction supervision		X				
Installer certification						Not done
* Record-keeping		X				
Permit issuance		X				
<b>Operation and Maintenance</b>						
* Procedures and regulations						Not done
Operator/inspector certification						Not done
* Routine inspections						Not done
* Emergency inspections		X				
* System repair/replacement				X		
* Repair supervision		X				
Performance certification						Not done
System ownership				X		
<b>Residuals Disposal</b>						
Disposal regulations	X					
* Hauler certification	X					
Record-keeping		X				
Equipment inspections		X				
Facility inspections		X				
Facility operations					X	
<b>Financing</b>						
* Secure funding						Not applicable
* Set charges						Not applicable
* Collect charges						Not applicable
<b>Monitoring</b>						
* Reporting system						Not applicable
Sampling	X					
<b>Public Education</b>						
Develop methods	X					
* Disseminate information	X					
* Respond to complaints		X				

\*Management functions that require local agency input.



Table 2-6. Funding options

Fund type	Source of funds	How funds are used						
		Construction and repair	Inspections	Permitting	Planning	Capital reserve	Principal and interest	Operation and maintenance
<b>Initial funds</b>	Municipality receives state grants, state revolving funds, state bonds	X	X	X	X			
	Municipality uses savings (capital reserve)	X	X	X	X			
	Municipality obtains federal grants or loans	X	X	X	X			
	Municipality obtains loans from local bank	X	X	X	X			
	Cost sharing with major users	X	X	X	X			
	Property assessments (might require property owner to obtain low-interest loans)	X	X	X	X			
<b>Management program funds (continual)</b>	User fees (property owner)		X	X		X	X	X
	Taxes (property owner)		X	X		X	X	X
	Fees for specific services, punitive fees (property owner)		X	X				X
	Capital reserve fund	X			X			
	Developer-paid fees (connection fees, impact fees)	X	X	X	X	X	X	X

<sup>a</sup> Principal and interest payment (debt service) on various loans used for initial financing.

Sources: Ciotoli and Wiswall, 1982, 1986; Shephard, 1996.

grant, loan, and loan guarantee funding and outline other potential funding sources.

### 2.5.2 Primary funding sources

The following agencies and programs are among the most dependable and popular sources of funds for onsite system management and installation programs.

#### Clean Water State Revolving Fund

The Clean Water State Revolving Fund, or CWSRF (see <http://www.epa.gov/owm/finan.htm>), is a

low- or no-interest loan program that has traditionally financed centralized sewage treatment plants across the nation. Program guidance issued in 1997 emphasized that the fund could be used as a source of support for the installation, repair, or upgrading of onsite systems in small towns, rural areas, and suburban areas. The states and the territory of Puerto Rico administer CWSRF programs, which operate like banks. Federal and state contributions are used to capitalize the fund programs, which make low- or no-interest loans for water quality projects. Funds are then repaid to the CWSRF over terms as long as 20 years. Repaid funds are recycled to fund other water quality projects. Projects

### Financial assistance program elements

- Determine program components or system aspects that require additional financial assistance.
- Identify financial resources available for system design, installation, operation, maintenance, and repair.
- Research funding options (e.g., permit or user fees, property taxes, impact fees, fines, grants/loans).
- Work with stakeholder group to execute or establish selected funding option(s).

that might be eligible for CWSRF funding include new system installations and replacement or modification of existing systems. Costs associated with establishing a management entity to oversee onsite systems in a region, including capital outlays (e.g., for trucks on storage buildings), may also be eligible. Approved management entities include city and county governments, special districts, public or private utilities, and private for-profit or nonprofit corporations.

### U.S. Department of Agriculture Rural Development programs

U.S. Department of Agriculture Rural Development programs provide loans and grants to low and moderate-income persons. State Rural Development offices administer the programs; for state office locations, see [http://www.rurdev.usda.gov/recd\\_map.html](http://www.rurdev.usda.gov/recd_map.html). A brief summary of USDA Rural Development programs is provided below.

#### *Rural Housing Service*

The Rural Housing Service Single-Family Housing Program ([http://www.rurdev.usda.gov/rhs/Individual/ind\\_splash.htm](http://www.rurdev.usda.gov/rhs/Individual/ind_splash.htm)) provides homeownership opportunities to low- and moderate-income rural Americans through several loan, grant, and loan guarantee programs. The program also makes funding available to individuals to finance vital improvements necessary to make their homes safe and sanitary. The Direct Loan Program (section 502) provides individuals or families direct financial assistance in the form of a home loan at an affordable interest rate. Most loans are to families with incomes below 80 percent of the median income level in the communities where they live.

Applicants might obtain 100 percent financing to build, repair, renovate, or relocate a home, or to purchase and prepare sites, including providing water and sewage facilities. Families must be without adequate housing but be able to afford the mortgage payments, including taxes and insurance. These payments are typically within 22 to 26 percent of an applicant's income. In addition, applicants must be unable to obtain credit elsewhere yet have reasonable credit histories. Elderly and disabled persons applying for the program may have incomes up to 80 percent of the area median income.

#### *Home Repair Loan and Grant Program*

For very low-income families that own homes in need of repair, the Home Repair Loan and Grant Program offers loans and grants for renovation. Money might be provided, for example, to repair a leaking roof; to replace a wood stove with central heating; or to replace a pump and an outhouse with running water, a bathroom, and a waste disposal system. Homeowners 62 years and older are eligible for home improvement grants. Other low-income families and individuals receive loans at a 1 percent interest rate directly from the Rural Housing Service. Loans of up to \$20,000 and grants of up to \$7,500 are available. Loans are for up to 20 years at 1 percent interest.

#### *Rural Utilities Service*

The Rural Utilities Service (<http://www.usda.gov/rus/water/programs.htm>) provides assistance for public or not-for-profit utilities, including wastewater management districts. Water and waste disposal loans provide assistance to develop water and waste disposal systems in rural areas and towns with a population of 10,000 or less. The funds are available to public entities such as municipalities, counties, special-purpose districts, Indian tribes, and corporations not operated for profit. The program also guarantees water and waste disposal loans made by banks and other eligible lenders. Water and Waste Disposal Grants can be accessed to reduce water and waste disposal costs to a reasonable level for rural users. Grants might be made for up to 75 percent of eligible project costs in some cases.

**Rural Business-Cooperative Service**

The Rural Business-Cooperative Service ([http://www.rurdev.usda.gov/rbs/busp/b&i\\_gar.htm](http://www.rurdev.usda.gov/rbs/busp/b&i_gar.htm)) provides assistance for businesses that provide services for system operation and management. Business and Industry Guaranteed Loans can be made to help create jobs and stimulate rural economies by providing financial backing for rural businesses. This program provides guarantees up to 90 percent of a loan made by a commercial lender. Loan proceeds might be used for working capital, machinery and equipment, buildings and real estate, and certain types of debt refinancing. Assistance under the Guaranteed Loan Program is available to virtually any legally organized entity, including a cooperative, corporation, partnership, trust or other profit or nonprofit entity, Indian tribe or federally recognized tribal group, municipality, county, or other political subdivision of a state.

**Community Development Block Grants**

The U.S. Department of Housing and Urban Development (HUD) operates the Community Development Block Grant (CDBG) program, which provides annual grants to 48 states and Puerto Rico. The states and Puerto Rico use the funds to award grants for community development to smaller cities and counties. CDBG grants may be used for numerous activities, including rehabilitating residential and nonresidential structures, constructing public facilities, and improving water and sewer facilities, including onsite systems. USEPA is working with HUD to improve access to CDBG funds for treatment system owners by raising program awareness, reducing paperwork burdens, and increasing promotional activities in eligible areas. More information is available at <http://www.hud.gov/cpd/cdbg.html>.

**Nonpoint Source Pollution Program**

Clean Water Act section 319 (nonpoint source pollution control) funds can support a wide range of polluted runoff abatement, including onsite wastewater projects. Authorized under section 319 of the federal Clean Water Act and financed by federal, state, and local contributions, these projects provide cost-share funding for individual and community systems and support broader watershed assessment, planning, and management activities. Projects funded in the past have included direct cost-share for onsite system repairs and upgrades, assessment of watershed-scale onsite system contributions to polluted runoff, regional remediation strategy development, and a wide range of other programs dealing with onsite wastewater issues. For example, a project conducted by the Gateway District Health Department in east-central Kentucky enlisted environmental science students from Morehead State University to collect and analyze stream samples for fecal coliform “hot spots.” Information collected by the students was used to target areas with failing systems for cost-share assistance or other remediation approaches (USEPA, 1997b). The Rhode Island Department of Environmental Management developed a user-friendly system inspection handbook with section 319 funds to improve system monitoring practices and then developed cost-share and loan programs to help system owners pay for needed repairs (USEPA, 1997). For more information, see <http://www.epa.gov/OWOW/NPS/>.

**2.5.3 Other funding sources**

Other sources of funding include state finance programs, capital reserve or savings funds, bonds,

**PENNVEST: Financing onsite wastewater systems in the Keystone State**

The Pennsylvania Infrastructure Investment Authority (PENNVEST) provides low-cost financing for systems on individual lots or within entire communities. Teaming with the Pennsylvania Housing Finance Agency and the state’s Department of Environmental Protection, PENNVEST created a low-interest onsite system loan program for low- to moderate-income (150 percent of the statewide median household income) homeowners. The \$65 application fee is refundable if the project is approved. The program can save system owners \$3,000 to \$6,000 in interest payments on a 15-year loan of \$10,000. As of 1999 PENNVEST had approved 230 loans totaling \$3.5 million. Funds for the program come from state revenue bonds, special statewide referenda, the state general fund, and the State Revolving Fund.

Source: PADEP, 1998.

certificates of participation, notes, and property assessments. Nearly 20 states offer some form of financial assistance for installation of OWTSSs, through direct grants, loans, or special project cost-share funding. Capital reserve or savings funds are often used to pay for expenses that might not be eligible for grants or loans, such as excess capacity for future growth. Capital reserve funds can also be used to assist low- and moderate-income households with property assessment or connection fees.

Bonds usually finance long-term capital projects such as the construction of OWTSSs. States, municipalities, towns, townships, counties, and special districts issue bonds. The two most common types of bonds are general obligation bonds, which are backed by the faith and credit of the issuing government, and revenue bonds, which are supported by the revenues raised from the beneficiaries of a service or facility. General obligation bonds are rarely issued for wastewater treatment facilities because communities are often limited in the amount of debt they might incur. These bonds are generally issued only for construction of schools, libraries, municipal buildings, and police or fire stations.

Revenue bonds are usually not subject to debt limits and are secured by repayment through user fees. Issuing revenue bonds for onsite projects allows a community to preserve the general obliga-

tion borrowing capacity for projects that do not generate significant revenues. A third and less commonly used bond is the special assessment bond, which is payable only from the collection of special property assessments. Some states administer state bond banks, which act as intermediaries between municipalities and the national bond market to help small towns that otherwise would have to pay high interest rates to attract investors or would be unable to issue bonds. State bond banks, backed by the fiscal security of the state, can issue one large, low-interest bond that funds projects in a number of small communities

Communities issue Certificates of Participation (COPs) to lenders to spread out costs and risks of loans to specific projects. If authorized under state law, COPs can be issued when bonds would exceed debt limitations. Notes, which are written promises to repay a debt at an established interest rate, are similar to COPs and other loan programs. Notes are used mostly as a short-term mechanism to finance construction costs while grant or loan applications are processed. Grant anticipation notes are secured by a community's expectation that it will receive a grant. Bond anticipation notes are secured by the community's ability to sell bonds.

Finally, property assessments might be used to recover capital costs for wastewater facilities that benefit property owners within a defined area. For example, property owners in a specific neighbor-

### **Funding systems and management in Massachusetts**

The Commonwealth of Massachusetts has developed three programs that help finance onsite systems and management programs. The loan program provides loans at below-market rates. A tax credit program provides a tax credit of up to \$4,500 over 3 years to defray the cost of system repairs for a primary residence. Finally, the Comprehensive Community Septic Management Program provides funding for long-term community, regional, or watershed-based solutions to system failures in sensitive environmental areas. Low-interest management program loans of up to \$100,000 are available.

*Source: Massachusetts DEP, 2000.*



Table 2-7. Advantages and disadvantages of various funding sources

Funding source	Description	Advantages	Disadvantages
Loans	Money lent with interest; can be obtained from federal, state, and commercial lending institution sources.	State and federal agencies can often issue low-interest loans with a long repayment period. Loans can be used for short-term financing while waiting for grants or bonds.	Loans must be repaid with interest. Lending agency might require certain provisions (e.g., power to levy taxes) to assure managing agency of ability to repay the debt. Commercial loans generally are available at higher interest rates and might be difficult to obtain without adequate collateral.
Grants	Funds awarded to pay for some or all of a community project.	Funds need not be repaid. Small communities might be eligible for many different grants to build or upgrade their environmental facilities.	Applying for grants and managing grant money require time and money. Sometimes grant-imposed wage standards apply to an entire project even if the grant is only partially funding the project; this increases project expense. Some grants require use of material and design requirements that exceed local standards. (Grants might result in higher costs.)
General obligation bonds	Bonds backed by the full faith and credit of the issuing entity. Secured by the taxing powers of the issuing entity. Commonly used by local governments.	Interest rates are usually lower than those of other bonds. Offers considerable flexibility to local governments.	Community debt limitations might restrict use. Voters often must approve of using these bonds. Usually used for facilities that do not generate revenues.
Revenue bonds	Bonds repaid by the revenue of the facility.	Can be used to circumvent local debt limitation.	Do not have full faith and credit of the local government. Interest rates are typically higher than those of general obligation bonds.
Special assessment bonds	Bonds payable only from collection of special assessments. Property taxes cannot be used to pay for these.	Removes financial burden from local government. Useful when direct benefits can be readily identified.	Can be costly to individual landowners. Might be inappropriate in areas with nonuniform lot sizes. Interest rate might be relatively high.
Bond bank monies	States use taxing power to secure a large bond issue that can be divided among communities.	States can get the large issue bond at a lower interest rate. The state can issue the bond in anticipation of community need.	Many communities compete for limited amount of bond bank funds.
Certificates of participation	COPs can be issued by a community instead of bonds. COPs are issued to several lenders that participate in the same loan.	Costs and risks of loan spread out over several lenders. When allowed by state law, COPs can be issued when bonds would exceed debt limitations.	Requires complicated agreements among participating lenders.
Note	A written promise to pay a debt. Can include grant and bond anticipation notes.	Method of short-term financing while a community is waiting for a grant or bond.	Community must be certain of receipt of the grant money. Bond notes are risky because voters must approve general obligation bonds before they are issued. Voter support must be overwhelming if bond notes are used.
Property assessment	Direct fees or taxes on property. Sometimes referred to as an improvement fee.	Useful where benefits from capital improvements are identifiable. Can be used to reduce local share debt requirements for financing. Can be used to establish a fund for future capital investments.	Initial lump sum payment of assessment might be a significant burden on individual property owners.
User fee	Fee charged for using the wastewater system.	Generates steady flow of revenue. Graduated fees encourage water conservation.	Flat fees discourage water conservation. Graduated fee could discourage industries or businesses that use high volumes of water from locating in an area.
Service fee	Fee charged for a specific service, such as pumping the septic tank.	Generates funds to pay for O&M. Fees not imposed on people not connected to the system.	Revenue flow not always continuous.
Punitive fees	Charges assessed for releasing pollutants into the system.	Generates revenue while discouraging pollution.	Generation of funds not always reliable. Could encourage business to change location or participate in illegal activities to avoid fees. Could generate opposition to O&M scheme.
Connection fees	Charges assessed for connection to existing system.	Connection funded by beneficiary. All connection costs might be paid.	Might discourage development.

Source: USEPA, 1994.



hood could be assessed for the cost of installing sewers or a cluster treatment system. Depending on the amount of the assessment, property owners might pay it all at once or pay in installments at a set interest rate. Similar assessments are often charged to developers of new residential or commercial facilities if the developers are not required to install wastewater treatment systems approved by the local regulatory agency. Funding for ongoing management of onsite systems in newly developed areas should be considered when these assessments are calculated.

Although funds from grants, special projects, and other one-time sources can help initiate special projects or develop new functions, support for onsite management over the long term should come from sources that can provide continuous funding (table 2-7). Monthly service fees, property assessments, regular general fund allocations, and permit/licensing fees can be difficult to initiate but provide the most assurance that management program activities can be supported over the long term. Securing public acceptance of these financing mechanisms requires stakeholder involvement in their development, outreach programs that provide a clear picture of current problems and expected benefits, and an appropriate matching of community resources with management program need.

### References

- Alaska Administrative Code. 1999. Title 18 (Environmental Conservation), Chapter 72, Article 1. Alaska Department of Environmental Conservation. April 1999 version.
- Ayres Associates. 1993. *The Capability of Fine Sandy Soils for Septic Tank Effluent Treatment: A Field Investigation at an In-Situ Lysimeter Facility in Florida*. Report to the Florida Department of Health and Rehabilitative Services, Tallahassee, FL.
- Bass, J. 2000. E-mail to Barry Toning from Jay Bass, Subsurface Systems Bureau, New Hampshire Department of Environmental Services, regarding the elements of New Hampshire's certification and testing requirements for service providers. October 24, 2000.
- Buzzards Bay Project National Estuary Program. 1999. *What is SepTrack?* The Massachusetts Alternative Septic System Test Center. <<http://www.buzzardsbay.org/septrfct.htm>>. Accessed July 26, 2001.
- Ciotoli, P.A., and K.C. Wiswall. 1982. *Management of Small Community Wastewater Systems*. USEPA 600/8-82/009. NTIS PB82-260829. Washington, DC.
- County Environmental Quarterly. 1997. Using GIS to Assess Septic System Impacts to Chesapeake Bay. National Association of Counties, Washington, DC.
- Eliasson, J.M., D.A. Lenning, and S.C. Wecker. 2001. Critical Point Monitoring – A New Framework for Monitoring On-Site Wastewater Systems. In *Onsite Wastewater Treatment: Proceedings of the Ninth National Symposium on Individual and Small Community Sewage Systems*. American Society of Agricultural Engineers, St. Joseph, MI.
- English, C.D., and T.E. Yeager. 2001. Considerations About the Formation of Responsible Management Entities (RME) as a Method to Insure the Viability of Decentralized Wastewater Management Systems. Unpublished manuscript presented at the Ninth National Symposium on Individual and Small Community Sewage Systems, Austin TX. Sponsored by the American Society of Agricultural Engine, St. Joseph, MI.
- Fairfax County Health Department. 1995. Information Notice to All Septic Tank Owners. Notice from Dennis A. Hill, Division of Environmental Health, August 24, 1995.
- Florida Administrative Code. 2000. Chapter 64E-6. Standards for Onsite Sewage Treatment and Disposal Systems. Florida Department of Health. <<http://www9.myflorida.com/environment/OneStop/OSTDS/64e6.pdf>>.
- Heigis, W.S., and B. Douglas. 2000. Integrated Wastewater Information Systems. In *Onsite: The Future of Water Quality*. National Onsite Wastewater Recycling Association, Laurel, MD.
- Honachefsky, W. 2000. *Ecologically-Based Municipal Land Use Planning*. ISBN 1566704065. Lewis Publishers, Inc., Boca Raton, FL.

- Hoover, M.T., and D. Beardsley. 2000. Science and regulatory decision making. *Small Flows Quarterly*, 1(4). National Small Flows Clearinghouse, Morgantown, WV.
- Hoover, M.T., and D. Beardsley. 2001. The weight of scientific evidence. *Small Flows Quarterly* 2(1). National Small Flows Clearinghouse, Morgantown, WV.
- Kentucky Revised Statutes. 2001. Legislative Research Commission, Commonwealth of Kentucky, Frankfort, KY.
- Kreissl, F. 1982. Evolution of State Codes and Their Implications. In *Proceedings of Fourth Northwest On-Site Wastewater Disposal Short Course*, September 1982, University of Washington, Seattle.
- Kreissl, J., and R. Otis. 1999. New Markets for Your Municipal Wastewater Services: Looking Beyond the Boundaries. In *Proceedings: Water Environment Federation Workshop*, October 1999, New Orleans, LA.
- Maine Department of Human Services. 1996. Rules for Site Evaluators of Subsurface Wastewater Disposal Systems. Statutory Authority: 22 MRSA Section 42 Sub-section 3A. 10-144 Chapter 245.
- Mancl, K. 1999. *Crystal Lakes, Colorado: National Onsite Demonstration Project Case Study*. Published online by the National Onsite Demonstration Project of the National Small Flows Clearinghouse. <<http://www.estd.wvu.edu/nodp4/index.html>>.
- Mancl, K., and S. Patterson. 2001. Twenty Years of Success in Septic Systems Management. In *On-Site Wastewater Treatment: Proceedings of the Ninth National Symposium on Individual and Small Community Sewage Systems*. American Society of Agricultural Engineers. St. Joseph, MI.
- Massachusetts Department of Environmental Protection (DEP). 2000. *Financial Assistance Opportunities for Septic System Management*. Massachusetts Department of Environmental Protection, Bureau of Resource Protection. <<http://www.magnet.state.ma.us/dep/pao/files/t5sum.htm>>.
- Massachusetts Environmental Code. Title 5, 310 CMR 15.00, promulgated pursuant to the authority of Massachusetts General Law c. 12A, Section 13.
- Minnesota Statutes. 2000. Chapter 115, Section 115.55: Individual Sewage Treatment Systems. <<http://www.revisor.leg.state.mn.us/stats/115/55.html>>.
- National Small Flow Clearinghouse (NSFC). 1995a. *Inspections: From the State Regulations*. Published as WWPCRG40 in February 1995. National Small Flows Clearinghouse, Morgantown, WV.
- National Small Flow Clearinghouse (NSFC). 1995b. Idaho regulations program responsive to change. *Small Flows* 9(3). National Small Flow Clearinghouse, Morgantown, WV.
- National Small Flow Clearinghouse (NSFC). 1996. Management tools and strategies. *Pipeline* 7(2).
- Nawathe, D. Using Smart Controllers with Remote Monitoring Capability to Meet New Market Needs. In *Onsite: The Future of Water Quality*, NOWRA 2000 Conference Proceedings. National Onsite Wastewater Recycling Association, Inc., Laurel, MD.
- New England Interstate Water Pollution Control Commission. 2000. *Technical Guidelines for New England Regulatory Cooperation to Promote Innovative/Alternative On-Site Wastewater Technologies*. Prepared by New England Interstate Regulatory Cooperation Project's Technical Review Committee. New England Interstate Water Pollution Control Commission, Lowell, MA.
- New Hampshire Department of Environmental Services. 1991. *Permitting of Installers and Designers of Subsurface Sewage Disposal Systems*. Environmental Fact Sheet SSB-4. New Hampshire Department of Environmental Services, Concord, NH.
- Noah, M. 2000. Mandated certification of onsite professionals. *Small Flows Quarterly* 1(1). National Small Flow Clearinghouse, Morgantown, WV.
- North Carolina Agricultural Extension Service (NCAES). 1990. *Soil Facts: Management of Single Family Wastewater Treatment and*

- Disposal Systems*. NCAES, North Carolina State University, Raleigh, NC.
- North Carolina State University (NCSU). 2001. *Subsurface Wastewater System Operator Training School*. North Carolina State University, Raleigh, NC. <<http://www.soil.ncsu.edu/swetc/subsurface/subsurface.htm>>.
- Oregon Department of Environmental Quality. 1998. *Oregon Department of Environmental Quality Strategic Plan: Strategic Plan Overview*. <<http://www.deq.state.or.us/msd/plan/hguide.htm>>.
- Otis, R.J., B.J. McCarthy, and J. Crosby. 2001. Performance Code Framework for Management of Onsite Wastewater Treatment in Northeast Minnesota. In *On-Site Wastewater Treatment: Proceedings of the Ninth National Symposium on Individual and Small Community Sewage Systems*. American Society of Agricultural Engineers, St. Joseph, MI.
- Pennsylvania Department of Environmental Protection (PADEP). 2000. *Individual On-Lot Sewage Disposal System Funding Program*. Pennsylvania Infrastructure Investment Authority, Harrisonburg, PA. <<http://www.pennvest.state.pa.us/PVLink/onlot2000.pdf>>.
- Rose, R.P. 1999. *Onsite Wastewater Management in New Mexico: A Case Study of Peña Blanca Water and Sanitation District*. Published online by the National Onsite Demonstration Project of the National Small Flows Clearinghouse. <<http://www.estd.wvu.edu/nodp4/index.html>>.
- Shepherd, C. 1996, April. *Managing Wastewater: Prospects in Massachusetts for a Decentralized Approach*. Prepared for the ad hoc Task Force for Decentralized Wastewater Management. Marine Studies Consortium and Waquoit Bay National Estuarine Research Reserve.
- Soltman, M.J. 2000. E-mail to the state regulators listserver from Mark J. Soltman, Supervisor, Wastewater Management Program, Office of Environmental Health & Safety, Washington. Accessed August 16, 2000.
- Stephens, L.D. 2000. Remote Management: A Valuable Tool for the Future of Decentralized Wastewater Treatment. In *Onsite: The Future of Water Quality*, NOWRA 2000 Conference Proceedings. National Onsite Wastewater Recycling Association, Inc., Laurel, MD.
- Sumption, John. 2000. Deputy Director of Cass County, Minnesota, Environmental Services. Personal communication.
- Swanson, E. 2001. Performance-Based Regulation for Onsite Systems. Unpublished manuscript distributed at the USEPA/NSFC State Regulators Conference, April 18-22, 2001.
- Texas Natural Resource Conservation Commission. 1997. TNRCC Approves New Rules for On-Site Wastewater Systems. Public notice at <<http://twri.tamu.edu/twripubs/Insight/v5n4/article-1.html>>. Accessed March 21, 1997.
- Texas Senate Research Center. 2000. *Budget 101: A Guide to the Budget Process in Texas*. <[http://www.lbb.state.tx.us/WEBDOWN.NSF/1b5fe0ddd179f295862564b30057b343/431856189918c5268625668f006702c3?OpenDocument#\\_3vs\\_](http://www.lbb.state.tx.us/WEBDOWN.NSF/1b5fe0ddd179f295862564b30057b343/431856189918c5268625668f006702c3?OpenDocument#_3vs_)>.
- U.S Environmental Protection Agency (USEPA). 1980. *Design Manual: Onsite Wastewater Treatment and Disposal Systems*. EPA 625-1-80-012. Office of Research and Development and Office of Water, Cincinnati, OH.
- U.S Environmental Protection Agency (USEPA). 1986. *Septic Systems and Ground Water Protection: A Program Manager's Guide and Reference Book*. EPA/440/6-86/005; NTIS PB88-1/2/23. U.S Environmental Protection Agency, Office of Water, Washington, DC.
- U.S Environmental Protection Agency (USEPA). 1992. *Wastewater Treatment/Disposal for Small Communities*. September, 1992. EPA/625/R-92/005. United States Environmental Protection Agency, Washington DC.
- U.S Environmental Protection Agency (USEPA). 1993. *Guidance Specifying Management Measures for Sources of Nonpoint Pollution in Coastal Waters*. EPA/625/1-88/022. U.S. Environmental Protection Agency, Office of Water, Washington, DC.
- U.S Environmental Protection Agency (USEPA). 1994. *Water Quality Standards Handbook*:

- Second Edition*. USEPA Office of Water. EPA 823-B-94-005a. Washington, DC
- U.S Environmental Protection Agency (USEPA). 1994. *Environmental Planning for Small Communities: A Guide for Local Decision-Makers*. EPA/625/R-94/009. U.S. Environmental Protection Agency, Office of Research and Development, Office of Regional Operations and State/Local Relations, Washington, DC.
- U.S Environmental Protection Agency (USEPA). 1995a. *Process Design Manual on Surface Disposal and Land Application of Sewage Sludge and Domestic Septage*. U.S. Environmental Protection Agency, Cincinnati, OH. <<http://www.epa.gov/ORD/WebPubs/sludge.pdf>>.
- U.S Environmental Protection Agency (USEPA). 1995b. *Domestic Septage Regulatory Guidance*. U.S. Environmental Protection Agency, Cincinnati, OH. <<http://www.epa.gov/oia/tips/scws.htm>>.
- U.S Environmental Protection Agency (USEPA). 1995c. *Process Design Manual: Land Application of Sewage Sludge and Domestic Septage*. EPA/625/R-95/001. U.S. Environmental Protection Agency, Cincinnati, OH.
- U.S Environmental Protection Agency (USEPA). 1997a, April. *Response to Congress on Use of Decentralized Wastewater Treatment Systems*. EPA 832-R-97-001b. U.S. Environmental Protection Agency, Washington, DC.
- U.S Environmental Protection Agency (USEPA). 1997b. *Section 319 Success Stories: Volume II. Highlights of State and Tribal Nonpoint Source Programs*. EPA 841-R-97-001. U.S. Environmental Protection Agency, Office of Water, Washington, DC. October.
- U.S Environmental Protection Agency (USEPA). 1998, April. *National Water Quality Inventory: 1996 Report to Congress*. EPA841-R-97-008. U.S. Environmental Protection Agency, Office of Water, Washington DC.
- U.S Environmental Protection Agency (USEPA). 2000. Draft EPA Guidelines for Management of Onsite/Decentralized Wastewater Systems. U.S. Environmental Protection Agency, Office of Wastewater Management, Washington, DC. *Federal Register*, October 6, 2000.
- Walsh, J., R.J. Otis, and T.L. Loudon. 2001. NOWRA Model Framework for Unsewered Wastewater Infrastructure. In *Onsite Wastewater Treatment: Proceedings of the Ninth National Symposium on Individual and Small Community Sewage Systems*. American Society of Agricultural Engineers, St. Joseph, MI.
- Washington Department of Health. 1994. On-site sewage system regulations. Chapter 246-272, Washington Administrative Code, adopted March 9, 1994, effective January 1, 1995. Washington Department of Health, Olympia, WA. <<http://www.doh.wa.gov/ehp/ts/osreg1.doc>>.
- Wisconsin Department of Commerce. 2001. *Private Onsite Wastewater Treatment Systems Program*. WI DOC. POWTS Code, Comm 83, State Plumbing Code. Wisconsin Department of Commerce, Safety and Buildings Division, Madison, WI. <<http://www.commerce.state.wi.us/SB/SB-POWTSProgram.html>>.





# Chapter 3:

## Establishing treatment system performance requirements

- 3.1 Introduction
  - 3.2 Estimating wastewater characteristics
  - 3.3 Estimating wastewater flow
  - 3.4 Wastewater quality
  - 3.5 Minimizing wastewater flows and pollutants
  - 3.6 Integrating wastewater characterization and other design information
  - 3.7 Transport and fate of wastewater pollutants in the receiving environment
  - 3.8 Establishing performance requirements
- 

### 3.1 Introduction

This chapter outlines essential steps for characterizing wastewater flow and composition and provides a framework for establishing and measuring performance requirements. Chapter 4 provides information on conventional and alternative systems, including technology types, pollutant removal effectiveness, basic design parameters, operation and maintenance, and estimated costs. Chapter 5 describes treatment system design and selection processes, failure analysis, and corrective measures.

This chapter also describes methods for establishing and ensuring compliance with wastewater treatment performance requirements that protect human health, surface waters, and ground water resources. The chapter describes the characteristics of typical domestic and commercial wastewaters and discusses approaches for estimating wastewater quantity and quality for residential dwellings and commercial establishments. Pollutants of concern in wastewaters are identified, and the fate and transport of these pollutants in the receiving environment are discussed. Technical approaches for establishing performance requirements for onsite systems, based on risk and environmental sensitivity assessments, are then presented. Finally, the chapter discusses performance monitoring to ensure sustained protection of public health and water resources.

### 3.2 Estimating wastewater characteristics

Accurate characterization of raw wastewater, including daily volumes, rates of flow, and associated pollutant load, is critical for effective treatment system design. Determining treatment system performance requirements, selecting appropriate treatment processes, designing the treatment system, and operating the system depends on an accurate assessment of the wastewater to be treated.

There are basically two types of onsite system wastewaters—residential and nonresidential. Single-family households, condominiums, apartment houses, multifamily households, cottages, and resort residences all fall under the category of residential dwellings. Discharges from these dwellings consist of a number of individual waste streams generated by water-using activities from a variety of plumbing fixtures and appliances. Wastewater flow and quality are influenced by the type of plumbing fixtures and appliances, their extent and frequency of use, and other factors such as the characteristics of the residing family, geographic location, and water supply (Anderson and Siegrist, 1989; Crites and Tchobanoglous, 1998; Siegrist, 1983).

A wide variety of institutional (e.g., schools), commercial (e.g., restaurants), and industrial

establishments and facilities fall into the nonresidential wastewater category. Wastewater-generating activities in some nonresidential establishments are similar to those of residential dwellings. Often, however, the wastewater from nonresidential establishments is quite different from that from residential dwellings and should be characterized carefully before Onsite Wastewater Treatment System (OWTS) design. The characteristics of wastewater generated in some types of nonresidential establishments might prohibit the use of conventional systems without changing wastewater loadings through advanced pretreatment or accommodating elevated organic loads by increasing the size of the subsurface wastewater infiltration system (SWIS). Permitting agencies should note that some commercial and large-capacity septic systems (systems serving 20 or more people, systems serving commercial facilities such as automotive repair shops) might be regulated under USEPA's Class V Underground Injection Control Program (see <http://www.epa.gov/safewater/uic/classv.html>).

In addition, a large number of seemingly similar nonresidential establishments are affected by subtle and often intangible influences that can cause significant variation in wastewater characteristics. For example, popularity, price, cuisine, and location can produce substantial variations in wastewater flow and quality among different restaurants (University of Wisconsin, 1978). Nonresidential wastewater characterization criteria that are easily applied and accurately predict flows and pollutant loadings are available for only a few types of establishments and are difficult to develop on a national basis with any degree of confidence. Therefore, for existing facilities the wastewater to be treated should be characterized by metering and sampling the current wastewater stream. For many existing developments and for almost any new development, however, characteristics of nonresidential wastewaters should be estimated based on available data. Characterization data from similar facilities already in use can provide this information.

### 3.3 Estimating wastewater flow

The required hydraulic capacity for an OWTS is determined initially from the estimated wastewater flow. Reliable data on existing and projected flows should be used if onsite systems are to be designed properly and cost-effectively. In situations where

onsite wastewater flow data are limited or unavailable, estimates should be developed from water consumption records or other information. When using water meter readings or other water use records, outdoor water use should be subtracted to develop wastewater flow estimates. Estimates of outdoor water use can be derived from discussions with residents on car washing, irrigation, and other outdoor uses during the metered period under review, and studies conducted by local water utilities, which will likely take into account climatic and other factors that affect local outdoor use.

Accurate wastewater characterization data and appropriate factors of safety to minimize the possibility of system failure are required elements of a successful design. System design varies considerably and is based largely on the type of establishment under consideration. For example, daily flows and pollutant contributions are usually expressed on a per person basis for residential dwellings. Applying these data to characterize residential wastewater therefore requires that a second parameter, the number of persons living in the residence, be considered. Residential occupancy is typically 1.0 to 1.5 persons per bedroom; recent census data indicate that the average household size is 2.7 people (U.S. Census Bureau, 1998). Local census data can be used to improve the accuracy of design assumptions. The current onsite code practice is to assume that maximum occupancy is 2 persons per bedroom, which provides an estimate that might be too conservative if additional factors of safety are incorporated into the design.

For nonresidential establishments, wastewater flows are expressed in a variety of ways. Although per person units may also be used for nonresidential wastewaters, a unit that reflects a physical characteristic of the establishment (e.g., per seat, per meat served, per car stall, or per square foot) is often used. The characteristic that best fits the wastewater characterization data should be employed (University of Wisconsin, 1978).

When considering wastewater flow it is important to address sources of water uncontaminated by wastewater that could be introduced into the treatment system. Uncontaminated water sources (e.g., storm water from rain gutters, discharges from basement sump pumps) should be identified and eliminated from the OWTS. Leaking joints,

cracked treatment tanks, and system damage caused by tree roots also can be significant sources of clear water that can adversely affect treatment performance. These flows might cause periodic hydraulic overloads to the system, reducing treatment effectiveness and potentially causing hydraulic failure.

### 3.3.1 Residential wastewater flows

#### Average daily flow

The average daily wastewater flow from typical residential dwellings can be estimated from indoor water use in the home. Several studies have evaluated residential indoor water use in detail (Anderson and Siegrist, 1989; Anderson et al., 1993; Brown and Caldwell, 1984; Mayer et al., 1999). A summary of recent studies is provided in table 3-1. These studies were conducted primarily on homes in suburban areas with public water supplies. Previous studies of rural homes on private wells generally indicated slightly lower indoor water use values. However, over the past three decades there has been a significant increase in the number of suburban housing units with onsite systems, and it has recently been estimated that the majority of OWTSSs in the United States are located in suburban metropolitan areas (Knowles, 1999). Based on the data in table 3-1, estimated average daily wastewater flows of approximately 50 to 70 gallons per person per day (189 to 265 liters per person per

day) would be typical for residential dwellings built before 1994.

In 1994 the U.S. Energy Policy Act (EPACT) standards went into effect to improve water use efficiency nationwide. EPACT established national flow rates for showerheads, faucets, urinals, and water closets. In 2004 and again in 2007 energy use standards for clothes washers will go into effect, and they are expected to further reduce water use by those appliances. Homes built after 1994 or retrofitted with EPACT-efficient fixtures would have typical average daily wastewater flows in the 40 to 60 gallons/person/day range. Energy- and water-efficient clothes washers may reduce the per capita flow rate by up to 5 gallons/person/day (Mayer et al., 2000).

Of particular interest are the results of the Residential End Uses of Water Study (REUWS), which was funded by the American Water Works Association Research Foundation (AWWARF) and 12 water supply utilities (Mayer et al., 1999). This study involved the largest number of residential water users ever characterized and provided an evaluation of annual water use at 1,188 homes in 12 metropolitan areas in North America. In addition, detailed indoor water use characteristics of approximately 100 homes in each of the 12 study areas were evaluated by continuous data loggers and computer software that identified fixture-specific end uses of water. Table 3-2 provides the

**Table 3-1. Summary of average daily residential wastewater flows<sup>a</sup>**

Study	Number of residences	Study duration (months)	Study average (gal/pers/day) <sup>b</sup>	Study range (gal/pers/day)
Brown & Caldwell (1984)	210		66.2 (250.6) <sup>b</sup>	57.3–73.0 (216.9–276.3) <sup>b</sup>
Anderson & Siegrist (1989)	90	3	70.8 (268.0)	65.9–76.6 (249.4–289.9)
Anderson et al. (1993)	25	3	50.7 (191.9)	26.1–85.2 (98.9–322.5)
Mayer et al. (1999)	1188	1 <sup>c</sup>	69.3 (262.3)	57.1–83.5 (216.1–316.1)
Weighted Average	153		68.6 (259.7)	

<sup>a</sup> Based on indoor water use monitoring and not wastewater flow monitoring.

<sup>b</sup> Liters/person/day in parentheses.

<sup>c</sup> Based on 2 weeks of continuous flow monitoring in each of two seasons at each home.

Table 3-2. Comparison of daily per capita indoor water use for 12 study sites

Study Site	Sample size (number of houses)	Mean daily per capita indoor use (gal/pers/day) <sup>a</sup>	Median daily per capita indoor use (gal/pers/day) <sup>a</sup>	Standard deviation of per capita indoor use (gal/pers/day) <sup>a</sup>
Seattle, WA	99	57.1	54.0	28.6
San Diego, CA	100	58.3	54.1	23.4
Boulder, CO	100	64.7	60.3	25.8
Lompoc, CA	100	65.8	56.1	33.4
Tampa, FL	99	65.8	59.0	33.5
Walnut Valley Water District, CA	99	67.8	63.3	30.8
Denver, CO	99	69.3	64.9	35.0
Las Virgenes Metropolitan Water District, CA	100	69.6	61.0	38.6
Waterloo & Cambridge, ON	95	70.6	59.5	44.6
Phoenix, AZ	100	77.6	66.9	44.8
Tempe & Scottsdale, AZ	99	81.4	63.4	67.6
Eugene, OR	98	83.5	63.8	68.9
12 study sites	1188	69.3 (316.5) <sup>b</sup>	60.5 (289.0) <sup>b</sup>	39.6 (149.9) <sup>b</sup>

<sup>a</sup> Multiply gallons/person/day by 3.875 to obtain liters/person/day.

<sup>b</sup> Liters/person/day in parentheses.

Source: Mayer et al., 1999.

average daily per capita indoor water use by study site for the 1,188 homes. The standard deviation data provided in this table illustrate the significant variation of average daily flow among residences. The median daily per capita flow ranged from 54 to 67 gallons/person/day (204 to 253 liters/person/day) and probably provides a better estimate of average daily flow for most homes given the distribution of mean per capita flows in figure 3-1 (Mayer et al., 2000). This range might be reduced further in homes with EPACT-efficient fixtures and appliances.

### Individual activity flows

Average daily flow is the average total flow generated on a daily basis from individual wastewater-generating activities in a building. These activities typically include toilet flushing, showering and bathing, clothes washing and dishwashing, use of faucets, and other miscellaneous uses. The average flow characteristics of several major residential water-using activities are presented in table 3-3. These data were derived from some 1 million measured indoor water use events in 1,188 homes in 12 suburban areas as part of the REUWS (Mayer et al., 1999). Figure 3-2 illustrates these same data graphically.

One of the more important wastewater-generating flows identified in this study was water leakage from plumbing fixtures. The average per capita leakage measured in the REUWS was 9.5 gallons/person/day (35.0 liters/person/day). However, this value was the result of high leakage rates at a relatively small percentage of homes. For example, the average daily leakage per household was 21.9 gallons (82.9 liters) with a standard deviation of 54.1 gallons (204.8 liters), while the median leakage rate was only 4.2 gallons/house/day (15.9 liters/house/day). Nearly 67 percent of the homes in the study had average leakage rates of less than 10 gallons/day (37.8 liters/day), but 5.5 percent of the study homes had leakage rates that averaged more than 100 gallons (378.5 liters) per day. Faulty toilet flapper valves and leaking faucets were the primary sources of leaks in these high-leakage-rate homes. Ten percent of the homes monitored accounted for 58 percent of the leakage measured. This result agrees with a previous end use study where average leakage rates of 4 to 8 gallons/person/day (15.1 to 30.3 liters/person/day) were measured (Brown and Caldwell, 1984). These data point out the importance of leak detection and repair during maintenance or repair of onsite

Table 3-3. Residential water use by fixture or appliance<sup>a,b</sup>

Fixture/use	Gal/use: Average range	Uses/person/day: Average range	Gal/person/ day: Average range <sup>c</sup>	% Total: Average range
Toilet	3.5 2.9–3.9	5.05 4.5–5.6	18.5 15.7–22.9	26.7 22.6–30.6
Shower	17.2 <sup>d</sup> 14.9–18.6	0.75 <sup>d</sup> 0.6–0.9	11.6 8.3–15.1	16.8 11.8–20.2
Bath	See shower	See shower	1.2 0.5–1.9	1.7 0.9–2.7
Clothes washer	40.5 —	0.37 0.30–0.42	15.0 12.0–17.1	21.7 17.8–28.0
Dishwasher	10.0 9.3–10.6	0.10 0.06–0.13	1.0 0.6–1.4	1.4 0.9–2.2
Faucets	1.4 <sup>e</sup> —	8.1 <sup>f</sup> 6.7–9.4	10.9 8.7–12.3	15.7 12.4–18.5
Leaks	NA	NA	9.5 3.4–17.6	13.7 5.3–21.6
Other Domestic	NA	NA	1.6 0.0–6.0	2.3 0.0–8.5
Total	NA	NA	69.3 57.1–83.5	100

<sup>a</sup> Results from AWWARF REUWS at 1,188 homes in 12 metropolitan areas. Homes surveyed were served by public water supplies, which operate at higher pressures than private water sources. Leakage rates might be lower for homes on private water supplies.

<sup>b</sup> Results are averages over range. Range is the lowest to highest average for 12 metropolitan areas.

<sup>c</sup> Gal/person/day might not equal gal/use multiplied by uses/person/day because of differences in the number of data points used to calculate means.

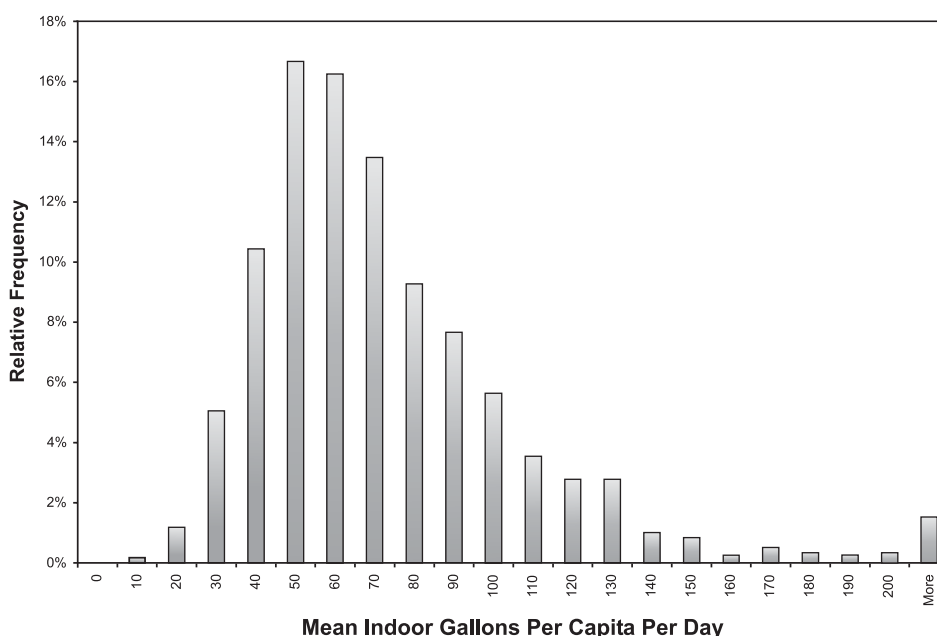
<sup>d</sup> Includes shower and bath.

<sup>e</sup> Gallons per minute.

<sup>f</sup> Minutes of use per person per day.

Source: Mayer et al., 1999.

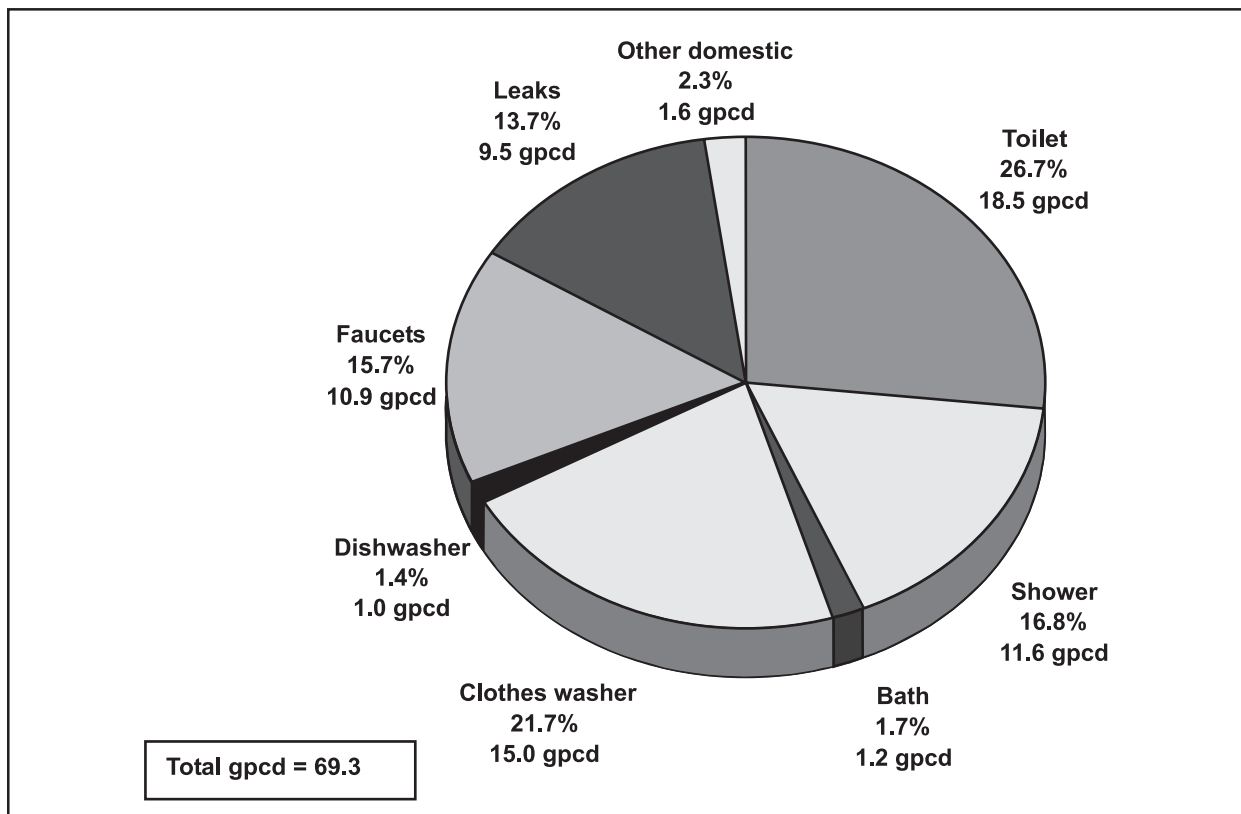
Figure 3-1. Distribution of mean household daily per capita indoor water use for 1,188 data-logged homes



Source: Mayer et al., 1999.



Figure 3-2. Indoor water use percentage, including leakage, for 1,188 data logged homes<sup>a</sup>



<sup>a</sup> gpcd = gallons per capita (person) per day  
 Source: Mayer et al. 1999.

systems. Leakage rates like those measured in the REUWS could significantly increase the hydraulic load to an onsite wastewater system and might reduce performance.

### Maximum daily and peak flows

Maximum and minimum flows and instantaneous peak flow variations are necessary factors in properly sizing and designing system components. For example, most of the hydraulic load from a home occurs over several relatively short periods of time (Bennett and Lindstedt, 1975; Mayer et al., 1999; University of Wisconsin, 1978). The system should be capable of accepting and treating normal peak events without compromising performance. For further discussion of flow variations, see section 3.3.3.

### 3.3.2 Nonresidential wastewater flows

For nonresidential establishments typical daily flows from a variety of commercial, institutional, and recreational establishments are shown in tables 3-4 to 3-6 (Crites and Tchobanoglous, 1998; Tchobanoglous and Burton, 1991). The typical values presented are not necessarily an average of the range of values but rather are weighted values based on the type of establishment and expected use. Actual monitoring of specific wastewater flow and characteristics for nonresidential establishments is strongly recommended. Alternatively, a similar establishment located in the area might provide good information. If this approach is not feasible, state and local regulatory agencies should be consulted for approved design flow guidelines for nonresidential establishments. Most design flows provided by regulatory agencies are very conservative estimates based on peak rather than average daily flows. These agencies might accept only their established flow values and therefore should be contacted before design work begins.

Table 3-4. Typical wastewater flow rates from commercial sources<sup>a,b</sup>

Facility	Unit	Flow, gallons/unit/day		Flow, liters/unit/day		
		Range	Typical	Range	Typical	
Airport	Passenger	2-4	3	8-15	11	
Apartment house	Person	40-80	50	150-300	190	
Automobile service station <sup>c</sup>	Vehicle served	8-15	12	30-57	45	
	Employee	9-15	13	34-57	49	
Bar	Customer	1-5	3	4-19	11	
	Employee	10-16	13	38-61	49	
Boarding house	Person	25-60	40	95-230	150	
Department store	Toilet room	400-600	500	1,500-2,300	1,900	
	Employee	8-15	10	30-57	38	
Hotel	Guest	40-60	50	150-230	190	
	Employee	8-13	10	30-49	38	
Industrial building (sanitary waste only)	Employee	7-16	13	26-61	49	
Laundry (self-service)	Machine	450-650	550	1,700-2,500	2,100	
	Wash	45-55	50	170-210	190	
Office	Employee	7-16	13	26-61	49	
Public lavatory	User	3-6	5	11-23	19	
Restaurant (with toilet)	Meal	2-4	3	8-15	11	
	Conventional	Customer	8-10	9	30-38	34
	Short order	Customer	3-8	6	11-30	23
	Bar/cocktail lounge	Customer	2-4	3	8-15	11
Shopping center	Employee	7-13	10	26-49	38	
	Parking space	1-3	2	4-11	8	
Theater	Seat	2-4	3	8-15	11	

<sup>a</sup> Some systems serving more than 20 people might be regulated under USEPA's Class V Underground Injection Control (UIC) Program. See <http://www.epa.gov/safewater/uic.html> for more information.

<sup>b</sup> These data incorporate the effect of fixtures complying with the U.S. Energy Policy Act (EPACT) of 1994.

<sup>c</sup> Disposal of automotive wastes via subsurface wastewater infiltration systems is banned by Class V UIC regulations to protect ground water. See <http://www.epa.gov/safewater/uic.html> for more information.

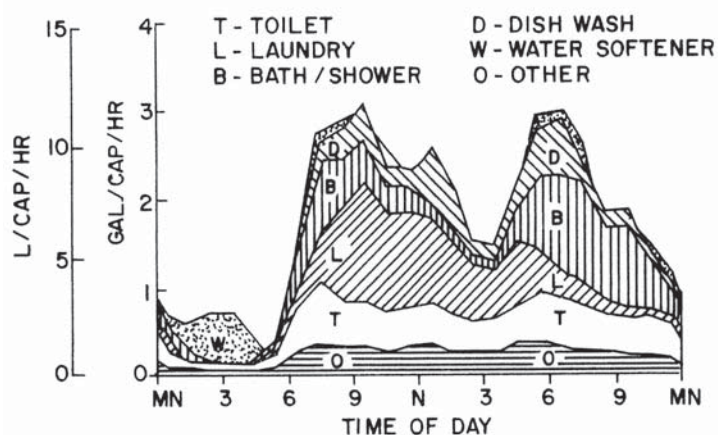
Source: Crites and Tchobanoglous, 1998.

### 3.3.3 Variability of wastewater flow

Variability of wastewater flow is usually characterized by daily and hourly minimum and maximum flows and instantaneous peak flows that occur during the day. The intermittent occurrence of individual wastewater-generating activities can create large variations in wastewater flows from residential or nonresidential establishments. This variability can affect gravity-fed onsite systems by potentially causing hydraulic overloads of the system during peak flow conditions. Figure 3-3 illustrates the routine fluctuations in wastewater flows for a typical residential dwelling.

Wastewater flow can vary significantly from day to day. Minimum hourly flows of zero are typical for

Figure 3-3. Daily indoor water use pattern for single-family residence



Source: University of Wisconsin, 1978.

Table 3-5. Typical wastewater flow rates from institutional sources<sup>a</sup>

Facility	Unit	Flow, gallons/unit/day		Flow, liters/unit/day	
		Range	Typical	Range	Typical
Assembly hall	Seat	2–4	3	8–15	11
Hospital, medical	Bed	125–240	165	470–910	630
	Employee	5–15	10	19–57	38
Hospital, mental	Bed	75–140	100	280–530	380
	Employee	5–15	10	19–57	38
Prison	Inmate	80–150	120	300–570	450
	Employee	5–15	10	19–57	38
Rest home	Resident	50–120	90	190–450	340
	Employee	5–15	10	19–57	38
School, day-only:					
With cafeteria, gym, showers	Student	15–30	25	57–110	95
With cafeteria only	Student	10–20	15	38–76	57
Without cafeteria, gym, or showers	Student	5–17	11	19–64	42
School, boarding	Student	50–100	75	190–380	280

<sup>a</sup>Systems serving more than 20 people might be regulated under USEPA's Class V UIC Program. See <http://www.epa.gov/safewater/uic.html> for more information.

Source: Crites and Tchobanoglous, 1998.

residential dwellings. Maximum hourly flows as high as 100 gallons (380 L/hr) (Jones, 1976; Watson et al., 1967) are not unusual given the variability of typical fixture and appliance usage characteristics and residential water use demands. Hourly flows exceeding this rate can occur in cases of plumbing fixture failure and appliance misuse (e.g., broken pipe or fixture, faucets left running).

Wastewater flows from nonresidential establishments are also subject to wide fluctuations over time and are dependent on the characteristics of water-using fixtures and appliances and the busi-

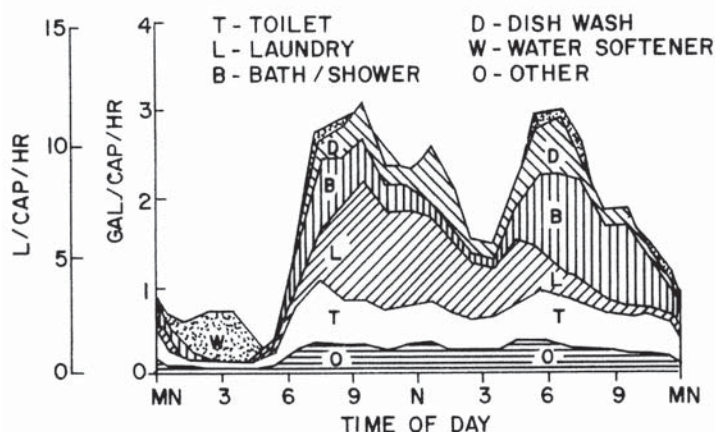
ness characteristics of the establishment (e.g., hours of operation, fluctuations in customer traffic).

The peak flow rate from a residential dwelling is a function of the fixtures and appliances present and their position in the plumbing system configuration. The peak discharge rate from a given fixture or appliance is typically around 5 gallons/minute (19 liters/minute), with the exception of the tank-type toilet and possibly hot tubs and bathtubs. The use of several fixtures or appliances simultaneously can increase the total flow rate above the rate for isolated fixtures or appliances. However, attenuation occurring in the residential drainage system tends to decrease peak flow rates observed in the sewer pipe leaving the residence. Although field data are limited, peak discharge rates from a single-family dwelling of 5 to 10 gallons/minute (19 to 38 liters/minute) can be expected. Figure 3-4 illustrates the variability in peak flow from a single home.

### 3.4 Wastewater quality

The qualitative characteristics of wastewaters generated by residential dwellings and nonresidential establishments can be distinguished by their physical, chemical, and biological composition. Because individual water-using events occur intermittently and contribute varying quantities of

Figure 3-4. Peak wastewater flows for single-family home



Source: University of Wisconsin, 1978.

Table 3-6. Typical wastewater flow rates from recreational facilities<sup>a</sup>

Facility	Unit	Flow, gallons/unit/day		Flow, liters/unit/day	
		Range	Typical	Range	Typical
Apartment, resort	Person	50–70	60	190–260	230
Bowling alley	Alley	150–250	200	570–950	760
Cabin, resort	Person	8–50	40	30–190	150
Cafeteria	Customer	1–3	2	4–11	8
	Employee	8–12	10	30–45	38
Camps:					
Pioneer type	Person	15–30	25	57–110	95
Children's, with central toilet/bath	Person	35–50	45	130–190	170
Day, with meals	Person	10–20	15	38–76	57
Day, without meals	Person	10–15	13	38–57	49
Luxury, private bath	Person	75–100	90	280–380	340
Trailer camp	Trailer	75–150	125	280–570	470
Campground-developed	Person	20–40	30	76–150	110
Cocktail lounge	Seat	12–25	20	45–95	76
Coffee Shop	Customer	4–8	6	15–30	23
	Employee	8–12	10	30–45	38
Country club	Guests onsite	60–130	100	230–490	380
	Employee	10–15	13	38–57	49
Dining hall	Meal served	4–10	7	15–38	26
Dormitory/bunkhouse	Person	20–50	40	76–190	150
Fairground	Visitor	1–2	2	4–8	8
Hotel, resort	Person	40–60	50	150–230	190
Picnic park, flush toilets	Visitor	5–10	8	19–38	30
Store, resort	Customer	1–4	3	4–15	11
	Employee	8–12	10	30–45	38
Swimming pool	Customer	5–12	10	19–45	38
	Employee	8–12	10	30–45	38
Theater	Seat	2–4	3	8–15	11
Visitor center	Visitor	4–8	5	15–30	19

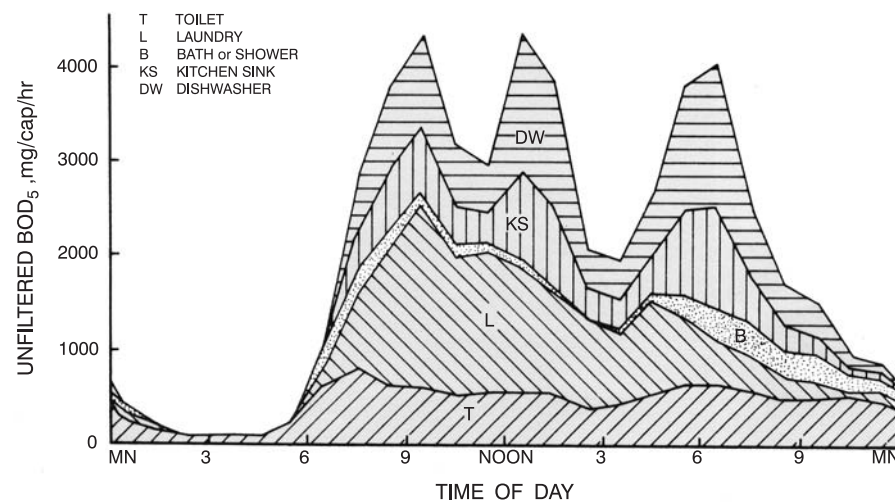
<sup>a</sup> Some systems serving more than 20 people might be regulated under USEPA's Class V UIC Program.

Source: Crites and Tchobanoglous, 1998.

pollutants, the strength of residential wastewater fluctuates throughout the day (University of Wisconsin, 1978). For nonresidential establishments, wastewater quality can vary significantly among different types of establishments because of differences in waste-generating sources present, water usage rates, and other factors. There is currently a dearth of useful data on nonresidential wastewater organic strength, which can create a large degree of uncertainty in design if facility-specific data are not available. Some older data (Goldstein and Moberg, 1973; Vogulis, 1978) and some new information exists, but modern organic strengths need to be

verified before design given the importance of this aspect of capacity determination.

Wastewater flow and the type of waste generated affect wastewater quality. For typical residential sources peak flows and peak pollutant loading rates do not occur at the same time (Tchobanoglous and Burton, 1991). Though the fluctuation in wastewater quality (see figure 3-5) is similar to the water use patterns illustrated in figure 3-3, the fluctuations in wastewater quality for an individual home are likely to be considerably greater than the multiple-home averages shown in figure 3-5.

Figure 3-5. Average hourly distribution of total unfiltered BOD<sub>5</sub>

Source: University of Wisconsin, 1978.

OWTSs should be designed to accept and process hydraulic flows from a residence (or establishment) while providing the necessary pollutant removal efficiency to achieve performance goals. The concentrations of typical pollutants in raw residential wastewaters and average daily mass loadings are summarized in table 3-7. Residential water-using activities contribute varying amounts of pollutants to the total wastewater flow. Table 3-8 contains a summary of the average mass loading of several key pollutants from the sources identified in table 3-7.

If the waste-generating sources present at a particular nonresidential establishment are similar to those of a typical residential dwelling, an approximation of the pollutant mass loadings and concentrations in the wastewater can be derived using the residential wastewater quality data for those categories presented in tables 3-7 and 3-8. However, the results of previous studies have demonstrated that in many cases nonresidential wastewater is considerably different from residential wastewater. Restaurant wastewater, for example, contains substantially higher levels of organic matter, solids, and grease compared to typical residential wastewater (Siegrist et al., 1984; University of Wisconsin, 1978). Restaurant wastewater BOD<sub>5</sub> concentrations reported in the literature range from values similar to those for domestic waste to well over 1,000 milligrams/liter, or 3.5 to 6.5 times higher than residential BOD<sub>5</sub>. Total suspended solids and grease concentrations in restaurant wastewaters were reported to be 2 to 5 times higher than the concentrations in domestic wastewaters (Kulesza, 1975;

Shaw, 1970). For shopping centers, the average characteristics determined by one study found BOD<sub>5</sub> average concentrations of 270 milligrams/liter, with suspended solids concentrations of 337 milligrams/liter and grease concentrations of 67 milligrams/liter (Hayashida, 1975).

More recent characterizations of nonresidential establishments have sampled septic tank effluent, rather than the raw wastewater, to more accurately identify and quantify the mass pollutant loads delivered to the components of the final treatment train (Ayres Associates, 1991; Siegrist et al., 1984). Because of the variability of the data, for establishments where the waste-generating sources are significantly different from those in a residential dwelling or where more refined characterization data might be appropriate, a detailed review of the pertinent literature, as well as wastewater sampling at the particular establishment or a similar establishment, should be conducted.

### 3.5 Minimizing wastewater flows and pollutants

Minimizing wastewater flows and pollutants involves techniques and devices to (1) reduce water use and resulting wastewater flows and (2) decrease the quantity of pollutants discharged to the waste stream. Minimizing wastewater volumes and pollutant concentrations can improve the efficiency of onsite treatment and lessen the risk of hydraulic or treatment failure (USEPA, 1995). These meth-



**Table 3-7. Constituent mass loadings and concentrations in typical residential wastewater<sup>a</sup>**

Constituent	Mass loading (grams/person/day)	Concentration <sup>b</sup> (mg/L)
Total solids (TS)	115–200	500–880
Volatile solids	65–85	280–375
Total suspended solids (TSS)	35–75	155–330
Volatile suspended solids	25–60	110–265
5-day biochemical oxygen demand (BOD <sub>5</sub> )	35–65	155–286
Chemical oxygen demand (COD)	115–150	500–660
Total nitrogen (TN)	6–17	26–75
Ammonia (NH <sub>4</sub> )	1–3	4–13
Nitrites and nitrates (NO <sub>2</sub> -N; NO <sub>3</sub> -N)	<1	<1
Total phosphorus (TP) <sup>c</sup>	1–2	6–12
Fats, oils, and grease	12–18	70–105
Volatile organic compounds (VOC)	0.02–0.07	0.1–0.3
Surfactants	2–4	9–18
Total coliforms (TC) <sup>d</sup>	–	10 <sup>8</sup> –10 <sup>10</sup>
Fecal coliforms (FC) <sup>d</sup>	–	10 <sup>6</sup> –10 <sup>8</sup>

<sup>a</sup> For typical residential dwellings equipped with standard water-using fixtures and appliances.

<sup>b</sup> Milligrams per liter; assumed water use of 60 gallons/person/day (227 liters/person/day).

<sup>c</sup> The detergent industry has lowered the TP concentrations since early literature studies; therefore, Sedlak (1991) was used for TP data.

<sup>d</sup> Concentrations presented in Most Probable Number of organisms per 100 milliliters.

Source: Adapted from Bauer et al., 1979; Bennett and Linstedt, 1975; Laak, 1975, 1986; Sedlak, 1991; Tchobanoglous and Burton, 1991.

**Table 3-8. Residential wastewater pollutant contributions by source<sup>a,b</sup>**

Parameter		Garbage disposal (gpcd) <sup>c</sup>	Toilet (gpcd) <sup>c</sup>	Bathing, sinks, appliances (gpcd) <sup>c</sup>	Approximate total (gpcd) <sup>c</sup>
BOD <sub>5</sub>	mean	18.0	16.7	28.5	63.2
	range	10.9–30.9	6.9–23.6	24.5–38.8	
	% of total	(28%)	(26%)	(45%)	(100%)
Total suspended solids	mean	26.5	27.0	17.2	70.7
	range	15.8–43.6	12.5–36.5	10.8–22.6	
	% of total	(37%)	(38%)	(24%)	(100%)
Total nitrogen	mean	0.6	8.7	1.9	11.2
	range	0.2–0.9	4.1–16.8	1.1–2.0	
	% of total	(5%)	(78%)	(17%)	(100%)
Total phosphorus <sup>d</sup>	mean	0.1	1.6	1.0	2.7
	range	—	—	—	—
	% of total	(4%)	(59%)	(37%)	(100%)

<sup>a</sup> Adapted from USEPA, 1992.

<sup>b</sup> Means and ranges for BOD, TSS, and TN are results reported in Bennett and Linstedt, 1975; Laak, 1975; Ligman et al., 1974; Olsson et al., 1968; and Siegrist et al., 1976.

<sup>c</sup> Grams per capita (person) per day.

<sup>d</sup> The use of low-phosphate detergents in recent years has lowered the TP concentrations since early literature studies; therefore, Sedlak (1991) was used for TP data.

ods have been developed around two main strategies—wastewater flow reduction and pollutant mass reduction. Although this section emphasizes residential flows, many of the concepts are applicable to nonresidential establishments. (For more information on both residential and nonresidential water use reduction, see <http://www.epa.gov/OW/you/intro.html>.)

### **3.5.1 Minimizing residential wastewater volumes**

The most commonly reported failure of residential OWTS infiltration systems is hydraulic overloading. Hydraulic overloads can be caused by wastewater flow or pollutant loads that exceed system design capacity. When more water is processed than an OWTS is designed to handle, detention time within the treatment train is reduced, which can decrease pollutant removal in the tank and overload the infiltration field. Reducing water use in a residence can decrease hydraulic loading to the treatment system and generally improve system performance. If failure is caused by elevated pollutant loads, however, other options should be considered (see chapter 5).

Indoor residential water use and resulting wastewater flows are attributed mainly to toilet flushing, bathing, and clothes washing (figure 3-2). Toilet use usually accounts for 25 to 30 percent of indoor water use in residences; toilets, showers, and faucets in combination can represent more than 70 percent of all indoor use. Residential wastewater flow reduction can therefore be achieved most dramatically by addressing these primary indoor uses and by minimizing wastewater flows from extraneous sources. Table 3-9 presents many of the methods that have been applied to achieve wastewater flow reduction.

#### **Eliminating extraneous flows**

Excessive water use can be reduced or eliminated by several methods, including modifying water use habits and maintaining the plumbing system appropriately. Examples of methods to reduce water use include

- Using toilets to dispose of sanitary waste only (not kitty litter, diapers, ash tray contents, and other materials.)

- Reducing time in the shower
- Turning off faucets while brushing teeth or shaving
- Operating dishwashers only when they are full
- Adjusting water levels in clothes washers to match loads; using machine only when full
- Making sure that all faucets are completely turned off when not in use
- Maintaining plumbing system to eliminate leaks

These practices generally involve changes in water use behavior and do not require modifying of plumbing or fixtures. Homeowner education programs can be an effective approach for modifying water use behavior (USEPA, 1995). Wastewater flow reduction resulting from eliminating wasteful water use habits will vary greatly depending on past water use habits. In many residences, significant water use results from leaking plumbing fixtures. The easiest ways to reduce wastewater flows from indoor water use are to properly maintain plumbing fixtures and repair leaks when they occur. Leaks that appear to be insignificant, such as leaking toilets or dripping faucets, can generate large volumes of wastewater. For example, a 1/32-inch (0.8 millimeters) opening at 40 pounds per square inch (207 mm of mercury) of pressure can waste from 3,000 to 6,000 gallons (11,550 to 22,700 liters) of water per month. Even apparently very slow leaks, such as a slowly dripping faucet, can generate 15 to 20 gallons (57 to 76 liters) of wastewater per day.

#### **Reducing wastewater flow**

Installing indoor plumbing fixtures that reduce water use and replacing existing plumbing fixtures or appliances with units that use less water are successful practices that reduce wastewater flows (USEPA, 1995). Recent interest in water conservation has been driven in some areas by the absence of adequate source water supplies and in other areas by a desire to minimize the need for expensive wastewater treatment. In 1992 Congress passed the U.S. Energy Policy Act (EPACT) to establish national standards governing the flow capacity of showerheads, faucets, urinals, and water closets for the purpose of national energy and water conservation (table 3-10). Several states have also implemented specific water conservation practices

Table 3-9. Wastewater flow reduction methods

**Elimination of extraneous flows**

- Improved water-use habits
- Improved plumbing and appliance maintenance and monitoring
- Elimination of excessive water supply pressure

**Reduction of existing wastewater flows**

- Toilets
 

<ul style="list-style-type: none"> <li>Water-carriage toilets               <ul style="list-style-type: none"> <li>- Toilet-tank inserts</li> <li>- Ultra-low flush (ULF) toilets (1.6 gal or 6 L per flush or less)</li> <li>Wash-down flush</li> <li>Pressurized tank</li> </ul> </li> </ul>	<ul style="list-style-type: none"> <li>Non-water-carriage toilets               <ul style="list-style-type: none"> <li>- Biological (compost) toilets</li> <li>- Incinerator toilets</li> </ul> </li> </ul>
--	---
- Bathing devices, fixtures, and appliances
  - Shower flow controls
  - Reduced-flow showerheads
  - On/off showerhead valves
  - Mixing valves
  - Air-assisted, low-flow shower system
- Clothes-washing devices, fixtures, and appliances
  - High-efficiency washer
  - Adjustable cycle settings
  - Washwater recycling feature
- Miscellaneous
  - Faucet inserts
  - Faucet aerators
  - Reduced-flow faucet fixtures
  - Mixing valves
  - Hot water pipe insulation
  - Pressure-reducing valves
  - Hot water recirculation

**Wastewater recycle/reuse systems**

- Sink/bath/laundry wastewater recycling for toilet flushing
- Recycling toilets
- Combined wastewater recycling for toilet flushing
- Combined wastewater recycling for outdoor irrigation

Sources: Adapted from USEPA, 1992, 1995.

(USEPA, 1995; for case studies and other information, see <http://www.epa.gov/OW/you/intro.html>).

Several toilet designs that use reduced volumes of water for proper operation have been developed. Conventional toilets manufactured before 1994 typically use 3.5 gallons (13.2 liters) of water per flush. Reduced-flow toilets manufactured after 1994 use 1.6 gallons (6.1 liters) or less per flush. Though studies have shown an increased number of flushes with reduced-flow toilets, potential savings of up to 10 gallons/person/day (37.8 liters/person/day) can be achieved (Aher et al., 1991; Anderson

et al., 1993; Mayer et al., 1999, 2000). Table 3-11 contains information on water carriage toilets and systems; table 3-12 contains information on non-water-carriage toilets. The reader is cautioned that not all fixtures perform well in every application and that certain alternatives might not be acceptable to the public.

The volume of water used for bathing varies considerably based on individual habits. Averages indicate that showering with common showerheads using 3.0 to 5.0 gallons/minute (0.19 to 0.32 liters/second) amounts to a water use of 10 to 12.5

Table 3-10. Comparison of flow rates and flush volumes before and after U.S. Energy Policy Act

Fixture	Fixtures installed prior to 1994 in gallons/minute (liters/second)	EPACT requirements (effective January, 1994)	Potential reduction in water used (%)
Kitchen faucet	3.0 gpm (0.19 L/s)	2.5 gpm (0.16 L/s)	16
Lavatory faucets	3.0 gpm (0.19 L/s)	2.5 gpm (0.16 L/s)	16
Showerheads	3.5 gpm (0.22 L/s)	2.5 gpm (0.16 L/s)	28
Toilet (tank type)	3.5 gal (13.2 L)	1.6 gal (6.1 L)	54
Toilet (valve type)	3.5 gal (13.2 L)	1.6 gal <sup>a</sup> (6.1 L)	54
Urinal	3.0 gal (11.4 L)	1.0 gal (3.8 L)	50

Source: Konen, 1995.

Table 3-11. Wastewater flow reduction: water-carriage toilets and systems <sup>a</sup>

Generic type	Description	Application considerations	Operation & maintenance	Water use per event gal (L)	Total flow reduction in gpcd (Lpcd); % of use <sup>b</sup>
Toilets with tank inserts	Displacement devices placed into storage tank of conventional toilet to reduce volume but not height of stored water.	Device must be compatible with existing toilet and not interfere with flush mechanism	Frequent post-installation inspections to ensure proper positioning	3.3–3.8 (12.5–14.4)	1.8–3.5 (6.8–13.2) 4%–8%
	Varieties: Plastic bottles, flexible panels, drums, or plastic bags	Installation by owner  Reliability low; failure can result in large flow increase			
Water-saving toilets	Variation of conventional flush toilet fixture; similar in appearance and operation. Redesigned flushing rim and priming jet to initiate siphon flush in smaller trapway with less water.	Interchangeable with conventional fixture	Essentially the same as for a conventional unit	1.0–1.6 (3.8–13.2)	5.3–13 (12.1–49.2) 6%–20%
Washdown flush toilets	Flushing uses only water, but substantially less due to washdown flush	Rough-in for unit may be nonstandard	Similar to conventional toilet	0.8–1.6 (3.0–6.1)	9.4–12.2 (35.6–46.2)
	Varieties: Few  Note: Water usage may increase due to multiple flushings	Drain-line slope and lateral-run restrictions  Plumber installation advisable	Cleaning possible	(but more frequent flushings possible)	21%–27%
Pressurized-tank toilets	Specially designed toilet tank to pressurize air contained in toilet tank. Upon flushing, compressed air propels water into bowl at increased velocity	Compatible with most conventional toilet units  Increased noise level	Periodic maintenance of compressed air source	2.0–2.5 (7.6–9.5)	6.3–8.0 (23.8–30.3) 14%–18%
	Varieties: Few	Water supply pressure of 35–120 psi (180–620 cm Hg) required			

<sup>a</sup> Adapted from USEPA, 1992. Compared to conventional toilet usage (4.3 gallons/flush [16.3 liters/flush], 3.5 uses per person per day, and a total daily flow of 45 gallons/person/day [170 liters/person/day]).

<sup>b</sup> gpcd = gallons per capita (person) per day; Lpcd = liters per capita (person) per day.

Table 3-12. Wastewater flow reduction: non-water-carriage toilets <sup>a</sup>

Generic type	Description	Application considerations	Operation and maintenance
Biological toilets	Large units with a separated decomposition chamber. Accept toilet wastes and other organic matter, and over a long time period partially stabilize excreta through biological activity and evaporation.	Installation requires 6- to 12-in (150-mm to 300-mm)-diameter roof vent, space beneath floor for decomposition chamber, ventilation system, and heating Handles toilet waste and some kitchen waste Restricted usage capacity cannot be exceeded Difficult to retrofit and expensive	Periodic addition of organic matter Removal of product material at 6- to 24-month intervals should be performed by management authority due to risk of exposure to pathogens in wastes Heat loss through vent
Incinerator toilets	Small self-contained units that volatilize the organic components of human waste and evaporate the liquids.	Installation requires 4-in-diameter roof vent Handles only toilet waste Power or fuel required Increased noise level Residuals disposal Limited usage rate (frequency)	Weekly removal of ash Semiannual cleaning and adjustment of burning assembly or heating elements Fuel units could pose safety concerns

<sup>a</sup> Adapted from USEPA, 1992. None of these devices uses any water; therefore, the amount of flow and pollutant reduction equal to those of conventional toilet use (see table 3-3). Significant quantities of pollutants (including N, BOD<sub>5</sub>, SS, P, and pathogens) are therefore removed from the wastewater stream (table 3-8).

Table 3-13. Wastewater flow reduction: showering devices and systems <sup>a</sup>

Generic type	Description	Application considerations	Water use rate
Shower flow-control inserts and restrictors	Reduce flow rate by reducing diameter of supply line ahead of showerhead	Compatible with most existing showerheads. User habits may negate potential savings by extended shower duration	1.5–3.0 gal/min (0.09–0.19 L/s)
Reduced-flow showerheads	Fixtures similar to conventional, except restrict flow rate  Varieties: Many manufacturers, but units similar	Compatible with most conventional plumbing Installed by user	1.5–2.5 gal/min (0.09–0.19 L/s)
On/off showerhead valve	Small valve device placed in supply line ahead of showerhead allows shower flow to be turned on and off without readjustment of volume or temperature	Compatible with most conventional plumbing and fixtures Usually installed by plumber	Unchanged, but total duration and use are reduced
Mixing valves	Specifically designed valves maintain constant temperature of total flow. Faucets may be operated (on and off) without temperature adjustment	Compatible with most conventional plumbing and fixtures Usually installed by plumber	Unchanged, but daily duration and use are reduced
Air-assisted, low-flow shower system	Specifically designed system uses compressed air to atomize water flow and provide shower sensation	May be difficult and expensive to retrofit Requires shower location less than 50 ft (15.3 m) away from water heater Requires compressed air and power source Requires maintenance of air compressor	0.5 gal/min (0.3 L/s)

Note: gal/min = gallons per minute; L/s = liters per second.

<sup>a</sup> Adapted from USEPA, 1992.



gallons/person/day (37.9 to 47.3 liters/person/day). Table 3-13 provides an overview of showering devices available to reduce wastewater flows associated with shower use. A low-flow showerhead can reduce water flow through the shower by 2 or 3 gallons/minute (0.13 to 0.19 liters/second), but if the user stays in the shower twice as long because the new showerhead does not provide enough pressure or flow to satisfy showering preferences, projected savings can be negated.

Indoor water use can also be reduced by installing flow reduction devices or faucet aerators at sinks and basins. More efficient faucets can reduce water use from 3 to 5 gallons/minute (0.19 to 0.32 liters/second) to 2 gallons/minute (0.13 liters/second), and aerators can reduce water use at faucets by as much as 60 percent while still maintaining a strong flow. Table 3-14 provides a summary of wastewater flow reduction devices that can be applied to water use at faucets.

### Reducing water pressure

Reducing water pressure is another method for reducing wastewater flows. The flow rate at faucets and showers is directly related to the water pressure in the water supply line. The maximum water flow from a fixture operating on a fixed setting can be

reduced by reducing water pressure. For example, a reduction in pressure from 80 pounds per square inch (psi) (414 cm Hg) to 40 psi (207 cm Hg) can reduce the flow rate through a fully opened faucet by about 40 percent. Reduced pressure has little effect on the volume of water used by fixtures that operate on a fixed volume of water, such as toilets and washing machines, but it can reduce wastewater flows from sources controlled by the user (e.g., faucets, showerheads).

### 3.5.2 Reducing mass pollutant loads in wastewater

Pollutant mass loading modifications reduce the amount of pollutants requiring removal or treatment in the OWTS. Methods that may be applied for reducing pollutant mass loads include modifying product selection, improving user habits, and eliminating or modifying certain fixtures. Household products containing toxic compounds, commonly referred to as “household hazardous waste,” should be disposed of properly to minimize threats to human health and the environment. For more information on disposal options and related issues, visit the USEPA Office of Solid Waste’s *Household Hazardous Waste* web site at <http://www.epa.gov/epaoswer/non-hw/muncpl/hhw.htm>.

Table 3-14. Wastewater flow reduction: miscellaneous devices and systems

Generic type	Description	Application considerations
Faucet insert	Device that inserts into faucet valve or supply line and restricts flow rate with a fixed or pressure-compensating orifice	Compatible with most plumbing Installation simple
Faucet aerator	Devices attached to faucet outlet that entrain air into water flow	Compatible with most plumbing Installation simple Periodic cleaning of aerator screens
Reduced-flow faucet	Similar to conventional unit, but restricts flow rate with a fixed or pressure-compensating orifice	Compatible with most plumbing Installation identical to conventional faucet
Mixing valves	Specifically designed valve units that allow flow and temperature to be set with a single control	Compatible with most plumbing Installation identical to conventional valve units
Hot-water system insulation	Hot-water heater and piping are wrapped with insulation to reduce heat loss and water use (faucet delivers hot water quicker)	May be difficult to wrap entire hot-water piping system after house is built.

<sup>a</sup> Adapted from USEPA, 1992.

Source: Adapted from USEPA, 1992.

## Selecting cleaning agents and household chemicals

Toilet flushing, bathing, laundering, washing dishes, operating garbage disposals, and general cleaning are all activities that can include the use of chemicals that are present in products like disinfectants and soaps. Some of these products contribute significant quantities of pollutants to wastewater flows. For example, bathing, clothes washing, and dish washing contribute large amounts of sodium to wastewater. Before manufacturers reformulated detergents, these activities accounted for more than 70 percent of the phosphorus in residential flows. Efforts to protect water quality in the Chesapeake Bay, Great Lakes, and major rivers across the nation led to the first statewide bans on phosphorus in detergents in the 1970s, and other states issued phosphorus bans throughout the 1980s. The new low-phosphorus detergents have reduced phosphorus loadings to wastewater by 40 to 50 percent since the 1970s.

The impacts associated with the daily use of household products can be reduced by providing public education regarding the environmental impacts of common household products. Through careful selection of cleaning agents and chemicals, pollution impacts on public health and the environment associated with their use can be reduced.

## Improving user habits

Everyday household activities generate numerous pollutants. Almost every commonly used domestic product—cleaners, cosmetics, deodorizers, disinfectants, pesticides, laundry products, photographic products, paints, preservatives, soaps, and medicines—contains pollutants that can contaminate ground water and surface waters and upset biological treatment processes in OWTs (Terrene Institute, 1995). Some household hazardous waste (HHW) can be eliminated from the wastewater stream by taking hazardous products to HHW recycling/reuse centers, dropping them off at HHW collection sites, or disposing of them in a solid waste form (i.e., pouring liquid products like paint, cleaners, or polishes on newspapers, allowing them to dry in a well-ventilated area, and enclosing them in several plastic bags for landfilling) rather than dumping them down the sink or flushing them down the toilet. Improper disposal of HHW can best be reduced by implementing public education

### Improving onsite system performance by improving user habits

The University of Minnesota Extension Service's *Septic System Owner's Guide* recommends the following practices to improve onsite system performance:

- Do not use “every flush” toilet bowl cleaners.
- Reduce the use of drain cleaners by minimizing the amount of hair, grease, and food particles that go down the drain.
- Reduce the use of cleaners by doing more scrubbing with less cleanser.
- Use the minimum amount of soap, detergent, and bleach necessary to do the job.
- Use minimal amounts of mild cleaners and only as needed.
- Do not drain chlorine-treated water from swimming pools and hot tubs into septic systems.
- Dispose of all solvents, paints, antifreeze, and chemicals through local recycling and hazardous waste collection programs.
- Do not flush unwanted prescription or over-the-counter medications down the toilet.

*Adapted from University of Minnesota, 1998.*

and HHW collection programs. A collection program is usually a 1-day event at a specific site. Permanent programs include retail store drop-off programs, curbside collection, and mobile facilities. Establishing HHW collection programs can significantly reduce the amount of hazardous chemicals in the wastewater stream, thereby reducing impacts on the treatment system and on ground water and surface waters.

Stopping the practice of flushing household wastes (e.g., facial tissue, cigarette butts, vegetable peelings, oil, grease, other cooking wastes) down the toilet can also reduce mass pollutant loads and decrease plumbing and OWTs failure risks. Homeowner education is necessary to bring about these changes in behavior. Specific homeowner information is available from the National Small Flows Clearinghouse at [http://www.estd.wvu.edu/nsfc/NSFC\\_septic\\_news.html](http://www.estd.wvu.edu/nsfc/NSFC_septic_news.html).

**Table 3-15. Reduction in pollutant loading achieved by eliminating garbage disposals**

Parameter	Reduction in pollutant loading (%)
Total suspended solids	25–40
Biochemical oxygen demand	20–28
Total nitrogen	3.6
Total phosphorus	1.7
Fats, oils, and grease	60–70

Source: University of Wisconsin, 1978.

### Eliminating use of garbage disposals

Eliminating the use of garbage disposals can significantly reduce the amount of grease, suspended solids, and BOD in wastewater (table 3-15). Reducing the amount of vegetable and other food-related material entering wastewater from garbage disposals can also result in a slight reduction in nitrogen and phosphorus loads. Eliminating garbage disposal use also reduces the rate of sludge and scum accumulation in the septic tank, thus reducing the frequency of required pumping. OWTs, however, can accommodate garbage disposals by using larger tanks, SWISs, or alternative system designs. (For more information, see Special Issue Fact Sheets 2 and 3 in the Chapter 4 Fact Sheets section.)

### Using graywater separation approaches

Another method for reducing pollutant mass loading to a single SWIS is segregating toilet waste flows (blackwater) from sink, shower, washing machine, and other waste flows (graywater). Some types of toilet systems provide separate handling of human excreta (such as the non-water-carriage units in table 3-14). Significant quantities of suspended solids, BOD, nitrogen, and pathogenic organisms are eliminated from wastewater flows by segregating body wastes from the OWTs wastewater stream through the use of composting or incinerator toilets. This approach is more cost-effective for new homes, homes with adequate crawl spaces, or mobile or modular homes. Retrofitting existing homes, especially those with concrete floors, can be expensive. (For more information on graywater reuse, see Special Issue Fact Sheet 4 in the Chapter 4 Fact Sheets section and <http://www.epa.gov/OW/you/chap3.html>.)

Graywaters contain appreciable quantities of organic matter, suspended solids, phosphorus, grease, and bacteria (USEPA, 1980a). Because of the presence of significant concentrations of bacteria and possibly pathogens in graywaters from bathing, hand washing, and clothes washing, caution should be exercised to ensure that segregated graywater treatment and discharge processes occur below the ground surface to prevent human contact. In addition, siting of graywater infiltration fields should not compromise the hydraulic capacity of treatment soils in the vicinity of the blackwater infiltration field.

### 3.5.3 Wastewater reuse and recycling systems

Many arid and semiarid regions in the United States have been faced with water shortages, creating the need for more efficient water use practices. Depletion of ground water and surface water resources due to increased development, irrigation, and overall water use is also becoming a growing concern in areas where past supplies have been plentiful (e.g., south Florida, central Georgia). Residential development in previously rural areas has placed additional strains on water supplies and wastewater treatment facilities. Decentralized wastewater management programs that include onsite wastewater reuse/recycling systems are a viable option for addressing water supply shortages and wastewater discharge restrictions. In municipalities where water shortages are a recurring problem, such as communities in California and Arizona, centrally treated reclaimed wastewater has been used for decades as an alternative water supply for agricultural irrigation, ground water recharge, and recreational waters.

*Wastewater reuse* is the collection and treatment of wastewater for other uses (e.g., irrigation, ornamental ponds, and cooling systems). *Wastewater recycling* is the collection and treatment of wastewater and its reuse in the same water-use scheme, such as toilet and urinal flushing (Tchobanoglous and Burton, 1991). Wastewater reuse/recycling systems can be used in individual homes, clustered communities, and larger institutional facilities such as office parks and recreational facilities. The Grand Canyon National Park has reused treated wastewater for toilet flushing, landscape irrigation, cooling water, and

boiler feedstock since 1926, and other reuse systems are gaining acceptance (Tchobanoglous and Burton, 1991). Office buildings, schools, and recreational facilities using wastewater reuse/recycling systems have reported a 90 percent reduction in water use and up to a 95 percent reduction in wastewater discharges (Burks and Minnis, 1994).

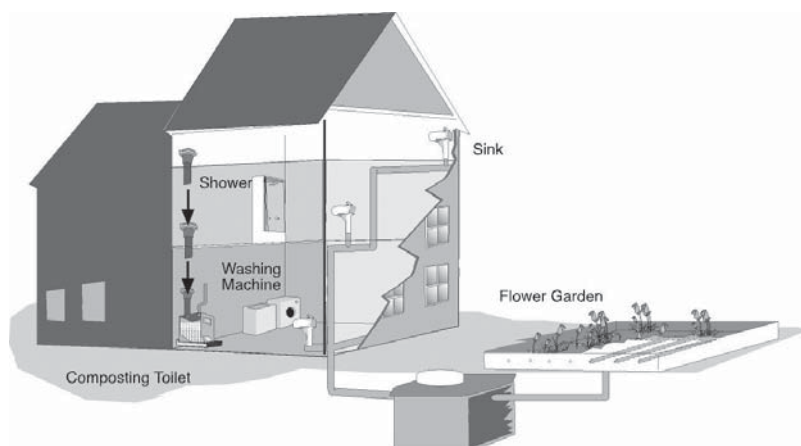
Wastewater reuse/recycling systems reduce potable water use by reusing or recycling water that has already been used at the site for nonpotable purposes, thereby minimizing wastewater discharges. The intended use of wastewater dictates the degree of treatment necessary before reuse. Common concerns associated with wastewater reuse/recycling systems include piping cross-connections, which could contaminate potable water supplies with wastewater, difficulties in modifying and integrating potable and nonpotable plumbing, public and public agency acceptance, and required maintenance of the treatment processes.

A number of different onsite wastewater reuse/recycling systems and applications are available. Some systems, called combined systems, treat and reuse or recycle both blackwater and graywater (NAPHCC, 1992). Other systems treat and reuse or recycle only graywater. Figure 3-6 depicts a typical graywater reuse approach. Separating graywater and blackwater is a common practice to reduce pollutant loadings to wastewater treatment systems (Tchobanoglous and Burton, 1991).

### 3.5.4 Factors of safety in characterization estimates

Conservative predictions or factors of safety are typically used to account for potential variability in wastewater characteristics at a particular dwelling or establishment. These predictions attempt to ensure adequate treatment by the onsite system without requiring actual analysis of the variability in flow or wastewater quality. However, actual measurement of wastewater flow and quality from a residential dwelling or nonresidential establishment always provides the most accurate estimate for sizing and designing an OWTS. Metering daily water use and analyzing a set of grab samples to confirm wastewater strength estimates are often substituted for direct

Figure 3-6. Typical graywater reuse approach



measurement of concentrations because of cost considerations.

Minimum septic tank size requirements or minimum design flows for a residential dwelling may be specified by onsite codes (NSFC, 1995). Such stipulations should incorporate methods for the conservative prediction of wastewater flow. It is important that realistic values and safety factors be used to determine wastewater characteristics in order to design the most cost-effective onsite system that meets performance requirements.

Factors of safety can be applied indirectly by the choice of design criteria for wastewater characteristics and occupancy patterns or directly through an overall factor. Most onsite code requirements for system design of residential dwellings call for estimating the flow on a per person or per bedroom basis. Codes typically specify design flows of 100 to 150 gallons/bedroom/day (378 to 568 liters/bedroom/day), or 75 to 100 gallons/person/day (284 to 378 liters/person/day), with occupancy rates of between 1.5 and 2 persons/bedroom (NSFC, 1995).

For example, if an average daily flow of 75 gallons/person/day (284 liters/person/day) and an occupancy rate of 2 persons per bedroom were the selected design units, the flow prediction for a three-bedroom home would include a factor of safety of approximately 2 when compared to typical conditions (i.e., 70 gallons/person/day and 1 person/bedroom). In lieu of using conservative design flows, a direct factor of safety (e.g., 2) may be applied to estimate the design flow from a



residence or nonresidential establishment. Multiplying the typical flow estimated (140 gallons/day) by a safety factor of 2 yields a design flow of 280 gallons/day (1,058 liters/day). Factors of safety used for individual systems will usually be higher than those used for larger systems of 10 homes or more.

Great care should be exercised in predicting wastewater characteristics so as not to accumulate multiple factors of safety that would yield unreasonably high design flows and result in unduly high capital costs. Conversely, underestimating flows should be avoided because the error will quickly become apparent if the system overloads and requires costly modification.

### **3.6 Integrating wastewater characterization and other design information**

Predicting wastewater characteristics for typical residential and nonresidential establishments can be a difficult task. Following a logical step-by-step procedure can help simplify the characterization process and yield more accurate wastewater characteristic estimates. Figure 3-7 is a flow chart that illustrates a procedure for predicting wastewater characteristics. This strategy takes the reader through the characterization process as it has been described in this chapter. The reader is cautioned that this flowchart is provided to illustrate one simple strategy for predicting wastewater characteristics. Additional factors to consider, such as discrepancies between literature values for wastewater flow and quality and/or the need to perform field studies, should be addressed based on local conditions and regulatory requirements.

In designing wastewater treatment systems, it is recommended that designers consider the most significant or limiting parameters, including those that may be characterized as outliers, when considering hydraulic and mass pollutant treatment requirements and system components. For example, systems that will treat wastewaters with typical mass pollutant loads but hydraulic loads that exceed typical values should be designed to handle the extra hydraulic input. Systems designed for facilities with typical hydraulic loads but atypical mass pollutant loads (e.g., restaurants,

grocery stores, or other facilities with high-strength wastes) should incorporate pretreatment units that address the additional pollutant loadings, such as grease traps.

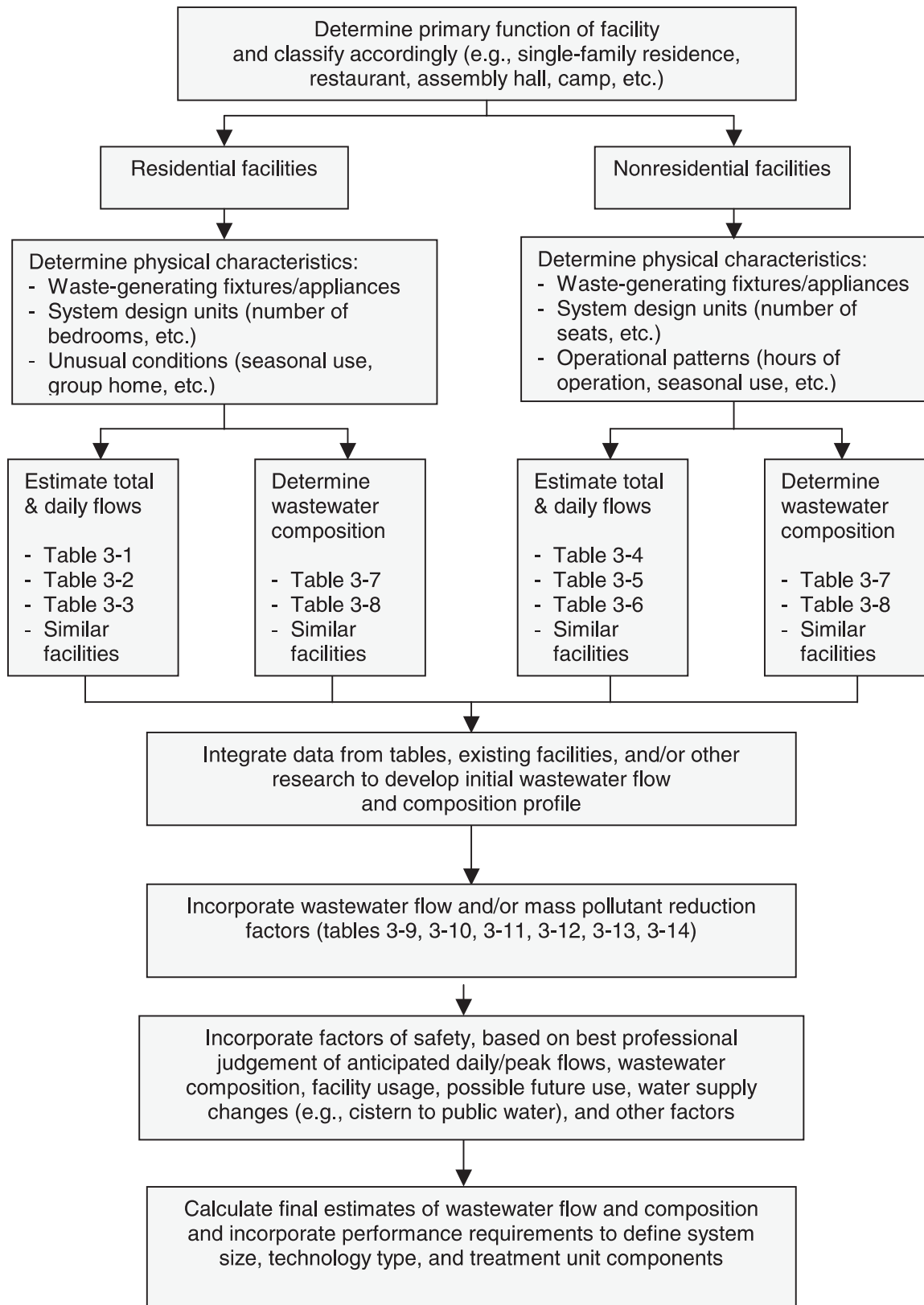
### **3.7 Transport and fate of wastewater pollutants in the receiving environment**

Nitrate, phosphorus, pathogens, and other contaminants are present in significant concentrations in most wastewaters treated by onsite systems. Although most can be removed to acceptable levels under optimal system operational and performance conditions, some may remain in the effluent exiting the system. After treatment and percolation of the wastewater through the infiltrative surface biomat and passage through the first few inches of soil, the wastewater plume begins to migrate downward until nearly saturated conditions exist. The worst case scenario occurs when the plume is mixing with an elevated water table. At that point, the wastewater plume will move in response to the prevailing hydraulic gradient, which might be lateral, vertical, or even a short distance upslope if ground water mounding occurs (figure 3-8). Moisture potential, soil conductivity, and other soil and geological characteristics determine the direction of flow.

Further treatment occurs as the plume passes through the soil. The degree of this additional treatment depends on a host of factors (e.g., residence time, soil mineralogy, particle sizes). Permit writers should consider not only the performance of each individual onsite system but also the density of area systems and overall hydraulic loading, the proximity of water resources, and the collective performance of onsite systems in the watershed. Failure to address these issues can lead ultimately to contamination of lakes, rivers, streams, wetlands, coastal areas, or ground water. This section examines key wastewater pollutants, their impact on human health and water resources, how they move in the environment, and how local ecological conditions affect wastewater treatment.



Figure 3-7. Strategy for estimating wastewater flow and composition



### 3.7.1 Wastewater pollutants of concern

Environmental protection and public health agencies are becoming increasingly concerned about ground water and surface water contamination from wastewater pollutants. Toxic compounds, excessive nutrients, and pathogenic agents are among the potential impacts on the environment from onsite wastewater systems. Domestic wastewater contains several pollutants that could cause significant human health or environmental risks if not treated effectively before being released to the receiving environment.

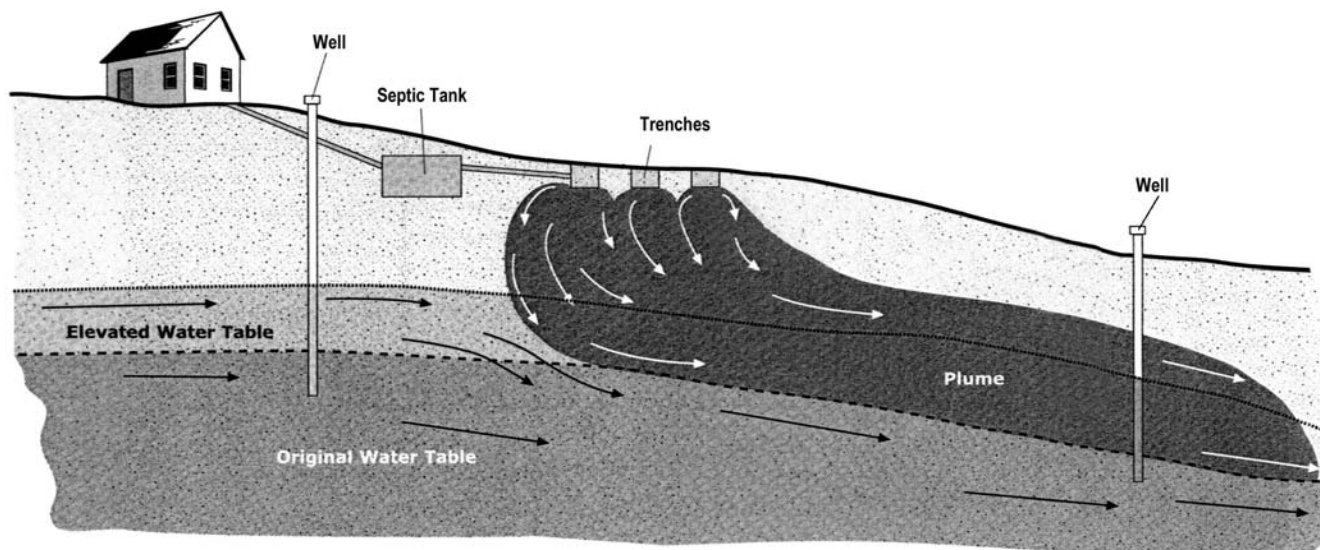
A conventional OWTS (septic tank and SWIS) is capable of nearly complete removal of suspended solids, biodegradable organic compounds, and fecal coliforms if properly designed, sited, installed, operated, and maintained (USEPA, 1980a, 1997). These wastewater constituents can become pollutants in ground water or surface waters if treatment is incomplete. Research and monitoring studies have demonstrated removals of these typically found constituents to acceptable levels. More recently, however, other pollutants present in wastewater are raising concerns, including nutrients (e.g., nitrogen and phosphorus), pathogenic parasites (e.g., *Cryptosporidium parvum*, *Giardia lamblia*), bacteria and viruses, toxic organic

compounds, and metals. Their potential impacts on ground water and surface water resources are summarized in table 3-16. Recently, concerns have been raised over the movement and fate of a variety of endocrine disruptors, usually from use of pharmaceuticals by residents. No data have been developed to confirm a risk at this time.

### 3.7.2 Fate and transport of pollutants in the environment

When properly designed, sited, constructed, and maintained, conventional onsite wastewater treatment technologies effectively reduce or eliminate most human health or environmental threats posed by pollutants in wastewater (table 3-17). Most traditional systems rely primarily on physical, biological, and chemical processes in the septic tank and in the biomat and unsaturated soil zone below the SWIS (commonly referred to as a leach field or drain field) to sequester or attenuate pollutants of concern. Where point discharges to surface waters are permitted, pollutants of concern should be removed or treated to acceptable, permit-specific levels (levels permitted under the National Pollutant Discharge Elimination System of the Clean Water Act) before discharge.

Figure 3-8. Plume movement through the soil to the saturated zone.



Source: Adapted from NSFC, 2000.

Table 3-16. Typical wastewater pollutants of concern

Pollutant	Reason for concern
Total suspended solids (TSS) and turbidity (NTU)	In surface waters, suspended solids can result in the development of sludge deposits that smother benthic macroinvertebrates and fish eggs and can contribute to benthic enrichment, toxicity, and sediment oxygen demand. Excessive turbidity (colloidal solids that interfere with light penetration) can block sunlight, harm aquatic life (e.g., by blocking sunlight needed by plants), and lower the ability of aquatic plants to increase dissolved oxygen in the water column. In drinking water, turbidity is aesthetically displeasing and interferes with disinfection.
Biodegradable organics (BOD)	Biological stabilization of organics in the water column can deplete dissolved oxygen in surface waters, creating anoxic conditions harmful to aquatic life. Oxygen-reducing conditions can also result in taste and odor problems in drinking water.
Pathogens	Parasites, bacteria, and viruses can cause communicable diseases through direct/indirect body contact or ingestion of contaminated water or shellfish. A particular threat occurs when partially treated sewage pools on ground surfaces or migrates to recreational waters. Transport distances of some pathogens (e.g., viruses and bacteria) in ground water or surface waters can be significant.
Nitrogen	Nitrogen is an aquatic plant nutrient that can contribute to eutrophication and dissolved oxygen loss in surface waters, especially in lakes, estuaries, and coastal embayments. Algae and aquatic weeds can contribute trihalomethane (THM) precursors to the water column that may generate carcinogenic THMs in chlorinated drinking water. Excessive nitrate-nitrogen in drinking water can cause methemoglobinemia in infants and pregnancy complications for women. Livestock can also suffer health impacts from drinking water high in nitrogen.
Phosphorus	Phosphorus is an aquatic plant nutrient that can contribute to eutrophication of inland and coastal surface waters and reduction of dissolved oxygen.
Toxic organics	Toxic organic compounds present in household chemicals and cleaning agents can interfere with certain biological processes in alternative OWTs. They can be persistent in ground water and contaminate downgradient sources of drinking water. They can also cause damage to surface water ecosystems and human health through ingestion of contaminated aquatic organisms (e.g., fish, shellfish).
Heavy metals	Heavy metals like lead and mercury in drinking water can cause human health problems. In the aquatic ecosystem, they can also be toxic to aquatic life and accumulate in fish and shellfish that might be consumed by humans.
Dissolved inorganics	Chloride and sulfide can cause taste and odor problems in drinking water. Boron, sodium, chlorides, sulfate, and other solutes may limit treated wastewater reuse options (e.g., irrigation). Sodium and to a lesser extent potassium can be deleterious to soil structure and SWIS performance.

Source: Adapted in part from Tchobanoglous and Burton, 1991.

Table 3-17. Examples of soil infiltration system performance

Parameter	Applied concentration in milligrams per liter	Percent removal	References
BOD <sub>5</sub>	130–150	90–98	Siegrist et al., 1986 U. Wisconsin, 1978
Total nitrogen	45–55	10–40	Reneau 1977 Sikora et al., 1976
Total phosphorus	8–12	85–95	Sikora et al., 1976
Fecal coliforms	NA <sup>a</sup>	99–99.99	Gerba, 1975

<sup>a</sup> Fecal coliforms are typically measured in other units, e.g., colony-forming units per 100 milliliters.

Source: Adapted from USEPA, 1992.

Onsite systems can fail to meet human health and water quality objectives when fate and transport of potential pollutants are not properly addressed. Failing or failed systems threaten human health if pollutants migrate into ground waters used as drinking water and nearby surface waters used for recreation. Such failures can be due to improper siting, inappropriate choice of technology, faulty design, poor installation practices, poor operation, or inadequate maintenance. For example, in high-density subdivisions conventional septic tank/SWIS systems might be an inappropriate choice of technology because leaching of nitrate-nitrogen could result in nitrate concentrations in local aquifers that exceed the drinking water standard. In soils with excessive permeability or shallow water tables, inadequate treatment in the unsaturated soil zone might allow pathogenic bacteria and viruses to enter the ground water if no mitigating measures are taken. Poorly drained soils can restrict reoxygenation of the subsoil and result in clogging of the infiltrative surface.

A number of factors influence the shape and movement of contaminant plumes from OWTSS. Climate, soils, slopes, landscape position, geology, regional hydrology, and hydraulic load determine whether the plume will disperse broadly and deeply or, more commonly, migrate in a long and relatively narrow plume along the upper surface of a confining layer or on the surface of the ground water. Analyses of these factors are key elements in understanding the contamination potential of individual or clustered OWTSS in a watershed or ground water recharge area.

### **Receiving environments and contaminant plume transport**

Most onsite systems ultimately discharge treated water to ground water. Water beneath the land surface occurs in two primary zones, the aerated or vadose zone and the saturated (groundwater) zone. Interstices in the aerated (upper) vadose zone are unsaturated, filled partially with water and partially with air. Water in this unsaturated zone is referred to as vadose water. In the saturated zone, all interstices are filled with water under hydrostatic pressure. Water in this zone is commonly referred to as ground water. Where no overlying impermeable barrier exists, the upper surface of the ground water is called the water table. Saturation extends slightly above the water table due to capillary attraction but

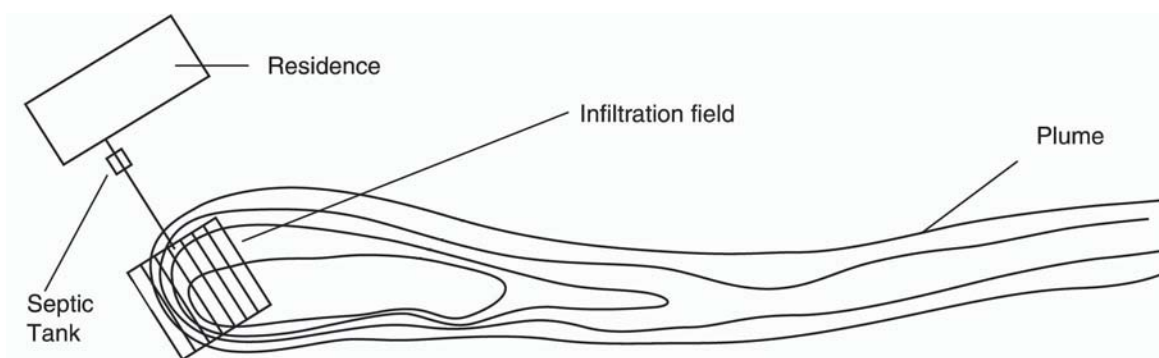
water in this “capillary fringe” zone is held at less than atmospheric pressure.

Onsite wastewater treatment system performance should be measured by the ability of the system to discharge a treated effluent capable of meeting public health and water quality objectives established for the receiving water resource. Discharges from existing onsite systems are predominantly to ground water but they might involve direct (point source) or indirect (nonpoint source) surface water discharges in some cases. Ground water discharges usually occur through soil infiltration. Point source discharges are often discouraged by regulatory agencies because of the difficulty in regulating many small direct, permitted discharges and the potential for direct or indirect human contact with wastewater. Nonpoint source surface water discharges usually occur as base flow from ground water into watershed surface waters. In some cases regional ground water quality and drinking water wells might be at a lesser risk from OWTSS discharges than nearby surface waters because of the depth of some aquifers and regional geology.

The movement of subsurface aqueous contaminant plumes is highly dependent on soil type, soil layering, underlying geology, topography, and rainfall. Some onsite system setback/separation codes are based on plume movement models or measured relationships that have not been supported by recent field data. In regions with moderate to heavy rainfall, effluent plumes descend relatively intact as the water table is recharged from above. The shape of the plume depends on the soil and geological factors noted above, the uniformity of effluent distribution in the SWIS, the orientation of the SWIS with respect to ground water flow and direction, and the preferential flow that occurs in the vadose and saturated zones (Otis, 2000).

In general, however, plumes tend to be long, narrow, and definable, exhibiting little dispersion (figure 3-9). Some studies have found SWIS plumes with nitrate levels exceeding drinking water standards (10 mg/L) extending more than 328 feet (100 meters) beyond the SWIS (Robertson, 1995). Mean effluent plume dispersion values used in a Florida study to assess subdivision SWIS nitrate loadings over 5 years were 60 feet, 15 feet, and 1.2 feet for longitudinal, lateral, and vertical disper-





**Figure 3-9. An example of effluent plume movement** (Robertson, 1991). A study that examined SWIS plume movement in a shallow, unconfined sand aquifer found that after 12 years the plume had sharp lateral and vertical boundaries, a length of 426 feet (130 meters), and a uniform width of about 32.8 feet (10 meters) (Robertson, 1991). At another site examined in that study, a SWIS constructed in a similar carbonate-depleted sand aquifer generated a plume with discrete boundaries that began discharging into a river 65.6 feet (20 meters) away after 1.5 years of system operation.

Given the tendency of OWTS effluent plumes to remain relatively intact over long distances (more than 100 meters), dilution models commonly used in the past to calculate nitrate attenuation in the vadose zone are probably unrealistic (Robertson, 1995). State codes that specify 100-foot separation distances between conventional SWIS treatment units and downgradient wells or surface waters should not be expected to always protect these resources from dissolved, highly mobile contaminants such as nitrate (Robertson, 1991). Moreover, published data indicate that viruses that reach groundwater can travel at least 220 feet (67 meters) vertically and 1,338 feet (408 meters) laterally in some porous soils and still remain infective (Gerba, 1995). One study noted that fecal coliform bacteria moved 2 feet (0.6 meter) downward and 50 feet (15 meters) longitudinally 1 hour after being injected into a shallow trench in saturated soil on a 14 percent slope in western Oregon (Cogger, 1995). Contaminant plume movement on the surface of the saturated zone can be rapid, especially under sloping conditions, but it typically slows upon penetration into ground water in the

saturated zone. Travel times and distances under unsaturated conditions in more level terrain are likely much less.

### Ground water discharge

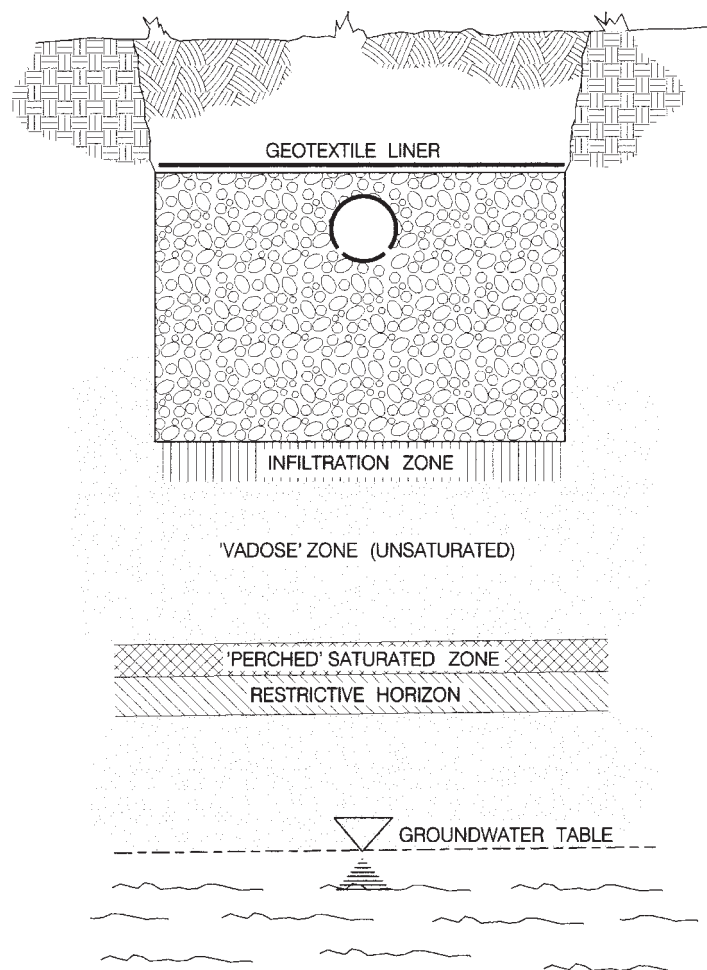
A conventional OWTS (septic tank and SWIS) discharges to ground water and usually relies on the unsaturated or vadose zone for final polishing of the wastewater before it enters the saturated zone. The septic tank provides primary treatment of the wastewater, removing most of the settleable solids, greases, oils, and other floatable matter and anaerobic liquifaction of the retained organic solids. The biomat that forms at the infiltrative surface and within the first few centimeters of unsaturated soil below the infiltrative field provides physical, chemical, and biological treatment of the SWIS effluent as it migrates toward the ground water.

Because of the excellent treatment the SWIS provides, it is a critical component of onsite systems that discharge to ground water. Fluid transport from the infiltrative surface typically occurs through three zones, as shown in figure 3-10 (Ayres Associates, 1993a). In addition to the three zones, the figure shows a saturated zone perched above a restrictive horizon, a site feature that often occurs.

Pretreated wastewater enters the SWIS at the surface of the infiltration zone. A biomat forms in this zone, which is usually only a few centimeters thick. Most of the physical, chemical, and biological treatment of the pretreated effluent occurs in this zone and in the vadose zone. Particulate matter in the effluent accumulates on the infiltration surface and within the pores of the soil matrix, providing a



Figure 3-10. Soil treatment zones



Source: Ayres Associates, 1993a.

source of carbon and nutrients to the active biomass. New biomass and its metabolic by-products accumulate in this zone. The accumulated biomass, particulate matter, and metabolic by-products reduce the porosity and the infiltration rate through them. Thus, the infiltration zone is a transitional zone where fluid flow changes from saturated to unsaturated flow. The biomat controls the rate at which the pretreated wastewater moves through the infiltration zone in coarse- to medium-textured soils, but it is less likely to control the flow through fine-textured silt and clay soils because they may be more restrictive to flow than the biomat.

Below the zone of infiltration lies the unsaturated or vadose zone. Here the effluent is under a negative pressure potential (less than atmospheric) resulting from the capillary and adsorptive forces of the soil matrix. Consequently, fluid flow occurs over the surfaces of soil particles and through finer pores of

the soil while larger pores usually remain air-filled. This is the most critical fluid transport zone because the unsaturated soil allows air to diffuse into the open soil pores to supply oxygen to the microbes that grow on the surface of the soil particles. The negative soil moisture potential forces the wastewater into the finer pores and over the surfaces of the soil particles, increasing retention time, absorption, filtration, and biological treatment of the wastewater.

From the vadose zone, fluid passes through the capillary fringe immediately above the ground water and enters the saturated zone, where flow occurs in response to a positive pressure gradient. Treated wastewater is transported from the site by fluid movement in the saturated zone. Mixing of treated water with ground water is somewhat limited because ground water flow usually is laminar. As a result, treated laminar water can remain as a distinct plume at the ground water interface for some distance from its source (Robertson et al., 1989). The plume might descend into the ground water as it travels from the source because of recharge from precipitation above. Dispersion occurs, but the mobility of solutes in the plume varies with the soil-solute reactivity.

Water quality-based performance requirements for ground water discharging systems are not clearly defined by current codes regulating OWTSS. Primary drinking water standards are typically required at a point of use (e.g., drinking water well) but are addressed in the codes only by requirements that the infiltration system be located a specified horizontal distance from the wellhead and vertical distance from the seasonal high water table. Nitrate-nitrogen is the common drinking water pollutant of concern that is routinely found in ground water below conventional SWISs. Regions with karst terrain or sandy soils are at particular risk for rapid movement of bacteria, viruses, nitrate-nitrogen, and other pollutants to ground water. In addition, geological conditions that support "gaining streams" (streams fed by ground water during low-flow conditions) might result in OWTSS nutrient or pathogen impacts on surface waters if siting or design criteria fail to consider these conditions.

### Surface water discharge

Direct discharges to surface waters require a permit issued under the National Pollutant Discharge Elimination System (NPDES) of the Clean Water

Act. The NPDES permitting process, which is administered by all but a few states, defines discharge performance requirements in the form of numerical criteria for specific pollutants and narrative criteria for parameters like color and odor. The treated effluent should meet water quality criteria before it is discharged. Criteria-based standards may include limits for BOD<sub>5</sub>, TSS, fecal coliforms, ammonia, nutrients, metals, and other pollutants, including chlorine, which is often used to disinfect treated effluent prior to discharge. The limits specified vary based on the designated use of the water resource (e.g., swimming, aquatic habitat, recreation, potable water supply), state water classification schemes (Class I, II, III, etc.), water quality criteria associated with designated uses, or the sensitivity of aquatic ecosystems—especially lakes and coastal areas—to eutrophication. Surface water discharges are often discouraged for individual onsite treatment systems, however, because of the difficulty in achieving regulatory oversight and surveillance of many small, privately operated discharges.

### Atmospheric discharge

Discharges to the atmosphere also may occur through evaporation and transpiration by plants. Evapotranspiration can release significant volumes of water into the atmosphere, but except for areas where annual evaporation exceeds precipitation (e.g., the American Southwest), evapotranspiration cannot be solely relied on for year-round discharge. However, evapotranspiration during the growing season can significantly reduce the hydraulic loading to soil infiltration systems.

### Contaminant attenuation

Performance standards for ground water discharge systems are usually applied to the treated effluent/ground water mixture at some specified point away from the treatment system (see chapter 5). This approach is significantly different from the effluent limitation approach used with surface water discharges because of the inclusion of the soil column as part of the treatment system. However, monitoring ground water quality as a performance measure is not as easily accomplished. The fate and transport of wastewater pollutants through soil should be accounted for in the design of the overall treatment system.

Contaminant attenuation (removal or inactivation through treatment processes) begins in the septic tank and continues through the distribution piping of the SWIS or other treatment unit components, the infiltrative surface biomat, the soils of the vadose zone, and the saturated zone. Raw wastewater composition was discussed in section 3.4 and summarized in table 3-7. Jantrania (1994) found that chemical, physical, and biological processes in the anaerobic environment of the septic tank produce effluents with TSS concentrations of 40 to 350 mg/L, oil and grease levels of 50 to 150 mg/L, and total coliform counts of 10<sup>6</sup> to 10<sup>8</sup> per 100 milliliters. Although biofilms develop on exposed surfaces as the effluent passes through piping to and within the SWIS, no significant level of treatment is provided by these growths. The next treatment site is the infiltrative zone, which contains the biomat. Filtration, microstraining, and aerobic biological decomposition processes in the biomat and infiltration zone remove more than 90 percent of the BOD and suspended solids and 99 percent of the bacteria (University of Wisconsin, 1978).

As the treated effluent passes through the biomat and into the vadose and saturated zones, other treatment processes (e.g., filtration, adsorption, precipitation, chemical reactions) occur. The following section discusses broadly the transport and fate of some of the primary pollutants of concern under the range of conditions found in North America. Table 3-18 summarizes a case study that characterized the septic tank effluent and soil water quality in the first 4 feet of a soil treatment system consisting of fine sand. Results for other soil types might be significantly different. Note that mean nitrate concentrations still exceed the 10 mg/L drinking water standard even after the wastewater has percolated through 4 feet of fine sand under unsaturated conditions.

### Biochemical oxygen demand and total suspended solids

Biodegradable organic material creates biochemical oxygen demand (BOD), which can cause low dissolved oxygen concentrations in surface water, create taste and odor problems in well water, and cause leaching of metals from soil and rock into ground water and surface waters. Total suspended solids (TSS) in system effluent can clog the infiltrative surface or soil interstices, while colloidal solids

Table 3-18. Case study: septic tank effluent and soil water quality <sup>a</sup>

Parameter (units)	Statistics	Septic tank effluent quality	Soil water quality <sup>b</sup> at 0.6 meter	Soil water Quality <sup>b</sup> at 1.2 meters
BOD (mg/L)	Mean	93.5	<1	<1
	Range	46–156	<1	<1
	# samples	11	6	6
TOC (mg/L)	Mean	47.4	7.8	8.0
	Range	31–68	3.7–17.0	3.1–25.0
	# samples	11	34	33
TKN (mg/L)	Mean	44.2	0.77	0.77
	Range	19–53	0.40–1.40	0.25–2.10
	# samples	11	35	33
NO <sub>3</sub> -N (mg/L)	Mean	0.04	21.6	13.0
	Range	0.01–0.16	1.7–39.0	2.0–29.0
	# samples	11	35	32
TP (mg/L)	Mean	8.6	0.40	0.18
	Range	7.2–17.0	0.01–3.8	0.02–1.80
	# samples	11	35	33
TDS (mg/L)	Mean	497	448	355
	Range	354–610	184–620	200–592
	# samples	11	34	32
Cl (mg/L)	Mean	70	41	29
	Range	37–110	9–65	9–49
	# samples	11	34	31
F. Coli (log # per 100 mL)	Mean	4.57	nd <sup>c</sup>	nd
	Range	3.6–5.4	<1	<1
	# samples	11	24	21
F. strep. (log # per 100 mL)	Mean	3.60	nd	nd
	Range	1.9–5.3	<1	<1
	# samples	11	23	20

<sup>a</sup> The soil matrix consisted of a fine sand; the wastewater loading rate was 3.1 cm per day over 9 months. TOC = total organic carbon; TKN = total Kjeldahl nitrogen; TDS = total dissolved solids; Cl = chlorides;

F. coli = fecal coliforms; F. strep = fecal streptococci.

<sup>b</sup> Soil water quality measured in pan lysimeters at unsaturated soil depths of 2 feet (0.6 meter) and 4 feet (1.2 meters).

<sup>c</sup> nd = none detected.

Source: Adapted from Anderson et al., 1994.

cause cloudiness in surface waters. TSS in direct discharges to surface waters can result in the development of sludge layers that can harm aquatic organisms (e.g., benthic macro invertebrates). Systems that fail to remove BOD and TSS and are located near surface waters or drinking water wells may present additional problems in the form of pathogens, toxic pollutants, and other pollutants.

Under proper site and operating conditions, however, OWTs can achieve significant removal rates (i.e., greater than 95 percent) for biodegradable organic compounds and suspended solids. The risk of ground water contamination by BOD and TSS

(and other pollutants associated with suspended solids) below a properly sited, designed, constructed, and maintained SWIS is slight (Anderson et al., 1994; University of Wisconsin, 1978). Most settleable and floatable solids are removed in the septic tank during pretreatment. Most particulate BOD remaining is effectively removed at the infiltrative surface and biomat. Colloidal and dissolved BOD that might pass through the biomat are removed through aerobic biological processes in the vadose zone, especially when uniform dosing and reoxygenation occur. If excessive concentrations of BOD and TSS migrate beyond the tank because of poor maintenance, the infiltrative

surface can clog and surface seepage of wastewater or plumbing fixture backup can occur.

### Nitrogen

Nitrogen in raw wastewater is primarily in the form of organic matter and ammonia. After the septic tank, it is primarily (more than 85 percent) ammonia. After discharge of the effluent to the infiltrative surface, aerobic bacteria in the biomat and upper vadose zone convert the ammonia in the effluent almost entirely to nitrite and then to nitrate. Nitrogen in its nitrate form is a significant ground water pollutant. It has been detected in urban and rural ground water nationwide, sometimes at levels exceeding the USEPA drinking water standard of 10 mg/L (USGS, 1999). High concentrations of nitrate (greater than 10 mg/L) can cause methemoglobin-

emia or “blue baby syndrome,” a disease in infants that reduces the blood’s ability to carry oxygen, and problems during pregnancy. Nitrogen is also an important plant nutrient that can cause excessive algal growth in nitrogen-limited inland (fresh) waters and coastal waters, which are often limited in available nitrogen. High algal productivity can block sunlight, create nuisance or harmful algal blooms, and significantly alter aquatic ecosystems. As algae die, they are decomposed by bacteria, which can deplete available dissolved oxygen in surface waters and degrade habitat conditions.

Nitrogen contamination of ground water below infiltration fields has been documented by many investigators (Anderson et al., 1994; Andreoli et al., 1979; Ayres Associates, 1989, 1993b, c; Bouma et al., 1972; Carlile et al., 1981; Cogger and

**Table 3-19. Wastewater constituents of concern and representative concentrations in the effluent of various treatment units**

Constituents of concern	Example direct or indirect measures (Units)	Tank-based treatment unit effluent concentrations					SWIS percolate into ground water at 3 to 5 ft depth (% removal)
		Domestic STE <sup>1</sup>	Domestic STE with N-removal recycle <sup>2</sup>	Aerobic unit effluent	Sand filter effluent	Foam or textile filter effluent	
Oxygen demand	BOD <sub>5</sub> (mg/L)	140-200	80-120	5-50	2-15	5-15	>90%
Particulate solids	TSS (mg/L)	50-100	50-80	5-100	5-20	5-10	>90%
Nitrogen	Total N (mg N/L)	40-100	10-30	25-60	10-50	30-60	10-20%
Phosphorus	Total P (mg P/L)	5-15	5-15	4-10	<1-10 <sup>4</sup>	5-15 <sup>4</sup>	0-100%
Bacteria (e.g., <i>Clostridium perfringens</i> , <i>Salmonella</i> , <i>Shigella</i> )	Fecal coliform (organisms per 100 mL)	10 <sup>6</sup> -10 <sup>8</sup>	10 <sup>6</sup> -10 <sup>8</sup>	10 <sup>3</sup> -10 <sup>4</sup>	10 <sup>1</sup> -10 <sup>3</sup>	10 <sup>1</sup> -10 <sup>3</sup>	>99.99%
Virus (e.g., hepatitis, polio, echo, coxsackie, coliphage)	Specific virus (pfu/mL)	0-10 <sup>5</sup> (episodically present at high levels)	0-10 <sup>5</sup> (episodically present at high levels)	0-10 <sup>5</sup> (episodically present at high levels)	0-10 <sup>5</sup> (episodically present at high levels)	0-10 <sup>5</sup> (episodically present at high levels)	>99.9%
Organic chemicals (e.g., solvents, petrochemicals, pesticides)	Specific organics or totals (µg/L)	0 to trace levels (?)	0 to trace levels (?)	0 to trace levels (?)	0 to trace levels (?)	0 to trace levels (?)	>99%
Heavy metals (e.g., Pb, Cu, Ag, Hg)	Individual metals (µg/L)	0 to trace levels	0 to trace levels	0 to trace levels	0 to trace levels	0 to trace levels	>99%

<sup>1</sup> Septic tank effluent (STE) concentrations given are for domestic wastewater. However, restaurant STE is markedly higher particularly in BOD<sub>5</sub>, COD, and suspended solids while concentrations in graywater STE are noticeably lower in total nitrogen.

<sup>2</sup> N-removal accomplished by recycling STE through a packed bed for nitrification with discharge into the influent end of the septic tank for denitrification.

<sup>3</sup> P-removal by adsorption/precipitation is highly dependent on media capacity, P loading, and system operation.

Source: Siegrist, 2001 (after Siegrist et al., 2000)

Source: Siegrist, 2001 (after Siegrist et al., 2000).



Carlile, 1984; Ellis and Childs, 1973; Erickson and Bastian, 1980; Gibbs, 1977a, b; Peavy and Brawner, 1979; Peavy and Groves, 1978; Polta, 1969; Preul, 1966; Reneau, 1977, 1979; Robertson et al., 1989, 1990; Shaw and Turyk, 1994; Starr and Sawhney, 1980; Tinker, 1991; Uebler, 1984; Viraraghavan and Warnock, 1976a, b, c; Walker et al., 1973a, b; Wolterink et al., 1979). Nitrate-nitrogen concentrations in ground water were usually found to exceed the drinking water standard of 10 mg/L near the infiltration field. Conventional soil-based systems can remove some nitrogen from septic tank effluent (table 3-19), but high-density installation of OWTSS can cause contamination of ground or surface water resources. When nitrate reaches the ground water, it moves freely with little retardation. Denitrification has been found to be significant in the saturated zone only in rare instances where carbon or sulfur deposits are present. Reduction of nitrate concentrations in ground water occurs primarily through dispersion or recharge of ground water supplies by precipitation (Shaw and Turyk, 1994).

Nitrogen can undergo several transformations in and below a SWIS, including adsorption, volatilization, mineralization, nitrification, and denitrification. Nitrification, the conversion of ammonium nitrogen to nitrite and then nitrate by bacteria under aerobic conditions, is the predominant transformation that occurs immediately below the infiltration zone. The negatively charged nitrate ion is very soluble and moves readily with the percolating soil water.

Biological denitrification, which converts nitrate to gaseous forms of nitrogen, can remove nitrate from percolating wastewater. Denitrification occurs under anaerobic conditions where available electron donors such as carbon or sulfur are present. Denitrifying bacteria use nitrate as a substitute for oxygen when accepting electrons. It has been generally thought that anaerobic conditions with organic matter seldom occur below soil infiltration fields. Therefore, it has been assumed that all the nitrogen applied to infiltration fields ultimately leaches to ground water (Brown et al., 1978; Walker et al., 1973a, b). However, several studies indicate that denitrification can be significant. Jenssen and Siegrist (1990) found in their review of several laboratory and field studies that approximately 20 percent of nitrogen is lost from wastewater percolating through soil. Factors found to

favor denitrification are fine-grained soils (silts and clays) and layered soils (alternating fine-grained and coarser-grained soils with distinct boundaries between the texturally different layers), particularly if the fine-grained soil layers contain organic material. Jenssen and Siegrist concluded that nitrogen removal below the infiltration field can be enhanced by placing the system high in the soil profile, where organic matter in the soil is more likely to be present, and by dosing septic tank effluent onto the infiltrative surface to create alternating wetting and drying cycles. Denitrification can also occur if ground water enters surface water bodies through organic-rich bottom sediments. Nitrogen concentrations in ground water were shown to decrease to less than 0.5 mg/L after passage through sediments in one Canadian study (Robertson et al., 1989, 1990).

It is difficult to predict removal rates for wastewater-borne nitrate or other nitrogen compounds in the soil matrix. In general, however, nitrate concentrations in SWIS effluent can and often do exceed the 10 mg/L drinking water standard. Shaw and Turyk (1994) found nitrate concentrations ranging from 21 to 108 mg/L (average of 31 to 34 mg/L) in SWIS effluent plumes analyzed as part of a study of 14 pressure-dosed drain fields in sandy soils of Wisconsin. The limited ability of conventional SWISs to achieve enhanced nitrate reductions and the difficulty in predicting soil nitrogen removal rates means that systems sited in drinking water aquifers or near sensitive aquatic areas should incorporate additional nitrogen removal technologies prior to final soil discharge.

### **Phosphorus**

Phosphorus is also a key plant nutrient, and like nitrogen it contributes to eutrophication and dissolved oxygen depletion in surface waters, especially fresh waters such as rivers, lakes, and ponds. Monitoring below subsurface infiltration systems has shown that the amount of phosphorus leached to ground water depends on several factors: the characteristics of the soil, the thickness of the unsaturated zone through which the wastewater percolates, the applied loading rate, and the age of the system (Bouma et al., 1972; Brandes, 1972; Carlile et al., 1981, Childs et al., 1974; Cogger and Carlile, 1984; Dudley and Stephenson, 1973; Ellis and Childs, 1973; Erickson and Bastian, 1980; Gilliom and Patmont, 1983; Harkin et al., 1979;



Jones and Lee, 1979; Whelan and Barrow, 1984). The amount of phosphorus in ground water varies from background concentrations to concentrations equal to that of septic tank effluent. However, removals have been found to continue within ground water aquifers (Carlile et al., 1981; Childs et al., 1974; Cogger and Carlile, 1984; Ellis and Childs, 1973; Gilliom and Patmont, 1983; Rea and Upchurch, 1980; Reneau, 1979; Reneau and Pettry, 1976; Robertson et al., 1990).

Retardation of phosphorus contamination of surface waters from SWISs is enhanced in fine-textured soils without continuous macropores that would allow rapid percolation. Increased distance of the system from surface waters is also an important factor in limiting phosphorus discharges because of greater and more prolonged contact with soil surfaces. The risk of phosphorus contamination, therefore, is greatest in karst regions and coarse-textured soils without significant iron, calcium, or aluminum concentrations located near surface waters.

The fate and transport of phosphorus in soils are controlled by sorption and precipitation reactions (Sikora and Corey, 1976). At low concentrations (less than 5 mg/L), the phosphate ion is chemisorbed onto the surfaces of iron and aluminum minerals in strongly acid to neutral systems and on calcium minerals in neutral to alkaline systems. As phosphorus concentrations increase, phosphate precipitates form. Some of the more important precipitate compounds formed are strengite,  $\text{FePO}_4 \cdot 2\text{H}_2\text{O}$ ; variscite,  $\text{AlPO}_4 \cdot 2\text{H}_2\text{O}$ ; dicalcium phosphate,  $\text{CaHPO}_4 \cdot 2\text{H}_2\text{O}$ ; octacalcium phosphate,  $\text{Ca}_8\text{H}(\text{PO}_4)_3 \cdot 3\text{H}_2\text{O}$ ; and hydroxyapatite,  $\text{Ca}_{10}(\text{PO}_4)_6(\text{OH})_2$ . In acidic soils, phosphate sorption probably involves the aluminum and iron compounds; in calcareous or alkaline soils, calcium compounds predominate.

Estimates of the capacity of the soil to retain phosphorus are often based on sorption isotherms such as the Langmuir model (Ellis and Erickson, 1969; Sawney, 1977; Sawney and Hill, 1975; Sikora and Corey, 1976; Tofflemire and Chen, 1977). This method significantly underestimates the total retention capacity of the soil (Anderson et al., 1994; Sawney and Hill, 1975; Sikora and Corey, 1976; Tofflemire and Chen, 1977). This is because the test measures the chemisorption capacity but does not take into account the slower precipitation reactions that regenerate the chemi-

sorption sites. These slower reactions have been shown to increase the capacity of the soil to retain phosphorus by 1.5 to 3 times the measured capacity calculated by the isotherm test (Sikora and Corey, 1976; Tofflemire and Chen, 1977). In some cases the total capacity has been shown to be as much as six times greater (Tofflemire and Chen, 1977). These reactions can take place in unsaturated or saturated soils (Ellis and Childs, 1973; Jones and Lee, 1977a, b; Reneau and Pettry, 1976; Robertson et al., 1990; Sikora and Corey, 1976).

The capacity of the soil to retain phosphorus is finite, however. With continued loading, phosphorus movement deeper into the soil profile can be expected. The ultimate retention capacity of the soil depends on several factors, including its mineralogy, particle size distribution, oxidation-reduction potential, and pH. Fine-textured soils theoretically provide more sorption sites for phosphorus. As noted above, iron, aluminum, and calcium minerals in the soil allow phosphorus precipitation reactions to occur, a process that can lead to additional phosphorus retention. Sikora and Corey (1976) estimated that phosphorus penetration into the soil below a SWIS would be 52 centimeters per year in Wisconsin sands and 10 centimeters per year in Wisconsin silt loams.

Nevertheless, knowing the retention capacity of the soil is not enough to predict the travel of phosphorus from subsurface infiltration systems. Equally important is an estimate of the total volume of soil that the wastewater will contact as it percolates to and through the ground water. Fine-textured, unstructured soils (e.g., clays, silty clays) can be expected to disperse the water and cause contact with a greater volume of soil than coarse, granular soils (e.g., sands) or highly structured fine-textured soils (e.g., clayey silts) having large continuous pores. Also, the rate of water movement and the degree to which the water's elevation fluctuates are important factors.

There are no simple methods for predicting phosphorus removal rates at the site level. However, several landscape-scale tools that provide at least some estimation of expected phosphorus loads from clusters of onsite systems are available. The MANAGE assessment method, which is profiled in section 3.9.1, is designed to estimate existing and projected future (build-out) nutrient loads and to identify "hot spots" based on land use and cover

(see <http://www.epa.gov/owow/watershed/Proceed/joubert.html>; <http://www.edc.uri.edu/cewq/manage.html>). Such estimates provide at least some guidance in siting onsite systems and considering acceptable levels of both numbers and densities in sensitive areas.

### Pathogenic microorganisms

Pathogenic microorganisms found in domestic wastewater include a number of different bacteria, viruses, protozoa, and parasites that cause a wide range of gastrointestinal, neurological, respiratory, renal, and other diseases. Infection can occur through ingestion (drinking contaminated water; incidental ingestion while bathing, skiing, or fishing), respiration, or contact (table 3-20). The

occurrence and concentration of pathogenic microorganisms in raw wastewater depend on the sources contributing to the wastewater, the existence of infected persons in the population, and environmental factors that influence pathogen survival rates. Such environmental factors include the following: initial numbers and types of organisms, temperature (microorganisms survive longer at lower temperatures), humidity (survival is longest at high humidity), amount of sunlight (solar radiation is detrimental to survival), and additional soil attenuation factors, as discussed below. Typical ranges of survival times are presented in table 3-21. Among pathogenic agents, only bacteria have any potential to reproduce and multiply between hosts (Cliver, 2000). If temperatures are between 50 and 80 degrees Fahrenheit (10 to 25 degrees Celsius)

**Table 3-20. Waterborne pathogens found in human waste and associated diseases**

Type	Organism	Disease	Effects
Bacteria	<i>Escherichia coli</i> enteropathogenic)	Gastroenteritis	Vomiting, diarrhea, death in susceptible populations
	<i>Legionella pneumophila</i>	Legionellosis	Acute respiratory illness
	<i>Leptospira</i>	Leptospirosis	Jaundice, fever (Well's disease)
	<i>Salmonella typhi</i>	Typhoid fever	High fever, diarrhea, ulceration of the small intestine
	<i>Salmonella</i>	Salmonellosis	Diarrhea, dehydration
	<i>Shigella</i>	Shigellosis	Bacillary dysentery
	<i>Vibrio cholerae</i>	Cholera	Extremely heavy diarrhea, dehydration
	<i>Yersinia enterocolitica</i>	Yersinosis	Diarrhea
Protozoans	<i>Balantidium coli</i>	Balantidiasis	Diarrhea, dysentery
	<i>Cryptosporidium</i>	Cryptosporidiosis	Diarrhea
	<i>Entamoeba histolytica</i>	Ameobiasis (amoebic dysentery)	Prolonged diarrhea with bleeding, abscesses of the liver and small intestine
	<i>Giardia lamblia</i>	Giardiasis	Mild to severe diarrhea, nausea, indigestion
	<i>Naegleria fowleri</i>	Amebic Meningoencephalitis	Fatal disease; inflammation of the brain
Viruses	Adenovirus (31 types)	Conjunctivitis	Eye, other infections
	Enterovirus (67 types, e.g., polio-, echo-, and Coxsackie viruses)	Gastroenteritis	Heart anomalies, meningitis
	Hepatitis A	Infectious hepatitis	Jaundice, fever
	Norwalk agent	Gastroenteritis	Vomiting, diarrhea
	Reovirus	Gastroenteritis	Vomiting, diarrhea
	Rotavirus	Gastroenteritis	Vomiting, diarrhea

Source: USEPA, 1999.

Table 3-21. Typical pathogen survival times at 20 to 30 °C

Pathogen	Typical survival times in days	
	In fresh water & sewage	In unsaturated soils
Viruses <sup>a</sup>		
Enteroviruses <sup>b</sup>	< 120 but usually < 50	< 100 but usually < 20
Bacteria		
Fecal coliforms <sup>a</sup>	< 60 but usually < 30	< 70 but usually < 20
<i>Salmonella</i> spp. <sup>a</sup>	< 60 but usually < 30	< 70 but usually < 20
<i>Shigella</i> spp. <sup>a</sup>	< 30 but usually < 10	
Protozoa		
<i>Entamoeba histolytica</i> cysts	< 30 but usually < 15	< 20 but usually < 10
Helminths		
<i>Ascaris lumbricoides</i> eggs	Many months	Many months

<sup>a</sup> In seawater, viral survival is less and bacterial survival is very much less than in fresh water.

<sup>b</sup> Includes polio-, echo-, and Coxsackie viruses.

Source: Adapted from Feacham et al., 1983, cited in UNDP-World Bank, 1992.

and nutrients are available, bacterial numbers may increase 10- to 100-fold. However, such multiplication is usually limited by competition from other, better-adapted organisms (Cliver, 2000).

Enteric bacteria are those associated with human and animal wastes. Once the bacteria enter a soil, they are subjected to life process stresses not encountered in the host. In most nontropical regions of the United States, temperatures are typically much lower; the quantity and availability of nutrients and energy sources are likely to be appreciably lower; and pH, moisture, and oxygen conditions are not as likely to be conducive to long-term survival. Survival times of enteric bacteria in the soil are generally reduced by higher temperatures, lower nutrient and organic matter content, acidic conditions (pH values of 3 to 5), lower moisture conditions, and the presence of indigenous soil microflora (Gerba et al., 1975). Potentially pathogenic bacteria are eliminated faster at high temperatures, pH values of about 7, low oxygen content, and high dissolved organic substance content (Pekdeger, 1984). The rate of bacterial die-off approximately doubles with each 10-degree increase of temperature between 5 and 30 °C (Tchobanoglous and Burton, 1991). Observed survival rates for various potential pathogenic bacteria have been found to be extremely variable. Survival times of longer than 6 months can occur at greater depths in unsaturated soils where oligotrophic (low-nutrient) conditions exist (Pekdeger, 1984).

The main methods of bacterial retention in unsaturated soil are filtration, sedimentation, and adsorption (Bicki et al., 1984; Cantor and Knox, 1985; Gerba et al., 1975). Filtration accounts for the most retention. The sizes of bacteria range from 0.2 to 5 microns (µm) (Pekdeger, 1984; Tchobanoglous and Burton, 1991); thus, physical removal through filtration occurs when soil micropores and surface water film interstices are smaller than this. Filtration of bacteria is enhanced by slow permeability rates, which can be caused by fine soil textures, unsaturated conditions, uniform wastewater distribution to soils, and periodic treatment system resting. Adsorption of bacteria onto clay and organic colloids occurs within a soil solution that has high ionic strength and neutral to slightly acid pH values (Canter and Knox, 1985).

Normal operation of septic tank/subsurface infiltration systems results in retention and die-off of most, if not all, observed pathogenic bacterial indicators within 2 to 3 feet (60 to 90 centimeters) of the infiltrative surface (Anderson et al., 1994; Ayres Associates, 1993a, c; Bouma et al., 1972; McGauhey and Krone, 1967). With a mature biomat at the infiltrative surface of coarser soils, most bacteria are removed within the first 1 foot (30 centimeters) vertically or horizontally from the trench-soil interface (University of Wisconsin, 1978). Hydraulic loading rates of less than 2 inches/day (5 centimeters/day) have also been found to promote better removal of bacteria in septic tank effluent (Ziebell et al., 1975). Biomat

formation and lower hydraulic loading rates promote unsaturated flow, which is one key to soil-based removal of bacteria from wastewater. The retention behavior of actual pathogens in unsaturated soil might be different from that of the indicators (e.g., fecal coliforms) that have been measured in most studies.

Failure to properly site, design, install, and/or operate and maintain subsurface infiltration systems can result in the introduction of potentially pathogenic bacteria into ground water or surface waters. Literature reviews prepared by Hagedorn (1982) and Bicki et al. (1984) identify a number of references that provide evidence that infiltrative surfaces improperly constructed below the ground water surface or too near fractured bedrock correlate with such contamination. Karst geology and seasonally high water tables that rise into the infiltrative field can also move bacteria into ground water zones. Once in ground water, bacteria from septic tank effluent have been observed to survive for considerable lengths of time (7 hours to 63 days), and they can travel up to and beyond 100 feet (30 meters) (Gerba et al., 1975).

Viruses are not a normal part of the fecal flora. They occur in infected persons, and they appear in septic tank effluent intermittently, in varying numbers, reflecting the combined infection and carrier status of OWTS users (Berg, 1973). It is estimated that less than 1 to 2 percent of the stools excreted in the United States contain enteric viruses (University of Wisconsin, 1978). Therefore, such viruses are difficult to monitor and little is known about their frequency of occurrence and rate of survival in traditional septic tank systems. Once an infection (clinical or subclinical) has occurred, however, it is estimated that feces may contain  $10^6$  to  $10^{10}$  viral particles per gram (Kowal, 1982). Consequently, when enteric viruses are present in septic tank effluent, they might be present in significant numbers (Anderson et al., 1991; Hain and O'Brien, 1979; Harkin et al., 1979; Vaughn and Landry, 1977; Yeager and O'Brien, 1977).

Some reduction (less than 1 log) of virus concentrations in wastewater occurs in the septic tank. Higgins et al. (2000) reported a 74 percent decrease in MS2 coliphage densities, findings that concurs with those of other studies (Payment et al., 1986; Roa, 1981). Viruses can be both retained and inactivated in soil; however, they can also be retained but not

inactivated. If not inactivated, viruses can accumulate in soil and subsequently be released due to changing conditions, such as prolonged peak OWTS flows or heavy rains. The result could be contamination of ground water. Soil factors that decrease survival include warm temperatures, low moisture content, and high organic content. Soil factors that increase retention include small particle size, high moisture content, low organic content, and low pH. Sobsey (1983) presents a thorough review of these factors. Virus removal below the vadose zone might be negligible in some geologic settings. (Cliver, 2000).

Most studies of the fate and transport of viruses in soils have been columnar studies using a specific serotype, typically poliovirus 1, or bacteriophages (Bitton et al., 1979; Burge and Enkiri, 1978; Drewry, 1969, 1973; Drewry and Eliassen, 1968; Duboise et al., 1976; Goldsmith et al., 1973; Green and Cliver, 1975; Hori et al., 1971; Lance et al., 1976; Lance et al., 1982; Lance and Gerba, 1980; Lefler and Kott, 1973, 1974; Nestor and Costin, 1971; Robeck et al., 1962; Schaub and Sorber, 1977; Sobsey et al., 1980; Young and Burbank, 1973; University of Wisconsin, 1978). The generalized results of these studies indicate that adsorption is the principal mechanism of virus retention in soil. Increasing the ionic strength of the wastewater enhances adsorption. Once viruses have been retained, inactivation rates range from 30 to 40 percent per day.

Various investigations have monitored the transport of viruses through unsaturated soil below the infiltration surface has been monitored by (Anderson et al., 1991; Hain and O'Brien, 1979; Jansons et al., 1989; Schaub and Sorber, 1977; Vaughn and Landry, 1980; Vaughn et al., 1981; Vaughn et al., 1982, 1983; Wellings et al., 1975). The majority of these studies focused on indigenous viruses in the wastewater and results were mixed. Some serotypes were found to move more freely than others. In most cases viruses were found to penetrate more than 10 feet (3 meters) through unsaturated soils. Viruses are less affected by filtration than bacteria (Bechdol et al., 1994) and are more resistant than bacteria to inactivation by disinfection (USEPA, 1990). Viruses have been known to persist in soil for up to 125 days and travel in ground water for distances of up to 1,339 feet (408 meters). However, monitoring of eight conventional individual home septic tank systems in Florida indicated that 2 feet (60 centimeters) of fine sand effectively



removed viruses (Anderson et al., 1991; Ayres Associates, 1993c). Higgins (2000) reported 99 percent removal of virus particles within the first 1 foot (30.5 centimeters) of soil.

Recent laboratory and field studies of existing onsite systems using conservative tracers (e.g., bromide ions) and microbial surrogate measures (e.g., viruses, bacteria) found that episodic breakthroughs of virus and bacteria can occur in the SWIS, particularly during early operation (Van Cuyk et al., 2001). Significant (e.g., 3-log) removal of viruses and near complete removal of fecal bacteria can be reasonably achieved in 60 to 90 centimeters of sandy media (Van Cuyk et al., 2001).

Inactivation of pathogens through other physical, chemical, or biological mechanisms varies considerably. Protozoan cysts or oocysts are generally killed when they freeze, but viruses are not. Ultraviolet light, extremes of pH, and strong oxidizing agents (e.g., hypochlorite, chlorine dioxide, ozone) are also effective in killing or inactivating most pathogens (Cliver, 2000). Korich (1990) found that in demand-free water, ozone was slightly more effective than chlorine dioxide against *Cryptosporidium parvum* oocysts, and both were much more effective than chlorine or monochloramine. *C. parvum* oocysts were

found to be 30 times more resistant to ozone and 14 times more resistant to chlorine dioxide than are *Giardia lamblia* cysts (Korich et al., 1990).

### Toxic organic compounds

A number of toxic organic compounds that can cause neurological, developmental, or other problems in humans and interfere with biological processes in the environment can be found in septic tank effluent. Table 3-22 provides information on potential health effects from selected organic chemicals, along with USEPA maximum containment levels for these pollutants in drinking water. The toxic organics that have been found to be the most prevalent in wastewater are 1,4-dichlorobenzene, methylbenzene (toluene), dimethylbenzenes (xylenes), 1,1-dichloroethane, 1,1,1-trichloroethane, and dimethylketone (acetone). These compounds are usually found in household products like solvents and cleaners.

No known studies have been conducted to determine toxic organic treatment efficiency in single-family home septic tanks. A study of toxic organics in domestic wastewater and effluent from a community septic tank found that removal of low-molecular-weight alkylated benzenes (e.g., toluene,

**Table 3-22. Maximum contaminant levels (MCLs) for selected organic chemicals in drinking water**

Contaminant	MCL (mg/L)	Potential health effects
Benzene	0.005	Anemia; decrease in blood platelets; increased risk of cancer
Chlordane	0.002	Liver or nervous system problems; increased risk of cancer
Chlorobenzene	0.1	Liver or kidney problems
2,4-D	0.07	Liver, kidney, or adrenal gland problems
o-Dichlorobenzene	0.6	Liver, kidney, or circulatory system problems
1,2-Dichloroethane	0.005	Increased risk of cancer
Dichloromethane	0.005	Liver problems, increased risk of cancer
Dioxin	0.00000003	Reproductive difficulties; increased risk of cancer
Ethylbenzene	0.7	Liver or kidney problems
Hexachlorobenzene	0.001	Liver or kidney problems; reproductive difficulties; increased risk of cancer
Lindane	0.0002	Liver or kidney problems
Toluene	1.0	Nervous system, kidney, or liver problems
Trichloroethylene	0.005	Liver problems; increased risk of cancer
Vinyl chloride	0.002	Increased risk of cancer
Xylenes (total)	10	Nervous system damage

Source: USEPA, 2000a.



xylene) was noticeable, whereas virtually no removal was noted for higher-molecular-weight compounds (DeWalle et al., 1985). Removal efficiency was observed to be directly related to tank detention time, which is directly related to settling efficiency.

The behavior of toxic organic compounds in unsaturated soil is not well documented. The avenues of mobility available to toxic organics include those which can transport organics in both gaseous and liquid phases. In the gaseous phase toxic organics diffuse outward in any direction within unobstructed soil voids; in the liquid phase they follow the movement of the soil solution. Because of their nonpolar nature, certain toxic organics are not electrochemically retained in unsaturated soil. Toxic organics can be transformed into less innocuous forms in the soil by indigenous or introduced microorganisms. The biodegradability of many organic compounds in the soil depends on oxygen availability. Halogenated straight-chain compounds, such as many chlorinated solvents, are usually biodegraded under anaerobic conditions when carbon dioxide replaces oxygen (Wilhelm, 1998). Aromatic organic compounds like benzene and toluene, however, are biodegraded primarily under aerobic conditions. As for physical removal, organic contaminants are adsorbed by solid organic matter. Accumulated organic solids in the tank and in the soil profile, therefore, might be important retainers of organic contaminants. In addition, because many of the organic contaminants found in domestic wastewater are relatively volatile, unsaturated conditions in drain fields likely facilitate the release of these compounds through gaseous diffusion and volatilization (Wilhelm, 1998).

Rates of movement for the gaseous and liquid phases depend on soil and toxic organic compound type. Soils having fine textures, abrupt interfaces of distinctly different textural layers, a lack of fissures and other continuous macropores, and low moisture content retard toxic organic movement (Hillel, 1989). If gaseous exchange between soil and atmosphere is sufficient, however, appreciable losses of low-molecular-weight alkylated benzenes such as toluene and dimethylbenzene (xylene) can be expected because of their relatively high vapor pressure (Bauman, 1989). Toxic organics that are relatively miscible in water (e.g., methyl tertiary butyl ether, tetrachloroethane, benzene, xylene) can be expected to move with soil water. Nonmiscible toxic organics that remain in liquid or solid phases (chlorinated solvents, gasoline, oils) can become tightly bound to soil particles (Preslo et al., 1989). Biodegradation appears to be an efficient removal mechanism for many volatile organic compounds. Nearly complete or complete removal of toxic organics below infiltration systems was found in several studies (Ayres Associates, 1993a, c; Robertson, 1991; Sauer and Tyler, 1991).

Some investigations have documented toxic organic contamination of surficial aquifers by domestic wastewater discharged from community infiltration fields (Tomson et al., 1984). Of the volatile organic compounds detected in ground water samples collected in the vicinity of subsurface infiltration systems, Kolega (1989) found trichloromethane, toluene, and 1,1,1-trichloroethane most frequently and in some of the highest concentrations. Xylenes, dichloroethane, and dichloromethane were also detected.

**Table 3-23. Case study: concentration of metals in septic tank effluent<sup>a</sup>**

Metal constituent	Mean concentration (µg/L)	Range (µg/L)
Arsenic	37 (5) <sup>b</sup>	6–59
Barium	890 (5)	400–1310
Cadmium	83 (7)	30–330
Chromium	320 (7)	60–1400
Lead	2700 (1)	-
Mercury	2 (2)	1–3
Nickel	4000 (1)	-
Selenium	15 (6)	3–39

<sup>a</sup> Samples collected from the outlet of nine septic tanks.

<sup>b</sup> Number in parentheses indicates number of septic tanks in which metals were detected.

Source: Florida HRS, 1993, after Watkins, 1991.

Once toxic organics reach an aquifer, their movement generally follows the direction of ground water movement. The behavior of each within an aquifer, however, can be different. Some stay near the surface of the aquifer and experience much lateral movement. Others, such as aliphatic chlorinated hydrocarbons, experience greater vertical movement because of their heavier molecular weight (Dagan and Bresler, 1984). Based on this observation, 1,4-dichlorobenzene, toluene, and xylenes in septic tank effluent would be expected to experience more lateral than vertical movement in an aquifer; 1,1-dichloroethane, 1,1,1-trichloroethane, dichloromethane, and trichloromethane would be expected to show more vertical movement. Movement of toxic organic compounds is also affected by their degree of solubility in water. Acetone, dichloromethane, trichloromethane, and 1,1-dichloroethane are quite soluble in water and are expected to be very highly mobile; 1,1,1-trichloroethane, toluene, and 1,2-dimethylbenzene (o-xylene) are expected to be moderately mobile; and 1,3-dimethylbenzene (m-xylene), 1,4-dimethylbenzene (p-xylene), and 1,4-dichlorobenzene are expected to have low mobility (Fetter, 1988).

System design considerations for removing toxic organic compounds include increasing tank retention time (especially for halogenated, straight-chain compounds like organic solvents), ensuring greater vadose zone depths below the SWIS, and placing the infiltration system high in the soil profile, where higher concentrations of organic matter and oxygen can aid the volatilization and treatment of

aromatic compounds. It should be noted that significantly high levels of toxic organic compounds can cause die-off of tank and biomat microorganisms, which could reduce treatment performance. Onsite systems that discharge high amounts of toxic organic compounds might be subject to USEPA's Class V Underground Injection Control Program (see <http://www.epa.gov/safewater.uic.html>).

### Metals

Metals like lead, mercury, cadmium, copper, and chromium can cause physical and mental developmental delays, kidney disease, gastrointestinal illnesses, and neurological problems. Some information is available regarding metals in septic tank effluent (DeWalle et al. 1985). Metals can be present in raw household wastewater because many commonly used household products contain metals. Aging interior plumbing systems can contribute lead, cadmium, and copper (Canter and Knox, 1985). Other sources of metals include vegetable matter and human excreta. Several metals have been found in domestic septage, confirming their presence in wastewater. They primarily include cadmium, copper, lead, and zinc (Bennett et al., 1977; Feige et al., 1975; Segall et al., 1979). OWTSSs serving nonresidential facilities (e.g., rural health care facilities, small industrial facilities) can also experience metal loadings. Several USEPA priority pollutant metals have been found in domestic septic tank effluent (Whelan and Titmanis, 1982). The most prominent metals were nickel, lead, copper,

**Table 3-24. Maximum contaminant levels (MCLs) for selected inorganic chemicals in drinking water**

Contaminant	MCL (mg/L)	Potential health effects
Arsenic	0.05 <sup>1</sup>	Increase in blood cholesterol; decrease in blood glucose
Cadmium	0.005	Kidney damage
Chromium	0.1	Possible allergic dermatitis after long exposures
Copper	1.3 (action level)	Gastrointestinal distress with short-term exposure; liver or kidney damage possible with long-term exposure
Lead	0.015 (action level)	Physical and mental developmental delays in children; kidney problems, high blood pressure for adults
Inorganic mercury	0.002	Kidney damage
Nitrate-nitrogen	10.0	Methemoglobinemia (blue baby syndrome)
Nitrite-nitrogen	1.0	Methemoglobinemia (blue baby syndrome)
Selenium	0.05	Hair or fingernail loss; numbness in fingers or toes; circulatory problems

<sup>1</sup> The MCL for arsenic is currently under review by USEPA.  
Source: USEPA, 2000a.

zinc, barium, and chromium. A comparison of mean concentrations of metals in septic tank effluent as found in one study (table 3-23) with the USEPA maximum contaminant levels for drinking water noted in table 3-24 reveals a potential for contamination that might exceed drinking water standards in some cases.

The fate of metals in soil is dependent on complex physical, chemical, and biochemical reactions and interactions. The primary processes controlling the fixation/mobility potential of metals in subsurface infiltration systems are adsorption on soil particles and interaction with organic molecules. Because the amount of naturally occurring organic matter in the soil below the infiltrative surface is typically low, the cation exchange capacity of the soil and soil solution pH control the mobility of metals below the infiltrative surface. Acidic conditions can reduce the sorption of metals in soils, leading to increased risk of ground water contamination (Evanko, 1997; Lim et al., 2001). (See figure 3-11.) It is likely that movement of metals through the unsaturated zone, if it occurs at all, is accomplished by movement of organic ligand complexes formed at or near the infiltrative surface (Canter and Knox, 1985; Matthes, 1984).

Information regarding the transport and fate of metals in ground water can be found in hazardous waste and soil remediation literature (see [http://www.gwrtac.org/html/Tech\\_eval.html#METALS](http://www.gwrtac.org/html/Tech_eval.html#METALS)). One study attempted to link septic tank systems to

metal contamination of rural potable water supplies, but only a weak correlation was found (Sandhu et al., 1977). Removal of sources of metals from the wastewater stream by altering user habits and implementing alternative disposal practices is recommended. In addition, the literature suggests that improving treatment processes by increasing septic tank detention times, ensuring greater unsaturated soil depths, and improving dose and rest cycles may decrease risks associated with metal loadings from onsite systems (Chang, 1985; Evanko, 1997; Lim et al., 2001).

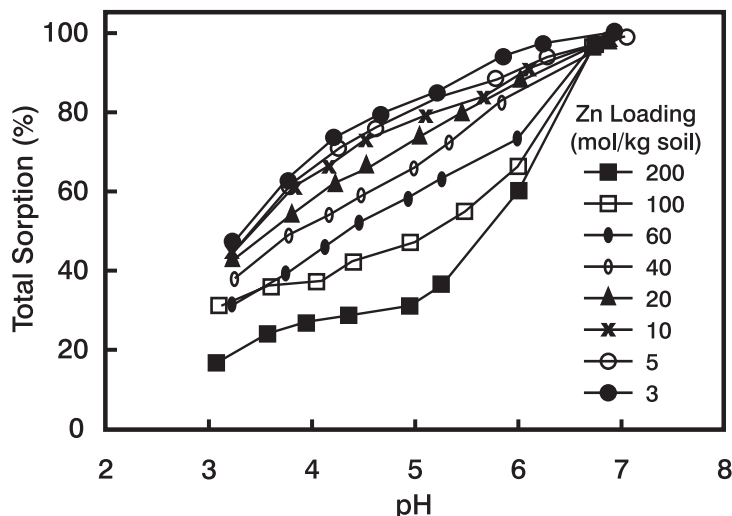
### Surfactants

Surfactants are commonly used in laundry detergents and other soaps to decrease the surface tension of water and increase wetting and emulsification. Surfactants are the largest class of anthropogenic organic compounds present in raw domestic wastewater (Dental et al., 1993). Surfactants that survive treatment processes in the septic tank and subsequent treatment train can enter the soil and mobilize otherwise insoluble organic pollutants. Surfactants have been shown to decrease adsorption — and even actively desorb — the pollutant trichlorobenzene from soils (Dental, 1993). Surfactants can also change soil structure and alter wastewater infiltration rates.

Surfactant molecules contain both strongly hydrophobic and strongly hydrophilic properties and thus tend to concentrate at interfaces of the aqueous system including air, oily material, and particles. Surfactants can be found in most domestic septic tank effluents. Since 1970 the most common anionic surfactant used in household laundry detergent is linear alkylbenzenesulfonate, or LAS. Whelan and Titmanis (1982) found a range of LAS concentrations from 1.2 to 6.5 mg/L in septic tank effluent. Dental (1993) cited studies finding concentrations of LAS in raw wastewater ranging from 3 mg/L to 21 mg/L.

Because surfactants in wastewater are associated with particulate matter and oils and tend to concentrate in sludges in wastewater treatment plants (Dental, 1993), increasing detention times in the tank might aid in their removal. The behavior of surfactants in unsaturated soil is dependent on surfactant type. It is expected that minimal retention of anionic and nonionic surfactants occurs in unsaturated soils having low organic matter content. However, the degree of mobility is subject to soil

Figure 3-11. Zinc sorption by clay as a function of pH at various loading concentrations (in 0.05 M NaCl medium)



Source: Lim et al., 2001.

solution chemistry, organic matter content of the soil, and rate of degradation by soil microorganisms. Soils with high organic matter should favor retention of surfactants because of the lipophilic component of surfactants. Surfactants are readily biodegraded under aerobic conditions and are more stable under anaerobic conditions. Substantial attenuation of LAS in unsaturated soil beneath a subsurface infiltration system has been demonstrated (Anderson et al., 1994; Robertson et al., 1989; Shimp et al., 1991). Cationic surfactants strongly sorb to cation exchange sites of soil particles and organic matter (McAvoy et al., 1991). Thus, fine-textured soils and soils having high organic matter content will generally favor retention of these surfactants.

Some investigations have identified the occurrence of methylene blue active substance (MBAS) in ground water (Perlmutter and Koch, 1971; Thurman et al., 1986). The type of anionic surfactant was not specifically identified. However, it was surmised that the higher concentrations noted at the time of the study were probably due to use of alkylbenzenesulfonate (ABS), which is degraded by microorganisms at a much slower rate than LAS. There has also been research demonstrating that all types of surfactants might be degraded by microorganisms in saturated sediments (Federle and Pastwa, 1988). No investigations have been found that identify cationic or nonionic surfactants in ground water that originated from subsurface wastewater infiltration systems. However, because of concerns over the use of alkylphenol polyethoxylates, studies of fate and transport of this class of endocrine disrupters are in progress.

### Summary

Subsurface wastewater infiltration systems are designed to provide wastewater treatment and dispersal through soil purification processes and ground water recharge. Satisfactory performance is dependent on the treatment efficiency of the pretreatment system, the method of wastewater distribution and loading to the soil infiltrative surface, and the properties of the vadose and saturated zones underlying the infiltrative surface. The soil should have adequate pore characteristics, size distribution, and continuity to accept the daily volume of wastewater and provide sufficient soil-water contact and retention time for treatment before the effluent percolates into the ground water.

Ground water monitoring below properly sited, designed, constructed, and operated subsurface infiltration systems has shown carbonaceous biochemical oxygen demand (CBOD), suspended solids (TSS), fecal indicators, metals, and surfactants can be effectively removed by the first 2 to 5 feet of soil under unsaturated, aerobic conditions. Phosphorus and metals can be removed through adsorption, ion exchange, and precipitation reactions, but the capacity of soil to retain these ions is finite and varies with soil mineralogy, organic content, pH, reduction-oxidation potential, and cation exchange capacity. Nitrogen removal rates vary significantly, but most conventional SWISs do not achieve drinking water standards (i.e., 10 mg/L) for nitrate concentrations in effluent plumes. Evidence is growing that some types of viruses are able to leach with wastewater from subsurface infiltration systems to ground water. Longer retention times associated with virus removal are achieved with fine-texture soil, low hydraulic loadings, uniform dosing and resting, aerobic subsoils, and high temperatures. Toxic organics appear to be removed in subsoils, but further study of the fate and transport of these compounds is needed.

Subsurface wastewater infiltration systems do affect ground water quality and therefore have the potential to affect surface water quality (in areas with gaining streams, large macropore soils, or karst terrain or in coastal regions). Studies have shown that after the treated percolate enters ground water it can remain as a distinct plume for as much as several hundred feet. Concentrations of nitrate, dissolved solids, and other soluble contaminants can remain above ambient ground water concentrations within the plume. Attenuation of solute concentrations is dependent on the quantity of natural recharge and travel distance from the source, among other factors. Organic bottom sediments of surface waters appear to provide some retention or removal of wastewater contaminants if the ground water seeps through those sediments to enter the surface water. These bottom sediments might be effective in removing trace organic compounds, endotoxins, nitrate, and pathogenic agents through biochemical activity, but few data regarding the effectiveness and significance of removal by bottom sediments are available.

Public health and environmental risks from properly sited, designed, constructed, and operated



septic tank systems appear to be low. However, soils with excessive permeability (coarse-texture soil or soil with large and continuous pores), low organic matter, low pH, low cation exchange capacities, low oxygen-reduction potential, high moisture content, and low temperatures can increase health and environmental risks under certain circumstances.

### 3.8 Establishing performance requirements

As noted in chapter 2, the OWTS regulatory authority and/or management entity establishes performance requirements to ensure future compliance with the public health and environmental objectives of the community. Performance requirements are based on broad goals such as eliminating health threats from contact with effluent or direct/indirect ingestion of effluent contaminants. They are intended to meet standards for water quality and public health protection and can be both quantitative (total mass load or concentration) or qualitative (e.g., no odors or color in discharges to surface waters). Compliance with performance requirements is measured at a specified performance boundary (see chapter 5), which can be a physical boundary or a property boundary. Figure 3-12 illustrates performance and compliance boundaries and potential monitoring sites in a cutaway view of a SWIS.

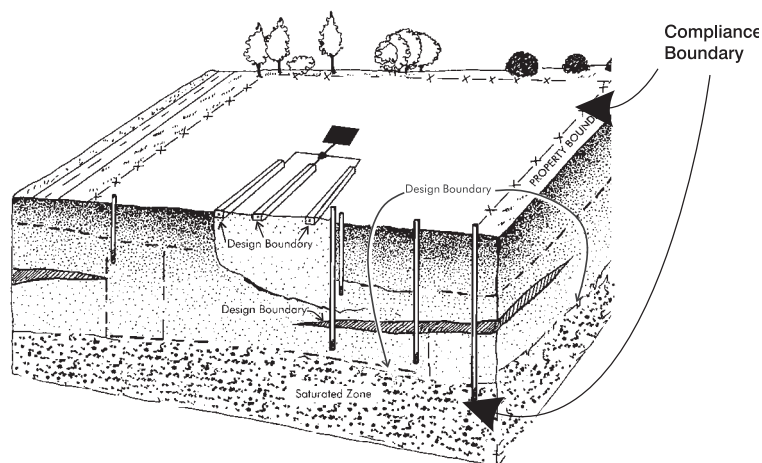
Design boundaries are where conditions abruptly change. A design boundary can be at the intersection of unit processes or between saturated and unsaturated soil conditions (e.g., the delineation between the infiltrative, vadose, and ground water zones) or at another designated location, such as a drinking water well, nearby surface water, or property boundary.

Performance requirements for onsite treatment systems should be established based on water quality standards for the receiving resource and the assimilative capacity of the environment between the point of the wastewater release to the receiving environment and the performance boundary designated by the management entity or regulatory authority. Typically, the assimilative capacity of the receiving environment is considered part of the treatment system to limit costs in reaching the desired performance requirement or water quality goals (see figure 3-12). The performance boundary is usually a specified distance from the point of release, such as a property boundary, or a point of use, such as a drinking water well or surface water with designated uses specified by the state water agency.

Achievement of water quality objectives requires that treatment system performance consider the assimilative capacity of the receiving environment. If the assimilative capacity of the receiving environment is overlooked because of increases in pollutant loadings, the treatment performance of onsite systems before discharge to the soil should increase. OWTSs serving high-density clusters of homes or located near sensitive receiving waters might be the subject of more stringent requirements than those serving lower-density housing farther from sensitive water resources.

Performance requirements for onsite systems should be based on risk assessments that consider the hazards of each potential pollutant in the wastewater to be treated, its transport and fate, potential exposure opportunities, and projected effects on humans and environmental resources. A variety of governmental agencies have already established water quality standards for a wide range of surface water uses. These include standards for protecting waters used for recreation, aquatic life support, shellfish propagation and habitat, and drinking water. In general, these standards are based on risk assessment processes and procedures that consider the designated uses of receiving waters, the hazard and toxicity of the pollutants,

Figure 3-12. Example of compliance boundaries for onsite wastewater treatment systems





### Nitrogen contributions from onsite systems

The San Lorenzo River basin in California is served primarily by onsite wastewater treatment systems. Since 1985 the Santa Cruz County Environmental Health Service has been working with local stakeholders to develop a program for inspecting all onsite systems, assessing pollutant loads from those systems, and correcting identified problems. Studies conducted through this initiative included calculations of nutrient inputs to the river from onsite systems. According to the analyses performed by the county and its contractors, 55 to 60 percent of the nitrate load in the San Lorenzo River during the summer months came from onsite system effluent. Assumptions incorporated into the calculations included an average septic tank effluent total nitrogen concentration of 50 mg/L, per capita wastewater generation of 70 gallons per day, and an average house occupancy of 2.8 persons. Nitrogen removal was estimated at 15 percent for SWISs in sandy soils and 25 percent for SWISs in other soils.

*Source: Ricker et al., 1994.*

### Performance requirements of Wisconsin's ground water quality rule

Wisconsin was one of the first states to promulgate ground water standards. Promulgated in 1985, Wisconsin's ground water quality rule establishes both public health and public welfare ground water quality standards for substances detected in or having a reasonable probability of entering the ground water resources of the state. Preventive action and enforcement limits are established for each parameter included in the rule. The preventive action limits (PALs) inform the Department of Natural Resources (DNR) of potential threats to ground water quality. When a PAL is exceeded, the Department is required to take action to control the contamination so that the enforcement limit is not reached. For example, nitrate-nitrogen is regulated through a public health standard. The PAL for nitrate is 2 mg/L (nitrogen), and its enforcement limit is 10 mg/L (nitrogen). If the PAL is exceeded, the DNR requires a specific control response based on an assessment of the cause and significance of the elevated concentration. Various responses may be required, including no action, increased monitoring, revision of operational procedures at the facility, remedial action, closure, or other appropriate actions that will prevent further ground water contamination.

*Source: State of Wisconsin Administrative Code, Chapter NR 140.*

the potential for human and ecosystem exposure, and the estimated impacts of exposure. Although federally mandated ground water quality standards (maximum contaminant levels; see tables in section 3.8) are currently applicable only to drinking water supply sources, some states have adopted similar local ground water quality standards (see sidebar).

Local needs or goals need to be considered when performance requirements are established. Watershed- or site-specific conditions might warrant lower pollutant discharge concentrations or mass pollutant limits than those required by existing water quality standards. However, existing water quality standards provide a good starting point for selecting appropriate OWTS performance require-

ments. The mass of pollutants that should be removed by onsite treatment systems can be determined by estimating the mass of cumulative OWTS pollutants discharged to the receiving waters and calculating the assimilative capacity of the receiving waters. Mass pollutant loads are usually apportioned among the onsite systems and other loading sources (e.g., urban yards and landscaped areas, row crop lands, animal feeding operations) in a ground water aquifer or watershed.

#### 3.8.1 Assessing resource vulnerability and receiving water capacity

Historically, conventional onsite systems have been designed primarily to protect human health. Land use planning has affected system oversight requirements, but environmental protection has been a

### Massachusetts' requirements for nitrogen-sensitive areas

Nitrogen-sensitive areas are defined in state rules as occurring within Interim Wellhead Protection Areas, 1-year recharge areas of public water supplies, nitrogen-sensitive embayments, and other areas that are designated as nitrogen-sensitive based on scientific evaluations of the affected water body (310 Code of Massachusetts Regulations 15.000, 1996). Any new construction using onsite wastewater treatment in these designated areas must abide by prescriptive standards that limit design flows to a maximum of 440 gallons per day of aggregated flows per acre. Exceptions are permitted for treatment systems with enhanced nitrogen removal capability. With enhanced removal, the maximum design flow may be increased. If the system is an approved alternative system or a treatment unit with a ground water discharge permit that produces an effluent with no more than 10 mg/L of nitrate, the design flow restrictions do not apply.

Source: Title V, Massachusetts Environmental Code.

tertiary objective, at best, for most regulatory programs. Human health protection is assumed (but not always ensured) by infiltrating septic tank effluent at sufficiently low rates into moderately permeable, unsaturated soils downgradient and at specified distances from water supply wells. Site evaluations are performed to assess the suitability of proposed locations for the installation of conventional systems. Criteria typically used are estimated soil permeability (through soil analysis or percolation tests), unsaturated soil depth above the seasonally high water table, and horizontal setback distances from wells, property lines, and dwellings (see chapter 5).

OWTS codes have not normally considered increased pollutant loads to a ground water resource (aquifer) due to higher housing densities, potential contamination of water supplies by nitrates, or the environmental impacts of nutrients and pathogens on nearby surface waters. Preserving and protecting water quality require more comprehensive evaluations of development sites proposed to be served by onsite systems. A broader range of water contaminants and their potential mobility in the environment should be considered at scales that consider both spatial (site vs. region) and temporal (existing vs. planned development) issues (see tables 3-20 to 3-24). Some watershed analyses are driven by TMDLs (Total Maximum Daily Loads established under section 303 of the Clean Water Act) for interconnected surface waters, while others are driven by sole source aquifer or drinking water standards.

### Site suitability assessments

Some states have incorporated stricter site suitability and performance requirements into their OWTS permit programs. Generally, the stricter requirements were established in response to concerns over nitrate contamination of water supplies or nutrient inputs to surface waters. For example, in Massachusetts the Department of Environmental Protection has designated “nitrogen-sensitive areas” in which new nitrogen discharges must be limited. Designation of these areas is based on ecological sensitivity and relative risk of threats to drinking water wells.

### Multivariate rating approaches: DRASTIC

Other approaches are used that typically involve regional assessments that inventory surface and ground water resources and rate them according to their sensitivity to wastewater impacts. The ratings are based on various criteria that define vulnerability. One such method is DRASTIC (see sidebar). DRASTIC is a standardized system developed by USEPA to rate broad-scale ground water vulnerability using hydrogeologic settings (Aller et al., 1987). The acronym identifies the hydrogeologic factors considered: depth to ground water, (net) recharge, aquifer media, soil media, topography (slope), impact of the vadose zone media, and (hydraulic) conductivity of the aquifer. This method is well suited to geographic information system (GIS) applications but requires substantial amounts of information regarding the natural resources of a region to produce meaningful results. Landscape scale methods and models are excellent planning tools but might have limited utility at the site scale. These approaches should be

### Using GIS tools to characterize potential water quality threats in Colorado

Summit County, Colorado, developed a GIS to identify impacts that OWTs-generated nitrates might have on water quality in the upper Blue River watershed. The GIS was developed in response to concerns that increasing residential development in the basin might increase nutrient loadings into the Dillon Reservoir. Database components entered into the GIS included geologic maps, soil survey maps, topographic features, land parcel maps, domestic well sampling data, onsite system permitting data, well logs, and assessors' data. The database can be updated with new water quality data, system maintenance records, property records, and onsite system construction permit and repair information. The database is linked to the DRASTIC ground water vulnerability rating. The approach is being used to identify areas that have a potential for excessive contamination by nitrate-nitrogen from OWTs. These assessments could support onsite system placement and removal decisions and help prioritize water quality improvement projects.

Source: Stark et al., 1999.

supported and complemented by other information collected during the site evaluation (see chapter 5).

#### GIS overlay analysis: MANAGE

A simpler GIS-based method was developed by the University of Rhode Island Cooperative Extension Service (see <http://www.edc.uri.edu/cewq/manage.html>). The Method for Assessment, Nutrient-loading, and Geographic Evaluation (MANAGE) uses a combination of map analyses that incorporates landscape features, computer-generated GIS and other maps, and a spreadsheet to estimate relative pollution risks of proposed land uses (Joubert et al., 1999; Kellogg et al., 1997). MANAGE is a screening-level tool designed for areawide assessment of entire aquifers, wellhead protection areas, or small watersheds (figure 3-13). Local knowledge and input are needed to identify critical resource areas, refine the map data, and select management options for analysis. Community decision makers participate actively in the assessment process (see sidebar).

The spreadsheet from the MANAGE application extracts spatial and attribute data from the national Soil Survey Geographic (SSURGO) database (USDA, 1995; see [http://www.ftw.nrcs.usda.gov/ssur\\_data.html](http://www.ftw.nrcs.usda.gov/ssur_data.html)) and Anderson Level III Land Cover data (Anderson, 1976) through the Rhode Island GIS system. The soils are combined into hydrologic groups representing the capability of the soils to accept water infiltration, the depth to the water table, and the presence of hydraulically restrictive horizons. Estimates of nutrient loadings are made using published data and simplifying assumptions. The spreadsheet estimates relative

pollutant availability, surface water runoff pollutant concentrations, and pollutant migration to ground water zones without attempting to model fate and transport mechanisms, which are highly uncertain. From these data the spreadsheet calculates a hydrologic budget, estimates nutrient loading, and summarizes indicators of watershed health to create a comprehensive risk assessment for wastewater management planning. (For mapping products available from the U.S. Geological Survey, see <http://www.nmd.usgs.gov/>.)

MANAGE generates three types of assessment results that can be displayed in both map and chart form: (1) pollution “hot spot” mapping of potential high-risk areas, (2) watershed indicators based on land use characteristics (e.g., percent of impervious area and forest cover), and (3) nutrient loading in the watershed based on estimates from current research of sources, and generally assumed fates of nitrogen and phosphorus (Joubert et al., 1999).

It is important to note that before rules, ordinances, or overlay zones based on models are enacted or established, the models should be calibrated and verified with local monitoring information collected over a year or more. Only models that accurately and consistently approximate actual event-response relationships should serve as the basis for management action. Also, the affected population must accept the model as the basis for both compliance and possible penalties.

#### Value analysis and vulnerability assessment

Hoover et al. (1998) has proposed a more subjective vulnerability assessment method that emphasizes public input. This approach considers risk

assessment methods and management control strategies for both ground waters and surface waters. It uses three components of risk assessment and management, including consideration of

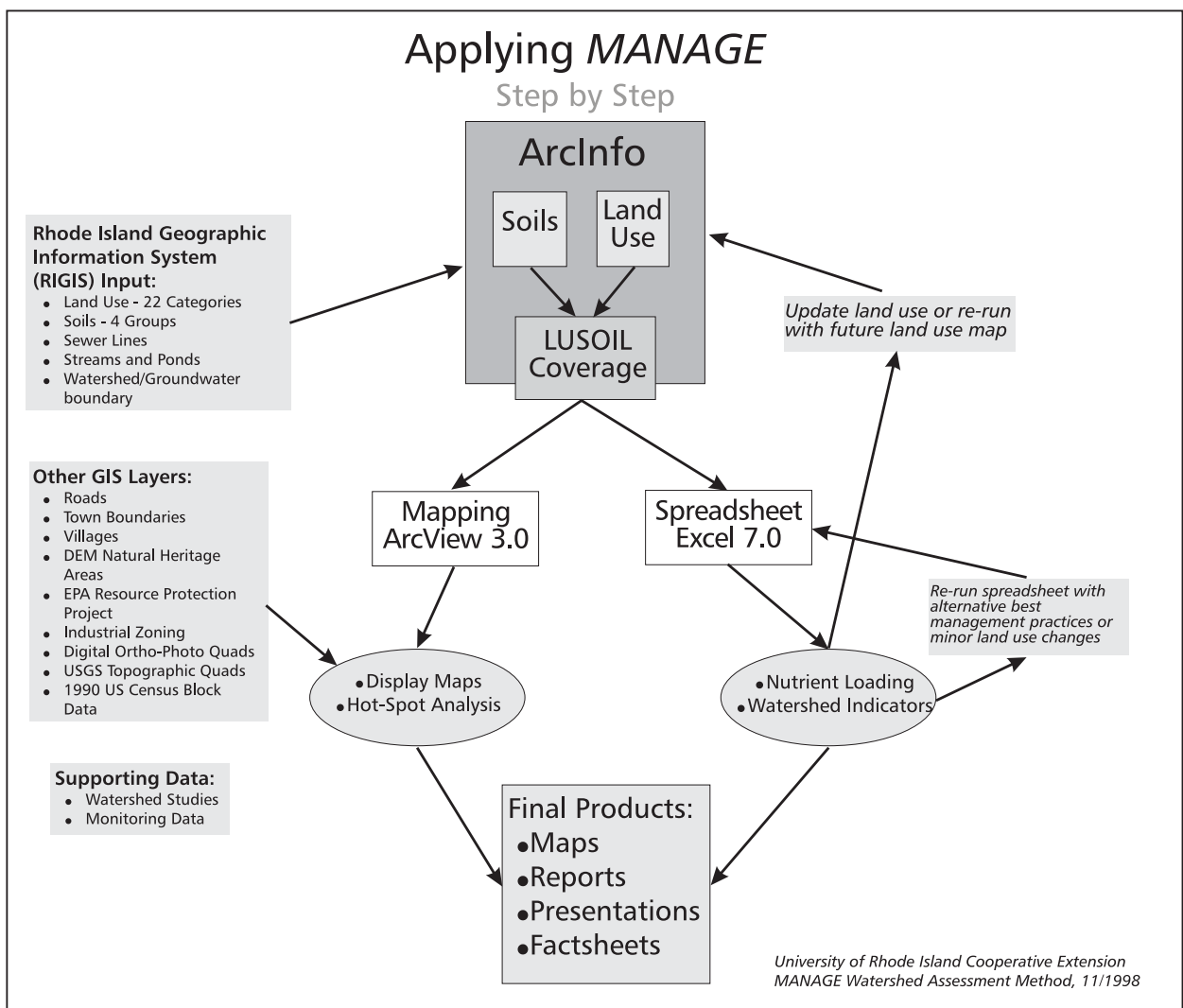
- Value of ground and surface water as a public water supply or resource
- Vulnerability of the water supply or resource
- Control measures for addressing hazards

The first part of the onsite risk assessment and management approach involves a listing of all the ground water and surface water resources in a region or community (table 3-26). Through community meetings consensus is developed on the

relative perceived value of each identified resource and the potential perceived consequences of contamination. For example, a community might determine that shellfish waters that are open to public harvesting are less important than public drinking water supply areas but more important than secondary recreational waters that might be used for body contact sports. This ranking is used to create a table that shows the relative importance of each resource (table 3-26 and case study).

The second part of this risk assessment process is development of a vulnerability assessment matrix. One potential measure of pollution vulnerability is the ability of pollutants to move vertically from the point of release to the water table or bedrock.

Figure 3-13. Input and output components of the MANAGE assessment method



Source: Kellogg et al., 1997.

### Application of the MANAGE tool to establish performance requirements

The town of New Shoreham, Rhode Island, is a popular vacation resort on a 6,400-acre island 10 miles off the southern coast of the state. The permanent population is approximately 800, but during the summer the population swells to as many as 10,000 overnight visitors and another 3,000 daily tourists. Proper wastewater management is a serious concern on the island. A publicly owned treatment works serves the town's harbor/commercial/business district, but 85 percent of the permanent residents and 54 percent of the summer population are served by OWTs, many of which ultimately discharge to the island's sole source aquifer. Protection of this critical water resource is vital to the island's residents and tourism-based economy.

The University of Rhode Island (URI) Cooperative Extension Service's MANAGE risk analysis model was used to identify potential sources of ground water contamination (Kellogg et al., 1997). The model was also used to analyze potential ground water impacts at build-out assuming current zoning. This projection was used to compare the relative change in pollution risk under future development scenarios including the use of alternative technologies that provide better removal of nitrogen and pathogens. Onsite treatment systems were estimated to contribute approximately 72 percent of the nitrogen entering ground water recharge areas. The model indicated that nitrogen removal treatment technologies could effectively maintain nitrogen inputs at close to existing levels even with continued growth. It also showed that nitrogen removal technologies were not necessary throughout the island but would be most beneficial in "hot spots" where the risk of system failure and pollutant delivery to sensitive areas was the greatest.

The town adopted a wastewater management ordinance that mandated regular inspections of onsite systems by a town inspector (Town of New Shoreham, 1996, 1998). It also established septic tank pumping schedules and other maintenance requirements based on inspection results. Inspection schedules have the highest priority in public drinking water supply reservoirs, community wellhead protection zones, and "hot spots" such as wetland buffers. Because the town expected to uncover failed and substandard systems, zoning standards were developed for conventional and alternative OWTs technologies to ensure that new and reconstructed systems would be appropriate for difficult sites and critical resource areas (Town of New Shoreham, 1998). A type of site vulnerability matrix was developed in cooperation with URI Cooperative Extension using key site characteristics—depth to seasonally high water table, presence of restrictive layers, and excessively permeable soils (Loomis et al., 1999). The matrix was used to create a vulnerability rating that is used to establish the level of treatment needed to protect water quality in that watershed or critical resource area.

Three treatment levels were established: T1, primary treatment with watertight septic tanks and effluent screens; T2N, nitrogen removal required to meet  $\leq 19$  mg/L; and T2C, fecal coliform removal  $\leq 1,000$  MPN/100 mL (table 3-25). The town provides a list of specific state-approved treatment technologies considered capable of meeting these standards. By the year 2005, cesspools and failing systems must be upgraded to specified standards. In addition, all septic tanks must be retrofitted with tank access risers and effluent screens.

Source: Loomis et al., 1999.

**Table 3-25. Treatment performance requirements for New Shoreham, Rhode Island**

Treatment level zone	Tested & certified watertight septic tank	Water-tight access risers to grade	Effluent filter & tipping D-box	Effluent BOD & TSS (mg/L)	TN removal percent	TN effluent (mg/L)	Fecal coliforms (CFUs per 100 mL)
T1	✓ <sup>a</sup>	✗	✓	NS <sup>b</sup>	NS	NS	NS
T2N <sup>c</sup>	✗	✓	✗ <sup>d</sup>	$\leq 30$ <sup>e</sup>	$\geq 50$	$\leq 19$	NS
T2C <sup>c</sup>	✓	✗	✓ <sup>d</sup>	$\leq 10$	NS	NS	$\leq 1000$

<sup>a</sup>Required by town ordinance.

<sup>b</sup>NS = not specified by town ordinance.

<sup>c</sup>Shallow pressure-dosed drain fields may be required when soil suitability rating is poor, when site vulnerability rating is high to extreme, or when the proposed system is in a wetland buffer, or where other constraints exist.


<sup>d</sup>Required if feasible.

<sup>e</sup>All concentrations and reductions are determined and measured at the outlet of the treatment unit prior to discharge to a drain field.

Source: Adapted from Loomis, 2000.



Table 3-26. Resource listing, value ranking, and wastewater management schematic

Vulnerability Rating	Water supply			Water resource							
	Ground water		GW	Surface water			GW				
	Site	Critical area	Regionally important aquifer	Primary recreation	Shellfish waters	Nutrient-sensitive	Secondary recreation	Poor aquifer			
High	Sites of community wellfields and source areas within 10 days' time of travel in the ground water to the community wellfields			Directly next to wellfield	Wellfield capture zone	Outwash sand & gravel	Beaches used for swimming	Commercial open waters	Lakes, ponds, rivers, etc.	Other surface waters	Unproductive confined aquifers
	Inner and outer critical areas that are within the ground water capture zones for the community wellfields										
	High-yielding surficial aquifers of regional importance that are used for many individual wells and that have rapid recharge										
Mod.	Source areas within 200 feet of frequently used swimming beaches										
	Source areas within 200 feet of shellfish waters that are open to public harvesting										
	Source areas for nutrient-sensitive surface waters that are susceptible to eutrophication or to loss of shellfish or finfish nursery areas due to nutrient inputs										
Low	Source areas within 100 feet of secondary recreational waters that are used for swimming on an unorganized basis										
	Poor, unproductive glacial till aquifers or productive aquifers isolated from the surface or not used for many private wells										
<p>Highest Value Resource  Lowest Value Resource</p>											

Source: Hoover et al., 1998.

### Resource value ranking and wastewater management

A northern U.S. unsewered coastal community was concerned about the impacts onsite treatment systems might have on its ground water resources (Hoover et al., 1998). Public water in the community is derived exclusively from ground water. The extended recharge zone for the community well fields is also a water supply source in the community. Other resources in the community include regionally important sand and gravel glacial outwash aquifers, public beaches, shellfish habitat in shallow surface waters, nutrient-sensitive surface waters, low-yield glacial till aquifers, and other surface waters used as secondary recreational waters.

Through public meetings, the community identified and ranked the various water resources according to their perceived value. After ranking, the vulnerability of each resource to pollution from onsite treatment systems was estimated. The vulnerability ratings were based on the thickness of the unsaturated zone in the soil, the rate of water movement through the soil, and the capability of the soil to attenuate pollutants (table 3-25). For each rating, a control zone designation was assigned (R5, R4, R3, R2, or R1). The criteria used for the vulnerability ratings were documented in the community's wastewater management plan. Control measures were established for each control zone. In this instance, specific wastewater treatment trains were prescribed for use in each control zone based on the depth of the unsaturated soil zone (tables 3-26 and 3-27). The treatment standards are TS1 = primary treatment, TS2 = secondary treatment, TS3 = tertiary treatment, TS4 = nutrient reduction, and TS5 = tertiary treatment with disinfection.

Important criteria considered include the thickness of the unsaturated soil layer and the properties of the soil. The vulnerability assessment matrix (table 3-26) identifies areas of low, moderate, high, or extreme vulnerability depending on soil conditions. For example, vulnerability might be "extreme" for coarse or sandy soils with less than 2 feet of vertical separation between the ground surface and the water table or bedrock. Vulnerability might be "low" for clay-loam soils with a vertical separation of greater than 6 feet and low permeability. Each resource specified in the first part of the risk assessment process can be associated with each vulnerability category. A more detailed discussion of ground water vulnerability assessment is provided in *Groundwater Vulnerability Assessment: Predicting Relative Contamination Potential under Conditions of Uncertainty* (National Research Council, 1993).

The third and final part of the risk assessment process is developing a management matrix that specifies a control measure for each vulnerability category relative to each resource (tables 3-27, 3-28). Several categories of management control measures (e.g., stricter performance requirements for OWTs) might be referenced depending on the value and vulnerability of the resource. Generally, each management control measure would define

- Management entity requirements for each control measure

- System performance and resource impact monitoring requirements for each vulnerable category
- Types of acceptable control measures based on the vulnerability and value of the resource
- Siting flexibility allowed for each control measure
- Performance monitoring requirements for each control measure and vulnerability category

### Probability of impact approach

Otis (1999) has proposed a simplified "probability of environmental impact" approach. This method was developed for use when resource data are insufficient and mapping data are unavailable for a more rigorous assessment. The approach is presented in the form of a decision tree that considers mass loadings to the receiving environment (ground water or surface water), population density, and the fate and transport of potential pollutants to a point of use (see following case study and figure 3-14). The decision tree (figure 3-14) estimates the relative probability of water resource impacts from wastewater discharges generated by sources in the watershed. Depending on the existing or expected use of the water resource, discharge standards for the treatment systems can be established. The system designer can use these discharge standards to assemble an appropriate treatment train.



### Establishing performance requirements by assessing the probability of impact

The “probability of impact” method estimates the probability that treated water discharged from an onsite system will reach an existing or future point of use in an identified water resource. By considering the relative probability of impact based on existing water quality standards (e.g., drinking water, shellfish water, recreational water), acceptable treatment performance standards can be established. The pollutants and their concentrations or mass limits to be stipulated in the performance requirements will vary with the relative probability of impact estimated, the potential use of the water resource, and the fate and transport characteristics of the pollutant.

As an example, the assessment indicates that a ground water supply well that provides water for drinking without treatment might be adversely affected by an onsite system discharge. Soils are assumed to be of acceptable texture and structure, with a soil depth of 3 feet. Nitrate-nitrogen and fecal coliforms are two wastewater pollutants that should be addressed by the performance requirements for the treatment system (i.e., constructed components plus soil). With a relative probability of impact estimated to be “high,” the regulatory authority considers it reasonable to require the treatment system to achieve drinking water standards for nitrate and fecal coliforms before discharge to the saturated zone. The drinking water standards for nitrate and fecal coliforms in drinking water are 10 mg/L for nitrate and zero for fecal coliforms. Considering the fate of nitrogen in the soil, it can be expected that any of the nitrogen discharged by the pretreatment system will be converted to nitrate in the unsaturated zone of the soil except for 2 to 3 mg/L of refractory organic nitrogen. Because nitrate is very soluble and conditions for biological denitrification in the soil cannot be relied on, the performance standard for the onsite system is 12 mg/L of total nitrogen (10 mg/L of nitrite + 2 mg/L of refractory organic nitrogen) prior to soil discharge. In the case of fecal coliforms, the natural soil is very effective in removing fecal indicators where greater than 2 feet of unsaturated natural soil is present. Therefore, no fecal coliform standard is placed on the pretreatment (i.e., constructed) system discharge because the standard will be met after soil treatment and before final discharge to the saturated zone.

If the probability of impact is estimated to be “moderate” or “low,” only the nitrogen treatment standard would change. If the probability of impact is “moderate” because travel time to the point of use is long, dispersion and dilution of the nitrate in the ground water is expected to reduce the concentration in the discharge substantially. Therefore, the treatment standard for total nitrogen can be safely raised, perhaps to 20 to 30 mg/L of nitrogen. If the probability of impact is “low,” no treatment standard for nitrogen is necessary.

If the probability of impact is “high” but the point of ground water use at risk is an agricultural irrigation well, no specific pollutants in residential wastewater are of concern. Therefore, the treatment required need be no more than that provided by a septic tank.

*Source: Otis, 1999.*

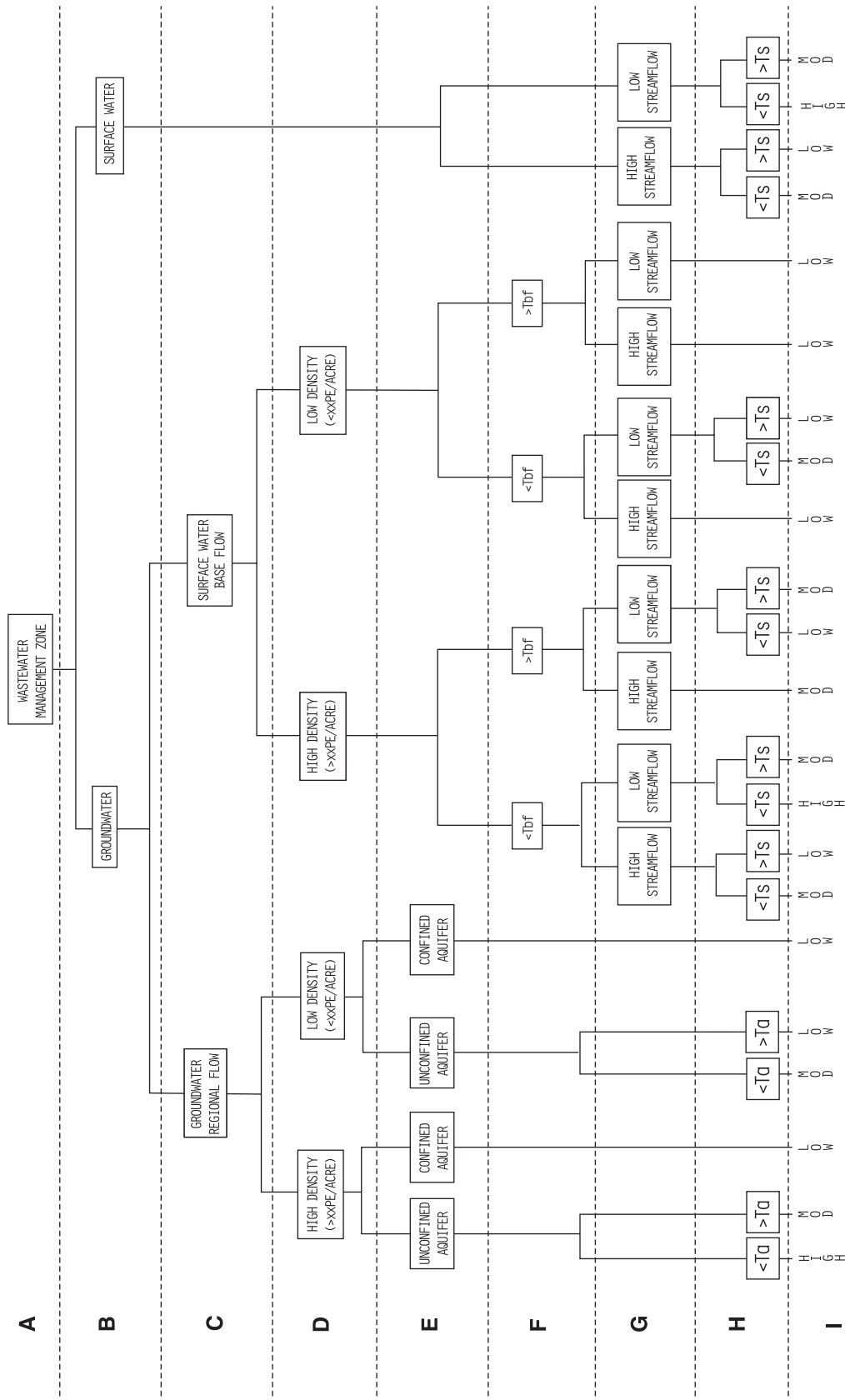
waters. For example, the mass balance equation used to predict nitrate-nitrogen (or other soluble pollutant) concentrations in ground water and surface waters is

As the examples above indicate, there are a wide range of approaches for assessing water resource vulnerability and susceptibility to impacts from

$$\text{Nitrate-nitrogen (mg/L)} = \frac{\text{Annual nitrogen loading from all sources in lb/yr} \times 454,000 \text{ mg/lb}}{\text{Annual water recharge volume from all sources in liters}}$$

onsite wastewater treatment systems. Other methodologies include risk matrices similar to those summarized above and complex contaminant transport models, including Qual2E, SWMM, and BASINS, the EPA-developed methodology for integrating point and nonpoint source pollution assessments (see <http://www.epa.gov/ow/compedium/toc.htm> for more information on BASINS and other water quality modeling programs).

Figure 3-14. Probability of environmental impact decision tree (see key)



Source: Otis, 1999.



Environmental sensitivity assessment key (for figure 3-14).

A	<p><b>Wastewater management zone</b> Includes the entire service area of the district.</p>
B	<p><b>Receiving environment</b> Receiving water to which the wastewater is discharged.</p>
C	<p><b>Fate of ground water discharge</b> The treated discharge to ground water may enter the regional flow or become base flow to surface water. Ground water flow direction can be roughly estimated from ground surface topography if other sources of information are not available. In some instances both regional flow and base flow routes should be assessed to determine the controlling point of use.</p>
D	<p><b>Planning area density (population equivalents per acre)</b> The risk of higher contaminate concentrations in the ground water from ground water-discharging treatment facilities will increase with increasing numbers of people served. Where building lots are served by individual infiltration systems, the population served divided by the total area composed by contiguous existing and planned lots would determine population equivalents per acre (p.e./acre). For a large cluster system, the p.e./acre would be determined by the population served divided by the area of the infiltration surface of the cluster system.</p>
E	<p><b>Well construction</b> Wells developed in an unconfined aquifer with direct hydraulic connections to the wastewater discharge have a higher probability of impact from the wastewater discharge than wells developed in a confined aquifer. Wells that are considered within the zone of influence from the wastewater discharge should be identified and their construction determined from well logs.</p>
F	<p><b>Travel time to base flow discharge, <math>T_{bf}</math></b> Treated wastewater discharges in ground water can affect surface waters through base flow. The potential impacts of base flows are inversely proportional to the travel time in the ground water, <math>T_{bf}</math>, because of the dispersion and dilution (except in karst areas) that will occur. Where aquifer characteristics necessary to estimate travel times are unknown, distance can be substituted as a measure. If travel time, <math>T_{bf}</math>, is greater than time to a ground water point of use, <math>T_a</math>, the ground water should be assumed to be the receiving environment.</p>
G	<p><b>Stream flow</b> Stream flow will provide dilution of the wastewater discharges. The mixing and dilution provided are directly proportional to the stream flow. Stream flow could be based on the 7-day, 10-year low-flow condition (<math>{}_7Q_{10}</math>) as a worst case. "High" and "low" stream flow values would be defined by the ratio of the <math>{}_7Q_{10}</math> to the daily wastewater discharge. For example, ratios greater than 100:1 might be "high," whereas those less than 100:1 might be "low." Stream flow based on the watershed area might also be used (cfs/acre).</p>
H	<p><b>Travel time to aquifer or surface water point of use, <math>T_a</math> or <math>T_s</math></b> The potential impacts of wastewater discharges on points of use (wells, coastal embayments, recreational areas, etc.) are inversely proportional to the travel time. Except for karst areas, distance could be used as a substitute for travel time if aquifer or stream characteristics necessary to estimate travel times are unknown.</p>
I	<p><b>Relative probability of impact</b> The relative probability of impact is a qualitative estimate of expected impact from a wastewater discharge on a point of use. The risk posed by the impact will vary with the intended use of the water resource and the nature of contaminants of concern.</p>

Source: Otis, 1999.

### Estimating nitrogen loadings and impacts for Buttermilk Bay, Massachusetts

In Buttermilk Bay, a 530-acre shallow coastal bay at the northern end of Buzzards Bay in Massachusetts, elevated nitrogen levels associated with onsite systems and land use in the watershed have contributed to nuisance algal growth and declines in eelgrass beds in some areas. An investigation in the early 1990s supported by the New England Interstate Water Pollution Control Commission and USEPA established a critical (maximum allowable) nitrogen loading rate of 115,600 pounds per year by identifying an appropriate ecological effects threshold (the nitrogen concentration associated with significant ecological impacts, or 0.24 mg/L in nitrogen-sensitive Buttermilk Bay) and considering both the size and recharge rate of the bay:

**Critical Loading Rate (pounds per year) =**

Threshold nitrogen concentration x volume x number of annual water body recharges =  
 240 milligrams of N per cubic meter x 2,996,000 cubic meters x 73 annual recharges =  
 52,489,920,000 milligrams of N / 454,000 milligrams in one pound =

**115,617 pounds per year = critical loading rate for nitrogen**

After establishing the critical nitrogen loading rate, the watershed assessment team sought to quantify annual nitrogen loads discharged to the bay under existing conditions. Loading values for various sources of nitrogen in the watershed were estimated and are presented in table 3-29. For the purposes of estimating nitrogen contributions from onsite systems, it was assumed that the total nitrogen concentration in onsite treated effluent was 40 mg/L and the per capita flow was 55 gallons per day. [It should be noted that nitrogen concentrations in onsite system treated effluent commonly range between 25 and 45 mg/L for soil-based systems, though some researcher have found higher effluent concentrations. In general, SWIS nitrogen removal rates range between 10 and 20 percent (Van Cuyk et al., 2001) for soil-based systems. Mechanized systems designed for nitrogen removal can achieve final effluent N concentrations as low as 10-25 mg/L.]

Using the research-based assumptions and estimates summarized in the table, the assessment team estimated that total current nitrogen loadings totaled about 91,053 lb/yr. Onsite wastewater treatment systems represented a significant source (74 percent) of the overall nitrogen input, followed by lawn fertilizers (15 percent) and cranberry bogs (7 percent).

The final part of the Buttermilk Bay analysis involved projecting the impact of residential build-out on nitrogen loads to the bay. With a critical (maximum allowable) nitrogen loading rate of 115,617 lb/yr and an existing loading rate of 91,053 lb/yr, planners had only a 24,564 lb/yr cushion with which to work. Full residential build-out projections generated nitrogen loading rates that ranged from 96,800 lb/yr to 157,500 lb/yr. Regional planners used this information to consider approaches for limiting nitrogen loadings to a level that could be safely assimilated by the bay. Among a variety of options that could be considered under this scenario are increasing performance requirements for onsite systems, decreasing system densities, limiting the total number of new residences with onsite systems in the bay watershed, and reducing nitrogen inputs from other sources (e.g., lawn fertilizers, cranberry bogs).

**Table 3-29. Nitrogen loading values used in the Buttermilk Bay assessment**

Nitrogen source	Nitrogen concentration	Loading rate	Flow/recharge	Total loading
Onsite wastewater systems	40 mg/L	6.72 lb N/person/yr	55 gal/person/day (165 gal/dwelling)	66,940 lb
Fertilizers—lawns	NA	0.9 lb N /1000 ft <sup>2</sup> /yr	18 in./yr	13,721 lb
Fertilizers—cranberry bogs	NA	15.8 lb N/1000 ft <sup>2</sup> /yr	NA	6,378 lb
Pavement runoff	2.0 mg/L	0.42 lb N/1000 ft <sup>2</sup> /yr	40 in./year	1,723 lb
Roof runoff	0.75 mg/L	0.15 lb N/1000 ft <sup>2</sup> /yr	40 in./year	686 lb
Atmospheric deposition	0.3 mg DIN/L	3.03 lb N/acre	NA	1,606 lb
<b>Total</b>				<b>91,053 lb</b>

NA = not available.

Source: Horsley Witten Hegemann, 1991, after Nelson et al., 1988.

### 3.8.2 Establishing narrative or numerical performance requirements

Performance requirements should reflect acceptable environmental impacts and public health risks based on assessment methods such as those described in the preceding section. They should specify observable or measurable requirements in narrative or numerical form. Conventional onsite treatment systems (septic tanks with SWISs) have used narrative requirements such as prohibitions on wastewater backup in plumbing fixtures or effluent pooling on the ground surface. These requirements are measurable through observation but address only some specific public health issues. An example of a narrative performance requirement that addresses potential environmental impacts is the Town of Shoreham's requirement for specifically approved treatment trains for environmentally sensitive areas (see sidebar and table 3-26 in preceding section). Compliance is determined by whether the required treatment processes are in place; water quality monitoring is not involved. The regulating agencies assume that the water quality objectives are achieved if these narrative performance requirements are met. Although there is merit in this approach, some additional steps (e.g., operation and maintenance monitoring, targeted water quality monitoring) would be included in a more comprehensive program.

Numerical performance requirements specify the critical parameters of concern (e.g., nitrate, phosphorus, fecal coliforms), the maximum allowable concentration or mass pollutant/flow discharge permitted per day, and the point at which the requirements apply. Examples of numerical performance requirements include Massachusetts' requirement for limited volume discharges (measured in gallons per day) in designated nitrogen-sensitive areas or a water quality standard for nitrogen of 25 mg/L, to be met at the property boundary. Unlike the narrative requirements, numerical performance requirements provide more assurance that the public health and water quality goals are being met.

### 3.9 Monitoring system operation and performance

Performance monitoring of onsite treatment systems serves several purposes. Its primary purpose is to ensure that treatment systems are operated and maintained in compliance with the performance requirements. It also provides performance data useful in making corrective action decisions and evaluating areawide environmental impacts for land use and wastewater planning. Historically, performance monitoring of onsite treatment systems has not been required. Regulatory agencies typically limit their regulatory

#### Onsite system inspection/maintenance guidance for Rhode Island

The Rhode Island Department of Environmental Management published in 2000 the *Septic System Checkup*, an inclusive guide to inspecting and maintaining septic systems. The handbook, available to the public, is written for both lay people and professionals in the field. The guide is an easy-to-understand, detailed protocol for inspection and maintenance and includes newly developed state standards for septic system inspection and maintenance. It describes two types of inspections: a maintenance inspection to determine the need for pumping and minor repairs, and a functional inspection for use during property transfers. The handbook also includes detailed instructions for locating septic system components, diagnosing in-home plumbing problems, flow testing and dye tracing, and scheduling inspections. Several Rhode Island communities, including New Shoreham, North Kingstown and Glocester, currently use *Septic System Checkup* as their inspection standard. The University of Rhode Island offers a training course for professionals interested in becoming certified in the inspection procedures.

The handbook is available free on-line at <http://www.state.ri.us/dem/regs/water/isdsbook.pdf>. Individual spiral-bound copies can be purchased for \$10 with inspection report forms or \$7 for the manual without forms from DEM's Office of Technical and Customer Assistance at 401.222.6822.

Source: Rhode Island Department of Environmental Management.

control primarily to system siting, design, and construction and certification of site evaluators, designers, and other service providers. System performance is largely ignored by the regulatory authority or management entity or addressed through sometimes weak owner education and voluntary compliance programs until a hydraulic failure is reported or observed (see chapters 2 and 5).

OWTS oversight agencies typically exert regulatory control by conducting the site evaluation and reviewing the proposed design for compliance with administrative code prescriptions for proven systems. If the site characteristics and selected system design meet the prescriptions in the code, a construction permit is issued for installation by a certified contractor. The regulatory authority or management entity usually performs a pre-coverup inspection before final approval is given to use the system. At that point the regulatory authority typically relinquishes any further oversight of the system until a hydraulic failure is observed or reported. The owner may be given educational materials and instructions describing the system and what maintenance should be performed, but routine operation and maintenance is left up to the owner. Tank pumping or other routine maintenance tasks are seldom required or even tracked by the regulatory authority or management entity for information purposes. Regular inspections of systems are usually not mandated.

This regulatory approach might be adequate for the degree of risk to human health and the environment posed by isolated and occasional hydraulic failures. Where onsite treatment is used in moderate-to-high-density suburban and seasonal developments, however, it has not proven to be adequate, particularly where treatment failures can be expected to significantly affect ground water and surface water quality. Onsite system failure rates across the nation range as high as 10 percent or more in some areas (see Section 1.3). In cases where high system densities or system age indicates the likelihood of ground or surface water contamination, incorporation of mandated performance monitoring into OWTS management programs is strongly recommended. In 2000 USEPA issued suggested guidelines for onsite system management programs. *Draft Guidelines for Management of Onsite/Decentralized Wastewater Systems* (USEPA, 2000b) provides an excellent framework for developing a

comprehensive management program that considers the full range of issues involved in OWTS planning, siting, design, installation, operation, maintenance, monitoring, and remediation (see chapter 2).

Local OWTS regulatory and management agencies in many areas are embracing more rigorous operation, maintenance, and inspection programs to deal with problems caused by aging systems serving developments built before 1970, poor maintenance due to homeowner indifference or ignorance, and regional hydraulic or pollutant overloads related to high-density OWTS installations. Operation and maintenance management programs adopted by these agencies consist mostly of an integrated performance assurance system that inventories new and existing systems, establishes monitoring or inspection approaches, requires action when systems fail to operate properly, and tracks all activities to ensure accountability among regulatory program staff and system owners. (See chapter 2 and *Draft Guidelines for Management of Onsite/Decentralized Wastewater Systems* at <http://www.epa.gov/owm/decent/index.htm> for more information and examples.)

### 3.9.1 Operating permits

Periodic review of system performance is necessary to ensure that systems remain in compliance with established performance requirements after they are installed. Thus, regulatory agencies need to maintain rigorous, perpetual oversight of systems to ensure periodic tank pumping, maintenance of system components, and prompt response to problems that may present threats to human health or water resources. Some jurisdictions are fulfilling this responsibility by issuing renewable/revocable operating permits. The permit stipulates conditions that the system must meet before the permit can be renewed (see sidebar). The duration of such permits might vary. For example, shorter-term permits might be issued for complex treatment systems that require more operator attention or to technologies that are less proven (or with which the regulatory authority has less comfort). The owner is responsible for documenting and certifying that permit conditions have been met. If permit conditions have not been met, a temporary permit containing a compliance schedule for taking appropriate actions may be issued. Failure to meet the compliance schedule can result in fines or penalties.



### Onsite system operating permits in St. Louis County, Minnesota

St. Louis County, located in the northeastern region of Minnesota, extends from the southwestern tip of Lake Superior north to the Canadian border. The physical characteristics of the region are poorly suited for application of traditional onsite treatment systems. Many of the soils are very slowly permeable lacustrine clays, shallow to bedrock, and often near saturation. The existing state minimum code restricts onsite systems to sites featuring permeable soils with sufficient unsaturated depths to maintain a 3-foot separation distance to the saturated zone. To allow the use of onsite treatment, the county has adopted performance requirements that may be followed in lieu of the prescriptive requirements where less than 3 feet of unsaturated, permeable soils are present. In such cases the county requires that the owner continuously demonstrate and certify that the system is meeting the performance requirements. This is achieved through the issuance of renewable operating permits for higher-performance alternative treatment systems. The operating permit is based on evaluation of system performance rather than design prescription and includes the following:

- ✓ System description
- ✓ Environmental description
- ✓ Site evaluation documentation
- ✓ Performance requirements
- ✓ System design, construction plan, specifications, and construction drawings
- ✓ Maintenance requirements
- ✓ Monitoring requirements (frequency, protocol, and reporting)
- ✓ Contingency plan to be implemented if the system fails to perform to requirements
- ✓ Enforcement and penalty provisions

The permit is issued for a limited term, typically 5 years. Renewal requires that the owner document that the permit requirements have been met. If the documentation is not provided, a temporary permit is issued with a compliance schedule. If the compliance schedule is not met, the county has the option of reissuing the temporary permit and/or assessing penalties. The permit program is self-supporting through permit fees.

### 3.9.2 Monitoring programs

Monitoring individual or regional onsite system performance may include performance inspections (see Chapter 2 and *Draft Management Guidelines for Onsite/Decentralized Wastewater Systems*), water quality sampling at performance boundaries, drinking water well monitoring, and assessment of problem pollutant concentrations (pathogens, nitrate, phosphorus) in nearby surface waters. In general, monitoring of system performance seeks to ascertain if onsite systems are meeting performance requirements, i.e., protecting public health and water quality. Assessing the sensitivity of water resources to potential pollutant loadings from onsite systems helps in developing performance requirements and the monitoring methods and sampling locations that might be used.

Monitoring system performance through water quality sampling is difficult for conventional onsite

systems because the infiltration field and underlying soil are part of the treatment system. The percolate that enters the ground water from the infiltration system does not readily mix and disperse in the ground water. It can remain as a distinct, narrow plume for extended distances from the system (Robertson et al., 1991). Locating this plume for water quality sampling is extremely difficult, and the cost involved probably does not warrant this type of monitoring except for large systems that serve many households or commercial systems constructed over or near sensitive ground water and surface water resources (see chapter 5). Monitoring of onsite treatment systems is enhanced considerably by the inclusion of inspection and sampling ports at performance boundaries (e.g., between treatment unit components) and the final discharge point. Other methods of monitoring such as simple inspections of treatment system operation or documentation of required system maintenance



### Monitoring requirements in Washington

The Department of Health of the state of Washington has adopted a number of monitoring requirements that OWTS owners must meet (Washington Department of Health, 1994). Because such requirements place additional oversight responsibilities on management agencies, additional resources are needed to ensure compliance. Among the requirements are the following:

The system owner is responsible for properly operating and maintaining the system and must

- Determine the level of solids and scum in the septic tank once every 3 years.
- Employ an approved pumping service provider to remove the septage from the tank when the level of solids and scum indicates that removal is necessary.
- Protect the system area and the reserve area from cover by structures or impervious material, surface drainage, soil compaction (for example, by vehicular traffic or livestock), and damage by soil removal and grade alteration.
- Keep the flow of sewage to the system at or below the approved design both in quantity and waste strength.
- Operate and maintain alternative systems as directed by the local health officer.
- Direct drains, such as footing or roof drains away from the area where the system is located.

Local health officers in Washington also perform monitoring duties, including the following:

- Providing operation and maintenance information to the system owner upon approval of any installation, repair, or alteration of a system.
- Developing and implementing plans to monitor all system performance within areas of special concern<sup>1</sup>; initiating periodic monitoring of each system by no later than January 1, 2000, to ensure that each system owner properly maintains and operates the system in accordance with applicable operation and maintenance requirements; disseminating relevant operation and maintenance information to system owners through effective means routinely and upon request; and assisting in distributing educational materials to system owners.

Finally, local health officers may require the owner of the system to perform specified monitoring, operation, or maintenance tasks, including the following:

- Using one or more of the following management methods or another method consistent with the following management methods for proper operation and maintenance: obtain and comply with the conditions of a renewable or operational permit; employ a public entity eligible under Washington state statutes to directly or indirectly manage the onsite system; or employ a private management entity, guaranteed by a public entity eligible under Washington state statutes or sufficient financial resources, to manage the onsite system.
- Evaluating any effects the onsite system might have on ground water or surface water.
- Dedicating easements for inspections, maintenance, and potential future expansion of the onsite system.

<sup>1</sup> "Areas of special concern" are areas where the health officer or department determines additional requirements might be necessary to reduce system failures or minimize potential impacts upon public health. Examples include shellfish habitat, sole source aquifers, public water supply protection areas, watersheds of recreational waters, wetlands used in food production, and areas that are frequently flooded.

Source: *Washington Department of Health, 1994.*

might be sufficient and more cost-effective than water quality sampling at a performance boundary.

The Critical Point Monitoring (CPM) approach being developed in Washington State provides a systematic approach to choosing critical locations to monitor specific water quality parameters

(Eliasson et al., 2001). The program is most suitable for responsible management entities operating comprehensive management programs. CPM provides an appropriate framework for monitoring treatment train components, though it should be recognized that evaluations of overall system effectiveness—and compliance with

### State of Massachusetts' onsite treatment system inspection program

Massachusetts in 1996 mandated inspections of OWTs to identify and address problems posed by failing systems (310 CMR 15.300, 1996). The intent of the program is to ensure the proper operation and maintenance of all systems. A significant part of the program is the annual production of educational materials for distribution to the public describing the importance of proper maintenance and operation of onsite systems and the impact systems can have on public health and the environment.

Inspections are required at the time of property transfer, a change in use of the building, or an increase in discharges to the system. Systems with design flows equal to or greater than 10,000 gpd require annual inspections. Inspections are to be performed only by persons approved by the state. The inspection criteria are established by code and must include

- ✓ A general description of system components, their physical layout, and horizontal setback distances from property lines, buildings, wells, and surface waters.
- ✓ Description of the type of wastewater processed by the system (domestic, commercial, or industrial).
- ✓ System design flow and daily water use, if metered.
- ✓ Description of the septic tank, including age, size, internal and external condition, water level, etc.
- ✓ Description of distribution box, dosing siphon, or distribution pump, including evidence of solids carryover, clear water infiltration, and equal flow division, and evidence of backup, if any.
- ✓ Description of the infiltration system, including signs of hydraulic failure, condition of surface vegetation, level of ponding above the infiltration surface, other sources of hydraulic loading, depth to seasonally high water table, etc.

A system is deemed to be failing to protect public health, safety, and the environment if the septic tank is made of steel, if the OWTs is found to be backing up, if it is discharging directly or indirectly onto the surface of the ground, if the infiltration system elevation is below the high ground water level elevation, or if the system components encroach on established horizontal setback distances.

The owner must make the appropriate upgrades to the system within 2 years of discovery. The owner's failure to have the system inspected as required or to make the necessary repairs constitutes a violation of the code.

*Source: Title V, Massachusetts Environmental Code.*

performance requirements—should be based on monitoring *at the performance boundaries* (see chapter 5).

#### Elements of a monitoring program

Any monitoring program should be developed carefully to ensure that its components consider public health and water quality objectives, regulatory authority / management entity administrative and operational capacity, and the local political, social, and economic climate. Critical elements for a monitoring program include

- Clear definition of the parameters to be monitored and measurable standards against which the monitoring results will be compared.
- Strict protocols that identify when, where, and how monitoring will be done, how results will

be analyzed, the format in which the results will be presented, and how data will be stored.

- Quality assurance and quality control measures that should be followed to ensure credible data.

#### System inspections

Mandatory inspections are an effective method for identifying system failures or systems in need of corrective actions. Inspections may be required at regular intervals, at times of property transfer or changes in use of the property, or as a condition to obtain a building permit for remodeling or expansion. Twenty-three states now require some form of inspection for existing OWTs (NSFC, 1999). The OWTs regulatory authority or management entity

### Effluent quality requirements in Minnesota

St. Louis County, Minnesota, has established effluent standards for onsite systems installed on sites that do not have soils meeting the state's minimum requirements. Many of the soils in the county do not meet the minimum 3-foot unsaturated soil depth required by the state code. To allow for development the county has adopted a performance code that establishes effluent requirements for systems installed where the minimums cannot be met. Where the natural soil has an unsaturated depth of less than 3 feet but more than 1 foot, the effluent discharged to the soil must have no more than 10,000 fecal coliform colonies per 100 mL. On sites with 1 foot of unsaturated soil or less, the effluent must have no more than 200 fecal coliform colonies per 100 mL. These effluent limits are monitored prior to final discharge at the infiltrative surface but recognize treatment provided by the soil. If hydraulic failure occurs, the county considers the potential risk within acceptable limits. The expectation is that any discharges to the surface will meet at least the primary contact water quality requirements of 200 fecal coliform colonies per 100 mL. Other requirements, such as nutrient limitations, may be established for systems installed in environmentally sensitive areas.

### Documenting wastewater migration to streams in Northern Virginia

The Northern Virginia Planning District Commission uses commercially available ultraviolet light bulbs and cotton swatches to screen for possible migration of residential wastewater into area streams. The methodology is based on the presence of optical brighteners in laundry detergents, which are invisible to the naked eye but glow under "black" lights. The brighteners are very stable in the environment and are added to most laundry soaps. They are readily absorbed onto cotton balls or cloth swatches, which can be left in the field for up to two weeks. Users must ensure that the absorbent medium is free from optical brighteners prior to use.

Although the methodology is acceptable for screening-level analysis, it does not detect wastewater inputs from buildings that do not have laundry facilities and does not verify the presence of other potential contaminants (e.g., bacteria, nitrogen compounds). Despite these shortcomings, the approach is inexpensive, effective, and a good tool for screening and public education.

*Source: Northern Virginia Regional Commission, 1999.*

should collect information on new systems (system owner, contact information, system type, location, design life and capacity, recommended service schedule) at the time of permitting and installation. Inventories of existing systems can be developed by consulting wastewater treatment plant service area maps, identifying areas not served by publicly owned treatment works (POTWs), and working with public and private utilities (drinking water, electricity, and solid waste service providers) to develop a database of residents and contact information. Telephone, door-to-door, or mail surveys can be used to gather information on system type, tank capacity, installation date, last date of service (e.g., pumping, repair), problem incidents, and other relevant information.

Minnesota, Massachusetts, Wisconsin, and a number of counties and other jurisdictions require disclosure of system condition or assurances that

they are functioning properly at the time of property transfer (see sidebar). Assurances are often in the form of inspection certificates issued by county health departments, which have regulatory jurisdiction over OWTs. Clermont County, Ohio, developed an OWTs owner database by cross-referencing water line and sewer service customers. Contact information from the database was used for a mass mailing of information on system operation and maintenance and the county's new inspection program to 70 percent of the target audience. Other approaches used in the Clermont County outreach program included advisory groups, homeowner education meetings, news media releases and interview programs, meetings with real estate agents, presentations at farm bureau meetings, displays at public events, and targeted publications (Caudill, 1998).

### Biochemical application of a bacterial source tracking methodology

Researchers from Virginia Tech analyzed antibiotic resistance in fecal streptococci to determine the sources of bacteria found in streams in rural Virginia. The team first developed a database of antibiotic resistance patterns for 7,058 fecal streptococcus isolates from known human, livestock, and wildlife sources in Montgomery County, Virginia. Correct fecal streptococcus source identification averaged 87 percent for the entire database and ranged from 84 percent for deer isolates to 93 percent for human isolates. A field test of the database yielded an overall bacteria source accuracy rate of 88 percent, with an accuracy rate of at least 95 percent for differentiation between human and animal sources.

The approach was applied to a watershed improvement project on Page Brook in Clarke County, Virginia, to determine the impacts of a cattle exclusion fencing and alternative stock watering project. Pre-project bacterial analyses showed heavy bacteria contamination from cattle sources (more than 78 percent), with smaller proportions from waterfowl, deer, and unidentified sources (about 7 percent each). After the fencing and alternative stock watering stations were installed, fecal coliform levels from all sources declined by an average of 94 percent, from 15,900/100 mL to 960/100 mL. Analysis of bacteria conducted after the project also found that cattle-linked isolates decreased to less than 45 percent of the total.

*Source: Hagedorn et al., 1999.*

The Town of Shoreham, Rhode Island, adopted a similar inspection program by ordinance in 1996 (Loomis et al., 1999). The ordinance mandates regular inspection of all systems by a town inspector. Septage pumping schedules and other maintenance requirements are based on the results of the inspection. Factors considered in the inspections include site characteristics, system technology and design, system use, and condition. The ordinance allows the town to prioritize inspection schedules in critical resource areas such as public wellheads and high-risk areas determined to be prone to onsite system failure. It also authorizes the town to assess fees, levy fines, and track the inspections.

### Prescribed maintenance

Where specific unit processes or treatment trains have satisfactorily demonstrated reliable performance through a credible testing program, some programs assume that identical processes or treatment trains will perform similarly if installed under similar site-specific conditions. The system would need to be managed according to requirements of the designer/manufacture as outlined in the operation and maintenance manual to maximize the potential for assured performance. Therefore, some states monitor system maintenance as an alternative to water quality-based performance monitoring. The method of monitoring varies. In several states the owner must contract with the equipment manufacturer or certified operator to provide

operation and maintenance services. If the owner severs the contract, the contractor is obligated to notify the state regulatory authority or other management entity. Failure to maintain a contract with an operator is a violation of the law. Other states require that the owner provide certified documentation that required maintenance has been performed in accordance with the system management plan. Requiring the owner to provide periodic documentation helps to reinforce the notion that the owner is responsible for the performance of the system. Chapter 2 provides additional information on prescriptive and other approaches to monitoring, operation, and maintenance.

### Water quality sampling and bacterial source tracking

OWTS effluent quality sampling is a rigorous and expensive method of onsite system compliance monitoring. Such programs require that certain water quality criteria be met at designated locations after each treatment unit (see chapter 5). Sampling pretreated effluent before discharge to the soil requires an assumption of the degree of treatment that will occur in the soil. Therefore, the performance requirements used to determine compliance should be adjusted to credit soil treatment. Unfortunately, some incomplete or inaccurate data equate travel time in all types of soil to pollutant removals under various conditions. Even when better data are available, it is often difficult to match condi-

tions at the site from which the data were derived to the soils, geology, water resources, slopes, topography, climate, and other conditions present at the site under consideration. Effluent monitoring should be undertaken only when the potential risk to human health and the environment from system failure is great enough to warrant the cost of sampling and analysis or when assessment information is needed to establish performance requirements or identify technologies capable of protecting valued water resources.

Ground water sampling is the most direct method of compliance monitoring. However, because of the difficulty of locating monitoring wells in the effluent plume it has historically been used only for compliance monitoring of large infiltration systems. If performance standards are to be used in the future, ground water monitoring will become more commonplace despite its cost because it is the only true determinant of compliance with risk assessment criteria and values. Installing small-diameter drop tubes at various depths at strategic downgradient locations can provide a cost-effective approach for continuous sampling.

Monitoring of the unsaturated zone has been conducted as an alternative to ground water monitoring. This method avoids the problem of locating narrow contaminant plumes downgradient of the infiltration system, but allowances should be made in parameter limits to account for dispersion and treatment that could occur in the saturated zone. To obtain samples, suction lysimeters are used. Porous cups are installed in the soil at the desired sample depth, and a vacuum is applied to extract the sample. This type of sampling works reasonably well for some dissolved inorganic chemical species but is not suitable for fecal indicators (Parizek and Lane, 1970; Peters and Healy, 1988). Use of this method should be based on a careful evaluation of whether the method is appropriate for the parameters to be monitored because it is extremely expensive and proper implementation requires highly skilled personnel.

Water quality sampling of lakes, rivers, streams, wetlands, and coastal embayments in areas served by OWTSs can provide information on potential resource impacts caused by onsite systems. Concentrations of nitrogen, phosphorus, total and fecal coliforms, and fecal streptococci are often mea-

sured to determine possible impacts from system effluent. Unless comprehensive source sampling that characterizes OWTS pollutant contributions is in place, however, it is usually difficult to attribute elevated measurements of these parameters directly to individual or clustered OWTSs. Despite this difficulty, high pollutant concentrations often generate public interest and provide the impetus necessary for remedial actions (e.g., tank pumping; voluntary water use reduction; comprehensive system inspections; system repairs, upgrades, replacements) that might be of significant benefit.

Tracer dye tests of individual systems, infrared photography, and thermal imaging are used in many jurisdictions to confirm direct movement of treated or partially treated wastewater into surface waters. Infrared and thermal photography can show areas of elevated temperature and increased chlorophyll concentrations from wastewater discharges. Areas with warmer water during cold months or high chlorophyll during warm months give cause for further investigation (Rouge River National Wet Weather Demonstration Project, 1998). The Arkansas Health Department has experimented with helicopter-mounted infrared imaging equipment to detect illicit discharges and failed systems around Lake Conway with some success (Eddy, 2000), though these and other monitoring approaches (e.g., using tracers such as surfactants, laundry whiteners, and caffeine) are not typical and are still undergoing technical review.

Recently, some success has been demonstrated by advanced bacterial source tracking (BST) methodologies, which identify bacteria sources (humans, cattle, dogs, cats, wildlife) through molecular or biochemical analysis. Molecular (genotype) assessments match bacteria collected at selected sampling points with bacteria from known mammalian sources using ribotype profiles, intergenetic DNA sequencing, ribosomal DNA genetic marker profile analyses, and other approaches (Bernhard and Field, 2000; Dombek et al., 2000; Parveen et al., 1999). Biochemical (phenotype) assessments of bacteria sources conduct similar comparisons through analysis of antibiotic resistance in known and unknown sources of fecal streptococci (Hagedorn et al., 1999), coliphage serological differentiation, nutritional pattern analysis, and other methods. In general, molecular methods seem to offer the most precise identification of specific



types of sources (animal species), but are costly, time-consuming, and not yet suitable for large-scale use. The precision of most biochemical approaches appears to be somewhat less than molecular methods, but analyte costs are lower, processing times are shorter, and large numbers of samples can be assayed in shorter time periods (Virginia Tech, 2001). It has been suggested that biochemical methods be used to screen large numbers of bacterial isolates for likely sources followed by an analysis of a subset of the isolates through molecular approaches to validate the findings. (For more information, see [http://www.bsi.vt.edu/biol\\_4684/BST/BST.html](http://www.bsi.vt.edu/biol_4684/BST/BST.html)).

Finally, some OWTS management agencies use fecal coliform/fecal streptococci (FC/FS) ratios as a screening tool to detect the migration of poorly treated effluent to inland surface waters. Under this approach, which is effective only if samples are taken near the source of contamination, the number of fecal coliforms in a sample volume is divided by the number of fecal streptococci in an equal sample volume. If the quotient is below 0.7, the bacteria sources are most likely animals. Quotients above 4.0 indicate a greater likelihood of human sources of bacteria, while values between 0.7 and 4.0 indicate a mix of human and animal sources. Several factors should be considered when using the FC/FS screening approach:

- Bacterial concentrations can be highly variable if the pH is outside the 4.0 to 9.0 range
- Faster die-off rates of fecal coliforms will alter the ratio as time and distance from contaminant sources increase
- Pollution from several sources can alter the ratio and confuse the findings
- Ratios are of limited value in assessing bays, estuaries, marine waters, and irrigation return waters

Sampling and analysis costs vary widely across the nation and are influenced by factors such as the number of samples to be collected and assessed, local business competition, and sample collection, handling, and transport details. Because of variability in price and the capacity of local agencies to handle sample collection, transport, and analysis, several cost estimates should be solicited. Some example analytical costs are provided in table 3-30.

**Table 3-30. Typical laboratory costs for water quality analysis**

Parameter	Cost range per sample (in dollars)	Typical cost per sample (in dollars)
BOD <sub>5</sub>	15–50	35
NO <sub>2</sub>	10–25	20
NO <sub>3</sub>	10–25	20
Fecal coliform	15–50	30
TKN	4–50	35
Total phosphorus	5–35	25
TSS	8–25	15

Source: Tetra Tech, 2000.

Because of the cost and difficulty of monitoring, underfunded management agencies have often opted to focus their limited resources on ensuring that existing systems are properly operated and maintained and new systems are appropriately planned, designed, installed, operated, and maintained. They have relied on limited water quality monitoring of regional ground water and surface waters to provide an indication of regional onsite system performance. Additional site-specific monitoring is recommended, however, where drinking water or valued surface water resources are threatened.

## References

- Aher, A., A. Chouthai, L. Chandrasekar, W. Corpening, L. Russ, and B. Vijapur. 1991, October. *East Bay Municipal Utility District Water Conservation Study*. Report no. R219. Prepared for East Bay Municipal Utility District, Oakland, California. Stevens Institute of Technology, Hoboken, NJ.
- Alhajjar, B.J., J.M. Harkin, and G. Chesters. 1989. Detergent formula and characteristics of wastewater in septic tanks. *Journal of the Water Pollution Control Federation* 61(5):605-613.
- Allen, L., T. Bennett, J.H. Lehr, and R.J. Petty. 1987. *DRASTIC: A Standardized System for Evaluating Ground Water Pollution Potential Using Hydrogeologic Settings*. EPA/600/2-85/018. U.S. Environmental Protection Agency, Kerr Environmental Research Laboratory, Ada, OK.

- Anderson, D.L., and R.L. Siegrist. 1989. The performance of ultra-low-volume flush toilets in Phoenix. *Journal of the American Water Works Association* 81(3):52-57.
- Anderson, D.L., A.L. Lewis, and K.M. Sherman. 1991. Human Enterovirus Monitoring at Onsite Sewage Disposal Systems in Florida. In *On-site Wastewater Treatment: Individual And Small Community Sewage Systems, Proceedings of the Sixth National Symposium on Individual and Small Community Sewage Systems*, December 16-17, 1991, Chicago, IL, pp. 94-104. American Society of Agricultural Engineers, St. Joseph, MI.
- Anderson, D.L., D.M. Mulville-Friel, and W.L. Nero. 1993. The Impact of Water Conserving Plumbing Fixtures On Residential Water Use Characteristics in Tampa, Florida. In *Proceedings of the Conserv93 Conference*, December 12-16, 1993, Las Vegas, Nevada.
- Anderson, D.L., R.J. Otis, J.I. McNeillie, and R.A. Apfel. 1994. In-situ Lysimeter Investigation of Pollutant Attenuation in the Vadose Zone of a Fine Sand. In *On-Site Wastewater Treatment: Proceedings of the Seventh International Symposium on Individual and Small Community Sewage Systems*. American Society of Agricultural Engineers, St. Joseph, MI.
- Anderson, J.R., E.E. Hardy, J.T. Roach, and R.E. Wimer, 1976. *A Land Use and Land Cover Classification System for Use with Remote Sensor Data*. Professional paper 964. U.S. Geological Survey, Reston, VA.
- Andreoli, A., N. Bartilucci, R. Forgiione, and R. Reynolds. 1979. Nitrogen removal in a subsurface disposal system. *Journal of the Water Pollution Control Federation* 51(4):841-854.
- Ayres Associates. 1989. *Onsite Sewage Disposal System Research in Florida: Performance Monitoring and Groundwater Quality Impacts of OSDs in Subdivision Developments*. Report to the Department of Health and Rehabilitative Services, Tallahassee, FL. Ayres Associates, Madison, WI.
- Ayres Associates. 1993a. *Onsite Sewage Disposal System Research in Florida: An Evaluation of Current OSD Practices in Florida*. Report to the Department of Health and Rehabilitative Services, Environmental Health Program, Tallahassee, FL. Ayres Associates, Madison, WI.
- Ayres Associates. 1993b. *An Investigation of the Surface Water Contamination Potential from On-Site Sewage Disposal Systems (OSDS) in the Turkey Creek Sub-Basin of the Indian River Lagoon*. Report to the Department of Health and Rehabilitative Services, Tallahassee, FL. Ayres Associates, Madison, WI.
- Ayres Associates. 1993c. *The Capability of Fine Sandy Soils for Septic Tank Effluent Treatment: A Field Investigation at an In-Situ Lysimeter Facility in Florida*. Report to the Florida Department of Health and Rehabilitative Services, Tallahassee, FL. Ayres Associates, Madison, WI.
- Bauer, D.H., E.T. Conrad, and D.G. Sherman. 1979. *Evaluation of On-Site Wastewater Treatment and Disposal Options*. U.S. Environmental Protection Agency, Cincinnati, OH.
- Bauman, B.J. 1989. Soils contaminated by motor fuels: research activities and perspectives of the American Petroleum Institute. In *Petroleum Contaminated Soils. Vol. I, Remediation Techniques, Environmental Fate, Risk Assessment*, ed. P.T. Kosteci and E.J. Calabrese, pp. 3-19. Lewis Publishers, Inc., Chelsea, MI.
- Bechdol, M.L., A.J. Gold, and J.H. Gorres. 1994. Modeling Viral Contamination from On-Site Wastewater Disposal in Coastal Watersheds. In *Onsite Wastewater Treatment: Proceedings of the Seventh International Symposium on Individual and Small Community Sewage Systems*, Atlanta, GA, December 11-13, 1993, pp. 146-153. American Society of Agricultural Engineers, St. Joseph, MI.
- Bennett, E.R., and E.K. Linstedt. 1975. *Individual Home Wastewater Characterization and Treatment*. Completion report series no. 66. Colorado State University, Environmental Resources Center, Fort Collins, CO.
- Bennett, S.M., J.A. Heidman, and J.R. Kreissl. 1977. *Feasibility of Treating Septic Tank Waste by Activated Sludge*. EPA/600-2-77/141.

- District of Columbia, Department of Environmental Services, Washington, DC.
- Berg, G. 1973. Microbiology-detection and occurrences of viruses. *Journal of the Water Pollution Control Federation* 45:1289-1294.
- Bernhard, A.E., and K.G. Field. 2000. Identification of nonpoint sources of fecal pollution in coastal waters by using host-specific 16S ribosomal DNA genetic markers from fecal anaerobes. *Applied and Environmental Microbiology* April 2000.
- Bicki, T.J., R.B. Brown, M.E. Collins, R.S. Mansell, and D.J. Rothwell. 1984. *Impact of On-Site Sewage Disposal Systems on Surface and Groundwater Quality*. Report to Florida Department of Health and Rehabilitative Services, Institute of Food and Agricultural Science, University of Florida, Gainesville, FL.
- Bitton, G., J.M. Davidson, and S.R. Farrah. 1979. On the value of soil columns for assessing the transport pattern of viruses through soil: A critical look. *Water, Air, and Soil Pollution* 12:449-457.
- Bouma, J., W.A. Ziebell, W.G. Walker, P.G. Olcott, E. McCoy, and F.D. Hole. 1972. *Soil Absorption of Septic Tank Effluent: A Field Study of Some Major Soils in Wisconsin*. Information circular no. 20. University of Wisconsin Extension Geological and Natural History Survey, Madison, WI.
- Brandes, M. 1972. *Studies on Subsurface Movement of Effluent from Private Sewage Disposal Systems Using Radioactive and Dye Traces*. Ontario Ministry of the Environment, Toronto, ON, Canada.
- Brown and Caldwell. 1984. *Residential Water Conservation Projects*. Research report 903. U.S. Department of Housing and Urban Development, Office of Policy Development, Washington, DC.
- Brown, K.W., J.F. Slowey, and H.W. Wolf. 1978. The Movement of Salts, Nutrients, Fecal Coliform and Virus Below Septic Leach Fields in Three Soils. In *Home Sewage Treatment, Proceedings of the Second National Home Sewage Treatment Symposium*, December 12-13, 1977, Chicago, IL, pp. 208-217. American Society of Agricultural Engineers, St. Joseph, MI.
- Burge, W.D., and N.D. Enkiri. 1978. Virus adsorption by fine soils. *Journal of Environmental Quality* 7:73-76.
- Burks, B.D., and M.M. Minnis. 1994. *Onsite Wastewater Treatment Systems*. Hogarth House, Madison, WI.
- Cantor, L.W., and R.C. Knox. 1985. *Septic Tank System Effects on Groundwater Quality*. Lewis Publishers listserve, Inc., Chelsea, MI.
- Carlile, B.L., C.G. Cogger, and S.J. Steinbeck. 1981. *Movement and Treatment of Effluent in Soils of the Lower Coastal Plain of North Carolina*. North Carolina State University, Department of Soil Science, Raleigh, NC.
- Caudill, J.R. 1998. Homeowner Education About Onsite Sewage Systems. In *Proceedings of the Seventh National Onsite Wastewater Recycling Association and Annual Conference*, October 1998, Northern Kentucky. National Onsite Wastewater Recycling Association. Laurel, MD.
- Chang, A.C. and A.L. Page. 1985. *Soil Deposition of Trace Metals During Groundwater Recharge Using Surface Spreading*. Chapter 21, *Artificial Recharge of Groundwater*, ed. Takashi Asano. Butterworth Publishers.
- Childs, K.E., S.B. Upchurch, and B. Ellis. 1974. Sampling of variable waste-migration patterns in groundwater. *Ground Water* 12:369-377.
- Cliver, D.O. 2000. Research needs in decentralized wastewater treatment and management: fate and transport of pathogen. White paper available from Department of Population Health and Reproduction, School of Veterinary Medicine, University of California, Davis, CA.
- Cogger, C.G. 1995. Seasonal high water tables, vertical separation, and system performance. Published in *Separation Distance Information Package (WWPCGN61)*. National Small Flows Clearinghouse, West Virginia University, Morgantown, WV.
- Cogger, C.G., and B.L. Carlile. 1984. Field performance of conventional and alternative

- septic systems in wet soils. *Journal of Environmental Quality* 13:137-142.
- Crites, R., and G. Tchobanoglous. 1998. *Small and Decentralized Wastewater Management Systems*. McGraw-Hill, Boston, MA.
- Dagan, G., and E. Bresler. 1984. Solute transport in soil at field scale. In *Pollutants in Porous Media*, ed. B. Yaron, G. Dagan, and J. Goldshmid, pp. 17-48. Springer-Verlag, Berlin, Germany.
- Dental, S.K., H.E. Allen, C. Srinivasarao, and J. Divincenzo. 1993. *Effects of Surfactants on Sludge Dewatering and Pollutant Fate*. Third year completion report project no. 06, prepared for Water Resources Center, University of Delaware. Newark August 1, 1993. <[bluehen.ags.udel.edu/dewrc/surfact.htm](http://bluehen.ags.udel.edu/dewrc/surfact.htm)>.
- DeWalle, F.B., D. Kalman, D. Norman, and J. Sung. 1985. *Trace Volatile Organic Removals in a Community Septic Tank*. EPA/600/2-85/050. U.S. Environmental Protection Agency, Water Engineering Research Laboratory, Cincinnati, OH.
- Dombeck, P.E., L.K. Johnson, S.T. Zimmerley, and M.J. Sadowsky. 2000. Use of repetitive DNA sequences and the PCR to differentiate *escherichia coli* isolates from human and animal sources. *Applied and Environmental Microbiology*, June 2000.
- Drewry, W.A. 1969. *Virus Movement in Groundwater Systems*. OWRR-A-005-ARK (2). Water Resources Research Center, University of Fayetteville, Fayetteville, AR.
- Drewry, W.A. 1973. Virus-soil interactions. In *Proceedings Landspreading Municipal Effluent and Sludge in Florida*. Institute of Food and Agricultural Science, University of Florida, Gainesville, FL.
- Drewry, W.A., and R. Eliassen. 1968. Virus movement in groundwater. *Journal of the Water Pollution Control Federation* 40:R257-R271.
- Duboise, S.M., B.E. Moore, and B.P. Sagik. 1976. Poliovirus survival and movement in a sandy forest soil. *Applied and Environmental Microbiology* 31:536-543.
- Dudley, J.G., and P.A. Stephenson. 1973. *Nutrient Enrichment of Groundwater from Septic Tank Disposal Systems*. Upper Great Lakes Regional Commission, University of Wisconsin, Madison, WI.
- Eddy, N. 2000. Arkansas sanitarian uses infrared technology to track down sewage. *Small Flows Quarterly* 1(2, Spring 2000).
- Eliasson, J.M., D.A. Lanning, and S.C. Weckler. 2001. *Critical Point Monitoring - A New Framework for Monitoring On-Site Wastewater Systems*. Onsite Wastewater Treatment: Proceedings of the Ninth national Symposium on Individual and Small Community Sewage Systems. American Society of Agricultural Engineers, St. Joseph, MI.
- Ellis, B.G., and K.E. Childs. 1973. Nutrient movement from septic tanks and lawn fertilization. *Michigan Department of Natural Resources Technical Bulletin* 73-5.
- Ellis, B.G., and A.E. Erickson. 1969. *Movement and Transformation of Various Phosphorus Compounds in Soils*. Michigan State University, Soil Science Department, East Lansing, MI.
- Erickson, A.E., and J.W. Bastian. 1980. The Michigan Freeway Rest Area System—Experiences and experiments with onsite sanitary systems. In *Individual Onsite Wastewater Systems: Proceedings of the Sixth National Conference*. Ann Arbor Science Publications, Ann Arbor, MI.
- Evanko, C.R., and D.A. Dzombak. 1997. *Remediation of Metals-Contaminated Soils and Groundwater*. Technical evaluation report TE-97-01, Ground-Water Remediation Technologies Analysis Center, Pittsburgh, PA. <<http://www.gwrtac.org>>.
- Feacham, R.G. 1983. Infections related to water and excreta: the health dimension of the decade. In *Water Practice Manuals 3: Water Supply and Sanitation in Developing Countries*, ed. B.J. Dangerfield. The Institute of Water Engineers and Scientists, London, England. Cited in UNDP-World Bank, 1992.
- Federle, T.W., and G.M. Pastwa. 1988. Biodegradation of surfactants in saturated



- subsurface sediments: A field study. *Groundwater* 26(6):761-770.
- Feige, W.A., E.T. Oppelt, and J.F. Kreissl. 1975. *An Alternative Septage Treatment Method: Lime Stabilization/Sand-Bed Dewatering*. EPA-600/2-75/036. U.S. Environmental Protection Agency, Municipal Environmental Research Laboratory, Cincinnati, OH.
- Fetter, C.W. 1988. *Applied Hydrogeology*. Merrill Publishing Company, Columbus, OH.
- Florida Department of Health and Rehabilitative Services. 1993. *Onsite Sewage Disposal System Research in Florida*. Florida Department of Health and Rehabilitative Services and Ayres Associates. March 1993.
- Gerba, C.P. 1995. Virus survival and transport in groundwater. Published in *Separation Distance Technology Package* (WWPCGN61). National Small Flows Clearinghouse, West Virginia University, Morgantown, WV.
- Gerba, C.P., C. Wallis, and J.L. Melnick. 1975. Fate of wastewater bacteria and viruses in soil. *Journal of Irrigation, Drainage, and Engineering*, American Society of Civil Engineers, 101:157-175.
- Gibbs, M.M. 1977a. Soil renovation of effluent from a septic tank on a lake shore. *New Zealand Journal of Science* 20:255-263.
- Gibbs, M.M. 1977b. Study of a septic tank system on a lake shore: temperature and effluent flow patterns. *New Zealand Journal of Science* 20:55-61.
- Gilliom, R.J., and F.R. Patmont. 1983. Lake phosphorus loading from septic systems by seasonally perched ground water. *Journal of the Water Pollution Control Federation* 55:1297-1305.
- Goldsmith, J.D., D. Zohar, Y. Argaman, and Y. Kott. 1973. Effect of dissolved salts on the filtration of coliform bacteria in sand dunes. In *Advances in Water Pollution Research*, ed. S.H. Jenkins, pp. 147-157. Pergamon Press, New York, NY.
- Goldstein, S.N., and W.J. Moberg. 1973. *Wastewater Treatment Systems for Rural Communities*. Commission on Rural Water, National Demonstration Water Project, Washington, DC.
- Green, K.M., and D.O. Cliver. 1975. Removal of virus from septic tank effluent by sand columns. In *Home Sewage Disposal, Proceedings of the National Home Sewage Disposal Symposium*, December 9-10, 1974, Chicago, IL, pp.137-143. American Society of Agricultural Engineers St., Joseph, MI.
- Hagedorn, C. 1982. Transport and Fate: Bacterial Pathogens in Ground Water. In *Microbial Health Considerations of Soil Disposal of Domestic Wastewaters*, proceedings of a conference, University of Oklahoma, Norman, May 11-12, 1982, pp. 153-171. EPA-600/9-83-017. U.S. Environmental Protection Agency, Cincinnati, OH.
- Hagedorn, C., S.L. Robinson, J.R. Filtz, S.M. Grubbs, T.A. Angier, and R.B. Reneau, Jr. 1999. Determining sources of fecal pollution in a rural Virginia watershed with antibiotic resistance patterns in fecal streptococci. *Applied and Environmental Microbiology*, December 1999.
- Hain, K.E., and R.T. O'Brien. 1979. *The Survival of Enteric Viruses in Septic Tanks and Septic Tank Drain fields*. Water Resources Research Institute report no. 108. New Mexico Water Resources Research Institute, New Mexico State University, Las Cruces, NM.
- Harkin, J.M., C.J. Fitzgerald, C.P. Duffy, and D.G. Kroll. 1979. *Evaluation of Mound Systems for Purification of Septic Tank Effluent*. Technical report WIS WRC 79-05. University of Wisconsin, Water Resources Center, Madison, WI.
- Higgins, J., G. Heufelder, and S. Foss. 2000. Removal efficiency of standard septic tank and leach trench septic systems for MS2 coliphage. *Small Flows Quarterly* 1(2).
- Hillel, D. 1989. Movement and retention of organics in soil: a review and a critique of modeling. In *Petroleum Contaminated Soils, Vol. I, Remediation Techniques, Environmental Fate, Risk Assessment*, ed. P.T. Kostecki and E.J. Calabrese, pp. 81-86. Lewis Publishers, Inc., Chelsea, MI.



- Hoover, M.T., A. Arenovski, D. Daly, and D. Lindbo. 1998. A risk-based approach to on-site system siting, design and management. In *On-site Wastewater Treatment, Proceedings of the Eighth National Symposium on Individual and Small Community Sewage Systems*. American Society of Agricultural Engineers, St. Joseph, MI.
- Hori, D.H., N.C. Burbank, R.H.F. Young, L.S. Lau, and H.W. Klemmer. 1971. Migration of poliovirus type II in percolating water through selected oahu soils. In *Advances in Water Pollution Research*, Vol. 2, ed. S.H. Jenkins. Pergamon Press, New York.
- Horsley, Witten, Hegemann. 1991. *Quantification and Control of Nitrogen Inputs to Buttermilk Bay*. Report prepared for the U.S. Environmental Protection Agency, Massachusetts Executive Office of Environmental Affairs, and New England Interstate Water Pollution Control Commission. Horsley, Witten, Hegemann, Inc., Barnstable, MA.
- Jansons, J., L.W. Edmonds, B. Speight, and M.R. Bucens. 1989. Movement of virus after artificial recharge. *Water Research* 23:293-299.
- Jantrania, A.R., W.A. Sack, and V. Earp. 1994. Evaluation of Additives for Improving Septic Tank Operation Under Stress Conditions. In *Proceedings of the Seventh International Symposium on Individual and Small Community Sewage Systems*. American Society of Agricultural Engineers, St. Joseph, MI.
- Jenssen, P.D., and R.L. Siegrist. 1990. *Technology Assessment of Wastewater Treatment by Soil Infiltration Systems*. Water Science Technology, Vol. 22.
- Jones, E.E. 1975. Domestic Wastewater Use In Individual Homes and Hydraulic Loading and Discharge from Septic Tanks. In *Home Sewage Disposal, Proceedings of the First National Home Sewage Disposal Symposium*. American Society of Agricultural Engineers, St. Joseph, MI.
- Jones, R.A., and G.F. Lee. 1977a. *Septic Tank Wastewater Disposal Systems as Phosphorus Sources for Surface Waters*. Occasional paper no. 13. Colorado State University, Department of Environmental Engineering, Fort Collins, CO.
- Jones, R.A., and G.F. Lee. 1977b. *Septic Tank Wastewater Disposal Systems as Phosphorus Sources for Surface Waters*. EPA 600/3-77-129. U.S. Environmental Protection Agency, Robert S. Kerr Environmental Research Laboratory, Ada, OK.
- Jones, R.A., and G.F. Lee. 1979. Septic tank wastewater disposal systems as phosphorus sources for surface waters. *Journal of the Water Pollution Control Federation* 51:2764-2775.
- Joubert, L., J. Lucht, and A.J. Gold. 1999. A Geographic Information System-based Watershed Assessment Strategy For Community Wastewater Management Planning. In *Proceedings NOWRA . . . New Ideas for a New Millennium*. National Onsite Wastewater Recycling Association, Northbrook, IL.
- Kellogg, D.Q., L. Joubert, and A.J. Gold. 1997. *MANAGE: A Method for Assessment, Nutrient-Loading, and Geographic Evaluation of Nonpoint Pollution*. University of Rhode Island Cooperative Extension, Department of Natural Resources Science, Kingston, RI.
- Knowles, Graham. 1999. *National Onsite Demonstration Program IV*. Unpublished manuscript and presentation. National Small Flows Clearinghouse, Morgantown, WV.
- Kolega, J.J. 1989. Impact of Toxic Chemicals to Groundwater. In *Proceedings of the Sixth Northwest On-site Wastewater Treatment Short Course*, September 18-19, 1989, Seattle, WA, ed. R.W. Seabloom and D. Lenning, pp. 247-256. University of Washington, Seattle, WA.
- Konen, Thomas P. 1995. *Water use and efficiency under the U.S. Energy Policy Act*. Stevens Institute of Technology, Building Technology Research Laboratory. Hoboken, NJ.
- Korich, D.G., J.R. Mead, M.S. Madore, N.A. Sinclair, and C.R. Sterling. 1990. Effects of ozone, chlorine dioxide, chlorine, and monochloramine on *Cryptosporidium parvum* oocyst viability. *Applied and Environmental Microbiology* 56:1423-1428.
- Kowal, N.E. 1982. *Health Effects of Land Treatment: Microbiological*. EPA-600/1-81-

055. U.S. Environmental Protection Agency, Cincinnati, OH.
- Kulesza, T.J. 1975. Chief of the Industrial Waste Unit, City of Philadelphia Water Department. Personal communication.
- Laak, R. 1975. Relative Pollution Strengths of Undiluted Waste Materials Discharged in Households and The Dilution Waters Used for Each. In *Manual of Grey Water Treatment Practice*. Anne Arbor Science, Ann Arbor, MI.
- Laak, R. 1976. Pollutant load from plumbing fixtures and pretreatment to control soil clogging. *Journal of Environmental Health* 39:48-50.
- Lance, J.C., and C.P. Gerba. 1980. Poliovirus movement during high rate land application of sewage water. *Journal of Environmental Quality* 9:31-34.
- Lance, J.C., C.P. Gerba, and J.L. Melnick. 1976. Virus movement in soil columns flooded with secondary sewage effluent. *Applied Environmental Microbiology* 32:520-526.
- Lance, J.C., C.P. Gerba, and D.S. Wang. 1982. Comparative movement of different enteroviruses in soil columns. *Journal of Environmental Quality* 11:347-351.
- Lefler, E., and Y. Kott. 1973. Enteric virus behavior in sand dunes. In *Proceedings of the Fourth Science Conference of the Israel Ecological Society*, Tel-Aviv, Israel.
- Lefler, E., and Y. Kott. 1974. Virus retention and survival in sand. In *Virus Survival in Water and Wastewater Systems*, ed. J.F. Malina, Jr., and B.P. Sagik, pp. 84-91. University of Texas, Austin, TX.
- Ligman, K., N. Hutzler, and W.C. Boyle. 1974. Household wastewater characterization. *Journal of the Environmental Engineering Division, American Society of Civil Engineers* 100(EE1), Proceeding Paper 10372.
- Lim, T., J. Tav, and C. Tah. 2001. Influence of metal loading on the mode of metal retention in a natural clay. *Journal of Environmental Engineering* 127 (6, June).
- Loomis, G., L. Joubert, B. Dillman, D. Dow, J. Lucht, and A. Gold. 1999. A Watershed Risk-based Approach to Onsite Wastewater Management—A Block Island, Rhode Island case study. In *Proceedings of the 10th Northwest On-Site Wastewater Treatment Short Course and Equipment Exhibition*. University of Washington, Seattle, WA.
- Massachusetts Environmental Code. Title V, 310 CMR 15.00, promulgated pursuant to the authority of Massachusetts General Law c. 12A, Section 13.
- Matthess, G. 1984. Unsaturated zone pollution by heavy metals. In *Pollutants in Porous Media*, ed. B. Yaron, G. Dagan, and J. Goldshmid, pp. 79-122. Springer-Verlag, Berlin, Germany.
- Mayer, P.W., W.B. DeOreo, E.M. Opitz, J.C. Kiefer, W.Y. Davis, B. Dziegielewski, and J.O. Nelson. 1999. *Residential End Uses of Water*. Report to AWWA Research Foundation and American Water Works Association (AWWA), Denver, CO.
- Mayer, P.W., W.B. DeOreo, and D.M. Lewis. 2000. *Seattle Home Water Conservation Study: The Impacts of High Efficiency Plumbing Fixture Retrofits in Single-Family Homes*. Submitted to Seattle Public Utilities and U.S. Environmental Protection Agency by Aquacraft, Inc. Water Engineering and Management, Boulder, CO.
- McAvoy, D.C., C.E. White, B.L. Moore, and R.A. Rapaport. 1991. Sorption and transport of anionic and cationic surfactants below a Canadian septic tank/tile field. *Environmental Toxicology and Chemistry*.
- McGauhey, P.H., and R.B. Krone. 1967. *Soil Mantle as a Wastewater Treatment System*. Sanitary Engineering Research Laboratory report no. 67-11. University of California, Berkeley, CA.
- National Association of Plumbing-Heating-Cooling Contractors (NAPHCC). 1992. *Assessment of On-Site Graywater and Combined Wastewater Treatment and Recycling Systems*. NAPHCC, Falls Church, VA.
- National Research Council. 1993. *Groundwater Vulnerability Assessment: Predicting Relative Contamination Potential Under Conditions of*

- Uncertainty*. Water Science and Technology Board, Commission on Geosciences, Environment, and Resources, Committee on Techniques for Assessing Groundwater Vulnerability. National Academy Press, Washington, DC.
- National Small Flows Clearinghouse (NSFC). 1995. *Summary of Onsite Systems in the United States, 1993*. National Small Flows Clearinghouse, Morgantown, WV.
- National Small Flows Clearinghouse (NSFC). 1998. Robertson, Cherry, and Sudicky. *Vertical Separation Technology Package*. January 1998, p. 32.
- National Small Flows Clearinghouse (NSFC). 2000. *Small Flows Quarterly*. Vol.1, No.4, Summer 2000. National Environmental Service Center, West Virginia University. Morgantown, WV.
- Nelson, M.E., S.W. Horsley, T. Cambareri, M. Giggey, and J. Pinette. 1988. Predicting Nitrogen Concentrations in Ground Water—An Analytical Model. In *Proceedings of the National Water Well Association*, Westerville, OH.
- Nestor, I., and L. Costin. 1971. The removal of Coxsackie virus from water by sand obtained from the rapid sand filters of water-plants. *Journal of Hygiene, Epidemiology, Microbiology and Immunology* 15:129-136.
- Northern Virginia Regional Commission. 1999. Students shed light on sewage question in Four Mile Run. Press release, August 3, 1999. Northern Virginia Regional Commission, Annandale, VA.
- Olsson, E., L. Karlgren, and V. Tullander. 1968. *Household Wastewater*. Report 24:1968. The National Swedish Institute for Building Research, Stockholm, Sweden.
- Otis, R.J. 1999. Establishing Risk-Based Performance Standards. Presented at the National Environmental Health Association Onsite Wastewater Systems Conference, Nashville, TN.
- Otis, R.J. 2000. Performance management. *Small Flows Quarterly* 1(1):12.
- Parizek, R.R., and B.E. Lane. 1970. Soil-water sampling using pan and deep pressure-vacuum lysimeters. *Journal of Hydrology* 11:1-21.
- Parveen, S., K.M. Portier, K. Robinson, L. Edmiston, and M.S. Tamplin. 1999. Discriminant analysis of ribotype profiles of *escherichia coli* for differentiating human and nonhuman sources of fecal pollution. *Applied and Environmental Microbiology*, July 1999.
- Payment, P., S. Fortin, and M. Trudel. 1986. Elimination of human enteric viruses during conventional wastewater treatment by activated sludge. *Canadian Journal of Microbiology* 32:922-925.
- Peavy, H.S., and C.E. Brawner. 1979. Unsewered Subdivisions as a Non-point Source of Groundwater Pollution. In *Proceedings of National Conference on Environmental Engineering*, San Francisco, CA.
- Peavy, H.S., and K.S. Groves. 1978. The Influence of Septic Tank Drainfields on Ground Water Quality in Areas of High Ground Water. In *Home Sewage Treatment, Proceedings of the Second National Home Sewage Treatment Symposium*, December 12-19, 1977, Chicago, IL, pp. 218-225. American Society of Agricultural Engineers, St. Joseph, MI.
- Pekdeger, A. 1984. Pathogenic Bacteria and Viruses in the Unsaturated Zone. In *Pollutants in Porous Media*, ed. B. Yaron, G. Dagan, and J. Goldshmid, pp. 195-206. Springer-Verlag, Berlin, Germany.
- Perlmutter, N.M., and E. Koch. 1971. *Preliminary Findings on the Detergent and Phosphate Contents of Water of Southern Nassau County, New York*. U.S. Geological Survey professional paper 750-D. U.S. Government Printing Office, Washington, DC.
- Peters, C.A., and R.W. Healy. 1988. The representativeness of pore water samples collected from the unsaturated zone using pressure-vacuum lysimeters. *Groundwater Monitoring Report* (Spring):96-101.
- Polta, R.C. 1969. Septic tank effluents, water pollution by nutrients: sources, effects, and controls. University of Minnesota. *Water Resources Bulletin* 13:53-57.

- Preslo, L., M. Miller, W. Suyama, M. McLearn, P. Kostecki, and E. Fleischer. 1989. Available Remedial Technologies for Petroleum Contaminated Soils. In *Petroleum Contaminated Soils*, Vol. I, *Remediation Techniques, Environmental Fate, Risk Assessment*, ed. P.T. Kostecki and E.J. Calabrese, pp. 115-125. Lewis Publishers, Inc., Chelsea, MI.
- Preul, H.C. 1966. Underground movement of nitrogen. *Advanced Water Pollution Research* 1:309-323.
- Rao, V.C., S.B. Lakhe, S.V. Waghmare, V. Raman. 1981. Virus removal in primary settling of raw sewage. *Journal of Environmental Engineering* 107:57-59.
- Rea, R.A., and J.B. Upchurch. 1980. Influence of regolith properties on migration of septic tank effluents. *Groundwater* 18:118-125.
- Reneau, R.B., Jr. 1977. Changes in inorganic nitrogenous compounds from septic tank effluent in a soil with a fluctuating water table. *Journal of Environmental Quality* 6:173-178.
- Reneau, R.B., Jr. 1979. Changes in concentrations of selected chemical pollutants in wet, tile-drained soil systems as influenced by disposal of septic tank effluents. *Journal of Environmental Quality* 8:189-196.
- Reneau, R.B., and D.E. Pettry. 1976. Phosphorus distribution from septic tank effluent in coastal plain soils. *Journal of Environmental Quality* 5:34-39.
- Rhode Island Department of Environmental Management. 2000. *Septic System Checkup*. Department of Environmental Management, Providence, RI.
- Ricker, J., N. Hantzsche, B. Hecht, and H. Kolb. 1994. Area-wide Wastewater Management for the San Lorenzo River Watershed, California. In *Onsite Wastewater Treatment: Proceedings of the Seventh International Symposium on Individual and Small Community Sewage Systems*. Atlanta, GA. December 11-13, 1994, pp. 355-367. American Society of Agricultural Engineers, St. Joseph, MI.
- Robeck, G.C., N.A. Clarke, and K.A. Dostall. 1962. Effectiveness of water treatment processes in virus removal. *Journal of the American Water Works Association* 54:1275-1290.
- Robertson, W.D. 1991. A case study of ground water contamination from a domestic septic system: 7. persistence of dichlorobenzene. *Environmental Toxicology and Chemistry* Vol. 10.
- Robertson, W.D., and J.A. Cherry. 1995. *In-situ* denitrification of septic-system nitrate using porous media barriers: field study. *Groundwater* 33(1):99-110.
- Robertson, W.D., J.A. Cherry, and E.A. Sudicky. 1989. Groundwater contamination at two small septic systems on sand aquifers. *Groundwater* 29(1):82-92.
- Robertson, W.D., E.A. Sudicky, J.A. Cherry, R.A. Rapaport, and R.J. Shimp. 1990. Impact of a Domestic Septic System on an Unconfined Sand Aquifer. In *Contaminant Transport in Groundwater*, ed. Kobus and Kinzelbach. Balkema, Rotterdam, Netherlands.
- Rouge River National Wet Weather Demonstration Project. 1998. *Michigan General Permit Draft Guidance*. <<http://www.wcdoe.org/rouge/river/techtoc/nonpoint/permit/illegal.html>>.
- Sandhu, S.S., W.J. Warreu, and P. Nelson. 1977. Trace inorganics in rural potable water and their correlation to possible sources. *Water Resources* 12:257-261.
- Sauer, P.A., and E.J. Tyler. 1991. Volatile Organic Chemical (VOC) Attenuation in Unsaturated Soil Above and Below an Onsite Wastewater Infiltration System. In *On-site Wastewater Treatment: Proceedings of the Sixth National Symposium on Individual and Small Sewage Systems*. American Society of Agricultural Engineers, St. Joseph, MI.
- Sawney, B.L. 1977. Predicting phosphate movement through soil columns. *Journal of Environmental Quality* 6:86.
- Sawney, B.L., and D.E. Hill. 1975. Phosphate sorption characteristics of soils treated with domestic wastewater. *Journal of Environmental Quality* 4:343-346.
- Schaub, S.A., and C.A. Sorber. 1977. Virus and bacteria removal from wastewater by rapid



- infiltration through soil. *Applied and Environmental Microbiology* 33:609-619.
- Sedlak, R. ed. *Phosphorus and Nitrogen Removal from Municipal Wastewater, Principles and Practice*. 2nd ed. The Soap and Detergent Association. Lewis Publishers, New York, NY.
- Segall, B.A., C.R. Ott, and W.B. Moeller. 1979. *Monitoring Septage Addition to Wastewater Treatment Plants* Vol. 1. *Addition to the Liquid Stream*. EPA-600/2-79-132. U.S. Environmental Protection Agency, Cincinnati, OH.
- Shaw, R. 1970. Experiences with waste ordinances and surcharges at Greensboro, North Carolina. *Journal of the Water Pollution Control Federation* 42(1):44.
- Shaw, B., and N.B. Turyk. 1994. Nitrate-N Loading to Ground Water from Pressurized Mound, In-ground and At-grade Septic Systems. In *On-Site Wastewater Treatment: Proceedings of the Seventh International Symposium on Individual and Small Community Sewage Systems*. American Society of Agricultural Engineers, St. Joseph, MI.
- Shimp, R.J., E.V. Lapsins, and R.M. Ventullo. 1991. Biodegradation of linear alkyl benzene sulfonate (LAS) and nitrilotriacetic acid (NTA) in surface and subsurface soils and groundwater near a septic tank tile field. *Environmental Toxicology and Chemistry*.
- Siegrist, R.L. 1983. Minimum-flow plumbing fixtures. *Journal of the American Water Works Association* 75(7):342-348.
- Siegrist, R.L., D.L. Anderson, and J.C. Converse. 1985. Commercial Wastewater Onsite Treatment and Disposal. In *On-Site Wastewater Treatment, Proceedings of the Fourth National Symposium on Individual and Small Community Sewage Systems*. American Society of Agricultural Engineers, St. Joseph, MI.
- Siegrist, R.L., D.L. Anderson, and D.L. Hargett. 1986. *Large Soil Absorption Systems for Wastewaters from Multiple-Home Developments*. EPA/600/S2-86/023. U.S. Environmental Protection Agency, Cincinnati, OH.
- Siegrist, R.L., M. Witt, and W.C. Boyle. 1976. The characteristics of rural household wastewater. *Journal of the Environmental Engineering Division, American Society of Civil Engineers*, 102:533-548. Proceedings.
- Sikora, L.J., and R.B. Corey. 1976. Fate of nitrogen and phosphorus in soils under septic tank waste disposal fields. *Transactions of American Society of Agricultural Engineers* 19:866.
- Sobsey, M.D. 1983. Transport and Fate of Viruses in Soils. In *Microbial Health Considerations of Soil Disposal of Domestic Wastewaters*, proceedings of a conference, May 11-12, 1982, University of Oklahoma. EPA-600/9-83-017. U.S. Environmental Protection Agency, Cincinnati, OH.
- Sobsey, M.D., C.H. Dean, M.E. Knuckles, and R.A. Wagner. 1980. Interactions and survival of enteric viruses in soil materials. *Applied and Environmental Microbiology* 40:92-101.
- Stark, S.L., J.R. Nurkols, and J. Rada. 1999. Using GIS to investigate septic system sites and nitrate pollution potential. *Journal of Environmental Health* April.
- Starr, J.L., and B.L. Sawhney. 1980. Movement of nitrogen and carbon from a septic system drainfield. *Water, Air, and Soil Pollution* 13:113-123.
- Tchobanoglous, G., and F.L. Burton. 1991. *Wastewater Engineering: Treatment, Disposal, Reuse*, 3rd ed. McGraw-Hill, Inc., New York, NY.
- Terrene Institute. 1995. *Local Ordinance: A User's Guide*. Prepared by Terrene Institute in cooperation with the U.S. Environmental Protection Agency, Washington, DC.
- Tetra Tech, Inc. 2000. Water quality sampling costs. Unpublished data collected by Kathryn Phillips, Tetra Tech Inc., Fairfax, VA.
- Thurman, E.M., L.B. Barber, Jr., and D. Leblanc. 1986. Movement and fate of detergents in groundwater: a field study. *Journal of Contaminants and Hydrology* 1:143-161.
- Tinker, J.R., Jr. 1991. An analysis of nitrate-nitrogen in groundwater beneath unsewered



- subdivisions. *Groundwater Monitoring Review* 141-150.
- Tofflemire, T.J., and M. Chen. 1977. Phosphate removal by sands and soil. *Groundwater* 15:377-387.
- Tomson, M., C. Curran, J.M. King, H. Wang, J. Dauchy, V. Gordy, and B.H. Ward. 1984. *Characterization of Soil Disposal System Leachates*. EPA-600/2-84-101. U.S. Environmental Protection Agency, Municipal Environmental Research Laboratory, Cincinnati, OH.
- Town of New Shoreham. 1996. *Wastewater Management Plan Ordinance*. Town of New Shoreham, RI.
- Town of New Shoreham. 1998. *Zoning Ordinance*. Amendment of Article 5, Section 506 (Septic Systems). Town of New Shoreham, RI.
- Uebler, R.L. 1984. Effect of loading rate and soil amendments on inorganic nitrogen and phosphorus leached from a wastewater soil absorption system. *Journal of Environmental Quality* 13:475-479.
- United Nations Development Programme (UNDP)-World Bank. 1992. *Reuse of Human Wastes in Aquaculture: A Technical Review*. Water and Sanitation report no. 2. UNDP-World Bank, Washington, DC.
- University of Minnesota, 1998. *Septic System Owner's Guide*. University of Minnesota Extension Service. Publication no. PC-6583-GO. University of Minnesota, College of Agricultural, Food, and Environmental Sciences, St. Paul. <<http://www.extension.umn.edu/distribution/naturalresources/DD6583.html>>.
- University of Wisconsin-Madison. 1978. *Management of Small Wastewater Flows*. EPA-600/7-78-173. U.S. Environmental Protection Agency, Office of Research and Development, Municipal Environmental Research Laboratory (MERL) Cincinnati, OH.
- U.S. Census Bureau. 1990. *Current Housing Report*. U.S. Census Bureau, Washington, DC.
- U.S. Environmental Protection Agency (USEPA). 1980a. *Design Manual: Onsite Wastewater Treatment and Disposal System*. EPA/625/1-80/012. U.S. Environmental Protection Agency, Office of Research and Development and Office of Water, Cincinnati, OH.
- U.S. Environmental Protection Agency (USEPA). 1980b. *Planning Wastewater Management Facilities for Small Communities*. EPA-600/8-80-030. U.S. Environmental Protection Agency, Office of Research and Development, Wastewater Research Division, Municipal Environmental Research Laboratory, Cincinnati, OH.
- U.S. Environmental Protection Agency (USEPA). 1990. *The Use of Models for Granting Variances from Mandatory Disinfection of Groundwater Used as a Public Water Supply*. U.S. Environmental Protection Agency, Office of Research and Development, Ada, OK.
- U.S. Environmental Protection Agency (USEPA). 1992. *Water Treatment/Disposal for Small Communities*. EPA/625/R-92/005 U.S. Environmental Protection Agency, Office of Research and Development, Center for Environmental Research Information, Cincinnati, OH.
- U.S. Environmental Protection Agency (USEPA). 1995. *Clean Water Through Conservation*. EPA 841-B-95-002. U.S. Environmental Protection Agency, Office of Water, Washington, DC.<<http://www.epa.gov/OW/you/intro.html>>.
- U.S. Environmental Protection Agency (USEPA). 1998. *Clean Water Action Plan: Restoring and Protecting America's Waters*. USEPA 840-R-98-001. U.S. Environmental Protection Agency, Washington, DC.
- U.S. Environmental Protection Agency (USEPA). 1997. *Response to Congress on Use of Decentralized Wastewater Treatment Systems*. EPA/832/R-97/001b. U.S. EPA, Washington, DC.
- U.S. Environmental Protection Agency (USEPA). 1999. *Review of Potential Modeling Tools and Approaches to Support the BEACH Program*. U.S. Environmental Protection Agency, Office of Science and Technology, Standards and Applied Science Division, Washington, DC.

- U.S. Environmental Protection Agency (USEPA). 2000a. *Current Drinking Water Standards*. U.S. Environmental Protection Agency, Office of Ground Water and Drinking Water. <http://www.epa.gov/OGWDW/wot/appa.html>. Accessed May 5, 2000.
- U.S. Environmental Protection Agency (USEPA). 2000b. *Draft Guidelines for Management of Onsite/Decentralized Wastewater Systems*. 65FR195, October 6, 2000.
- U.S. Geological Survey (USGS). 1999. *The Quality of Our Nation's Waters: Nutrients and Pesticides*. U.S. Geological Survey circular 1225. U.S. Department of the Interior, U.S. Geological Survey, Reston, VA.
- Van Cuyk, S.M., R.L. Siegrist, and A.L. Logan. 2001. *Evaluation of Virus and Microbiological Purification in Wastewater Soil Absorption Systems Using Multicomponent Surrogate and Tracer Additions*. On-Site Wastewater Treatment: Proceedings of the Ninth National Symposium on Individual and Small Community Sewage Systems. American Society of Agricultural Engineers, St. Joseph, MI.
- Vaughn, J.M., and E.F. Landry. 1977. *Data Report: An Assessment of the Occurrence of Human Viruses in Long Island Aquatic Systems*. Brookhaven National Laboratory, Department of Energy and Environment, Upton, NY.
- Vaughn, J.M., and E.F. Landry. 1980. *The Fate of Human Viruses in Groundwater Recharge Systems*. BNL 51214, UC-11. Brookhaven National Laboratory, Department of Energy and Environment, Upton, NY.
- Vaughn, J.M., E.F. Landry, C.A. Beckwith, and M.Z. Thomas. 1981. Virus removal having groundwater recharge: effects of infiltration rate on adsorption of poliovirus to soil. *Applied and Environmental Microbiology* 41:139-147.
- Vaughn, J.M., E.F. Landry, and M.Z. Thomas. 1982. The lateral movement of indigenous enteroviruses in a sandy sole-source aquifer. In *Microbial Health Considerations of Soil Disposal of Domestic Wastewaters*, proceedings of a conference, May 11-12, 1982, University of Oklahoma. EPA-600/9-83-017. U.S. Environmental Protection Agency, Cincinnati, OH.
- Vaughn, J.M., E.F. Landry, and M.Z. Thomas. 1983. Entrainment of viruses from septic tank leach fields through a shallow, sandy soil aquifer. *Applied and Environmental Microbiology* 45:1474-1480.
- Viraraghavan, T., and R.G. Warnock. 1976a. Efficiency of a septic tank tile system. *Journal of the Water Pollution Control Federation* 48:934-944.
- Viraraghavan, T., and R.G. Warnock. 1976b. Ground water pollution from a septic tile field. *Water, Air, and Soil Pollution* 5:281-287.
- Viraraghavan, T., and R.G. Warnock. 1976c. Ground water quality adjacent to a septic tank system. *Journal of the American Water Works Association* 68:611-614.
- Virginia Polytechnic Institute and State University. 2001. *Bacterial Source Tracking (BST): Identifying Sources of Fecal Pollution*. Virginia Polytechnic Institute and State University, Department of Crop and Soil Environmental Sciences, Blacksburg, VA. [http://www.bsi.vt.edu/biol\\_4684/BST/BST.html](http://www.bsi.vt.edu/biol_4684/BST/BST.html).
- Walker, W.G., J. Bouma, D.R. Keeney, and F.R. Magdoff. 1973a. Nitrogen transformations during subsurface disposal of septic tank effluent in sands: I. Soil transformations. *Journal of Environmental Quality* 2:475.
- Walker, W.G., J. Bouma, D.R. Keeney, and P.G. Olcott. 1973b. Nitrogen transformations during subsurface disposal of septic tank effluent in sands: II. Ground water quality. *Journal of Environmental Quality* 2:521-525.
- Washington Department of Health. 1994. On-site sewage system regulations. Chapter 246-272, Washington Administrative Code, adopted March 9, 1994, effective January 1, 1995. Washington Department of Health, Olympia, WA. <<http://www.doh.wa.gov/ehp/ts/osreg1.doc>>.

- Watson, K.S., R.P. Farrell, and J.S. Anderson. 1967. The contribution from the individual home to the sewer system. *Journal of the Water Pollution Control Federation* 39(12):2034-2054.
- Watkins, R.E. 1991. Elkhart County Health Department, Environmental Health Services, Goshen, NY. Personal communication.
- Wellings, F.M., A.L. Lewis, C.W. Mountain, and L.V. Pierce. 1975. Demonstration of virus in ground water after effluent discharge onto soil. *Applied Microbiology* 29:751-757.
- Whelan, B.R., and N.J. Barrow. 1984. The movement of septic tank effluent through sandy soils near Perth. II: movement of phosphorus. *Australian Journal of Soil Research* 22:293-302.
- Whelan, B.R., and Z.V. Titmanis. 1982. Daily chemical variability of domestic septic tank effluent. *Water, Air, and Soil Pollution* 17:131-139.
- Wilhelm, S.W. 1998. Biogeochemistry of conventional septic systems and tile beds. Reproduced in *Vertical Separation Distance Technology Package* (WWBKGN61). National Small Flows Clearinghouse, Morgantown, WV.
- Wisconsin Administrative Code. 1999. Chapter Comm 85: *Private Onsite Wastewater Treatment Systems*. Draft rules. State of Wisconsin Department of Commerce, Madison, WI.
- Wolterink, T.J., et al. 1979. *Identifying Sources of Subsurface Nitrate Pollution with Stable Nitrogen Isotopes*. EPA 600/4-79-050. U.S. Environmental Protection Agency, Washington, DC.
- Yeager, J.G., and R.T. O'Brien. 1977. *Enterovirus and Bacteriophage Inactivation in Subsurface Waters and Translocation in Soil*. Water Resources Research Institute report no. 083. New Mexico State University, New Mexico Water Resources Research Institute, Las Cruces, NM.
- Young, R.H.F., and N.C. Burbank, Jr. 1973. Virus removal in Hawaiian soils. *Journal of the American Water Works Association* 65:698-704.
- Ziebell, W.A., D.H. Nero, J.F. Deininger, and E. McCoy. 1975. Use of bacteria in assessing waste treatment and soil disposal systems. In *Home Sewage Disposal, Proceedings of the National Home Sewage Disposal Symposium*, December 19-20, 1974, Chicago, IL, pp. 58-63. American Society of Agricultural Engineers, St. Joseph, MI.



# Chapter 4

## Treatment processes and systems

- 4.1 Introduction
  - 4.2 Conventional systems and treatment options
  - 4.3 Subsurface wastewater infiltration
  - 4.4 Design considerations
  - 4.5 Construction management and contingency options
  - 4.6 Septic tanks
  - 4.7 Sand/media filters
  - 4.8 Aerobic Treatment Units
- 

### 4.1 Introduction

This chapter contains information on individual onsite/decentralized treatment technologies or unit processes. Information on typical application, design, construction, operation, maintenance, cost, and pollutant removal effectiveness is provided for most classes of treatment units and their related processes. This information is intended to be used in the preliminary selection of a system of treatment unit processes that can be assembled to achieve predetermined pollutant discharge concentrations or other specific performance requirements. Complete design specifications for unit processes and complete systems are not included in the manual because of the number of processes and process combinations and the wide variability in their application and operation under various site conditions. Designers and others who require more detailed technical information are referred to such sources.

Chapter 4 is presented in two main sections. The first section contains information about *conventional* (soil-based or subsurface wastewater infiltration) systems, referred to as SWISs in this document. Both gravity-driven and mechanized SWISs are covered in this section of chapter 4. The second section contains a general introduction to sand filters (including other media), and a series of fact sheets on treatment technologies, *alternative* systems (e.g., fixed-film and suspended growth systems, evapotranspiration systems, and other applications), and special issues pertaining to the design, operation, and maintenance of onsite wastewater treatment systems (OWTSSs). This

approach was used because the conventional system is the most economical and practical system type that can meet performance requirements in many applications.

The first section is further organized to provide information about the major components of a conventional system. Given the emphasis in this manual on the design boundary (performance-based) approach to system design, this section was structured to lead the reader through a discussion of system components by working backwards from the point of discharge to the receiving environment to the point of discharge from the home or other facility served by the onsite system. Under this approach, soil infiltration issues are discussed first, the distribution piping to the infiltration system including graveless systems is addressed next, and matters related to the most common preliminary treatment device, the septic tank, are covered last.

The fact sheets in the second section of this chapter describe treatment technologies and discuss special issues that might affect system design, performance, operation, and maintenance. These treatment technologies are often preceded by a septic tank and can include a subsurface wastewater infiltration system. Some treatment technologies may be substituted for part or all of the conventional system, though nearly all alternative approaches include a septic tank for each facility being served. Fact sheets are provided for the more widely used and successful treatment technologies, such as sand filters and aerobic treatment units.



The component descriptions provided in this chapter are intended to assist the reader in screening components and technologies for specific applications. Chapter 5 presents a strategy and procedures that can be used to screen and select appropriate treatment trains and their components for specific receiver sites. The reader should review chapter 5 before selecting system components.

## 4.2 Conventional systems and treatment options

The three primary components of a conventional system (figure 4-1) are the soil, the subsurface wastewater infiltration system (SWIS; also called a leach field or infiltration trench), and the septic tank. The SWIS is the interface between the engineered system components and the receiving ground water environment. It is important to note that the performance of conventional systems relies primarily on treatment of the wastewater effluent in the soil horizon(s) below the dispersal and infiltration components of the SWIS. Information on SWIS siting, hydraulic and mass loadings, design and geometry, distribution methods, and construction considerations is included in this chapter. The other major component of a conventional system, the septic tank, is characterized by describing its many functions in an OWTS.

Treatment options include physical, chemical, and biological processes. Use of these options is determined by site-specific needs. Table 4-1 lists

common onsite treatment processes and methods that may be used alone or in combination to assemble a treatment train capable of meeting established performance requirements. Special issues that might need to be addressed in OWTS design include treatment of high-strength wastes (e.g., biochemical oxygen demand and grease from schools and restaurants), mitigation of impacts from home water softeners and garbage disposals, management of holding tanks, and additives (see related fact sheets).

## 4.3 Subsurface wastewater infiltration

Subsurface wastewater infiltration systems (SWISs) are the most commonly used systems for the treatment and dispersal of onsite wastewater. Infiltrative surfaces are located in permeable, unsaturated natural soil or imported fill material so wastewater can infiltrate and percolate through the underlying soil to the ground water. As the wastewater infiltrates and percolates through the soil, it is treated through a variety of physical, chemical, and biochemical processes and reactions.

Many different designs and configurations are used, but all incorporate soil infiltrative surfaces that are located in buried excavations (figure 4-1). The primary infiltrative surface is the bottom of the excavation, but the sidewalls also may be used for infiltration. Perforated pipe is installed to distribute the wastewater over the infiltration surface. A porous

Figure 4-1. Conventional subsurface wastewater infiltration system

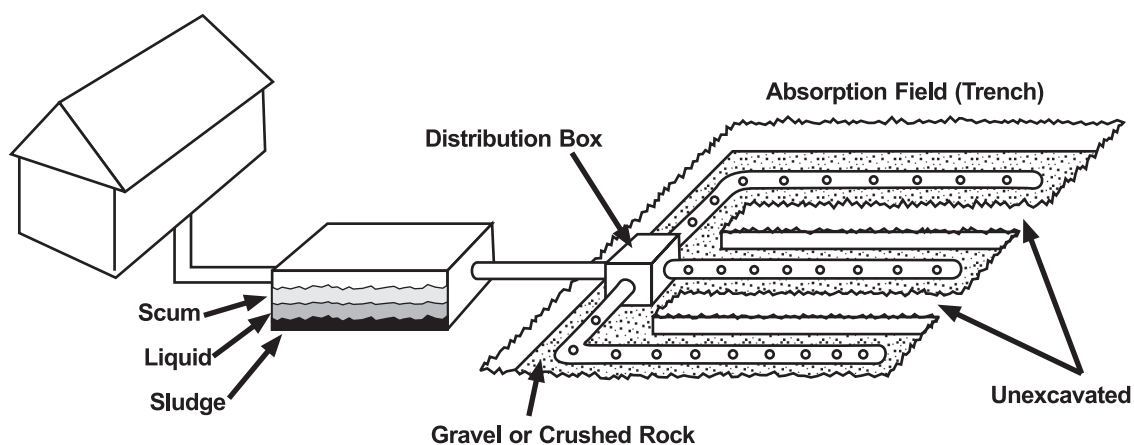


Table 4-1. Commonly used treatment processes and optional treatment methods

Treatment objective	Treatment process	Treatment methods
<b>Suspended solids removal</b>	Sedimentation	Septic tank Free water surface constructed wetland Vegetated submerged bed
	Filtration	Septic tank effluent screens Packed-bed media filters (incl. dosed systems) Granular (sand, gravel, glass, bottom ash) Peat, textile Mechanical disk filters Soil infiltration
<b>Soluble carbonaceous BOD and ammonium removal</b>	Aerobic, suspended-growth reactors	Extended aeration Fixed-film activated sludge Sequencing batch reactors (SBRs)
	Fixed-film aerobic bioreactor	Soil infiltration Packed-bed media filters (incl. dosed systems) Granular (sand, gravel, glass) Peat, textile, foam Trickling filter Fixed-film activated sludge Rotating biological contactors
	Lagoons	Facultative and aerobic lagoons Free water surface constructed wetlands
<b>Nitrogen transformation</b>	Biological Nitrification (N) Denitrification (D)	Activated sludge (N) Sequencing batch reactors (N) Fixed film bio-reactor (N) Recirculating media filter (N, D) Fixed-film activated sludge (N) Anaerobic upflow filter (N) Anaerobic submerged media reactor (D) Submerged vegetated bed (D) Free-water surface constructed wetland (N, D)
	Ion exchange	Cation exchange (ammonium removal) Anion exchange (nitrate removal)
<b>Phosphorus removal</b>	Physical/Chemical	Infiltration by soil and other media Chemical flocculation and settling Iron-rich packed-bed media filter
	Biological	Sequencing batch reactors
<b>Pathogen removal (bacteria, viruses, parasites)</b>	Filtration/Predation/Inactivation	Soil infiltration Packed-bed media filters Granular (sand, gravel, glass bottom ash) Peat, textile
	Disinfection	Hypochlorite feed Ultraviolet light
<b>Grease removal</b>	Flotation	Grease trap Septic tank
	Adsorption	Mechanical skimmer
	Aerobic biological treatment (incidental removal will occur; overloading is possible)	Aerobic biological systems

medium, typically gravel or crushed rock, is placed in the excavation below and around the distribution piping to support the pipe and spread the localized flow from the distribution pipes across the excavation cavity. Other gravelless or “aggregate-free” system components may be substituted. The porous medium maintains the structure of the excavation, exposes the applied wastewater to more infiltrative surface, and provides storage space for the wastewater within its void fractions (interstitial spaces, typically 30 to 40 percent of the volume) during peak flows with gravity systems. A permeable geotextile fabric or other suitable material is laid over the porous medium before the excavation is backfilled to prevent the introduction of backfill material into the porous medium. Natural soil is typically used for backfilling, and the surface of the backfill is usually slightly mounded and seeded with grass.

Subsurface wastewater infiltration systems provide both dispersal and treatment of the applied wastewater. Wastewater is transported from the infiltration system through three zones (see chapter 3). Two of these zones, the infiltration zone and vadose zone, act as fixed-film bioreactors. The infiltration zone, which is only a few centimeters thick, is the most biologically active zone and is often referred to as the “biomat.” Carbonaceous material in the wastewater is quickly degraded in this zone, and nitrification occurs immediately below this zone if sufficient oxygen is present. Free or combined forms of oxygen in the soil must satisfy the oxygen demand generated by the microorganisms degrading the materials. If sufficient oxygen is not present, the metabolic processes of the microorganisms can be reduced or halted and both treatment and infiltration of the wastewater will be adversely affected (Otis, 1985). The vadose (unsaturated) zone provides a significant pathway for oxygen diffusion to re-aerate the infiltration zone (Otis, 1997, Siegrist et al., 1986). Also, it is the zone where most sorption reactions occur because the negative moisture potential in the unsaturated zone causes percolating water to flow into the finer pores of the soil, resulting in greater contact with the soil surfaces. Finally, much of the phosphorus and pathogen removal occurs in this zone (Robertson and Harman, 1999; Robertson et al., 1998; Rose et al., 1999; Yates and Yates, 1988).

### **4.3.1 SWIS designs**

There are several different designs for SWISs. They include trenches, beds, seepage pits, at-grade

systems, and mounds. SWIS applications differ in their geometry and location in the soil profile. Trenches have a large length-to-width ratio, while beds have a wide, rectangular or square geometry. Seepage pits are deep, circular excavations that rely almost completely on sidewall infiltration. Seepage pits are no longer permitted in many jurisdictions because their depth and relatively small horizontal profile create a greater point-source pollutant loading potential to ground water than other geometries. Because of these shortcomings, seepage pits are not recommended in this manual.

Infiltration surfaces may be created in natural soil or imported fill material. Most traditional systems are constructed below ground surface in natural soil. In some instances, a restrictive horizon above a more permeable horizon may be removed and the excavation filled with suitable porous material in which to construct the infiltration surface (Hinson et al., 1994). Infiltration surfaces may be constructed at the ground surface (“at-grades”) or elevated in imported fill material above the natural soil surface (“mounds”). An important difference between infiltration surfaces constructed in natural soil and those constructed in fill material is that a secondary infiltrative surface (which must be considered in design) is created at the fill/natural soil interface. Despite the differences between the types of SWISs, the mechanisms of treatment and dispersal are similar.

### **4.3.2 Typical applications**

Subsurface wastewater infiltration systems are passive, effective, and inexpensive treatment systems because the assimilative capacity of many soils can transform and recycle most pollutants found in domestic and commercial wastewaters. SWISs are the treatment method of choice in rural, unsewered areas. Where point discharges to surface waters are not permitted, SWISs offer an alternative if ground water is not closely interconnected with surface water. Soil characteristics, lot size, and the proximity of sensitive water resources affect the use of SWISs. Table 4-2 presents characteristics for typical SWIS applications and suggests applications to avoid. Local codes should be consulted for special requirements, restrictions, and other relevant information.

**Table 4-2. Characteristics of typical SWIS applications**

Characteristic	Typical application	Applications to avoid <sup>a</sup>
Type of wastewater	Domestic and commercial (residential, mobile home parks, campgrounds, schools, restaurants, etc.)	Facilities with non-sanitary and/or industrial wastewaters. Check local codes for other possible restrictions
Daily flow	< 20 population equivalents unless a management entity exists	> 20 population equivalents without a management program. Check local codes for specific or special conditions (e.g., USEPA or state Underground Injection Control Program Class V rule)
Minimum pretreatment	Septic tank, Imhoff tank	Discharge of raw wastewater to SWIS
Lot orientation	Loading along contour(s) must not exceed the allowable contour loading rate	Any site where hydraulic loads from the system will exceed allowable contour loading rates
Landscape position	Ridge lines, hilltops, shoulder/side slopes	Depressions, foot slopes, concave slopes, floodplains
Topography	Planar, mildly undulating slopes of $\leq 20\%$ grade	Complex slopes of $> 30\%$
Soil texture	Sands to clay loams	Very fine sands, heavy clays, expandable clays
Soil structure	Granular, blocky	Platy, prismatic, or massive soils
Drainage	Moderately drained or well drained sites	Extremely well, somewhat poor, or very poorly drained sites
Depth to ground water or bedrock	> 5 feet	< 2 feet. Check local codes for specific requirements.

<sup>a</sup>Avoid when possible.

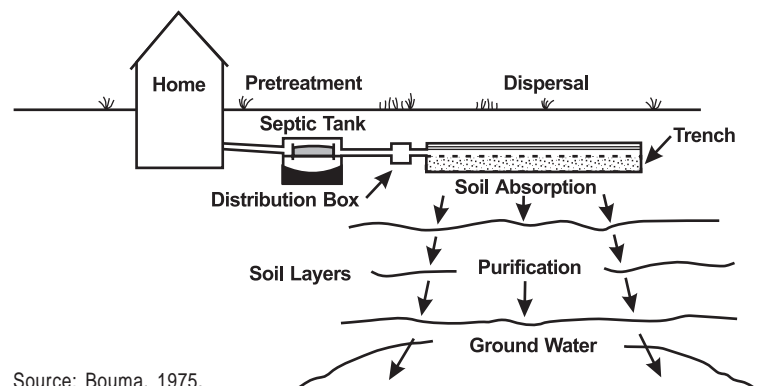
Source: Adapted from WEF, 1990.

### 4.3.3 Typical performance

Results from numerous studies have shown that SWISs achieve high removal rates for most wastewater pollutants of concern (see chapter 3) with the notable exception of nitrogen. Biochemical oxygen demand, suspended solids, fecal indicators, and surfactants are effectively removed within 2 to 5 feet of unsaturated, aerobic soil (figure 4-2). Phosphorus and metals are removed through adsorption, ion exchange, and precipitation reactions. However, the retention capacity of the soil is finite and varies with soil mineralogy, organic content, pH, redox potential, and cation exchange capacity. The fate of viruses and toxic organic compounds has not been well documented (Tomson et al., 1984). Field and laboratory studies suggest that the soil is quite effective in removing viruses, but some types of viruses apparently are able to leach from SWISs to the ground water. Fine-textured soils, low hydraulic loadings, aerobic subsoils, and high temperatures favor destruction of viruses and toxic organics. The most significant documented threats to ground water quality from

SWISs are nitrates. Wastewater nitrogen is nearly completely nitrified below properly operating SWISs. Because nitrate is highly soluble and environments favoring denitrification in subsoil are limited, little removal occurs (see chapter 3). Chlorides also leach readily to ground water because they, too, are highly soluble and are nonreactive in soil.

**Figure 4-2. Lateral view of conventional SWIS-based system**



Dispersion of SWIS percolate in the ground water is often minimal because most ground water flow is laminar. The percolate can remain for several hundred feet as a distinct plume in which the solute concentrations remain above ambient ground water concentrations (Robertson et al., 1989, Shaw and Turyk, 1994). The plume descends in the ground water as the ground water is recharged from the surface, but the amount of dispersion of the plume can be variable. Thus, drinking water wells some distance from a SWIS can be threatened if they are directly in the path of a percolate plume.

## 4.4 Design considerations

Onsite wastewater treatment system designs vary according to the site and wastewater characteristics encountered. However, all designs should strive to incorporate the following features to achieve satisfactory long-term performance:

- Shallow placement of the infiltration surface (< 2 feet below final grade)
- Organic loading comparable to that of septic tank effluent at its recommended hydraulic loading rate
- Trench orientation parallel to surface contours
- Narrow trenches (< 3 feet wide)
- Timed dosing with peak flow storage
- Uniform application of wastewater over the infiltration surface
- Multiple cells to provide periodic resting, standby capacity, and space for future repairs or replacement

Based on the site characteristics, compromises to ideal system designs are necessary. However, the designer should attempt to include as many of the above features as possible to ensure optimal long-term performance and minimal impact on public health and environmental quality.

### 4.4.1 Placement of the infiltration surface

Placement of a SWIS infiltration surface may be below, at, or above the existing ground surface (in an in-ground trench, at grade, or elevated in a

mound system). Actual placement relative to the original soil profile at the site is determined by desired separation from a limiting condition (figure 4-3). Treatment by removal of additional pollutants during movement through soils and the potential for excessive ground water mounding will control the minimum separation distance from a limiting condition. The depth below final grade is affected by subsoil reaeration potential. Maximum delivery of oxygen to the infiltration zone is most likely when soil components are shallow and narrow and have separated infiltration areas. (Erickson and Tyler, 2001).

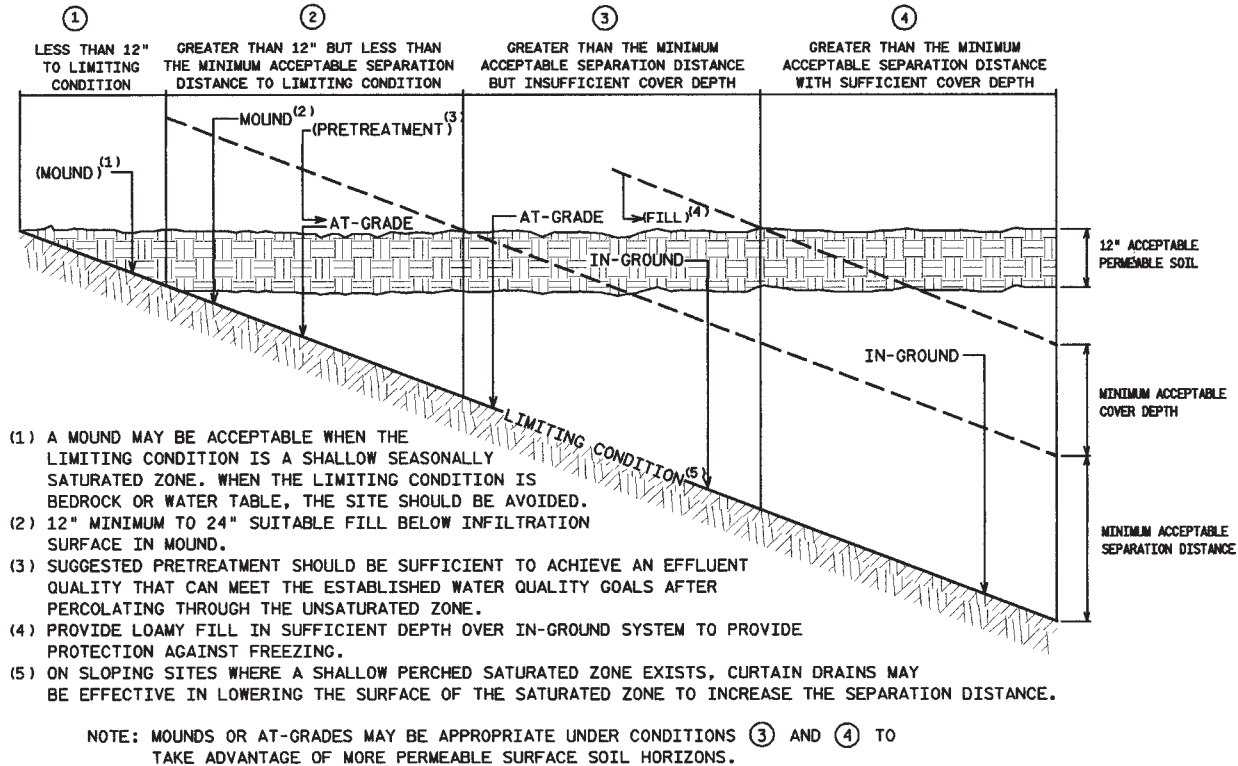
### 4.4.2 Separation distance from a limiting condition

Placement of the infiltration surface in the soil profile is determined by both treatment and hydraulic performance requirements. Adequate separation between the infiltration surface and any saturated zone or hydraulically restrictive horizon within the soil profile (secondary design boundary as defined in section 5.3.1) must be maintained to achieve acceptable pollutant removals, sustain aerobic conditions in the subsoil, and provide an adequate hydraulic gradient across the infiltration zone. Treatment needs (performance requirements) establish the minimum separation distance, but the potential for ground water mounding or the availability of more permeable soil may make it advantageous to increase the separation distance by raising the infiltration surface in the soil profile.

Most current onsite wastewater system codes require minimum separation distances of at least 18 inches from the seasonally high water table or saturated zone irrespective of soil characteristics. Generally, 2- to 4-foot separation distances have proven to be adequate in removing most fecal coliforms in septic tank effluent (Ayres Associates, 1993). However, studies have shown that the applied effluent quality, hydraulic loading rates, and wastewater distribution methods can affect the unsaturated soil depth necessary to achieve acceptable wastewater pollutant removals. A few studies have shown that separation distances of 12 to 18 inches are sufficient to achieve good fecal coliform removal if the wastewater receives additional pretreatment prior to soil application (Converse and Tyler, 1998a, 1998b; Duncan et al., 1994). However, when effluents with lower organic and



Figure 4-3. Suggested subsurface infiltration system design versus depth (below the original ground surface) to a limiting condition



Source: Otis, 2001.

oxygen-demanding content are applied to the infiltration surface at greater hydraulic loading rates than those typically used for septic tank effluents (during extended periods of peak flow), treatment efficiency can be lost (Converse and Tyler, 1998b, Siegrist et al., 2000).

Reducing the hydraulic loading rate or providing uniform distribution of the septic tank effluent has been shown to reduce the needed separation distance (Bomblat et al., 1994; Converse and Tyler, 1998a; Otis, 1985; Siegrist et al., 2000; Simon and Reneau, 1987). Reducing both the daily and instantaneous hydraulic loading rates and providing uniform distribution over the infiltration surface can help maintain lower soil moisture levels. Lower soil moisture results in longer wastewater retention times in the soil and causes the wastewater to flow through the smaller soil pores in the unsaturated zone, both of which enhance treatment and can reduce the necessary separation distance.

Based only on hydraulics, certain soils require different vertical separation distances from ground

water to avoid hydrologic interference with the infiltration rate. From a treatment standpoint, required separation distances are affected by dosing pattern, loading rate, temperature, and soil characteristics. Uniform, frequent dosing (more than 12 times/day) in coarser soils maximizes the effectiveness of biological, chemical, and physical treatment mechanisms. To offset inadequate vertical separation, a system designer can raise the infiltration surface in an at-grade system or incorporate a mound in the design. If the restrictive horizon is a high water table and the soil is porous, the water table can be lowered through the use of drainage tile or a curtain drain if the site has sufficient relief to promote surface discharge from the tile piping. For flat terrain with porous soils, a commercial system has been developed and is being field tested. It lowers the water table with air pressure, thereby avoiding any aesthetic concerns associated with a raised mound on the site. Another option used where the terrain is flat and wet is pumped drainage surrounding the OWTS (or throughout the subdivision) to lower the seasonal high water table and enhance aerobic conditions beneath the

drainfield. These systems must be properly operated by certified operators and managed by a public management entity since maintenance of off-lot portions of the drainage network will influence performance of the SWIS.

The hydraulic capacity of the site or the hydraulic conductivity of the soil may increase the minimum acceptable separation distance determined by treatment needs. The soil below the infiltration surface must be capable of accepting and transmitting the wastewater to maintain the desired unsaturated separation distance at the design hydraulic loading rate to the SWIS. The separation distance necessary for satisfactory hydraulic performance is a function of the permeability of the underlying soil, the depth to the limiting condition, the thickness of the saturated zone, the percentage of rocks in the soil, and the hydraulic gradient. Ground water mounding analyses may be necessary to assess the potential for the saturated zone to rise and encroach upon the minimum acceptable separation distance (see section 5.4). Raising the infiltration surface can increase the hydraulic capacity of the site by accommodating more mounding. If the underlying soil is more slowly permeable than soil horizons higher in the profile, it might be advantageous to raise the infiltration surface into the more permeable horizon where higher hydraulic loading rates are possible (Hoover et al., 1991; Weymann et al., 1998). A shallow infiltration system covered with fill or an at-grade system can be used if the natural soil has a shallow permeable soil horizon (Converse et al., 1990; Penninger, and Hoover, 1998). If more permeable horizons do not exist, a mound system constructed of suitable sand fill (figure 4-4) can provide more permeable material in which to place the infiltration surface.

#### **4.4.3 Depth of the infiltration surface**

The depth of the infiltration surface is an important consideration in maintaining adequate subsoil aeration and frost protection in cold climates. The maximum depth should be limited to no more than 3 to 4 feet below final grade to adequately re-aerate the soil and satisfy the daily oxygen demand of the applied wastewater. The infiltrative surface depth should be less in slowly permeable soils or soils with higher ambient moisture. Placement below this depth to take advantage of more permeable

soils should be resisted because re-aeration of the soil below the infiltration surface will be limited. In cold climates, a minimum depth of 1 to 2 feet may be necessary to protect against freezing. Porous fill material can be used to provide the necessary cover even with an elevated (at-grade or mound) system if it is necessary to place the infiltration surface higher.

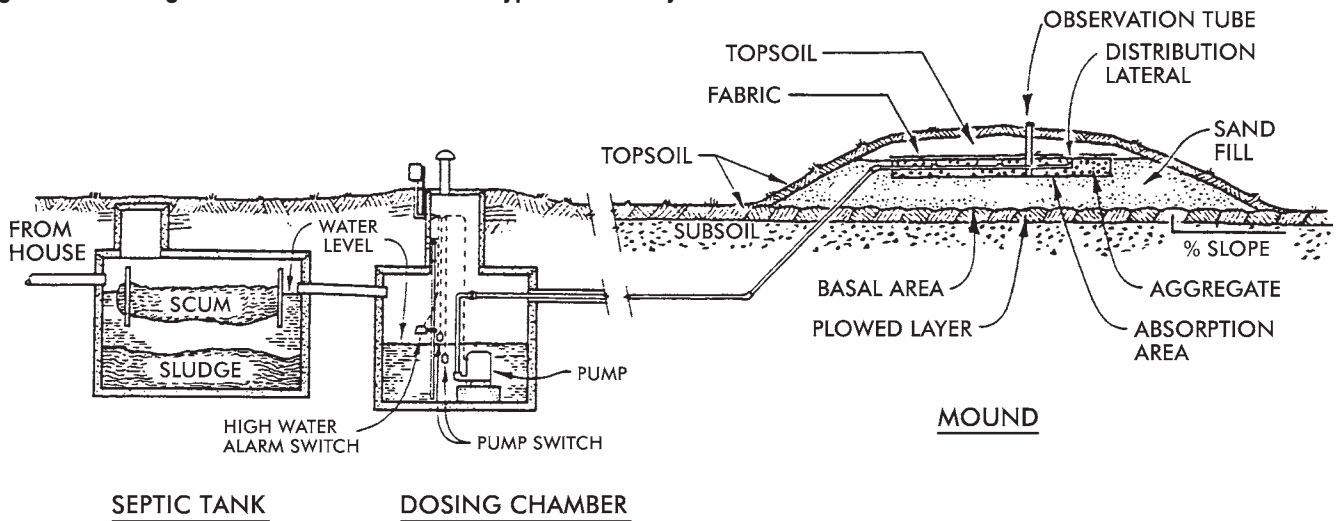
#### **4.4.4 Subsurface drainage**

Soils with shallow saturated zones sometimes can be drained to allow the infiltration surface to be placed in the natural soil. Curtain drains, vertical drains, underdrains, and mechanically assisted commercial systems can be used to drain shallow water tables or perched saturated zones. Of the three, curtain drains are most often used in onsite wastewater systems to any great extent. They can be used effectively to remove water that is perched over a slowly permeable horizon on a sloping site. However, poorly drained soils often indicate other soil and site limitations that improved drainage alone will not overcome, so the use of drainage enhancements must be carefully considered. Any sloping site that is subject to frequent inundation during prolonged rainfall should be considered a candidate for upslope curtain drains to maintain unsaturated conditions in the vadose zone.

Curtain drains are installed upslope of the SWIS to intercept the permanent and perched ground water flowing through the site over a restrictive horizon. Perforated pipe is laid in the bottom of upslope trenches excavated into the restrictive horizon. A durable, porous medium is placed around the piping and up to a level above the estimated seasonally high saturated zone. The porous medium intercepts the ground water and conveys it to the drainage pipe (figure 4-5). To provide an outfall for the drain, one or both ends of the pipe are extended downslope to a point where it intercepts the ground surface. When drainage enhancements are used, the outlet and boundary conditions must be carefully evaluated to protect local water quality.

The drain should avoid capture of the SWIS percolate plume and ground water infiltrating from below the SWIS or near the end of the drain. A separation distance between the SWIS and the drain that is sufficient to prevent percolate from the

Figure 4-4. Raising the infiltration surface with a typical mound system.



Source: ASAE, Converse and Tyler, 1998b.

SWIS from entering the drain should be maintained. The vertical distance between the bottom of the SWIS and the drain and soil permeability characteristics should determine this distance. As the vertical distance increases and the permeability decreases, the necessary separation distance increases. A 10-foot separation is used for most applications. Also, if both ends of the drain cannot be extended to the ground surface, the upslope end should be extended some distance along the surface contour beyond the end of the SWIS. If not done,

ground water that seeps around the end of the drain can render the drain ineffective. Similar cautions should be observed when designing and locating outlet locations for commercial systems on flat sites.

The design of a curtain drain is based on the permeability of the soil in the saturated zone, the size of the area upslope of the SWIS that contributes water to the saturated zone, the gradient of the drainage pipe, and a suitable outlet configuration.

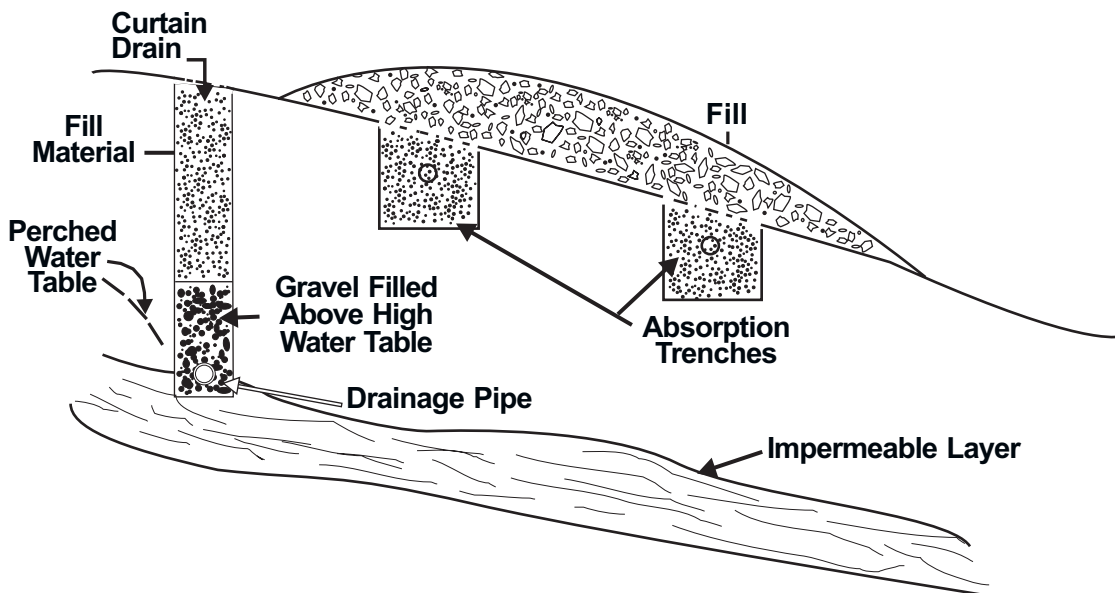


Figure 4-5. Schematic of curtain drain construction

If the saturated hydraulic conductivity is low and the drainable porosity (the percentage of pore space drained when the soil is at field capacity) is small, even effectively designed curtain drains might have limited effect on soil wetness conditions. Penninger et al. (1998) illustrated this at a site with a silty clay loam soil at field capacity that became completely re-saturated with as little as 1-inch of precipitation. Figure 4-6 provides a useful design chart that considers most of these parameters. For further design guidance, refer to the U.S. Department of Agriculture's *Drainage of Agricultural Land* (USDA, 1973).

### 4.4.5 Sizing of the infiltration surface

The minimum acceptable infiltration surface area is a function of the maximum anticipated daily wastewater volume to be applied and the maximum instantaneous and daily mass loading limitations of the infiltration surface (see chapter 5). Both the bottom and sidewall area of the SWIS excavation can be infiltration surfaces; however, if the sidewall is to be an active infiltration surface, the bottom surface must pond. If continuous ponding of the infiltration surface persists, the infiltration zone will become anaerobic, resulting in loss of hydraulic capacity. Loss of the bottom surface for infiltration will cause the ponding depth to increase over time as the sidewall also clogs (Bouma, 1975; Keys et al., 1998; Otis, 1977). If allowed to continue,

hydraulic failure of the system is probable. Therefore, including sidewall area as an active infiltration surface in design should be avoided. If sidewall areas are included, provisions should be made in the design to enable removal of the ponded system from service periodically to allow the system to drain and the biomat to oxidize naturally.

### Design flow

An accurate estimation of the design flow is critical to infiltration surface sizing. For existing buildings where significant changes in use are not expected, water service metering will provide good estimates for design. It is best to obtain several weeks of metered daily flows to estimate daily average and peak flows. For new construction, water use metering is not possible and thus waste flow projections must be made based on similar establishments. Tables of "typical" water use or wastewater flows for different water use fixtures, usage patterns, and building uses are available (see section 3.3.1). Incorporated into these guidelines are varying factors of safety. As a result, the use of these guides typically provides conservatively high estimates of maximum peak flows that may occur only occasionally. It is critical that the designer recognizes the conservativeness of these guides and how they can be appropriately adjusted because of their impacts on the design and, ultimately, performance of the system.

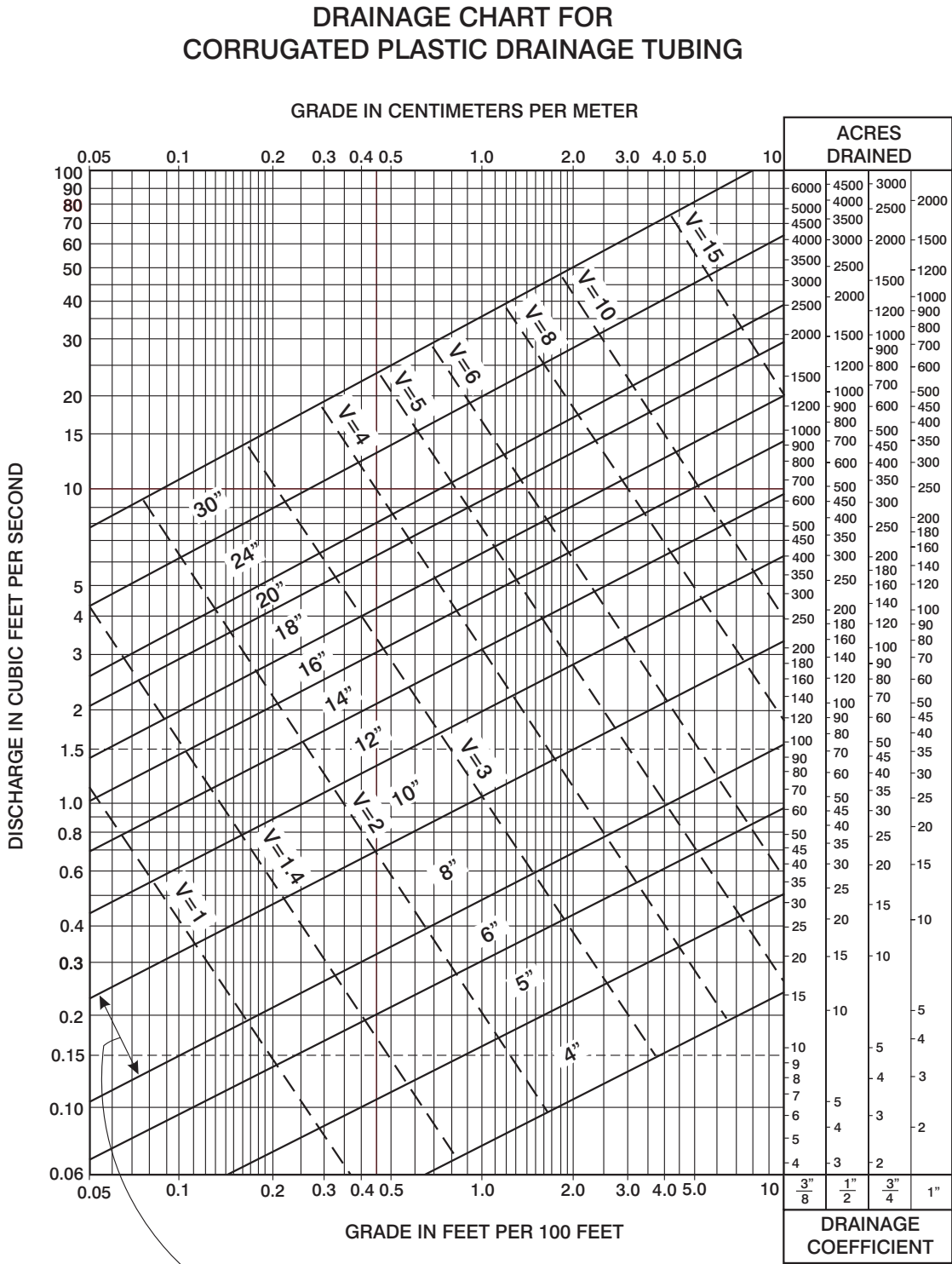
### Curtain drain design

Curtain drain design (see preceding figures) is dependent on the size of the contributing drainage area, the amount of water that must be removed, the soil's hydraulic properties, and the available slope of the site.

The contributing drainage area is estimated by outlining the capture zone on a topographic map of the site. Drainage boundaries are determined by extending flow lines perpendicular to the topographic contours upslope from the drain to natural divides (e.g., ridge tops) or natural or man-made "no-flow" boundaries (e.g., rock outcrops, major roads). The amount of water that must be removed is an estimate of the volume of precipitation that would be absorbed by the soil after a rainfall event. This is called the *drainage coefficient*, which is expressed as the depth of water to be removed over a specified period of time, typically 24 hours. Soil structure, texture, bulk density, slope, and vegetated cover all affect the volume of water to be drained.

The slope of the drain can be determined after the upslope depth of the drain invert and the outfall invert are established. These can be estimated from the topographic map of the site. The contributing drainage area, water volume to be removed, and slope of the drain are estimated. Figure 4-6 can be used to determine the drain diameter. For example, the diameter of a curtain drain that will drain an area upslope of 50 acres with a drainage coefficient of  $\frac{3}{4}$  inch on a slope of 5 percent would be 8 inches (see figure). At 0.5 percent, the necessary drain diameter would be 12 inches.

Figure 4-6. Capacity chart for subsurface drains



Source: USDA, 1973.



**Infiltration surface loading limitations**

Infiltration surface hydraulic loading design rates are a function of soil morphology, wastewater strength, and SWIS design configuration. Hydraulic loadings are traditionally used to size infiltration surfaces for domestic septic tank effluent. In the past, soil percolation tests determined acceptable hydraulic loading rates. Codes provided tables that correlated percolation test results to the necessary infiltration surface areas for different classes of soils. Most states have supplemented this approach with soil morphologic descriptions. Morphologic features of the soil, particularly structure, texture, and consistence, are better predictors of the soil's hydraulic capacity than percolation tests (Brown et al., 1994; Gross et al., 1998; Kleiss and Hoover,

1986; Simon and Reneau, 1987; Tyler et al., 1991; Tyler and Converse, 1994). Although soil texture analysis supplemented the percolation test in most states by the mid-1990s, soil structure has only recently been included in infiltrative surface sizing tables (table 4-3). Consistence, a measure of how well soils form shapes and stick to other objects, is an important consideration for many slowly permeable soil horizons. Expansive clay soils that become extremely firm when moist and very sticky or plastic when wet (exhibiting firm or extremely firm consistence) are not well suited for SWISs.

Not all soil conditions are represented in table 4-3, which is a generic guide to the effects of soil properties on the performance of SWISs. Also

**Table 4-3. Suggested hydraulic and organic loading rates for sizing infiltration surfaces**

Texture	Structure		Hydraulic loading (gal/ft <sup>2</sup> -day)		Organic loading (lb BOD/1000ft <sup>2</sup> -day)	
	Shape	Grade	BOD=150	BOD=30	BOD=150	BOD=30
Coarse sand, sand, loamy coarse sand, loamy sand	Single grain	Structureless	0.8	1.6	1.00	0.40
Fine sand, very fine sand, loamy fine sand, loamy very fine sand	Single grain	Structureless	0.4	1.0	0.50	0.25
Coarse sandy loam, sandy loam	Massive	Structureless	0.2	0.6	0.25	0.15
	Platy	Weak	0.2	0.5	0.25	0.13
		Moderate, strong				
	Prismatic, blocky, granular	Weak	0.4	0.7	0.50	0.18
Moderate, strong		0.6	1.0	0.75	0.25	
Fine sandy loam, very fine sandy loam	Massive	Structureless	0.2	0.5	0.25	0.13
	Platy	Weak, mod., strong				
		Weak	0.2	0.6	0.25	0.15
	Prismatic, blocky, granular	Moderate, strong	0.4	0.8	0.50	0.20
Massive		Structureless	0.2	0.5	0.25	0.13
Loam	Platy	Weak, mod., strong				
		Weak	0.4	0.6	0.50	0.15
	Prismatic, blocky, granular	Moderate, strong	0.6	0.8	0.75	0.20
		Massive	Structureless		0.2	0.00
Silt loam	Platy	Weak, mod., strong				
		Weak	0.4	0.6	0.50	0.15
	Prismatic, blocky, granular	Moderate, strong	0.6	0.8	0.75	0.20
		Massive	Structureless			
Sandy clay loam, clay loam, silty clay loam	Platy	Weak, mod., strong				
		Weak	0.2	0.3	0.25	0.08
	Prismatic, blocky, granular	Moderate, strong	0.4	0.6	0.50	0.15
		Massive	Structureless			
Sandy clay, clay, silty clay	Platy	Weak, mod., strong				
		Weak				
	Prismatic, blocky, granular	Weak				
		Moderate, strong	0.2	0.3	0.25	0.08

Source: Adapted from Tyler, 2000.

available are many other state and local guides that include loadings for soils specific to local geomorphology. North Carolina, for example, uses the *long-term acceptance rate* (LTAR) for soil loadings, which is the volume of wastewater that can be applied to a square foot of soil each day over an indefinite period of time such that the effluent from the onsite system is absorbed and properly treated (North Carolina DEHNR, 1996). In the North Carolina rules, LTAR and loading rate values are the same.

Increasingly, organic loading is being used to size infiltration surfaces. Based on current understanding of the mechanisms of SWIS operation, organic loadings and the reaeration potential of the subsoil to meet the applied oxygen demand are critical considerations in successful SWIS design. Anaerobic conditions are created when the applied oxygen demand exceeds what the soil is able to supply by diffusion through the vadose zone (Otis, 1985, 1997; Siegrist et al., 1986). The facultative and anaerobic microorganisms that are able to thrive in this environment are less efficient in degrading the waste materials. The accumulating waste materials and the metabolic by-products cause soil clogging and loss of infiltrative capacity.

Further, higher forms of soil fauna that would help break up the biomat (e.g., worms, insects, non-wetland plants) and would be attracted to the carbon and nutrient-rich infiltration zone are repelled by the anoxic or anaerobic environment. If wastewater application continues without ample time to satisfy the oxygen demand, hydraulic failure due to soil clogging occurs. Numerous studies have shown that wastewaters with low BOD concentrations (e.g., < 50 mg/L) can be applied to soils at rates 2 to 16 times the typical hydraulic loading rate for domestic septic tank effluent (Jones and Taylor, 1965; Laak, 1970, 1986; Loudon et al., 1998; Otis, 1985; Siegrist and Boyle, 1987; Tyler and Converse, 1994).

The comparatively higher hydraulic loadings that highly treated wastewater (highly treated in terms of TSS, ammonium-nitrogen, and BOD) may permit should be considered carefully because the resulting rapid flow through the soil may allow deep penetration of pathogens (Converse and Tyler, 1998a, 1998b; Siegrist et al., 2000; Siegrist and Van Cuyk, 2001b; Tyler and Converse, 1994). The trench length perpendicular to ground water

movement (footprint) should remain the same to minimize system impacts on the aquifer.

Unfortunately, well-tested organic loading rates for various classes of soils and SWIS design configurations have not been developed. Most organic loading rates have been derived directly from the hydraulic loadings typically used in SWIS design by assuming a BOD<sub>5</sub> concentration (see box and table 4-3). The derived organic loading rates also incorporate the implicit factor of safety found in the hydraulic loading rates. Organic loadings do appear to have less impact on slowly permeable soils because the resistance of the biomat that forms at the infiltrative surface presents less resistance to infiltration of the wastewater than the soil itself (Bouma, 1975). For a further discussion of SWIS performance under various environmental conditions, see Siegrist and Van Cuyk, 2001b.

### Constituent mass loadings

Constituent mass loadings may be a concern with respect to water quality. For example, to use the soil's capacity to adsorb and retain phosphorus when systems are located near sensitive surface waters, a phosphorus loading rate based on the soil adsorption capacity might be selected as the controlling rate of wastewater application to the infiltration surface to maximize phosphorus removal. Placement of the effluent distribution piping high in the soil profile can promote greater phosphorus removal because the permeability of medium- and fine-textured soils tends to decrease with depth and because the translocation of aluminum and iron—which react with phosphorus to form insoluble compounds retained in the soil matrix—occurs in some sandy soils, with the maximum accumulation usually above 45 cm (Mokma et al., 2001). Many lakes are surrounded by sandy soils with a low phosphorus adsorption capacity. If effluent distribution systems are installed below 45 cm in these sandy soils, less phosphorus will be removed from the percolating effluent. In the case of a soluble constituent of concern such as nitrate-nitrogen, a designer might decide to reduce the mass of nitrate per unit of application area. This would have the effect of increasing the size of the SWIS footprint, thereby reducing the potential concentration of nitrate in the ground water immediately surrounding the SWIS (Otis, 2001).

### Factors of safety in infiltration surface sizing

Sizing of onsite wastewater systems for single-family homes is typically based on the estimated peak daily flow and the “long term acceptance rate” of the soil for septic tank effluent. In most states, the design flow is based on the number of bedrooms in the house. A daily flow of 150 gallons is commonly assumed for each bedroom. This daily flow per bedroom assumes two people per bedroom that generate 75 gpd each. Bedrooms, rather than current occupancy, are used for the basis of SWIS design because the number of occupants in the house can change.

Using this typical estimating procedure, a three-bedroom home would have a design flow of 150 gpd/bedroom x 3 bedrooms or 450 gpd. However, the actual daily average flow could be much less. Based on the 1990 census, the average home is occupied by 2.8 persons. Each person in the United States generates 45 to 70 gpd of domestic wastewater. Assuming these averages, the average daily flow would be 125 to 195 gpd or 28 to 44 percent of the design flow, respectively. Therefore, the design flow includes an implicit factor of safety of 2.3 to 3.6. Of course, this factor of safety varies inversely with the home occupancy and water use.

Unfortunately, the factors of safety implicitly built into the flow estimates are seldom recognized. This is particularly true in the case of the design hydraulic loading rates, which were derived from existing SWISs. In most codes, the hydraulic loading rates for sand are about 1.0 to 1.25 gpd/ft<sup>2</sup>. Because these hydraulic loading rates assume daily flows of 150 gpd per bedroom, they are overestimated by a factor of 2.3 to 3.6. Fortunately, these two assumptions largely cancel each other out in residential applications, but the suggested hydraulic loading rates often are used to size commercial systems and systems for schools and similar facilities, where the ratios between design flows and actual daily flows are closer to 1.0. This situation, combined with a lack of useful information on allowable organic loading rates, has resulted in failures, particularly for larger systems where actual flow approximates design.

#### 4.4.6 Geometry, orientation, and configuration of the infiltration surface

The geometry, orientation, and configuration of the infiltration surface are critical design factors that affect the performance of SWISs. They are important for promoting subsoil aeration, maintaining an acceptable separation distance from a saturated zone or restrictive horizon, and facilitating construction. Table 4-4 lists the design considerations discussed in this section.

##### Geometry

The width and length of the infiltration surface are important design considerations to improve performance and limit impacts on the receiving environment. Trenches, beds, and seepage pits (or dry wells) are traditionally used geometries. Seepage pits can be effective for wastewater dispersal, but they provide little treatment because they extend deep into the soil profile, where oxygen transfer and treatment are limited and the separation distance to ground water is reduced. They are not recommended for onsite wastewater treatment and are not included as an option in this manual.

##### Width

Infiltration surface clogging and the resulting loss of infiltrative capacity are less where the infiltration surface is narrow. This appears to occur because reaeration of the soil below a narrow infiltration surface is more rapid. The dominant pathway for oxygen transport to the subsoil appears to be diffusion through the soil surrounding the infiltration surface (figure 4-7). The unsaturated zone below a wide surface quickly becomes anaerobic because the rates of oxygen diffusion are too low to meet the oxygen demands of biota and organics on the infiltration surface. (Otis, 1985; Siegrist et al., 1986). Therefore, trenches perform better than beds. Typical trench widths range from 1 to 4 feet. Narrower trenches are preferred, but soil conditions and construction techniques might limit how narrow a trench can be constructed. On sloping sites, narrow trenches are a necessity because in keeping the infiltration surface level, the uphill side of the trench bottom might be excavated into a less suitable soil horizon. Wider trench infiltration surfaces have been successful in at-grade systems and mounds probably because the engineered fill material and elevation above the natural grade promote better reaeration of the fill.

### Comparing hydraulic and organic mass loadings for a restaurant wastewater

Infiltration surface sizing traditionally has been based on the daily hydraulic load determined through experience to be acceptable for the soil characteristics. This approach to sizing fails to account for changes in applied wastewater strength. Since soil clogging has been shown to be dependent on applied wastewater strength, it might be more appropriate to size infiltration surfaces based on organic mass loadings.

To illustrate the impact of the different sizing methods, sizing computations for a restaurant are compared. A septic tank is used for pretreatment prior to application to the SWIS. The SWIS is to be constructed in a sandy loam with a moderate, subangular blocky structure. The suggested hydraulic loading rate for domestic septic tank effluent on this soil is 0.6 gpd/ft<sup>2</sup> (table 4-3). The restaurant septic tank effluent has the following characteristics:

BOD<sub>5</sub>            800 mg/L  
 TSS                200 mg/L  
 Average daily flow    600 gpd

#### Infiltration area based on hydraulic loading:

$$\text{Area} = 600 \text{ gpd} / 0.6 \text{ gpd/ft}^2 = 1,000 \text{ ft}^2$$

#### Infiltration area based on organic loading:

At the design infiltration rate of 0.6 gpd/ft<sup>2</sup> recommended for domestic septic tank effluent, the equivalent organic loading is (assuming a septic tank BOD<sub>5</sub> effluent concentration of 150 mg/L)

$$\begin{aligned} \text{Organic Loading} &= 150 \text{ mg/L} \times 0.6 \text{ gpd/ft}^2 \times (8.34 \text{ lb/mg/L} \times 10^{-6} \text{ gal}) \\ &= 7.5 \times 10^{-4} \text{ lb BOD}_5/\text{ft}^2\text{-d} \end{aligned}$$

Assuming 7.5 x 10<sup>-4</sup> lb BOD<sub>5</sub>/ft<sup>2</sup>-d as the design organic loading rate,

$$\begin{aligned} \text{Area} &= \frac{(800 \text{ mg-BOD}_5/\text{L} \times 600 \text{ gpd} \times 8.34 \text{ lbs/mg/L} \times 10^{-6} \text{ gal})}{(7.5 \times 10^{-4} \text{ lb BOD}_5/\text{ft}^2\text{-d})} \\ &= \frac{4.0 \text{ lb BOD}_5/\text{d}}{(7.5 \times 10^{-4} \text{ lb BOD}_5/\text{ft}^2\text{-d})} = 5337 \text{ ft}^2 \text{ (a 540\% increase)} \end{aligned}$$

#### Impact of a 40% water use reduction on infiltration area sizing

Based on hydraulic loading,

$$\text{Area} = \frac{(1 - 0.4) \times 600 \text{ gpd}}{0.6 \text{ gpd/ft}^2} = 600 \text{ ft}^2$$

Based on organic loading (note the concentration of BOD<sub>5</sub> increases with water conservation but the mass of BOD<sub>5</sub> discharged does not change),

$$\begin{aligned} \text{Area} &= \frac{(800 \text{ mg-BOD}_5/\text{L} \times 600 \text{ gpd}) \times (8.34 \text{ lb/mg/L} \times 10^{-6} \text{ gal})}{[(1 - 0.4) \times 600 \text{ gpd}] \times (7.5 \times 10^{-4} \text{ lb BOD}_5/\text{ft}^2\text{-d})} \\ &= \frac{4.0 \text{ lb BOD}_5/\text{d}}{(7.5 \times 10^{-4} \text{ lb BOD}_5/\text{ft}^2\text{-d})} = 5337 \text{ ft}^2 \text{ (an 890\% increase)} \end{aligned}$$

However, infiltration bed surface widths of greater than 10 feet are not recommended because oxygen transfer and clogging problems can occur (Converse and Tyler, 2000; Converse et al., 1990).

#### Length

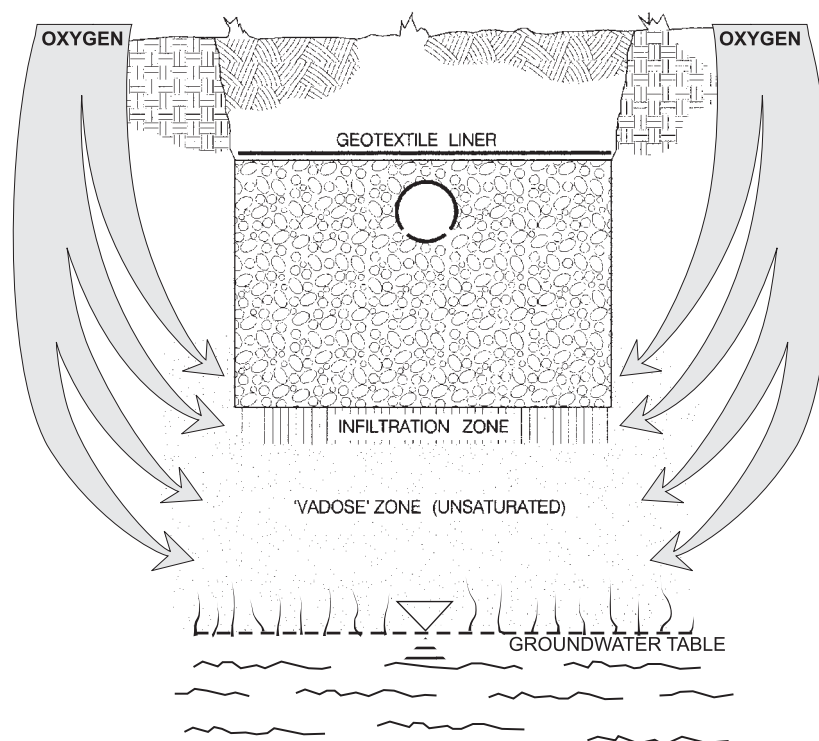
The trench length is important where downslope linear loadings are critical, ground water quality impacts are a concern, or the potential for ground

water mounding exists. In many jurisdictions, trench lengths have been limited to 100 feet. This restriction appeared in early codes written for gravity distribution systems and exists as an artifact with little or no practical basis when pressure distribution is used. Trench lengths longer than 100 feet might be necessary to minimize ground water impacts and to permit proper wastewater drainage from the site. Long trenches can be used to reduce the linear loadings on a site by spreading the

Table 4-4. Geometry, orientation, and configuration considerations for SWISs

Design type	Design considerations
<b>Trench</b>	
<i>Geometry</i>	
Width	Preferably less than 3 ft. Design width is affected by distribution method, constructability, and available area.
Length	Restricted by available length parallel to site contour, distribution method, and distribution network design.
Sidewall height	Sidewalls are not considered an active infiltration surface. Minimum height is that needed to encase the distribution piping or to meet peak flow storage requirements.
<i>Orientation/ configuration</i>	Should be constructed parallel to site contours and/or water table or restrictive layer contours. Should not exceed the site's maximum linear hydraulic loading rate per unit of length. Spacing of multiple, parallel trenches is also limited by the construction method and slow dispersion from the trenches.
<b>Bed</b>	
<i>Geometry</i>	
Width	Should be as narrow as possible. Beds wider than 10 to 15 feet should be avoided.
Length	Restricted by available length parallel to site contour, distribution method, and distribution network design.
Sidewall height	Sidewalls are not considered an active infiltration surface. Minimum height is that needed to encase the distribution piping or to meet peak flow storage requirements.
<i>Orientation/ configuration</i>	Should be constructed parallel to site contours and/or water table or restrictive layer contours. The loading over the total projected width should not exceed the estimated downslope maximum linear hydraulic loading.
<b>Seepage pit</b>	Not recommended because of limited treatment capability.

Figure 4-7. Pathway of subsoil reaeration



Source: Ayres Associates, 2000



wastewater loading parallel to and farther along the surface contour. With current distribution/dosing technology, materials, and construction methods, trench lengths need be limited only by what is practical or feasible on a given site. Also, use of standard trench lengths, e.g., X feet of trench/BR, is discouraged because it restricts the design options to optimize performance for a given site condition.

### Height

The height of the sidewall is determined primarily by the type of porous medium used in the system, the depth of the medium needed to encase the distribution piping, and/or storage requirements for peak flows. Because the sidewall is not included as an active infiltration surface in sizing the infiltration area, the height of the sidewall can be minimized to keep the infiltration surface high in the soil profile. A height of 6 inches is usually sufficient for most porous aggregate applications. Use of a gravelless system requires a separate analysis to determine the height based on whether it is an aggregate-free (empty chamber) design or one that substitutes a lightweight aggregate for washed gravel or crushed stone.

### Orientation

Orientation of the infiltration surface(s) becomes an important consideration on sloping sites, sites with shallow soils over a restrictive horizon or saturated zone, and small or irregularly shaped lots. The long axes of trenches should be aligned parallel to the ground surface contours to reduce linear contour hydraulic loadings and ground water mounding potential. In some cases, ground water or restrictive horizon contours may differ from surface contours because of surface grading or the soil's morphological history. Where this occurs, consideration should be given to aligning the trenches with the contours of the limiting condition rather than those of the surface. Extending the trenches perpendicular to the ground water gradient reduces the mass loadings per unit area by creating a "line" source rather than a "point" source along the contour. However, the designer must recognize that the depth of the trenches and the soil horizon in which the infiltration surface is placed will vary across the system. Any adverse impacts this might have on system performance should be mitigated through design adjustments.

### Configuration

The spacing of multiple trenches constructed parallel to one another is determined by the soil characteristics and the method of construction. The sidewall-to-sidewall spacing must be sufficient to enable construction without damage to the adjacent trenches. Only in very tight soils will normally used spacings be inadequate because of high soil wetness and capillary fringe effects, which can limit oxygen transfer. It is important to note that the sum of the hydraulic loadings to one or more trenches or beds per each unit of contour length (when projected downslope) must not exceed the estimated maximum contour loading for the site. Also, the finer (tighter) the soil, the greater the trench spacing should be to provide sufficient oxygen transfer. Quantitative data are lacking, but Camp (1985) reported a lateral impact of more than 2.0 meters in a clay soil.

Given the advantages of lightweight gravelless systems in terms of potentially reduced damage to the site's hydraulic capacity, parallel trenches may physically be placed closer together, but the downslope hydraulic capacity of the site and the natural oxygen diffusion capacity of the soil cannot be exceeded.

#### 4.4.7 Wastewater distribution onto the infiltration surface

The method and pattern of wastewater distribution in a subsurface infiltration system are important design elements. Uniform distribution aids in maintaining unsaturated flow below the infiltration surface, which results in wastewater retention times in the soil that are sufficiently long to effect treatment and promote subsoil reaeration. Uniform distribution design also results in more complete utilization of the infiltration surface.

Gravity flow and dosing are the two most commonly used distribution methods. For each method, various network designs are used (table 4-5). Gravity flow is the most commonly used method because it is simple and inexpensive. This method discharges effluent from the septic tank or other pretreatment tank directly to the infiltration surface as incoming wastewater displaces it from the tank(s). It is characterized by the term "trickle flow" because the effluent is slowly discharged over much of the day. Typically, tank discharges

are too low to flow throughout the distribution network. Thus, distribution is unequal and localized overloading of the infiltration surface occurs with concomitant poor treatment and soil clogging (Bouma, 1975; McGauhey and Winneberger, 1964; Otis, 1985; Robeck et al., 1964).

Dosing, on the other hand, accumulates the wastewater effluent in a dose tank from which the water is periodically discharged under pressure in “doses” to the infiltration system by a pump or siphon. The pretreated wastewater is allowed to accumulate in the dose tank and is discharged when a predetermined water level, water volume, or elapsed time is reached. The dose volumes and discharge rates are usually such that much of the distribution network is filled, resulting in more uniform distribution over the infiltration surface. Dosing outperforms gravity-flow systems because distribution is more uniform. In addition, the periods between doses provide opportunities for the subsoil to drain and reerate before the next dose (Bouma et al., 1974; Hargett et al., 1982; Otis et al., 1977). However, which method is most appropriate depends on the specific application.

### Gravity flow

Gravity flow can be used where there is a sufficient elevation difference between the outlet of the pretreatment tank and the SWIS to allow flow to and through the SWIS by gravity. Gravity flow systems are simple and inexpensive to construct but

are the least efficient method of distribution. Distribution is very uneven over the infiltration surface, resulting in localized overloading (Converse, 1974; McGauhey and Winneberger, 1964; Otis et al., 1978; University of Wisconsin, 1978). Until a biomat forms on the infiltration surface to slow the rate of infiltration, the wastewater residence time in the soil might be too short to effect good treatment. As the biomat continues to form on the overloaded areas, the soil surface becomes clogged, forcing wastewater effluent to flow through the porous medium of the trench until it reaches an unclogged infiltration surface. This phenomenon, known as “progressive clogging,” occurs until the entire infiltration surface is ponded and the sidewalls become the more active infiltration surfaces. Without extended periods of little or no flow to allow the surface to dry, hydraulic failure becomes imminent. Although inefficient, these systems can work well for seasonal homes with intermittent use or for households with low occupancies. Seasonal use of SWISs allows the infiltration surface to dry and the biomat to oxidize, which rejuvenates the infiltration capacity. Low occupancies result in mass loadings of wastewater constituents that are lower and less likely to exceed the soil’s capacity to completely treat the effluent.

#### *Perforated pipe*

Four-inch-diameter perforated plastic pipe is the most commonly used distribution piping for

**Table 4-5. Distribution methods and applications.**

Method	Typical applications
<b>Gravity flow</b>	
4-inch perforated pipe	Single or looped trenches at the same elevation; beds.
Distribution box	Multiple independent trenches on flat or sloping sites.
Serial relief line	Multiple serially connected trenches on a sloping site.
Drop box	Multiple independent trenches on a sloping site.
<b>Dosed distribution</b>	
4-inch perforated pipe (with or without a distribution box)	Single (or multiple) trenches, looped trenches at the same elevation, and beds.
Pressure manifold	Multiple independent trenches on sloping sites.
Rigid pipe pressure network	Multiple independent trenches at the same elevation (a preferred method for larger SWISs)
Dripline pressure network	Multiple independent trenches on flat or sloping sites (a preferred method for larger SWISs)

gravity flow systems. The piping is generally smooth-walled rigid polyvinyl chloride (PVC), or flexible corrugated polyethylene (PE) or acrylonitrile-butadiene-styrene (ABS). One or two rows of holes or slots spaced 12 inches apart are cut into the pipe wall. Typically, the piping is laid level in gravel (figure 4-1) with the holes or slots at the bottom (ASTM, undated). One distribution line is used per trench. In bed systems, multiple lines are installed 3 to 6 feet apart.

*Distribution box*

Distribution boxes are used to divide the wastewater effluent flow among multiple distribution lines. They are shallow, flat bottomed, watertight structures with a single inlet and individual outlets provided at the same elevation for each distribution line. An above-grade cover allows access to the inside of the box. The “d-box” must be laid level on a sound, frost-proof footing to divide the flow evenly among the outlets. Uneven settlement or frost heaving results in unequal flow to the lateral lines because the outlet hole elevations cease to be level. If this occurs, adjustments must be made to reestablish equal division of flow. Several devices can be used. Adjustable weirs that can level the outlet inverts and maintain the same length of weir per outlet are one option. Other options include designs that allow for leveling of the entire box (figure 4-8). The box can also be used to take individual trenches out of service by blocking the outlet to the distribution lateral or raising the outlet weir above the weir elevations for the other outlets. Because of the inevitable movement of d-boxes, their use has been discouraged for many years (USPHS, 1957). However, under a managed care system with regular adjustment, the d-box is acceptable.

*Serial relief line*

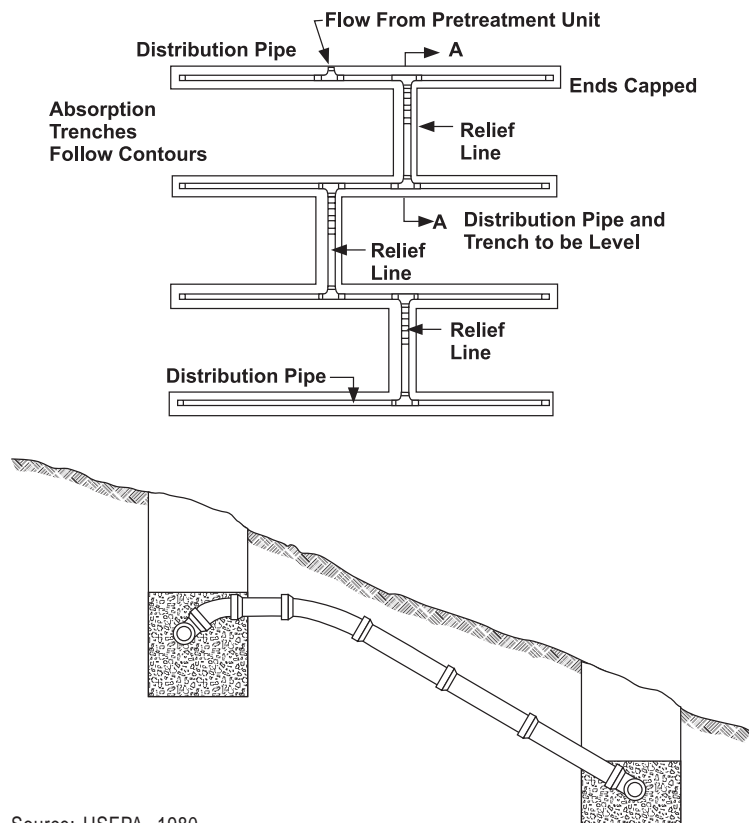
Serial relief lines distribute wastewater to a series of trenches constructed on a sloping site. Rather than dividing the flow equally among all trenches as with a distribution box, the uppermost trench is loaded until completely flooded before the next (lower) trench receives effluent. Similarly, that trench is loaded until flooded before discharge occurs to the next trench, and so on. This method of loading is accomplished by installing “relief lines” between successive trenches (figure 4-9).

Figure 4-8. Distribution box with adjustable weir outlets



Source: Ayres Associates.

Figure 4-9. Serial relief line distribution network and installation detail



Source: USEPA, 1980.

The relief lines are simple overflow lines that connect one trench to the adjacent lower trench. They are solid-wall pipes that connect the crown of the upper trench distribution pipe with the distribution pipe in the lower trench. Successive relief lines are separated by 5 to 10 feet to avoid short-circuiting. This method of distribution makes full hydraulic use of all bottom and sidewall infiltration surfaces, creates the maximum hydrostatic head over the infiltration surfaces to force the water into the surrounding soil, and eliminates the problem of dividing flows evenly among independent trenches. However, because continuous ponding of the infiltration surfaces is necessary for the system to function, the trenches suffer hydraulic failure more rapidly and progressively because the infiltration surfaces cannot regenerate their infiltrative capacity.

#### *Drop box*

Drop box distribution systems function similarly to relief line systems except that drop boxes are used in place of the relief lines. Drop boxes are installed for each trench. They are connected in manifolds to trenches above and below (figure 4-10). The outlet invert can be placed near the top of each trench to force the trench to fill completely before it discharges to the next trench if a serial distribution mode of operation is desired. Solid-wall pipe is used between the boxes.

The advantage of this method over serial relief lines is that individual trenches can be taken out of service by attaching 90 degree ells to the outlets that rise above the invert of the manifold connection to the next trench drop box. It is easier to add additional trenches to a drop box system than to a serial relief line network. Also, the drop box system may be operated as an alternating trench system by using the 90 degree ells on unused lines. With this and the serial distribution system, the designer must carefully evaluate the downslope capacity of the site to ensure that it will not be overloaded when the entire system or specific trench combinations are functioning.

#### **Gravelless wastewater dispersal systems**

Gravelless systems have been widely used. They take many forms, including open-bottomed chambers, fabric-wrapped pipe, and synthetic materials such as expanded polystyrene foam chips (fig-

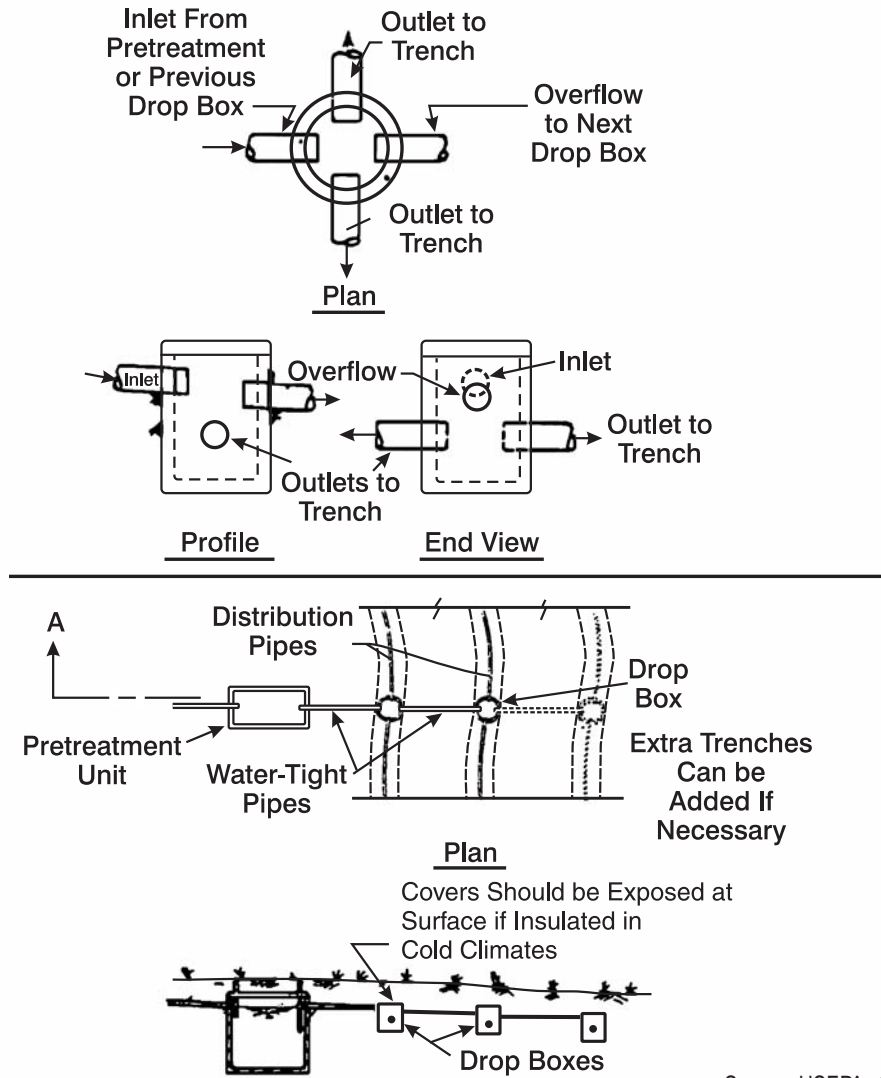
ure 4-11). Some gravelless drain field systems use large-diameter corrugated plastic tubing covered with permeable nylon filter fabric not surrounded by gravel or rock. The area of fabric in contact with the soil provides the surface for the septic tank effluent to infiltrate the soil. The pipe is a minimum of 10 to 12 inches (25.4 to 30.5 centimeters) in diameter covered with spun bonded nylon filter fabric to distribute water around the pipe. The pipe is placed in a 12- to 24-inch (30.5- to 61-centimeter)-wide trench. These systems can be installed in areas with steep slopes with small equipment and in hand-dug trenches where conventional gravel systems would not be possible.

Reduced sizing of the infiltration surface is often promoted as another advantage of the gravelless system. This is based primarily on the premise that gravelless systems do not “mask” the infiltration surface as gravel does where the gravel is in direct contact with the soil. Proponents of this theory claim that an infiltration surface area reduction of 50 percent is warranted. However, these reductions are not based on scientific evidence though they have been codified in some jurisdictions (Amerson et al., 1991; Anderson et al., 1985; Carlile and Osborne, 1982; Effert and Cashell, 1987). Although gravel masking might occur in porous medium applications, reducing the infiltration surface area for gravelless systems increases the BOD mass loading to the available infiltration surface. Many soils might not be able to support the higher organic loading and, as a result, more severe soil clogging and greater penetration of pollutants into the vadose zone and ground water can occur (University of Wisconsin, 1978), negating the benefits of the gravelless surface.

A similar approach must be taken with any contaminant in the pretreatment system effluent that must be removed before it reaches ground water or nearby surface waters. A 50 percent reduction in infiltrative surface area will likely result in less removal of BOD, pathogens, and other contaminants in the vadose zone and increase the presence and concentrations of contaminants in effluent plumes. The relatively confined travel path of a plume provides fewer adsorption sites for removal of adsorbable contaminants (e.g., metals, phosphorus, toxic organics). Because any potential reductions in infiltrative surface area must be analyzed in a similar comprehensive fashion, the use of

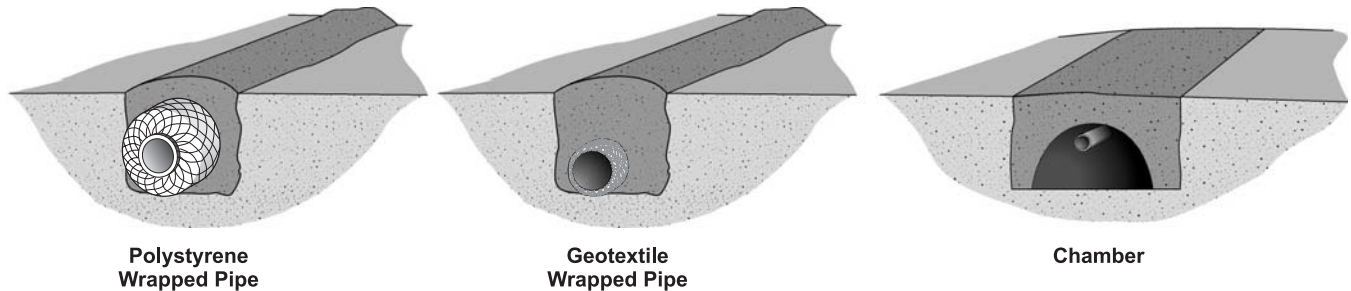


Figure 4-10. Drop box distribution network



Source: USEPA, 1980

Figure 4-11. Various gravelless systems



Source: National Small Flows Clearinghouse.



gravelless medium should be treated similarly to potential reductions from increased pretreatment and better distribution and dosing concepts.

Despite the cautions stated above, the overall inherent value of lightweight gravelless systems should not be ignored, especially in areas where gravel is expensive and at sites that have soils that are susceptible to smearing or other structural damage during construction due to the impacts of heavy machinery on the site. In all applications where gravel is used (see *SWIS Media* in the following section), it must be properly graded and washed. Improperly washed gravel can contribute fines and other material that can plug voids in the infiltrative surface and reduce hydraulic capability. Gravel that is embedded into clay or fine soils during placement can have the same effect.

#### *Leaching chambers*

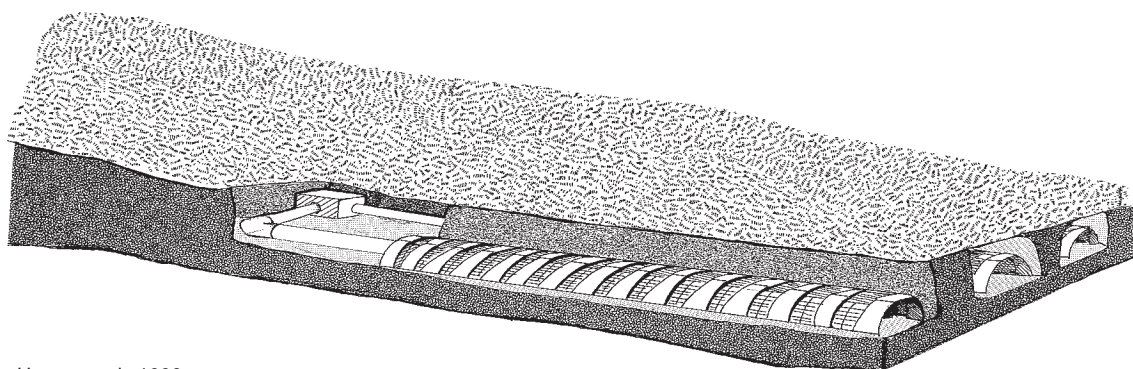
A leaching chamber is a wastewater treatment system that consists of trenches or beds and one or more distribution pipes or open-bottomed plastic chambers. Leaching chambers have two key functions: to disperse the effluent from septic tanks and to distribute this effluent throughout the trenches. A typical leaching chamber consists of several high-density polyethylene injection-molded arch-shaped chamber segments. A typical chamber has an average inside width of 15 to 40 inches (38 to 102 centimeters) and an overall length of 6 to 8 feet (1.8 to 2.4 meters). The chamber segments are usually 1-foot high, with wide slotted sidewalls. Depending on the drain field size requirements, one or more chambers are typically connected to form an underground drain field network.

Typical leaching chambers (figure 4-12) are gravelless systems that have drain field chambers with no bottoms and plastic chamber sidewalls, available in a variety of shapes and sizes. Use of these systems sometimes decreases overall drain field costs and may reduce the number of trees that must be removed from the drain field lot.

About 750,000 chamber systems have been installed over the past 15 years. Currently, a high percentage of new construction applications use lightweight plastic leaching chambers for new wastewater treatment systems in states like Colorado, Idaho, North Carolina, Georgia, Florida, and Oregon. The gravel aggregate traditionally used in drain fields can have large quantities of mineral fines that also clog or block soil pores. Use of leaching chambers avoids this problem. Recent research sponsored by manufacturers shows promising results to support reduction in sizing of drain fields through the use of leaching chambers without increased hydraulic and pollutant penetration failures (Colorado School of Mines, 2001; Siegrist and Vancuyk, 2001a, 2001b). These studies should be continued to eventually yield rational guidelines for proper sizing of these systems based on the type of pretreatment effluent to be received (septic tank effluent, effluent from filters or aerobic treatment units, etc.), as well as different soil types and hydrogeological conditions. Many states offer drain field sizing reduction allowances when leaching chambers are used instead of conventional gravel drain fields.

Because leaching chamber systems can be installed without heavy equipment, they are easy to install

**Figure 4-12. Placement of leaching chambers in typical application**



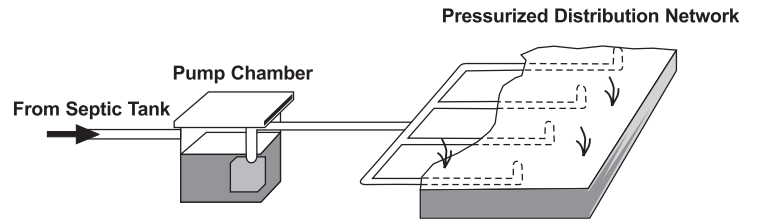
Source: Hoover et al., 1996.

and repair. These high-capacity, open-bottom drain field systems can provide greater storage than conventional gravel systems and can be used in areas appropriate for gravel aggregate drain fields. Leaching systems can operate independently and require little day-to-day maintenance. Their maintenance requirements are comparable to those of aggregate trench systems.

The lightweight chamber segments available on the market stack together compactly for efficient transport. Some chambers interlock with ribs without fasteners, cutting installation time by more than 50 percent reused and conventional gravel/pipe systems. Such systems can be reused and relocated if the site owner decides to build on another drain field site. A key disadvantage of leaching chambers compared to gravel drain fields is that they can be more expensive if a low-cost source of gravel is readily available.

Porous media should be placed along the chamber sidewall area to a minimum compacted height of 8 inches above the trench bottom. Additional backfill is placed to a minimum compacted height of 6 to 12 inches above the chamber, depending on the chamber strength. Individual chamber trench bottoms should be leveled in all directions and follow the contour of the ground surface elevation without any dams or other water stops. The manufacturer’s installation instructions should be followed, and systems should be installed by an authorized contractor.

Figure 4-13. Typical pressurized distribution system layout



Source: National Small Flows Clearinghouse

**Dosed flow distribution**

Dosed-flow distribution systems are a significant improvement over gravity-flow distribution systems. The design of dosed-flow systems (figure 4-13) includes both the distribution network and the dosing equipment (see table 4-6). Dosing achieves better distribution of the wastewater effluent over the infiltration surface than gravity flow systems and provides intervals between doses when no wastewater is applied. As a result, dosed-flow systems reduce the rate of soil clogging, more effectively maintain unsaturated conditions in the subsoil (to effect good treatment through extended residence times and increased reaeration potential), and provide a means to manage wastewater effluent applications to the infiltration system (Hargett et al., 1982). They can be used in any application and should be the method of choice. Unfortunately, they are commonly perceived to be less desirable because they add a mechanical

Table 4-6. Dosing methods and devices.

Dosing method	Typical application
On-Demand	Dosing occurs when a sufficient volume of wastewater has accumulated in the dose tank to activate the pump switch or siphon. Dosing continues until the preselected low water level is reached. Typically, there is no control on the daily volume of wastewater dosed.
Timed	Dosing is performed by pumps on a timed cycle, typically at equal intervals and for preset dose volumes so that the daily volume of wastewater dosed does not exceed the system’s design flow. Controls can be set so that only full doses occur. Peak flows are stored in the dose tank for dosing during low flow periods. Excessive flows are retained in the tank, and, if they persist, a high water alarm alerts the owner of the need for remedial action. This approach prevents unwanted and detrimental discharges to the SWIS.
Dosing device	
Pump	Pressure distribution networks are set at elevations that are typically higher than the dose tank. Multiple infiltration areas can be dosed from the same tank using multiple, alternating pumps or automatic valves.
Siphon	On-demand dosing of gravity or pressure distribution networks is used where the elevation between the siphon invert and the distribution pipe orifices is sufficient for the siphon to operate. Siphons cannot be used for timed dosing. Two siphons in the same dose tank can be used to alternate automatically between two infiltration areas.

component to an otherwise “passive” system and add cost because of the dosing equipment. The improved performance of dosed-flow systems over gravity flow systems should outweigh these perceived disadvantages, especially when a management entity is in place. It must be noted, however, that if dosed infiltration systems are allowed to pond, the advantages of dosing are lost because the bottom infiltration surface is continuously inundated and no longer allowed to rest and reaerate. Therefore, there is no value in using dosed-flow distribution in SWISs designed to operate ponded, such as systems that include sidewall area as an active infiltration surface or those using serial relief lines.

*Perforated pipe*

Four-inch perforated pipe networks (with or without d-boxes or pressure manifolds) that receive dosed-flow applications are designed no differently than gravity-flow systems. Many of the advantages of dosing are lost in such networks, however, because the distribution is only slightly better than that of gravity-flow systems (Converse, 1974).

*Pressure manifold*

A pressure manifold consists of a large-diameter pipe tapped with small outlet pipes that discharge to gravity laterals (figure 4-14). A pump pressurizes the manifold, which has a selected diameter to ensure that pressure inside the manifold is the same at each outlet. This method of flow division is more accurate and consistent than a distribution box, but it has the same shortcoming since flow after the manifold is by gravity along each distribu-

tion lateral. Its most common application is to divide flow among multiple trenches constructed at different elevations on a sloping site.

Table 4-7 can be used to size a pressure manifold for different applications (see sidebar). This table was developed by Berkowitz (1985) to size the manifold diameter based on the spacing between pressure lateral taps, the lateral tap diameter, and the number of lateral taps. The hydraulic computations made to develop the table set a maximum flow differential between laterals of 5 percent. The dosing rate is determined by calculating the flow in a single lateral tap assuming 1 to 4 feet of head at the manifold outlets and multiplying the result by the number of lateral taps. The Hazen-Williams equation for pipe flow can be used to make this calculation.

Pressure distribution is typically constructed of Schedule 40 PVC pipe (figure 4-15). The lateral taps are joined by tees. They also can be attached by tapping (threading) the manifold pipe, but the manifold pipe must be Schedule 80 to provide a thicker pipe wall for successful tapping. Valves on each pressure tap are recommended to enable each line to be taken out of service as needed by closing the appropriate valve. This allows an opportunity to manage, rest, or repair individual lines. To prevent freezing, the manifold can be drained back to the dose tank after each dose. If this is done, the volume of water that will drain from the manifold and forcemain must be added to the dose volume to achieve the desired dose.

*Rigid pipe pressure network*

Rigid pipe pressure distribution networks are used to provide relatively uniform distribution of

Figure 4-14. Pressure manifold detail

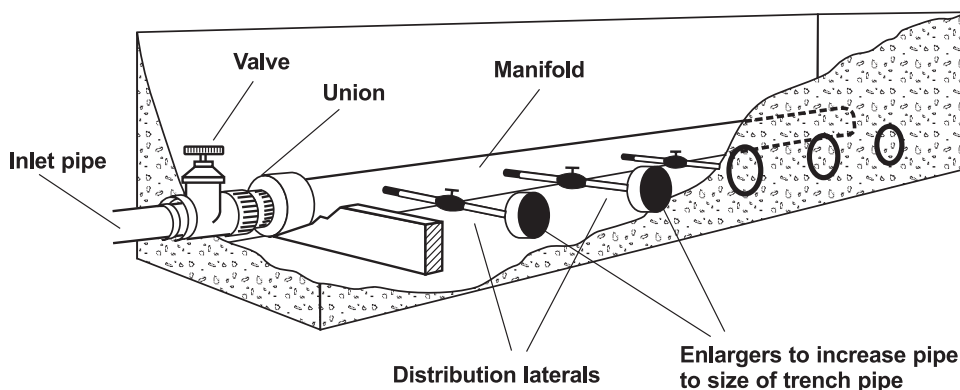
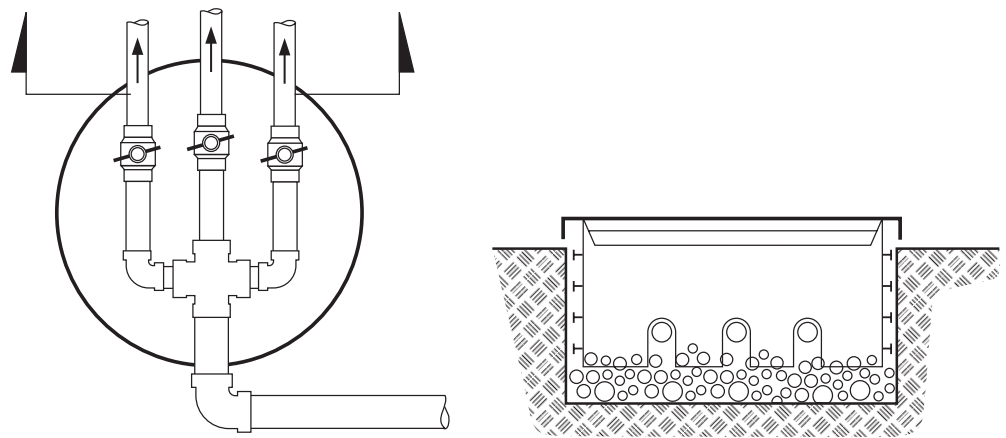


Table 4-7. Pressure manifold sizing

Tap spacing (feet)	Manifold size (inches)	Single-sided manifold						Double-sided manifold						
		Lateral tap diameter (inches)						Lateral tap diameter (inches)						
		0.50	0.75	1.00	1.25	1.50	2.00	0.50	0.75	1.00	1.25	1.50	2.00	
		Maximum number of lateral taps						Maximum number of lateral taps						
0.5	2	4	2					2						
	3	9	5	3	2			4	2					
	4	16	9	5	3	2		7	4	2				
	6	>40	21	12	7	5	3	18	10	6	3	2		
	8		38	22	12	9	5		17	10	6	4	2	
3.0	2	8	2					2						
	3	14	12	3	2			6	2					
	4	21	18	6	3	2		16	5	3				
	6	38	30	26	8	5	3	>20	19	7	3	2		
6.0	2	5	4					4						
	3	9	7	6	2			7	3	2				
	4	14	11	9	4	2		10	9	3				
	6	27	20	17	14	7	3	19	15	13	4	3		

Source: Adapted from Berkowitz, 1985.

Figure 4-15. Horizontal design for pressure distribution



Source: Washington Department of Health, 1998.

wastewater effluent over the entire infiltration surface simultaneously during each dose. They are well suited for all dosed systems. Because they deliver the same volume of wastewater effluent per linear length of lateral, they can be used to dose multiple trenches of unequal length. Although rigid pipe pressure networks can be designed to deliver equal volumes to trenches at different elevations (Mote, 1984; Mote et al., 1981; Otis, 1982), these situations should be avoided. Uniform distribution is achieved only when the network is fully pressurized. During filling and draining of the network,

the distribution lateral at the lowest elevation receives more water. This disparity increases with increasing dosing frequency. As an alternative on sloping sites, the SWIS could be divided into multiple cells, with the laterals in each cell at the same elevation. If this is not possible, other distribution designs should be considered.

The networks consist of solid PVC pipe manifolds that supply water to a series of smaller perforated PVC laterals (figure 4-16). The laterals are designed to discharge nearly equal volumes of

### Pressure manifold design

A SWIS consisting of 12 trenches of equal length is to be constructed on a slope. To divide the septic tank effluent equally among the 12 trenches, a pressure manifold is to be used. The lateral taps are to be spaced 6 inches apart on one side of the manifold.

Table 4-7 can be used to size the manifold. Looking down the series of columns under the Single-sided manifold, up to sixteen ½-inch taps could be made to a 4-inch manifold. Therefore, a 4-inch manifold would be acceptable. If ¾- or 1-inch taps were used, a 6-inch manifold would be necessary.

Using the orifice equation, the flow from each lateral tap can be estimated by assuming an operating pressure in the manifold:

$$Q = Ca(2gh)^2$$

where  $Q$  is the lateral discharge rate,  $C$  is a dimensionless coefficient that varies with the characteristics of the orifice (0.6 for a sharp-edged orifice),  $a$  is the area of the orifice,  $g$  is the acceleration due to gravity, and  $h$  is the operating pressure within the manifold. In English units using a 0.6 orifice coefficient, this equation becomes

$$Q = 11.79 d^2 h^{1/2}$$

where  $Q$  is the discharge rate in gallons per minute,  $d$  is the orifice diameter in inches, and  $h$  is the operating pressure in feet of water.

Assuming ½-inch taps with a operating pressure of 3 feet of water, the discharge rate from each outlet is

$$Q = 11.79 (1/2)^2 3^{1/2} = 5.1 \text{ gpm}$$

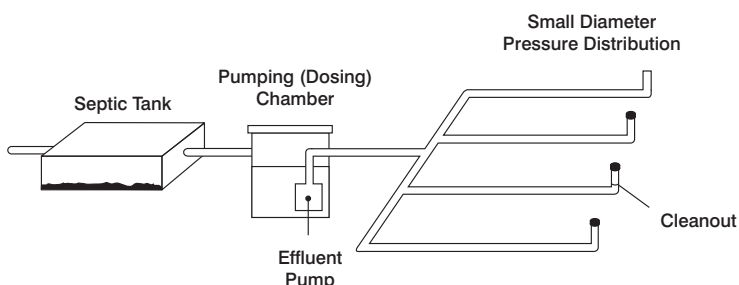
Thus, the pump must be capable of delivering 12 x 5.1 gpm or approximately 60 gpm against an operating pressure of 3 feet of water plus the static lift and friction losses incurred in the forcemain to the pressure manifold.

wastewater from each orifice in the network when fully pressurized. This is accomplished by maintaining a uniform pressure throughout the network during dosing. The manifolds and laterals are sized relative to the selected orifice size and spacing to achieve uniform pressure. A manual flushing mechanism should be included to enable periodic flushing of slimes and other solids that accumulate in the laterals.

### Design of dosed flow systems

A simplified method of network design has been developed (Otis, 1982). Lateral and manifold sizing is determined using a series of graphs and tables after the designer has selected the desired orifice size and spacing and the distal pressure in the network (typically 1 to 2 feet of head). These graphs and tables were derived by calculating the change in flow and pressure at each orifice between the distal and proximal ends of the network. The method is meant to result in discharge rates from the first and last orifices that differ by no more than 10 percent in any lateral and 15 percent across the entire network. However, subsequent testing of field installations indicated that the design model overestimates the maximum lateral length by as much as 25 percent (Converse and Otis, 1982). Therefore, if the graphs and tables are used, the maximum lateral length for any given orifice size and spacing should not exceed 80 percent of the maximum design length suggested by the lateral sizing graphs. In lieu of using the graphs and tables, a spreadsheet could be written using the equations presented and adjusting the orifice discharge coefficient.

Figure 4-16. Rigid pipe pressure distribution networks with flushing cleanouts





### Design procedure for rigid pipe pressure distribution network

The simplified design procedure for rigid pipe pressure networks as presented by Otis (1982) includes the following steps:

1. Lay out the proposed network.
2. Select the desired orifice size and spacing. Maximize the density of orifices over the infiltration surface, keeping in mind that the dosing rate increases as the orifice size increases and the orifice spacing decreases.
3. Determine the appropriate lateral pipe diameter compatible with the selected orifice size and spacing using a spreadsheet or sizing charts from Otis (1982).
4. Calculate the lateral discharge rate using the orifice discharge equation (0.48 discharge coefficient or 80 percent of 0.6).
5. Determine the appropriate manifold size based on the number, spacing, and discharge rate of the laterals using a spreadsheet or sizing table from Otis (1982).
6. Determine the dose volume required. Use either the minimum dose volume equal to 5 times the network volume or the expected daily flow divided by the desired dosing frequency, whichever is larger.
7. Calculate the minimum dosing rate (the lateral discharge times the number of laterals).
8. Select the pump based on the required dosing rate and the total dynamic head (sum of the static lift, friction losses in the forcemain to the network, and the network losses, which are equal to 1.3 times the network operating pressure).

To achieve uniform distribution, the density of orifices over the infiltration surface should be as high as possible. However, the greater the number of orifices used, the larger the pump must be to provide the necessary dosing rate. To reduce the dosing rate, the orifice size can be reduced, but the smaller the orifice diameter, the greater the risk of orifice clogging. Orifice diameters as small as 1/8 inch have been used successfully with septic tank effluent when an effluent screen is used at the septic tank outlet. Orifice spacings typically are 1.5 to 4 feet, but the greater the spacing, the less uniform the distribution because each orifice represents a point load. It is up to the designer to achieve the optimum balance between orifice density and pump size.

The dose volume is determined by the desired frequency of dosing and the size of the network. Often, the size of the network will control design. During filling and draining of the network at the start and end of each dose, the distribution is less uniform. The first holes in the network discharge more during initial pressurization of the network, and the holes at the lowest elevation discharge more as the network drains after each dose. To

minimize the relative difference in discharge volumes, the dose volume should be greater than five times the volume of the distribution network (Otis, 1982). A pump or siphon can be used to pressurize the network.

#### *Dripline pressure network*

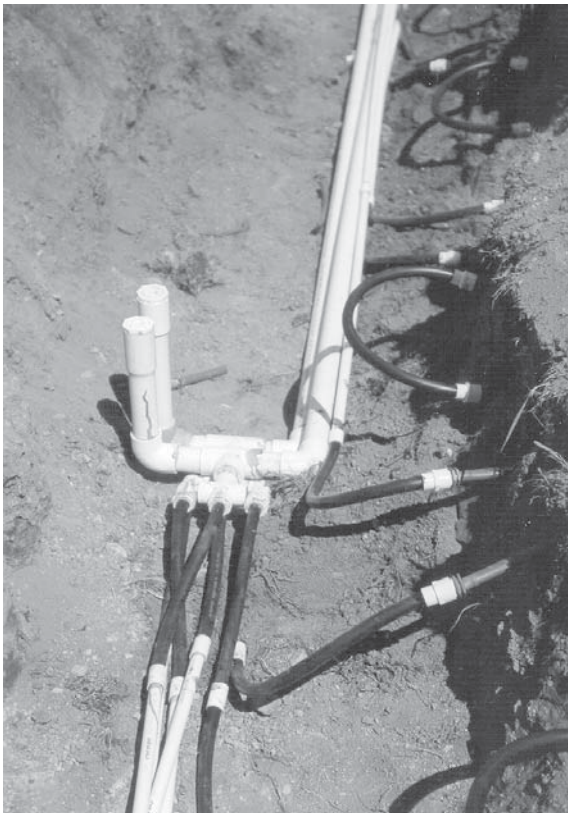
Drip distribution, which was derived from drip irrigation technology, was recently introduced as a method of wastewater distribution. It is a method of pressure distribution capable of delivering small, precise volumes of wastewater effluent to the infiltration surface. It is the most efficient of the distribution methods and is well suited for all types of SWIS applications. A dripline pressure network consists of several components:

- Dose tank
- Pump
- Prefilter
- Supply manifold
- Pressure regulator (when turbulent, flow emitters are used)

- Dripline
- Emitters
- Vacuum release valve
- Return manifold
- Flush valve
- Controller

The pump draws wastewater effluent from the dose tank, preferably on a timed cycle, to dose the distribution system. Before entering the network, the effluent must be prefiltered through mechanical or granular medium filters. The former are used primarily for large SWIS systems. The backflush water generated from a self-cleaning filter should be returned to the headworks of the treatment system. The effluent enters the supply manifold that feeds each dripline (figure 4-17). If turbulent flow emitters are used, the filtered wastewater must first pass through a pressure regulator to control the

**Figure 4-17. Pressure manifold and flexible drip lines prior to trench filling**



Source: Ayres Associates.

maximum pressure in the dripline. Usually, the dripline is installed in shallow, narrow trenches 1 to 2 feet apart and only as wide as necessary to insert the dripline using a trenching machine or vibratory plow. The trench is backfilled without any porous medium so that the emitter orifices are in direct contact with the soil. The distal ends of each dripline are connected to a return manifold. The return manifold is used to regularly flush the dripline. To flush, a valve on the manifold is opened and the effluent is flushed through the driplines and returned to the treatment system headworks.

Because of the unique construction of drip distribution systems, they cause less site disruption during installation, are adaptable to irregularly shaped lots or other difficult site constraints, and use more of the soil mantle for treatment because of the shallow depth of placement. Also, because the installed cost per linear foot of dripline is usually less than the cost of conventional trench construction, dripline can be added to decrease mass loadings to the infiltration surface at lower costs than other distribution methods. Because of the equipment required, however, drip distribution tends to be more costly to construct and requires regular operation and maintenance by knowledgeable individuals. Therefore, it should be considered for use only where operation and maintenance support is ensured.

The dripline is normally a ½-inch-diameter flexible polyethylene tube with emitters attached to the inside wall spaced 1 to 2 feet apart along its length. Because the emitter passageways are small, friction losses are large and the rate of discharge is low (typically from 0.5 to nearly 2 gallons per hour).

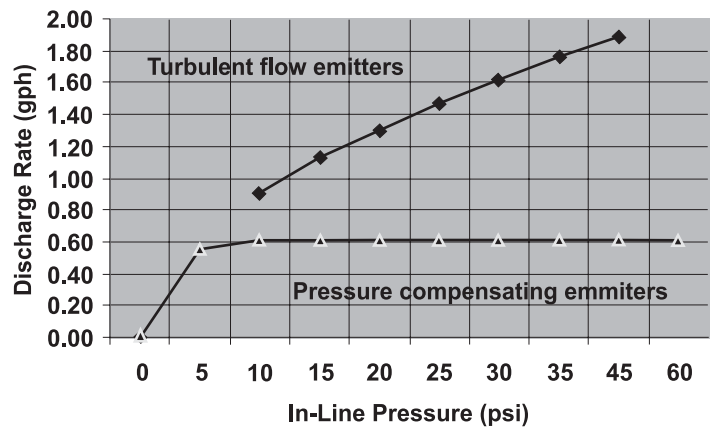
Two types of emitters are used. One is a “turbulent-flow” emitter, which has a very long labyrinth. Flow through the labyrinth reduces the discharge pressure nearly to atmospheric rates. With increasing in-line pressure, more wastewater can be forced through the labyrinth. Thus, the discharges from turbulent flow emitters are greater at higher pressures (figure 4-18). To more accurately control the rate of discharge, a pressure regulator is installed in the supply manifold upstream of the dripline. Inlet pressures from a minimum of 10 psi to a maximum of 45 psi are recommended. The second emitter type is the pressure-compensating

emitter. This emitter discharges at nearly a constant rate over a wide range of in-line pressures (figure 4-18).

Head losses through driplines are high because of the small diameter of the tubing and its in-line emitters, and therefore dripline lengths must be limited. Manufacturers limit lengths at various emitter spacings. With turbulent flow emitters, the discharge from each successive emitter diminishes in response to pressure loss created by friction or by elevation changes along the length of the dripline. With pressure-compensating emitters, the in-line pressure should not drop below 7 to 10 psi at the final emitter. The designer is urged to work with manufacturers to ensure that the system meets their requirements.

Pressure-compensating emitters are somewhat more expensive but offer some important advantages over turbulent-flow emitters for use in onsite wastewater systems. Pressure-compensating dripline is better suited for sloping sites or sites with rolling topography where the dripline cannot be laid on contour. Turbulent-flow emitters discharge more liquid at lower elevations than the same emitters at higher elevations. The designer should limit the difference in discharge rates between emitters to no more than 10 percent. Also, because the discharge rates are equal when under pressure, monitoring flow rates during dosing of a pressure-compensating dripline network can provide an effective way to determine whether leaks or obstructions are present in the network or emitters. Early detection is important so that simple and effective corrective actions can be taken. Usually, injection of a mild bleach solution into the dripline is effective in restoring emitter performance if clogging is due to biofilms. If this action proves to be unsuccessful, other corrective actions are more difficult and costly. An additional advantage of pressure-compensating emitters is that pressure regulators are not required. Finally, when operating in their normal pressure range, pressure-compensating emitters are not affected by soil water pressure in structured soils, which can cause turbulent-flow emitters to suffer reduced dosing volumes.

Figure 4-18. Turbulent-flow and pressure-compensating emitter discharge rates versus in-line pressure



### Controlling clogging in drip systems

With small orifices, emitters are susceptible to clogging. Particulate materials in the wastewater, soil particulates drawn into an emitter when the dripline drains following a dose, and biological slimes that grow within the dripline pose potential clogging problems. Also, the moisture and nutrients discharged from the emitters may invite root intrusion through the emitter. Solutions to these problems lie in both the design of the dripline and the design of the distribution network. Emitter hydrodynamic design and biocide impregnation of the dripline and emitters help to minimize some of these problems. Careful network design is also necessary to provide adequate safeguards. Monitoring allows the operator to identify other problems such as destruction from burrowing animals.

To control emitter clogging, appropriate engineering controls must be provided. These include prefiltration of the wastewater, regular dripline flushing, and vacuum release valves on the network. Prefiltration of the effluent through granular or mechanical filters is necessary. These filters should be capable of removing all particulates that could plug the emitter orifices. Dripline manufacturers recommend that self-cleaning filters be designed to remove particles larger than 100 to 115 microns. Despite this disparate experience, pretreatment with filters is recommended in light of the potential cost of replacing plugged emitters. Regular cleaning of the filters is necessary to maintain satisfactory performance. The backflush water should be returned to the head of the treatment works.

The dripline must be flushed on a regular schedule to keep it scoured of solids. Flushing is accomplished by opening the flush valve on the return manifold and increasing the pumping rate to achieve scouring velocity. Each supplier recommends a velocity and procedure for this process. The flushing rate and volume must include water losses (discharge) through the emitters during the flushing event. Both continuous flushing and timed flushing are used. However, flushing can add a significant hydraulic load to the treatment system and must be considered in the design. If intermittent flushing is practiced, flushing should be performed at least monthly.

Aspiration of soil particles is another potential emitter clogging hazard. Draining of the network following a dosing cycle can create a vacuum in the network. The vacuum can cause soil particles to be aspirated into the emitter orifices. To prevent this from occurring, vacuum relief valves are used. It is best to install these at the high points of both the supply and return manifolds.

### **Placement and layout of drip systems**

When drip distribution was introduced, the approach to sizing SWISs using this distribution method was substantially different from that for SWISs using other distribution methods. Manufacturer-recommended hydraulic loading rates were expressed in terms of gallons per day per square foot of drip distribution footprint area. Typically, the recommended rates were based on 2-foot emitter and dripline spacing. Therefore, each emitter would serve 4 square feet of footprint area. Because the dripline is commonly plowed into the soil without surrounding it with porous medium, the soil around the dripline becomes the actual infiltration surface. The amount of infiltration surface provided is approximately  $\frac{2}{3}$  to 1 square foot per 5 linear feet of dripline. As a result, the wastewater loading rate is considerably greater than the hydraulic loadings recommended for traditional SWISs. Experience has shown however, that the hydraulic loading on this surface can be as much as seven times higher than that of traditional SWIS designs (Ayres Associates, 1994). This is probably due to the very narrow geometry, higher levels of pretreatment, shallow placement, and intermittent loadings of the trenches, all of which help to enhance reaeration of the infiltration surface.

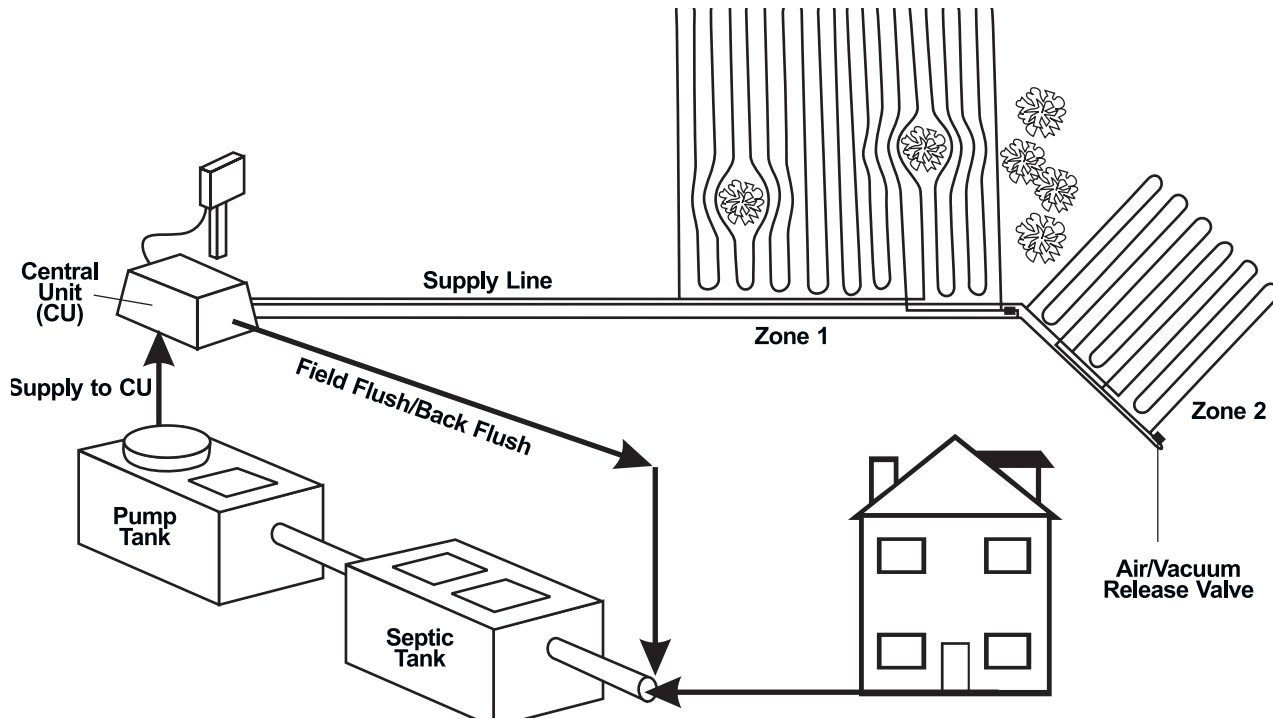
The designer must be aware of the differences between the recommended hydraulic loadings for drip distribution and those customarily used for traditional SWISs. The recommended drip distribution loadings are a function of the soil, dripline spacing, and applied effluent quality. It is necessary to express the hydraulic loading in terms of the footprint area because the individual dripline trenches are not isolated infiltration surfaces. If the emitter and/or dripline spacing is reduced, the wetting fronts emanating from each emitter could overlap and significantly reduce hydraulic performance. Therefore, reducing the emitter and/or dripline spacing should not reduce the overall required system footprint. Reducing the spacing might be beneficial for irrigating small areas of turf grass, but the maximum daily emitter discharge must be reduced proportionately by adding more dripline to maintain the same footprint size. Using higher hydraulic loading rates must be carefully considered in light of secondary boundary loadings, which could result in excessive ground water mounding (see chapter 5). Further, the instantaneous hydraulic loading during a dose must be controlled because storage is not provided in the dripline trench. If the dose volume is too high, the wastewater can erupt at the ground surface.

Layout of the drip distribution network must be considered carefully. Two important consequences of the network layout are the impacts on dose pump sizing necessary to achieve adequate flushing flows and the extent of localized overloading due to internal dripline drainage. Flushing flow rates are a function of the number of manifold/dripline connections: More connections create a need for greater flushing flows, which require a larger pump. To minimize the flushing flow rate, the length of each dripline should be made as long as possible in accordance with the manufacturer's recommendations. To fit the landscape, the dripline can be looped between the supply and return manifolds (figure 4-19). Consideration should also be given to dividing the network into more than one cell to reduce the number of connections in an individual network. A computer program has been developed to evaluate and optimize the hydraulic design for adequate flushing flows of dripline networks that use pressure-compensating emitters (Berkowitz and Harman, 1994).

Internal drainage that occurs following each dose or when the soils around the dripline are saturated



Figure 4-19. Dripline layout on a site with trees



Source: Adapted from American Manufacturing, 2001.

can cause significant hydraulic overloading to lower portions of the SWIS. Following a dose cycle, the dripline drains through the emitters. On sloping sites, the upper driplines drain to the lower driplines, where hydraulic overloading can occur. Any free water around the dripline can enter through an emitter and drain to the lowest elevation. Each of these events needs to be avoided as much as possible through design. The designer can minimize internal drainage problems by isolating the driplines from each other in a cell, by aligning the supply and return manifolds with the site's contours. A further safeguard is to limit the number of doses per day while keeping the instantaneous hydraulic loadings to a minimum so the dripline trench is not flooded following a dose. This trade-off is best addressed by determining the maximum hydraulic loading and adjusting the number of doses to fit this dosing volume.

Freezing of dripline networks has occurred in severe winter climates. Limited experience indicates that shallow burial depths together with a lack of uncompacted snow cover or other insulating materials might lead to freezing. In severe winter

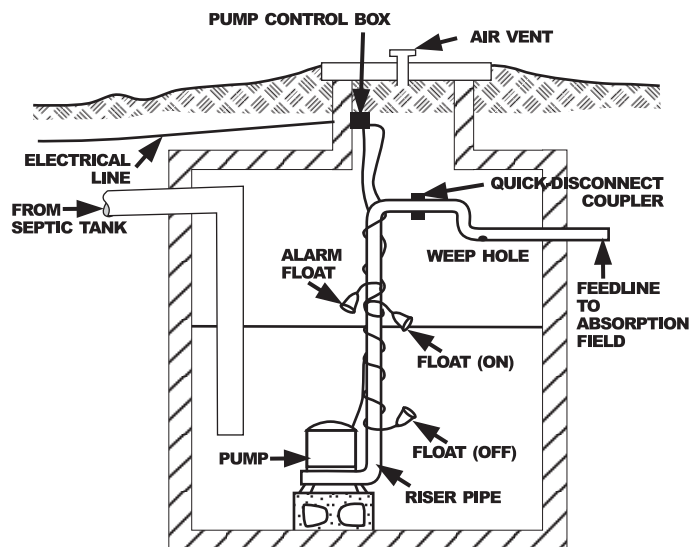
climates, the burial depth of dripline should be increased appropriately and a good turf grass established over the network. Mulching the area the winter after construction or every winter should be considered. Also, it is good practice to install the vacuum release valves below grade and insulate the air space around them. Although experience with drip distribution in cold climates is limited, these safeguards should provide adequate protection.

### Dosing methods

Two methods of dosing have been used (table 4-6). With on-demand dosing, the wastewater effluent rises to a preset level in the dose tank and the pump or siphon is activated by a float switch or other mechanism to initiate discharge (figure 4-20). During peak-flow periods, dosing is frequent with little time between doses for the infiltration system to drain and the subsoil to reaerate. During low-flow periods, dosing intervals are long, which can be beneficial in controlling biomat development but is inefficient in using the hydraulic capacity of the system.



Figure 4-20. Pumping tank (generic)



Source: Purdue University, 1990

Timed dosing overcomes some of the shortcomings of on-demand dosing. Timers are used to turn the pump on and off at specified intervals so that only a predetermined volume of wastewater is discharged with each dose. Timed dosing has two distinct advantages over on-demand dosing. First, the doses can be spaced evenly over the entire 24-hour day to optimize the use of the soil's treatment capacity. Second, the infiltration system receives no more than its design flow each day. Clear water infiltration, leaking plumbing fixtures, or excessive water use are detected before the excess flow is discharged to the infiltration system because the dose tank will eventually fill to its high water alarm level. At that point, the owner has the option of calling a septage pumper to empty the tanks or activating the pump to dose the system until the problem is diagnosed and corrected. Unlike on-demand dosing, timed dosing requires that the dose tank be sized to store peak flows until they can be pumped (see sidebar).

Dosing frequency and volume are two important design considerations. Frequent, small doses are preferred over large doses one or two times per day. However, doses should not be so frequent that distribution is poor. This is particularly true with either of the pressure distribution networks. With pressure networks, uniform distribution does not occur until the entire network is pressurized. To ensure pressurization and to minimize unequal discharges from the orifices during filling and draining, a dose volume equal to five times the

network volume is a good rule of thumb. Thus, doses can be smaller and more frequent with dripline networks than with rigid pipe networks because the volume of drip distribution networks is smaller.

#### 4.4.8 SWIS media

A porous medium is placed below and around SWIS distribution piping to expand the infiltration surface area of the excavation exposed to the applied wastewater. This approach is similar in most SWIS designs, except when drip distribution or aggregate-free designs are used. In addition, the medium also supports the excavation sidewalls, provides storage of peak wastewater flows, minimizes erosion of the infiltration surface by dissipating the energy of the influent flow, and provides some protection for the piping from freezing and root penetration.

Traditionally, washed gravel or crushed rock, typically ranging from  $\frac{3}{4}$  to  $2\frac{1}{2}$  inches in diameter, has been used as the porous medium. The rock should be durable, resistant to slaking and dissolution, and free of fine particles. A hardness of at least 3 on the Moh's scale of hardness is suggested. Rock that can scratch a copper penny without leaving any residual meets this criterion. It is important that the medium be washed to remove fine particles. Fines from insufficiently washed rock have been shown to result in significant reductions in infiltration rates (Amerson et al., 1991). In all applications where gravel is used, it must be properly graded and washed. Improperly washed gravel can contribute fines and other material that can plug voids in the infiltrative surface and reduce hydraulic capability. Gravel that is embedded into clay or fine soils during placement can have the same effect.

In addition to natural aggregates, gravelless systems have been widely used as alternative SWIS medium (see preceding section). These systems take many forms, including open-bottomed chambers, fabric-wrapped pipe, and synthetic materials such as expanded polystyrene foam chips, as described in the preceding section. Systems that provide an open chamber are sometimes referred to as "aggregate-free" systems, to distinguish them from others that substitute lightweight medium for gravel or stone. These systems provide a suitable substitute in locales where gravel is not available or affordable. Some systems (polyethylene chambers and light-

### Dose tank sizing for timed dosing

Timed dosing to a SWIS is to be used in an onsite system serving a restaurant in a summer resort area. Timed dosing will equalize the flows, enhancing treatment in the soil and reducing the required size of the SWIS.

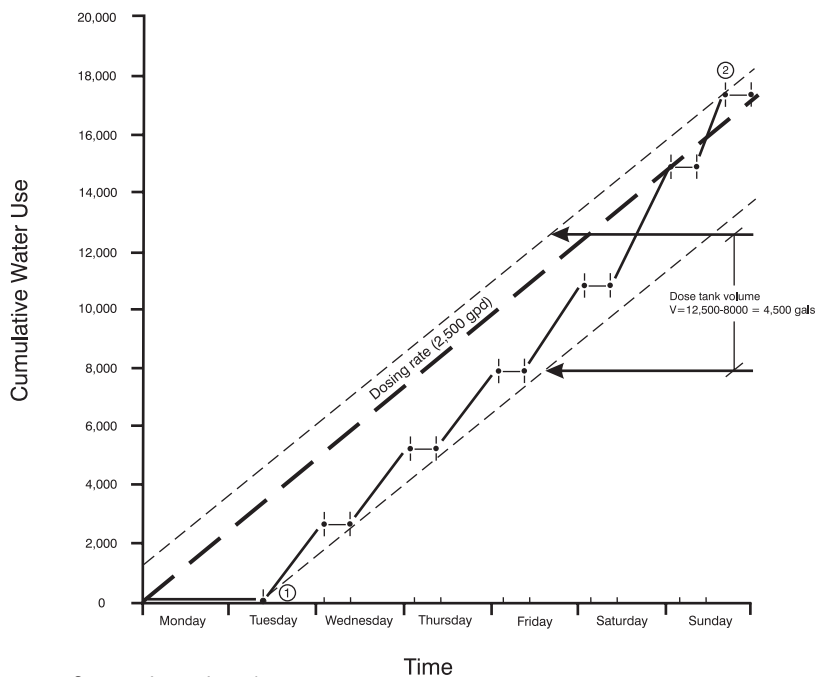
The restaurant serves meals from 11 a.m. to 12 midnight Tuesday through Saturday and from 9 a.m. to 2 p.m. Sundays. The largest number of meals is served during the summer weekends. The restaurant is closed on Mondays. The metered water use is as follows:

Average weekly water use (summer)	17,500 gal
Peak weekend water use (4 p.m. Friday to 2 p.m. Sunday)	9,500 gal

The dose tank will be sized to equalize flows over a 7-day period. The dosing frequency is to be six times daily or one dose every 4 hours. Therefore, the dose volume will be

$$\text{Dose volume} = 17,500 \text{ gal/wk} \div (7 \text{ d/wk} \times 6 \text{ doses/day}) = 417 \text{ gal/dose}$$

The necessary volume of the dose tank to store the peak flows and equalize the flow to the SWIS over the 7-day week can be determined graphically.



Source: Ayres Associates.

The accumulated water use over the week and the daily dosing rate (6 doses/day  $\times$  417 gal/dose = 2,500 gpd) is plotted on the graph. Lines parallel to the dosing rate are drawn tangent to points 1 and 2 representing the maximum deviations of the water use line above and below the dosing rate line. The volume represented by the difference between the two parallel lines is the tank volume needed to achieve flow equalization. A 4,500-gallon tank would be required.

Both siphons and pumps can be used for dosing distribution networks. Only drip distribution networks cannot be dosed by siphons because of the higher required operating pressures and the need to control instantaneous hydraulic loadings (dose volume). Siphons can be used where power is not available and elevation is adequate to install the siphon sufficiently above the distribution network to overcome friction losses in the forcemain and network. Care must be taken in their selection and installation to ensure proper performance. Also, owners must be aware that siphon systems require routine monitoring and occasional maintenance. "Dribbling" can occur when the siphon bell becomes saturated, suspending dosing and allowing the wastewater effluent to trickle out under the bell. Dribbling can occur because of leaks in the bell or a siphon out of adjustment. Today, pumps are favored over siphons because of the greater flexibility in site selection and dosing regime.

weight aggregate systems) can also offer substantial advantages in terms of reduced site disruption over the traditional gravel because their light weight makes them easy to handle without the use of heavy equipment. These advantages reduce labor costs, limit damage to the property by machinery, and allow construction on difficult sites where conventional medium could not reasonably be used.

## 4.5 Construction management and contingency options

Onsite wastewater systems can and do fail to perform at times. To avoid threats to public health and the environment during periods when a system malfunctions hydraulically, contingency plans should be made to permit continued use of the system until appropriate remedial actions can be taken. Contingency options should be considered during design so that the appropriate measures are designed into the original system. Table 4-8 lists common contingency options.

### 4.5.1 Construction considerations

Construction practices are critical to the performance of SWISs. Satisfactory SWIS performance depends on maintaining soil porosity. Construction activities can significantly reduce the porosity and cause SWISs to hydraulically fail soon after being brought into service. Good construction practices should carefully consider site protection before and during construction, site preparation, and construction equipment selection and use. Good construction practices for at-grade and mound systems can be found elsewhere (Converse and Tyler, 2000; Converse et al., 1990). Many of them, however, are similar to those described in the following subsections.

#### Site protection

Construction of the onsite wastewater system is often only one of many construction activities that occur on a property. If not protected against intrusion, the site designated for the onsite system can be damaged by other, unrelated construction

Table 4-8. Contingency options for SWIS malfunctions

Contingency option	Description	Comments
Reserve area	Unencumbered area of suitable soils set aside for a future replacement system.	Does not provide immediate relief from performance problems because the replacement system must be constructed. The replacement system should be constructed such that use can be alternated with use of the original system.
Multiple cells	Two or more infiltration cells with a total hydraulic capacity of 100% to 200% of the required area that are alternated into service.	Provide immediate relief from performance problems by providing stand-by capacity. Rotating cells in and out of service on an annual or other regular schedule helps to maintain system capacity. Alternating valves are commercially available to implement this option. The risk from performance problems is reduced because the malfunction of a single cell involves a smaller proportion of the daily flow.
Water conservation	Water-conserving actions taken to reduce the hydraulic load to the system, which may alleviate the problem.	A temporary solution that may necessitate a significant lifestyle change by the residents, which creates a disincentive for continued implementation. The organic loading will remain the same unless specific water uses or waste inputs are eliminated from the building or the wastewaters are removed from the site.
Pump and haul	Conversion of the septic tank to a holding tank that must be periodically pumped. The raw waste must be hauled to a suitable treatment and/or disposal site.	Holding tanks are a temporary or permanent solution that can be effective but costly, creating a disincentive for long-term use.

activities. Therefore, the site should be staked and roped off before any construction activities begin to make others aware of the site and to keep traffic and materials stockpiles off the site.

The designer should anticipate what activities will be necessary during construction and designate acceptable areas for them to occur. Site access points and areas for traffic lanes, material stockpiling, and equipment parking should be designated on the drawings for the contractor.

### Site preparation

Site preparation activities include clearing and surface preparation for filling. Before these activities are begun, the soil moisture should be determined. In nongranular soils, compaction will occur if the soil is near its plastic limit. This can be tested by removing a sample of soil and rolling it between the palms of the hands. If the soil fails to form a “rope” the soil is sufficiently dry to proceed. However, constant care should be taken to avoid soil disturbance as much as possible.

#### *Clearing*

Clearing should be limited to mowing and raking because the surface should be only minimally disturbed. If trees must be removed, they should be cut at the base of the trunk and removed without heavy machinery. If it is necessary to remove the stumps, they should be ground out. Grubbing of the site (mechanically raking away roots) should be avoided. If the site is to be filled, the surface should be moldboard- or chisel-plowed parallel to the contour (usually to a depth of 7 to 10 inches) when the soil is sufficiently dry to ensure maximum vertical permeability. The organic layer should not be removed. Scarifying the surface with the teeth of a backhoe bucket is not sufficient.

#### *Excavation*

Excavation activities can cause significant reductions in soil porosity and permeability (Tyler et al., 1985). Compaction and smearing of the soil infiltrative surface occur from equipment traffic and vibration, scraping actions of the equipment, and placement of the SWIS medium on the infiltration surface. Lightweight backhoes are most commonly used. Front-end loaders and blades should not be used

because of their scraping action. All efforts should be made to avoid any disturbance to the exposed infiltration surface. Equipment should be kept off the infiltration field. Before the SWIS medium is installed, any smeared areas should be scarified and the surface gently raked. If gravel or crushed rock is to be used for SWIS medium, the rock should be placed in the trench by using the backhoe bucket rather than dumping it directly from the truck. If damage occurs, it might be possible to restore the area, but only by removing the compacted layer. It might be necessary to remove as much as 4 inches of soil to regain the natural soil porosity and permeability (Tyler et al., 1985). Consequences of the removal of this amount of soil over the entire infiltration surface can be significant. It will reduce the separation distance to the restrictive horizon and could place the infiltration surface in an unacceptable soil horizon.

To avoid potential soil damage during construction, the soil below the proposed infiltration surface elevation must be below its plastic limit. This should be tested before excavation begins. Also, excavation should be scheduled only when the infiltration surface can be covered the same day to avoid loss of permeability from wind-blown silt or raindrop impact. Another solution is to use lightweight gravelless systems, which reduce the damage and speed the construction process.

Before leaving the site, the area around the site should be graded to divert surface runoff from the SWIS area. The backfill over the infiltration surface should be mounded slightly to account for settling and eliminate depressions over the system that can pond water. Finally, the area should be seeded and mulched.

### 4.5.2 Operation, maintenance, and monitoring

Subsurface wastewater infiltration systems require little operator intervention. Table 4-9 lists typical operation, maintenance, and monitoring activities that should be performed. However, more complex pretreatment, larger and more variable flows, and higher-risk installations increase the need for maintenance and monitoring. More information is provided in the USEPA draft *Guidelines for Onsite/Decentralized Wastewater Systems* (2000) and in the chapter 4 fact sheets.



Table 4-9. Operation, maintenance, and monitoring activities

Task	Description	Frequency
Water meter reading	Recommended for large, commercial systems	Daily
Dosing tank controls	Check function of pump, switches, and timers for pressure-dosed systems	Monthly
Pump calibration	Check pumping rate and adjust dose timers as appropriate for pressure-dosed systems	Annually
Infiltration cell rotation	Direct wastewater to standby cells to rest operating cells	Annually (optimally in the spring)
Infiltration surface ponding	Record wastewater ponding depths over the infiltration surface and switch to standby cell when ponding persists for more than a month	Monthly
Inspect surface and perimeter of SWIS	Walk over SWIS area to observe surface ponding or other signs of stress or damage	Monthly
Tank solids levels and integrity assessment	Check for sludge and scum accumulation, condition of baffles and inlet and outlet appurtenances, and potential leaks	Varies with tank size and management program

### 4.5.3 Considerations for large and commercial systems

Designs for systems treating larger flows follow the same guidelines used for residential systems, but they must address characteristics of the wastewater to be treated, site characteristics, infiltration surface sizing, and contingency planning more comprehensively.

#### Wastewater characteristics

Wastewaters from cluster systems serving multiple homes or commercial establishments can differ substantially in flow pattern and waste strength from wastewaters generated by single family residences. The ratio of peak to average daily flow from residential clusters is typically much lower than what is typical from single residences. This is because the moderating effect associated with combining multiple water use patterns reduces the daily variation in flow. Commercial systems, on the other hand, can vary significantly in wastewater strength. Typically, restaurants have high concentrations of grease and BOD, laundromats have high sodium and suspended solids concentrations, and toilet facilities at parks and rest areas have higher concentrations of BOD, TSS, and nitrogen. These differences in daily flow patterns and waste strengths must be dealt with in the design of SWISs. Therefore, it is important to

characterize the wastewater fully before initiating design (see chapter 3).

#### Site characteristics

The proposed site for a SWIS that will treat wastewater from a cluster of homes or a commercial establishment must be evaluated more rigorously than a single-residence site because of the larger volume of water that is to be applied and the greater need to determine hydraulic gradients and direction. SWIS discharges can be from 10 to more than 100 times the amount of water that the soil infiltration surface typically receives from precipitation. For example, assume that an area receives an average of 40 inches of rainfall per year. Of that, less than 25 percent (about 10 inches annually) infiltrates and even less percolates to the water table. A wastewater infiltration system is designed to infiltrate 0.4 to 1.6 inches per day, or 146 to 584 inches per year. Assuming actual system flows are 30 percent of design flows, this is reduced to 44 to 175 inches per year even under this conservative approach.

The soils associated with small systems can usually accommodate these additional flows. However, systems that treat larger flows load wastewaters to the soil over a greater area and might exceed the site's capacity to accept the wastewater. Restrictive horizons that may inhibit deep percolation need to



be identified before design. Ground water mounding analysis should be performed to determine whether the hydraulic loading to the saturated zone (secondary design boundary), rather than the loading to the infiltration surface, controls system sizing (see Chapter 5). If the secondary boundary controls design, the size of the infiltration surface, its geometry, and even how wastewater is applied will be affected.

### Infiltration surface sizing

Selection of the design flow is a very important consideration in infiltration surface sizing. State codified design flows for residential systems typically are 2 to 5 times greater than the average daily flow actually generated in the home. This occurs because the design flow is usually based on the number of bedrooms rather than the number of occupants. As a result, the actual daily flow is often a small fraction of the design flow.

This is not the case when the per capita flows for the population served or metered flows are used as the design flow. In such instances, the ratio of design flow to actual daily flow can approach unity. This is because the same factors of safety are typically not used to determine the design flow. In itself, this is not a problem. The problem arises when the metered or averaged hydraulic loading rates are used to size the infiltration surface. These rates can be more than two times what the soil below the undersized system is actually able to accept. As a result, SWISs would be significantly undersized. This problem is exacerbated where the waste strength is high.

To avoid the problem of undersizing the infiltration surface, designs must compensate in some way. Factors of safety of up to 2 or more could be applied to accurate flow estimates, but the more common practice is to design multiple cells that provide 150 to 200 percent of the total estimated infiltration surface needed. Multiple cells are a good approach because the cells can be rotated into service on a regular schedule that allows the cells taken out of service to rest and rejuvenate their hydraulic capacity. Further, the system provides standby capacity that can be used when malfunctions occur, and distribution networks are smaller to permit smaller and more frequent dosing, thereby maximizing oxygen transfer and the hydraulic capacity of the site. For high-strength wastewaters, advanced pretreatment can be speci-

fied or the infiltration surface loadings can be adjusted (see *Special Issue Fact Sheet 4*).

### Contingency planning

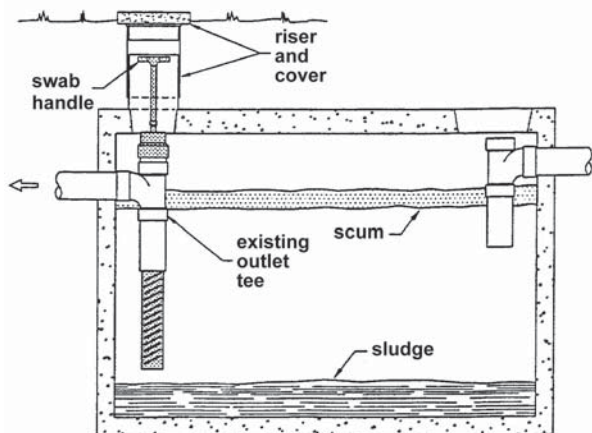
Malfunctions of systems that treat larger flows can create significant public health and environmental hazards. Therefore, adequate contingency planning is more critical for these systems than for residential systems. Standby infiltration cells, timed dosing, and flow monitoring are key design elements that should be included. Also, professional management should be required.

## 4.6 Septic tanks

The septic tank is the most commonly used wastewater pretreatment unit for onsite wastewater systems. Tanks may be used alone or in combination with other processes to treat raw wastewater before it is discharged to a subsurface infiltration system. The tank provides primary treatment by creating quiescent conditions inside a covered, watertight rectangular, oval, or cylindrical vessel, which is typically buried. In addition to primary treatment, the septic tank stores and partially digests settled and floating organic solids in sludge and scum layers. This can reduce the sludge and scum volumes by as much as 40 percent, and it conditions the wastewater by hydrolyzing organic molecules for subsequent treatment in the soil or by other unit processes (Baumann et al., 1978). Gases generated from digestion of the organics are vented back through the building sewer and out of the house plumbing stack vent. Inlet structures are designed to limit short circuiting of incoming wastewater across the tank to the outlet, while outlet structures (e.g., a sanitary “tee” fitting) retain the sludge and scum layers in the tank and draw effluent only from the clarified zone between the sludge and scum layers. The outlet should be fitted with an effluent screen (commonly called a septic tank filter) to retain larger solids that might be carried in the effluent to the SWIS, where it could contribute to clogging and eventual system failure. Inspection ports and manways are provided in the tank cover to allow access for periodically removing the tank contents, including the accumulated scum and sludge (figure 4-21). A diagram of a two-compartment tank is shown later in this section.

Septic tanks are used as the first or only pretreatment step in nearly all onsite systems regardless of

Figure 4-21. Profile of a single-compartment septic tank with outlet screen



daily wastewater flow rate or strength. Other mechanical pretreatment units may be substituted for septic tanks, but even when these are used septic tanks often precede them. The tanks passively provide suspended solids removal, solids storage and digestion, and some peak flow attenuation.

### 4.6.1 Treatment

A septic tank removes many of the settleable solids, oils, greases, and floating debris in the raw wastewater, achieving 60 to 80 percent removal (Baumann et al., 1978; Boyer and Rock, 1992; University of Wisconsin, 1978). The solids removed are stored in sludge and scum layers, where they undergo liquefaction. During liquefaction, the first step in the digestion process, acid-forming bacteria

partially digest the solids by hydrolyzing the proteins and converting them to volatile fatty acids, most of which are dissolved in the water phase. The volatile fatty acids still exert much of the biochemical oxygen demand that was originally in the organic suspended solids. Because these acids are in the dissolved form, they are able to pass from the tank in the effluent stream, reducing the BOD removal efficiency of septic tanks compared to primary sedimentation. Typical septic tank BOD removal efficiencies are 30 to 50 percent (Boyer and Rock, 1992; University of Wisconsin, 1978; see table 4-10). Complete digestion, in which the volatile fatty acids are converted to methane, could reduce the amount of BOD released by the tank, but it usually does not occur to a significant extent because wastewater temperatures in septic tanks are typically well below the optimum temperature for methane-producing bacteria.

Gases that form from the microbial action in the tank rise in the wastewater column. The rising gas bubbles disturb the quiescent wastewater column, which can reduce the settling efficiency of the tank. They also dislodge colloidal particles in the sludge blanket so they can escape in the water column. At the same time, however, they can carry active anaerobic and facultative microorganisms that might help to treat colloidal and dissolved solids present in the wastewater column (Baumann and Babbitt, 1953).

Septic tank effluent varies naturally in quality depending on the characteristics of the wastewater and condition of the tank. Documented effluent quality from single-family homes, small communities and cluster systems, and various commercial septic tanks is presented in tables 4-10 through 4-12.

Table 4-10. Characteristics of domestic septic tank effluent

Parameter	University of Wis. (1978)	Harkin, et al. (1979)	Ronayne, et al. (1982)	Ayres Associates (1993)	Ayres Associates (1996)
No. tanks sampled	7	33	8	8	1
Location (No. samples)	Wisconsin (150)	Wisconsin (140 - 215)	Oregon (56)	Florida (36)	Florida (3)
BOD <sub>5</sub> (mg/L)	138	132	217	141	179
COD (mg/L)	327	445	—	—	—
TSS (mg/L)	49	87	146	161	59
TKN (mgN/L)	45	82	57.1	39	66
TP (mgP/l)	13	21.8	—	11	17
Oil/Grease (mg/L)	—	—	—	36	37
Fecal coliforms (log#/L)	4.6	6.5	6.4	5.1-8.2	7.0

Table 4-11. Average septic tank effluent concentrations for selected parameters from small community and cluster systems

Parameter	Westboro, WI <sup>a</sup>	Bend, OR <sup>b</sup>	Glide, OR <sup>c</sup>	Manila, CA <sup>d</sup>	College Sta., TX <sup>e</sup>
BOD <sub>5</sub> (mg/L)	168	157	118	189	--
COD (mg/L)	338	276	228	284	266
TSS (mg/L)	85	36	52	75	--
TN (mgN/L)	63.4	41	50	--	29.5
TP (mgP/L)	8.1	--	--	--	8.2
Oil/Grease (mg/L)	--	65	16	22	--
Fecal coliforms (log#/L)	7.3	--	--	--	6.0
pH	6.9–7.4	6.4–7.2	6.4–7.2	6.5–7.8	7.4
Flow (gpcd)	36	40–60	48	40–57	--

<sup>a</sup> Small-diameter gravity sewer serving a small community collecting septic tank effluent from 90 connections (Otis, 1978).

<sup>b</sup> Pressure sewer collecting septic tank effluent from eleven homes (Bowne, 1982).

<sup>c</sup> Pressure sewer collecting septic tank effluent from a small community (Bowne, 1982).

<sup>d</sup> Pressure sewer serving a small community collecting septic tank effluent from 330 connections (Bowne, 1982).

<sup>e</sup> Effluent from one septic tank accepting wastewater from nine homes (Brown et al., 1977).

Table 4-12. Average septic tank effluent concentrations of selected parameters from various commercial establishments<sup>a</sup>

Wastewater Type	BOD <sub>5</sub> (mg/L)	COD (mg/L)	TSS (mg/L)	TKN (mgN/L)	TP (mgP/L)	Oil/Grease (mg/L)	Temp (°C)	pH
Restaurant A	582	1196	187	82	24	101	8–22	5.6–6.4
Restaurant B	245	622	65	64	14	40	8–22	6.6–7.0
Restaurant C	880	1667	372	71	23	144	13–23	5.8–6.3
Restaurant D	377	772	247	30	15	101	16–21	5.7–6.8
Restaurant E	693	1321	125	78	28	65	4–26	5.5–6.9
Restaurant F	261	586	66	73	19	47	7–25	5.8–7.0
Motel	171	381	66	34	20	45	20–28	6.5–7.1
Country Club A	197	416	56	36	13	24	6–20	6.5–6.8
Country Club B	333	620	121	63	17	46	13–26	6.2–6.8
Country Club C	101	227	44	36	10	33	10–23	6.2–7.4
Bar/Grill	179	449	79	61	7	49	8–22	6.0–7.0

<sup>a</sup> Averages based on 2 to 9 grab samples depending on the parameter taken between March and September 1983.

Source: Siegrist et al., 1985.

## Volume

### 4.6.2 Design considerations

The primary purpose of a septic tank is to provide suspended solids and oil/grease removal through sedimentation and flotation. The important factor to achieving good sedimentation is maintaining quiescent conditions. This is accomplished by providing a long wastewater residence time in the septic tank. Tank volume, geometry, and compartmentalization affect the residence time.

Septic tanks must have sufficient volume to provide an adequate hydraulic residence time for sedimentation. Hydraulic residence times of 6 to 24 hours have been recommended (Baumann and Babbitt, 1953; Kinnicutt et al., 1910). However, actual hydraulic residence times can vary significantly from tank to tank because of differences in geometry, depth, and inlet and outlet configurations (Baumann and Babbitt, 1953). Sludge and scum also affect the residence time, reducing it as the solids accumulate.

**Table 4-13. Septic tank capacities for one- and two-family dwellings (ICC, 1995).**

Number of bedrooms	Septic tank volume (gallons)
1	750 <sup>a</sup>
2	750 <sup>a</sup>
3	1,000
4	1,200
5	1,425
6	1,650
7	1,875
8	2,100

<sup>a</sup> Many states have established 1,000 gallons or more as the minimum size.

Most state and national plumbing codes specify the tank volume to be used based on the building size or estimated peak daily flow of wastewater. Table 4-13 presents the tank volumes recommended in the International Private Sewage Disposal Code specified for one- and two-family residences (ICC, 1995). The volumes specified are typical of most local codes, but in many jurisdictions the minimum tank volume has been increased to 1,000 gallons or more. For buildings other than one- or two-family residential homes, the rule of thumb often used for sizing tanks is to use two to three times the esti-

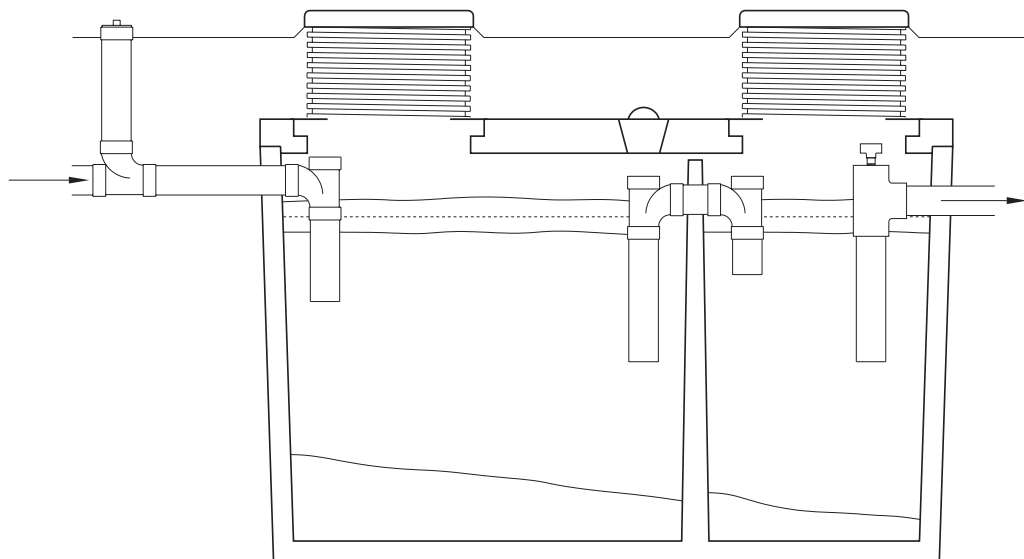
mated design flow. This conservative rule of thumb is based on maintaining a 24-hour minimum hydraulic retention time when the tank is ready for pumping, for example, when the tank is one-half to two-thirds full of sludge and scum.

**Geometry**

Tank geometry affects the hydraulic residence time in the tank. The length-to-width ratio and liquid depth are important considerations. Elongated tanks with length-to-width ratios of 3:1 and greater have been shown to reduce short-circuiting of the raw wastewater across the tank and improve suspended solids removal (Ludwig, 1950). Prefabricated tanks generally are available in rectangular, oval, and cylindrical (horizontal or vertical) shapes. Vertical cylindrical tanks can be the least effective because of the shorter distance between the inlets and outlets. Baffles are recommended.

Among tanks of equal liquid volumes, the tank with shallower liquid depths better reduces peak outflow rates and velocities, so solids are less likely to remain in suspension and be carried out of the tank in the effluent. This is because the shallow tank has a larger surface area. Inflows to the tank cause less of a liquid rise because of the larger surface area. The rate of flow exiting the tank (over a weir or through a pipe invert) is propor-

**Figure 4-22. Two-compartment tank with effluent screen and surface risers**



Source: Washington Department of Health, 1998.

tional to the height of the water surface over the invert (Baumann et al., 1978; Jones, 1975). Also, the depth of excavation necessary is reduced with shallow tanks, which helps to avoid saturated horizons and lessens the potential for ground water infiltration or tank flotation. A typically specified minimum liquid depth below the outlet invert is 36 inches. Shallower depths can disturb the sludge blanket and, therefore, require more frequent pumping.

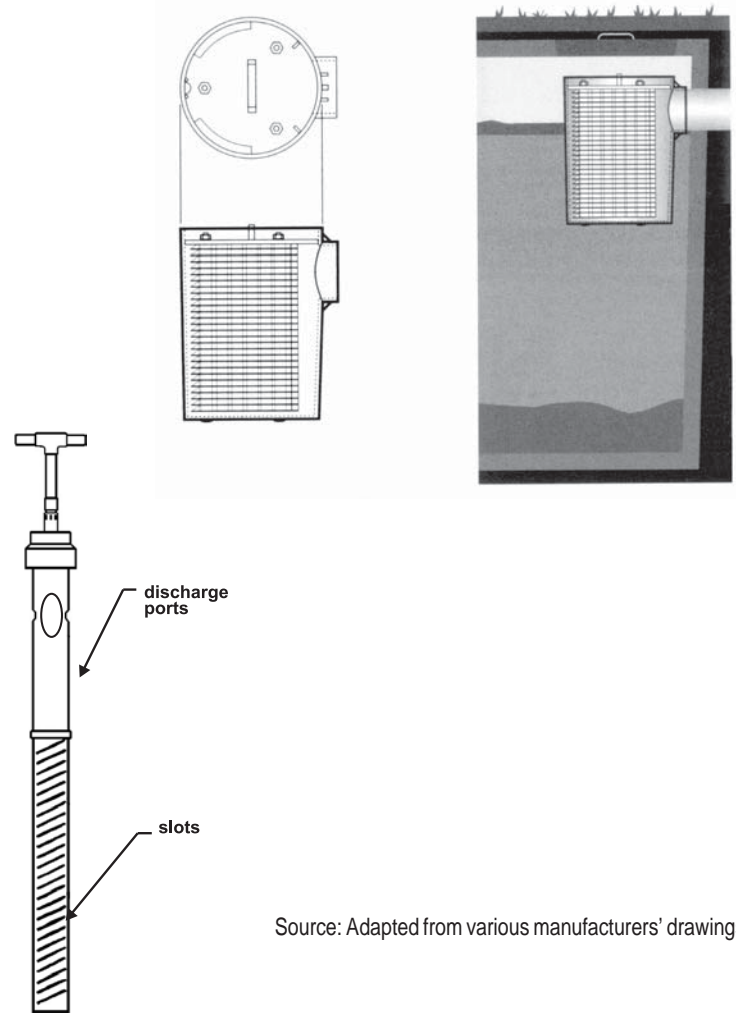
### Compartmentalization

Compartmentalized tanks (figure 4-23) or tanks placed in series provide better suspended solids removal than single-compartment tanks alone, although results from different studies vary (Baumann and Babbitt, 1953; Boyer and Rock, 1992; Weibel et al., 1949, 1954; University of Wisconsin, 1978). If two compartments are used, better suspended solids removal rates are achieved if the first compartment is equal to one-half to two-thirds the total tank volume (Weibel et al., 1949, 1954). An air vent between compartments must be provided to allow both compartments to vent. The primary advantage of these configurations is when gas generated from organic solids digestion in the first compartment is separated from subsequent compartments.

### Inlets and outlets

The inlet and outlet of a septic tank are designed to enhance tank performance. Their respective invert elevations should provide at least a 2- to 3-inch drop across the tank to ensure that the building sewer does not become flooded and obstructed during high wastewater flows (figure 4-24). A clear space of at least 9 inches should be provided above the liquid depth (outlet invert) to allow for scum storage and ventilation. Both the inlet and outlet are commonly baffled. Plastic sanitary tees are the most commonly used baffles. Curtain baffles (concrete baffles cast to the tank wall and fiberglass or plastic baffles bolted to the tank wall) have also been used. The use of gasket materials that achieve a watertight joint with the tank wall makes plastic sanitary tees easy to adjust, repair, or equip with effluent screens or filters. The use of a removable, cleanable effluent screen connected to the outlet is strongly recommended.

Figure 4-23. Examples of septic tank effluent screens/filters



Source: Adapted from various manufacturers' drawings.

The inlet baffle is designed to prevent short-circuiting of the flow to the outlet by dissipating the energy of the influent flow and deflecting it downward into the tank. The rising leg of the tee should extend at least 6 inches above the liquid level to prevent the scum layer from plugging the inlet. It should be open at the top to allow venting of the tank through the building sewer and out the plumbing stack vent. The descending leg should extend well into the clear space between the sludge and scum layers, but not more than about 30 to 40 percent of the liquid depth. The volume of the descending leg should not be larger than 2 to 3 gallons so that it is completely flushed to expel floating materials that could cake the inlet. For this reason, curtain baffles should be avoided.



The outlet baffle is designed to draw effluent from the clear zone between the sludge and scum layers. The rising leg of the tee should extend 6 inches above the liquid level to prevent the scum layer from escaping the tank. The descending leg should extend to 30 or 40 percent of the liquid depth. Effluent screens (commonly called septic tank filters), which can be fitted to septic tank outlets, are commercially available. Screens prevent solids that either are buoyant or are resuspended from the scum or sludge layers from passing out of the tank (figures 4-22 and 4-23). Mesh, slotted screens, and stacked plates with openings from 1/32 to 1/8 inch are available. Usually, the screens can be fitted into the existing outlet tee or retrofitted directly into the outlet. An access port directly above the outlet is required so the screen can be removed for inspection and cleaning.

Quality-assured, reliable test results have not shown conclusively that effluent screens result in effluents with significantly lower suspended solids and BOD concentrations. However, they provide an excellent, low-cost safeguard against neutral-buoyancy solids and high suspended solids in the tank effluent resulting from solids digestion or other upsets. Also, as the effluent screens clog over time, slower draining and flushing of home fixtures may alert homeowners of the need for maintenance before complete blockage occurs.

### **Tank access**

Access to the septic tank is necessary for pumping septage, observing the inlet and outlet baffles, and servicing the effluent screen. Both manways and inspection ports are used. Manways are large openings, 18 to 24 inches in diameter or square. At least one that can provide access to the entire tank for septage removal is needed. If the system is compartmentalized, each compartment requires a manway. They are located over the inlet, the outlet, or the center of the tank. Typically, in the past manway covers were required to be buried under state and local codes. However, they should be above grade and fitted with an airtight, lockable cover so they can be accessed quickly and easily. Inspection ports are 8 inches or larger in diameter and located over both the inlet and the outlet unless a manway is used. They should be extended above grade and securely capped.

*(CAUTION: The screen should not be removed for inspection or cleaning without first plugging the outlet or pumping the tank to lower the liquid level below the outlet invert. Solids retained on the screen can slough off as the screen is removed. These solids will pass through the outlet and into the SWIS unless precautions are taken. This caution should be made clear in homeowner instructions and on notices posted at the access port.)*

Septic tank designs for large wastewater flows do not differ from designs for small systems. However, it is suggested that multiple compartments or tanks in series be used and that effluent screens be attached to the tank outlet. Access ports and manways should be brought to grade and provided with locking covers for all large systems.

### **Construction materials**

Septic tanks smaller than 6,000 gallons are typically premanufactured; larger tanks are constructed in place. The materials used in premanufactured tanks include concrete, fiberglass, polyethylene, and coated steel. Precast concrete tanks are by far the most common, but fiberglass and plastic tanks are gaining popularity. The lighter weight fiberglass and plastic tanks can be shipped longer distances and set in place without cranes. Concrete tanks, on the other hand, are less susceptible to collapse and flotation. Coated steel tanks are no longer widely used because they corrode easily. Tanks constructed in place are typically made of concrete.

Tanks constructed of fiberglass-reinforced polyester (FRP) usually have a wall thickness of about 1/4 inch (6 millimeters). Most are gel- or resin-coated to provide a smooth finish and prevent glass fibers from becoming exposed, which can cause wicking. Polyethylene tanks are more flexible than FRP tanks and can deform to a shape of structural weakness if not properly designed. Concrete tank walls are usually about 4 inches thick and reinforced with no. 5 rods on 8-inch (20-centimeter) centers. Sulfuric acid and hydrogen sulfide, both of which are present in varying concentrations in septic tank effluent, can corrode exposed rods and the concrete itself over time. Some plastics (e.g., polyvinyl chloride, polyethylene, but not nylon) are virtually unaffected by acids and hydrogen sulfide (USEPA, 1991).

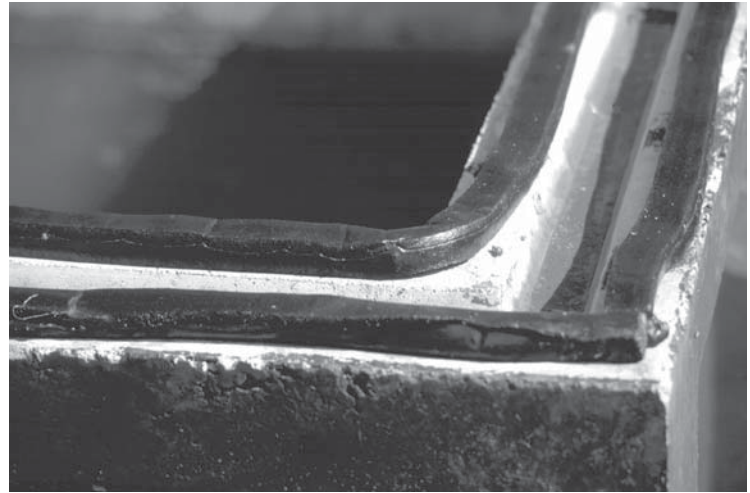
Quality construction is critical to proper performance. Tanks must be properly designed, reinforced, and constructed of the proper mix of materials so they can meet anticipated loads without cracking or collapsing. All joints must be watertight and flexible to accommodate soil conditions. For concrete tank manufacturing, a “best practices manual” can be purchased from the National Pre-Cast Concrete Association (NPCA, 1998). Also, a *Standard Specification for Precast Concrete Septic Tanks (C 1227)* has been published by the American Society for Testing and Materials (ASTM, 1998).

**Watertightness**

Watertightness of the septic tank is critical to the performance of the entire onsite wastewater system. Leaks, whether exfiltrating or infiltrating, are serious. Infiltration of clear water to the tank from the building storm sewer or ground water adds to the hydraulic load of the system and can upset subsequent treatment processes. Exfiltration can threaten ground water quality with partially treated wastewater and can lower the liquid level below the outlet baffle so it and subsequent processes can become fouled with scum. Also, leaks can cause the tank to collapse.

Tank joints should be designed for watertightness. Two-piece tanks and tanks with separate covers should be designed with tongue and groove or lap joints (figure 4-24). Manway covers should have similar joints. High-quality, preformed joint sealers should be used to achieve a watertight seal. They should be workable over a wide temperature range and should adhere to clean, dry surfaces; they must not shrink, harden, or oxidize. Seals should meet the minimum compression and other requirements prescribed by the seal manufacturer. Pipe and

Figure 4-24. Tongue and groove joint and sealer



Source: Ayres Associates

inspection port joints should have cast-in rubber boots or compression seals.

Septic tanks should be tested for watertightness using hydrostatic or vacuum tests, and manway risers and inspection ports should be included in the test. The professional association representing the materials industry of the type of tank construction (e.g., the National Pre-cast Concrete Association) should be contacted to establish the appropriate testing criteria and procedures. Test criteria for precast concrete are presented in table 4-14.

**4.6.3 Construction considerations**

Important construction considerations include tank location, bedding and backfilling, watertightness, and flotation prevention, especially with non-concrete tanks. Roof drains, surface water runoff, and other clear water sources must not be routed to the septic tank. Attention to these considerations

Table 4-14. Watertightness testing procedure/criteria for precast concrete tanks

Standard	Hydrostatic test		Vacuum test	
	Preparation	Pass/fail criterion	Preparation	Pass/fail criterion
<b>C 1227, ASTM (1993)</b>	Seal tank, fill with water, and let stand for 24 hours. Refill tank.	Approved if water level is held for 1 hour	Seal tank and apply a vacuum of 2 in. Hg.	Approved if 90% of vacuum is held for 2 minutes.
<b>NPCA (1998)</b>	Seal tank, fill with water, and let stand for 8 to 10 hours. Refill tank and let stand for another 8 to 10 hours.	Approved if no further measurable water level drop occurs	Seal tank and apply a vacuum of 4 in. Hg. Hold vacuum for 5 minutes. Bring vacuum back to 4 in. Hg.	Approved if vacuum can be held for 5 minutes without a loss of vacuum.

will help to ensure that the tank performs as intended.

### **Location**

The tank should be located where it can be accessed easily for septage removal and sited away from drainage swales or depressions where water can collect. Local codes must be consulted regarding minimum horizontal setback distances from buildings, property boundaries, wells, water lines, and the like.

### **Bedding and backfilling**

The tank should rest on a uniform bearing surface. It is good practice to provide a level, granular base for the tank. The underlying soils must be capable of bearing the weight of the tank and its contents. Soils with a high organic content or containing large boulders or massive rock edges are not suitable.

After setting the tank, leveling, and joining the building sewer and effluent line, the tank can be backfilled. The backfill material should be free-flowing and free of stones larger than 3 inches in diameter, debris, ice, or snow. It should be added in lifts and each lift compacted. In fine-textured soils such as silts, silt loams, clay loams, and clay, imported granular material should be used. This is a must where freeze and thaw cycles are common because the soil movement during such cycles can work tank joints open. This is a significant concern when using plastic and fiberglass tanks.

The specific bedding and backfilling requirements vary with the shape and material of the tank. The manufacturer should be consulted for acceptable materials and procedures.

### **Watertightness**

All joints must be sealed properly, including tank joints (sections and covers if not a monolithic tank), inlets, outlets, manways, and risers (ASTM, 1993; NPCA, 1998). The joints should be clean and dry before applying the joint sealer. Only high-quality joint sealers should be used (see previous section). Backfilling should not proceed until the sealant setup period is completed. After all joints have been made and have cured, a watertightness

test should be performed (see table 4-14 for precast concrete tanks). Risers should be tested.

### **Flotation prevention**

If the tank is set where the soil can be saturated, tank flotation may occur, particularly when the tank is empty (e.g., recently pumped dose tanks or septic tank after septage removal). Tank manufacturers should be consulted for appropriate antifoatation devices.

## **4.6.4 Operation and maintenance**

The septic tank is a passive treatment unit that typically requires little operator intervention. Regular inspections, septage pumping, and periodic cleaning of the effluent filter or screen are the only operation and maintenance requirements. Commercially available microbiological and enzyme additives are promoted to reduce sludge and scum accumulations in septic tanks. They are not necessary for the septic tank to function properly when treating domestic wastewaters. Results from studies to evaluate their effectiveness have failed to prove their cost-effectiveness for residential application. For most products, concentrations of suspended solids and BOD in the septic tank effluent increase upon their use, posing a threat to SWIS performance. No additive made up of organic solvents or strong alkali chemicals should be used because they pose a potential threat to soil structure and ground water.

### **Inspections**

Inspections are performed to observe sludge and scum accumulations, structural soundness, watertightness, and condition of the inlet and outlet baffles and screens. *(Warning: In performing inspections or other maintenance, the tank should not be entered. The septic tank is a confined space and entering can be extremely hazardous because of toxic gases and/or insufficient oxygen.)*

#### *Sludge and scum accumulations*

As wastewater passes through and is partially treated in the septic tank over the years, the layers of floatable material (scum) and settleable material (sludge) increase in thickness and gradually reduce the amount of space available for clarified waste-

water. If the sludge layer rises to the bottom of the effluent T-pipe, solids can be drawn through the effluent port and transported into the infiltration field, increasing the risk of clogging. Likewise, if the bottom of the thickening scum layer moves lower than the bottom of the effluent T-pipe, oils and other scum material can be drawn into the piping that discharges to the infiltration field. Various devices are commercially available to measure sludge and scum depths. The scum layer should not extend above the top or below the bottom of either the inlet or outlet tees. The top of the sludge layer should be at least 1 foot below the bottom of either tee or baffle. Usually, the sludge depth is greatest below the inlet baffle. The scum layer bottom must not be less than 3 inches above the bottom of the outlet tee or baffle. If any of these conditions are present, there is a risk that wastewater solids will plug the tank inlet or be carried out in the tank effluent and begin to clog the SWIS.

#### *Structural soundness and watertightness*

Structural soundness and watertightness are best observed after the septage has been pumped from the tank. The interior tank surfaces should be inspected for deterioration, such as pitting, spalling, delamination, and so forth and for cracks and holes. The presence of roots, for example, indicates tank cracks or open joints. These observations should be made with a mirror and bright light. Watertightness can be checked by observing the liquid level (before pumping), observing all joints for seeping water or roots, and listening for running or dripping water. Before pumping, the liquid level of the tank should be at the outlet invert level. If the liquid level is below the outlet invert, exfiltration is occurring. If it is above, the outlet is obstructed or the SWIS is flooded. A constant trickle from the inlet is an indication that plumbing fixtures in the building are leaking and need to be inspected.

#### *Baffles and screens*

The baffles should be observed to confirm that they are in the proper position, secured well to the piping or tank wall, clear of debris, and not cracked or broken. If an effluent screen is fitted to the outlet baffle, it should be removed, cleaned, inspected for irregularities, and replaced. Note that

effluent screens should not be removed until the tank has been pumped or the outlet is first plugged.

### **Septic tank pumping**

Tanks should be pumped when sludge and scum accumulations exceed 30 percent of the tank volume or are encroaching on the inlet and outlet baffle entrances. Periodic pumping of septic tanks is recommended to ensure proper system performance and reduce the risk of hydraulic failure. If systems are not inspected, septic tanks should be pumped every 3 to 5 years depending on the size of the tank, the number of building occupants, and household appliances and habits (see Special Issues Fact Sheets). Commercial systems should be inspected and/or pumped more frequently, typically annually. There is a system available that provides continuous monitoring and data storage of changes in the sludge depth, scum or grease layer thickness, liquid level, and temperature in the tank. Long-term verification studies of this system are under way. Accumulated sludge and scum material stored in the tank should be removed by a certified, licensed, or trained service provider and reused or disposed of in accordance with applicable federal, state, and local codes. (Also see section 4.5.5.)

### **4.6.5 Septage**

Septage is an odoriferous slurry (solids content of only 3 to 10 percent) of organic and inorganic material that typically contains high levels of grit, hair, nutrients, pathogenic microorganisms, oil, and grease (table 4-15). Septage is defined as the entire contents of the septic tank—the scum, the sludge, and the partially clarified liquid that lies between them—and also includes pumpings from aerobic treatment unit tanks, holding tanks, biological (“composting”) toilets, chemical or vault toilets, and other systems that receive domestic wastewaters. Septage is controlled under the federal regulations at 40 CFR Part 503. Publications and other information on compliance with these regulations can be found at <http://www.epa.gov/oia/tips/scws.htm>.

Septage also may harbor potentially toxic levels of metals and organic and inorganic chemicals. The exact composition of septage from a particular treatment system is highly dependent upon the type of facility and the activities and habits of its users.



**Table 4-15. Chemical and physical characteristics of domestic septage**

Parameter	Concentration (mg/L)	
	Average	Range
Total solids	34,106	1,132–130,475
Total volatile solids	23,100	353–71,402
Total suspended solids	12,862	310–93,378
Volatile suspended solids	9,027	95–51,500
Biochemical oxygen demand	6,480	440–78,600
Chemical oxygen demand	31,900	1,500–703,000
Total Kjeldahl nitrogen	588	66–1,060
Ammonia nitrogen	97	3–116
Total phosphorus	210	20–760
Alkalinity	970	522–4,190
Grease	5,600	208–23,368
pH	—	1.5–12.6

Source: USEPA, 1994.

For example, oil and grease levels in septage from food service or processing facilities might be many times higher than oil and grease concentrations in septage from residences (see Special Issues Fact Sheets). Campgrounds that have separate graywater treatment systems for showers will likely have much higher levels of solids in the septage from the blackwater (i.e., toilet waste) treatment system. Septage from portable toilets might have been treated with disinfectants, deodorizers, or other chemicals.

### Septage management programs

The primary objective of a septage management program is to establish procedures and rules for handling and disposing of septage in an affordable manner that protects public health and ecological resources. When planning a program it is important to have a thorough knowledge of legal and regulatory requirements regarding handling and disposal. USEPA (1994) has issued regulations and guidance that contain the type of information required for developing, implementing, and maintaining a septage management program. Detailed guidance for identifying, selecting, developing, and operating reuse or disposal sites for septage is provided in *Process Design Manual: Surface Disposal of Sewage Sludge and Domestic Septage* (USEPA,

1995<sup>b</sup>), which is on the Internet at <http://www.epa.gov/ORD/WebPubs/sludge.pdf>. Additional information can be found in *Domestic Septage Regulatory Guidance* (USEPA, 1993), at <http://www.epa.gov/oia/tips/scws.htm>.

States and municipalities typically establish public health and environmental protection regulations for septage management (pumping, handling, transport, treatment, and reuse/disposal). Key components of septage management programs include tracking or manifest systems that identify acceptable septage sources, pumpers, transport equipment, final destination, and treatment, as well as procedures for controlling human exposure to septage, including vector control, wet weather runoff, and access to disposal sites.

### Septage treatment/disposal: land application

The ultimate fate of septage generally falls into three basic categories—land application, treatment at a wastewater treatment plant, or treatment at a special septage treatment plant. Land application is the most commonly used method for disposing of septage in the United States. Simple and cost-effective, land application approaches use minimal energy and recycle organic material and nutrients back to the land. Topography, soils, drainage patterns, and agricultural crops determine which type of land disposal practice works best for a given situation. Some common alternatives are surface application, subsurface incorporation, and burial. Disposal of portable toilet wastes mixed with disinfectants, deodorizers, or other chemicals at land application sites is not recommended. If possible, these wastes should be delivered to the collection system of a wastewater treatment plant to avoid potential chemical contamination risks at septage land application sites. Treatment plant operators should be consulted so they can determine when and where the septage should be added to the collection system.

When disposing of septage by land application, appropriate buffers and setbacks should be provided between application areas and water resources (e.g., streams, lakes, sinkholes). Other considerations include vegetation type and density, slopes, soils, sensitivity of water resources, climate,



and application rates. Agricultural products from the site must not be directly consumed by humans. Land application practices include the following:

#### *Spreading by hauler truck or farm equipment*

In the simplest method, the truck that pumps the septage takes it to a field and spreads it on the soil. Alternatively, the hauler truck can transfer its septage load into a wagon spreader or other specialized spreading equipment or into a holding facility at the site for spreading later.

#### *Spray irrigation*

Spray irrigation is an alternative that eliminates the problem of soil compaction by tires. Pretreated septage is pumped at 80 to 100 psi through nozzles and sprayed directly onto the land. This method allows for septage disposal on fields with rough terrain.

#### *Ridge and furrow irrigation*

Pretreated septage can be transferred directly into furrows or row crops. The land should be relatively level.

#### *Subsurface incorporation of septage*

This alternative to surface application involves placing untreated septage just below the surface. This approach reduces odors and health risks while still fertilizing and conditioning the soil. The method can be applied only on relatively flat land (less than 8 percent slope) in areas where the seasonally high water table is at least 20 inches. Because soil compaction is a concern, no vehicles should be allowed to drive on the field for 1 to 2 weeks after application. Subsurface application practices include the following:

- *Plow and furrow irrigation:* In this simple method, a plow creates a narrow furrow 6 to 8 inches (15 to 20 centimeters) deep. Liquid septage is discharged from a tank into the furrow, and a second plow covers the furrow.
- *Subsurface injection:* A tillage tool is used to create a narrow cavity 4 to 6 inches (10 to 15 centimeters) deep. Liquid septage is injected into the cavity, and the hole is covered.

#### *Codisposal of septage in sanitary landfills*

Because of the pollution risks associated with runoff and effluent leaching into ground water, landfill disposal of septage is not usually a viable option. However, some jurisdictions may allow disposal of septage/soil mixtures or permit other special disposal options for dewatered septage (sludge with at least 20 percent solids). Septage or sludge deposited in a landfill should be covered immediately with at least 6 inches of soil to control odors and vector access (USEPA, 1995b). (*Note: Codisposal of sewage sludge or domestic septage at a municipal landfill is considered surface disposal and is regulated under 40 CFR Part 258.*)

### **Septage treatment/disposal: treatment plants**

Disposal of septage at a wastewater treatment plant is often a convenient and cost-effective option. Addition of septage requires special care and handling because by nature septage is more concentrated than the influent wastewater stream at the treatment plant. Therefore, there must be adequate capacity at the plant to handle and perhaps temporarily store delivered septage until it can be fed into the treatment process units. Sites that typically serve as the input point for septage to be treated at a wastewater treatment plant include the following:

#### *Upstream sewer manhole*

This alternative is viable for larger sewer systems and treatment plants. Septage is added to the normal influent wastewater flow at a receiving station fitted with an access manhole.

#### *Treatment plant headworks*

The septage is added at the treatment plant upstream of the inlet screens and grit chambers. The primary concern associated with this option is the impact of the introduced wastes on treatment unit processes in the plant. A thorough analysis should be conducted to ensure that plant processes can accept and treat the wastes while maintaining appropriate effluent pollutant concentrations and meeting other treatment requirements. In any event, the treatment plant operator should be consulted before disposal.

*Sludge-handling process*

To reduce loading to the liquid stream, the septage can be sent directly to the sludge-handling process. Like the headworks option, the impact on the sludge treatment processes must be carefully analyzed to ensure that the final product meets treatment and other requirements.

*Treatment at a special septage treatment plant*

This method of septage disposal is usually employed in areas where land disposal or treatment at a wastewater treatment plant is not a feasible option. There are few of these facilities, which vary from simple lagoons to sophisticated plants that mechanically and/or chemically treat septage. Treatment processes used include lime stabilization, chlorine oxidation, aerobic and anaerobic digestion, composting, and dewatering using pressure or vacuum filtration or centrifugation. This is the most expensive option for septage management and should be considered only as a last resort.

**Public outreach and involvement**

Developing septage treatment units or land application sites requires an effective public outreach program. Opposition to locating these facilities in the service area is sometimes based about incomplete or inaccurate information, fear of the unknown, and a lack of knowledge on potential impacts. Without an effective community-based program of involvement, even the most reasonable plan can be difficult to implement. Traditional guidance on obtaining public input in the development of disposal or reuse facilities can be found in *Process Design Manual: Surface Disposal of Sewage Sludge and Domestic Septage* (USEPA, 1995b), which is on the Internet at <http://www.epa.gov/ORD/WebPubs/sludge.pdf>.

Additional information can be found in *Domestic Septage Regulatory Guidance* (USEPA, 1993), posted at <http://www.epa.gov/oia/tips/scws.htm>. General guidance on developing and implementing a public outreach strategy is available in *Getting In Step: A Guide to Effective Outreach in Your Watershed*, published by the Council of State Governments (see chapter 2) and available at <http://www.epa.gov/owow/watershed/outreach/documents/>.

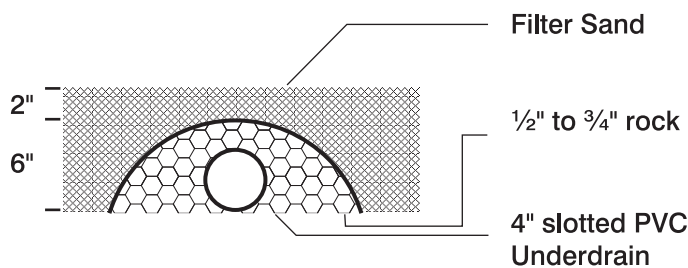
**4.7 Sand/media filters**

Sand (or other media) filters are used to provide advanced treatment of settled wastewater or septic tank effluent. They consist of a lined (lined with impervious PVC liner on sand bedding) excavation or watertight structure filled with uniformly sized washed sand (the medium) that is normally placed over an underdrain system (figure 4-25). These contained media filters are also known as packed bed filters. The wastewater is dosed onto the surface of the sand through a distribution network and is allowed to percolate through the sand to the underdrain system. The underdrain collects the filtrate for further processing, recycling, or discharging to a SWIS. Some “bottomless” designs directly infiltrate the filtered effluent into the soil below.

**4.7.1 Treatment mechanisms and filter design**

Sand filters are essentially aerobic, fixed-film bioreactors used to treat septic tank effluent. Other very important treatment mechanisms that occur in sand filters include physical processes such as straining and sedimentation, which remove suspended solids within the pores of the media, and chemical adsorption of dissolved pollutants (e.g., phosphorus) to media surfaces. The latter phenomenon tends to be finite because adsorption sites become saturated with the adsorbed compound, and it is specific to the medium chosen. Bioslimes from the growth of microorganisms develop as attached films on the sand particle surfaces. The microorganisms in the slimes absorb soluble and colloidal waste materials in the wastewater as it percolates around the sand surfaces. The absorbed materials are incorporated into new cell mass or degraded under aerobic conditions to carbon dioxide and water.

Figure 4-25. Underdrain system detail for sand filters



Most of the biochemical treatment occurs within approximately 6 inches (15 centimeters) of the filter surface. As the wastewater percolates through this active layer, carbonaceous BOD and ammonium-nitrogen are removed. Most of the suspended solids are strained out at the filter surface. The BOD is nearly completely removed if the wastewater retention time in the sand media is sufficiently long for the microorganisms to absorb and react with waste constituents. With depleting carbonaceous BOD in the percolating wastewater, nitrifying microorganisms are able to thrive deeper in this active surface layer, where nitrification will readily occur.

To achieve acceptable treatment, the wastewater retention time in the filter must be sufficiently long and reaeration of the media must occur to meet the oxygen demand of the applied wastewater. The pore size distribution and continuity of the filter medium, the dose volume, and the dosing frequency are key design and operating considerations for achieving these conditions. As the effective size and uniformity of the media increases, the reaeration rate increases, but the retention time decreases. Treatment performance might decline if the retention time is too short. If so, it may be necessary to recirculate the wastewater through the filter several times to achieve the desired retention time and concomitant treatment performance. Multiple small dose volumes that do not create a saturated wetting front on the medium can be used to extend residence times. If saturated conditions are avoided, moisture tensions within the medium will remain high, which will redistribute the applied wastewater throughout the medium, enhancing its contact with the bioslimes on the medium. The interval between doses provides time for reaeration of the medium to replenish the oxygen depleted during the previous dose.

Filter surface clogging can occur with finer media in response to excessive organic loadings. Biomass increases can partially fill the pores in the surface layer of the sand. If the organic loadings are too great, the biomass will increase to a point where the surface layer becomes clogged and is unable to accept further wastewater applications. However, if the applied food supply is less than that required by resident microorganisms, the microorganisms are forced into endogenous respiration; that is, they begin to draw on their stored metabolites or

surrounding dead cells for food. If the microorganisms are maintained in this growth phase, net increases of biomass do not occur and clogging can be minimized.

Chemical adsorption can occur throughout the medium bed, but adsorption sites in the medium are usually limited. The capacity of the medium to retain ions depends on the target constituent, the pH, and the mineralogy of the medium. Phosphorus is one element of concern in wastewater that can be removed in this manner, but the number of available adsorption sites is limited by the characteristics of the medium. Higher aluminum, iron, or calcium concentrations can be used to increase the effectiveness of the medium in removing phosphorus. Typical packed bed sand filters are not efficient units for chemical adsorption over an extended period of time. However, use of special media can lengthen the service (phosphorus removal) life of such filters beyond the normal, finite period of effective removal.

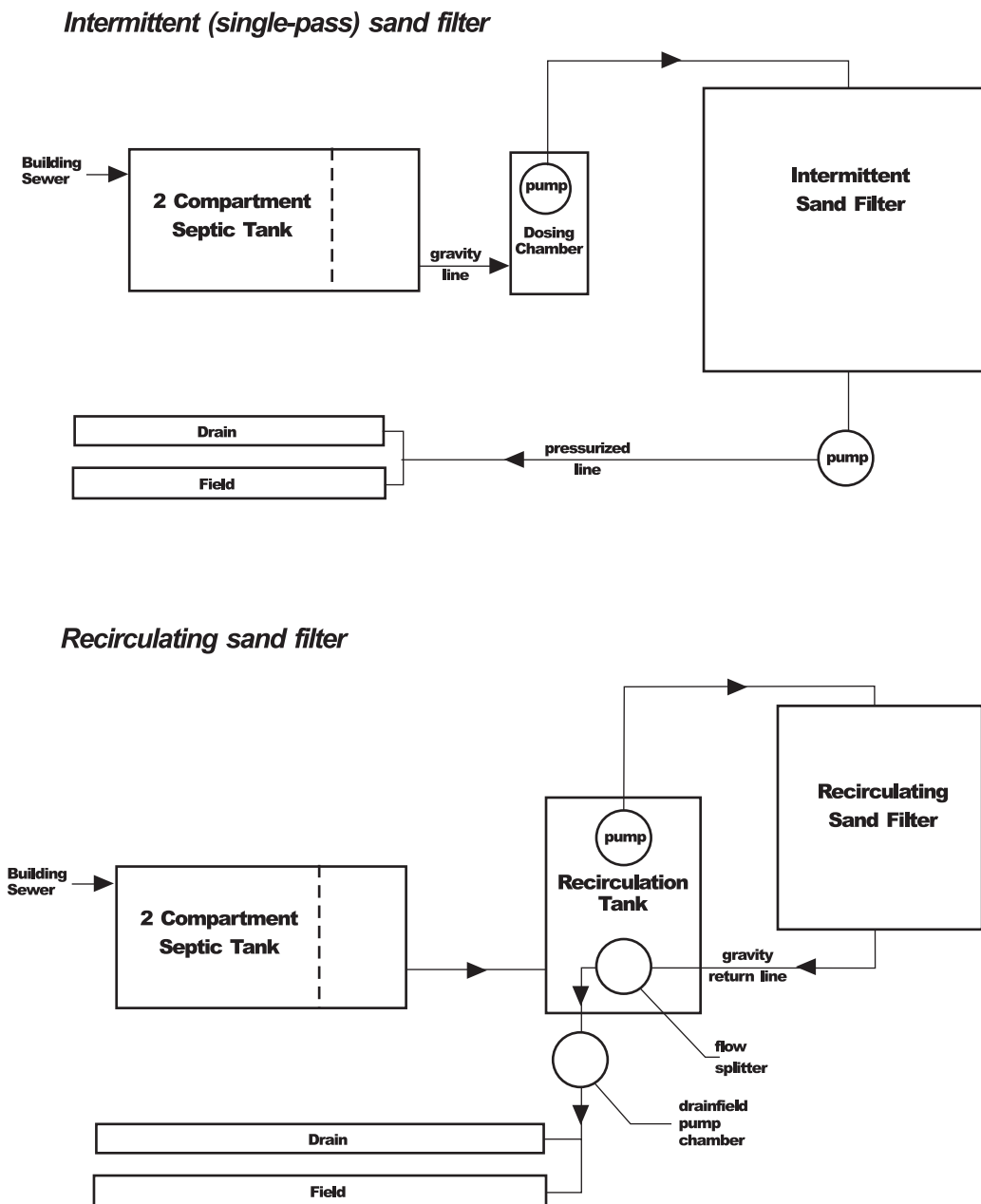
### Filter designs

Sand filters are simple in design and relatively passive to operate because the fixed-film process is very stable and few mechanical components are used. Two types of filter designs are common, “single-pass” and “recirculating” (figure 4-26). They are similar in treatment mechanisms and performance, but they operate differently. Single-pass filters, historically called “intermittent” filters, discharge treated septic tank effluent after one pass through the filter medium (see Fact Sheet 10). Recirculating filters collect and recirculate the filtrate through the filter medium several times before discharging it (see Fact Sheet 11). Each has advantages for different applications.

#### *Single-pass filters*

The basic components of single-pass filters (see Fact Sheet 10) include a dose tank, pump and controls (or siphon), distribution network, and the filter bed with an underdrain system (figure 4-25). The wastewater is intermittently dosed from the dose tank onto the filter through the distribution network. From there, it percolates through the sand medium to the underdrain and is discharged. On-demand dosing has often been used, but timed dosing is becoming common.

Figure 4-26. Schematics of the two most common types of sand media filters



To create the wastewater retention times necessary for achieving desired treatment results, single-pass filters must use finer media than that typically used in recirculating filters. Finely sized media results in longer residence times and greater contact between the wastewater and the media surfaces and their attached bioslimes. BOD removals of greater than 90 percent and nearly complete ammonia removal are typical (Darby et al., 1996; Emerick et al., 1997;

University of Wisconsin, 1978). Single-pass filters typically achieve greater fecal coliform removals than recirculating filters because of the finer media and the lower hydraulic loading. Daily hydraulic loadings are typically limited to 1 to 2 gpd/ft<sup>2</sup>, depending on sand size, organic loading, and especially the number of doses per day (Darby et al., 1996).

### Recirculating filters

The basic components of recirculating filters (see Fact Sheet 11) are a recirculation/dosing tank, pump and controls, a distribution network, a filter bed with an underdrain system, and a return line fitted with a flow-splitting device to return a portion of the filtrate to the recirculation/dosing tank (figure 4-26). The wastewater is dosed to the filter surface on a timed cycle 1 to 3 times per hour. The returned filtrate mixes with fresh septic tank effluent before being returned to the filter.

### Media types

Many types of media are used in packed bed filters. Washed, graded sand is the most common medium. Other granular media used include gravel, anthracite, crushed glass, expanded shale, and bottom ash from coal-fired power plants. Bottom ash has been studied successfully by Swanson and Dix (1987). Crushed glass has been studied (Darby et al., 1996; and Emerick et al., 1997), and it was found to perform similarly to sand of similar size and uniformity. Expanded shale appears to have been successful in some field trials in Maryland, but the data are currently incomplete in relation to long-term durability of the medium.

Foam chips, peat, and nonwoven coarse-fiber synthetic textile materials have also been used. These are generally restricted to proprietary units. Probably the most studied of these is the peat filter, which has become fairly common in recent years. Depending on the type of peat used, the early performance of these systems will produce an effluent with

a low pH and a yellowish color. This is accompanied by some excellent removal of organics and microbes, but would generally not be acceptable as a surface discharge (because of low pH and visible color). However, as a pretreatment for a SWIS, low pH and color are not a problem. Peat must meet the same hydraulic requirements as sand (see Fact Sheets 10 and 11). The primary advantage of the proprietary materials, the expanded shale, and to some degree the peat is their light weight, which makes them easy to transport and use at any site. Some short-term studies of nonwoven fabric filters have shown promise (Roy and Dube, 1994). System manufacturers should be contacted for application and design using these materials.

### 4.7.2 Applications

Sand media filters may be used for a broad range of applications, including single-family residences, large commercial establishments, and small communities. They are frequently used to pretreat wastewater prior to subsurface infiltration on sites where the soil has insufficient unsaturated depth above ground water or bedrock to achieve adequate treatment. They are also used to meet water quality requirements before direct discharge to a surface water. They are used primarily to treat domestic wastewater, but they have been used successfully in treatment trains to treat wastewaters high in organic materials such as those from restaurants and supermarkets. Single pass filters are most frequently used for smaller applications and sites where nitrogen removal is not required. Recirculating filters are used for both large and small flows

#### Performance of sand and other filters

Twelve innovative treatment technologies were installed to replace failed septic systems in the Narragansett Bay watershed, which is both pathogen- and nitrogen-sensitive. The technologies installed consisted of an at-grade recirculating sand filter, single pass sand filters, Maryland-style recirculating sand filters, foam biofilters, and a recirculating textile filter. The treatment performance of these systems was monitored over an 18-month period. In the field study, TSS and BOD<sub>5</sub> concentrations were typically less than 5 mg/L for all sand filter effluent and less than 20 mg/L for both the foam biofilter and textile filter effluents. Single pass sand filters achieved substantial fecal coliform reductions, reaching mean discharge levels ranging from 200 to 520 colonies per 100 mL for all 31 observations. The at-grade recirculating sand filter achieved the highest total nitrogen reductions of any technology investigated and consistently met the Rhode Island state nitrogen removal standard (a TN reduction of 50 percent or more and a TN concentration of 19 mg/L or less) throughout the study.

Source: Loomis et al., 2001.



and are frequently used where nitrogen removal is necessary. Nitrogen removal of up to 70 to 80 percent can be achieved if an anoxic reactor is used ahead of the recirculation tank, where the nitrified return filtrate can be mixed with the carbon-rich septic tank effluent (Anderson et al., 1998; Boyle et al., 1994; Piluk and Peters, 1994).

### 4.7.3 Performance

The treatment performance of single-pass and recirculating filters is presented in table 4-16. The medium used was sand or gravel as noted. Recirculating sand filters generally match or outperform single-pass filters in removal of BOD, TSS, and nitrogen. Typical effluent concentrations for domestic wastewater treatment are less than 10 mg/L for both BOD and TSS, and nitrogen removal is approximately 50 percent. Single-pass sand filters can also typically produce an effluent of less than 10 mg/L for both BOD and TSS. Effluent is nearly completely nitrified, but some variability can be expected in nitrogen removal capability. Pell and Nyberg (1989) found typical nitrogen removals of 18 to 33 percent with their intermittent sand filter. Fecal coliform removal is somewhat better in single pass filters. Removals range from 2 to 4 logs in both types of filters. Intermittent sand filter fecal coliform removal is a function of hydraulic loading; removals decrease as the loading rate increases above 1 gpm/ft<sup>2</sup> (Emerick et al., 1997).

Effluent suspended solids from sand filters are typically low. The medium retains the solids. Most of the organic solids are ultimately digested. Gravel filters, on the other hand, do not retain solids as well.

excessive solids buildup due to the lack of periodic sludge pumping and removal. In such cases, the solids storage capacity of the final settling compartment might be exceeded, which results in the discharge of solids into the effluent. ATU performance and effluent quality can also be negatively affected by the excessive use of toxic household chemicals. ATUs must be properly operated and maintained to ensure acceptable performance.

## 4.8 Aerobic treatment units

Aerobic treatment units (ATUs) refer to a broad category of pre-engineered wastewater treatment

devices for residential and commercial use. ATUs are designed to oxidize both organic material and ammonium-nitrogen (to nitrate nitrogen), decrease suspended solids concentrations and reduce pathogen concentrations.

A properly designed treatment train that incorporates an ATU and a disinfection process can provide a level of treatment that is equivalent to that level provided by a conventional municipal biological treatment facility. The ATU, however, must be properly designed, installed, operated and maintained.

Although most ATUs are suspended growth devices, some units are designed to include both suspended growth mechanisms combined with fixed-growth elements. A third category of ATU is designed to provide treatment entirely through the use of fixed-growth elements such as trickling filters or rotating biological contactors (refer to sheets 1 through 3). Typical ATU's are designed using the principles developed for municipal-scale wastewater treatment and scaled down for residential or commercial use.

Most ATUs are designed with compressors or aerators to oxygenate and mix the wastewater. Partial pathogen reduction is achieved. Additional disinfection can be achieved through chlorination, UV treatment, ozonation or soil filtration. Increased nutrient removal (denitrification) can be achieved by modifying the treatment process to provide an anaerobic/anoxic step or by adding treatment processes to the treatment train.

### 4.8.1 Treatment mechanisms

ATUs may be designed as continuous or batch flow systems (refer to fact sheets 1 through 3). The simplest continuous flow units are designed with no flow equalization and depend upon aeration tank volume and/or baffles to reduce the impact of hydraulic surges. Some units are designed with flow-dampening devices, including air lift or float-controlled mechanical pumps to transfer the wastewater from the aeration tank to a clarifier. Other units are designed with multiple-chambered tanks to attenuate flow. The batch (fill and draw) flow system design eliminates the problem of hydraulic variation. Batch systems are designed to collect and treat wastewater over a period of time.

Table 4-16. Single pass and recirculating filter performance.

Reference	BOD			TSS			TKN			TN			Fecal Coliforms			Comments <sup>d,e</sup>
	Inf.	Eff.	% Rem.	Inf.	Eff.	% Rem.	Inf.	Eff.	% Rem.	Inf.	Eff.	% Rem.	Inf.	Eff.	% Rem.	
	(mg/L)	(mg/L)	(%)	(mg/L)	(mg/L)	(%)	(mg-N/L)	(mg-N/L)	(%)	(mg-N/L)	(mg-N/L)	(%)	(#/100mL)	(#/100mL)	(%)	
<b>Single Pass Filters</b>																
Cagle & Johnson (1994) <sup>a</sup> California	160	2	98.75	73	16	78.08	61.8	5.9	90.45	61.8	37.4	39.48	1.14E+05	1.11E+02	99.90	Sand media: es=0.25-0.65 mm; uc=3-4. Design hydraulic loadings=1.2 gpd/ft <sup>2</sup> based on 150 gpd/bedroom. Actual flows not measured.
Effert, et al. (1985) <sup>a</sup> Ohio	127	4	96.85	53	17	67.92	--	--	--	41.5	37.5	9.64	2.19E+05	1.60E+03	99.27	Sand media: es=0.4 mm, uc=2.5. Average loadings=0.4 gpd/ft <sup>2</sup> / 0.42 lb BOD/1000ft <sup>2</sup> Doses per day=3.3.
Ronayne, et al. (1982) <sup>a</sup> Oregon	217	3	98.62	146	10	93.15	57.1	1.7	97.02	57.5	30.3	47.30	2.60E+05	4.07E+02	99.84	Sand media: es=0.14-0.30 mm; uc=1.5-4.0. Average loadings=0.33-0.70 gpd/ft <sup>2</sup> BOD/1000ft <sup>2</sup> -day.
Sievers (1998) <sup>a</sup> Missouri	297	3	98.99	44	3	93.18	37	0.5	98.65	37.1	27.5	25.88	4.56E+05	7.30E+01	99.98	Sand media: not reported. Design hydraulic loading=1 gpd/ft <sup>2</sup> . Daily flows not reported.
<b>Recirculating Filters</b>																
Louden, et al. (1985) <sup>a</sup> Michigan	150	6	96.00	42	6	85.71	55	2.3	95.82	55	26	52.73	3.40E+03	1.40E+01	99.59	Sand media: es=0.3 mm, uc=4.0. Average loadings=0.9 gpd/ft <sup>2</sup> (forward flow) / 1.13 lb BOD/1000ft <sup>2</sup> -day. Recirculation ratio=3:1. Dosed 4-6 times per hour. Open surface, sprinkler
Piluk & Peters (1994) <sup>a</sup> Maryland	235	5	97.87	75	8	89.33	--	--	--	57	20	64.91	1.80E+06	9.20E+03	99.49	Sand media: es=1 mm, uc=<2.5. Design hydraulic loading=3.54 gpd/ft <sup>2</sup> (forward flow). Actual flows not measured. Recirculation ratio=3:1. Doses per day=24.
Ronayne, et al. (1982) <sup>a</sup> Oregon	217	3	98.62	146	4	97.26	57.1	1.1	98.07	57.5	31.5	45.22	2.60E+05	8.50E+03	96.73	Sand media: es=1.2 mm, uc=2.0. Maximum hydraulic loading (forward flow)=3.1 gpd/ft <sup>2</sup> Recirculation ratio=3:1-4:1. Doses/day=48.
Roy & Dube (1994) <sup>a</sup> Quebec	101	6	94.06	77	3	96.10	37.7	7.9	79.05	37.7	20.1	46.68	4.80E+05	1.30E+04	97.29	Gravel media: es=4.0, uc=<2/5. Design hydraulic loading (forward flow)=23.4 gpd/ft <sup>2</sup> ratio=5:1. Doses per day=48. Open surface, winter operation.
Ayres Assoc. (1998a) <sup>b</sup> Wisconsin	601	10	98.34	546	9	98.35	65.9	3	95.45	65.9	16	75.72	>2500	6.20E+01	>98	Gravel media: pea gravel (3/8-in. dia.). Design hydraulic loading=15 gpd/ft <sup>2</sup> (forward flow). Recirculation ratio=3:1-5:1. Doses per day=72. Open surface, seasonal operation.
Owen & Bobb (1994) <sup>c</sup> Wisconsin	80	8	90.00	36	6	83.33	--	--	>95	--	--	--	--	--	--	Sand media: es=1.5 mm, uc=4-5. Design hydraulic loading=2.74 gpd/ft <sup>2</sup> (forward flow). Recirculation ratio=1:1 to 4:1. Open surface, winter operation.

<sup>a</sup> Single-family home filters. <sup>b</sup> Restaurant (grease and oil inf/eff = 119/<1 mg/L respectively). <sup>c</sup> Small community treating average 15,000 gpd of septic tank effluent. <sup>d</sup> 1 gpd/ft<sup>2</sup> = 4 cm/day = 0.04m<sup>3</sup>/m<sup>2</sup>×day. <sup>e</sup> 1 lb BOD/1000ft<sup>2</sup>×day = 0.00455 kg/m<sup>2</sup>×day

Pumps are used to discharge the settled effluent at the end of the cycle (usually one day). Fixed film treatment plants typically are operated as continuous flow systems.

Oxygen is transferred by diffused air, sparged turbine, or surface entrainment devices. When diffused air systems are used, blowers or compressors are used to force the air through diffusers near the bottom of the tank. The sparged turbine is typically designed with a diffused air source and an external mixer, e.g., a submerged flat-bladed turbine. The sparged turbine is more complex than the simple diffused air system. A variety of surface entrainment devices aerate and mix the wastewater. Air is entrained and circulated in the mixed liquor through violent agitation from mixing or pumping.

The separation of process-generated solids by clarification or filtration is a critical design factor for successful ATU performance. Most ATUs are designed to rely on the process of simple gravity separation to remove most of the solids. Some systems include effluent filters within the clarifier to further screen and retain solids in the treatment plant. Gas deflection barriers and scum baffles are a part of some designs and are a simple way to keep floating solids away from the weir area. Properly managed upflow clarifiers can improve separation.

#### **4.8.2 Design Considerations**

ATU's are typically rated by hydraulic capacity and organic and solids loadings. ATU daily treatment volumes may range from 400 gpd to a maximum of 1,500 gpd. ATUs typically can be used to treat residential wastewaters with influent concentrations which have 100 mg/L to 300 mg/L total organic compounds and 100 mg/L to 350 mg/L total suspended solids. Design flows are generally set by local sanitary codes for residential and commercial dwellings using methods described in Section 3.3.

ATU's should be equipped with audio and visual alarms to warn of compressor/aerator failure and high water. These alarms alert the owner and/or service provider of service issues that require immediate attention.

ATU's should be constructed of noncorrosive materials, including reinforced plastics and

fiberglass, coated steel, and reinforced concrete. Buried ATU's must be designed to provide easy access to mechanical parts, electrical control systems, and appurtenances requiring maintenance such as weirs, air lift pump lines, etc. ATU's installed above ground should be properly housed to protect against severe climatic conditions. Installation should be in accordance with manufacturers' specifications.

Appurtenances should be constructed of corrosion-free materials including polyethylene plastics. Air diffusers are usually constructed of PVC or ceramic stone. Mechanical components must be either waterproofed and/or protected from the elements. Because blowers, pumps, and other prime movers can be subject to harsh environments and continuous operation, they should be designed for heavy duty use. Proper housing can reduce blower noise.

#### **4.8.3 Applications**

ATUs are typically integrated in a treatment train to provide additional treatment before the effluent is discharged to a SWIS. ATU-treatment trains can also be designed to discharge to land and surface waters; ATU discharge is suitable for drip irrigation if high quality effluent is consistently maintained through proper management. Although some jurisdictions allow reductions in vertical separation distances and/or higher soil infiltration rates when ATUs are used, consideration must be given to the potential impacts of higher hydraulic and pollutant loadings. Increased flow through the soil may allow deeper penetration of pathogens and decreased treatment efficiency of other pollutants (see sections 4.4.2 and 4.4.5).

#### **4.8.4 Performance**

Managed ATU effluent quality is typically characterized as 25 mg/L or less CBOD<sub>5</sub> and 30 mg/L or less TSS. Fecal coliform counts are typically 3-4 log # / 100 ml (Table 3-19) when the ATUs are operated at or below their design flows and the influent is typical domestic sewage. Effluent nutrient levels are dependent on influent concentrations, climate, and operating conditions.

Other wastewater characteristics may influence performance. Cleaning agents, bleach, caustic

agents, floating matter, and other detritus can plug or damage equipment. Temperature will affect process efficiency, i.e., treatment efficiency generally will improve as the temperature increases.

Owners should be required by local sanitary codes or management program requirements to maintain ongoing service agreements for the life of the system. ATU's should be inspected every three months to help ensure proper operation and treatment effectiveness. Many ATU manufacturers offer a two-year warranty with an optional service agreement after the warranty expires. Inspections generally include visual checks of hoses, wires, leads and contacts, testing of alarms, examination of the mixed liquor, cleaning of filters, removal of detritus, and inspection of the effluent. ATU's should be pumped when the mixed-liquor (aerator) solids are above 6,000 mg/L or the final settler is more than 1/3 full of settled solids.

#### 4.8.5 Risk management

ATU's should be designed to protect the treatment capability of the soil dispersal system and also to sound alarms or send signals to the management entity (owners and/or service providers) when inspection or maintenance is needed. All biological systems are sensitive to temperature, power interruptions, influent variability, and shock loadings of toxic chemicals. Successful operation of ATUs depends on adherence to manufacturers' design and installation requirements and good management that employs meaningful measurements of system performance at sufficiently frequent intervals to ascertain changes in system function. Consistent performance depends on a stable power supply, an intact system as designed, and routine maintenance to ensure that components and appurtenances are in good order. ATU's, like all other onsite wastewater treatment technologies, will fail if they are not designed, installed, or operated properly. Vigilance on the part of owners and service providers is essential to ensure ATUs are operated and maintained to function as designed.

#### 4.8.6 Costs

Installed ATU costs range from \$2500 to \$9000 installed. Pumping may be necessary at any time due to process upsets, or every eight to twelve months, depending on influent quality, temperature and type of process. Pumping could cost from \$100-to-\$300, depending on local requirements. Aerators/compressors last about three to five years and cost from \$300 to \$500 to replace.

Many communities require service contracts. These contracts typically range in cost between \$100 and \$400 per year, depending on the options and features the owners choose. The high end includes pumping costs. Power requirements are generally quoted at around \$200/year.

## References

- American Society for Testing and Materials (ASTM). 1993 (pp. 63–65). Standard Specification for Precast Concrete Septic Tanks. C 1227. American Society for Testing and Materials, West Conshohocken, PA.
- American Manufacturing. 2001. Alternative Drainfield. Used with permission. <http://www.americanonsite.com/american/lit9901.html>.
- Amerson, R.S., E.J. Tyler, and J.C. Converse. 1991. Infiltration as Affected by Compaction, Fines and Contact Area of Gravel. In *On-Site Wastewater Treatment: Proceedings of the Sixth National Symposium on Individual and Small Community Sewage Systems*. American Society of Agricultural Engineers, St. Joseph, MI.
- Anderson, D.L., M.B. Tyl, R.J. Otis, T.G. Mayer, K.M. Sherman. 1998. Onsite Wastewater Nutrient Reduction Systems (OWNRS) for Nutrient Sensitive Environments. In *On-Site Wastewater Treatment: Proceedings of the Eighth National Symposium on Individual and Small Community Sewage Systems*, ed. D.M. Sievers. American Society of Agricultural Engineers, St. Joseph, MI.



- Anderson, J.L., R.E. Machmeier, and M.P. Gaffron. 1985. Evaluation and Performance of Nylon Wrapped Corrugated Tubing in Minnesota. In *On-Site Wastewater Treatment: Proceedings of the Fourth National Symposium on Individual and Small Community Sewage Systems*. American Society of Agricultural Engineers, St. Joseph, MI.
- Aqua Test, Inc., and Stuth Co., Inc. 1995. *Crushed Recycled Glass as a Filter Media for the Onsite Treatment of Wastewater*. Washington State Department of Community, Trade and Economic Development, Clean Washington Center, Olympia, WA.
- Ayres Associates. 1993. *Onsite Sewage Disposal System Research in Florida: An Evaluation of Current OSDS Practices in Florida*. Report to the State of Florida Department of Health and Rehabilitative Services Environmental Health Program, Tallahassee, FL.
- Ayres Associates. 1994. *Evaluation of Hydraulic Loading Criteria for the "Perc-Rite"® Subsurface Drip Irrigation Systems*. Report prepared for Waste Water Systems, Inc., Lilburn, GA.
- Ayres Associates. 1996. Contaminant Transport Investigation from an Onsite Wastewater Treatment System (OWTS) in Fine Sand. Phase 3 report to the Soap and Detergent Association, New York, NY.
- Ayres Associates. 1998a. Unpublished data. Madison, WI.
- Ayres Associates. 1998b. *Florida Keys Onsite Wastewater Nutrient Reduction Systems Demonstration Project—Final Report*. Florida Department of Health, Tallahassee, FL.
- Ayres Associates. 1998c. Design memo: Recirculating sand/gravel filter recirculation tank design. Unpublished design memo. Ayres Associates, Madison, WI.
- Ayres Associates. 2000 Unpublished graphic. Madison, WI.
- Baumann, E.R., and H.E. Babbit. 1953. An Investigation of the Performance of Six Small Septic Tanks. University of Illinois Engineering Experiment Station. Bulletin Series No. 409. Vol. 50, No. 47. University of Illinois, Urbana, IL.
- Baumann, E.R., E.E. Jones, W.M. Jakubowski, and M.C. Nottingham. 1978. Septic Tanks. In *Home Sewage Treatment: Proceedings of the Second National Home Treatment Symposium*. American Society of Agricultural Engineers, St. Joseph, MI.
- Berkowitz, S.J. 1985. Pressure Manifold Design for Large Subsurface Ground Absorption Sewage Systems. In *Onsite Wastewater Treatment: Proceedings of the Fourth National Symposium on Individual and Small Community Sewage Systems*. American Society of Agricultural Engineers, St. Joseph, MI.
- Berkowitz, S.J., and J.R. Harman. 1994. Computer Program for Evaluating the Hydraulic Design of Subsurface Wastewater Drip Irrigation System Pipe Networks. In *On-Site Wastewater Treatment: Proceedings of the Seventh International Symposium on Individual and Small Community Sewage Systems*, ed. E. Collins. American Society of Agricultural Engineers, St. Joseph, MI.
- Boller, M., A. Schweger, J. Eugster, and V. Mettier. 1994. Dynamic behavior of intermittent sand filters. *Water Science and Technology* 28(10):98-107.
- Bomblat, C., D.C. Wolf, M.A. Gross, E.M. Rutledge, and E.E. Gbur. 1994. Field Performance of Conventional and Low Pressure Distribution Septic Systems. In *On-Site Wastewater Treatment: Proceedings of the Seventh International Symposium on Individual and Small Community Sewage Systems*, ed. E. Collins. American Society of Agricultural Engineers, St. Joseph, MI.
- Bouma, J. 1975. Unsaturated flow during soil treatment of septic tank effluent. *Journal of Environmental Engineering Division*, American Society of Civil Engineers, 101:967-983
- Bouma, J., J.C. Converse, and F.R. Magdoff. 1974. Dosing and resting to improve soil absorption beds. *Transactions*, American Society of Agricultural Engineers, 17:295-298.
- Bounds, T.R. 1994. Septic Tank Septage Pumping Intervals. In *On-Site Wastewater Treatment:*



- Proceedings of the Seventh International Symposium on Individual and Small Community Sewage Systems*, ed. E. Collins. American Society of Agricultural Engineers, St. Joseph, MI.
- Bowne, W.C. 1982. Characteristics and Treatment of STEP Pressure Sewer Collected Wastewater. Draft report submitted to U.S. Environmental Protection Agency, Cincinnati, OH.
- Boyle, W.C., R.J. Otis, R.A. Apfel, R.W. Whitmyer, J.C. Converse, B. Burkes, M.J. Bruch, Jr., and M. Anders. 1994. Nitrogen Removal from Domestic Wastewater in Unsewered Areas. In *On-Site Wastewater Treatment: Proceedings of the Seventh International Symposium on Individual and Small Community Sewage Systems*. American Society of Agricultural Engineers, St. Joseph, MI.
- Boyer, J.A., and C.A. Rock. 1992. Performance of Septic Tanks. In *Proceedings*, ed. R.W. Seabloom, Seventh Northwest On-Site Wastewater Treatment Short Course and Equipment Exhibition, University of Washington, Seattle.
- Brandes, M. 1977. *Accumulation Rate and Characteristics of Septic Tank Sludge and Septage*. Ontario MOE Report No. W63. Toronto, ON, Canada.
- Brown, D.F., L.A. Jones, and L.S. Wood. 1994. A Pedologic Approach for Siting Wastewater Systems in Delaware. In *Proceedings of the Seventh National Symposium on Individual and Small Community Sewage Systems*, pp. 229-237. American Society of Agricultural Engineers, St. Joseph, MI.
- Brown, K.W., J.F. Slowey, and H.W. Wolf. 1977. Accumulation and Passage of Pollutants in Domestic Septic Tank Disposal Fields. Final report submitted to U.S. Environmental Protection Agency. Project no. R801955-01-2. Texas A&M Research Foundation, College Station, TX.
- Buzzards Bay Project, Massachusetts Alternative Septic System Test Center, Buzzards Bay Project National Estuary Program. <http://www.buzzardsbay.org/eti.htm>
- Cagle, W.A., and L.A. Johnson. 1994. On-site Intermittent Sand Filter Systems, a Regulatory/Scientific Approach to Their Study in Placer County, California. In *On-Site Wastewater Treatment: Proceedings of the Seventh International Symposium on Individual and Small Community Sewage Systems*. American Society of Agricultural Engineers, St. Joseph, MI.
- Camp, G.N., Jr. 1985. Seasonal Variation of Two-Dimensional Flow from a Wastewater Disposal Trench. M.S. thesis, University of Cincinnati, Cincinnati, OH.
- Carlile, B.L., and D.J. Osborne. 1982. Some experience with gravel-less systems in Texas coastal areas. In *On-Site Sewage Treatment: Proceedings of the Third National Symposium on Individual and Small Community Sewage Treatment*. American Society of Agricultural Engineers, St. Joseph, MI.
- Colorado School of Mines. 2001. Letter report summarizing the field evaluations of virus treatment efficiency by wastewater soil absorption systems with aggregate-free and aggregate-laden infiltration surfaces. Lowe, VanCuyk, Dodson, and Siegrist.
- Converse, J.C. 1974. Distribution of domestic waste effluent in soil absorption beds. *Transactions*, American Society of Agricultural Engineers, 17:299-309.
- Converse, James C. 1997, 1999, 2000, 2001. *Aeration Treatment of Onsite Domestic Wastewater Aerobic Units and Packed Bed Filters*, University of Wisconsin-Madison.
- Converse, J.C., and R.J. Otis. 1982. *Field Evaluation of Pressure Distribution Networks*. In *Onsite Wastewater Treatment: Proceedings of the Third National Symposium on Individual and Small Community Sewage Systems*. ASAE Publication 1-82, American Society of Agricultural Engineers, St. Joseph, MI.

- Converse, J.C. and E.J. Tyler. 1998a. Soil Dispersal of Highly Pretreated Effluent – Considerations for Incorporation into Code. In *Proceedings: Seventh Annual Conference and Exhibit*. National Onsite Wastewater Recycling Association, Northbrook, IL.
- Converse, J.C., and E.J. Tyler. 1998b. Soil treatment of aerobically treated domestic wastewater with emphasis on modified mounds. In *On-Site Wastewater Treatment: Proceedings of the Eighth National Symposium on Individual and Small Community Sewage Systems*, ed. D.M. Sievers. American Society of Agricultural Engineers, St. Joseph, MI.
- Converse, J.C., and E.J. Tyler. 2000. *Wisconsin Mound Soil Absorption System: Siting, Design, and Construction Manual*. Small Scale Waste Management Project, University of Wisconsin-Madison, Madison, WI.
- Converse, J.C., E.J. Tyler, and J.O. Peterson. 1990. *Wisconsin At-Grade Soil Absorption System: Siting, Design, and Construction Manual*. Small Scale Waste Management Project, University of Wisconsin-Madison, Madison.
- Council of State Governments. 1998. *Getting In Step: A Guide to Effective Outreach in Your Watershed*. CSG Environmental Policy Group, Lexington, KY. <<http://www.epa.gov/owow/watershed/outreach/documentes/>>.
- Crites, R., and G. Tchobanoglous. 1998. *Small and Decentralized Wastewater Management Systems*. McGraw-Hill, San Francisco, CA.
- Darby, J., G. Tchobanoglous, M.A. Nor, and D. Maciolek. 1996. Shallow intermittent sand filtration performance evaluation. *Small Flows Journal* 2(1):3-15.
- Duncan, C.S., R.B. Reneau, Jr., and C. Hagedorn. 1994. Impact of Effluent Quality and Soil Depth on Renovation of Domestic Wastewater. In *On-Site Wastewater Treatment: Proceedings of the Seventh International Symposium on Individual and Small Community Sewage Systems*, ed. E. Collins. American Society of Agricultural Engineers, St. Joseph, MI.
- Effert, D., and M. Cashell. 1987. A Comparative Study of Three Soil Absorption Trench Designs Installed in an Illinoian Till Soil. In *On-Site Wastewater Treatment: Proceedings of the Fifth National Symposium on Individual and Small Sewage Systems*. American Society of Agricultural Engineers, St. Joseph, MI.
- Effert, D., J. Morand, and M. Cashell. 1985. Field Performance of Three Onsite Effluent Polishing Units. In *On-Site Wastewater Treatment: Proceedings of the Fourth National Symposium on Individual and Small Community Sewage Systems*. American Society of Agricultural Engineers, St. Joseph, MI.
- Emerick, R.W., R.M. Test, G. Tchobanoglous, and J. Darby. 1997. Shallow Intermittent Sand Filtration: Microorganism Removal. *Small Flows Journal* 3(1):12-22.
- Erickson, Jenny, E.J. Tyler. 2001. A Model for Soil Oxygen Delivery to Wastewater Infiltration Surfaces. In *On-Site Wastewater Treatment: Proceedings of the Ninth National Symposium on Individual and Small Community Sewage Systems*. American Society of Agricultural Engineers, St. Joseph, MI.
- Fiege, W.A., E.T. Oppett, and J.F. Kreissl. 1975. *An Alternative Septage Treatment Method: Lime Stabilization/Sand-Bed Dewatering*. EPA-600/2-75-036. U.S. Environmental Protection Agency, Washington, DC.
- Geoflow, Inc. 1999. *Design, Installation & Maintenance Manual—Small Systems*. Geoflow, Inc., Charlotte, NC.
- Gross, M.A., P.R. Owens, N.D. Dennis, A.K. Robinson, E.M. Rutledge. 1998. Sizing Onsite Wastewater Systems Using Soil Characteristics as Compared to the Percolation Test. In *On-Site Sewage Treatment: Proceedings of the Eighth National Symposium on Individual and Small Community Sewage Treatment*. American Society of Agricultural Engineers, St. Joseph, MI.
- Hargett, D.L., E.J. Tyler, and R.L. Siegrist. 1982. Soil Infiltration Capacity as Affected by Septic Tank Effluent Application Strategies. In *On-Site Sewage Treatment: Proceedings of the Third National Symposium on Individual and Small Community Sewage Treatment*. American Society of Agricultural Engineers, St. Joseph, MI.

- Hines, M., and R.E. Favreau. 1974. Recirculating Sand Filters: An Alternative to Traditional Sewage Absorption Systems. In *Home Sewage Disposal: Proceedings of the National Home Sewage Disposal Symposium*. American Society of Agricultural Engineers, St. Joseph, MI.
- Hinson, T.H., M.T. Hoover, and R.O. Evans. 1994. Sand-lined Trench Septic System Performance on Wet, Clayey Soils. In *Proceedings of the Seventh International Symposium on Individual and Small Community Sewage Systems*, pp.245-255. American Society of Agricultural Engineers, St. Joseph, MI.
- Hoover, M.T., A. Amoozegar, and D. Weymann. 1991. Performance assessment of sand filter, low pressure pipe systems in slowly permeable soils of Triassic Basin. In *Proceedings of Sixth National Symposium on Individual and Small Community Sewage Systems*, pp. 324-337. American Society of Agricultural Engineers, St. Joseph, MI.
- Hoover, M.T., T.M. Disy, M.A. Pfeiffer, N. Dudley, R.B. Meyer, and B. Buffington. 1996. *North Carolina Subsurface Operators Training School Manual*. Soil Science Department, College of Agriculture and Life Sciences, North Carolina State University, Raleigh, NC, and North Carolina Department of Environment, Health and Natural Resources, Raleigh, NC.
- International Code Council (ICC). 1995. *International Private Sewage Disposal Code*. International Code Council, Inc.
- Jones, E.E. 1975. Domestic Water Use in Individual Homes and Hydraulic Loading and Discharge from Septic Tanks. In *Home Sewage Disposal: Proceedings of the First National Home Sewage Disposal Symposium*. American Society of Agricultural Engineers, St. Joseph, MI.
- Jones, J.H., and G.S. Taylor. 1965. Septic tank effluent percolation through sands under laboratory conditions. *Soil Science* 99:301-309.
- Keys, J.R., E.J. Tyler, and J.C. Converse. 1998. Predicting Life for Wastewater Absorption Systems. In *On-Site Wastewater Treatment: Proceedings of the Eighth National Symposium on Individual and Small Community Sewage Systems*, ed. D.M. Sievers. American Society of Agricultural Engineers, St. Joseph, MI.
- Kinnicutt, L.P., C.E.A. Winslow, and R.W. Pratt. 1910. *Sewage Disposal*. John Wiley & Sons, New York.
- Kleiss, H.J. and M.T. Hoover. 1986. Soil and Site Criteria for On-site Systems. In *Utilization, Treatment, and Disposal of Waste on Land*. Soil Science society of America, Madison, WI.
- Laak, R. 1976. Influence of domestic wastewater pretreatment on soil clogging. *Journal of Water Pollution Control Federation* 42(Part 1):1495-1500.
- Laak, R. 1986. *Wastewater Engineering Design for Unsewered Areas*. 2nd ed. Technomic Publishing Co., Inc., Lancaster, PA.
- Levine, A.D., G. Tchohanoglous, and T. Asano. 1991. Size distributions of particulate contaminants in wastewater and their impacts on treatability. *Water Research* 25(8):911-922.
- Lombardo, Pio. 2000. Onsite Wastewater Treatment System Graphics. Lombardo Associates, Newton, MA. <<http://www.lombardoassociates.com>>.
- Loomis, G.W., D.B. Dow, M.H. Stolt, A.D. Sykes, A.J. Gold. 2001. Performance Evaluation of Innovative Treatment Technologies Used to Remediate Failed Septic Systems. In *Onsite Wastewater Treatment: Proceedings of the Ninth National Symposium on Individual and Small Community Sewage Systems*. American Society of Agricultural Engineers, St. Joseph, MI.
- Louden, T.L., D.B. Thompson, L. Fay, and L.E. Reese. 1985. Cold climate performance of recirculating sand filters. In *On-Site Wastewater Treatment: Proceedings of the Fourth National Symposium on Individual and Small Community Sewage Systems*. American Society of Agricultural Engineers, St. Joseph, MI.
- Louden, T.L., G.S. Salthouse, and D.L. Mokma. 1998. Wastewater Quality and Trench System Design Effects on Soil Acceptance Rates. Onsite Wastewater Treatment: Proceedings of the Eighth National Symposium on Individual and Small Community Sewage Systems.

- American Society of Agricultural Engineers, St. Joseph, MI.
- Ludwig, H.F. 1950. Septic tanks—Design and performance. *Sewage and Industrial Wastes* 96:122.
- Mancl, K.M. 1998. *Septic Tank Maintenance*. Ohio State University Extension Fact Sheet AEX-740-98. Ohio State University, Food, Agricultural and Biological Engineering, Columbus, OH.
- McGauhey, P., and J.T. Winneberger. 1964. Studies of the failure of septic tank percolation systems. *Journal Water Pollution Control Federation* 36:593-606.
- Mokma, D.L., T.L. Loudon, P. Miller. 2001. Rationale for Shallow Trenches in Soil Treatment Systems. In *On-Site Sewage Treatment: Proceedings of the Ninth National Symposium on Individual and Small Community Sewage Treatment*. American Society of Agricultural Engineers, St. Joseph, MI.
- Mote, C.R. 1984. Pressurized Distribution for On-Site Domestic Wastewater-Renovation Systems. Bulletin 870. Agricultural Experiment Station, University of Arkansas, Fayetteville, AR.
- Mote, C.R., J.W. Pote, E.M. Rutledge, H.D. Scott, and D.T. Mitchell. 1981. A computerized design and simulation model for pressure distribution systems in sloping septic tank filter fields. In *On-Site Sewage Treatment: Proceedings of the Third National Symposium on Individual and Small Community Sewage Treatment*. American Society of Agricultural Engineers, St. Joseph, MI.
- National Small Flows Clearinghouse. Winter, 1996. *Pipeline: Small Community Wastewater Issues Explained to the Public*. Vol. 7 no. 1.
- National Small Flows Clearinghouse. 2000. National Environmental Service Center. West Virginia University. Morgantown, WV.
- Noland, R.F., J.D. Edwards, and M. Kipp. 1978. *Full-Scale Demonstration of Lime Stabilization*. EPA-600/2-78-171. U.S. Environmental Protection Agency, Office of Research and Development, Cincinnati, OH.
- North Carolina Department of Environment, Health, and Natural Resources (DEHNR). 1996. *On-Site Wastewater Management Guidance Manual*. North Carolina Department of Environment, Health, and Natural Resources, Division of Environmental Health, On-Site Wastewater Section, Raleigh, NC.
- NPCA. 1998. *Septic Tank Manufacturing—Best Practices Manual*. National Precast Concrete Association, Indianapolis, IN. <<http://www.precast.org>>
- Otis, R.J. 1978. An Alternative Public Wastewater Facility for a Small Rural Community. Small Scale Waste Management Project. University of Wisconsin-Madison, Madison, WI.
- Otis, R.J. 1982. Pressure distribution design for septic tank systems. *Journal of the Environmental Engineering Division*, American Society of Civil Engineers, 108(EE1): 123-140.
- Otis, R.J. 1985. Soil Clogging: Mechanisms and Control. In *On-Site Wastewater Treatment: Proceedings of the Fourth National Symposium on Individual and Small Community Sewage Systems*. American Society of Agricultural Engineers, St. Joseph, MI.
- Otis, R.J. 1985. Soil Clogging: Mechanisms and Control. In *Onsite Wastewater Treatment: Proceedings of the Fourth National Symposium on Individual and Small Community Sewage Systems*. American Society of Agricultural Engineers, St. Joseph, MI.
- Otis, R.J. 1997. Considering reaeration. In *Proceedings: Ninth Northwest On-Site Wastewater Treatment Short Course and Equipment Exhibition*, ed. R.W. Seabloom. University of Washington, Seattle, WA.
- Otis, R.J. 2001. *Boundary Design: A Strategy for Subsurface Wastewater Infiltration System Design and Rehabilitation*. In *On-Site Wastewater Treatment: Proceedings of the Ninth National Symposium on Individual and Small Community Sewage Systems*. American Society of Agricultural Engineers, St. Joseph, MI.
- Otis, R.J., J.C. Converse, B.L. Carlile, and J.E. Witty. 1977. Effluent Distribution. In *Home*



- Sewage Treatment: Proceedings of the Second National Home Sewage Treatment Symposium*. American Society of Agricultural Engineers, St. Joseph, MI.
- Otis, R.J., J.C. Converse, B.L. Carlile, J.E. Witty. 1978. Effluent Distribution. In *On-Site Wastewater Treatment: Proceedings of the Second National Symposium on Individual and Small Community Sewage Systems*. American Society of Agricultural Engineers, St. Joseph, MI.
- Owen, J.E., and K.L. Bobb. 1994. Winter Operation and Performance of a Recirculating Sand Filter. In: *Proceedings: WEFTEC'94, 67<sup>th</sup> Annual Conference and Exposition*. Water Environment Federation, Alexandria, VA.
- Pell, M., and F. Nyberg. 1989. Infiltration of wastewater in a newly started pit sand filter system. *Journal of Environmental Quality* 18(4):451-467.
- Penninger, P.G., and M.T. Hoover. 1998. Performance of an at-grade septic system preceded by a pressure-dosed sand filter on a wet, clayey slate belt soil. In *On-Site Wastewater Treatment: Proceedings of the Eighth National Symposium on Individual and Small Community Sewage Systems*, ed. D.M. Sievers, pp. 326-335. American Society of Agricultural Engineers, St. Joseph, MI.
- Piluk, R.J. 1998. Maintenance of small recirculating sand filters. In *Proceedings: Seventh Annual Conference and Exhibit*. National Onsite Wastewater Recycling Association, Northbrook, IL.
- Piluk, R.J., and E.C. Peters. 1994. Small recirculating sand filters for individual homes. In *On-Site Wastewater Treatment: Proceedings of the Seventh International Symposium on Individual and Small Community Sewage Systems*. American Society of Agricultural Engineers, St. Joseph, MI.
- Purdue University. 1990a. *Steps in Constructing a Mound (Bed-Type) Septic System*. Cooperative Extension Service, Purdue University, West Lafayette, IN.  
< <http://www.agcom.purdue.edu/AgCom/Pubs/ID/ID-163.html>>.
- Purdue University. 1990b. *Construction Guidelines for Conventional Systems*. Cooperative Extension Service, Purdue University, West Lafayette, IN. <<http://www.agcom.purdue.edu/~agcom/Pubs/ID/ID-170.html>>.
- Robeck, G.C., T.W. Bendixen, W.A. Schwartz, and R.L. Woodward. 1964. Factors influencing the design and operation of soil systems for waste treatment. *Journal Water Pollution Control Federation* 36:971-983. Alexandria, VA.
- Robertson, W.D., and J. Harman. 1999. Phosphate plume persistence at two decommissioned septic system sites. *Ground Water* 37:228-236.
- Robertson, W.D., J.A. Cherry, and E.A. Sudicky. 1989. Ground water contamination at two small septic systems on sand aquifers. *Ground Water* 29:82-92.
- Robertson, W.D., S.L. Schiff, and C.J. Ptacek. 1998. Review of phosphate mobility and persistence in 10 septic system plumes. *Ground Water* 36: 100-110.
- Ronayne, M.P., R.C. Paeth, and S.A. Wilson. 1982. *Oregon On-Site Experimental Systems Program*. Final report to U.S. Environmental Protection Agency. Project No. 5806349. Oregon Department of Environmental Quality, Salem, OR.
- Rose, J.B., D.W. Griffin, and L.W. Nicosia. 1999. Virus Transport From Septic Tanks to Coastal Waters. In *Proceedings of the Tenth Northwest: Onsite Wastewater Treatment Short Course and Equipment Exhibition*. University of Washington, Seattle, WA.
- Roy, C., and J.P. Dube. 1994. A recirculating gravel filter for cold climates. In *On-Site Wastewater Treatment: Proceedings of the Seventh International Symposium on Individual and Small Community Sewage Systems*. American Society of Agricultural Engineers, St. Joseph, MI.
- Schultheis, R.A. 1997. *Septic Tank/Soil Absorption Field Systems: A Homeowner's Guide to Installation and Maintenance*. University of Missouri Cooperative Extension Service, Water Quality Initiative Publication WQ 401. Revised March 15, 1997.



- Shaw, B., and N.B. Turyk. 1994. Nitrate-N loading to ground water from pressurized mound, in-ground and at-grade septic systems. In *On-Site Wastewater Treatment: Proceedings of the Seventh International Symposium on Individual and Small Community Sewage Systems*, ed. E. Collins. American Society of Agricultural Engineers, St. Joseph, MI.
- Siegrist, R.L., and W.C. Boyle. 1987. Wastewater-induced soil clogging development. *Journal of Environmental Engineering*, American Society of Civil Engineering, 113(3):550-566.
- Siegrist, R.L., D.L. Anderson, and J.C. Converse. 1985. Commercial wastewater on-site treatment and disposal. In *On-Site Wastewater Treatment: Proceedings of the Fourth National Symposium on Individual and Small Community Sewage Systems*. American Society of Agricultural Engineers, St. Joseph, MI.
- Siegrist, R.L., D.L. Anderson, and D.L. Hargett. 1986. *Large Soil Absorption Systems for Wastewaters from Multiple-Home Developments*. EPA/600/S2-86/023. U.S. Environmental Protection Agency, Cincinnati, OH.
- Siegrist, R.L., E.J. Tyler, and P.D. Jansen. 2000. Design and Performance of Onsite Wastewater Soil Absorption Systems. In *Risk-Based Decision Making for Onsite Wastewater Treatment: Proceedings of the Research Needs Conference*. National Decentralized Water Resources Capacity Development Project. U.S. Environmental Protection Agency, Cincinnati, OH. (In press).
- Siegrist, R.L., and S. Van Cuyk. 2001a. Wastewater Soil Absorption Systems: *The Performance Effects of Process and Environmental Conditions*. In *On-Site Wastewater Treatment: Proceedings of the Ninth National Symposium on Individual and Small Community Sewage Systems*. American Society of Agricultural Engineers, St. Joseph, MI.
- Siegrist, R.L., and S. Van Cuyk. 2001b. Pathogen Fate in Wastewater Soil Absorption Systems as Affected by Effluent Quality and Soil Clogging Genesis. In *On-Site Wastewater Treatment: Proceedings of the Ninth National Symposium on Individual and Small Community Sewage Systems*. American Society of Agricultural Engineers, St. Joseph, MI.
- Sievers, D.M. 1998. Pressurized Intermittent Sand Filter with Shallow Disposal Field for a Single Residence in Boone County, Missouri. In *On-Site Wastewater Treatment: Proceedings of the Eighth National Symposium on Individual and Small Community Sewage Systems*. American Society of Agricultural Engineers, St. Joseph, MI.
- Simon, J.J., and R.B. Reneau, Jr. 1987. Recommended Septic Tank Effluent Loading Rates for Fine-Textured, Structured Soils with Flow Restrictions. In *On-Site Wastewater Treatment: Proceedings of the Sixth National Symposium on Individual and Small Community Sewage Systems*. American Society of Agricultural Engineers, St. Joseph, MI.
- Solomon, C., P. Casey, C. Mackne, and A. Lake. 1998. Recirculating sand filters. ETI project for U.S. Environmental Protection Agency, Office of Wastewater Management. National Small Flows Clearinghouse.
- Tofflemire, T.J., and M. Chen. 1977. Phosphate removal by sands and soils. *Ground water*, Vol. 15, p. 377.
- Tomson, M., C. Curran, J.M. King, H. Wangg, J. Dauchy, V. Gordy, and B.A. Ward. 1984. *Characterization of Soil Disposal System Leachates*. EPA/600/2-84/101. U.S. Environmental Protection Agency, Washington, DC.
- Tyler, E.J. 2000. Unpublished paper. University of Wisconsin-Madison, Department of Soil Science, Madison, WI.
- Tyler, E.J., W.C. Boyle, J.C. Converse, R.L. Siegrist, D.L. Hargett, and M.R. Schoenemann. 1985. *Design and Management of Subsurface Soil Absorption Systems*, EPA/600/2-85/070. U.S. Environmental Protection Agency, Water Engineering Research Laboratory, Cincinnati, OH.
- Tyler, E.J., and J.C. Converse. 1994. Soil acceptance of onsite wastewater as affected by soil morphology and wastewater quality. In *Proceedings of the 7th National Symposium on Individual and Small Community Sewage Systems*. American Society of Agricultural Engineers, St. Joseph, MI.

- Systems*, pp. 185-194. American Society of Agricultural Engineers, St. Joseph, MI.
- Tyler, E.J., E.M. Drozd, and J.O. Peterson. 1991. Hydraulic Loading Based Upon Wastewater Effluent Quality. In *On-Site Wastewater Treatment: Proceedings of the Sixth National Symposium on Individual and Small Community Sewage Systems*. American Society of Agricultural Engineers, St. Joseph, MI
- University of Wisconsin. 1978. *Management of Small Waste Flows*. EPA-600/2-78-173. U.S. Environmental Protection Agency, Cincinnati, OH.
- U.S. Department of Agriculture (USDA). 1973. *Drainage of Agricultural Land*. U.S. Department of Agriculture, Soil Conservation Service, Water Information Center.
- U.S. Environmental Protection Agency (USEPA). 1980. *Design Manual: Onsite Wastewater Treatment and Disposal Systems*. EPA 625/1-80-012. Office of Water Programs, Office of Research and Development, Washington, DC.
- U.S. Environmental Protection Agency (USEPA). 1991. *Manual: Alternative Wastewater Collection Systems*. Technical Report. EPA 625/1-91/024. Office of Research and Development. Cincinnati, OH.
- U.S. Environmental Protection Agency (USEPA). 1992. *Manual: Treatment/Disposal for Small Communities*. EPA 625/R-92/005. U.S. Environmental Protection Agency, Cincinnati, OH.
- U.S. Environmental Protection Agency (USEPA). 1993. *Domestic Septage Regulatory Guidance*. EPA 832-B-92-005. U.S. Environmental Protection Agency, Office of Water, Washington, DC.
- U.S. Environmental Protection Agency (USEPA). 1994. *Guide to Septage Treatment and Disposal*. EPA 625/R-94/002. U.S. Environmental Protection Agency, Office of Research and Development, Washington, DC.
- U.S. Environmental Protection Agency (USEPA). 1995a. *Process Design Manual: Land Application of Sewage Sludge and Domestic Septage*. U.S. Environmental Protection Agency, Office of Research and Development, Washington, DC. EPA 625/R-95/001.
- U.S. Environmental Protection Agency (USEPA). 1995b. *Process Design Manual: Surface Disposal of Sewage Sludge and Domestic Septage*. EPA/625/K-95/002. September. U.S. Environmental Protection Agency, Office of Research and Development, Washington DC.
- U.S. Environmental Protection Agency (USEPA). 1999. *Environmental Regulation and Technology: Control of Pathogens and Vector Attraction in Sewage Sludge*. EPA /625/R-92/013. U.S. Environmental Protection Agency, Office of Research and Development, Cincinnati, OH. <<http://www.epa.gov/ORD/NRMRL>>.
- U.S. Environmental Protection Agency (USEPA), Office of Water. September, 2000. *Decentralized Systems Technology Fact Sheet: Aerobic Treatment*. EPA/832/00/031.
- U.S. Environmental Protection Agency (USEPA). 2000. Guidelines for Management of Onsite/Decentralized Wastewater Systems (Draft). U.S. Environmental Protection Agency, Office of Wastewater Management. *Federal Register*, October 6, 2000. <<http://www.epa.gov/owm/smallc/guidelines.htm>>.
- U.S. Public Health Service (USPHS). 1967. *Manual of Septic Tank Practice*. U.S. Public Health Service Publication No. 526.
- Water Environment Federation (WEF). 1990. *Natural Systems of Wastewater Treatment*. Manual of Practice FD-16. Water Environment Federation, Alexandria, VA.
- Weibel, S.R., C.P. Straub, and J.R. Thoman. 1949. *Studies in Household Sewage Disposal Systems*. Part I. Federal Security Agency, Public Health Service, Robert A. Taft Engineering Center, Cincinnati, OH.
- Weibel, S.R., T.W. Bendixen, and J.B. Coulter. 1954. *Studies on Household Sewage Disposal Systems*. Part III. Department of Health, Education, and Welfare, Public Health Service, Robert A. Taft Sanitary Engineering Center, Cincinnati, OH.
- Weymann, D.F., A. Amoozegar, and M.T. Hoover. 1998. Performance of an on-site wastewater

disposal system in a slowly permeable soil. In *On-Site Wastewater Treatment: Proceedings of the Eighth National Symposium on Individual and Small Community Sewage Systems*, ed. D.M. Sievers, pp. 134-145. American Society of Agricultural Engineers, St. Joseph, MI.

Yates, M.V., and S.R. Yates. 1988. Modeling microbial fate in the subsurface environment. *Critical Reviews in Environmental Science, CCECAU* 17(4):307-344.





# Onsite Wastewater Treatment Systems Technology Fact Sheet 1

## Continuous-Flow, Suspended-Growth Aerobic Systems (CFSGAS)

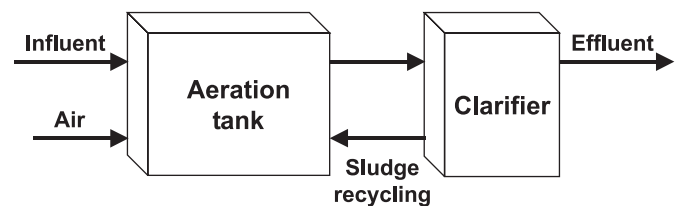
### Description

The activated sludge process is an aerobic suspended-growth process that maintains a relatively high population of microorganisms (biomass) by recycling settled biomass back to the treatment process. The biomass converts soluble and colloidal biodegradable organic matter and some inorganic compounds into cell mass and metabolic end products. The biomass is separated from the wastewater through settling in a clarifier for recycling or wasting to sludge handling processes. Preliminary treatment to remove settleable solids and floatable materials is usually provided by a septic tank or other primary treatment device. Most onsite designs are capable of providing significant ammonia oxidation and effective removal of organic matter.

The basic system consists of a number of interrelated components (as shown in figure 1):

- An aeration tank or basin.
- An oxygen source and equipment to disperse atmospheric or pressurized air or oxygen into the aeration tank at a rate sufficient to always maintain positive dissolved oxygen.
- A means to appropriately mix the aeration basin and ensure suspension of the biomass (usually accomplished by the aeration system).
- A clarifier to separate the biomass from the treated effluent and collect settled biomass for recycling to the aeration basin.

Figure 1. A basic CFSGAS configuration

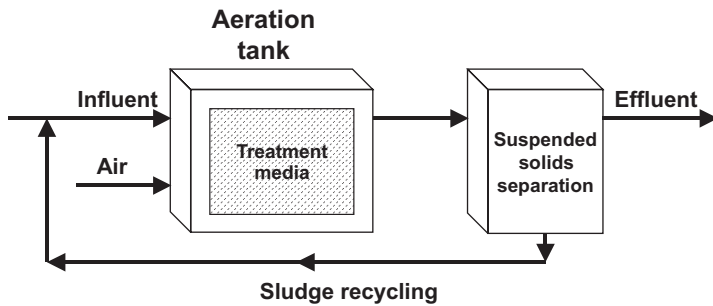


Several modifications of this basic process are commercially available. These include different aeration devices; different means of sludge collection and recycling to the aerator; the use of coarse membrane filters in lieu of, or in addition to, the clarifier; and process enhancement through the addition of an inert media area on which biofilms can grow. The addition of surfaces where biota can become attached and grow increases the capacity of the system (increased organic loading possible). This last modification is the most significant enhancement and is described below.

The combined fixed-film/suspended growth process is sometimes referred to as a class of treatment processes called coupled contact aeration, enhanced, or high biomass systems. To enhance performance and increase the capacity of the aeration tank, an inert support medium is added to the aeration tank. This allows a fixed film of biomass to attach and grow on the medium to augment the suspended microbial population, providing more biomass to feed on wastewater constituents (figure 2). Synthetic trickling filter media, loops of fiber bundles, and a variety of different plastic surface configurations can be suspended in the aeration tank. Advantages include increased active microbial mass per unit volume, enhanced potential for nitrification, reduced suspended solids loading to the clarifier, improved solids separation characteristics, reduced sludge production, and resilience under variable influent conditions.



Figure 2. An enhanced CFSGAS or “high biomass” system



## Typical application

These systems are usually preceded by a septic tank and followed by a subsurface wastewater infiltration system (SWIS). Despite some claims of reduced SWIS sizing when compared to the conventional septic tank pretreatment, the designer is cautioned to consider ground water protection. These systems should be applied only where onsite system management services are available. For surface water discharge, the system must be followed by disinfection at a minimum to consistently meet discharge standards. How-

ever, some subsurface (non-human-contact) reuse may be implemented without further treatment. High biomass systems can be a low-cost means of upgrading existing overloaded CFSGAS units that currently do not meet BOD or nitrification goals. They can also compete directly with conventional designs because they have greater stability in handling highly variable loadings.

## Design assumptions

The extended aeration type of CFSGAS is the most commonly used design. At present there is no generic information on design parameters for fixed film activated sludge systems. Package plants are delivered based on design flow rates. A conservative design approach for extended aeration systems is presented in table 1. The inert medium should support additional biomass and add to the total system microbial mass. Because the increase in microbial population is difficult to measure, any “credits” for this addition would have to be based on empirical observation. Claims for significantly decreased sludge production, increased oxygen transfer efficiency, and improved settleability of the sludge have not been universally proved. However, a number of successful installations for onsite and small municipal systems have been in operation throughout the world for more than 10 years (Mason, 1977; Rogella et al., 1988; Rusten et al., 1987).

Table 1-1. Design parameters for CFSGAS extended aeration package plants

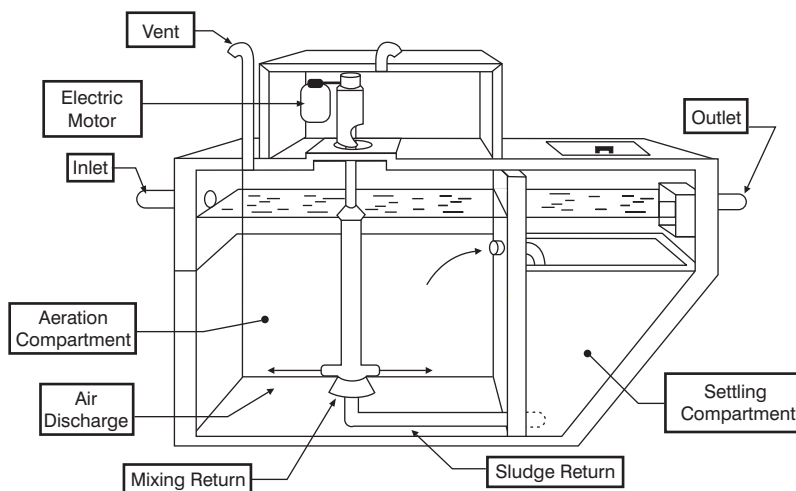
Parameter	Extended Aeration
Pretreatment (if needed)	Septic tank or equivalent
Mixed Liquor Suspended Solids (mg/L) <sup>a</sup>	2,000–6,000
F/M Load (lb BOD/d/MLVSS) <sup>b</sup>	0.05–0.15
Hydraulic Retention Time (h)	24–120
Solids Retention Time (days)	20–40
Mixing Power Input <sup>c</sup>	0.2–3.0 hp/1,000 ft <sup>3</sup>
Clarifier Overflow Rate (gpd/ft <sup>2</sup> )	200–400 avg., 800 peak
Clarifier Solids Loading (lb/d/ft <sup>2</sup> )	30 avg., 50 peak
Dissolved Oxygen (mg/L)	>2.0
Residuals Generated	0.6–0.9 lb TSS/lb BOD removed
Sludge Removal	3–6 months as needed

<sup>a</sup>TSS in aeration tank.

<sup>b</sup>Organic loading (pounds of BOD per day) to aeration tank volatile fraction of MLSS.

<sup>c</sup>Power input per cubic foot of tank volume.

**Figure 3. Components of a typical aerobic treatment unit**



Onsite package treatment units (see figure 3) should be constructed of noncorrosive materials, such as coated concrete, plastic, fiberglass, or coated steel. Units may be stand-alone or manufactured to drop into a compartmented septic tank. Some units are installed aboveground on a concrete slab with proper housing to protect against severe climatic conditions. Units may also be buried underground as long as easy access is provided to all mechanical parts, electrical control systems, and water surfaces. All electrical components should follow NEC code and be waterproof and/or housed from the elements. If airlift pumps are used, large-diameter units should be provided to avoid clogging. Blowers, pumps, and other mechanical devices should be designed for continuous use because they will be abused by climatic conditions and the corrosive atmosphere within the treatment environment. Easy access to all moving parts should be provided for routine maintenance. An effective alarm system should be employed. Typical land area requirements for package plants are modest.

For engineered package plants, final clarifier designs should be conservative for high MLSS and poor settleability of biomass. Because of the potential for bulking sludge, secondary clarifiers should be equipped with surface skimming devices to remove greases and floating solids, as well as efficient screens.

## Performance

Well-operated CFSGAS extended aeration units that are well operated can achieve BOD concentrations ranging from 10 to 50 mg/L and TSS concentrations ranging from 15 to 60 mg/L. Some studies (Brewer et al., 1978; Hutzler et al., 1978) have indicated poorer performance owing to surge flows, variable loading, and inadequate maintenance. Nitrification can also be significant in these aeration units during warmer periods. Some nitrogen removal can be achieved by denitrification, which can remove 30 to 40 percent of the total nitrogen (TN) under optimum conditions. Average total nitrogen effluent concentrations in residential extended aeration units range from 17 to 40 mg/L. Fecal coliform and virus removal has been reported in the range of 1 to 2 logs.

High biomass systems have produced BOD and TSS effluents of 5 to 40 mg/L. Although they are less dependent on temperature than the extended aeration CFSGAS, temperature does have an impact on their seasonal capability to nitrify the influent ammonium-nitrogen to nitrate-nitrogen. All CFSGAS systems do an excellent job of removing toxic organics and heavy metals. Most CFSGAS systems do not remove more than a small percentage of phosphorus (10 to 20 percent) and nitrogen (15 to 25 percent).

## Management requirements

CFSGAS systems must be managed and maintained by trained personnel rather than homeowners to perform acceptably. Power requirements vary from 2.5 to 10 kWh/day. They should be inspected at least every 2 to 3 months. During these inspections, excess solids pumping should be based on the mixed liquor measurements. It is estimated that an effective program will require between 12 and 28 person-hours annually, in addition to analytical testing of the effluent, where required. Management contracts should be in place for the life of the system. Common operational problems with extended aeration systems are provided in table 2. Residuals generated will vary from 0.6 to 0.9 lb TSS per lb BOD removed, over and above the normal septic tank sludge produced.

**Table 1-2. Common operational problems of extended aeration package plants**

Observation	Cause	Remedy
Excessive local turbulence In aeration tank	Diffuser plugging Pipe breakage Excessive aeration	Remove and clean Replace as required Throttle blower
White, thick, billowy foam on aeration tank	Insufficient MLSS	Avoid wasting solids
Thick, scummy, dark tan foam on aeration tank	High MLSS	Waste solids
Dark brown/black foam and mixed liquor in aeration tank	Anaerobic conditions Aerator failure	Check aeration system, aeration tank DO
Billowing sludge washout in clarifier	Hydraulic or solids overload Bulking sludge	Waste sludge; check flow to unit See EPA, 1977
Clumps of rising sludge in clarifier	Denitrification Septic conditions in clarifier	Increase sludge return rate to decrease sludge retention time in clarifier Increase return rate
Fine dispersed floc, turbid effluent	Turbulence in aeration tank Sludge age too high	Reduce power input Waste sludge
Poor TSS and/or BOD removal	Excess flow and strength variations	Install flow smoothing system
Poor nitrification	Low temperatures Excessive biocide use	Insulate, upgrade to high biomass, etc. Reduce biocide loading

## Risk management issues

CFSGAS systems require effluent disinfection at a minimum to meet surface discharge or any surface reuse water quality requirements. They are quite sensitive to temperature, interruption of electric supply, influent variability, or shock loadings of toxic chemicals. The septic tank helps protect these units from the latter problems. Aesthetically, noise from the blowers is the major irritant, while odors can be significant during power outages or organic overloading periods. High biomass units are more resistant to the above impacts. The systems are not well suited to seasonal use because of long start-up times.

## Costs

The installed costs of package plants are highly variable but are usually less than \$10,000. Operation and maintenance (O/M) costs are primarily dependent on local power and labor costs, varying from \$400 to \$600 per year in most cases.

## References

- Ayres Associates. 1998. *Florida Keys Onsite Wastewater Nutrient Reduction Systems Demonstration Project*. Contract no. LP 988. Florida Department of Health Onsite Sewage Program, Tallahassee, FL.
- Brewer, W.S., J. Lucas, and G. Prascak. 1978. An evaluation of the performance of household aerobic sewage treatment units. *Journal of Environmental Health* 41(2):82-84.

- Converse, J.C., and M.M. Converse. 1998. Pump Chamber Effluent Quality Following Aerobic Units and Sand Filters Serving Residences. In *Proceedings of the Eighth National Symposium on Individual and Small Community Sewage Systems*. American Society of Agricultural Engineers, Orlando, FL.
- Englehardt, J.D., and R.C. Ward. 1986. Operation and maintenance requirements for small flow treatment systems. *Journal of the Water Pollution Control Federation* 58(10).
- Hutzler, N.L., L. Waldorf, and J. Fancy. 1978. Performance of Aerobic Treatment Units. In *Proceedings of the Second National Home Sewage Treatment Symposium*. American Society of Agricultural Engineers, Chicago, IL.
- Kellam, J.G., et al. 1993. *Evaluation of Performance of Five Aerated Package Treatment Systems*. Bull. 178. Virginia Water Resources Research Center, Blacksburg, VA.
- Mason, D.G. 1977. A Unique Biological Treatment System for Small Plants. Paper presented at the 50th Water Pollution Control Federation Conference, Philadelphia, PA.
- Midwest Plan Service. 1982. *On-site Domestic Sewage Disposal Handbook*. Midwest Plan Service, University of Minnesota, St. Paul, MN.
- Otis, R.J., and W.C. Boyle. 1976. Performance of single household treatment units. *Journal of Environmental Engineering Division*, ASCE, 102, EE1, 175.
- Otis R.J., et al. 1975. The Performance of Household Wastewater Treatment Units under Field Conditions. In *Proceedings of the Third National Home Sewage Disposal Symposium*. American Society of Agricultural Engineers, Chicago, IL.
- Rogella, F., J. Sibony, G. Boisseau, and M. Benhomme. 1988. Fixed Biomass to Upgrade Activated Sludge. Paper presented at 61st Annual Water Pollution Control Federation Conference, Philadelphia, PA.
- Rusten, B., M.J. Tetreault, and J.F. Kreissl. 1987. Assessment of Phased Isolation Ditch Technologies for Nitrogen Control. In *Proceedings of the Seventh European Sewage and Refuse Symposium*, pp. 279-291, Munich, Germany.
- Tchobanoglous, G., and F. Burton. 1991. *Wastewater Engineering*. 3rd ed. McGraw-Hill, Inc., New York.
- U.S. Environmental Protection Agency (USEPA). 1978. *Management of Small Waste Flows*. Small Scale Waste Management Project. EPA 600/2-78-173. National Technical Information Service PB 286 474.
- U.S. Environmental Protection Agency (USEPA). 1980. *Design Manual: Onsite Wastewater Treatment and Disposal Systems*. EPA 625/1-80-012. U.S. Environmental Protection Agency, Office of Water Programs, Washington, DC.







# Onsite Wastewater Treatment Systems Technology Fact Sheet 2

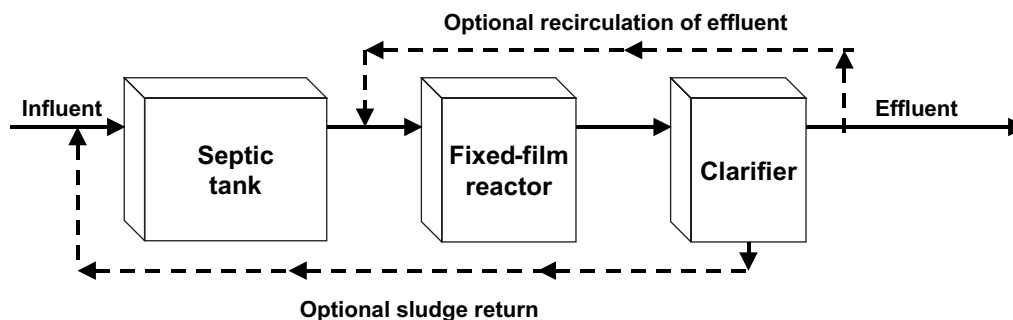
## Fixed-Film Processes

### Description

Fixed-film systems (FFS) are biological treatment processes that employ a medium such as rock, plastic, wood, or other natural or synthetic solid material that will support biomass on its surface and within its porous structure. At least two types of fixed-film systems may be considered —those in which the medium is held in place and is stationary relative to fluid flow (trickling filter) and those in which the medium is in motion relative to the wastewater (e.g., rotating biological disk). A third classification includes dual-process systems that encompass both fixed and suspended biomass together or in series. This approach is covered in Fact Sheet No. 1 on continuous-flow suspended-growth aerobic systems (CFSGAS).

Trickling filter systems are typically constructed as beds of media through which wastewater flows. Oxygen is normally provided by natural or forced ventilation. Flow distributors or sprayers distribute the wastewater evenly onto the surface of the medium. As the wastewater moves by gravity through the medium, soluble and colloidal organic matter is metabolized by the biofilm that forms on the medium. Excess biomass sloughs from the medium and is carried with the treated wastewater to the clarifier, where the solids settle and separate from the treated effluent. At this point the treated wastewater may be discharged or recycled back to the filter medium for further treatment (figure 1).

Figure 1. Trickling filter treatment system



A fixed-film biological treatment process that employs rotating disks that move within the wastewater is referred to as a rotating biological contactor (RBC). Developed in the late 1960s, the RBC employs a plastic medium configured as disks and mounted on a horizontal shaft. The shafts are rotated slowly (1 to 2 rpm) by mechanical or compressed air drive. For a typical aerobic RBC, approximately 40 percent of the medium is immersed in the wastewater. Anoxic or anaerobic RBCs (far less common) are fully immersed in the wastewater. Wastewater flows through the medium by simple displacement and gravity. Biomass continuously sloughs from the disks, and some suspended biomass develops within the wastewater channels through which the disks rotate, making the addition of a secondary clarifier necessary. The rotation of the disks exposes the attached biomass to atmospheric air and wastewater. Oxygen is supplied by natural surface transfer to the biomass. Some oxygenation of the wastewater is also created by turbulence at the disk-water interface. The use of

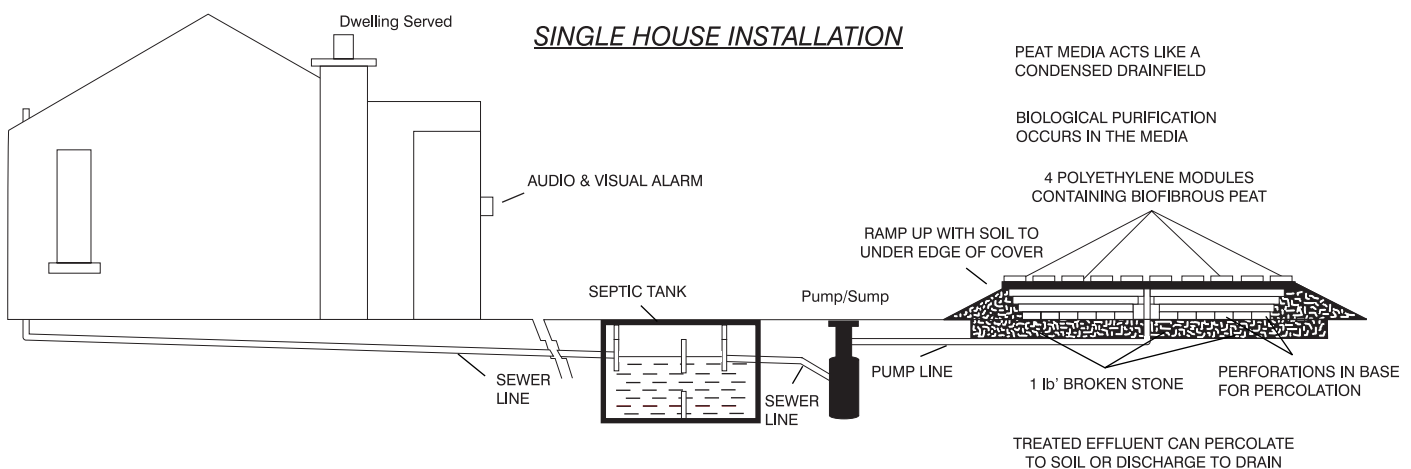
exposed and submerged stages in multiple tanks to create aerobic and anoxic conditions may be employed where nitrogen removal is required.

Commercially available modifications primarily address the media employed, the configuration of the tankage, and the mechanical supporting systems (e.g., supplemental aeration, programmable cycling, etc.). Some FFS sludges are wasted directly by pumping of the clarifier, whereas others convey all excess solids back to the pretreatment stage (septic tank) for subsequent removal. Lightweight synthetic media have greater surface area and are easier to install. Numerous variations ranging from extruded foam to high-specific-surface PVC and other plastic shapes are available commercially.

## Typical applications

Fixed-film systems (FFS) are an alternative to CFSGAS for reducing biochemical oxygen demand (BOD) and total suspended solids (TSS) from septic tank effluent to meet a higher effluent standard (figure 2). Like CFSGAS, they can meet secondary effluent standards (30 mg/L of BOD and TSS), but they would need a minimum of effluent disinfection to be acceptable for surface water discharges. They might meet onsite water reuse requirements as long as the effluent is distributed below the ground surface. Some data support the potential for soil absorption field infiltrative surface reduction following FFS, but caution is urged regarding ground water quality protection from use of such reductions. FFS can also be used as part of a nutrient reduction treatment train (see Facts Sheet No. 8 and No. 9 on nutrient removal). FFS provide an aerobic oxidation step in those sequences.

**Figure 2. Fixed-film system using peat moss as a treatment medium**



Source: Bord Na Mona, 1999.

## Design assumptions

Design guidelines for fixed-film systems are given in table 1. FFS package units should be constructed of noncorrosive materials. Some are installed aboveground on a concrete slab with proper housing to anticipate local climatic conditions. The units may also be buried underground as long as access is provided to all mechanical parts, control systems, underdrains, distribution system, and water surfaces. All electric components must meet NEC code and should be waterproofed and housed from the elements. If natural ventilation is required for aeration, proper design and construction must be considered to ensure adequate oxygen transfer. Pumps, drives (for rotating units), and other mechanical devices should be designed for continuous heavy-duty use and climatic conditions. Access and drainage capability should be provided to underdrains and distribution systems because they may become clogged over time. Alarms that alert homeowners or management entities should be provided to warn of system malfunctions.

**Table 1. Design parameters for fixed-film systems**

Parameter	Trickling filter	RBC
Pretreatment	Septic tank (primary clarifier)	Septic tank (primary clarifier)
Surface hydraulic loading	10–25 gal/d-ft <sup>2</sup>	N/A
Organic loading <sup>a</sup>	5–20 lb BOD/d-ft <sup>2</sup> (3–10 lb BOD/d-ft <sup>2</sup> to nitrify)	2.5 lb SBOD/d-1000 ft <sup>2</sup> (6.4 lb BOD/d-1000 ft <sup>2</sup> )
Clarifier overflow rate Average flow Peak flow	600–800 gal/d-ft <sup>2</sup> 1,000–1,200 gal/d-ft <sup>2</sup>	600–800 gal/d-ft <sup>2</sup> 1,000–1,200 gal/d-ft <sup>2</sup>
Clarifier TSS loading rate Average flow Peak flow	0.8–1.2 lbTSS/d-ft <sup>2</sup> 2.0 lb TSS /d-ft <sup>2</sup>	0.8–1.2 lb TSS /d-ft <sup>2</sup> 2.0 lb TSS /d-ft <sup>2</sup>
Recirculation	Optional	Optional
Sludge generated <sup>b</sup>	0.6–1.1 lb TSS /lb BOD removed	0.6–1.1 lb TSS /lb BOD removed

<sup>a</sup> Loading rates for RBC are expressed per 1,000 ft<sup>2</sup> of total disk surface.

<sup>b</sup> Sludge generated is in addition to solids removed in septic tank.

Onsite RBC package units should also be constructed of noncorrosive materials. Disk shafts and bearings and drives should be designed for heavy-duty use since they will be abused by the corrosive atmosphere generated by treatment processes and climatic conditions. Access should be provided to bearings, drives, and disks for maintenance. RBC units should be covered and insulated against cold weather and sunlight. Proper ventilation of the unit is necessary to ensure adequate oxygen transfer.

## Performance

Typical trickling filters and rotating medium systems currently available should be capable of producing effluent BOD and TSS concentrations of 5 to 40 mg/L. System reliability is somewhat better than suspended growth package plants because of the more effective capture and control of suspended solids. Nitrification is achievable at low loading rates in warm climates. Factors affecting performance include influent wastewater characteristics, hydraulic and organic loading, medium type, maintenance of optimal dissolved oxygen levels, and recirculation rates. The process is characteristically vulnerable to climatic conditions because of the cooling effect of the wastewater as it passes through the medium. Proper insulation, reduced effluent recirculation, and improved distribution techniques can lessen the impact of cold temperatures. Limited denitrification has been noted in nitrifying filters when oxygenation is poor and within dead zones (anaerobic portions) of the filter. Fecal coliform reductions are 1 to 2 logs. Nitrogen removal varies from 0 to 35 percent, while phosphorus removal of 10 to 15 percent might be expected.

Combined fixed-growth/suspended-growth package units are commercially available and are generally valuable in treating high-strength wastewaters. These “high-biomass” units can be organically loaded at much higher rates than either fixed-film or flow-through suspended growth systems. They are covered in the fact sheet on CFSGAS.

## Management needs

With proper management, RBC package plants are reliable and should pose no unacceptable risks to the homeowner or the environment. If not properly managed, however, the process can result in either premature failure of subsurface systems or environmental damage through the production of poor-quality effluent that may pose public health risks. Odors and filter flies may also create an environmental nuisance. Although there are benefits to RBCs, they do not come without

some cost. The mechanical complexity of some proprietary systems causes them to require more management attention. Additional management is needed when disinfection and surface discharge are used.

The manufacturer normally fixes the pumping and recirculation rates for fixed-film systems, and the rates require minimal adjustments once performance objectives are attained. Sludge wasting from the clarifier to the septic tank is normally fixed by timer setting and requires occasional adjustment to avoid biomass buildup. Where mechanical or diffused aeration is employed, complexity and required frequency of inspection increase. The most frequent need is to remove solids from the distribution system. Other maintenance requirements are listed in table 2.

Fixed-film units are also operation and maintenance intensive. Startup of the unit does not require seeding with bacterial cultures and may require 6 to 12 weeks for effective performance depending on the season. This makes them unsuitable for seasonal application. Most operating parameters in package systems cannot be controlled by the operator. The process is less labor-intensive than extended aeration (CFSGAS) systems, but it also requires semiskilled management personnel. Based on limited data on these systems, it is estimated that 4 to 12 person-hours per year plus analytical services should be sufficient. If disinfection is required, see Technology Fact Sheet 4. Power requirements depend on the package system selected but may range from 1 to 8 kW-h/day. Sludge production is 0.6 to 1.0 lb TSS/lb BOD removed over and above normal septic tank sludge (septage) production. Long power outages can be particularly damaging to RBC units, and any FFS will become odiferous under these conditions.

Inspections are recommended three to four times per year, with septage pumping (solid wasting) as needed based on inspection results. Routine maintenance requirements for onsite fixed-film systems are provided in table 2; certain tasks may not be required based on system design. For example, servicing of the final clarifier may be less critical if solids

**Table 2. Suggested maintenance for onsite fixed-film package plants**

System component	Suggested maintenance
Medium tank	Check medium for debris accumulation, ponding, and excessive biomass accumulation; check distribution system and clean as required; check underdrain system and clean as required.
RBC unit	Lubricate motors and bearings; replace seals as required; check integrity of disk/shaft connections; observe biomass accumulations in each stage and adjust shaft speed and direction as needed; maintain air-drive units if provided.
Aeration system	Natural ventilation — Check to ensure adequate ventilation through underdrains and medium. Mechanical/diffused air — See Extended Aeration fact sheet.
Clarifier	See CFSGAS fact sheet.
Controls	Check out functions of all controls and alarms; check electrical control box.
Analytical	Collect effluent samples for analyses of BOD, TSS, pH (N and P if required).
Septic tank/sludge wasting	Check for accumulated solids, and pump as required.

separated in the clarifier are returned to the primary settling chamber (septic tank). Field experience on operation and maintenance for these units has not been as well documented as for CFSGAS.

## Risk management

Fixed-film systems also require a minimum of effluent disinfection to meet surface water discharge requirements. They are more susceptible to extreme cold than CFSGAS but less sensitive to shock loading and influent variability. A prolonged interruption of electric supply will result in odors. Filter flies may also be a nuisance with these systems if vents are not properly screened.

## Costs

Observed costs are highly variable depending on climate, location, onsite aesthetic requirements, and many other factors. The cost of power should be in the range of \$100 per year for RBC units and \$35 per year for trickling filters. Capital (installed) costs of \$9,000 to \$14,000 are typical. A management contract (estimated at about \$100 to \$200 per year) is recommended.

## References

- Hutzler, N.L., L. Waldorf, and J. Fancy. 1978. Performance of Aerobic Treatment Units. In *Proceedings of the Second National Home Sewage Treatment Symposium*. American Society of Agricultural Engineers, Chicago, IL.
- Otis, R.J., and W. C. Boyle. 1976. Performance of single household treatment units. *Journal of Environmental Engineering Division*, American Society of Civil Engineers, 102, EE1, 175.
- Otis, R.J., et al. 1975. The Performance of Household Wastewater Treatment Units under Field Conditions. In *Proceedings of the Third National Home Sewage Disposal Symposium*, American Society of Agricultural Engineers, Chicago, IL, p.191.
- Tchobanoglous, G., and F. Burton. 1991. *Wastewater Engineering*. 3rd ed. McGraw-Hill, Inc., New York.
- Water Environment Federation. 1998. *Design of Municipal Wastewater Treatment Plants*. Manual of Practice no. 8. 4th ed. Water Environment Federation, Alexandria, VA.
- Water Pollution Control Federation (WCPF). 1988. *O & M of Trickling Filters, RBCs, and Related Processes*. Manual of Practice OM-10. Water Pollution Control Federation, Alexandria, VA.
- U.S. Environmental Protection Agency (USEPA). 1984. *Design Information on Rotating Biological Contactors*. EPA-600/2-84-106. U.S. Environmental Protection Agency, Cincinnati, OH.
- U.S. Environmental Protection Agency (USEPA). 1984. *Review of Current RBC Performance and Design Procedures*. EPA-600/2-85-033. U.S. Environmental Protection Agency, Cincinnati, OH.







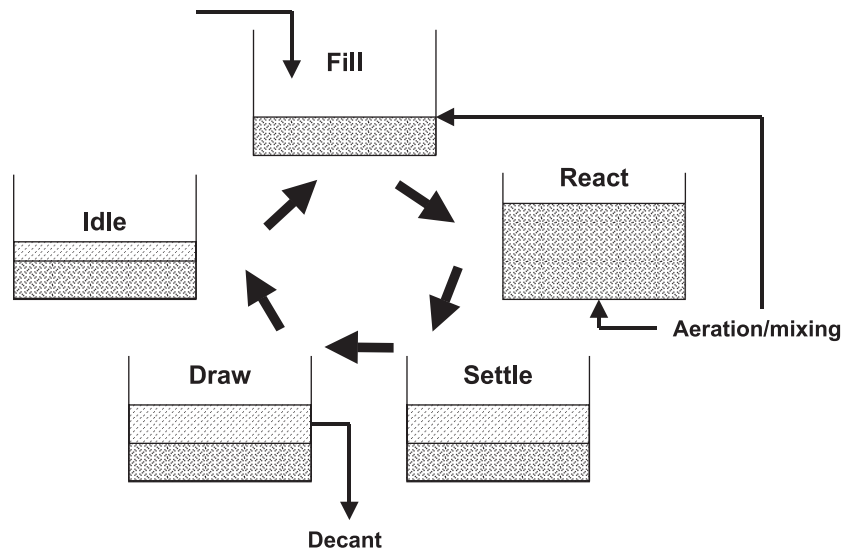
# Onsite Wastewater Treatment Systems Technology Fact Sheet 3

## Sequencing Batch Reactor Systems

### Description

The sequencing batch reactor (SBR) process is a sequential suspended growth (activated sludge) process in which all major steps occur in the same tank in sequential order (figure 1). There are two major classifications of SBRs: the intermittent flow (IF) or “true batch reactor,” which employs all the steps in figure 1, and the continuous flow (CF) system, which does not follow these steps. Both have been used successfully at a variety of U.S. and worldwide installations. SBRs can be designed and operated to enhance removal of nitrogen, phosphorus, and ammonia, in addition to removing TSS and BOD. The intermittent flow SBR accepts influent only at specified intervals and, in general, follows the five-step sequence. There are usually two IF units in parallel. Because this system is closed to influent flow during the treatment cycle, two units may be operated in parallel, with one unit open for intake while the other runs through the remainder of the cycles. In the continuous inflow SBR, influent flows continuously during all phases of the treatment cycle. To reduce short-circuiting, a partition is normally added to the tank to separate the turbulent aeration zone from the quiescent area.

Figure 1. Sequencing batch reactor (SBR) design principle



The SBR system is typically found in packaged configurations for onsite and small community or cluster applications. The major components of the package include the batch tank, aerator, mixer, decanter device, process control system (including timers), pumps, piping, and appurtenances. Aeration may be provided by diffused air or mechanical devices. SBRs are often sized to provide mixing as well and are operated by the process control timers. Mechanical aerators have the added value of potential operation as mixers or aerators. The decanter is a critical element in the process. Several decanter configurations are available, including fixed and floating units. At least one commercial package employs a thermal processing step for the excess sludge produced and wasted during the “idle” step. The key to the SBR process is the control system, which consists of a combination of level sensors, timers, and microprocessors. Programmable logic controllers can be configured to suit the owner’s needs. This provides a precise and versatile means of control.

## Typical applications

SBR package plants have found application as onsite systems in some states and counties where they are allowed by code. They are normally used to achieve a higher degree of treatment than a continuous-flow, suspended-growth aerobic system (CFSGAS) unit by eliminating impacts caused by influent flow fluctuations. For discharge to surface waters, they must meet effluent permit limits on BOD, TSS, and possibly ammonia. Additional disinfection is required to meet effluent fecal coliform requirements. For subsurface discharge, they can be used in situations where infiltrative surface organic loadings must be reduced. There are data showing that a higher quality effluent may reduce soil absorption field area requirements. The process may be used to achieve nitrification as well as nitrogen and phosphorus removal prior to surface and subsurface discharge. (See Fact Sheets 8 and 9.)

## Design assumptions

Typical IF system design information is provided in table 1. With CF-type SBRs, a typical cycle time is 3 to 4 hours, with 50 percent of that cycle devoted to aeration (step 2), 25 percent to settling (step 3), and 25 percent to decant (step 4). With both types, downstream or subsequent unit processes (e.g., disinfection) must be designed for greater capacity (because the effluent flow is several times the influent flow during the decant period) or an equalization tank must be used to permit a consistent flow to those processes.

**Table 1. Design parameters for IF-type SBR treatment systems**

Parameter	SBR systems
Pretreatment	Septic tank or equivalent
Mixed liquor suspended solids (mg/L)	2,000–6,500
F/M load (lb BOD/d/MLVSS)	0.04–0.20
Hydraulic retention time (h)	9–30
Total cycle times (h) <sup>a</sup>	4–12
Solids retention time (days)	20–40
Decanter overflow rate <sup>a</sup> (gpm/ft <sup>2</sup> )	<100
Sludge wasting	As needed to maintain performance

<sup>a</sup> Cycle times should be tuned to effluent quality requirements, wastewater flow, and other site constraints.

Onsite package units should be constructed of noncorrosive materials, such as coated concrete, plastic, fiberglass, or coated steel. Some units are installed aboveground on a concrete slab with proper housing to protect against local climatic concerns. The units can also be buried underground as long as easy access is provided to all mechanical parts, electrical control systems, and water surfaces. All electric components should meet NEC code and should be waterproofed and/or sheltered from the elements. If airlift pumps are used, large-diameter pipes should be provided to avoid clogging. Blowers, pumps, and other mechanical devices should be designed for continuous heavy-duty use. Easy access to all moving

parts must be provided for routine maintenance. An effective alarm system should be installed to alert homeowners or management entities of malfunctions. The area requirements for SBR package plants are similar to those in Fact Sheets 1 and 2.

## Performance

With appropriate design and operation, SBR plants have been reported to produce high quality BOD and TSS effluents. Typical ranges of CBOD<sub>5</sub> (carbonaceous 5-day BOD) are from 5 to 15 mg/L. TSS ranges from 10 to 30 mg/L in well-operated systems. FC removal of 1 to 2 logs can be expected. Normally, nitrification can be attained most of the time unless cold temperatures persist. The SBR systems produce a more reliable effluent quality than CFSGAS or FFS owing to the random nature of the wastewater generated from an individual home. The CF/SBR is also capable of meeting secondary effluent standards (30 mg/L of CBOD and TSS), but more subject to upset by randomly generated wastewaters than the IF/SBR (Ayers Associates, 1998) if short-circuiting cannot be minimized.

## Management needs

Long-term management (including operation and maintenance) of SBRs through homeowner service contracts or local management programs is an important component of the operation and maintenance program. Homeowners do not typically possess the skills needed or the desire to learn to perform proper operation and maintenance. In addition, homeowner neglect, ignorance, or interference (e.g., disabling alarm systems) has contributed to operational malfunctions. No wasting of biomass should be practiced until a satisfactory concentration has developed. Intensive surveillance by qualified personnel is desirable during the first months of startup.

Most operating parameters in SBR package systems can be controlled by the operator. Time clock controls may be used to regulate cycle times for each cycle, adjusted for and depending on observed performance. Alarm systems that warn of aerator system failure and/or pump failure are essential.

Inspections are recommended three to four times per year; septage pumping (solids wasting) is dependent upon inspection results. Routine maintenance requirements for onsite SBRs are given below. Operation and maintenance requires semi-skilled personnel. Based on field experience, 5 to 12 person-hours per year, plus analytical services, are required. The process produces 0.6 to 0.9 lb TSS/lb BOD removed and requires between 3.0 and 10 kWh/day for operation. Operating

**Table 2. Suggested maintenance for sequencing batch reactor package plants**

System component	Suggested maintenance tasks
Reaction tank	Check for foaming and uneven air distribution; check for floating scum; check decanter operation and adjust as required; adjust cycle time sequences as required to achieve effluent target concentrations; check settled sludge volume and adjust waste pumping to maintain target MLVSS levels.
Aeration system-diffused air	Check air filters, seals, oil level, and backpressure; perform manufacturer's required maintenance.
Aeration system-mechanical	Check for vibrations and overheating; check oil level, and seals; perform manufacturer's required maintenance.
Septic tank (primary clarifier)	Check for accumulated solids and order pumping if required.
Controls	Check functions of all controls and alarms; check electrical control box.
Sludge wasting	Pump waste solids as required to maintain target MLVSS range (typically 2,500 to 4,000 mg/L).
Analytical	Measure aeration tank grab sample for MLVSS, pH, and settleability; collect final effluent decant composite sample and analyze for water quality parameters as required (BOD, TSS, pH, N, P, etc.).

personnel prefer these systems to CFSGAS for their simplicity of O/M tasks. The key operational components are the programmer and the decanter, and these must be maintained in proper working order. The primary O/M tasks are provided in table 2.

## Risk management issues

With proper management, a package SBR system is reliable and should pose no unacceptable risks to the homeowner or the environment. If neglected, however, the process can result in environmental damage through production of poor-quality effluent that may pose public health risks and can result in the premature failure of subsurface systems. Odor and noise may also create some level of nuisance. SBRs are less susceptible to flow and quality loading changes than other aerobic biological systems, but they are still not suitable for seasonal applications. They are similarly susceptible to extreme cold and should be buried and/or insulated in areas subjected to these extremes. Local authorities can provide guidance on climatic effects on equipment and how to prevent them. The controller should be located in a heated environment. Long power outages can result in odors and effluent degradation, as is the case with other aerobic biological systems.

## Costs

For residential applications, typical system equipment costs are \$7,000 to \$9,000. Installation costs vary depending on site conditions; installation costs between \$1,500 and \$3,000 are typical for uncomplicated sites with good access. It should be noted that additional system components (e.g., subsurface infiltration system) will result in additional costs. Annual operation and maintenance costs include electricity use (<\$300/year), sludge removal (>\$100/year), and equipment servicing. (Some companies are providing annual service contracts for these units for \$250 to \$400.) Actual costs will vary depending on the location of the unit and local conditions.

## References

- Arora, M.L., et al. 1985. Technology evaluation of sequencing batch reactors. *Journal of the Water Pollution Control Federation* 57:867.
- Ayres Associates. 1998. *Florida Keys Onsite Wastewater Nutrient Reduction Systems Demonstration Project*. HRS Contract No. LP988. Florida Department of Health, Gainesville, FL.
- Buhr, H.O., et al. 1984. Making full use of step feed capability. *Journal of the Water Pollution Control Federation* 56:325.
- Deeny, K.J., and J.A. Heidman. 1991. Implementation of Sequencing Batch Reactor Technology in the United States. Paper presented at the 64th Annual Meeting of the Water Pollution Control Federation, Toronto, Canada.
- Eikum, A.S., and T. Bennett. 1992. New Norwegian Technology for Treatment of Small Flows. In *Proceedings of Seventh Northwest Onsite Wastewater Treatment Short Course*, ed. R.W. Seabloom. University of Washington, Seattle.
- U.S. Environmental Protection Agency (USEPA). 1986. *Summary Report, Sequencing Batch Reactors*. EPA 625/8-86-001. Technology Transfer, Cincinnati, OH.
- U.S. Environmental Protection Agency (USEPA). 1987. *Analysis of a Full-Scale SBR Operation at Grundy Center, Iowa*. EPA 600/J-87-065. U.S. Environmental Protection Agency, Cincinnati, OH.
- U.S. Environmental Protection Agency (USEPA). 1993. *Process Design Manual for Nitrogen Removal*. EPA 625/R-93-010. U.S. Environmental Protection Agency, Cincinnati, OH.
- Water Environment Federation. 1998. *Design of Municipal Wastewater Treatment Plants*. Manual of Practice No. 8. Water Environment Federation, Alexandria, VA.





# Onsite Wastewater Treatment Systems Technology Fact Sheet 4

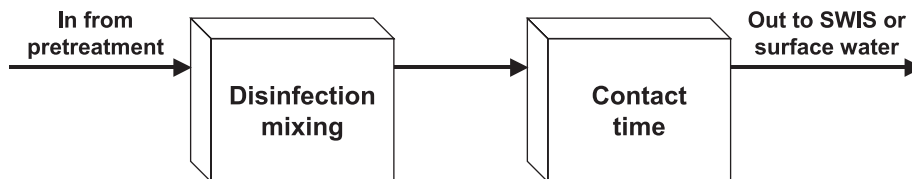
## Effluent Disinfection Processes

### Description

The process of disinfection destroys pathogenic and other microorganisms in wastewater. A number of important water-borne pathogens are found in the United States, including some bacteria species, protozoan cysts, and viruses. All pre-treatment processes used in onsite wastewater management remove some pathogens, but data are scant on the magnitude of this destruction. The two methods described in this section, chlorination and ultraviolet irradiation, are the most commonly used (figure 1). Currently, the effectiveness of disinfection is measured by the use of indicator bacteria, usually fecal coliform. These organisms are excreted by all warm-blooded animals, are present in wastewater in high numbers, tend to survive in the natural environment as long as or longer than many pathogenic bacteria, and are easy to detect and quantify.

A number of methods can be used to disinfect wastewater. These include chemical agents, physical agents, and irradiation. For onsite applications, only a few of these methods have proven to be practical (i.e., simple, safe, reliable, and cost-effective). Although ozone and iodine can be and have been used for disinfection, they are less likely to be employed because of economic and engineering difficulties.

Figure 1. Generic disinfection diagram

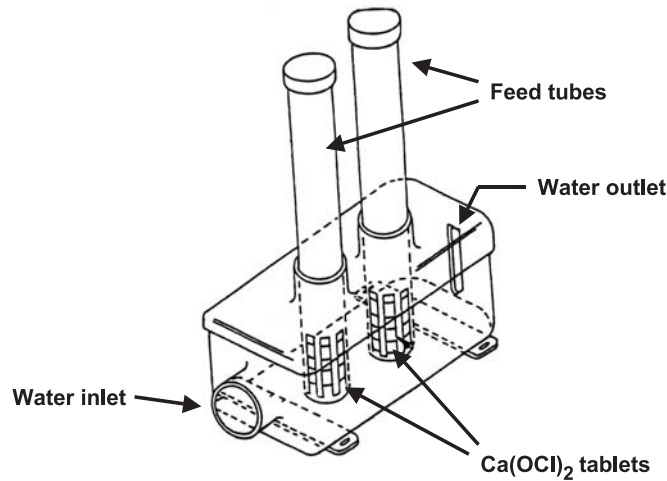


### Chlorine

Chlorine is a powerful oxidizing agent and has been used as an effective disinfectant in water and wastewater treatment for a century. Chlorine may be added to water as a gas ( $\text{Cl}_2$ ) or as a liquid or solid in the form of sodium or calcium hypochlorite, respectively. Because the gas can present a significant safety hazard and is highly corrosive, it is not recommended for onsite applications. Currently, the solid form (calcium hypochlorite) is most favored for onsite applications. When added to water, calcium hypochlorite forms hypochlorous acid ( $\text{HOCl}$ ) and calcium hydroxide (hydrated lime,  $\text{Ca}(\text{OH})_2$ ). The resulting pH increase promotes the formation of the anion,  $\text{OCl}^-$ , which is a free form of chlorine. Because of its reactive nature, free chlorine will react with a number of reduced compounds in wastewater, including sulfide, ferrous iron, organic matter, and ammonia. These nonspecific side reactions result in the formation of combined chlorine (chloramines), chloro-organics, and chloride, the last two of which are not effective as disinfectants. Chloramines are weaker than free chlorine but are more stable. The difference between the chlorine residual in the wastewater after some

time interval (free and combined chlorine) and the initial dose of chlorine is referred to as chlorine demand. The 15-minute chlorine demand of septic tank effluent may range from 30 to 45 mg/L as Cl; for biological treatment effluents, such as systems in Technology Fact Sheets 1, 2, and 3, it may range from 10 to 25 mg/L; and for sand filtered effluent, it may be 1 to 5 mg/L (Technology Fact Sheets 10 and 11).

**Figure 2. Example of a stack-feed chlorinator**



Calcium hypochlorite is typically dosed to wastewater in an onsite treatment system using a simple tablet feeder device (figure 2). Wastewater passes through the feeder and then flows to a contact tank for the appropriate reaction. The product of the contact time and disinfectant residual concentration (Ct) is often used as a parameter for design of the system. The contact basin should be baffled to ensure that short-circuiting does not occur. Chlorine and combined chlorine residuals are highly toxic to living organisms in the receiving water. Because overdosing (ecological risk) and underdosing (human health risk) are quite common with the use of tablets, long swales/ditches are recommended prior to direct discharge to sensitive waters.

Use of simple liquid sodium hypochlorite (bleach) feeders is more reliable but requires more frequent site visits by operators. These systems employ aspirator or suction feeders that can be part of the pressurization of the wastewater, causing both the pump and the feeder to require inspection and calibration. These operational needs should be met by centralized management or contracted professional management.

## Ultraviolet irradiation

The germicidal properties of ultraviolet (UV) irradiation have been recognized for many years. UV is germicidal in the wavelength range of 250 to 270 nm. The radiation penetrates the cell wall of the organism and is absorbed by cellular materials, which either prevents replication or causes the death of the cell. Because the only UV radiation effective in destroying the organism is that which reaches it, the water must be relatively free of turbidity. Because the distance over which UV light is effective is very limited, the most effective disinfection occurs when a thin film of the water to be treated is exposed to the radiation. The quantity of UV irradiation required for a given application is measured as the radiation intensity in microWatt-seconds per square centimeter (mW-s/cm<sup>2</sup>). For each application, wastewater transmittance, organisms present, bulb and sleeve condition, and a variety of other factors will have an impact on the mW-s/cm<sup>2</sup> required to attain a specific effluent microorganism count per 100 mL. The most useful variable that can be readily controlled and monitored is Total Suspended Solids. TSS has a direct impact on UV disinfection, which is related to the level of pretreatment provided.

Many commercial UV disinfection systems (figure 3) are available in the marketplace. Each has its own approach to how the wastewater contacts UV irradiation, such as the type of bulb (medium or low pressure; medium, low, or high intensity), the type of contact chamber configuration (horizontal or vertical), or the sleeve material separating the bulb from the liquid (quartz or teflon). All can be effective, and the choice will usually be driven by economics.

### Typical applications

Disinfection is generally required in three onsite-system circumstances. The first is after any process that is to be surface discharged. The second is before a SWIS where there is inadequate soil (depth to ground water or structure too porous) to meet ground water quality standards. The third is prior to some other immediate reuse (onsite recycling) of effluent that stipulates some specific pathogen requirement (e.g., toilet flushing or vegetation watering).

### Design assumptions

Chlorination units must ensure that sufficient chlorine release occurs (depending on pretreatment) from the tablet chlorinator. These units have a history of erratic dosage, so frequent attention is required. Performance is dependent on pretreatment, which the designer must consider. At the point of chlorine addition, mixing is highly desirable and a contact chamber is necessary to ensure maximum disinfection. Working with chlorinator suppliers, designers should try to ensure consistent dosage capability, maximize mixing usually by chamber or head loss, and provide some type of pipe of sufficient length to attain effective contact time before release. Tablets are usually suspended in open tubes that are housed in a plastic assembly designed to increase flow depth (and tablet exposure) in proportion to effluent flow. Without specific external mixing capability, the contact pipe (large-diameter Schedule 40 PVC) is the primary means of accomplishing disinfection. Contact time in these pipes (often with added baffles) is on the order of 4 to 10 hours, while dosage levels are in excess of those stated in table 1 for different pretreatment qualities and pH values. The commercial chlorination unit is generally located in a concrete vault with access hatch to the surface. The contact pipe usually runs from the vault toward the next step in the process or discharge location. Surface discharges to open swales or ditches will also allow for dechlorination prior to release to a sensitive receiving water.

Figure 3. Wastewater flow in a quartz UV unit

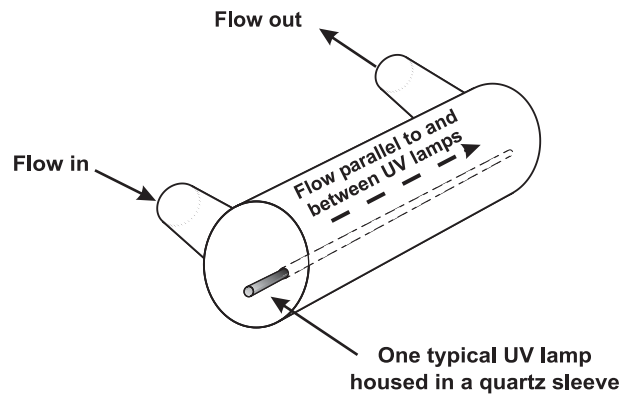


Table 1. Chlorine disinfection dose (in mg/L) design guidelines for onsite applications

Calcium hypochlorite	Septic tank effluent	Biological treatment effluent	Sand filter effluent
pH 6	35–50	15–30	2–10
pH 7	40–55	20–35	10–20
pH 8	50–65	30–45	20–35

Note: Contact time = 1 hour at average flow and temperature 20 °C. Increase contact time to 2 hours at 10 °C and 8 hours at 5 °C for comparable efficiency. Dose = mg/L as Cl. Doses assume typical chlorine demand and are conservative estimates based on fecal coliform data.

The effectiveness of UV disinfection is dependent upon UV power (table 2), contact time, liquid film thickness, wastewater absorbance, wastewater turbidity, system configuration, and temperature. Empirical relationships are used to relate UV power (intensity at the organism boundary) and contact time. Table 2 gives a general indication of the dose requirements for selected pathogens. Since effective disinfection is dependent on wastewater quality as measured by turbidity, it is important that pretreatment provide a high degree of suspended and colloidal solids removal.

**Table 2. Typical ultraviolet (UV) system design parameters**

Design parameter	Typical design value
UV dosage	20–140 mW-s/cm <sup>2</sup>
Contact time	6–40 seconds
UV intensity	3–12 mW-s/cm <sup>2</sup>
Wastewater UV transmittance	50–70%
Wastewater velocity	2–15 inches per second

Commercially available UV units that permit internal contact times of 30 seconds at peak design flows for the onsite system can be located in insulated outdoor structures or in heated spaces of the structure served, both of which must protect the unit from dust, excessive heat, freezing, and vandals. Ideally, the unit should also provide the necessary UV intensity (e.g., 35,000 to 70,000 mW-s/cm<sup>2</sup>) for achieving fecal coliform concentrations of about 200 CFU/100 mL. The actual dosage that reaches the microbes will be reduced by the transmittance of the wastewater (e.g., continuous-flow suspended-growth aerobic systems [CFSGAS] or fixed-film systems [FFS] transmittance of 60 to 65 percent). Practically, septic tank effluents cannot be effectively disinfected by UV, whereas biological treatment effluents can meet a standard of 200 cfu/100 mL with UV. High-quality reuse standards will require more effective pretreatment to be met by UV disinfection. No additional contact time is required. Continuous UV bulb operation is recommended for maximum bulb service life. Frequent on/off sequences in response to flow variability will shorten bulb life. Other typical design parameters are presented in table 2.

## Performance

There are few field studies of tablet chlorinators, but those that exist for post-sand-filter applications show fecal coliform reductions of 2 to 3 logs/100 mL. Another field study of tablet chlorinators following biological treatment units exceeded a standard of 200 FC/100 mL

93 percent of the time. No chlorine residual was present in 68 percent of the samples. Newer units managed by the biological unit manufacturer fared only slightly better. Problems were related to TSS accumulation in the chlorinator, tablet caking, failure of the tablet to drop into the sleeve, and failure to maintain the tablet supply. Sodium hypochlorite liquid feed systems can provide consistent disinfection of sand filter effluents (and biological system effluents) if the systems are managed by a utility.

Data for UV disinfection for onsite systems are also inadequate to perform a proper analysis. However, typical units treating sand filter effluents have provided more than 3 logs of FC removal and more than 4 logs of poliovirus removal. Since this level of pretreatment results in a very low final FC concentration (<100 CFU/100 mL), removals depend more on the influent concentration than inherent removal capability. This is consistent with several large-scale water reuse

studies that show that filtered effluent can reach essentially FC-free levels (<1 CFU/100 mL) with UV dosage of about 100 mW-s/cm<sup>2</sup>, while higher (but attainable) effluent FC levels require less dosage to filtered effluent (about 48 mW-s/cm<sup>2</sup>) than is required by aerobic unit effluent (about 60 mW-s/cm<sup>2</sup>). This can be attributed to TSS, turbidity, and transmittance (table 3). Average quartz tube transmittance is about 75 to 80 percent.

**Table 3. Typical (UV) transmittance values for water**

Wastewater treatment level	Percent transmittance
Primary	45–67
Secondary	60–74
Tertiary	67–82

Source: USEPA, 1986.

## Management needs

Chlorine addition by tablet feeders is likely to be the most practical method for chlorine addition for onsite applications. Tablet feeders are constructed of durable, corrosion-free plastics and are designed for in-line installation. Tablet chlorinators come as a unit similar to figure 2. If liquid bleach chlorinators are used, they would be similarly constructed. That unit is placed inside a vault that exits to the contact basin. The contact basin may be plastic, fiberglass, or a length of concrete pipe placed vertically and outfitted with a concrete base. Baffles should be provided to prevent short-circuiting of the flow. The contact basin should be covered to protect against the elements, but it should be readily accessible for maintenance and inspection.

The disinfection system should be designed to minimize operation and maintenance requirements, yet ensure reliable treatment. For chlorination systems, routine operation and maintenance would include servicing the tablet or solution feeder equipment, adding tablets or premixed solution, adjusting flow rates, cleaning the contact tank, and collecting and analyzing effluent samples for chlorine residuals. Caking of tablet feeders may occur and will require appropriate maintenance. Bleach feeders must be periodically refilled and checked for performance. Semiskilled technical support should be sufficient, and estimates of time are about 6 to 10 hours per year. There are no power requirements for gravity-fed systems. Chemical requirements are estimated to be about 5 to 15 pounds of available chlorine per year for a family of four. During the four or more inspections required per year, the contact basin may need cleaning if no filter is located ahead of the unit. Energy requirements for a gravity-fed system are nil. If positively fed by aspirator/suction with pumping, the disinfection unit and alarms for pump malfunctions will use energy and require inspection. Essentially unskilled (but trained) labor may be employed. Safety issues are minimal and include wearing of proper gloves and clothing during inspection and tablet/feeder work.

Commercially available package UV units are available for onsite applications. Most are self-contained and provide low-pressure mercury arc lamps encased by quartz glass tubes. The unit should be installed downstream of the final treatment process and protected from the elements. UV units must be located near a power source and should be readily accessible for maintenance and inspection. Appropriate controls for the unit must be corrosion-resistant and enclosed in accordance with electrical codes.

Routine operation and maintenance for UV systems involves semiskilled technician support. Tasks include cleaning and replacing the UV lamps and sleeves, checking and maintaining mechanical equipment and controls, and monitoring the UV intensity. Monitoring would require routine indicator organism analysis. Lamp replacement (usually annually) will depend upon the equipment selected, but lamp life may range from 7,500 to 13,000 hours. Based on limited operational experience, it is estimated that 10 to 12 hours per year would be required for routine operation and maintenance. Power requirements may be approximately 1 to 1.5 kWh/d. Quartz sleeves will require alcohol or other mildly acidic solution at each (usually four per year) inspection.

Whenever disinfection is required, careful attention to system operation and maintenance is necessary. Long-term management, through homeowner-service contracts or local management programs, is an important component of the operation and maintenance program. Homeowners do not possess the skills needed to perform proper servicing of these units, and homeowner neglect, ignorance, or interference may contribute to malfunctions.

## Risk management issues

With proper management, the disinfection processes cited above are reliable and should pose little risk to the homeowner. As mentioned above, a potentially toxic chlorine residual may have an important environmental impact if it persists at high concentrations in surface waters. By-products of chlorine reactions with wastewater constituents may also be toxic to aquatic species. If dechlorination is required prior to surface discharge, reactors containing sulfur dioxide, sodium bisulfate, sodium metabisulfate, or activated carbon can be employed. If the disinfection processes described above are improperly managed, the processes may not deliver the level of pathogen destruction that is anticipated and may result in some risk to downstream users of the receiving waters. The systems described are compact and require modest attention. Chlorination does not inherently require energy input; UV irradiation and dosage pumps do consume some energy



(>1kWh/day). Both processes will require skilled technical support for the monitoring of indicator organisms in the process effluents.

Chlorination systems respond to flow variability if the tablets are feeding correctly. UV does not do so and is designed for the highest flow scenario, thus overdosing at lower flows since there is no danger in doing so. Toxic loads are unlikely to affect either system, but TSS can affect both. Inspections must include all pretreatment steps. UV is more sensitive to extreme temperatures than chlorination, and must be housed appropriate to the climate. In extremely cold climates, the UV system can be housed inside the home with minimal danger to the inhabitants. Power outages will terminate UV disinfection and pressurized pumps for both systems, while causing few problems for gravity-fed chlorination units. There should be no odor problems during these outages.

## Costs

Installed costs of a complete tablet chlorination unit are about \$400 to \$500 for the commercial chlorinator unit and associated materials and \$800 to \$1,200 for installation and housing. Operation and maintenance would consist of tablets (\$30 to \$50 per year), labor (\$75 to \$100 per year), and miscellaneous repairs and replacements (\$15 to \$25 per year), in addition to any analytical support required.

Installed costs of UV units and associated facilities are \$1,000 to \$2,000. O/M costs include power (\$35 to \$40 per year), semiskilled labor (\$50 to \$100 per year), and lamp replacement (\$70 to \$80 per year), plus any analytical support.

## References

- Bauer, D.H., E.T. Conrad, and D.G. Sherman. 1981. *Evaluation of Onsite Wastewater Treatment and Disposal Options*. EPA 600/S2-81-178. NTIS No. PB-82-101-635. National Technical Information Service, Cincinnati, OH.
- Crites, R., and G. Tchobanoglous. 1998. *Small and Decentralized Wastewater Management Systems*. WCB/McGraw-Hill, San Francisco, CA.
- Hanzon, B.D., and R. Vigilia. 1999. Just the facts. *Water Environment and Technology* November 1999, 34-42.
- Scheible, O.K. 1987. Development of a rationally based design protocol for the ultraviolet light disinfection process. *Journal of the Water Pollution Control Federation* 59:25.
- University of Wisconsin. 1978. *Management of Small Waste Flows*. EPA 600/2-78-173. Cincinnati, OH.
- U.S. Environmental Protection Agency (USEPA). 1980. *Design Manual: Onsite Wastewater Treatment and Disposal Systems*. EPA 625/1-80-0012. U.S. Environmental Protection Agency, Cincinnati, OH.
- U.S. Environmental Protection Agency (USEPA). 1986. *Municipal Wastewater Disinfection Design Manual*. EPA 625/1-86-021. U.S. Environmental Protection Agency, Cincinnati, OH.
- U.S. Environmental Protection Agency (USEPA). 1992. *Ultraviolet Disinfection Technology Assessment*. EPA-832/R-92-004. U.S. Environmental Protection Agency, Office of Water, Washington, DC.
- Water Environment Federation. 1998. *Design of Municipal Wastewater Treatment Plants*, 3d ed. Alexandria, VA.
- White, G.C. 1992. *The Handbook of Chlorination and Alternative Disinfectants*. 3d ed. Van Nostrand Reinhold, New York.



# Onsite Wastewater Treatment Systems Technology Fact Sheet 5

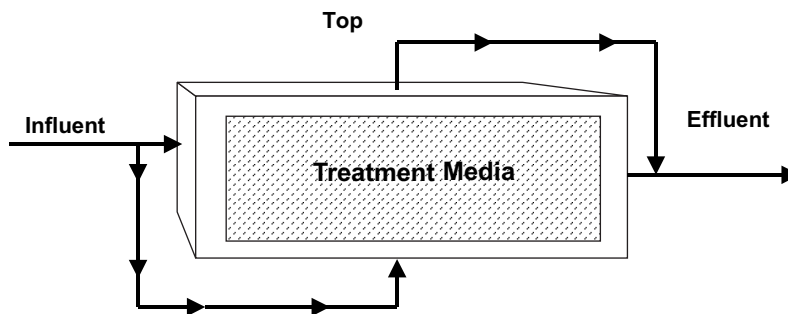
## Vegetated Submerged Beds and Other High-Specific-Surface Anaerobic Reactors

### Description

A high-specific-surface anaerobic reactor (figure 1) is any tank or cavity filled with solid media through which wastewater flows with a high hydraulic retention time (HRT). In onsite treatment the two primary types are vegetated submerged beds (VSBs) and anaerobic upflow filters (AUFs). The first is characterized by horizontal flow and prolific growth of macrophytes on the surface. The second comes in a variety of forms from upflow sludge blanket systems and fixed media anaerobic filters to partially fluidized beds of fine media. Both have long HRTs, produce anaerobic effluents, generally treat either high-strength or minimally pretreated wastewater, and usually require some form of posttreatment to meet surface discharge or water reuse requirements.

The primary removal mechanisms in all of these systems are physical, that is, flocculation, sedimentation, and adsorption. Anaerobic biological reactions are extremely slow and do not have a significant impact on soluble BOD until HRTs become quite long. Some toxic organic compounds may be reduced through these mechanisms and chemical precipitation (e.g., sulfides) at shorter HRTs.

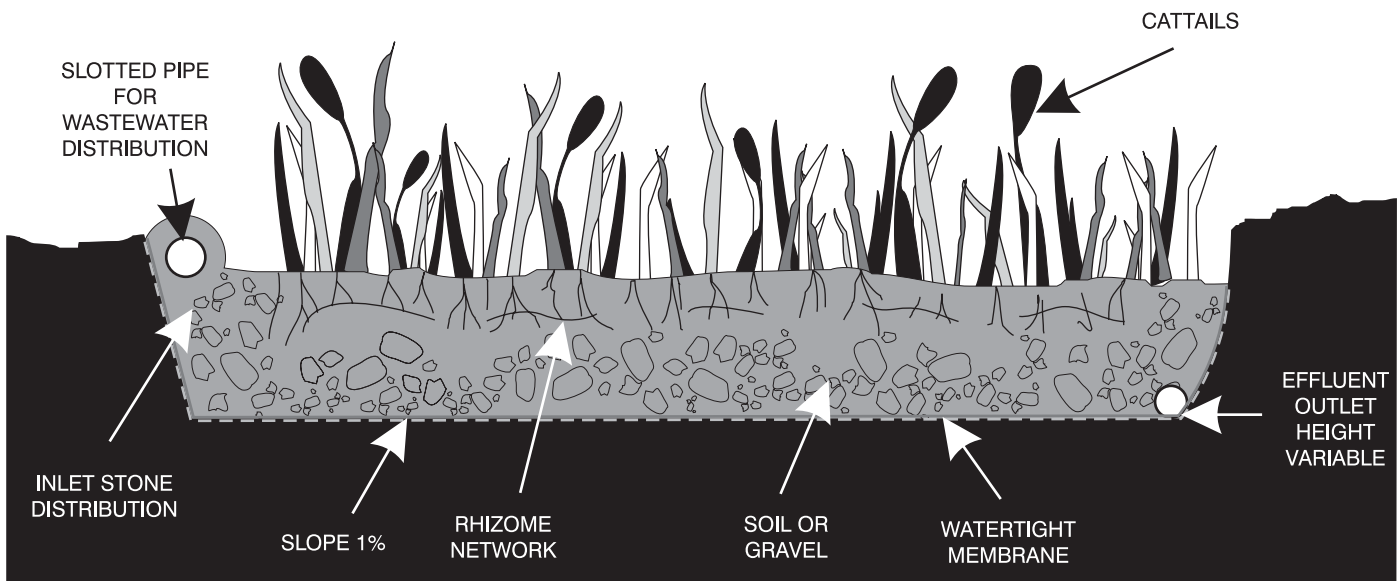
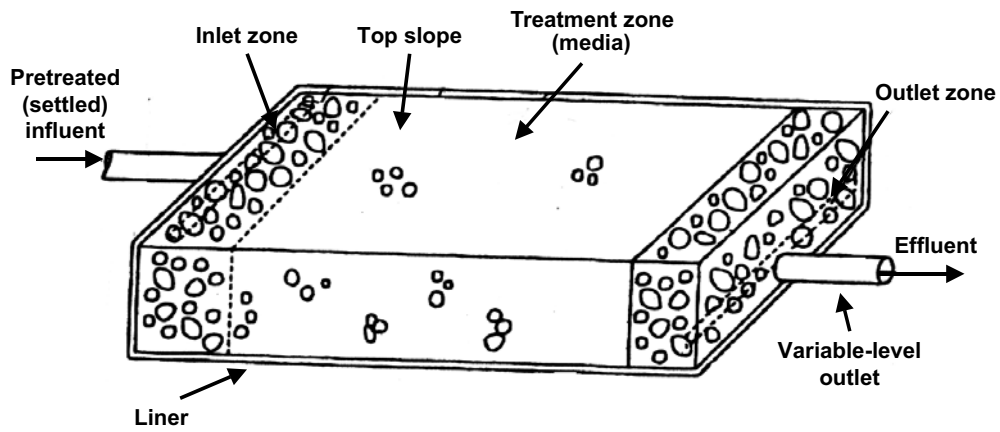
Figure 1. Generic high-specific surface anaerobic reactor



VSBs, as shown in figure 2, usually follow a septic tank and remove most of the suspended and larger colloidal particles, BOD, organic forms of nitrogen, and other particles. Although they are frequently identified as subsurface constructed wetlands, they do not fit the strict definition of a constructed wetland.

Three types of AUFs can be used as pretreatment devices for high-strength wastewater and some onsite pretreatment applications in the United States. They are shown in figures 3, 4, and 5. Figure 3, with a rock medium, is the most typical U.S. application.

Figure 2. Elements of a vegetated submerged bed (VSB) system



Source: Toms Creek Project, VA.

Figure 3. Schematic of the upflow anaerobic filter process

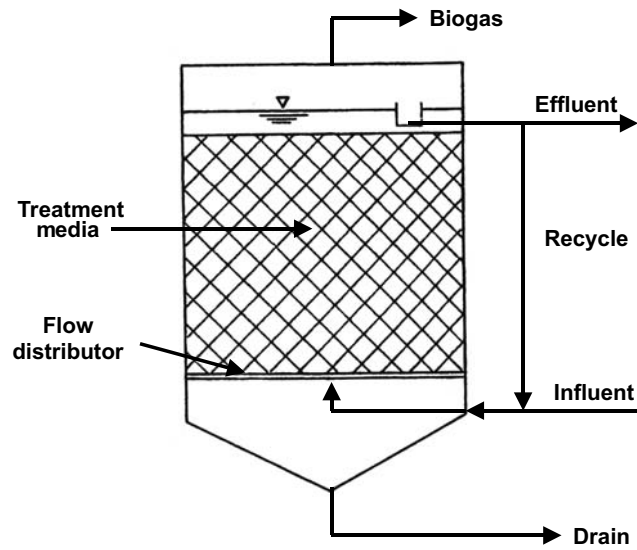


Figure 4. Schematic of the upflow anaerobic sludge blanket process

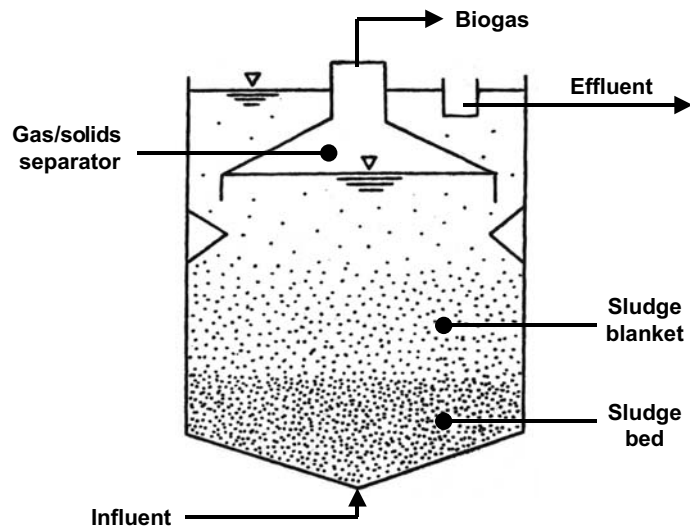
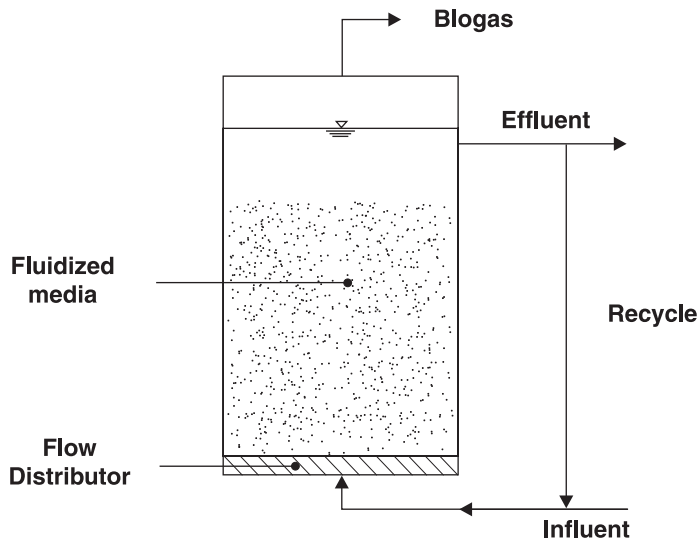


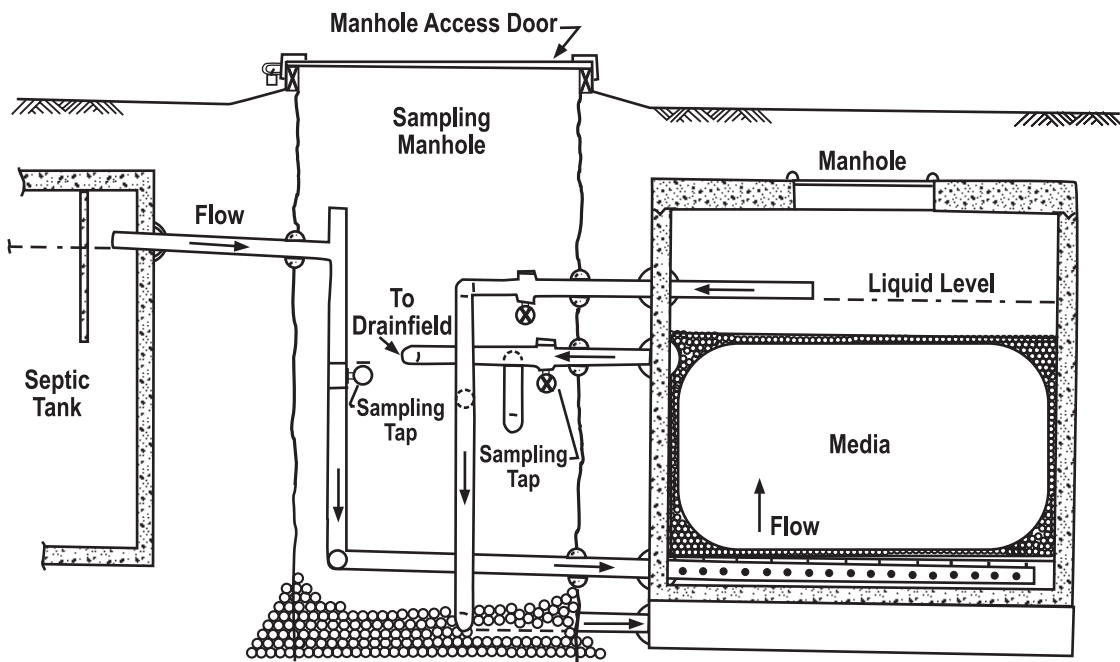
Figure 5. Schematic of the anaerobic fluidized bed process



### Typical applications

AUFs are widely used in hot climates where domestic wastewaters are several times higher in strength than U.S. wastewaters. These systems can reduce high BOD and TSS to levels that can be readily treated by typical aerobic processes such as suspended and fixed growth aerobic units or recirculating/intermittent media filters. International literature contains numerous references to the three types of AUFs and their valuable contributions to water pollution abatement. Anaerobic rock upflow filters (figure 6) are also used to lower septic tank effluent BOD and TSS concentrations prior to discharge to the subsurface wastewater infiltration system (SWIS).

Figure 6. Anaerobic upflow filter





VSBs are extremely popular in the United States because of their aesthetic features and their ability to meet basic (secondary) effluent standards when treating septic tank effluent. Until recently they were purported to be capable of nitrification and nutrient removal at economically competitive HRTs. Since they are largely anaerobic, this would be biochemically impossible. However, they are fully capable of meeting secondary BOD and TSS standards. They are also sometimes used before a SWIS and can meet the same effluent TSS and BOD standards as aerobic units (Technology Fact Sheets 1, 2, and 3). VSBs can be considered as pretreatment units regarding SWIS design requirements. They do not, however, remove more than 2 logs of fecal coliform and would likely require disinfection for direct surface discharge. They also require some form of aeration to meet effluent standards for dissolved oxygen (DO). These VSBs will capture rainfall and snowmelt, effluent standards for requiring adjustment to designs of SWIS following these units.

Both VSBs and AUFs are being used in rural areas in combination with aerobic processes to remove significant amounts of nitrogen through denitrification. These processes are included in the nutrient removal fact sheets.

## Design assumptions

VSB design guidance for small communities is provided in table 1. In the first few months of operation, excellent phosphorus removal will occur until the rock medium becomes saturated with phosphorus and breakthrough occurs. (Note: USEPA guidance on design of VSBs can be found in *Manual: Constructed Wetlands Treatment of Municipal Wastewater*, posted at <http://www.epa.gov/ordntrnt/ord/nrmrl/pubs/2001/wetlands/625r99010.pdf>)

Except for the anaerobic upflow rock filter, AUFs are rarely employed for U.S. onsite applications. Since the primary purpose of these systems is to improve the BOD and TSS of septic tank effluent, they are essentially physical processes. Therefore, they must be designed to maximize their flocculation and sedimentation functions. Limited field studies

**Table 1. Summary of VSB design guidance**

Pretreatment <sup>a</sup>	Objective
Surface area BOD TSS TKN TP	Based on desired effluent quality and areal loading rates as follows: 6 g/m <sup>2</sup> -d (53.5 lb/ac-d) to attain 30 mg/L effluent 1.6 g/m <sup>2</sup> -d (14.3 lb/ac-d) to attain 20 mg/L effluent 20 g/m <sup>2</sup> -d (178 lb/ac-d) to attain 30 mg/L effluent Use another treatment process in conjunction with VSB VSBs not recommended for phosphorus removal
Depth Media (typical) Water (typical)	0.5–0.6 m (20–24 in) 0.4–0.5 m (16–20 in)
Length	Minimum of 15 m (49 ft.)
Width	As calculated
Bottom slope	0–1%
Top slope	Level or nearly level
Hydraulic conductivity First 30% of length Last 70% of length	1% of clean K 10% of clean K
Media  Inlet zone (1 <sup>st</sup> 2 m [6.5 ft]) Treatment zone Outlet zone (last 1 m [3.3 ft]) Planting media (top 10 cm [4 in])	All media should be washed clean of fines and debris; more uniform rounded media will generally have more void spaces; media should be resistant to crushing or breakage. 40–80 mm (1.5–3.0 in) 20–30 mm (3/4–1 in) use clean K = 100,000, if actual K not known 40–80 mm (1.5–3.0 in) 5–20 mm (1/4–3/4 in)
Miscellaneous	Use adjustable outlet control device with capability to flood and drain system and sizing of VSB and SWIS (if used) must include a water balance analysis

<sup>a</sup> Use after primary sedimentation (e.g., septic tank, Imhoff tank, primary clarifier); not recommended for use after ponds because of problems with algae.

indicate that successful removal of particulate BOD and TSS could be obtained with an average HRT between 16 and 24 hours, rounded media size of 1 to 2 inches or greater, and a means of periodically draining excess accumulated solids from the bottom of the unit. At higher temperatures, some partial digestion of accumulated organic solids occurs. This liquefaction may be accompanied by gas production. The amount and makeup of that gas depend on pH, wastewater constituents (e.g., protein, lipids, carbohydrates), sulfate, alkalinity, and other constituents.

## Performance

VSB systems can treat septic tank effluent to a BOD of 20 to 30 mg/L, depending on the organic loading rate chosen. The VSB effluent TSS is almost always less than 30 mg/L. Some removal of all constituents (e.g., heavy metals, organic nitrogen and organic phosphorus, pesticides, and other toxic organics) can also be expected. Over and above these removals, there will be some small percentage of dissolved organic removal owing to anaerobic biological activity.

Rock AUFs after septic tanks have not been widely studied, but they appear to remove TSS by as much as 55 percent from septic tank effluent, while removing a similar percent of the BOD. Actual removals will depend on the specific fractions of particulate, colloidal, and soluble matter in the septic tank effluent. Little soluble or fine particulate removal is likely. Both systems will remove pathogens, with VSBs capable of removing from 1 to 3 logs (design average = 2 logs), while AUF removal is estimated to be closer to 1 log because of shorter HRTs.

## Management needs

All of these anaerobic systems are passive in nature and require minimal O/M activity. AUF units may be constructed aboveground, but they usually are below the ground surface to provide insulation and protect against severe climatic conditions. The solid medium can be a coarse gravel or one of many commercially available synthetic media that will not easily clog with biomass. Access to inlet and outlet systems should be provided for purposes of cleaning and servicing. An easily accessible means to drain the unit and an effective alarm system should be provided.

VSB units are generally aesthetically pleasing additions to the landscape if sufficient area is available for their application. It is estimated that fewer than 4 hours per year will be required for O/M tasks, which will involve inspecting the system and making any adjustments required. Therefore, until more information becomes available, a site visit schedule of three to four times a year is suggested.

Residuals generate in VSB systems at a slow rate. Although the system inlet where most solids accumulate can be excavated or piped for high-pressure removal, it is more likely that a replacement system would be built after the service life of the original system ends.

AUF units will require periodic flushing of accumulated solids and inspection of inlet and outlet systems. If solids are allowed to accumulate, the filter may clog or release high solids “events” to the SWIS. This will clog the infiltrative surface or the distribution system. Therefore, a site visit schedule of three to four times per year is suggested until more information becomes available. This would entail from 6 to 8 hours per year of labor. Disposal and transport of excess solids will require similar management to septage.

## Risk management issues

VSB systems can usually handle the flow variations likely to occur from residential sources, as well as toxic shock loads and power outages. Reed and colleagues (1995) proposed some models to support the view that insulation provided by dead vegetation (litter) on the surface should aid these systems during typical winters in northern climates. The potential for odor is low for properly sized systems.

AUF systems should also accommodate typical flow variations, toxic shocks, and power outages. They should be insulated from cold weather. AUFs are inherently odor and corrosion generators, so corrosion-resistant materials should be employed. Odor (hydrogen sulfide) production may require the use of an odor-control system (e.g., soil filters) to deodorize off-gases.

## Costs

VSB systems for onsite application will cost about \$20 per square foot (USEPA, 1999). Almost half of that cost is for the media, while excavation, liner, plants, control structures, and piping make up the rest. Operation and maintenance costs would run less than \$100 per year if these services are professionally provided.

AUF systems are likely to cost about \$1,000 to \$1,500 per house, primarily related to the cost of the tank and related containment features. O/M costs would run around \$200 per year, including solids transport as required.

## References

- Bauer, D.H., E.T. Conrad, and D.G. Sherman. 1979. *Evaluation of Onsite Wastewater Treatment and Disposal Options*. EPA 600/s2-81-178. U.S. Environmental Protection Agency, Cincinnati, OH.
- Cowlter, J.B., S. Soneda, and M.B. Ettinger. 1957. Anaerobic contact process for sewage disposal. *Sewage and Industrial Wastes Journal* 29(4):468-477.
- Crites, R., and G. Tchobanoglous. 1998. *Small and Decentralized Wastewater Management Systems*. WCB McGraw-Hill, San Francisco, CA.
- DeRenzo, D.J. 1977. *Energy from Bioconversion of Waste Materials*. Noyes Data Corporation, Park Ridge, NJ.
- Hamilton, J. 1975. Treatment of Septic Tank Effluent with an Anaerobic Filter. Master's of Science in Civil Engineering thesis, University of Washington, Seattle.
- Hamilton, J. 1976. *Proceedings of Northwest Onsite Wastewater Disposal Short Course*. University of Washington, Seattle.
- Jewell, W.J. 1987. Anaerobic sewage treatment. *Journal of Environmental Science and Technology* 21(1):14- 21.
- Kennedy, J.C. 1979. Performance of Anaerobic Filters and Septic Tanks Applied to the Treatment of Residential Wastewater. Master's thesis, University of Washington, Seattle.
- Lombardo & Associates, Inc. 1983. *Design Report. Anaerobic Upflow Filters*. Newton, MA.
- Netter, R., E. Stubner, P.A. Wildner, and I. Sekoulov. 1993. Treatment of septic tank effluent in a subsurface biofilter. *Water Science Technology* 28(10):117-124.
- Reed, S.C., R.W. Crites, and E.J. Middlebrooks. 1995. *Natural Systems for Waste Management and Treatment*. McGraw Hill, Inc, New York.
- Switzenbaum, M.S. 1985. *Proceedings of Seminar/Workshop-anaerobic Treatment of Sewage*. Report No. Env.E. 88-85-5. University of Massachusetts, Amherst, MA.
- Thaulow, H. 1974. Use of Anaerobic Filters for Onsite Treatment of Household Wastewater. Master's thesis, University of Washington, Seattle.
- U.S. Environmental Protection Agency (USEPA). 1992. *Wastewater Treatment/Disposal for Small Communities*. EPA 625/R-92-005. U.S. Environmental Protection Agency, Cincinnati, OH.
- U.S. Environmental Protection Agency (USEPA). 1993a. *Nitrogen Control Manual*. EPA 625/R-93/0010. U.S. Environmental Protection Agency, Office of Research and Development, Washington, DC.
- U.S. Environmental Protection Agency (USEPA). 1993b. *Subsurface Flow Constructed Wetlands for Wastewater Treatment: A Technology Assessment*. EPA 832-R-93-008. U.S. Environmental Protection Agency, Office of Water, Washington, DC.
- U.S. Environmental Protection Agency (USEPA). 1999. *Manual: Constructed Wetlands Treatment of Municipal Wastewater*. EPA 625/R-99/010. U.S. Environmental Protection Agency, Cincinnati, OH.





---

# Onsite Wastewater Treatment Systems Technology Fact Sheet 6

## Evapotranspiration and Evapotranspiration/Infiltration

### Description

Onsite evapotranspiration wastewater treatment systems are designed to disperse effluent exclusively by evapotranspiration. Evapotranspiration (ET) is defined as the combined effect of water removal from a medium by direct evaporation and by plant transpiration. The evapotranspiration/infiltration (ETI) process is a subsurface system designed to dispose of effluent by both evapotranspiration and infiltration into the soil. Both of these systems are preceded by primary pretreatment units (e.g., septic tank) to remove settleable and floatable solids. The influent to the ET or ETI units enters through a series of distribution pipes to a porous bed. In ET systems, a liner is placed below the bed to prevent water loss via infiltration unless the soil is impermeable. The surface of the sand bed is planted with water-tolerant plants. Effluent is drawn up through fine media by capillary wicking and evaporated or transpired into the atmosphere. In ETI systems, effluent is allowed to percolate into the underlying soil.

Modifications to ET and ETI systems include mechanical evaporating devices and a broad array of different designs and means of distribution, storage of excess influent, wicking, and containment or infiltration prevention. Some newer studies are using drip irrigation with distribution to forested areas with purported success.

### Typical applications

ET and ETI systems are best suited for arid (evaporation exceeds precipitation) climates. If ETI is selected, soil percolation is also an important consideration. Both systems are often selected when site characteristics dictate that conventional methods of effluent disposal are not appropriate (e.g., unprotected sole source aquifer, high water table or bedrock, tight soils, etc.).

Although these systems normally follow septic tanks, additional pretreatment may be employed to minimize clogging of the ET/ETI system piping and media. They are sometimes used as alternative systems during periods when normal disposal methods are inoperable, for example, spray or other surface irrigation. Also, these systems have been widely used for seasonal homes in areas where year-round application of ET/ETI is not practical and conventional methods are not feasible. Year-round ET systems (see figure 1) require large surface areas and are most feasible in the areas shown on figure 2. ETI systems can be employed to reduce the infiltrative burden on the site during the growing season. Such applications can also result in some reduction in nutrients, which are transferred to the overlying vegetation (USEPA, 1999).



Figure 1. Cross section of a generic evapotranspiration bed (adapted from NSFC)

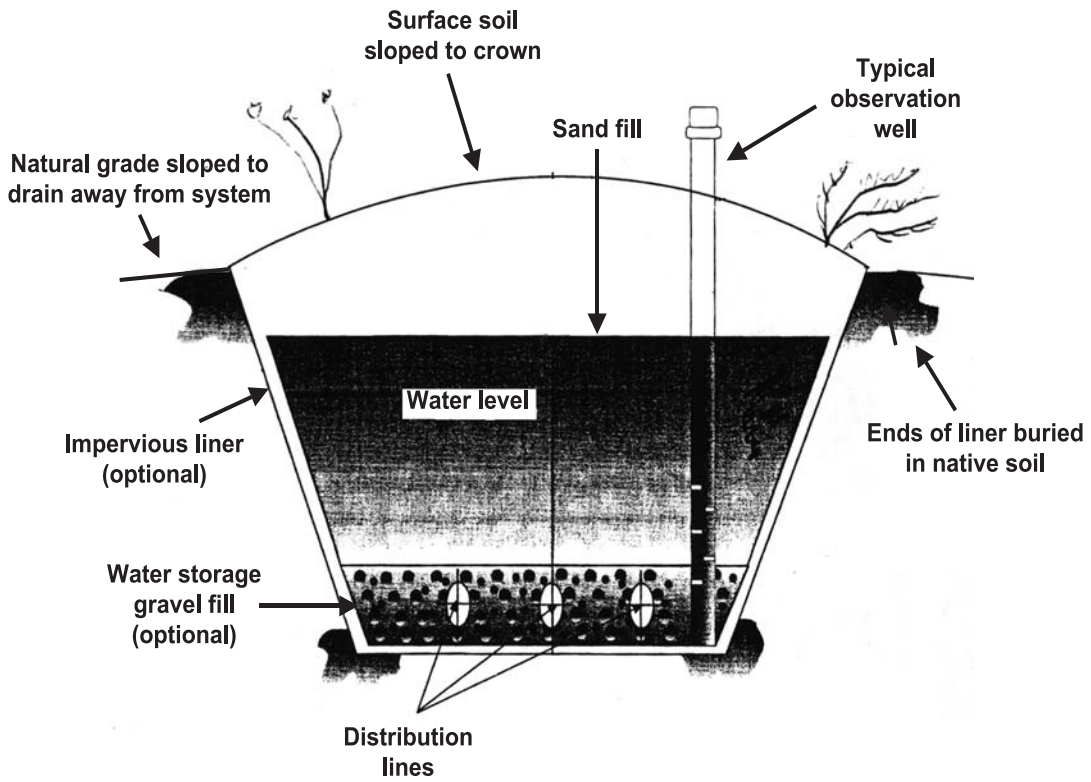
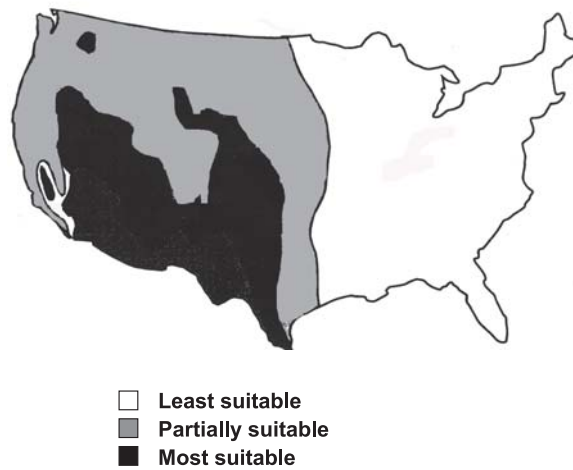


Figure 2. Relative suitability for evapotranspiration systems



## Design assumptions

The design evapotranspiration rate is site specific. Some areas are arid (precipitation < evaporation) but lack the solar radiation or wind velocities necessary to efficiently evaporate wastewater throughout the year. Therefore, simple use of well-known evaporation estimates like Pentman, Blaney-Criddle, and Jensen-Haise will not likely be satisfactory. In fact, historically, the definition of workable ET rates for an area has been a trial and error process, which is further complicated by the system design and the plants used. The primary variables that have an impact on the potential ET rate are climate, cover soil, and vegetation. The most important system variables, which control the movement of wastewater to the surface, are media and the depth to saturated (stored) water. Most published designs are suspect because they store the wastewater so deep that the wicking properties of the fill and the area (voids) through which water must rise restrict delivery of water to the surface where it is evaporated.

Present ET system designs normally employ 20-mil polyethylene liners where the soil is too permeable and ground water contamination is likely. Most employ distribution systems placed in 12 inches of gravel (0.75 to 2.5 inches) at the bottom of the bed. Spacing of the distribution pipes is 4 to 12 feet, with lower values preferred for better distribution. Wicking is accomplished by a 2- to 2.5-foot layer of sand (0.1 millimeter) and a loamy soil-sand mix to raise the water to the surface or a thin layer of soil at the surface. Most have employed the formula:

$$A = nQ/ET - P$$

where:

- A = surface area required to evaporate the wastewater
- n = coefficient, which varies from 1 to 1.6
- Q = annual flow volume
- ET = annual evapotranspiration rate
- P = annual precipitation rate

Each of these factors is open to some degree of interpretation. Because these systems are large and expensive, there has been a tendency to minimize their design size and cost, resulting in significant failure rates. Typical ET estimates range from 0.01 to 2.0 centimeters per day. The contribution of plants has remained a matter of controversy. ET bed sizing has varied from 3,000 to 10,000 square feet and higher. A water balance based on at least 10 years of data is calculated to provide sufficient storage for nonsurfacing operations or to estimate nonatmospheric volumes to be infiltrated.

The modern use of shallow trenches for SWIS is strongly related to the maximization of ET, and such systems could be classified as ETI systems. Further, the use of shallow serial distribution where topographic relief is available is a classic application of the ETI concept, that is, shallow trenches close to the surface, full of wastewater, with only a short wicking distance to the evaporative surface. Such a system fulfills all the described features of an ideal ETI system. Similarly, drip irrigation uses the shallowest of all SWIS burial requirements and, by nature, maximizes ET potential.

## Performance

There have been few studies of ET and ETI systems. Most ET system studies have been less than impressive. In most cases the fault has been related to poor design assumptions, for example, over-estimating the ET potential of shrubs and trees planted on the surface and of the overall potential of ET itself. Poor system design has been somewhat offset by leaking liners that give the appearance that the system is performing adequately. Inadequate wicking has been overcome by raising water levels. However, better ET assessment and more rational designs will improve performance at increased costs.

ETI systems have generally worked well, but no scientific studies have been performed to verify this observation. ETI systems do fail when the ET contribution is overestimated, but many times the placement of the wastewater higher in the soil profile offsets that error by increasing the infiltrative capacity of the site.

## Management needs

ET systems are very sensitive to variations in construction techniques. Poor construction can defeat their utility through poor liner installation, poor placement and choice of wicking media, compaction, and inadequate surface drainage mitigation.

Operation and maintenance requirements are minimal, often consisting of simply mowing the grass on the surface. Replanting cover crops to improve cold season performance has been suggested but offers little return. Shrubs or small trees planted on the ET system generally improve active (warm) season ET and hinder ET in the dormant (cold) season. Therefore, the O/M needs of the system should be limited to two to three short visits to observe and record the water height in the observation well. These tasks require about 1 to 2 hours per year of unskilled labor. No energy is required. ET system salt buildup, if not diluted by precipitation, may require some media replacement after 5 to 10 years of operation depending on water supply characteristics. There are no known safety issues with these systems as long as they are fenced or otherwise isolated from children's play areas.

ETI systems are very similar to SWIS systems, and their management requirements are similar to those of ET systems. Because ETI systems infiltrate wastewater, they have ground water and surface water contamination concerns like those of other SWIS designs, and they may require monitoring of effluent impacts depending on the uses of ground water and performance standards to protect them.

## Risk management issues

Because ET systems are large, there may be some visual aesthetic problems. Odors are usually not a problem, but they can be on occasion. Flow peaks during low ET periods could result in overflows, thus leading to the usual restriction for year-round ET use in areas where ET does not exceed precipitation by more than 2 inches per month. These systems do not function when their surface freezes. They are typically unaffected by power outages since they are generally fed by gravity. Toxics also have no impact unless they are phytotoxic and would then kill the surface vegetation.

## Costs

Because of their large size and specific media (and often liner) requirements, ET systems are generally expensive, reinforcing their use as a "last resort" alternative. Installed costs of \$10,000 to \$15,000 and higher are possible depending on climate and location. O/M costs are relatively low, on the order of \$20 to \$30 per year, but they could increase if the system fills and requires pumping. ETI systems have capital and O/M costs similar to a SWIS.

## References

- Bauer, D.H., E.T. Conrad, and D.G. Sherman. 1979. *Evaluation of Existing and Potential Technologies for Onsite Wastewater Treatment and Disposal*. EPA 600/S2-81-178. U.S. Environmental Protection Agency, Cincinnati, OH.
- Beck, A.F. 1979. Evapotranspiration bed design. *Journal of Environmental Engineering Division-American Society of Civil Engineers* 105(2): 411-415.
- Frank, W.L. 1996. Engineering parameters in the design of evapotranspiration beds. *Water and Engineering Management* November, 31-37.
- Ingham, A.T. 1987. *Guidelines for Evapotranspiration Systems*. State Water Resources Control Board, State of California. Sacramento, CA.
- Lomax, K.M., et al. 1978. *Guidelines for Evapotranspiration Systems*. State Water Resources Control Board, State of California. Sacramento, CA.
- National Small Flows Clearinghouse (NSFC). 1998. Evapotranspiration Systems Fact Sheet. Cooperative Agreement CX825652, U.S. Environmental Protection Agency, Washington, DC.

- National Small Flows Clearinghouse (NSFC). 2000. Evapotranspiration systems. *Pipeline* 11(1).
- Peters, E.C. 1988. *An Evaluation of Enhanced ET Onsite Sewage Treatment and Disposal Systems*. Master's thesis, University of Maryland, College Park.
- Salvato, J.A. 1982. Rational design of evapotranspiration bed. *Journal of Electrical Engineering-American Society of Civil Engineers* 109(3):646-660.
- U.S. Environmental Protection Agency (USEPA). 1999. *Manual: Constructed Wetlands Treatment of Municipal Wastewaters*. EPA/625/R-99/010. U.S. Environmental Protection Agency, Cincinnati, OH.
- Victoria (AUS)-Environmental Protection Agency. 1980. The Use of Transpiration Beds for Domestic Wastewater Disposal. EPA Report No. 104. Melbourne, Australia.
- Wheeter, D.W. 1979. *The Use of Evapotranspiration as a Means of Wastewater Disposal*. Research Report No. 73. Tennessee Water Resources Research Center, University of Tennessee, Knoxville.







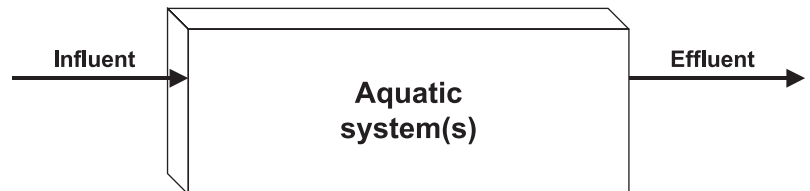
# Onsite Wastewater Treatment Systems Technology Fact Sheet 7

## Stabilization Ponds, FWS Constructed Wetlands, and Other Aquatic Systems

### Description

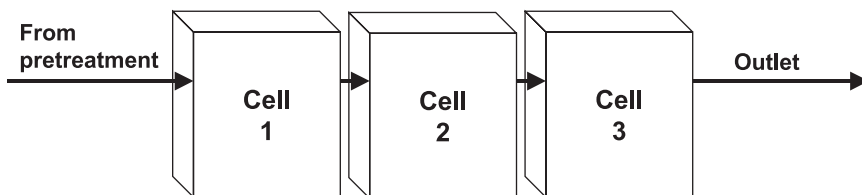
Aquatic systems are large basins filled with wastewater undergoing some combination of physical, chemical, and/or biological treatment processes that render the wastewater more acceptable for discharge to the environment (figure 1). They are not widely used because they tend to be large in area, require some form of fencing to minimize human health risk, often require supplemental treatment before discharge or reuse, and are approved in only a few states.

Figure 1. Generic aquatic lagoon system



Stabilization ponds (lagoons) have many forms, but the facultative lagoon is the most widely used. Aerated lagoons are often preferred because of their smaller size requirements. Anaerobic lagoons and maturation ponds are not used in the United States for onsite application by design. In some areas, lagoons must be lined according to codes, which further limits their application. Facultative lagoons are large in size, perform best when segmented into at least three cells, obtain necessary oxygen for treatment by surface reaeration from the atmosphere, combine sedimentation of particulates with biological degradation, and produce large quantities of algae, which limits the utility of their effluent without further treatment. A typical facultative lagoon is shown in figure 2.

Figure 2. Generic facultative lagoon

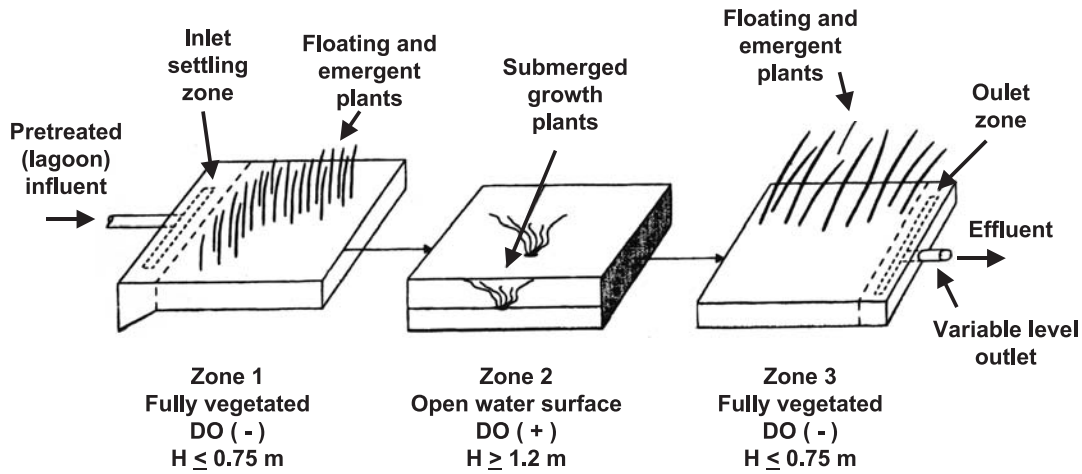


Aerated lagoons use mechanical equipment to enhance and intensify the biodegradation rate. They do not produce the intense algal load on downstream processes and have smaller areal requirements than facultative systems.

Free water surface (FWS) constructed wetlands have also been used, though rarely, for similar reasons. These systems perform best when divided into a minimum of three zones, the first and last being fully vegetated with macrophytes (cattails or bulrushes) and the middle having an open water surface, which performs like a facultative lagoon. In the first zone, the influent is suspended and colloidal solids are flocculated and settled under anaerobic or anoxic conditions. The second zone reaerates the anaerobic wastewater

to provide oxygen for aerobic biodegradation and possible nitrification before the final-zone flocculation and sedimentation (and denitrification) steps. An FWS constructed wetland is shown in figure 3.

**Figure 3. Elements of a free water surface (FWS) constructed wetland**



## Typical applications

Facultative lagoon systems, like evaporative (ET) systems, are not widely used for onsite wastewater treatment. They are large in size, are expensive to build, perform only a portion of the treatment necessary to permit surface discharge or reuse (table 1), and produce large concentrations of algae, which negates their use as direct pretreatment before soil infiltration. They have been used in a few states as an alternative system when a subsurface wastewater infiltration system (SWIS) is not feasible, usually to discharge without further treatment to surface waters, which is generally unacceptable under normal circumstances. In some states intermittent discharge lagoons are required. Storage volume is for all cold weather months (4 to 6 months), making the size of these systems too large for most applications.

Aerated lagoons require far less land and could theoretically be used in place of aerobic biological treatment, but they cannot be buried and insulated in northern climates like those units. They could be used in southern climates as pretreatment for SWISs and would otherwise have similar features to the fact sheets that describe those systems.

FWS constructed wetlands reliably produce an advanced secondary effluent and can be employed for significant nitrogen removal. They require large land areas, similar to facultative lagoons. Their effluent quality is excellent for SWIS application, but they require disinfection for surface discharge and many reuse options. They have a highly desirable appearance, which often makes them the preferred alternative for owners with sufficient land areas.

**Table 1. Typical design guidance**

Parameter	Facultative lagoon	Aerated lagoon	FWS constructed wetland
HRT (days)	30–180	3 (max)	6 (min)
Power (hp/10 <sup>6</sup> gal)	0	30	0
Depth (ft)	3–5	10	2–5
Minimum no. of cells	3	2	3
BOD loading (lb/acre-day)	20–60	200–600	40–53
TSS loading (lb/acre-day)	N/A	N/A	27–45

All of these aquatic systems should be placed after the septic tank and before the disinfection or SWIS steps in the treatment train.

## Performance

Facultative lagoons are capable of 75 to 95 percent BOD removal, but TSS removal varies widely because of algal growth. During nonalgal periods, up to 90 percent TSS removal is possible, but during warm seasons TSS removal can be negligible. In summer months 80 percent of the ammonia-nitrogen is nitrified, total nitrogen removal can reach 60 percent, and total phosphorus removal can approach 50 percent. Very long detention times in hot climates can reduce fecal coliforms to levels that can often meet surface water discharge standards, but typical U.S. retention times reduce fecal coliforms by 2 to 3 logs/100 mL.

Aerated ponds have removal capabilities similar to facultative lagoons, except that TSS removal is more consistent with aerobic biological systems (20 to 60 mg/L). Nitrification of ammonia-nitrogen can be nearly complete in warm seasons, while cold weather will halt that process. Some minimal phosphorus and nitrogen removal (10 to 20 percent) can be anticipated. Fecal coliform removal of 1 to 2 logs/100 mL is likely.

FWS systems can produce effluent BOD and TSS of 20 to 30 mg/L and can reduce nitrogen significantly. TP reduction is generally minor and similar to that of lagoons. Fecal coliform removals of about 2 to 3 logs (99 to 99.9 percent) can be expected.

## Management needs

Aquatic systems are normally excavated in natural soil and constructed with earthen dikes. They may or may not be lined, depending on soil type. Sufficient freeboard (up to 2 feet) must be provided to prevent topping during high winds. In some cases the lagoon may act as a percolation pond, allowing effluent to infiltrate into the underlying soil. When used, mechanical aeration devices must be installed and fixed in place. Aerators may be mounted on piers or floats. Appropriate controls and electrical connections must be provided. Inlets should be located as far away from outlets as possible, and both should be accessible for normal maintenance. Piping and pumps, as required, should be of corrosion-resistant materials, and pumps should be readily accessible. Fencing will normally be required to restrict access by the public.

The operation and maintenance of aquatic systems is typically minimal. Some attention must be paid to flow monitoring and adjustments, as required. Inlet and outlet structures, berms, and surface blockages should be inspected and maintained. The use of mechanical aeration will require operation and maintenance tasks but less than those for extended aeration systems. Sludge management is relatively simple, since sludge builds up very slowly over a period of 10 to 15 years. Pretreatment of lagoon influent by septic tanks will greatly reduce sludge accumulations in the lagoon. Requiring septic tanks for individual homes or facilities served by lagoon cluster systems is recommended. Monitoring of effluent quality for parameters of interest should be provided.

Only aerobic ponds require energy and semiskilled operators. Energy costs are in the range of \$150 to \$250 per year, and labor costs would be \$200 to \$250 per year. Sludge production would be similar to aerobic units. Facultative lagoons and FWS systems require nonskilled O/M personnel to visit the facility two to three times per year. Sludge removal will be required every 10 to 15 years at most. A fence around the facility usually satisfies safety needs.

## Risk management issues

Aquatic systems, particularly facultative lagoons and FWS constructed wetlands, are large, passive systems that are minimally affected by flow variations, extreme cold, and power outages. The risk of drowning can be mitigated only with restricted access, such as that provided by fencing and signage. Aerated lagoons are negatively affected by toxic loads, extreme cold, and power outages. Both lagoon types can be overloaded, resulting in odors, and the aerated type may become odorous during power outages. Poorly maintained facultative lagoons and FWS systems can become sources of

vector problems such as mosquito infestations. FWS systems can be negatively affected by extended toxic discharges, but their aesthetic image is extremely positive.

## Costs

Capital costs for a facultative lagoon for an individual home would be in the range of \$2,500 to \$7,500, whereas an aerated lagoon should cost somewhat more. An FWS system would cost \$2,000 to \$4,000.

Operation and maintenance costs for the facultative lagoon and FWS systems should be less than \$100 per year, whereas O/M costs for the aerated lagoon (including power) would be \$350 to \$500 per year.

## References

- Bauer, D.H., E.T. Conrad, and D.G. Sherman. 1979. *Evaluation of Onsite Wastewater Treatment and Disposal Options*. EPA 600/S2-81-178. U.S. Environmental Protection Agency, Cincinnati, OH.
- National Small Flows Clearinghouse. 1996. *Summary of Onsite System in the United States, 1993*. National Small Flows Clearinghouse Publication, Morgantown, WV.
- Reed, S.C., R.W. Crites, and E.J. Middlebrooks. 1995. *Natural Systems for Waste Management and Treatment* McGraw-Hill, New York, NY.
- U.S. Environmental Protection Agency (USEPA). 1983. *Design Manual: Municipal Wastewater Stabilization Ponds*. EPA 625/1-83/015. Center for Environmental Research Information, U.S. Environmental Protection Agency, Cincinnati, OH.
- U.S. Environmental Protection Agency (USEPA). 1992. *Manual: Wastewater Treatment Disposal for Small Communities*. EPA 625/R-92/005. U.S. Environmental Protection Agency, Cincinnati, OH.
- U.S. Environmental Protection Agency (USEPA). 1999. *Manual: Constructed Wetlands Treatment of Municipal Wastewaters*. EPA 625/R-99/010. U.S. Environmental Protection Agency, Cincinnati, OH.
- Water Environment Federation. 1990. *Natural Systems for Wastewater Treatment: Manual of Practice FD-16*. Water Environment Federation, Alexandria, VA.



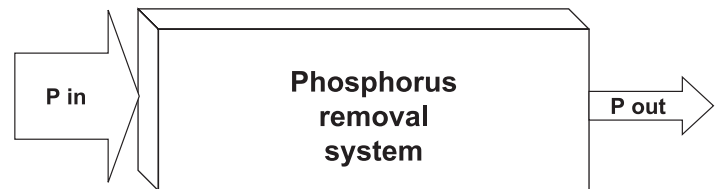
# Onsite Wastewater Treatment Systems Technology Fact Sheet 8

## Enhanced Nutrient Removal— Phosphorus

### Description

There are a large number of processes that can reduce nitrogen and a few that can reduce phosphorus. Most of these phosphorus removal processes are additions to other pretreatment processes that enhance the overall removal of phosphorus (figure 1). The degree of nutrient removal, the cost, and the O/M difficulty of these combinations quickly reduce the number of systems that are likely to be implemented for onsite nutrient removal. The removal of phosphorus is of concern where effluents may enter surface waters via direct surface discharge or subsurface flow through fractured bedrock, and in soils where little phosphorus exchange would take place (see chapter 3). Phosphorus is a key element in the eutrophication of natural or impounded freshwater bodies and some estuarine waters.

Figure 1. Phosphorus removal



Few phosphorus removal processes are well developed for onsite wastewater systems application. Those that have been successfully applied

generally fall into the categories of chemical, physical, and biological systems. The controlled addition of chemicals such as aluminum, iron, and calcium compounds with subsequent flocculation and sedimentation has had only limited success because of inadequate operation and maintenance of mechanical equipment problems and excessive sludge production. Physical and chemical processes such as ion exchange and precipitation of phosphates have been tried, but with limited success. Most notable successes have come with special filter materials that are naturally high in their concentration of the above chemicals, but their service lives are finite. Studies of high-iron sands and high-aluminum muds indicate that 50 to 95 percent of the phosphorus can be removed. However, the life of these systems has yet to be determined, after which the filter media will have to be removed and replaced. Use of supplemental iron powder mixed with natural sands is also being researched. All calcareous sands and other sands with high concentrations of these three elements will exhibit high phosphorus removal rates for some finite periods. Typical calcium-containing U.S. sands will essentially exhaust their capacity in 3 to 6 months, after which they will remove only particulate-based organic phosphorus or about 10 to 20 percent of the phosphorus contained in the wastewater.

One other practical way to minimize phosphorus discharges to the environment is the use of low-phosphate or phosphate-free detergents, which can reduce the wastewater P concentration from 7 to 8 mg/L to 5 to 6 mg/L. In terms of P movement from the SWIS to nearby waters, such a change could add 30 to 40 percent to the site's service life in attenuating or containing P from movement away from the SWIS. Of all the options, this may be the simplest, but concerns over public acceptance of these detergents as cleaning agents persist.

The only other known P-removal approach is the use of biological treatment systems. All aerobic treatment systems described in other fact sheets have the natural ability to remove 10 to 20 percent of the influent phosphorus, which is connected to the organic form in the biological reactors and wasted with excess sludge. Certain processes such as the



sequencing batch reactor (SBR) can improve on this removal by proper sequencing of aeration periods. Other aerobic biological units can similarly upgrade their phosphorus removal performance by the addition of anaerobic steps up to an effluent limit of 1 to 2 mg P/L, but the data to support the onsite applications of these upgrade technologies are lacking.

## Typical application

Phosphorus is rarely designed to be removed in onsite pretreatment because most soils have the innate ability to adsorb the nutrient for many years before it begins to migrate to nearby ground or surface waters. However, as onsite system sites age, there is the potential for serious environmental degradation, as witnessed by the thousands of inland lakes where older, onsite development is increasingly being cited as the primary reason for lake eutrophication.

Therefore, the most likely P-reduction systems that will be applied are iron-rich intermittent sand filter (ISF) media, sequencing batch reactors (SBR), and phosphate-free detergents. Other systems will surely be developed, especially upgraded aerobic treatment systems, but these three systems are most representative of current phosphorus reduction programs.

## Design assumptions

For special filter media, the design assumptions would be the same as those for an intermittent sand filter (ISF) with adjustment to the hydraulic and phosphorus areal rates because they might differ from conventional systems. Hydraulic loadings for one successful study are essentially 3 cm/day, and the TP loading is 0.16g/m<sup>2</sup>/day. The major unknown is the life of the special P-adsorption media. Most high-calcium sands become saturated in a few months, but one specific case has reported 2.5 years. Generally, these sands are not cost-effective. High-iron sands and crushed bricks are being studied and show longer durations of P-removal effectiveness, but definitive service lives are as yet unknown. The use of “red mud” and iron oxide powder mixed with sands and placed below the infiltrative surface in the SWIS has been successful, but the life of such media and the difficulty of replacement make these concepts less attractive unless the former is in the range of 20 years. Red mud (a bauxite mining by-product) must constitute at least 30 percent of the total volume of the filter bed. In a SWIS, the material must be mixed with the natural soil to a depth of 1 foot (0.3 m) below the infiltrative surface to attain high P-removal efficiency. Specific depths of mixed soils and loading rates have not been clearly delineated.

SBRs are capable of phosphorus removals greater than the typical CFSGAS, which can range from 20 to 40 percent. This is best accomplished by the “true” SBR (IF), but also by continuous feed (CF) SBRs if designed to do so. The IF type must not aerate during the fill stage in order to remove greater amounts of TP. The CF type must have a no-aeration section immediately following the recycle point to accomplish similar goals. Such designs are capable of reaching effluent TP in the range of 1.0 mg/L. The only onsite CF test available did not employ this sequence and removed only about 30 percent of the TP. Sludge wasting requirements are severe and limit the performance of this alternative.

Because carbon-to-phosphorus ratios in septic tank effluent are generally favorable (typically, 150 mg/L BOD to 7mg/L TP), the anoxic/anaerobic first stages (combined with appropriate organic loading rates and HRTs, as noted in the SBR fact sheet) can result in significant TP removal. Typically, this mode of SBR operation should also remove most of the nitrogen. All the phosphorus removal options require noncorrosive materials of construction, appropriate alarms and sensing systems, and regular management by semiskilled staff.

## Performance

The systems described above, in concert with low- or non-phosphate detergent use, are capable of removing phosphorus to an effluent value of 1 to 2 mg/L with proper maintenance. Subsequent travel through the soil’s vadose zone would further enhance TP concentrations to very low ambient values. Direct discharge (after disinfection) would meet most surface discharge requirements.

Phosphorus removal should be provided in sensitive surface water areas if direct surface discharging systems are used, or if SWISs are located in noncalcareous, low-iron or low-aluminum soils in close proximity to or directly influencing sensitive surface waters.

## Management needs

The use of low- or non-phosphate detergents would generally be a regional responsibility. Management of a high-iron or a high-aluminum filter would be similar to that required for ISFs. Flows and dosing rates should be checked on each O/M visit, along with annual recalibration of dosing pumps and monitoring of TP in the effluent. At least two visits per year are suggested to manage these systems (or 8 hours per year).

The SBR option is exactly the same as in the SBR fact sheet or three to four visits per year by semiskilled personnel (6 to 12 hours), with electrical usage of 3 to 10 kWh/day. The SBR will produce an additional 0.6 to 1.0 lb TSS/lb BOD removed, over and above the solids captured in the septic tank.

## Risk management issues

The two treatment systems described above are relatively unaffected by wide flow variations. The SBR can be seriously impaired by the toxic shocks but not the enhanced ISF. Both should be safe from extremely cold climates if properly insulated, but the SBR will suffer reduced biochemical efficiency in such extremes. Power outages will affect the SBR, producing odors and poor efficiency for some time after power restoration. The enhanced filter will also be interrupted because of dosing pump failure, but it should not experience odors or subsequent impairment.

## Costs

Enhanced TP-removal filters will have cost characteristics similar to conventional ISFs except in the initial and subsequent replacement of the enhanced media. Such a system may have an initial media cost increment of at least 1.2 and possibly 2.0 or larger, and an annual additional O/M cost related to more frequent media replacement. For example, a 5-year life would mean that a substantial replacement charge would be incurred every 5 years, equating to several hundred dollars per year in O/M cost over and above the normal O/M cost of \$250 to \$400 per year. The capital cost would vary between \$5,000 and \$11,000.

The SBR would exhibit similar capital (\$9,000 to \$12,000 per year) and O/M (\$650 to \$800 per year) costs as provided in Technology Fact Sheet 3.

## References

- Ayres Associates. 1997. *Florida Keys Onsite Wastewater Nutrient Reduction Systems (OWNRS) Demo Project Control Testing Facility: 2nd Quarter Status Report*. Report to Florida Department of Health under Contact No. LPQ988 and U.S. Environmental Protection Agency under Contract No. X994394-93-0. Ayres Associates, Madison, WI.
- Brandes, M. 1977. Effective phosphorus removal by adding alum to septic tank. *Journal of Water Pollution Control Federation* 49:2285-2296.
- Ho, G.E., K. Mathew, and R.A. Gibbs. 1992. Nitrogen and phosphorus removal from sewage effluent in amended soil columns. *Water Resources* 26(3):295-300.
- Irvine, R.L., L.H. Ketchum, Jr., M.L. Arora, and E.F. Barth. 1985. An organic loading study of full-scale SBRs. *Journal of Water Pollution Control Federation* 57(8):847-853.
- National Small Flows Clearinghouse. 1999. Benzie County, Michigan, NODPI project completed. *Small Flows* 13(4):10-11.
- U.S. Environmental Protection Agency (USEPA). 1987. *Phosphorus Removal Design Manual*. EPA 625/1-87/001. U.S. Environmental Protection Agency, Water Engineering Research Laboratory, Cincinnati, OH.





# Onsite Wastewater Treatment Systems Technology Fact Sheet 9

## Enhanced Nutrient Removal— Nitrogen

### Description

Nitrogen is a pollutant of concern for a number of reasons. Nitrogen in the ammonia form is toxic to certain aquatic organisms. In the environment, ammonia is oxidized rapidly to nitrate, creating an oxygen demand and low dissolved oxygen in surface waters. Organic and inorganic forms of nitrogen may cause eutrophication (i.e., high productivity of algae) problems in nitrogen-limited freshwater lakes and in estuarine and coastal waters. Finally, high concentrations of nitrate can harm young children when ingested.

Ammonia oxidation (nitrification) occurs in some of the processes described in previous fact sheets, and is dependent upon oxygen availability, organic biochemical oxygen demand (BOD), and hydraulic loading rates. Nitrogen removal by means of volatilization, sedimentation, and denitrification may also occur in some of the systems and system components. The amount of nitrogen removed (figure 1) is dependent upon process design and operation. Processes that remove 25 to 50 percent of the total nitrogen include aerobic biological systems and media filters, especially recirculating filters (Technology Fact Sheet 11). Enhanced nitrogen removal systems can be categorized by their mode of removal. Wastewater separation systems, which remove toilet wastes and garbage grinding, are capable of 80 to 90 percent nitrogen removal. Physical-chemical systems such as ion exchange, volatilization, and membrane processes, are capable of similar removal rates. Ion exchange resins remove  $\text{NH}_4\text{-N}$  or  $\text{NO}_3\text{-N}$ . Membrane processes employ a variety of membranes and pressures that all have a significant reject flow rate. Volatilization is generally significant only in facultative lagoon systems where ammonia volatilization can be significant. The vast majority of practical nitrogen-removal systems employ nitrification and denitrification biological reactions. Most notable of these are recirculating sand filters (RSFs) with enhanced anoxic modifications, sequencing batch reactors (SBR), and an array of aerobic nitrification processes combined with an anoxic/anaerobic process to perform denitrification. Some of the combinations are proprietary. Any fixed-film or suspended-growth aerobic reactor can perform the aerobic nitrification when properly loaded and oxygenated. A variety of upflow (AUF), downflow, and horizontal-flow anaerobic reactors can perform denitrification if oxygen is absent, a degradable carbon source (heterotrophic) is provided, and other conditions (e.g., temperature, pH, etc.) are acceptable.

Figure 1. Nitrogen removal systems



The most commonly applied and effective nitrogen-removal systems are biological toilets or segregated plumbing options and/or nitrification-denitrification process combinations. A more complete list is described below, along with accompanying schematic diagrams.

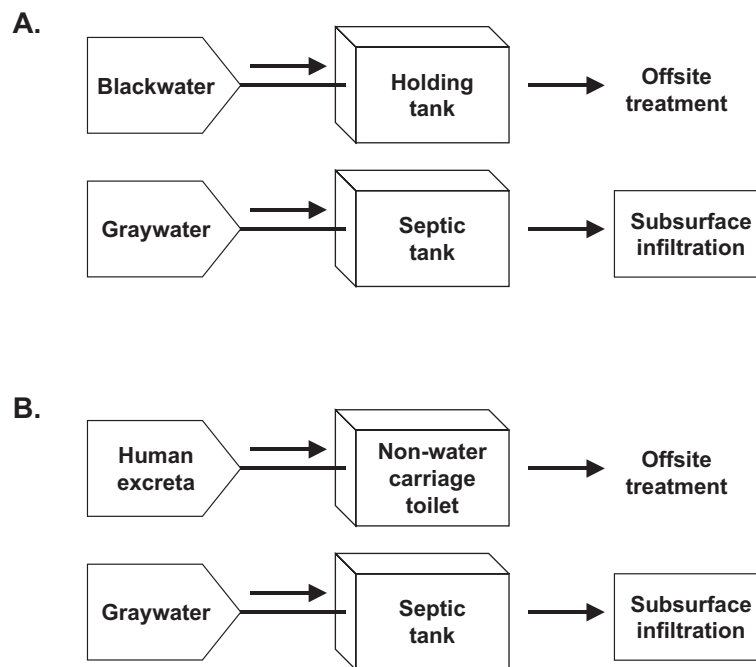
## Source separation systems

Source separation relies on isolating toilet wastes or blackwater from wastewater. This requires separate interior collection systems. Two source separation systems were identified: blackwater holding tank with low-volume-discharge toilets and graywater septic tank system, and non-water-carriage toilets and graywater septic tank system (figure 2). These types of toilets are discussed in chapter 3.

### *Blackwater holding tank with low-volume-discharge toilets and graywater septic tank system*

Blackwater discharged directly to a holding tank requires periodic removal for offsite treatment. Graywater wastes can be discharged to a conventional septic tank or subsurface infiltration system.

**Figure 2. Source separation systems: A. blackwater holding tank with low-volume discharge toilets and graywater septic tank system; B. non-water-carriage toilet and graywater septic tank system**



### *Non-water-carriage toilets and graywater septic tank system*

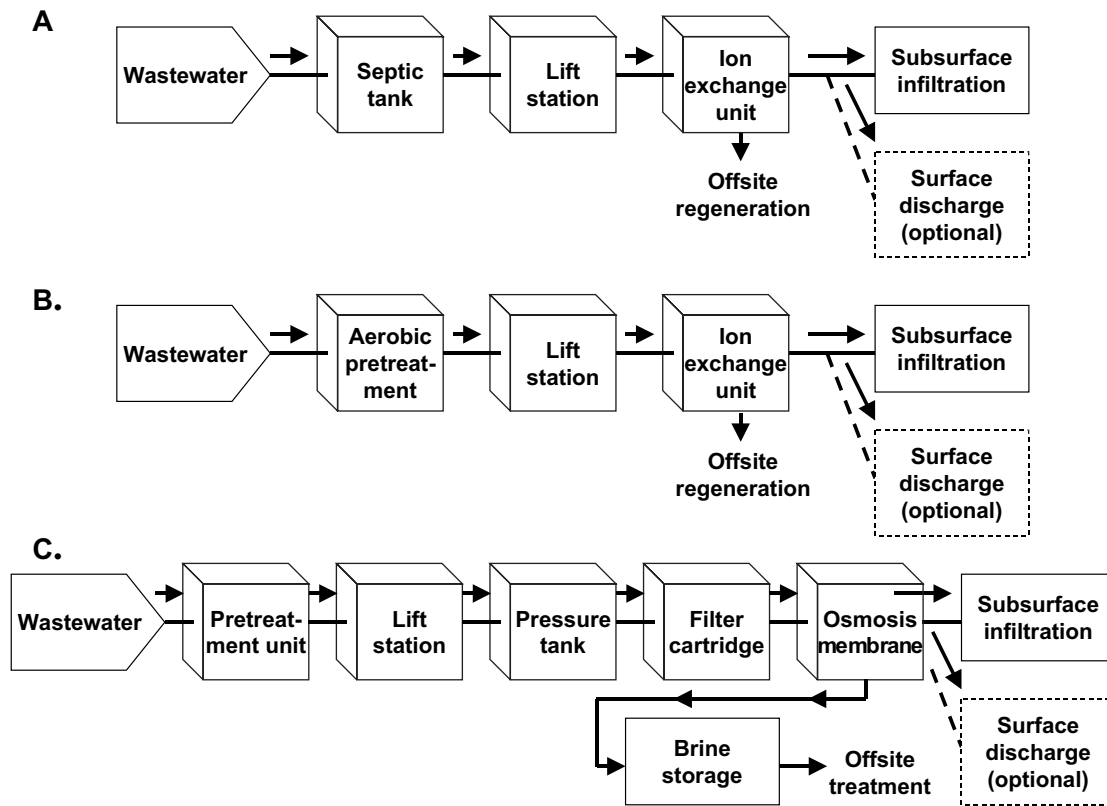
Excreta is discharged to non-water-carriage toilets to promote bulk reduction and decomposition. Biological and incineration toilets are the most common methods of accomplishing this. Non-water-carriage toilets that use these processes are commercially available. The remaining graywater wastes can be discharged to a conventional septic tank subsurface infiltration system.

## Physical/chemical treatment systems

Two types of physical/chemical treatment systems, ion exchange and reverse osmosis, appear to have some promise for single home use, although neither is in use at present (figure 9-3).



Figure 3. Physical/chemical systems: A. cation ( $\text{NH}_4^+$ ) exchange; B. anion ( $\text{NO}_3^-$ ) exchange; C. reverse osmosis



### *Ion exchange*

Two types of systems may be employed: cationic or anionic exchange systems. In the cationic system, the ammonium in septic tank effluent is removed. Clinoptilolite, a naturally occurring zeolite that has excellent selectivity for ammonium over most other cations in wastewater, can be used as an exchange medium. In the anionic system, septic tank effluent must be nitrified prior to passage through the exchange unit. Strong-base anion resins can be employed as an exchange medium for nitrate. Both systems require resin regeneration offsite.

### *Reverse osmosis*

This system requires pretreatment to remove much of the organic and inorganic suspended solids in wastewater. Pretreated wastewater stored under pressure is fed to a chamber containing a semipermeable membrane that allows separation of ions and molecules before disposal. Large volumes of waste brine are generated and must be periodically removed for offsite treatment.

## **Biological treatment systems**

A number of onsite treatment systems use biological denitrification for removal of nitrogen from wastewater. These systems have received the most scrutiny with respect to development and performance monitoring. However, more development and performance monitoring will be necessary to refine the performance consistency and improve understanding of operation processes and mechanisms (see figure 4).

Figure 4. Biological systems: A. an aerobic/anaerobic trickling filter package plant; B. sequencing batch reactor (SBR) design principle; C. ISF with AUF; D. source separation, treatment, recombination; E. recirculating sand filter with septic tank option; F. recirculating sand filter with anaerobic filter and carbon source

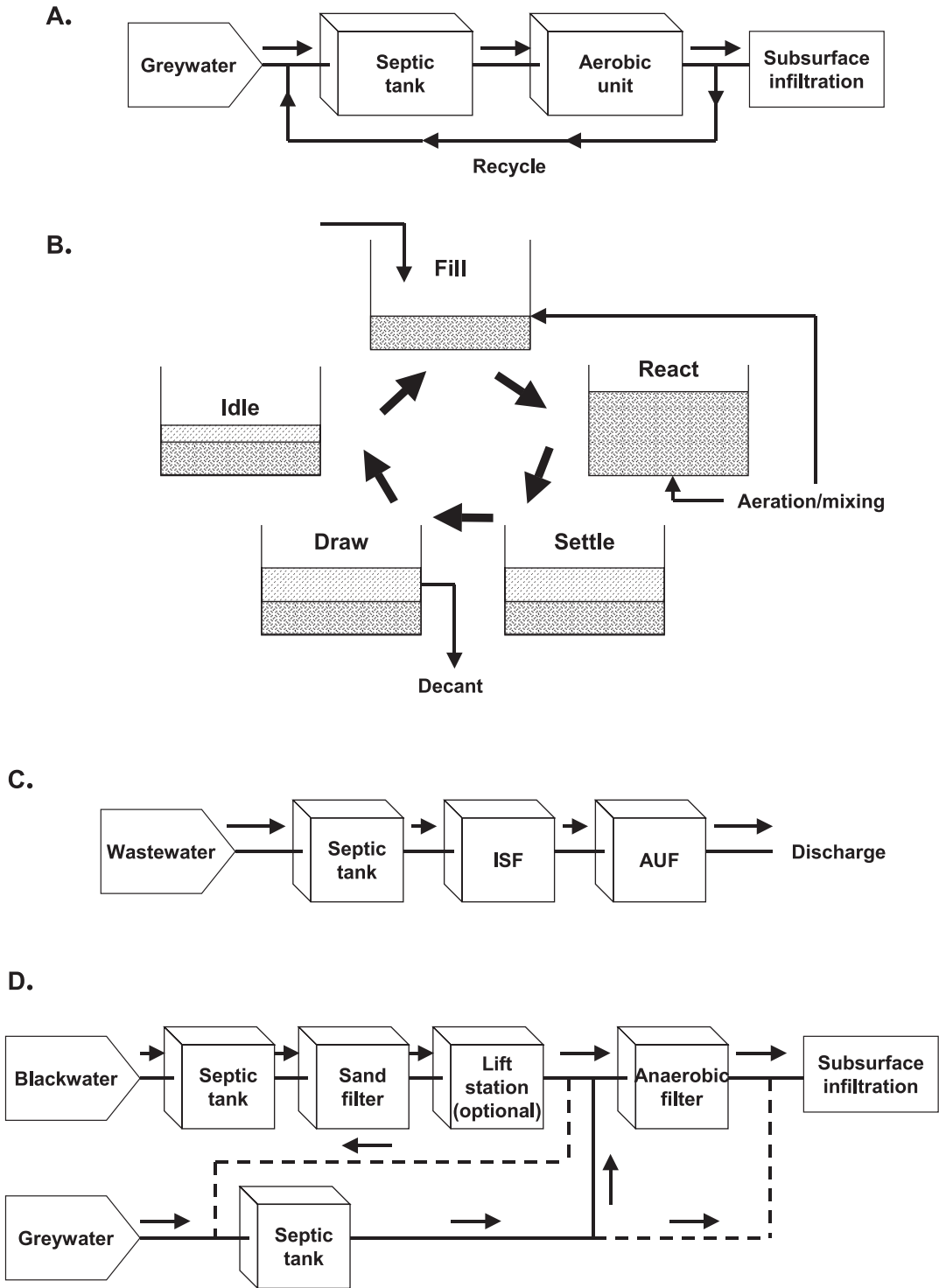
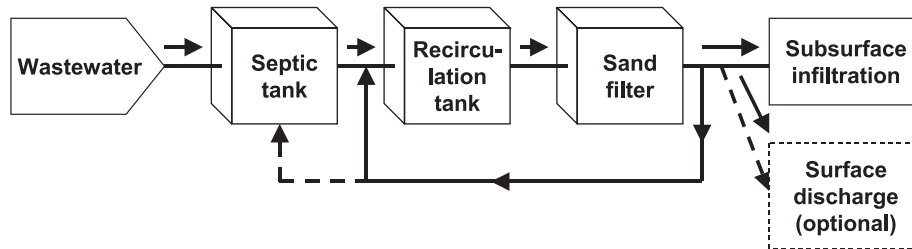
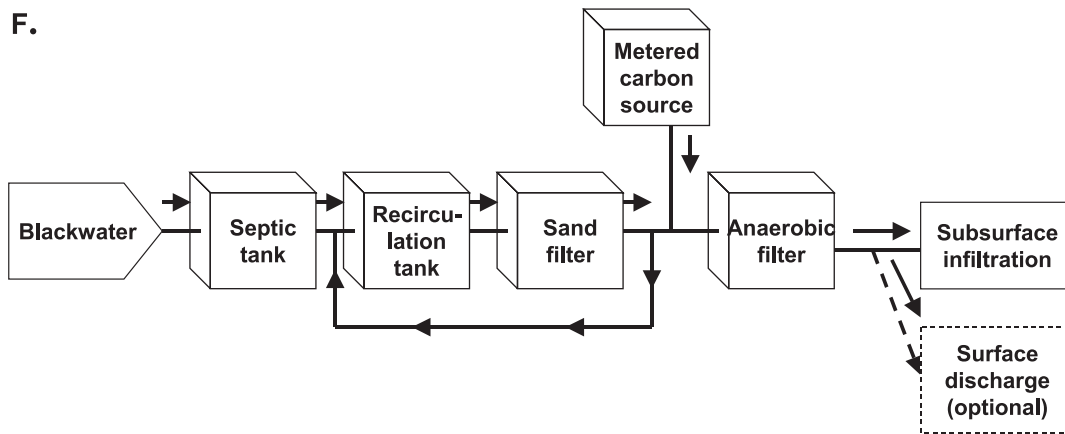


Figure 4. (continued)

E.



F.



#### *Aerobic/anaerobic trickling filter package plant*

These commercial systems use synthetic media trickling filters that receive wastewater from overlying sprayheads for aerobic treatment and nitrification. Filtrate returns to the anaerobic zone to mix with either septic tank contents or incoming septic tank effluent and undergoes denitrification. A portion of the filtered effluent (equal to the influent flow) is discharged for disposal or further treatment.

#### *Sequencing batch reactor (SBR)*

If sufficient hydraulic retention time (HRT) is provided to permit nitrification during the “react” phase of the SBR cycle and if the fill stage is anoxic for a sufficient HRT, the system can remove significant amounts of nitrogen and phosphorus. The SBR design is essentially the same as is described in the SBR fact sheet, while operationally the conditions noted above must be maintained.

#### *Intermittent sand filters with anaerobic filters*

Nitrification is provided in the ISF, while denitrification is provided in either the preceding septic tank with recirculation or a separate anaerobic filter. A vegetated submerged bed (VSB) (“subsurface flow wetland”) may be substituted for the anaerobic filter.

#### *Source separation, treatment, and recombination*

One commercial system employs this sequence where blackwater (toilet wastewater), after settling in a separate tank, is aerobically treated with an ISF to nitrify the majority of the nitrogen before it is recombined with settled greywater in an anaerobic upflow filter (AUF) for denitrification.

### *Recirculating sand filters combined with anaerobic/anoxic filters*

RSF systems normally remove 40 to 50 percent of influent nitrogen. To enhance this capability, they can be combined with a greater supply of carbon, time, and mixing than is normally available from the conventional recirculation tank. The anaerobic/anoxic options include recycling to the septic tank, better mixing, and longer HRT in a separate UF or VSB, or adding supplemental carbon (e.g., methanol, ethanol) to enhance the potential of the denitrification step.

## Typical applications

Nitrogen removal is increasingly being required when onsite systems are on or near coastal waters or over sensitive, unconfined aquifers used for drinking water. Nitrogen removal systems generally are located last in the treatment train prior to SWIS disposal and may be followed by disinfection when the system must discharge to surface waters. Usually, the minimum total nitrogen standard that can be regularly met is about 10 mg/L. Aerobic biological systems should not be employed at seasonal facilities.

## Design assumptions

A myriad of potential systems exist for enhanced nitrogen removal, and all of the major unit processes of such systems are described elsewhere. Also, since waste stream modification is covered in chapter 3, only the most promising, developed options are discussed in this fact sheet. Of the options discussed, granular media filters or aerobic biological systems (usually combined with an anaerobic upflow filter or the original septic tank process) are discussed in more detail.

Some salient design considerations that are not covered in other fact sheets or text include the following:

- Autotrophic denitrification in packed-bed sulfur reactors (variation on AUF) has been successfully demonstrated, but the need for additional alkalinity and the production of a high sulfate effluent have thus far limited the process.
- Denitrification improves with increased HRT in the recirculation tank, better mixing, and a pH between 7 and 8.
- Use of greywater as the degradable carbon source for denitrification limits the degree of denitrification attainable owing to reduced nitrogen content and low carbon-to-nitrogen ratio. The latter should exceed 5:1 for good denitrification.
- Use of synthetic anionic exchange resins appears impractical at this time. Cationic exchange of  $\text{NH}_4\text{-N}$  with clinoptilolite is feasible but very expensive because of the regeneration management costs. Both may be subject to fouling and clogging problems.
- Membranes present a major problem given the volume of the reject stream, which must be collected and frequently trucked to a site that will accept it for disposal.
- The use of beds of carbon-rich materials below SWIS leach lines could be a promising concept if the hydraulic matching problems are solved and the bed service life can be extended for 10 years or more.
- Accessibility, size of the holding tank, and availability of residual management facilities are significant design considerations in blackwater separation systems.
- Recycling to the septic tank may affect solids and grease removal in the tank and cause poor mixing of the nitrified stream with the septic tank contents. This could raise the oxidation-reduction potential (ORP) of the mixture above the normal range for an anoxic zone that accomplishes denitrification. Recycling to the second compartment of a multicompartiment tank is suggested at a ratio of less than 2.5 to 1 with a contact time of greater than 2 days.
- An AUF used for enhanced denitrification should be loaded with between 0.06 and 0.3 lb COD/ft<sup>3</sup> per day and have an HRT of at least 24 hours (preferably 36 or more hours). It can be filled with large (> 2 inches) rocks or synthetic media. A vegetated submerged bed (VSB) can be substituted for an AUF and may contribute some labile carbon to aid the process.

- SBR design for nitrogen and phosphorus removal is essentially similar, but the amount of labile carbon required is greater (6 to 8 mg/LCOD/ mg/L of TKN to be denitrified).
- Modern microprocessor controls make very complex process combinations possible to remove nitrogen, but overall simplicity is still desirable and requires less O/M sophistication.
- To attain full (>85 percent) nitrification, fixed-film systems cannot be loaded above 3 to 6 g BOD/m<sup>3</sup> per day or 6 to 12 g BOD/m<sup>3</sup> per day for rock and plastic media, respectively.

## Performance

Some expected sustainable performance ranges for the most likely combinations of nitrogen removal processes are given in table 1. Some of the nitrogen-removal systems could be combined with source separation and product substitution (low-phosphate detergents) for a maximum reduction in nitrogen where extreme measures might be required. However, the removals would not be additive owing to the changes in wastewater characteristics.

**Table 1. Typical N-removal ranges for managed systems**

Process	Percent TN removal
RSF	40–50
RSF (with recycle to ST or AUF)	70–80
ST–FFS (with recycle to ST or AUF) <sup>a</sup>	65–75
SBR <sup>a</sup>	50–80
SS and removal	60–80
(SS–TT R) <sup>a</sup>	40–60
ISF–AUF	55–75

<sup>a</sup>Commercially available systems.

Note: RSF = recirculating sand filters; AUF = anaerobic upflow filter; ST = septic tank; FFS = fixed-film system; SBR = sequencing batch reactor; SS = source separation; TT = treatment applied to both systems; R = recombined; ISF = intermittent sand filter.

## Management needs

Management needs for most unit processes are covered in other fact sheets. Source separation is feasible only for new homes, as it would be prohibitively expensive for existing homes. AUF systems are different from the fact sheet in that they must have HRTs greater than 2 days to enable anaerobic biological denitrification to be effective. This will add to O/M tasks by requiring regular flushing of excess biological growth. Some separation and removal would require regular inspection and maintenance of non-water-carriage toilets and periodic removal and proper disposal of excess solids from these units and from holding tanks.

## Risk management issues

Of the most likely systems shown in the table, few are extremely susceptible to upset by hydraulic loading variations. However, soluble toxic shocks could affect any AUF, SBR, or fixed-film nitrification system. Extreme cold will also have an impact on these systems. However, the ISF, RSF, and AUF systems have been the most resilient unit processes (excluding source separation) when properly housed and insulated. Power outages will affect all of the treatment systems. Reliability would be greatest for those that incorporate filters and less for the SBR and fixed-film systems.

## Costs

The capital and total costs of most of the nitrogen removal systems are very site specific, but non-water-carriage toilet source separation (assuming new homes) is the least expensive (low-water-use fixtures and holding tanks would add about \$4,000 to \$6,000). The biological combinations would be more expensive, and the physical/chemical systems would likely be the most expensive. Multiple units will generally increase costs, while the use of gravity transfer between processes will reduce them.

The additional O/M associated with an AUF involves flushing and disposal of excess flushed solids. If methanol is employed to enhance denitrification, additional O/M is required for the feeding system.



## References

- Ayres Associates. 1991. *Onsite Nitrogen Removal Systems: Phase I*. Report to Wisconsin DILHR, Madison, WI.
- Ayres Associates. 1997. *Florida Keys Wastewater Nutrient Reduction Systems Demo Project: 2nd Quarter Report*. Report to Florida Department of Health and U.S. Environmental Protection Agency. Florida Department of Health, Tallahassee, FL.
- Bauer, D.H., E.T. Conrad, and D.G. Sherman. 1979. *Evaluation of Existing and Potential Technologies for Onsite Wastewater Treatment and Disposal*. EPA 600/S2/81/178. Cincinnati, OH.
- Boyle, W.C., R.J. Otis, R.A. Apfel, R.W. Whitmeyer, J.C. Converse, B. Burkes, M.J. Bruch, Jr., and M. Anders. 1994. Nitrogen Removal from Domestic Wastewater in Unsewered Areas. In *Proceedings of the Seventh On-Site Wastewater Treatment Conference*. American Society of Agricultural Engineering, St. Joseph, MI.
- Katers, J.F., and A.E. Zaroni. 1998. Nitrogen removal. *Journal of Water Environment and Technology* 10(3):32-36.
- Lamb, B., A.J. Gold, G. Loomis, and C. McKiel. 1987. Evaluation of Nitrogen Removal Systems for Onsite Sewage Disposal. In *Proceedings of Fifth On-Site Wastewater Treatment Conference*. American Society of Agricultural Engineering, St. Joseph, MI.
- U.S. Environmental Protection Agency (USEPA). 1993. *Nitrogen Control Manual*. EPA 625/R-93/010. U.S. Environmental Protection Agency, Office of Research and Development, Cincinnati, OH.
- Venhuizen, D. LCRA onsite demonstration project for nitrogen removal and water reclamation. Unpublished but available from D. Venhuizen, P.E., 21 Cotton Gin Road, Umland, TX 78640.
- Whitmyer, R.W., R.A. Apfel, R.J. Otis, and R.L. Meyer. 1991. Overview of Individual Onsite Nitrogen Removal Systems. In *Proceedings of Sixth On-Site Wastewater Treatment Conference*. American Society of Agricultural Engineering, St. Joseph, MI.
- Winkler, E.S., and P.L.M. Veneman. 1991. A Denitrification System for Septic Tank Effluent Using Sphagnum Peat Moss. In *Proceedings of Sixth On-Site Wastewater Treatment Conference*, American Society of Agricultural Engineering, St. Joseph, MI.



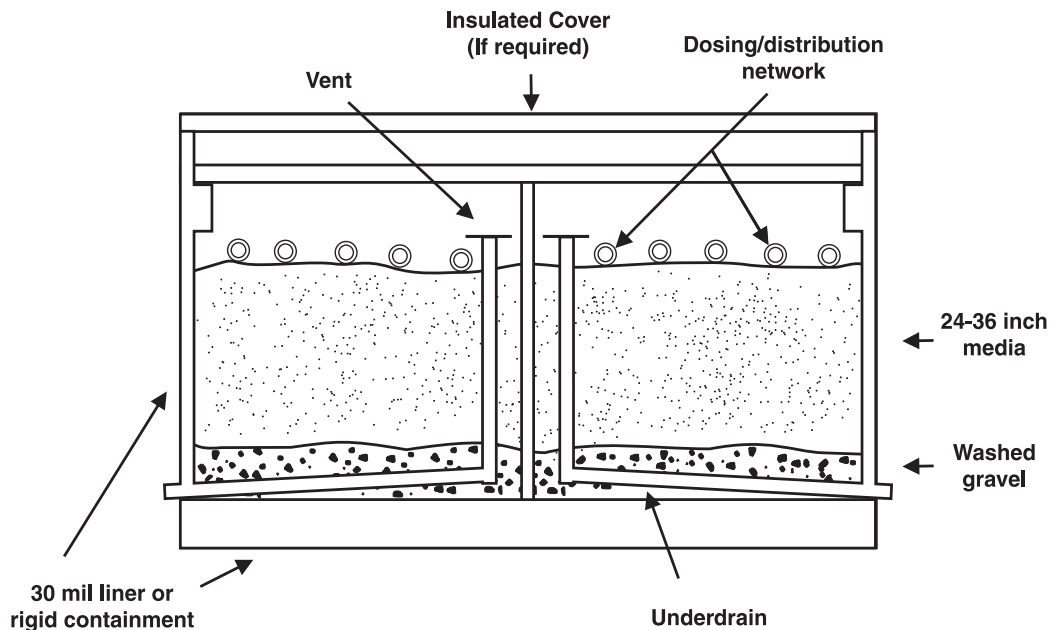
# Onsite Wastewater Treatment Systems Technology Fact Sheet 10

## Intermittent Sand/Media Filters

### Description

The term *intermittent sand filter* (ISF) is used to describe a variety of packed-bed filters of sand or other granular materials available on the market. Sand filters provide advanced secondary treatment of settled wastewater or septic tank effluent. They consist of a lined (e.g., impervious PVC liner on sand bedding) excavation or structure filled with uniform washed sand that is placed over an underdrain system (see figure 1). The wastewater is dosed onto the surface of the sand through a distribution network and allowed to percolate through the sand to the underdrain system. The underdrain system collects the filter effluent for further processing or discharge.

Figure 1. Generic, open intermittent sand filter



Sand filters are aerobic, fixed-film bioreactors. Other treatment mechanisms that occur in sand filters include physical processes, such as straining and sedimentation, that remove suspended solids within the pores of the media. Also, chemical adsorption of pollutants onto media surfaces plays a finite role in the removal of some chemical constituents (e.g., phosphorus). Bioslimes from the growth of microorganisms develop as films on the sand particle surfaces. The microorganisms in the slimes absorb soluble and colloidal waste materials in the wastewater as it percolates over the sand surfaces. The adsorbed materials are incorporated into a new cell mass or degraded under aerobic conditions to carbon dioxide and water.

Most biochemical treatment occurs within approximately 6 inches of the filter surface. As the wastewater percolates through this layer, suspended solids and carbonaceous biochemical oxygen demand (BOD) are removed. Most suspended

solids are strained out at the filter surface. The BOD is nearly completely removed if the wastewater retention time in the sand media is sufficiently long for the microorganisms to absorb wastewater constituents. With depleting carbonaceous BOD in the percolating wastewater, nitrifying microorganisms are able to thrive deeper in the surface layer where nitrification will readily occur.

Chemical adsorption can occur throughout the media bed. Adsorption sites in the media are usually limited, however. The capacity of the media to retain ions depends on the target constituent, the pH, and the mineralogy of the media. Phosphorous is one element of concern in wastewater that can be removed in this manner, but the number of available adsorption sites is limited by the characteristics of the media.

The basic components of intermittent sand filters include a dosing tank, pump and controls (or siphon), distribution network, and the filter bed with an underdrain system (see figure 1). The wastewater is intermittently dosed from the dosing tank onto the filter through the distribution network. From there, it percolates through the sand media to the underdrain and is discharged. On-demand dosing is usually used, but timed dosing is becoming common.

There are a large number of variations in ISF designs. For example, there are different means of distribution, underdrain designs, housing schemes and, most notably, media choices. Many types of media are used in single-pass filters. Washed, graded sand is the most common. Other granular media used include gravel, crushed glass, and bottom ash from coal-fired power plants. Foam chips (polystyrene), peat, and coarse-fiber synthetic textile materials have also been used. These media are generally restricted to proprietary units. System manufacturers should be contacted for application and design using these materials.

There are also related single-pass designs, which are not covered in this fact sheet. These include lateral flow designs and upflow-wicking concepts, both of which use physical removal concepts closer to the concepts described in the fact sheet on anaerobic upflow filters and vegetated submerged beds. These processes are not discussed herein but may exhibit some pollutant removal mechanisms that are described here. Simple gravity-fed, buried sand filters are not discussed because their performance history is unsatisfactory.

## Applications

Sand filters can be used for a broad range of applications, including single-family residences, large commercial establishments, and small communities. Sand filters are frequently used to pretreat septic tank effluent prior to subsurface infiltration onsite where the soil has insufficient unsaturated depth above ground water or bedrock to achieve adequate treatment. They are also used to meet water quality requirements (with the possible exception of fecal coliform removal) before direct discharge to a surface water. Sand filters are used primarily to treat domestic wastewater, but they have been used successfully in treatment trains to treat wastewaters high in organic materials such as those from restaurants and supermarkets. Single-pass ISF filters are most frequently used for smaller applications and sites where nitrogen removal is not required. However, they can be combined with anaerobic processes to reduce nitrogen significantly. Many studies have shown that ISF-treated onsite wastewaters can reduce clogging of the infiltrative surface by many times when compared with septic-tank effluents. However, be careful to evaluate the overall loading of pollutants and pathogens to the underlying aquifer and nearby surface waters before considering significant SWIS sizing reductions.

## Design

ISF filter design starts with the selected media. The media characteristics determine the necessary filter area, dose volumes, and dosing frequency. Availability of media for a specific application should be determined before completing the detailed design. Typical specifications, mass loadings, and media depths are presented in table 1. The sand or gravel selected should be durable with rounded grains. Only washed material should be used. Fine particles passing the U.S. No. 200 sieve (less than 0.074 mm) should be limited to less than 3 percent by weight. Other granular media that have been used are bottom ash, expanded clay, expanded shale, and crushed glass. These media should remove BOD and TSS similar to sand and gravel for similar effective sizes, uniformity, and grain shape. Newer commercial media such as textile materials have had limited testing, but based on early testing should be expected to perform as well as the above types.

Traditionally, sand filters have been designed based on hydraulic loadings. However, since these filters are primarily aerobic biological treatment units, it is more appropriate that they be designed based on organic loadings. Unfortunately, insufficient data exist to establish well-defined organic loading rates. Experience presently suggests that BOD<sub>5</sub> loadings on sand media should not exceed about 5 lb/1,000 ft<sup>3</sup> per day (0.024 kg/m<sup>2</sup> per day) where the effective size is near 1.0 mm and the dosing rate is at least 12 times per day.

Higher hydraulic and organic loadings have been described in several studies, but the long-term viability of the systems loaded at those higher organic loads has not yet been fully verified. The values in the table are thus considered conservative and may be subject to increases as more quality-assured data become available.

Dosing volume and frequency

have been shown to be the critical design variables. Small dose volumes are preferred because the flow through the porous media will occur under unsaturated conditions with higher moisture tensions. Better wastewater media contact and longer residence times occur under these conditions. Smaller dose volumes are achieved by increasing the number of doses per day. It has been suggested that each dose should be <0.5 cm (based on media surface perpendicular to infiltration direction) to fully nitrify the effluent in an ISF. This would limit maximum daily hydraulic loading to 12 cm/d, or 3 gpd/ft<sup>2</sup>, if the maximum frequency of daily dosing is accepted as 24 (or hourly) as supported by the literature. Media characteristics can limit the number of doses possible. Reaeration of the media must occur between doses. As the effective size of the media decreases, the time for drainage and reaeration of the media increases.

Distribution network characteristics will also limit the number of doses possible. The primary characteristics are the volume, pressure, orifice sizes, and spacing. To achieve uniform distribution over the filter surface, minimum dose volumes are necessary and can vary with the distribution method selected. Therefore, if the dose volume dictated by the distribution network design is too high, the network should be redesigned. Since the dose volume is a critical operating parameter, the method of distribution and design of the distribution system should be considered carefully.

Distribution methods used include rigid pipe pressure networks with orifices or spray nozzles, drip distribution, and surface flooding, which is no longer recommended for small ISFs (see chapter 4). Rigid pipe pressure networks are the most commonly used method. Both orifices and spray nozzles are used. The use of spray nozzles is usually limited to recirculating filters because nozzle fouling from suspended solids is less likely than with undiluted septic tank effluent. Since the minimum dose volume required to achieve uniform distribution is five times the rigid pipe volume, the filter can be divided into multiple cells that are loaded individually so the distribution networks can be smaller to reduce the dose volume needed for uniform distribution. Optimum designs minimize the dose each time the system is dosed. Drip distribution is being used increasingly because the minimum dose volumes are much less than the volumes of rigid pipe networks.

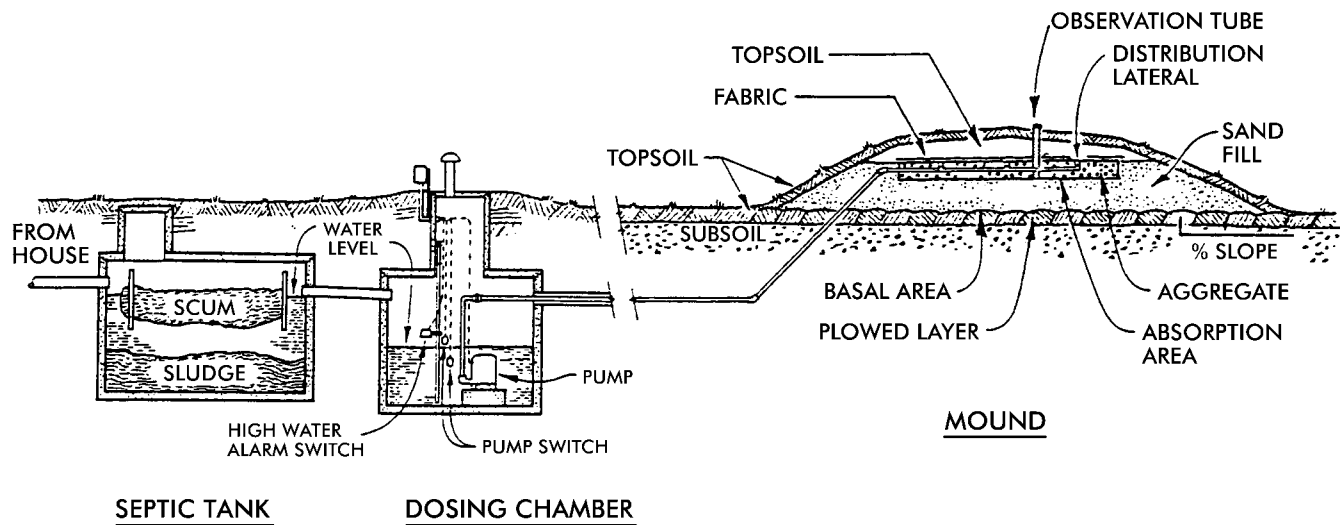
**Table 1. Specifications, mass loadings, and depth for single-pass intermittent sand filters**

Design parameter	Typical design value
<b>Material</b>	Durable, washed sand/gravel with rounded grains
<b>Specifications</b>	
Effective size	
Sand	0.25–1.00 mm
Gravel	N/A
Uniformity coefficient	< 4
Percent fines (passing 200 sieve or < 0.074 mm)	≤ 3
<b>Depth</b>	2 to 3 ft
<b>Mass loadings</b>	
Hydraulic loading <sup>a</sup>	
Sand	1–2 gpd/ft <sup>2</sup>
Gravel	N/A
Organic loading <sup>b</sup>	
Sand	5 lb BOD <sub>5</sub> /1,000ft <sup>2</sup> -d
Gravel	N/A
<b>Underdrains</b>	
Slope	0–0.1%
Size	3–4 in. dia.
<b>Dosing</b>	
Frequency	12–24 times per day
<b>Dosing tank</b>	
Volume	0.5–1.5 times design daily flow

<sup>a</sup> 1 gpd/ft<sup>2</sup> = 4 cm/day = 0.04 m<sup>3</sup>/m<sup>2</sup> per day

<sup>b</sup> 1 lb BOD/1000 ft<sup>2</sup> per day = 0.00455 kg/m<sup>2</sup> per day

Figure 2. ISF constructed in a mound with direct subsurface infiltration



Source: Converse and Tyler, 1998.

The underdrain system is placed on the floor of the tank or lined excavation. Ends of the underdrains should be brought to the surface of the filter and fitted with cleanouts that can be used to clean the biofilms underdrain, if necessary. The underdrain outlet is cut in the basin wall such that the drain invert is at the floor elevation and the filter can be completely drained. The underdrain outlet invert elevation must be sufficiently above the recirculation tank inlet to accommodate a minimum of 0.1 percent slope on the return line and any elevation losses through the flow splitting device. The underdrain (usually 1.25- to 2.0-inch PVC, class 200 [minimum]) is covered with washed, durable gravel to provide a porous medium through which the filtrate can flow to the underdrain system. The gravel should be sized to prevent the filter medium from mixing into the gravel, or a layer of 1/4- to 3/8-inch-diameter washed pea gravel should be placed over the washed underdrain gravel before the filter medium is added.

The filter basin can be a lined excavation or fabricated tank. For single-home systems, prefabricated concrete tanks are commonly used. Many single-home filters and most large filters are constructed within lined excavations. Typical liner materials are polyvinyl chloride and polypropylene. A liner thickness of 30 mil can withstand reasonable construction activities yet be relatively easy to work with. A sand layer should be placed below the liner to protect it from being punctured if the floor and walls of the excavation are stony. The walls of the excavation should be brought above the final grade to prevent entry of surface water.

Filters can be covered or buried. It is often necessary to provide a cover for the filter surface because the surface of a fine medium (e.g., sand) exposed to sunlight can be fouled with algae. Also, there may be concerns about odors, cold weather impacts, precipitation, leaf and debris accumulation, and snowmelt. In addition, the cover must provide ample fresh air venting. Reaeration of the filter medium primarily occurs from the filter surface. The lower 20 percent of the medium's depth maintains a high moisture content. At the bottom, the medium is near or at saturation, which is a barrier to air flow and venting from the underdrain system. The gravel surrounding the distribution piping must be vented to the surface to provide a fresh air flow. ISF filters open to the surface are built with roofs or removable covers or are merely shaded. Roofs provide cold weather protection and shed precipitation, debris, and snowmelt that would otherwise enter the system.

## Performance

Treatment field performance of single-pass intermittent sand filters is presented in table 2. Typical effluent concentrations for these single-family wastewater treatment systems are less than 5 mg/L and less than 10 mg/L for BOD and TSS, respectively. Effluent is nearly completely nitrified but some variability can be expected in nitrogen removal capability. Controlled studies generally find typical nitrogen removals of 18 to 33 percent with an ISF. Fecal coliform removal ranges



from 2 to 4 logs (99 to 99.99 percent). ISF fecal coliform removal is a function of hydraulic loading, with reduced removals as the loading rate increases above 1 gpm/ft<sup>2</sup> (Emerick et al., 1997). Effluent suspended solids from sand filters are typically low. The media retains the solids. Most organic solids are digested by the media over time.

**Table 2. Single-pass intermittent sand filter performance**

Reference	BOD(mg/L)		BOD(mg/L)		BOD(mg/L)		BOD(mg/L)		BOD(mg/L)	
	Influ.	Efflu.	Influ.	Efflu.	Influ.	Efflu.	Influ.	Efflu.	Influ.	Efflu.
	(% Removal)		(% Removal)		(% Removal)		(% Removal)		(% Removal)	
Cagle and Johnson, 1994 <sup>a</sup> (California)	160	2	73	16	61.8	5.9	61.8	37.4	1.14E+05	1.11E+02
	(98.75%)		(78.08%)		(90.45%)		(39.48%)		(99.90%)	
Effert et al., 1985 <sup>b</sup> (Ohio)	127	4	53	17	-	-	41.5	37.5	2.19E+05	1.60E+03
	(96.85%)		(67.92%)				(9.64%)		(99.27%)	
Ronayne et al., 1982 <sup>c</sup> (Oregon)	217	3	146	10	57.1	1.7	57.5	30.3	2.60E+05	4.07E+02
	(98.62%)		(93.15%)		(97.02%)		(47.30%)		(99.84%)	
Sievers, 1998 <sup>d</sup> (California)	297	3	44	3	37	0.5	37.1	27.5	4.56E+05	7.30E+01
	(98.99%)		(93.18%)		(98.65%)		(25.88%)		(99.98%)	

<sup>a</sup> Sand media: es = 0.25-0.65 mm; uc = 3-4. Design hydraulic loadings = 1.2 gpd/ft<sup>2</sup> based on 150 gpd/bedroom. Actual flows not measured.

<sup>b</sup> Sand media: es = 0.4 mm; uc = 2.5. Average loadings = 0.4 gpd/ft<sup>2</sup> / 0.42 lb BOD/1,000 ft<sup>2</sup>. Doses per day = 3.3.

<sup>c</sup> Sand media: es = 0.14-0.30 mm; uc = 1.5-4.0. Average loadings = 0.33 gpd/ft<sup>2</sup> / 0.6-1.27 lb BOD/1000 ft<sup>2</sup> per day.

<sup>d</sup> Sand media: not reported; uc = 3-4. Design hydraulic loadings = 1. gpd/ft<sup>2</sup>. Daily flows not reported.

## Management needs

Construction of ISF units usually involves excavation, forming/framing, liner placement with supporting sand layers, and plumbing. ISF units should never be placed in surface depressions without thoroughly sealing against prolonged inundation and drainage configurations that prevent stormwater entry. In all cases, units must be watertight with sealed entries and exits for piping. Filter fabric should not be used at any location through which the filtrate would flow. Media delivered to the site should be tested against design-sizing specifications. Excess (3 percent or greater) fines are one of the greatest concerns of the construction inspector.

The operation and maintenance requirements of packed bed filters are few and simple. As with all treatment systems, flow monitoring should be conducted to identify excessive flows and check dose volumes and dosing rates. If the flows are excessive, the source of the flows should be identified and corrective measures taken. Reduced dose volumes or dosing rates suggest that the distribution network is plugged or the pump is not performing properly. The distribution network should be flushed annually (or more often, as necessary) using the manual flushing device. Also, the dosing pump should be recalibrated at least annually.

The filter surface should not pond if the filter is designed properly and the wastewater characteristics do not change significantly. If standby cells are not available for regular resting and the surface is not covered with pea gravel, the surface can be raked to break up any material clogging the filter surface. Reducing the dose volume and increasing the dosing frequency may help to increase the reaeration potential and reduce clogging of the media. If the ponding problem persists, however, removal of the top layer or complete replacement of the media may be necessary. Before replacing the media, monitor wastewater flows and concentrations to determine if they are the cause of the problem. Problem sources should be identified and addressed before repairs are effected. Premature clogging is often traceable to excess TSS and BOD loading or to fines in the media. Where the problem develops naturally over time and standby cells are available, resting may be used to supplement the raking and/or surface skimming steps.

Free-access ISFs should be checked regularly (at least every 3 to 4 months), to prevent surface problems. Periodic raking and resting is recommended to maintain percolation and prevent ponding. Scraping off the top layer (e.g., 1 inch) of sand helps to prevent clogging. Intervals between scraping vary from a minimum of 3 months up to greater than 1 year. Removed surface layers need not be replaced until the total filter depth falls below 18 inches. If new filter material is not

readily available, it may be cost-effective to clean and reuse the old filter material. Resting is considered the best rehabilitation approach due to possible clogging contributions from raking/scraping.

ISFs have low energy requirements compared with other systems offering comparable effluent quality. Free-access ISFs using pumped dosing would require approximately 0.3 to 0.4 kWh/day.

## Risk management issues

ISF filters are simple in design and relatively passive to operate because the fixed-film process is very stable and few mechanical components are used. High flow variations after equalization in a septic tank are not a problem because the residual peaks and valleys are absorbed in the pressurization tank or in the last compartment of the preceding septic tank. Although ISFs have biological properties, the impact of toxic loading shocks are not well documented.

Free-access ISFs are often installed with removable covers to regulate temperatures in cold climates and to reduce odors. Space of 12 to 24 inches (30 to 61 cm) should be allotted between the sand surface and the installed cover (EPA, 1980). Odors from free-access filters treating septic tank effluent may warrant installation away from dwellings, especially if spray nozzles are used in distribution.

Power outages will impact ISF systems if these systems are uniformly dosed with pumps. During the power outage, all wastewater generated will accumulate in that dosing facility and septic tank, increasing the potential for odors.

## Costs

Filter media is the most expensive component in ISF construction. Typically, filter media can be installed for \$10 to \$15 per square foot, depending primarily on the type of media and the contractor's experience with ISF construction. Operation/maintenance costs include electricity for pumping/dosing, and 3 to 6 hours of semiskilled management visits per year cost about \$150 to \$200. The electricity is about \$10 to \$20 of that total.

## References

- Anderson, D.L., R.L. Siegrist, and R.J. Otis. 1985. *Technology Assessment of Intermittent Sand Filters*. U.S. Environmental Protection Agency, Office of Research and Development and Office of Water, Washington, DC.
- Bauer, D.H., E.T. Conrad, and D.G. Sherman. 1979. *Evaluations of Existing and Potential Technologies for Onsite Wastewater Treatment and Disposal*. EPA/600/S2-81-178. U.S. Environmental Protection Agency, Office of Research and Development, Cincinnati, OH.
- Boller, M., A. Schwager, J. Eugster, and V. Mottier. 1993. Dynamic Behavior of Intermittent Buried Filters. In *Small Wastewater Treatment Plants*, ed., H. Odegaard, TAPIR, Trondheim, Norway.
- Cagle, W.A., and L.A. Johnson. 1994. On-site intermittent sand filter systems: a regulatory/scientific approach to their study in Placer County, California. In *Proceedings of the Seventh Onsite Wastewater Treatment Symposium*, American Society of Agricultural Engineers, St. Joseph, MI.
- Darby, J., G. Tchobanoglous, M. Asri Nor, and D. Maciolek. 1996. *Small Flows Journal* 2(31): 3-15.
- Effert, D., J. Morand, and M. Cashell. 1985. Field performance of three onsite effluent polishing units. In *Proceedings of Fourth Onsite Wastewater Treatment Symposium*, American Society of Agricultural Engineers, St. Joseph, MI.
- Emerick, R.W., R.M. Test, G. Tchobanoglous, and J. Darby. 1997. *Small Flows Journal* 3(1):12-22.
- National Small Flows Clearinghouse. 1998. *Intermittent Sand Filters*. NSFC Fact Sheet for U.S. Environmental Protection Agency, Office of Water, Washington, DC.
- Oreco Systems, Inc. 1993. *Cost Estimating for STEP Systems and Sand Filters*. Oreco Systems, Inc., Roseburg, OR.

- Rhode Island Department of Environmental Management (DEM). 2000. *Sand Filter Guidance Document*. Department of Environmental Management, Providence, RI.
- Ronayne, M.P., R.C. Paeth, and S.A. Wilson. 1982. *Oregon On-site Experimental Systems Program*. Final report to U.S. Environmental Protection Agency, Office of Research and Development, Cincinnati, OH.
- Sievers, D.M. 1998. Pressurized intermittent sand filter with shallow disposal field for a single residue in Boone County, MO. In *Proceedings of the Eighth On-site Wastewater Treatment Symposium*. American Society of Agricultural Engineers, St. Joseph, MI.





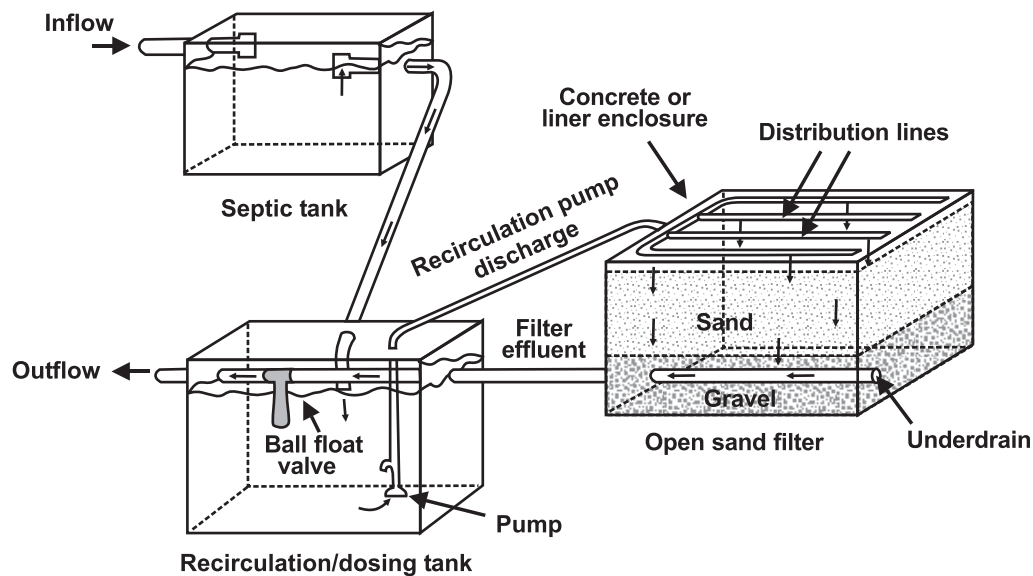
# Onsite Wastewater Treatment Systems Technology Fact Sheet 11

## Recirculating Sand/Media Filters

### Description

Recirculating filters using sand, gravel, or other media provide advanced secondary treatment of settled wastewater or septic tank effluent. They consist of a lined (e.g., impervious PVC liner on sand bedding) excavation or structure filled with uniform washed sand that is placed over an underdrain system (see figure 1). The wastewater is dosed onto the surface of the sand through a distribution network and allowed to percolate through the sand to the underdrain system. The underdrain system collects and recycles the filter effluent to the recirculation tank for further processing or discharge.

Figure 1. Typical recirculating sand filter system



Recirculating sand filters (RSFs) are aerobic, fixed-film bioreactors. Other treatment mechanisms that occur in sand filters include physical processes, such as straining and sedimentation, that remove suspended solids within the pores of the media. Also, chemical sorption of pollutants onto media surfaces plays a finite role in the removal of some chemical (e.g., phosphorus) constituents. Bioslimes from the growth of microorganisms develop as films on the sand particle surfaces. The microorganisms in the slimes absorb soluble and colloidal waste materials in the wastewater as it percolates over the sand surfaces. The absorbed materials are incorporated into a new cell mass or degraded under aerobic conditions to carbon dioxide and water.

Most biochemical treatment occurs within approximately 6 inches of the filter surface. As the wastewater percolates through this layer, suspended solids and carbonaceous biochemical oxygen demand (BOD) are removed. Most suspended solids are strained out at the filter surface. The BOD is nearly completely removed if the wastewater retention time in the sand media is sufficiently long for the microorganisms to absorb waste constituents. With depleting carbonaceous BOD in



the percolating wastewater, nitrifying microorganisms are able to thrive deeper in the surface layer, where nitrification will readily occur.

Chemical adsorption can occur throughout the media bed. Adsorption sites in the media are usually limited, however. The capacity of the media to retain ions depends on the target constituent, the pH, and the mineralogy of the media. Phosphorus is one element of concern that can be removed from wastewater in this manner, but the number of available adsorption sites is limited by the characteristics of the media.

The basic components of recirculating filters include a recirculation/dosing tank, pump and controls, distribution network, filter bed with an underdrain system, and a return line. The return line or the underdrain must split the flow to recycle a portion of the filtrate to the recirculation/dosing tank. A small volume of wastewater and filtrate is dosed to the filter surface on a timed cycle 1 to 3 times per hour. Recirculation ratios are typically between 3:1 and 5:1. In the recirculation tank, the returned aerobic filtrate mixes with the anaerobic septic tank effluent before being reapplied to the filter.

Recirculating filters must use a coarser media than single-pass filters because recirculation requires higher hydraulic loadings. Both coarse sand and fine gravel are used as filter media. Because of the high hydraulic conductivities of the coarse media, filtrate recirculation is used to provide the wastewater residence times in the media necessary to meet the treatment requirements. Based on forward flow, daily hydraulic loadings are typically about 3 gpd/ft<sup>2</sup> (2 to 5 gpd/ft<sup>2</sup>) when the filter media is coarse sand. Therefore, the corresponding combined daily filter hydraulic loading, including the recirculated flow, may be 6 to 25 gpd/ft<sup>2</sup>. Where gravel is used as the media, the daily hydraulic loadings are increased to as much as 10 to 15 gpd/ft<sup>2</sup> with a combined daily loading of 30 to 75 gpd/ft<sup>2</sup>. BOD and TSS removals are generally the same as those achieved by single-pass filters. Nearly complete ammonia removal by nitrification is also achieved. In addition, the mixing of the return filtrate anaerobic septic tank effluent removes approximately 50 percent of the total nitrogen. However, because of the greater hydraulic loadings and coarser media, fecal coliform removal is somewhat less than in single-pass filters.

Recirculating filters offer advantages over single-pass filters. Greater control of performance is possible because recirculation ratios can be changed to optimize treatment. The filter can be smaller because of the higher hydraulic loading. Recirculation also reduces odors because the influent wastewater (septic tank effluent) is diluted with return filtrate that is low in BOD and high in dissolved oxygen.

Many types of media are used in packed-bed filters. Washed, graded sand was the most common, but pea gravel has generally replaced it in recent times. Other granular media used include crushed glass, garnet, anthracite, plastic, expanded clay, expanded shale, open-cell foam, extruded polystyrene, and bottom ash from coal-fired power plants. Coarse-fiber synthetic textile materials are also used. These materials are generally restricted to proprietary units. Contact the system manufacturers for application and design using these materials.

Other modifications to the basic RSF design include the type of distribution system, the location and design of the recirculation tank, the means of flow splitting the filtrate between discharge and return flows, and enhancements to improve nitrogen removal. The last is addressed in Technology Fact Sheet 9 on nitrogen removal.

## Applications

Recirculating sand filters can be used for a broad range of applications, including single-family residences, large commercial establishments, and small communities. They are frequently used to pretreat wastewater prior to subsurface infiltration on sites where soil has insufficient unsaturated depth above ground water or bedrock to achieve adequate treatment. They are also used to meet water quality requirements before direct discharge to a surface water. RSFs are primarily used to treat domestic wastewater, but they have also been used successfully in treatment trains to treat wastewaters high in organic materials such as those from restaurants and supermarkets. Single-pass filters are most frequently used for smaller applications and at sites where nitrogen removal is not required. Recirculating filters are used for both large and small flows and are frequently used where nitrogen removal is necessary. RSFs frequently replace aerobic package plants in many parts of the country because of their high reliability and lower O/M requirements.

## Design

Packed-bed filter design starts with the selected media. The media characteristics determine the necessary filter area, dose volumes, and dosing frequency. Availability of media for a specific application should be determined before completing the detailed design. Typical specifications, mass loadings, and depths for sand and gravel media are presented in chapter 4. The sand or gravel selected should be durable with rounded grains. Only washed material should be used. Fine particles passing the U.S. No. 200 sieve (<0.074 mm) should be limited to less than 3 percent by weight. Other granular media are bottom ash, expanded clay, expanded shale, and crushed glass. These media should perform similarly to sand and gravel for similar effective sizes, uniformity, and grain shape. Newer commercial media such as textile materials have had limited testing, but should be expected to perform as well as the above types.

Traditionally, media filters have been designed based on hydraulic loadings. However, since they are primarily aerobic biological treatment units, it is more appropriate that they be designed based on organic loadings. Unfortunately, insufficient data exist to establish well-defined organic loading rates. Experience suggests that BOD<sub>5</sub> loadings on sand media should not exceed about 5 lb/1000 ft<sup>2</sup> per day (0.024 kg/m<sup>2</sup> per day) where the effective size is approximately 1.0 mm and the dosing rate is at least 12 times per day. Higher loadings have been measured in short-term studies, but designers are cautioned about exceeding this loading rate until quality-assured data confirm these higher levels. The BOD<sub>5</sub> loading should decrease with decreasing effective size of the sand. Because of the larger pore size and greater permeability, gravel filters can be loaded more heavily. BOD<sub>5</sub> loadings of 20 lb/1000 ft<sup>2</sup> per day (0.10 kg/m<sup>2</sup> per day) have been consistently successful, but again higher loadings have been measured. Some often-quoted design specifications for RSFs are given in table 1.

**Table 1. Typical design specifications for individual home recirculating sand filters**

Design parameter	Typical design value
<b>Median</b>	Durable, washed sand/gravel with rounded grains
<b>Specifications</b>	
Effective size	
Sand	1.0 – 5.0 mm
Gravel	3.0 – 20.0 mm
Uniformity coefficient	< 2.5
Percent fines (passing 200 sieve or < 0.074 mm)	≤ 3
<b>Depth</b>	24 in. (18 to 36 in.)
<b>Mass loadings</b>	
Hydraulic loading <sup>1</sup>	
Sand	3 -5 gpd/ft <sup>2</sup>
Gravel	10 –15 gpd/ft <sup>2</sup>
Organic loading <sup>2</sup>	
Sand	≤ 5 lb BOD <sub>5</sub> /1000ft <sup>2</sup> -d
Gravel	≤ 15 lb BOD <sub>5</sub> /1000ft <sup>2</sup> -d
<b>Underdrains</b>	
Type	Slotted or perforated pipe
Slope	0 – 0.1%
Transition bedding	0.6 – 1.0 cm washed pea gravel
Size	0.6 – 4.0 cm washed gravel or crushed stone
<b>Dosing</b>	
Frequency	48 times/day (every 30 min.) or more
Per Dose	1 to 2 gal./orifice
<b>Recirculation tank</b>	
Volume	1.5 times design daily flow
Recirculation rate	3 to 5 times daily flow

<sup>a</sup> 1 gpd/ft<sup>2</sup> = 4 cm/day = 0.04 m<sup>3</sup> / m<sup>2</sup> per day (forward flow only).

<sup>b</sup> 1 lb BOD/1,000 ft<sup>2</sup> per day = 0.00455 kg/m<sup>2</sup> per day.

The RSF dose volume depends on the recirculation ratio, dosing frequency, and distribution network:

$$\text{Dose Volume} = \text{Design Flow (gpd)} \times (\text{Recirculation Ratio} + 1) \div \text{Number of Doses/Day}$$

Small dose volumes are preferred because the flow through the porous media will occur under unsaturated conditions with higher moisture tensions. Better wastewater media contact and longer residence times occur under these conditions. Smaller dose volumes are achieved by increasing the number of doses per day.

The recirculation ratio increases the hydraulic loading without increasing the organic loading. For example, a 4:1 recirculation ratio results in a hydraulic loading of five times the design flow (1 part forward flow to 4 parts recycled flow). The increased hydraulic loading reduces the residence time in the filter so that recirculation is necessary to achieve the desired treatment. Typical recirculation ratios range from 3:1 to 5:1. As the permeability of the media increases, the recirculation ratio may need to increase to achieve the same level of treatment.

Media characteristics can limit the number of doses possible. Media reaeration must occur between doses. As the effective size of the media decreases, the time for drainage and reaeration of the media increases. For single pass filters, typical dosing frequencies are once per hour (24 times/day) or less. Recirculating sand filters dose 2 to 3 times per hour (48 to 72 times/day).

Distribution network requirements will also limit the number of doses possible. To achieve uniform distribution over the filter surface, minimum dose volumes are necessary and can vary with the distribution method selected. Therefore, if the dose volume dictated by the distribution network design is too high, the network should be redesigned. Since the dose volume is a critical operating parameter, the method of distribution and the distribution system design should be considered carefully.

Distribution methods used include rigid pipe pressure networks with orifices or spray nozzles, and drip emitters. Rigid pipe pressure networks are the most commonly used method. Orifices with orifice shields, facing upward, minimize hole blockage by stones. Since the minimum dose volume required to achieve uniform distribution is five times the pipe volume, large multihome filters are usually divided into multiple cells. Drip emitter distribution is being used increasingly because the minimum dose volumes are much less than the rigid pipe network volumes.

Recirculation tanks are a component of most recirculation filter systems. These tanks consist of a tank, recirculation pump and controls, and a return filter water flow splitting device. The flow splitting device may or may not be an integral part of the recirculation tank. Recirculation tanks store return filtrate, mix the filtrate with the septic tank effluent, and store peak influent flows. The tanks are designed to either remain full or be pumped down during periods of low wastewater flows. Since doses to the recirculating filter are of a constant volume and occur at timed intervals, the water level in the tank will rise and fall in response to septic tank effluent flow, return filtrate flow, and filter dosing.

In tanks designed to remain full, all filtrate is returned to the recirculation tank to refill the tank after each dosing event. When the tank reaches its normal full level, the remaining return filtrate is discharged out of the system as effluent. This design is best suited where treatment performance must be maintained continuously. For single-family home systems, the recirculation tank is typically sized to be equal to 1.5 times the design peak daily flow.

When the filtrate flow is continuously split between the return (to the recirculation tank) and the discharge, the liquid volume in the recirculation tank will vary depending on wastewater flows. During low flow periods the tank can be pumped down to the point that the low-water pump off switch is activated. This method leaves less return filtrate available to mix with the influent flow. While simple, this method of flow splitting can impair treatment performance because minimum recirculation ratios cannot be maintained. This is less of a disadvantage, however, for large, more continuous flows typical in small communities or large cluster systems.

The recirculation pump and controls are designed to dose a constant volume of mixed filtrate and septic tank effluent flow onto the filter on a timed cycle. The pump must be sized to provide the necessary dosing rate at the operating discharge head required by the distribution system. Pump operation is controlled by timers that can be set for pump time on and pump time off. A redundant pump-off float switch is installed in the recirculation tank below the minimum dose volume level. A high water alarm is also installed to provide notice of high water caused by pump failure, loss of pump calibration, or excessive influent flows.

## Recirculation tank sizing

In many types of commercial systems, daily flow variations can be extreme. In such systems, the recycle ratios necessary to achieve the desired treatment may not be maintained unless the recirculation tank is sized properly. During prolonged periods of high influent flows, the recirculation ratio can be reduced to the point that treatment performance is not maintained unless the recirculation tank is sized to provide a sufficient reservoir of recycled filtrate to mix with the influent during the high-flow periods.

To size the tank appropriately for the application, assess the water balance for the recirculation tank using the following procedure:

1. Select the dosing frequency based on the wastewater strength and selected media characteristics.
2. Calculate the dose volume based on the average daily flow:

$$V_{\text{dose}} = [(\text{recycle ratio} + 1) \times Q_{\text{ave. daily}}] \div (\text{doses/day})$$

$$Q_{\text{dose}} = V_{\text{dose}} \div (\text{dose period})$$

Where V and Q are the flow volume and flow rate, respectively.

3. Adjust the dose volume if the calculated volume is less than the required minimum dose volume for the distribution network.
4. Estimate the volumes and duration of influent peak flows that are expected to occur from the establishment.
5. Calculate the necessary recirculation tank "working" volume by performing a water balance around the recirculation tank for the peak flow period with the greatest average flow rate during that peak period.

$$\text{Inputs} = Q_{\text{inf.}} \times T + Q_{\text{recycle}} \times T = Q_{\text{inf.}} \times T + (Q_{\text{dose}} - Q_{\text{eff.}}) \times T = V_{\text{inf.}} + V_{\text{recycle}}$$

$$\text{Outputs} = V_{\text{dose}} \times (T \div \text{dose cycle time})$$

Where T is the peak flow period duration.

If the inputs are greater than the outputs, then  $Q_{\text{eff.}} = Q_{\text{dose}}$  and the peaks are stored in the available freeboard space of the recirculation tank. If the inputs are less than the outputs, then  $Q_{\text{eff.}} = Q_{\text{inf.}}$

To provide the necessary recycle ratio, sufficient filtrate must be available to mix with the influent septic tank effluent. The filtrate is provided by the return filtrate flow and the filtrate already in the recirculation tank.

$$\text{Recycle ratio} \times Q_{\text{inf.}} \times T \leq Q_{\text{recycle}} \times T + \text{minimum tank working volume}$$

$$\text{Where minimum tank working volume} = \text{Recycle ratio} \times (Q_{\text{inf.}} - Q_{\text{recycle}}) \times T$$

6. Calculate the necessary freeboard volume for storage of peak flows when the influent volume is greater than the dosing volume during the peak flow period.

$$\text{Freeboard volume} = Q_{\text{inf.}} \times T + Q_{\text{recycle}} \times T - Q_{\text{dose}} \times T$$

$$= Q_{\text{inf.}} \times T (Q_{\text{dose}} - Q_{\text{eff.}}) - Q_{\text{dose}} \times T$$

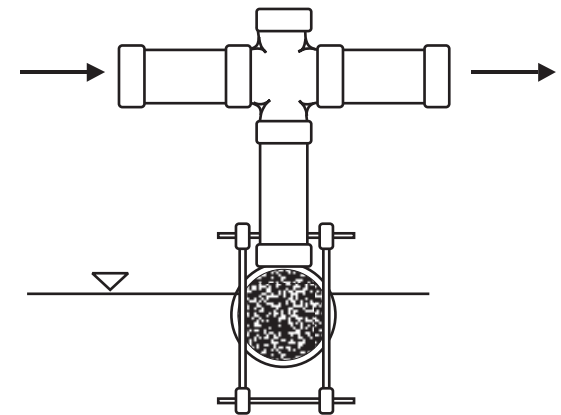
7. Calculate the minimum total recirculation volume.

$$\text{Total tank volume} = \text{minimum tank working volume} + \text{freeboard volume}$$

(Adapted from Ayres Associates, 1998.)

Several flow splitting devices may be used. The most common are ball float valves and proportional splitters. The ball float valve is used where the recirculation tank is designed to remain full. The valve is connected to the return filtrate line inside the recirculation tank (see figure 2). The return line runs through the tank. The ball float valve is open when the water level is below the normally full level. When the tank fills from either the return filtrate or the influent flow, the ball float rises to close the valve, and the remaining filtrate is discharged from the system. The proportional splitters continuously divide the flow between return filtrate and the filtrate effluent (see figure 3). Another type of splitter consists of a sump in which two pipes are stubbed into the bottom with their ends capped. In the crowns of each capped line, a series of equal-sized, pluggable holes are drilled. The return filtrate floods the sump, and the flow is split in proportion to the relative number of holes left open in each perforated capped pipe.

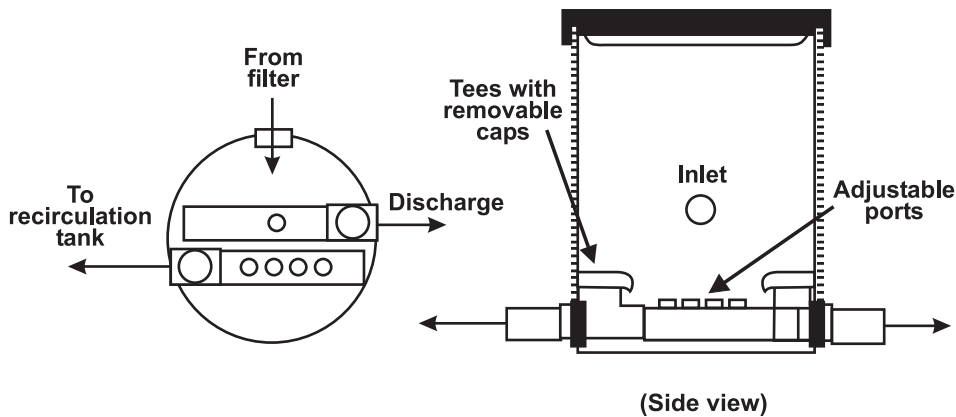
**Figure 2. Flow splitter operated by a float ball valve**



Another type of splitter divides flow inside the filter. The filter floor is raised so that it slopes in opposite directions. The raised point is located so that the ratio of the floor areas on either side is in proportion to the desired recirculation ratio. Each side has its own underdrain. One side drains back to the recirculation tank, the other side drains to discharge. This method has the disadvantage that adjustments to the recirculation ratio cannot easily be made.

Most RSFs are constructed aboveground and with an open filter surface; however, in cold climates, they can be placed in

**Figure 3. Splitter basin**



the ground to prevent freezing. Placing a cover over an RSF is recommended to reduce odors and to provide insulation in cold climates, although no freezing was observed in an open RSF in Canada using coarse gravel media. Covers must provide ample fresh air venting, because reaeration of the filter media occurs primarily from the filter surface.

The filter basin can be a lined excavation or fabricated tank. For single-home systems, prefabricated concrete tanks are com-

monly used. Many single-home filters and most large filters are constructed within lined excavations. Typical liner materials are polyvinyl chloride and polypropylene. A liner thickness of 30 mil can withstand reasonable construction activities yet be relatively easy to work with. A sand layer should be placed below the liner to protect it from puncturing if the floor and walls of the excavation are stony. The excavation walls should be brought above the final grade to prevent entry of surface water. It is often necessary to cover the filter surface to reduce the effects of algae fouling, odors, cold weather impacts, precipitation, and snow melt. The cover must provide ample fresh air venting, however. Reaeration of the filter media primarily occurs from the filter surface.

The underdrain system is placed on the floor of the tank or lined excavation (figure 4). Ends of the underdrains should be brought to the surface of the filter and fitted with cleanouts that can be used to clean the underdrains of biofilms if necessary. The underdrain outlet is cut in the basin wall such that the drain invert is at the floor elevation and the filter can be completely drained. The underdrain outlet invert elevation must be sufficiently above the recirculation tank inlet to accommodate a minimum of 0.1 percent slope on the return line and any elevation losses through the flow splitting device. The underdrain is covered with washed, durable gravel to provide a porous medium through which the filtrate can flow to



the underdrain system. The gravel should be sized to prevent the filter media from mixing into the gravel, or a layer of 1/4- to 3/8-inch-diameter gravel should be placed over the underdrain gravel before the filter media is added.

## Performance

RSF systems are extremely effective and reliable in removing BOD, TSS, and contaminants that associate with the particulate fraction of the incoming septic tank effluent. Some typical performance data are provided in table 2.

Normally, BOD and TSS effluent concentrations are less than 10 mg/L when RSF systems are treating residential wastewater. Nitrification tends to be complete, except in severely cold conditions. Natural denitrification in the recirculating tank results in 40 to 60 percent removal of total nitrogen (TN). Fecal coliform removal is normally 2 to 3 logs (99 to 99.9 percent). Phosphorus removal drops off from high percentages to about 20 to 30 percent after the exchange capacity of the media becomes exhausted. Some media and media mixes have very high iron and/or aluminum content that extends the initial period of high phosphorus removal. (See Enhanced Nutrient Removal—Phosphorus, Technology Fact Sheet 8.)

Figure 4. Typical underdrain detail.

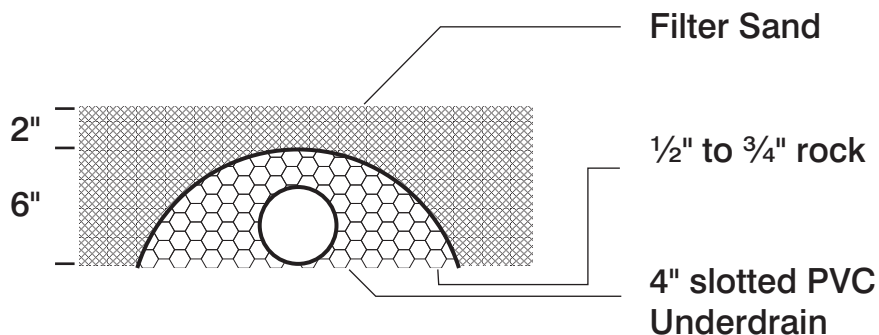


Table 2. Recirculating filter performance

Reference	BOD (mg/L)		TSS (mg/L)		TKN (mg-N/L)		TN (mg-N/L)		Fecal Coliform (#/100mL)	
	Influ.	Efflu. (% Removal)	Influ.	Efflu. (% Removal)	Influ.	Efflu. (% Removal)	Influ.	Efflu. (% Removal)	Influ.	Efflu. (% Removal)
Louden et al., 1985 <sup>a</sup> (Michigan)	150	6 (96.00%)	42	6 (85.71%)	55	2.3 (95.82%)	55	26 (52.73%)	3.40E+03	1.40E+01 (99.59%)
Piluk and Peters, 1994 <sup>b</sup> (Maryland)	235	5 (97.87%)	75	8 (89.33%)	Not reported		57	20 (64.91%)	1.80E+06	9.20E+03 (99.49%)
Ronayne, et al., 1982 <sup>c</sup> (Oregon)	217	3 (98.62%)	146	4 (97.26%)	57.1	1.1 (98.07%)	57.5	31.5 (45.22%)	2.60E+05	8.50E+03 (96.73%)
Roy and Dube, 1994 <sup>d</sup> (Quebec)	101	6 (94.06%)	77	3 (96.10%)	37.7	7.9 (79.05%)	37.7	20.1 (46.68%)	4.80E+05	1.30E+04 (97.29%)
Ayres Assoc., 1998 <sup>e</sup> (Wisconsin)	601	10 (98.34%)	46	9 (98.35%)	65.9	3 (95.45%)	65.9	16 (75.72%)	> 2500	6.20E+01 (> 98%)
Owen and Bobb, 1994 <sup>f</sup> (Wisconsin)	80	8 (90.00%)	36	6 (83.33%)	-	- (> 95%)	Not reported		Not reported	

<sup>a</sup>Single-family home filters. Sand media: es = 0.3 mm; uc = 4.0. Average loadings = 0.9 gpd/ft<sup>2</sup> (forward flow) / 1.13 lb BOD/1,000 ft<sup>2</sup> -day. Recirculation ratio = 3:1. Dosed 4-6 times per hour. Open surface.

<sup>b</sup>Single-family home filters. Sand media: es = 1 mm; uc = <2.5. Design hydraulic loadings = 3.54 gpd/ft<sup>2</sup> (forward flow). Actual flow not measured. Recirculation ratio = 3:1. Doses per day = 24.

<sup>c</sup>Single-family home filters. Sand media: es = 1.2 mm; uc = 2.0. Maximum hydraulic loading (forward flow) = 3.1 gpd/ft<sup>2</sup>. Recirculation ratio = 3:1-4:1. Doses per day = 48.

<sup>d</sup>Single-family home filters. Gravel media: es = 4.0 mm; uc = <2/5. Design hydraulic loading (forward flow) = 23.4 gpd/ft<sup>2</sup>. Recirculation ratio = 5:1. Doses per day = 48. Open surface, winter operation.

<sup>e</sup>Restaurant (grease and oil inf./eff. = 119/<1 mg/L, respectively). Gravel media: pea gravel (3/8 in. dia.) Design hydraulic loading (forward flow) = 15 gpd/ft<sup>2</sup>. Recirculation ratio = 3:1-5:1. Doses per day = 72. Open surface, seasonal operation.

<sup>f</sup>Small community treating average 15,000 gpd of septic tank effluent. Sand media: es = 1.5 mm; uc = 4.5. Design hydraulic loading (forward flow) = 2.74 gpd/ft<sup>2</sup>. Recirculation ratio = 1:1-4:1. Open surface, winter operation.

## Management needs

As with all treatment systems, the RSF should be constructed carefully according to design specifications using corrosion-resistant materials. Every truckload of media delivered to the site should be tested for compliance with the specifications. All tanks and lined basins, including the entry and exit plumbing locations, must be watertight.

Inspection and operation/maintenance (O/M) needs are primarily related to inspection and calibration of the recirculation pump and controls. For sand media units, frequent removal of vegetation and scraping of the surface are required. Regular maintenance tasks include periodic checks on the pressure head at the end of the distribution system, draining of the accumulated solids from lines, and occasional brushing of the lines (at least once per year), with bottle brushes attached to a plumber's snake.

The recirculation tank should be checked for sludge accumulation on each visit and pumped as necessary (usually one to three times per year).

## Risk management issues

RSFs are extremely reliable treatment devices and are quite resistant to flow variations. Toxic shocks are detrimental to RSF treatment performance because of the resistance of biofilms to upset and the extended period of contact between biofilms and wastewater.

Gravel RSFs (or RGFs) are likely viable throughout the United States when proper precautions (e.g., covering, insulation) are taken. These systems perform best in warmer climates, but they increase opportunities for odor problems. In general, gravel RSF systems are far less prone to odor production than ISFs. Increased recycle ratios should help minimize such problems. However, power outages will stop the process from treating the wastewater, and prolonged outages would be likely to generate some odors.

## Costs

Construction costs for recirculating sand filters are driven by treatment media costs, the recirculating tank and pump/control system costs, and containment costs. Total costs are therefore site specific, but tend to vary from \$8,000 to \$11,000. Low-cost alternative media can reduce this figure significantly.

Power costs for pumping at 3 to 4 kWh/day are in the range of \$90 to \$120 per year, and management costs for monthly visits/inspections by semiskilled personnel typically cost \$150 to \$200 annually.

## References

- Anderson, D.L., R.L. Siegrist, and R.J. Otis. 1985. *Technology Assessment of Intermittent Sand Filters*. U.S. Environmental Protection Agency, Office of Research and Development, and Office of Water, Publication, Washington, DC.
- Ayres Associates. 1997. *Florida Keys Wastewater Nutrient Reduction Systems Demo Project: Second Quarter Report*. Florida Department of Health, Tallahassee, FL.
- Ayres Associates. 1998. Unpublished data from Wisconsin.
- Bruen, M.G., and R.J. Piluk. 1994. Performance and Costs of Onsite Recirculating Sand Filters. In *Proceedings of the Seventh On-site Wastewater Treatment Symposium*. American Society of Agricultural Engineers, St. Joseph, MI.
- Kerri, K.D., and J. Brady. 1997. *Small Wastewater System Operation and Maintenance: Vol. 1*. California State University, Sacramento, CA.

- Louden, T.L., D.B. Thompson, L. Fay, and L.E. Reese. 1985. Cold-Climate Performance of Recirculating Sand Filters. In *Proceedings of the Fourth On-site Wastewater Treatment Symposium*. American Society of Agricultural Engineers, St. Joseph, MI.
- National Small Flows Clearinghouse. 1998. *Recirculating Sand Filters*. U.S. Environmental Protection Agency, Office of Water, Washington, DC.
- Orenco Systems, Inc. 1993. *Cost Estimating for STEP Systems and Sand Filters*. Orenco Systems, Inc., Roseburg, OR.
- Owen, J.E., and K.L. Bobb. 1994. Winter Operation and Performance of a Recirculating Sand Filter. In *Proceedings of the WEFTEC 67th Annual Conference*. Water Environment Federation, Alexandria, VA.
- Piluk, R.J., and E.C. Peters. 1994. Small Recirculating Sand Filters for Individuals Homes. In *Proceedings of the Seventh On-site Wastewater Treatment Symposium*. American Society of Agricultural Engineers, Joseph, MI.
- Rhode Island Department of Environmental Management. 2000. *Sand Filter Guidance Document*. Rhode Island Department of Environmental Management, Providence, RI.
- Roy, C., and J.P. Dube. 1994. A Recirculating Gravel Filter for Cold Climates. In *Proceedings of the Seventh On-site Wastewater Systems Symposium*. American Society of Agricultural Engineers, St. Joseph, MI.





# Onsite Wastewater Treatment Systems Technology Fact Sheet 12

## Land Treatment Systems

### Description

Land (surface) treatment systems (figures 1 and 2) are permitted in some states, but are not widely used because of their large land area requirements exacerbated by code-required setbacks. For example, a spray irrigation system requires about four times the area of an individual home lagoon. When these systems are used, large buffer areas and fencing may be required to ensure minimal human exposure. Also, given the nature of these systems, all requirements include disinfection and significant pretreatment before application. In wet and cold areas, an additional basin for storage or a larger dosing

Figure 1. Conceptual schematic of spray irrigation system

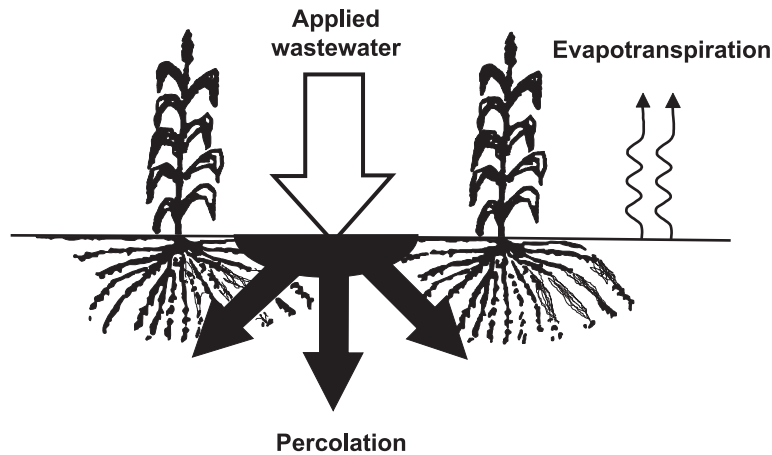
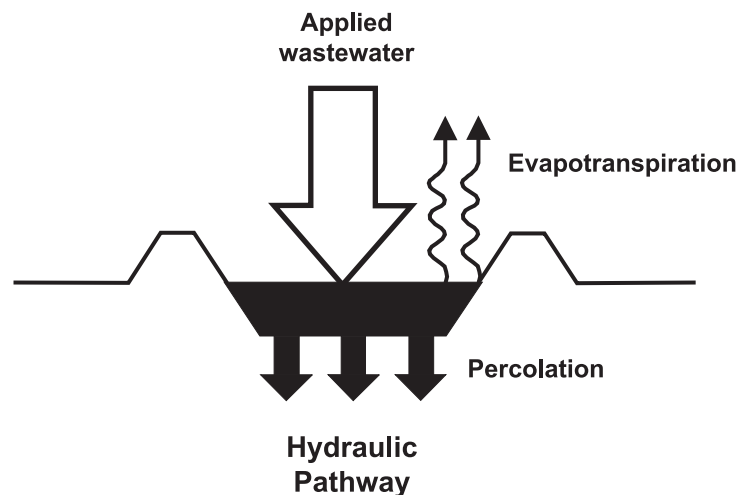
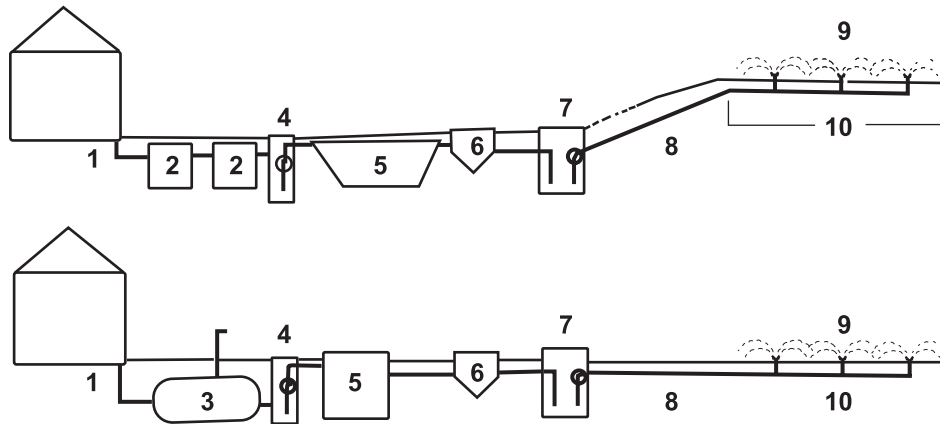


Figure 2. Conceptual schematic of rapid infiltration system





**Figure 3. Typical residential spray irrigation systems**



1. House sewer; 2. Septic tank (two required); 3. Aerobic unit; 4. Dosing tank; 5. Sand filter; 6. Cl<sub>2</sub> disinfection (or UV); 7. Tank and pump (plus storage); 8. Piping system; 9. Sprinklers; 10. Application site

Source: Adapted from McIntyre et al., 1994.

tank is necessary to eliminate possible runoff from the application area. The most used variation of these systems is the spray irrigation system (figure 3).

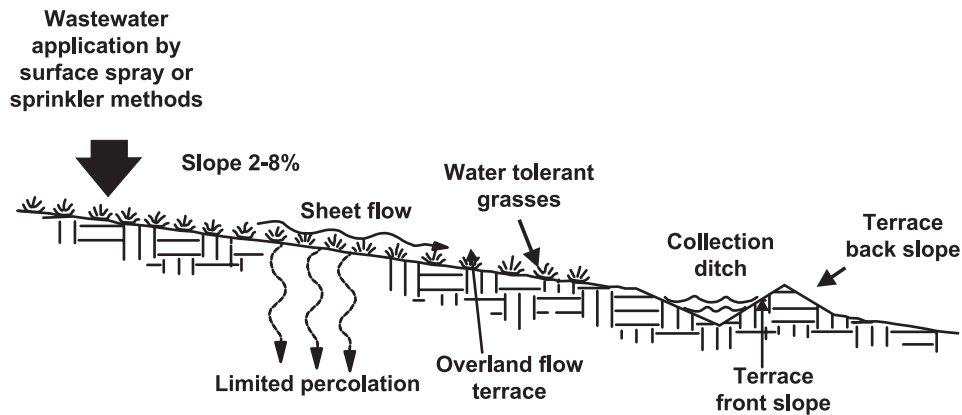
Spray irrigation systems distribute wastewater evenly on a vegetated plot for final treatment and discharge. Spray irrigation can be useful in areas where conventional onsite wastewater systems are unsuitable due to low soil permeability, shallow water depth table or impermeable layer, or complex site topography. Spray irrigation is not often used for residential onsite systems because of its large areal demands, the need to discontinue spraying during extended periods of cold weather, and the high potential for human contact with the wastewater during spraying. Spray irrigation systems are among the most land-intensive disposal systems. Drifting aerosols from spray heads can be a nuisance and must be monitored for impact on nearby land use and potential human contact. Buffer zones for residential systems must often be as large as, or even larger than, the spray field itself to minimize problems.

In a spray irrigation system, pretreatment of the wastewater is normally provided by a septic tank (primary clarifier) and aerobic unit, as well as a sand (media) filter and disinfection unit. Some states do not require the aerobic unit if the filter is used. The pretreated wastewater in spray irrigation systems is applied at low rates to grassy or wooded areas. Vegetation and soil microorganisms metabolize most nutrients and organic compounds in the wastewater during percolation through the first several inches of soil. The cleaned water is then absorbed by deep-rooted vegetation, or it passes through the soil to the ground water.

Rapid infiltration (RI) is a soil-based treatment method in which pretreated (clarified) wastewater is applied intermittently to a shallow earthen basin with exposed soil surfaces. It is only used where permeable soils, which generally can accept a conventional OWTS, are available. Because loading rates are high, most wastewater infiltrates the subsoil with minimal losses to evaporation. Treatment occurs within the soil before the wastewater reaches the ground water. The RI alternative is rarely used for onsite wastewater management. It is more widely used as a small-community wastewater treatment system in the United States and around the world.

The third and last type of land surface treatment is the overland flow (OF) process. In this system, pretreated wastewater is spread along a contour at the top of a gently sloping site that has minimum permeability. The wastewater then flows down the slope and is treated by microorganisms attached to vegetation as it travels by sheet flow over very impermeable soils until it is collected at the bottom of the slope for discharge. This system (figure 4) requires land areas similar to the spray

Figure 4. Overland flow system schematic



irrigation system. However, surface water discharge requirements (e.g., disinfection) from the OF system must still be met. Overland flow, like rapid infiltration, is rarely used for onsite wastewater management.

## Typical applications

Spray irrigation (SI) is normally considered at site locations that do not permit a conventional SWIS because of relative impermeability and shallow depths caused by restrictive conditions (e.g., ground water or impermeable bedrock or fragipan). SI is normally the final step in the treatment sequence as the effluent is reintroduced to the environment. Most states require advanced treatment and disinfection prior to SI treatment.

## Design assumptions

After pretreatment, which at a minimum should be a typical ISF effluent followed by disinfection, the treated wastewater is conveyed to a holding tank with a pump and controls that deliver it to the sprinkler system. The sprinklers spread the wastewater over a predetermined area at specific times. In wet climates or frozen soil conditions, an additional holding (storage) basin or larger dosing tank is required to prevent irrigation during periods when the wastewater would not be accepted by the soil for treatment and intended environmental incorporation. Regulations for buffer requirements from Texas, Virginia, and Pennsylvania are incorporated into table 1. Typically, the features listed below and their peripheral buffer zones are fenced to prevent exposure.

Application rates vary. Texas determines design rates based on evaporation, Virginia bases rates on soil texture, and Pennsylvania uses a combination of soil depth and slope. From a performance code approach, the application rate should be based on protecting the receiving surface/ground waters. It should be based on wastewater characteristics, critical constituent required concentrations (at a monitoring location where a specific quality standard must be met), and the characteristics of the site (i.e., features that will mitigate wastewater contaminants in order to meet the constituent concentration at the point of use).

In practical terms, all three states require the same pretreatment sequence, which yields SI influent of approximately 5, 5, 25, and 4 mg/L of CBOD, TSS, TN, and TP, respectively, in addition to a fecal coliform (FC) level of about 10 cfu/100 mL (if the disinfection step is working properly). Passage through 1 foot of unsaturated soil should for a few years remove most CBOD, TSS, TP, and FC; therefore, nitrogen will be the

Table 1. Buffer requirements to various features

Feature	Buffer distance (ft)
Property lines	10 - 100
Roads, driveways	25
Dwellings	0 - 100
Streams and lakes	25 - 100
Wells and water supplies	100
Recreation areas	100

Source: North Carolina DEHNR, 1996.

constituent of most concern. During the growing season, removal should be feasible by crop uptake and, to a lesser degree, ammonia volatilization.

Therefore, the hydraulic and nitrogen loading rates for a specific site are the primary design parameter. Also, these systems are rarely considered for permeable soils. The design approach described below is for this set of circumstances.

Spray irrigation systems are designed to treat wastewater and evenly distribute the effluent on a vegetated lot for final treatment. The application rate is determined by two major factors: hydraulic loading and nutrient loading (usually nitrogen is the limiting factor). The application rate is designed to meet the capacity of the soil to accept the effluent hydraulically and subsequently allow it to drain through the soil. The application rate can be varied according to the permeability of the soil. In Pennsylvania and Virginia, this method results in application rates of 0.6 to 2.5 cm/week. Lower rates can greatly improve nitrogen removal. The treated wastewater is spread over the required application area through a sprinkler or drip irrigation system.

Sprinklers are generally low-angle (7 to 13 degrees), large-drop-size nozzles designed to minimize aerosols. Application areas must be vegetated (with crops not intended for human consumption) and have slopes that preclude runoff to streams. The type of vegetation determines the nitrogen loading capacity of the site, but the hydraulic capacity depends on climate and soil characteristics. Additional nitrogen losses may occur through denitrification (only about 25 percent due to the low BOD:N ratio) and ammonia volatilization (about 10 percent if soil pH is high; less to none if it is acidic).

Spray irrigation of wastewater effluent must be timed to coincide with plant uptake and nutrient use. Temperature factors in some areas of the country may preclude the use of spray irrigation during certain times of the year. The wastewater may need to be stored in holding tanks during the coldest period of the year, because plant growth is limited and the nitrogen in effluent discharged during this time will be mineralized and unavailable for plant uptake.

Some SI systems irrigate only one or two days per week so that the soil can drain and aerate between applications. Others spray twice during the night or in the early morning to minimize inconvenience to the homeowner and to minimize the potential for human contact.

The width of the required buffer zone depends on the slope of the site, the average wind direction and velocity, the type of vegetation, and the types of nearby land uses. For wastewater produced by a single-family home, the minimum recommended SI plot area, including buffer zones, is commonly about 2 acres (0.81 hectares) in Pennsylvania and Virginia.

## **Performance**

Studies that sample both the soil below the spray field and its runoff show that spray irrigation systems work as well as other methods of managing wastewater. Spray irrigation systems are designed for no degradation; therefore, hydraulic and nutrient loading rates are based on the type of vegetation used and the hydraulic properties of the soils. If the vegetation cannot assimilate the amount of nitrogen applied, for example, then nitrogen removal to reduce the nitrogen content of the effluent prior to spray irrigation may be required. The overall efficiency of a spray irrigation system in removing pollutants will be a function of the pollutant removal efficiencies of the entire treatment process and plant uptake.

There have been few documented cases of health problems due to the spray irrigation, but use of proper buffer zones is crucial. One benefit of spray irrigation is savings on potable water because the wastewater is used for irrigation.

## **Management needs**

Construction factors include site preparation and installation of runoff controls, irrigation piping, return systems, and storage facilities. Since sustained wastewater infiltration is an important component of successful system operation, it is critical that construction activity be limited on the application site. Where stormwater runoff can be significant, measures must be taken to prevent excessive erosion, including terracing of steep slopes, contour plowing, no-till farming, establishment of grass border strips, and installation of sediment control basins. Earthworking operations should be conducted in

such a way as to minimize soil compaction. Soil moisture should generally be low during these operations. High-flotation tires are recommended for all construction vehicles.

The soil profile must also be managed to maintain infiltration rates by avoiding soil compaction and maintaining soil chemical balance. Compaction and surface sealing (caused by harvesting equipment and development of fine layers from multiple wastewater applications) can reduce soil infiltration and increase runoff.

Local regulatory agencies may require ground water monitoring to evaluate system performance. Soil fertility and chemical balance should be evaluated periodically to determine if soil amendments are necessary. Trace elements may also be analyzed to monitor possibly toxic accumulations.

Residuals produced by slow-rate land application systems are limited to harvested crops and crop residues that are not for human consumption. Agricultural crop applications require the most intensive management, while forest application requires the least management. Management tasks may include soil tillage, planting and harvesting of crops, nutrient control, pH adjustment, and sodium and salinity control. No special equipment, other than the appropriate agricultural equipment, is required. Typical pump, controls, and basin requirements prevail for the dosing system.

Virginia's O/M requirements for onsite spray irrigation systems (not including pretreatment unit processes) include the following:

- *Monthly.* Walk over spray area and examine for
  - Ponding of effluent
  - Bad odors
  - Damage to spray heads
  - Surfacing liquids
  - Vegetation problems
  - Surface soil collapse
- *Quarterly.* Conducted by a qualified, semi-skilled operator
  - Proper spray sequence
  - Proper pump function
  - Proper liquid levels
- *Biannually*
  - Erosion
  - Storage unit capacity
- *Annually.* Effluent sampling by a certified laboratory
  - Test water supplied to spray irrigation area for pH, total Kjeldahl nitrogen, fecal coliform bacteria, chlorine, TSS, and BOD
  - Reports of analyses are to be submitted by the laboratory to the local/district health department within 10 days of the completion of the analyses.

A management contract with an approved operator or operations firm is also required.

## Risk management issues

No crops grown on the SI application area should be consumed by humans. Buffer zones should minimize aerosol exposure. Spray irrigation systems with sufficient storage capacity are essentially unaffected by major flow variations. A water balance should be conducted to determine the need under the climate conditions, soils, and application rates and patterns of each rate. Similarly, toxic shock loadings should be largely dissipated in the preceding pretreatment steps, but phytotoxic compounds may still be a concern at the application site. Spray irrigation cannot function during saturated or frozen conditions, and the pretreated influent must be stored until proper vegetative uptake (usually nitrogen) conditions return. Power outages will affect the upstream pretreatment processes rather than the SI system, even though the system must have power to function.

However, by the time the wastewater effluent is discharged by the sprinklers, the water should be sufficiently treated so as not to pose health risks. There have been no documented cases of health problems due to the spray irrigation of properly treated wastewater. However, drifting aerosols from the spray heads should be monitored for impact on nearby land uses. A benefit of spray irrigation is the use of effluent, instead of potable tap water, to water the landscape.

## Costs

Construction costs of SI systems are very high if the generally required pretreatment is included, especially if both an aerobic unit and a sand filter treating septic tank effluent are included. Such a system could easily cost \$20,000 or more.

O/M costs for the SI system alone primarily include labor (15 to 20 hours per year), power (for pumps and other pretreatment needs) and materials (e.g., chlorine, if chosen). O/M costs are estimated at more than \$500 per year, given the entire treatment train suggested by figure 3. If the aerobic treatment unit is not required ahead of the sand filter, and a UV disinfection unit is used, this cost may reduce to \$300 to \$400 annually.

## References

- Crites, R., and G. Tchobanoglous. 1996. *Small and Decentralized Wastewater Management Systems*. WCB/McGraw-Hill, San Francisco, CA.
- Emery, H.C. 1999. Onsite Spray Irrigation: A Tale of Three Cities. *Pumper*.
- McIntyre, C., C. D'Amico, and J.H. Willenbrock. 1994. Residential Wastewater Treatment and Disposal: On-Site Spray Irrigation Systems. In *Proceedings of the Seventh Onsite Wastewater Treatment Symposium*. American Society of Agricultural Engineers, St. Joseph, MI.
- Monnett, G.T., R.B. Reneau, Jr., and C. Hagedorn. 1991. Evaluation of Onsite Spray Irrigation for Disposal on Marginal Soils. In *Proceedings of the 6th Onsite Wastewater Treatment Symposium*. American Society of Agricultural Engineers, St. Joseph, MI.
- North Carolina, DEHNR. 1996. On-site Wastewater Management Guidance Manual. Division of Environmental Health. Raleigh, NC.
- Rubin, A.R. 1992. Slow-Rate Spray Irrigation and Drip Disposal Systems for Treatment and Renovation of Domestic Wastewater from Individual Homes. In *Proceedings of the Seventh Northwest Onsite Wastewater Treatment Short Course*. University of Washington, Seattle.
- Shuval, H.I., A. Adin, B. Fattal, E. Raisitz, and P. Yekutieli. 1986. *Wastewater Irrigation in Developing Countries*. World Bank technical paper no. 51. World Bank, Washington, DC.
- U.S. Environmental Protection Agency (USEPA). 1992. *Manual: Wastewater Treatment/Disposal for Small Communities*. EPA/625/R-92/005. U.S. Environmental Protection Agency, Office of Research and Development, Cincinnati, OH.
- U.S. Environmental Protection Agency (USEPA). 1981. *Process Design Manual for Land Treatment of Municipal Wastewater*. EPA 625/1-81-013. U.S. Environmental Protection Agency, Office of Research and Development, Cincinnati, OH.





---

# Onsite Wastewater Treatment Systems Technology Fact Sheet 13

## Renovation/Restoration of Subsurface Wastewater Infiltration Systems (SWIS)

*Although an analysis to diagnose problems in OWTSS is provided in chapter 5, this Fact Sheet is included to provide a special reference to identify alternatives likely to be recommended to renovate and restore SWIS and observed results.*

### Functions of the subsurface wastewater infiltration system (SWIS)

The subsurface wastewater infiltration system (SWIS) receives the effluent pretreated in the septic tank and purifies it through biological, physical, and chemical reactions as it passes through the unsaturated soil to the ground water. An important component of the infiltration system is the biomat, a layer of organic and inorganic material and bacteria that forms at the interface between the trench and the surrounding soil. The biomat enhances treatment efficiency because it usually slows down the movement of the effluent, provides the flora and fauna necessary to biologically decompose wastes, and enhances the physical and chemical removal of very small particles of matter in the wastewater. Permeable soil textures and structures are required to support these processes.

SWISs are occasionally unable to accept the total daily wastewater load they receive, leading to ponding and eventual hydraulic failure. This is typically caused by the accumulation of biomass and suspended solids in or near the biomat, which reduces the soil's porosity and hydraulic conductivity. If the system fails hydraulically, the first step is usually to pump the septic tank and clean and replace the effluent screen (also known as a filter).

Restoring the hydraulic function of the infiltration system involves eliminating or reducing the flow restrictions. Various methods and products have been developed for restoring the infiltration capacity of SWISs. These include resting, additives, hydrogen peroxide, and soil fracturing.

A variety of additives are also marketed to improve the performance of septic tanks or eliminate the need for pumping. These septic tank additives are discussed in Special Issue Fact Sheet 1.

### SWIS restoration alternatives

#### *Periodic resting*

Periodic resting is a passive method for restoring the hydraulic capacity of the SWIS. Infiltration surfaces are "rested" by removing them from service for an extended period of time, typically 6 to 12 months. To remove a portion of the SWIS from service requires that the SWIS be constructed with multiple cells that have a total hydraulic capacity of 100 to 200 percent of the design flow, or enough suitable reserve SWIS area. Resting may also be used in seasonal facilities that discharge no wastewater for extended periods of the year. The portion of the SWIS taken offline receives no wastewater during the resting period, which allows the infiltration surface to drain and dry out. The resulting aerobic biochemical oxidation of the biomat mass can restore the porosity of the biomat, helping to unclog the system.

Several studies have shown resting to be an effective method to rejuvenate the hydraulic capacity of soil infiltration surfaces (Sharpe et al., 1984). Extended periods of resting at regular intervals is effective in preventing excessive soil clogging and restoring clogged infiltration surfaces. Seventy to eighty percent of the original infiltration capacity of the soil can be recovered by resting. The rate of restoration is proportional to grain size; that is, sand restores more quickly than silt and clay.

Some studies have explored the potential for adding earthworms when a malfunctioning SWIS is pumped. Generally, this approach has not been successful. If the system is basically sound in design, loaded within design limits, and located in well-drained soils, some improvement in hydraulic function may occur when worms are used, especially if some water conservation measures are implemented. However, no quantitative data exist to support the concept that worms aid SWIS restoration.

### ***Additives***

In addition to the additives described in Special Issue Fact Sheet 1, there are commercially available compounds that are apparently benign to the treatment processes in the septic tank and have potential benefit to the SWIS by exchanging with potentially harmful ions (e.g., sodium), that could destroy existing fine soil structure. Such additives could be useful in places having high-sodium drinking water or in areas with hard water supplies where ion exchange softeners are used and the regenerant is not discharged to the SWIS, leaving those soils with an excess of sodium ions. In general, however, the benefits of SWIS additives are not well documented. Chemical additives that contain strong acids or bases or toxic chemicals are generally discouraged or banned because of the possible adverse effects these chemical can have on system components, the soil structure, or ground water quality. Biological additives, on the other hand, may have some small benefits, but there is little published documentation to support this view. Microbial and enzyme preparations appear to enhance liquefaction of biodegradable solids in septic tanks. However, the effects of their use on the soil infiltration surface have not been documented. Studies have shown that biological additives are not directly harmful to traditional onsite systems, but significant beneficial impacts have not been documented with domestic wastewaters (Clark, 1999).

### ***Hydrogen peroxide***

Hydrogen peroxide ( $H_2O_2$ ) is a chemical treatment that was once promoted for its ability to treat a clogged SWIS.  $H_2O_2$ , a strong oxidant, was pumped directly into the absorption trench to restore the hydraulic capacity of the infiltration zone by oxidizing the biomat and breaking down the crust surrounding it. While early research on the use of hydrogen peroxide to unclog SWIS in sandy, unstructured soils appeared positive, subsequent testing did not. Controlled field studies found decreasing infiltration rates for clogged systems treated with  $H_2O_2$ . These reports suggest that hydrogen peroxide mobilizes fine soil particles during initial treatment in some soils. As the chemical reactions subside, however, these fine particles are deposited on top of the infiltrative surface, which can result in further clogging. Hydrogen peroxide can produce temporary benefits at a substantial cost, and is not recommended for regular long-term use in unclogging failed drainfields.

Hydrogen peroxide is a strong oxidant that has been shown to be very effective in eliminating biomats in SWIS, but it can also reduce soil porosity and hydraulic conductivity. The process has been shown to oxidize or “boil” the soil, which creates a layer of fine particles that are released when the soil peds are destroyed on the infiltrative surface. This dramatically reduces the hydraulic capacity of SWIS.

### ***Pneumatic soil fracturing***

Pneumatic soil fracturing is a mechanical treatment used to increase soil porosity by fracturing and lifting the soil surrounding the infiltration surface. A steel probe, inserted below the infiltration surface, is used to inject high-pressure air into the soil. The air fractures and lifts the ground. As the soil expands, polystyrene beads are discharged into the soil fractures, thereby holding them open to increase the porosity of the soil after the particles settle. However, any hydraulic improvements are accompanied by a potential for contamination of underlying aquifers. Insufficient data are available to recommend use of this concept in any area where sensitive ground water supplies lie in close proximity to the infiltrative surface.

Introduced in the early 1990s, pneumatic soil fracturing is a relatively new treatment method. Thus, available performance data on the method are limited and incomplete. Appropriate applications and expected performance are unknown.

## Application

These renovation methods can be applied for either preventive maintenance or rehabilitation after a hydraulic failure has occurred. Resting and the application of additives are primarily preventive maintenance methods. Standby infiltration cells to allow resting can be constructed with the original system or additional land can be held for replacement if failure of the original infiltration system fails. It should be noted that the ability to alternate cells regularly during normal operation is more effective as a preventive maintenance technique than a method to relieve a failed system. The use of additives and hydrogen peroxide is generally not recommended.

Users must be aware that when any of these methods are used to correct hydraulic failures, only the symptoms of failure is treated. The causes of the failure will usually persist. Therefore, the causes of failure should be identified and appropriate corrective action taken to prevent recurrences. Excessive daily flows, inadequate or improperly maintained pretreatment processes (e.g., failure to pump septic tank), and changes in wastewater characteristics because of new ownership or changes in use are common causes of hydraulic failure. If these failures are not eliminated or accommodated through appropriate system modifications, the effectiveness of the treatments will be short-lived.

## Responsibilities of the homeowner

The key responsibilities of the homeowner in ensuring the best operation of an existing or new septic tank/SWIS system include the following:

- *Using household cleansers in moderation.* Excessive use of household cleansers, disinfectants, and other common products can kill bacteria residing in the septic tank and the soil adsorption field. Used in moderate amounts and according to label directions, however, cleaners and disinfectants can be flushed into the wastewater system with no significant impacts. The wastewater stream dilutes the product, and organic material adsorbs it. Slug loading (excessive, instantaneous loadings) of household cleaners can be lethal to septic system bacteria, but normal follow-up usage usually reestablishes the tank's bacterial population within a few hours.
- *Avoiding disposal of toxic and hazardous materials in the wastewater stream.* Many common household products have toxic properties and should never be poured down the drain. The list includes drugs and antibiotics, solvents, paints, varnishes, photography chemicals, weed killers, and insecticides. All of these products have the potential to wipe out septic system bacteria and percolate into ground water supplies.
- *Curbing the use of drain cleaners and openers.* Products aimed at unclogging indoor wastewater pipes contain strong acids or alkalis as the active ingredient. Used according to the label directions, they can be effective in removing clogs of organic matter in indoor drainpipes. Most product labels warn, however, that the product is caustic or corrosive to pipes and can be hazardous to the user if applied improperly. A controlled study concluded that as little as 1.3 ounces of a name brand drain cleaner could destroy the bacteria population in a 1,000-gallon septic tank. This amount is within the general range of normal usage for some people. Bacteria populations in the tank will recover in a few days if the system inputs return to normal levels.
- *Disposing of solids appropriately.* Items such as cigarette butts, condoms, sanitary napkins, paper towels, and kitty litter should never be flushed or washed down the toilet or sink. Septic tanks are not designed as a disposal receptacle for these wastes. They can clog drainpipes and cause excessive and rapid sludge buildup in the tank.
- *Keeping fats, oils, and grease out of kitchen drains.* Fats, oils, and grease are natural by-products of cooking meats and other foods. Grease washed down the drain can stick, accumulate, and in some cases block wastewater drain pipes and the inlet and outlet structures in septic tanks. Food wastes should be scraped from plates and utensils and discarded as solid waste.

- *Avoiding the use of a garbage disposal unless the treatment system is designed for one.* Homes with garbage disposals generally have 20 to 28 percent higher biochemical oxygen demand (BOD) and 25 to 40 percent higher suspended solid loadings to septic tanks than homes without disposals. These significant contributions of organic matter require special consideration when sizing and installing a septic tank or soil absorption system.
- *Conserving water.* To function at peak efficiency, the septic tank needs to provide a quiescent environment and adequate detention time (i.e., more than 24 hours) for the solids and floatable matter to separate from the wastewater. Limiting water flows and timely repair of leaking fixtures help maintain these conditions and prevent overloading of the soil adsorption field.

## References

- Andress, S., and C. Jordan. 1998. *Onsite Sewage Systems*. Virginia Polytechnic Institute and State University, Civil Engineering Department, Blacksburg, VA.
- Angoli, T. 2000. Hydrogen peroxide not recommended to unclog failed drainfields. *Small Flows Quarterly* 1(2):42044.
- Clark, G.H. 1999. The Effect of Bacterial Additives on Septic Tank Performance. Master's thesis, North Carolina State University Department of Soil Science, Raleigh, NC.
- Dow, D., and G. Loomis. 1999. *Septic Tank Additives*. University of Rhode Island Cooperative Extension Service, Onsite Wastewater Training Center, Kingston, RI.
- Gross, M.A. 1987. *Assessment of the Effects of Household Chemicals upon Individual Septic Tank Performances*. University of Arkansas, Arkansas Water Resources Research Center, Fayetteville, AR.
- Hairston, J.E., G. Speakman, and L. Stribling. 1995. *Protecting Water Quality: Understanding Your Septic System and Water Quality*. Alabama Cooperative Extension Publication wq-125.al June 1995. Developed with support from Auburn University. Auburn University, Auburn, AL.
- Hargett, D.L., E.J. Tyler, J.C. Converse, and R.A. Apfel. 1984. Effects of Hydrogen Peroxide as a Chemical Treatment for Clogged Wastewater Absorption Systems. In *Proceedings of the Fourth National Symposium on Individual and Small Community Sewage Treatment*, American Society of Agricultural Engineers, St. Joseph, MI.
- Hargett, D.L., E.J. Tyler, and R.L. Siegrist. 1982. Soil Infiltration Capacity as Affected by Septic Tank Effluent Application Strategies. In *Onsite Sewage Treatment, Proceedings of the Third National Symposium on Individual and Small Community Sewage Treatment*. American Society of Agricultural Engineers, St. Joseph, MI.
- Jantrania, A., W.A. Sack, and V. Earp. 1994. Evaluations of Additives for Improving Septic Tank Operation Under Stress Condition. In *Proceedings of the International Symposium on Individual and Small Community Sewer Systems*. American Society of Agricultural Engineers, St. Joseph, MI.
- Olson, K., D. Gustafson, B. Liukkonen, and V. Cook. 1977. *Septic System Owner's Guide*. University of Minnesota Extension Services Publication PC-6583-GO. University of Minnesota, College of Agricultural, Food and Environmental Sciences, St. Paul, MN.
- Rupp, G. 1996. *Questions and Answers about Septic System Additives*. Montana State University Extension Service. Bozeman, MT.
- Scow, K.M. 1994. *The Efficacy and Environmental Impact of Biological Additives to Septic Systems*. University of California, Berkeley, CA.
- Sharpe, W.E., C.A. Cole, and D.D. Fritton. 1984. Restoration of failing onsite wastewater systems using water conservation. *Journal of the Water Pollution Control Federation* 56(7):855-866.
- Simons, A.P., and F.R. Magdoff. 1979. Disposal of septic tank effluent in mound and sand filter trench systems on a clay soil. *Journal of Environmental Quality* 8:469-473.

- Thomas, R.E., et al. 1996. Soil chemical changes and infiltration rate reduction under sewage spreading. In *Proceedings of the Annual Meeting of the Soil Science Society of America*, pp. 641-646. Madison, WI.
- U.S. Environmental Protection Agency. 1998. *A Project to Renovate Failing Gravity Septic Systems with Earthworms*. Section 319 project report. EPA 40-08/98/07/01. U.S. Environmental Protection Agency, Washington, DC.
- Virginia Polytechnic Institute and State University. 1996. *Septic System Maintenance*. Produced by the Water Quality Program Committee. VTU pub. no. 440-400. Virginia Polytechnic Institute and State University, Blacksburg, VA.







---

# Onsite Wastewater Treatment Systems Special Issues Fact Sheet 1

## Septic Tank Additives

### Description

Because of the presence of significant numbers and types of bacteria, enzymes, yeasts, and other fungi and microorganisms in typical residential and commercial wastewaters, the use of septic system additives containing these or any other ingredients is not recommended. The benefits of consumer products sold as septic system cleaners, degraders, decomposers, deodorizers, organic digesters, or enhancers are not significant or have not been demonstrated conclusively, depending on the product. Some of these products can actually interfere with treatment processes, affect biological decomposition of wastes, contribute to system clogging, and contaminate ground water. The septic tank/soil absorption field system is the most commonly used onsite wastewater treatment system in the United States. It is relatively low in cost, has no moving parts, and requires little maintenance.

Septic tanks have a number of important functions, including:

- *Remove oils, grease and settleable solids.* The septic tank is designed to provide quiescent conditions over a sufficient time period to allow settleable solids to sink to the bottom of the tank and floatable solids, oils, and grease to rise to the surface. The result is a middle layer of partially clarified effluent that exits the tank to the soil absorption field.
- *Store settleable and floatable material.* Tanks are generously sized according to projected wastewater flow and composition to accumulate sludge and scum at the bottom and top of the tank, respectively. Tanks require pumping at infrequent intervals (e.g., 1 to 7 years), depending on sludge and scum accumulation rates.
- *Digest/decompose organic matter.* In an anaerobic environment, facultative and anaerobic bacteria can reduce retained organic molecules to soluble compounds and gases, including  $H_2$ ,  $CO_2$ ,  $NH_3$ ,  $H_2S$ , and  $CH_4$ . This digestion can significantly reduce sludge volume in warm climates.

### Types of additives and effects on treatment processes

There are three general types of commonly marketed septic system additives:

- *Inorganic compounds*, usually strong acids or alkalis, are promoted for their ability to open clogged drains. Product ingredients (e.g., sulfuric acid, lye) are similar to those used in popular commercial drain cleaners. These products can adversely affect biological decomposition processes in the treatment system and cause structural damage to pipes, septic tanks, and other treatment system components. Hydrogen peroxide, once promoted as an infiltration field reconditioner, has been found to actually degrade soil structure and compromise long-term viability of soil treatment potential. Its use to unclog failed infiltration fields is no longer recommended.
- *Organic solvents*, often chlorinated hydrocarbons (e.g., methylene chloride, trichloroethylene) commonly used as degreasers and marketed for their ability to break down oils and grease. Organic solvents represent significant risks to ground water and wastewater treatment processes. These products can destroy resident populations of decomposer and other helpful microorganisms in the treatment system. Use of products containing organic solvents in onsite treatment systems is banned in many states. Introduction of organic solvents into onsite systems located in states that ban the use of these products may trigger liability issues if ground water becomes contaminated.

- *Biological additives*, like bacteria and extracellular enzymes mixed with surfactants or nutrient solutions, which mirror but do not appear to significantly enhance normal biological decomposition processes in the septic tank. Some biological additives have been found to degrade or dissipate septic tank scum and sludge. However, whether this relatively minor benefit is derived without compromising long-term viability of the soil infiltration system has not been demonstrated conclusively. Some studies suggest that material degraded by additives in the tank contributes to increased loadings of BOD, TSS, and other contaminants in the otherwise clarified septic tank effluent.

Other products containing formaldehyde, paraformaldehyde, quaternary ammonia, and zinc sulfate are advertised to control septic odors by killing bacteria. This objective, however, runs counter to the purpose and function of septic tanks (promoting anaerobic bacterial growth). If odor is a problem, the source should be investigated because sewage may be surfacing, a line might have ruptured, or another system problem might be present.

Another variety of consumer products is marketed for their ability to remove phosphorus from wastewater. These products are targeted at watershed residents who are experiencing eutrophication problems in nearby lakes and streams. Phosphorus is an essential nutrient for aquatic plant growth and limiting its input to inland surface waters can help curtail nuisance algae blooms. Aluminum (as alum, sodium aluminate, aluminum chloride, and activated alumina), ferric iron (as ferric chloride and ferric sulfate), ferrous iron (as ferrous sulfate and ferrous chloride), and calcium (as lime) have been proven to be effective in stripping phosphorus from effluent and settling it to the bottom of the tank. An important side effect of this form of treatment, however, can be the destruction of the microbial population in the septic tank due to loss of buffering capacity and a subsequent drop in pH. Treatment processes can be severely compromised under this scenario.

Finally, baking soda and other flocculants are marketed as products that lower the concentration of suspended solids in septic tank effluent. Theoretically, flocculation and settling of suspended solids would result in cleaner effluent discharges to the subsurface wastewater infiltration system. However, research has not conclusively demonstrated significant success in this regard.

## References

- Andress, S.; Jordan, C. 1998. *Onsite Sewage Systems*. Virginia Polytechnic Institute and State University, Civil Engineering Department, Blacksburg, VA.
- Angoli, T. 2000. *Hydrogen peroxide not recommended to unclog failed drainfields*. Small Flows Quarterly Vol. 1 No. 2, p. 42-44.
- Clark, G.H. 1999. The Effect of Bacterial Additives on Septic Tank Performance. Master's thesis, North Carolina State University, Department of Soil Science, Raleigh, NC.
- Dow, D., and G. Loomis. 1999. *Septic Tank Additives*. University of Rhode Island Cooperative Extension Service Onsite Wastewater Training Center, Kingston, RI.
- Hairston, J.E., G. Speakman, and L. Stribling. 1995. *Protecting Water Quality: Understanding Your Septic System and Water Quality*. Alabama Cooperative Extension Publication wq-125.al, June 1995. Developed with support from Auburn University, Auburn, AL.
- Olson, K., D. Gustafson; B. Liukkonen; and V. Cook. 1977. *Septic System Owner's Guide*. University of Minnesota Extension Services Publication PC-6583-GO. University of Minnesota, College of Agricultural, Food, and Environmental Sciences, St. Paul, MN.
- Rupp, G. 1996. *Questions and Answers About Septic System Additives*. Montana State University Extension Service, Bozeman, MT.
- Virginia Polytechnic Institute and State University (Virginia Tech). 1996. *Septic System Maintenance*. VTU publication no. 440-400, October 1996. Water Quality Program Committee, Virginia Polytechnic Institute and State University, Blacksburg, VA.



---

# Onsite Wastewater Treatment Systems Special Issues Fact Sheet 2

## High-Organic-Strength Wastewaters (Including Garbage Grinders)

### Description

Because many onsite treatment alternatives are sensitive to organic loading rate, high-strength wastewaters may require additional treatment steps to ultimately meet environmental discharge or reuse goals. Among the individual home options that increase the organic strength of the wastewater (see chapter 3) are water conservation and use of garbage grinders (disposals). Commercial wastewater may also be high in organic concentration and, thus, organic loading. The database on such wastewaters is extremely limited for use in design of OWTSSs.

The major concern caused by high organic loadings in the pretreated wastewater is higher organic loadings (e.g., BOD) to the infiltrative surface of the SWIS, which could result in clogging. A certain degree of clogging at the interface of infiltration trenches and the surrounding soil is expected and helps the soil absorption field function properly. The clogging layer, or biomat, which forms at this interface, is composed of organic material, trapped colloidal matter, bacteria, and microorganisms and their by-products. The biomat may slow the infiltrative capacity of the SWIS, but it increases effluent treatment time under unsaturated aerobic conditions (in the vadose zone below the trenches).

Physical clogging occurs when solid material such as grit, organic material, and grease is carried in the effluent beyond the septic tank to the soil adsorption field and deposited on the biomat. Biological clogging generally occurs with excessive organic loading to the biomat, which results in excess microbial growth that restricts the passage of effluent into the soil. Slimes, sugars, ferrous sulfide, and the precipitation of metals such as iron and manganese are additional clogging by-products. Chemical clogging can occur in clayey soils when high concentrations of sodium ions exchange with calcium and magnesium ions in the clay. The soil loses its structure and becomes tighter and more impervious.

### Garbage disposals

Garbage disposals, which have become a standard appliance in many residential kitchens in the United States, contribute excessive organic loadings to the infiltrative field and other system components. Usually installed under the kitchen sink, disposals are basically motorized grinders designed to shred food scraps, vegetable peelings and cuttings, bones, and other food wastes to allow them to flow through drain pipes and into the wastewater treatment system. Disposing of food waste in this manner eliminates the nuisance of an odor of food wastes decaying in a trashcan by moving this waste to the wastewater stream. Many states accommodate these appliances by prescribing additional septic tank volume, service requirements, or other stipulations (e.g., septic tank effluent filter, multiple tanks, larger infiltration field) that address higher BOD and TSS loadings.

Table 1 contains reported information that illustrates that in-sink garbage disposal units increase septic tank loadings of BOD by 20 to 65 percent, suspended solids by 40 to 90 percent, and fats, oils, and grease by 70 to 150 percent. For any septic system, the installation of a disposal causes a more rapid buildup of the scum and sludge layers in the septic tank and an increased risk of clogging in the soil adsorption field due to higher concentrations of suspended solids in the effluent. Also, it means that septic tank volumes should be increased or tanks should be pumped more frequently.

**Table 1. Increase in pollutant loading caused by addition of garbage disposal**

Parameter	Increase in pollutant loading (%)
Suspended solids	40–90
Biochemical oxygen demand	20–65
Total nitrogen	3–10
Total phosphorus	2–3
Fats, oils, and grease	70–150

Sources: Hazeltine, 1951; Rawn, 1951; Univ. of Wisconsin, 1978; USEPA, 1992.

Eliminating the use of garbage disposals will significantly reduce the amount of grease, suspended solids, and BOD in wastewater (see table 1). Elimination of garbage disposal use reduces the rate of sludge and scum accumulation in the septic tank, thus reducing the frequency of required pumping. All of these can improve wastewater system performance.

For system owners who choose to use garbage grinders, manufacturers recommend grinding wastes with a moderate flow of cold water. No research data representing claims of enhanced performance of garbage grinders equipped with septic system additive injectors are available. Additives are not required nor recommended for onsite system operation, and some might actually interfere with treatment, damage the drainfield, or contaminate ground water below the drainfield. (See Special Issues Fact Sheet 1.)

The most common unsewered commercial sources that exhibit high organic strength are restaurants, although a variety of commercial sources produce such wastewaters. These include other facilities with food service capability and dairy product/processing plants. The preprocessing required to remove the source of excessive organic strength is a function of (1) the fractionation of the organic content (settleable, supra-colloidal, colloidal, or soluble); (2) the site characteristics; and (3) the final steps in OWTS processing and the environmental introduction method.

## Typical Applications

Additional pretreatment is typically required before discharge to a SWIS or surface water. There are some proprietary aerobic units that are designed to accept high organic loads, and greatly increase the potential for odors and, where concrete structures are employed, corrosion. Therefore, odor protection becomes a major issue for the designer in these situations. These units are usually a combination of suspended growth/fixed growth or enhanced Continuous-Flow, Suspended Growth Aerobic Systems (CFSGAS; see Technology Fact Sheet 1). Alternatively, anaerobic upflow filters (UAFs) and other anaerobic proprietary and nonproprietary systems can also “thin” excess organics to permit normal loading to these final processing steps.

The Safe Drinking Water Act (SDWA) underground injection systems (UIC) Title V Rule, which is discussed in chapter 1, is designed to eliminate some of these problem wastewater sources of potential ground water contamination (e.g., auto repair facilities) from further consideration for SWIS disposal.

## Design

For domestic systems the additional organic and oil/grease concentrations resulting from use of a garbage grinder usually does not in itself cause the wastewater to require additional processing as described above, but the designer should at least calculate any potential design changes that might be required by the increased strength. For example, for a sandy soil, the



bottom area hydraulic loading rate could be crosschecked against the limiting organic loading rate limits cited in table 4-2. Most state codes require a septic tank size increase to account for the additional volume of sludge and scum accumulating in a septic tank but offer no advice as to any increasing field size.

For restaurants, facilities with food preparation, and other producers of high-organic wastewaters, the designer must evaluate alternative pretreatment schemes that can reduce the excess organics (and sometimes other constituents) to levels that allow subsequent processes to function normally and achieve surface water effluent discharge or reuse standards, if applicable.

An analysis of organic waste sources and waste characteristics (particulate/soluble fractions) is required to determine the best pretreatment approach. On the latter issue, if the majority was coming from a highly concentrated, low-volume source in the facility, a holding tank/hauling solution may be most cost-effective choice. The fraction that contains the majority of the excess contaminants might be readily removable by a specific process (e.g., soluble and biodegradable (aerobic unit) versus supracolloidal and removable by flocculation/sedimentation (vegetated submerged bed or anaerobic upflow filter).

## Performance

The performance of these pretreatment devices is discussed in other fact sheets. Influent concentrations which still exceed normal loading rates can be accommodated by increasing the size or other key basis of computing loading rate or by investigating and implementing pollution prevention measures to reduce the source concentration of the constituent of concern (e.g., BOD).

The reliability of anaerobic processes is highly temperature-dependent, thus requiring heating in northern climates. However short-term anaerobic upflow filters and vegetated submerged beds are less sensitive because of their primary reliance on physical processes. Aerobic treatment processes are also temperature-sensitive, but less so than anaerobic processes.

There is little documented, quality-assured information on the performance of small alternative systems that treat high-organic strength wastewater. However, well-managed aerobic units, upflow filters, and vegetated submerged beds are known to perform reliably.

## Management needs

Management needs are the same as those noted in the unit process fact sheets.

## Risk management issues

Depending on the sequence of processes chosen, the impacts of flow variation, toxic shocks, extreme temperatures, and power outages may cause significant variations from expected treatment performance. However, high-strength wastewaters greatly increase the potential for odors and, where concrete structures are employed, corrosion. Therefore, protection from odor becomes a major issue for the designer in these situations.

## Costs

Costs of treatment trains for high-organic-strength wastewaters can be estimated from the costs of the unit process components.

## References

- Andress, S., and C. Jordan. 1998. *Onsite Sewage Systems*. Virginia Polytechnic Institute and State University, Department of Civil Engineering, Blacksburg, VA.
- Hazeltine, T.R. 1951. Addition of garbage to sewage. *Water & Sewage Works*, pp. 151-154. Annual compilation, 1951.

- Jensen, P.D., and R.L. Siegrist. 1991. Integrated Loading Rate Determination for Wastewater Infiltration System Sizing. In *Proceedings of Sixth Onsite Wastewater Treatment Symposium*. American Society of Agricultural Engineers, St. Joseph, MI.
- Mancl, K.M. 1998. *Septic Tank Maintenance*. Ohio State University Extension publication AEX-740-98. Ohio State University, Food, Agricultural and Biological Engineering, Columbus, OH
- Rawns, A.M. 1951. Some effects of home garbage grinding upon domestic sewage. *American City*, March, pp.110-111.
- Siegrist, R.L. 1987. Hydraulic Loading Rates for Soil Absorption Systems Based on Wastewater Quality. In *Proceedings of the Fifth Onsite Wastewater Treatment Symposium*. American Society of Agricultural Engineers, St. Joseph, MI.
- Siegrist, R.L., D.L. Anderson, and J.C. Converse. 1984. *Commercial Wastewater Onsite Treatment Symposium*. American Society of Agricultural Engineers, St. Joseph, MI.
- Stuth, W.L. 1992. Treating Commercial High-Strength Waste. In *Proceedings of Seventh Northwest On-Site Wastewater Treatment Short Course*. University of Washington, Seattle, WA.
- Tyler, E.J., and J.C. Converse. 1994. Soil Acceptance of Onsite Wastewater as Affected by Soil Morphology and Wastewater Quality. In *Proceedings of Seventh Onsite Wastewater Treatment Symposium*. American Society of Agricultural Engineers, St. Joseph, MI.
- University of Wisconsin. 1978. Management of Small Waste Flows. USEPA 600/2-78-73. September, 1978. U.S. Environmental Protection Agency, Office of Research and Development, Cincinnati, OH.



---

# Onsite Wastewater Treatment Systems Special Issues Fact Sheet 3

## Water Softeners

### Description

Home water softeners, which periodically generate a backwash that is high in sodium, magnesium, and calcium concentrations, can affect wastewater treatment processes and the composition and structure of the infiltration field biomat and the underlying soil. However, attempts to predict whether impacts will occur and to estimate their severity are difficult and often inconclusive.

Water softeners remove “hardness” (dissolved calcium and magnesium) through ion exchange processes. Incoming hard water passes through a tank containing high-capacity ion exchange resin beads supersaturated with sodium. The calcium and magnesium ions in the water attach to the resin beads, replacing the sodium, which is released into the water. The softened water is then distributed for use throughout the house.

Over time, the ion exchange resin beads become saturated with calcium and magnesium ions. When this occurs, the tank must be recharged by flushing with a salt brine solution. Sodium ions reclaim their position on the resin beads, and the calcium and magnesium ions are released into the backwash water. The backwash water then exits the tank and is discharged to the wastewater treatment system. The number of times the tank is recharged and the amount of wastewater generated depends on a number of factors, including the hardness of the water, the amount of water used, the size of the water softener, and the capacity of the resins to remove calcium and magnesium.

The wastewater generated during the recharge phase of the water softening process mixes with other household wastewaters, enters the septic tank, and eventually moves to the soil adsorption field. Studies conducted by soil scientists at the University of Wisconsin and the National Sanitation Foundation conclude that the wastewater effluent generated from properly operating and maintained water softeners will not harm onsite systems that are designed, operated, and maintained appropriately. Specifically, the studies conclude the following:

- High concentrations of calcium and manganese in the softener backwash water have no deleterious effect on the biological functions occurring in the septic tank and may, in some cases, be helpful.
- The additional volume of wastewater generated (typically about 50 gallons per recharge cycle) is added slowly to the wastewater stream and does not cause any hydraulic overload problems.
- Soil structure in the soil absorption field is positively affected by the calcium and magnesium ions in water softener effluent (Corey et al., 1977).

Regarding the last conclusion, some people have the misconception that the salt brine that enters the ion exchange tank also exits the tank as wastewater. In fact, the influent with its high concentration of sodium ions is very different than the effluent, which has a high concentration of calcium and magnesium ions. Consequently, the potential for chemical clogging of clayey soil by sodium ions is reduced. The calcium and magnesium input may even help improve soil percolation.

### Risk management issues

The human health impacts of ingesting softened water are increasingly discussed in addition to the traditional benefits of reduced use of surfactants and plumbing repair requirements. The choice of the homeowner to soften or not to soften will

factor into all arguments. Also, the preceding descriptions are predicated on whole-house-supply softening. Today point-of-use devices designed for use with specific features in the house make the traditional advantages and disadvantages less clear.

## References

- Andress, S., and C. Jordan. 1998. *Onsite Sewage Systems*. Virginia Polytechnic Institute and State University, Civil Engineering Department, Blacksburg, VA.
- Corey, R.B., E.S. Tyler, and M.U. Olotu. 1997. Effects of Water Softner Use on the Permeability of Septic Tank Seepage Fields. In *Proceedings of Second National Home Sewage Treatment Symposium*. Pub. no. 5-77. American Society of Agricultural Engineers, St. Joseph, MI.
- Mancl, K.M. 1998. *Septic Tank Maintenance*. Ohio State University Extension publication AEX-740-98. Ohio State University, Food, Agricultural and Biological Engineering. Columbus, OH.
- University of Wisconsin. 1978. *Management of Small Waste Flows*. EPA-600/2-78-173. U.S. Environmental Protection Agency, Cincinnati, OH.
- U.S. Environmental Protection Agency (USEPA). 1992. *Manual: Wastewater Treatment/Disposal for Small Communities*. EPA 625/R-92/005. U.S. Environmental Protection Agency, Cincinnati, OH.



---

# Onsite Wastewater Treatment Systems Special Issues Fact Sheet 4

## Holding Tanks and Hauling Systems

### Description

A holding tank or vault receives wastewater from a home or commercial establishment and stores it until it is pumped out and hauled to a receiving/processing facility. Although similar to septic tanks, vaults have no outlet piping and must be watertight. The volume can range from 1,000 gallons to 4,000 gallons or more. The vault should be equipped with an audible and visible high-water alarm, which alerts the resident to the need for pumping.

Different sizes of vaults and tank trucks can be used; water conservation can reduce costs considerably by reducing the frequency of pumping. A vault can be equipped with a standpipe and a quick disconnect to which the pumping truck can be directly connected for efficient (minimal spillage) emptying of the vault.

Holding tanks can be used for the entire wastewater flow in cases where conventional and typical alternative systems are not feasible. They are often used this way for seasonal homes in sensitive environmental settings. Holding tanks can also be used to collect only a part of the wastewater flow. Usually, they are used to collect the greywater when non-water-carriage toilets are employed in sensitive areas. This option permits a significant reduction (usually one-third or more) in the number of tank pumpings as compared to the whole wastewater collection option. Another holding tank option is to collect only the blackwater fraction of the wastewater while the graywater is treated in an OWTS. This option is most popular in estuarine areas where significant nitrogen removal is required because the blackwater may contain from 70 to 90 percent of the total nitrogen load. In this case the reduction in pumping frequency from the whole wastewater option would be about two-thirds.

Over and above these combinations a program to reduce water use can be overlaid. The critical contribution of such a program (see chapter 3) is to reduce the daily volume of wastewater (blackwater, graywater, or combined) produced and the required frequency of holding tank pumping. Some onsite wastewater recycling can be added to this program in arid regions where gravity feed and belowground watering of nonconsumable vegetation can be accomplished. However, such a program must meet all local public health requirements.

### Applications

Pump and haul collection is best used when soil absorption fields do not work (for example, where bedrock or ground water levels are near the ground surface) and there is no sewer system. Typical applications are second homes, where annual occupancy may be only a few days to a few months; where a nuisance or public health hazard must be abated; where an isolated building has no running water; in temporary structures or gathering places; or where nutrients must be excluded from ground water to protect environmentally sensitive areas. Pump and haul collection may also simply be the least expensive alternative in some places.

Pump and haul systems are viable only under a wastewater authority that guarantees service. Pump and haul collection can become prohibitively expensive when homes are occupied all the time or where the distance from the treatment plant to the home is more than a few miles.



## Management needs

Holding tanks should be used only where a proper management program is in place. Construction requirements are essentially the same as for a septic tank in that the onsite testing for tank leakage is vital to a successful design and the alarm system must be dredged for proper functioning before acceptance.

In addition to timely pumping, operation and maintenance requirements should include checking the alarm function, cleaning the activation floats, and comparing volume used vs. volume accumulated in the tank. The skill requirements at the site are minimal and can be estimated as approximately 1 hour per pumping. There are normally no energy requirements; the residuals are the tank contents, and confined-space entry safety requirements must be followed if tank entry is required.

## Risk management issues

Holding tanks are not subject to upset by flow variation, toxic loads or power outages. They should be insulated and possibly heat-treated in extremely cold climates. If properly vented through the building sewer, they should not exhibit odor problems, but use in hot climates may require an increase in pumping frequency or a regular addition of lime for mitigation. There is a release of objectionable odors during tank pumping, which can cause some discomfort to residents.

## Costs

More recent cost estimates for holding tank-hauling wastewater disposal indicate that tank installation is about \$1 per gallon of capacity (up to 5,000 gallons) while the alarm system is about \$400.

Tank pumping is generally in range of 10 to 30 cents per gallon, to which labor, travel and equipment amortization may be added (or these costs may be included in a flat fee). Travel costs will dominate if the round-trip distance to the holding tank, to the disposal site, and back to home base exceeds 50 miles. The permit costs to discharge at an appointed site (treatment plant, land spreading site, or independent treatment facility) is also escalated, multiple pumping from a year-round house can become extremely expensive.

## References

- Anderson, C.D. 1986 Trucked Collection Systems Experience in the Northwest Territories. In *Proceedings of Appropriate Wastewater Management Technologies for Rural Areas Under Adverse Conditions*. Technical University of Nova Scotia, Halifax, NS.
- Burrows, R., and N. Bouwes. *The Cost of Holding Tanks for Domestic Wastewater*. Small Scale Waste Management Report. University of Wisconsin, Madison, WI.
- Dix, S.P. *Case Study Number 4: Crystal Lakes, Colorado*. National Small Wastewater Flows Clearinghouse, West Virginia University, Morgantown, WV.
- Mahoney, W.D., ed.-in-chief. 1989. Means Site Work Cost Data. R.S. Means Co., Kingston, MA.
- Mahoney, W.D., ed.-in-chief. 1990. Means Site Work Cost Data. R.S. Means Co., Kingston, MA.
- Manci, K. No date. *Wastewater Treatment Alternatives...Holding Tanks*. The Pennsylvania State University, College of Agriculture, Cooperative Extension Service, University Park, PA.
- Mooers, J.D., and D.H. Waller. 1996. *Onsite Wastewater Research Program: Phase III*. TUNS/Centre for Water Research Study, Halifax, NS.
- National Association of Waste Transporters (NAWT). 1998. *Introduction to Proper Onsite Sewage Treatment*. National Association of Waste Transporters, Scandia, MN.

U.S. Environmental Protection Agency (USEPA). 1984. *Final Generic Environmental Impact Statement: Wastewater Management in Rural Lake Areas*. U.S. Environmental Protection Agency, Region 5, Chicago, IL.

Waller D.H., and A.R. Townshend. 1987. *Appropriate Wastewater Management Technologies for Rural Areas Under Adverse Conditions*. Special Publication, Technical University of Nova Scotia, Halifax, NS.



# Chapter 5:

## Treatment System Selection

- 5.1 Introduction
- 5.2 Design conditions and system selection
- 5.3 Matching design conditions to system performance
- 5.4 Design boundaries and boundary loadings
- 5.5 Evaluating the receiving environment
- 5.6 Mapping the site
- 5.7 Developing the initial system design
- 5.8 Rehabilitating and upgrading existing systems

### 5.1 Introduction

Selecting the appropriate system type, size, and location at the site depends on the wastewater flow and composition information discussed in chapter 3, site- and landscape-level assessments outlined in chapter 3 and in this chapter, performance requirements as noted in chapter 3, and the array of available technology options reviewed in chapter 4. Key to selecting, sizing, and siting the system are identifying the desired level of performance and ensuring that the effluent quality at the performance boundaries meets the expected performance requirements.

### 5.2 Design conditions and system selection

An appropriate onsite wastewater treatment system concept for a given receiver site—proposed location of the system, regional geologic and hydrologic features, and downgradient soils used for treatment—depends on the prevailing design conditions. Designers must consider and evaluate the design conditions carefully before selecting a system concept. Design conditions include the characteristics of the wastewater to be treated, regulatory requirements, and the characteristics of the receiver site (figure 5-1). With sufficient knowledge of these factors, the designer can develop an effective preliminary design concept. This chapter focuses on general guidance for evaluation of the receiver site, identification of the site's design boundaries and requirements, and selection of suitable designs to meet the perfor-

mance requirements. This chapter also provides guidance for evaluating and rehabilitating systems that are not meeting their performance requirements.

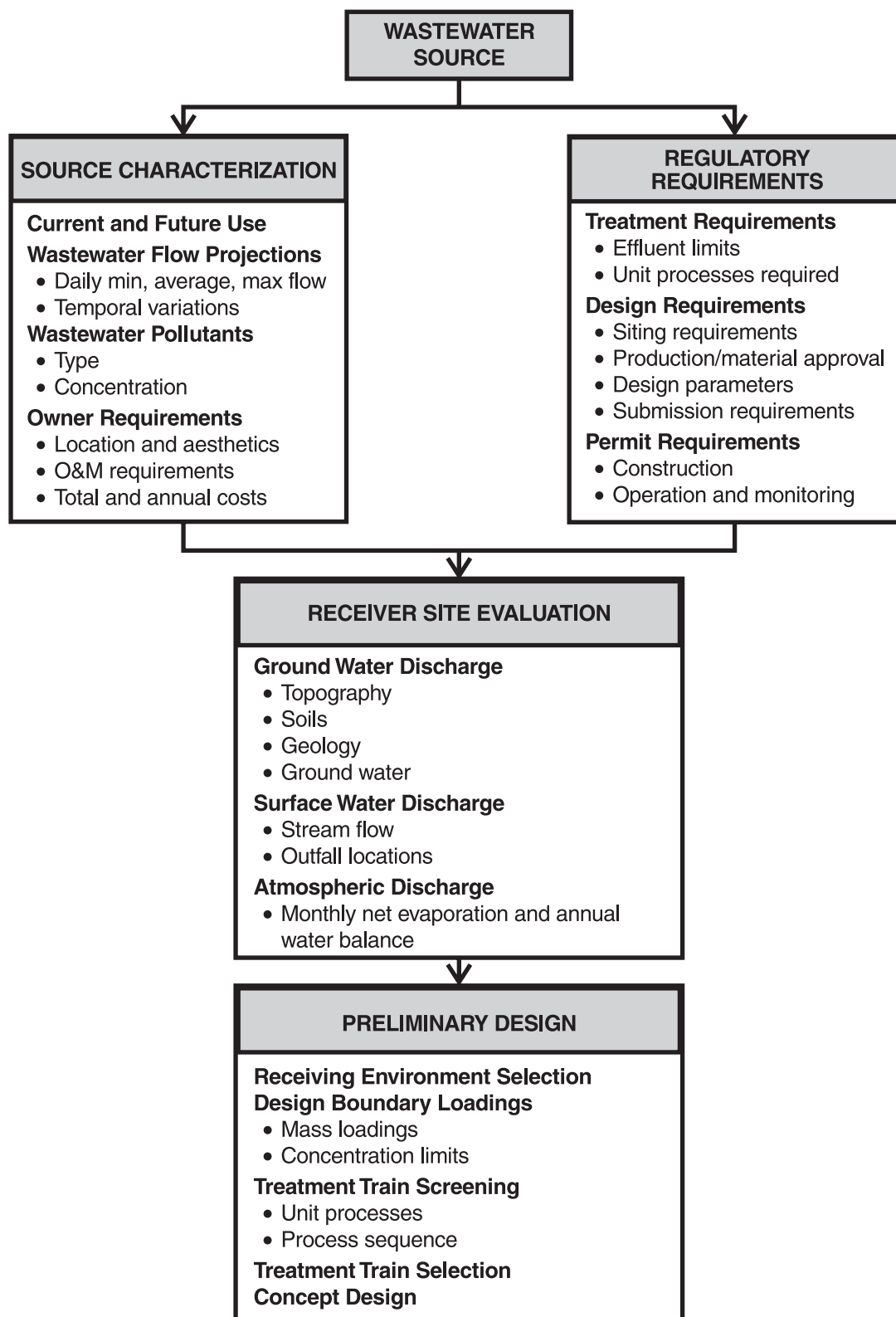
### 5.3 Matching design conditions to system performance

Design conditions include wastewater characteristics; system owner preferences for siting, operation and maintenance, and cost; regulatory requirements prescribed by the permitting agency's rules; and the receiver site's capability to treat or otherwise assimilate the waste discharge. Each of these must be evaluated in light of the others before an appropriate system design concept can be developed.

#### 5.3.1 Wastewater source considerations

Wastewater source considerations include projections of wastewater flow, wastewater composition, and owner requirements. Chapter 3 provides guidance for estimating flow and waste strength characteristics. The owner's needs, capabilities, and expectations might be explicit or implied. The first consideration is the owner's use of the property (present and projected), which informs analyses of the character and volume of the wastewater generated. The footprint and location of existing or planned buildings, paved areas, swimming pools, and other structures or uses will limit the area available for the onsite system. Second, the owner's concern for the system's visual impact or odor

Figure 5-1. Preliminary design steps and considerations.





potential might restrict the range of alternatives available to the designer. Third, the owner's ability and willingness to perform operation and maintenance tasks could limit the range of treatment alternatives. Finally, costs are a critical concern for the owner. Capital (construction) costs and recurring (operation and maintenance) costs should be estimated, and total costs over time should be calculated if cost comparisons between alternative systems are necessary. The owner should have both the ability and willingness to pay construction and operation and maintenance costs if the system is to perform satisfactorily.

### 5.3.2 Regulatory requirements

Designs must comply with the rules and regulations of the permitting entity. Onsite wastewater systems are regulated by a variety of agencies in the United States. At the state level, rules may be enacted as public health codes, nuisance codes, environmental protection codes, or building codes. In most (but not all) states, the regulatory authority for onsite single-family residential or small cluster systems is delegated to counties or other local jurisdictions. The state might enact a uniform code requirement that all local jurisdictions must enforce equally, or the state might have a minimum code that local jurisdictions may adopt directly or revise to be stricter. In a few states, general guidance rather than prescriptive requirements is provided to local jurisdictions. In such cases, the local jurisdictions may enact more or less strict regulations or choose not to adopt any specific onsite system ordinance.

Traditionally, state and local rules have been prescriptive codes that require specific system designs for a set of specific site criteria. Such rules typically require that treated wastewater discharged to the soil be maintained below the surface of the ground, though a few states and local jurisdictions do allow discharges to surface waters under their National Pollutant Discharge Elimination System (NPDES) permitting programs, as authorized by the federal Clean Water Act. If applications are proposed outside the prescriptive rules, the agency usually requires special approvals or variances before a permit can be issued. Circumstances that require special action (approvals, variances) and administrative processes for approving those actions are usually specified in state or local codes.

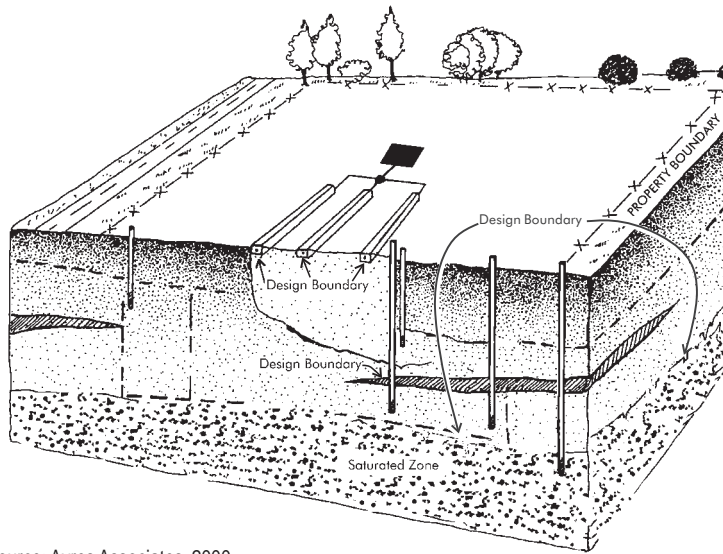
### 5.3.3 Receiver site suitability

The physical characteristics of the site (the location of the proposed system, regional geologic and hydrologic features, and the soils to be used in the treatment process) determine the performance requirements and treatment needs. A careful and thorough site evaluation is necessary to assess the capacity of the site to treat and assimilate effluent discharges. Treatment requirements for a proposed system are based on the performance boundary requirements established by rule and the natural design boundaries identified through the site evaluation.

## 5.4 Design boundaries and boundary loadings

Wastewater system design must focus on the critical design boundaries: between system components, system/soil interfaces, soil layer and property boundaries, or other places where design conditions abruptly change (see figures 5-2 and 5-3). System failures occur at design boundaries because they are sensitive to hydraulic and mass pollutant loadings. Exceeding the mass loading limit of a sensitive design boundary usually results in system failure. Therefore, all critical design boundaries must be identified and the mass loadings to each carefully considered to properly select the upstream performance and design requirements needed to prevent system failure (Otis, 1999).

The approach discussed in this chapter is based on characterizing the assimilative capacity of the receiving environment (ground water, surface water) and establishing onsite system performance requirements that protect human health and ecological resources. Desired system performance, as measured at the final discharge point (after treatment in the soil matrix or other treatment train components), provides a starting point for considering performance requirements for each preceding system component at each design boundary (e.g., septic tank-SWIS interface, biomat at the infiltrative surface, surface of the saturated zone). Through this approach, system designers can determine treatment or performance requirements for each component of the treatment train by assessing whether each proposed component can meet performance requirements (acceptable mass loading limits) at each subsequent design boundary.



Source: Ayres Associates, 2000.

**Figure 5-2. Performance (design) boundaries associated with onsite treatment systems**

Determining the critical design boundaries of the physical environment is the primary objective of the site evaluation (see section 5.5). Design boundaries are physical planes or points, or they may be defined by rule. More than one design boundary can be expected in every system, but not all of the identified boundaries are likely to control design. The most obvious design boundaries are those to which performance requirements are applied (figure 5-2). These are defined boundaries that might or might not coincide with a physical boundary. For a ground water discharge, the design boundary might be the water table surface, the property line, or a drinking water well. For surface water discharges the performance boundary is typically designated at the outfall to the receiving waters, where permit limits on effluent contaminants are applied. Physical boundaries are particularly significant for conventional wastewater treatment systems that discharge to ground water or to the atmosphere. Soil infiltrative surfaces, hydraulically restrictive soil horizons, or zones of saturation are often the critical design boundaries for ground water discharging systems.

The site evaluation must be sufficiently thorough to identify all potential design boundaries that might affect system design. Usually, the critical design boundaries are obvious for surface water discharging and evaporation systems. Design boundaries for

subsurface wastewater infiltration systems, however, are more difficult to identify because they occur in the soil profile and there might be more than one critical design boundary.

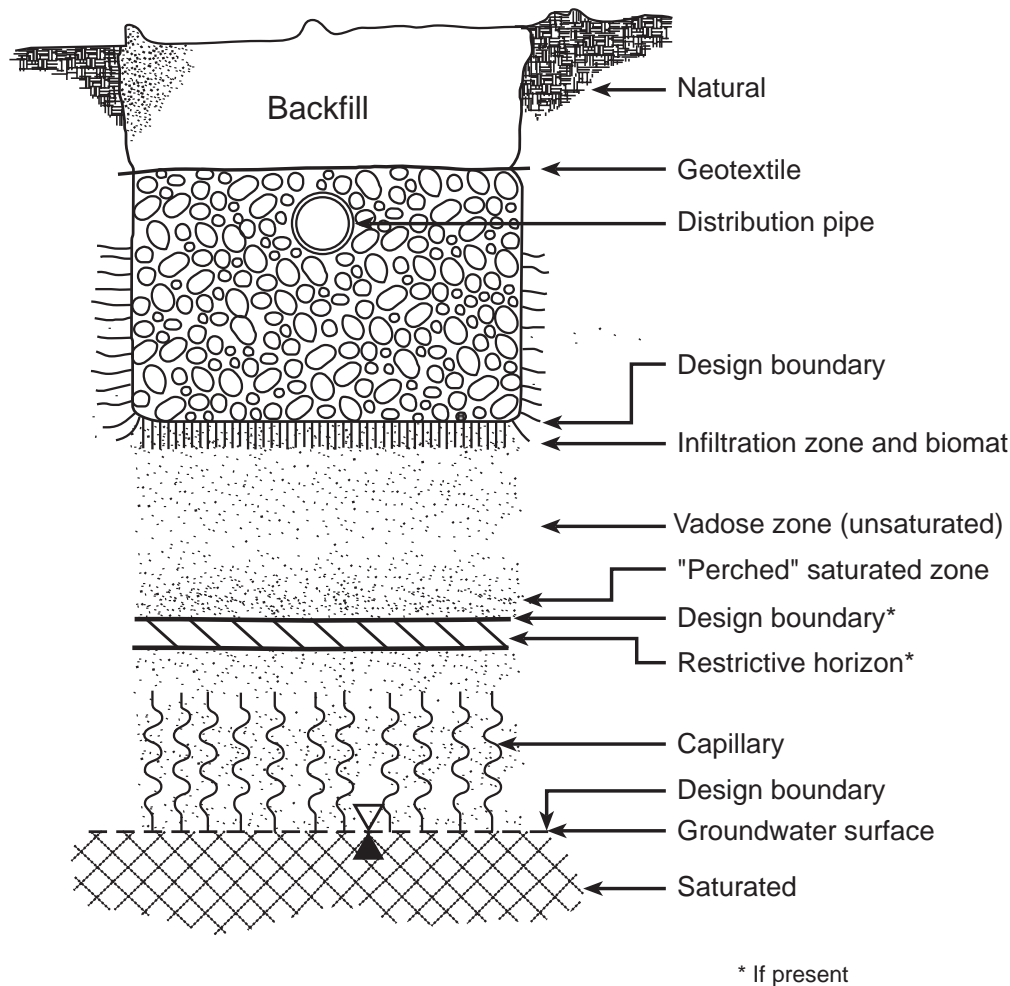
### 5.4.1 Subsurface infiltration system design boundaries and loadings

Subsurface wastewater infiltration systems (SWISs) have traditionally been used to treat and discharge effluent from residences, commercial buildings, and other facilities not connected to centralized sewage treatment plants. These systems accept and treat wastewater discharged from one or more septic tanks in below-grade perforated piping, which is usually installed in moderately shallow trenches 1.5 to 3.0 feet deep on a bed of crushed rock 0.5 to 1.5 inches in diameter. Leaching chambers, leach beds, and other SWIS technologies have also been approved for use in some states. Both the trench bottoms and sidewalls provide infiltrative surfaces for development of the biomat (see chapter 3) and percolation of treated wastewater to the surrounding soil matrix.

The soil functions as a biological, physical, and chemical treatment medium for the wastewater, as well as a porous medium to disperse the wastewater in the receiving environment as it percolates to the ground water. Therefore, the site evaluation must determine the capacity of the soil to hydraulically accept and treat the expected daily mass loadings of wastewater. Site and soil characteristics must provide adequate drainage of the saturated zone to maintain the necessary unsaturated depth below the infiltrative surface, allow oxygenation of aerobic biota in the biomat and reaeration of the subsoil, and prevent effluent surfacing at downgradient locations.

Traditional site evaluation and design procedures consider only the infiltrative surface of the SWIS as a design boundary (figure 5-3). Hydraulic loading rates to this boundary are usually estimated from percolation tests and/or soil profile analyses. The recommended daily hydraulic loading rates typically assume septic tank effluent is to be applied to the soil (through the SWIS biomat, across the trench bottom/sidewall soil interface, and into the surrounding soil). The estimated daily wastewater volume is divided by the applicable hydraulic loading rate to calculate the needed infiltration surface area. This method of design has endured since Henry Ryon first proposed

Figure 5-3. Subsurface wastewater infiltration system design/performance boundaries.



Source: Adapted from Ayres Associates, 1993.

the percolation test and its empirical relationship to infiltration system size nearly 100 years ago (Fredrick, 1948). Although this method of design has been reasonably successful, hydraulic and treatment failures still occur because focusing on the infiltrative surface overlooks other important design boundaries. Identifying those critical boundaries and assessing their impacts on SWIS design will substantially reduce the number and frequency of failures.

Usually there is more than one critical design boundary for a SWIS. Zones where free water or saturated soil conditions are expected to occur above or below unsaturated zones identify perfor-

mance boundary layers (Otis, 2001). In SWISs, these include

- The infiltrative surfaces where the wastewater first contacts the soil.
- Secondary infiltration surfaces that cause percolating wastewater to perch above an unsaturated zone created by changes in soil texture, structure, consistency, or bulk density.
- The ground water table surface, which the percolating wastewater must enter without excessive ground water mounding or degradation of ground water quality.

The infiltrative surface is a critical design and performance boundary in all SWISs since free water enters the soil and changes to water under tension (at pressures less than atmospheric) in the unsaturated zone. Many wastewater quality transformations occur at this boundary. For example, biochemical activity usually causes a hydraulically restrictive biomat to form at the infiltrative surface. Failure to consider the infiltrative surface in system design and to accommodate the changes that occur there can lead to hydraulic or treatment failure.

Other surfaces that are often critical design boundaries include those associated with hydraulically restrictive zones below the infiltrative surface that can cause water to perch. If hydraulic loadings are too great for these boundaries, surface seepage might occur at downslope locations as effluent slides along the perched boundary. Also, the saturated zone could mound to encroach on the unsaturated zone to the extent that sufficient reaeration of the soil does not occur, which can result in severe soil clogging. If hydraulic problems do not occur, these conditions offer some treatment

advantages. For example, denitrification is aided when saturation results in anaerobic conditions in interstices in the normally unsaturated zones. Perched or otherwise layered boundaries require careful characterization, analysis, and assessment of system operation to determine how they will affect the movement of effluent plumes from the SWIS.

The water table surface is where treatment is usually expected to be complete, that is, where pollutant loadings, with proper mixing and dispersion, should not create concentrations in excess of water quality standards. System designers should seek to ensure that hydraulic loadings from the system(s) to the ground water will not exceed the aquifer's capacity to drain water from the site. If a SWIS is to perform properly, the mass loadings to the critical design boundaries must be carefully considered and incorporated into the design of the system. The types of mass loadings that should be considered in SWIS design are presented in table 5-1.

The various design boundaries are affected differently by different types of mass loadings (table 5-2).

**Table 5-1. Types of mass loadings to subsurface wastewater infiltration systems.**

Mass loading type	Units	Typical loading rates
<b>Hydraulic</b>		
• Daily	Volume per day per unit area of boundary surface	<u>Septic tank effluent:</u> 0.15–1.0 gpd/ft <sup>2</sup> (0.6–4.0 cm/d) <u>Secondary effluent:</u> 0.15→ 2.0 gpd/ft <sup>2</sup> (0.6→8.0 cm/d)
• Instantaneous	Volume per dose per unit area of boundary surface	1/24–1/8 of the average daily wastewater volume
• Contour (Linear)	Volume per day per unit length of boundary surface contour (which can be a critical design parameter in areas with high water tables)	Depends on soil $K_{sat}^a$ , maximum allowable thickness of saturated zone, and slope of the boundary surface (see section 5.3)
<b>Constituent</b>		
• Organic	Mass of BOD per day per unit area of boundary surface	0.2–5.0 lb BOD/1000 ft <sup>2</sup> (1.0–29.4 kg BOD/1000 m <sup>2</sup> )
• Other pollutants	Mass of specific wastewater pollutant of concern per unit area of boundary surface (e.g., number of fecal coliforms, mass of nitrate nitrogen, etc.)	Variable with the constituent, its fate and transport, and the considered risk it imposes

<sup>a</sup> $K_{sat}$  is the saturated conductivity of the soil.

Source: Otis, 2001.



Table 5-2. Potential impacts of mass loadings on soil design boundaries

Boundary loading	Infiltrative boundary	Secondary boundaries	Water table boundary
<b>Hydraulic</b>			
• Daily	✓ (hydraulic capacity)	✓ (saturated zone encroachment)	✓ (saturated zone encroachment)
• Instantaneous	✓ (hydraulic capacity)	N/A (attenuated through soil)	N/A (attenuated through soil)
• Linear	N/A (unit gradient below boundary)	✓ (saturated zone encroachment)	✓ (saturated zone encroachment)
<b>Constituent</b>			
• Solids	✓ (surface clogging)	N/A (removed through soil)	N/A (removed through soil)
• Organic	✓ (surface clogging)	N/A (removed through soil)	N/A (removed through soil)
• Other	N/A (usually no impact on infiltration)	N/A (no treatment requirements)	✓ (treatment requirements)

Notes: ✓ denotes that mass loading has potential impact.  
 N/A denotes that mass loading typically has no impact and does not apply.  
 Text in parentheses describes reason for impact or lack of impact of mass loading.  
 Loading impacts apply to both gravity-based and mechanical systems. See chapter 4 for hydraulic and organic loading rates relative to soil texture and structure.

Source: Otis, 1999.

The infiltrative surface is the primary design boundary. At this boundary, the partially treated wastewater must pass through the biomat, enter the soil pores, and percolate into unsaturated soil. The wastewater cannot be applied at rates faster than the soil can accept it, nor can the soil be overloaded with solids or organic matter to the point where soil pores become clogged with solids or an overly thick development of the biomass. Because solids are usually removed through settling processes in the septic tank, the critical design loadings at this boundary are the daily and instantaneous hydraulic loading rates and the organic loading rate. System design requires that daily hydraulic and instantaneous/peak loadings be estimated carefully so that the total hydraulic load can be applied as uniformly as feasible over the entire day to maximize the infiltration capacity of the soil. Uniform dosing and resting maximizes the reaeration potential of the soil and meets the oxygen demand of the applied wastewater loading more efficiently. The organic loading rate is an important consideration if the available area for the SWIS is small. In moderately permeable or more permeable soils, lower organic loading rates can increase infiltration rates into the soil and may allow reductions in the size of the infiltrative surface. Organic loadings to

slowly permeable, fine-textured soils are of lesser concern because percolation rates through the biomat created by the organic loading are usually greater than the infiltration rate into the soil. Preventing effluent backup (hydraulic failure) by increasing the size of the SWIS and implementing water conservation measures are important considerations in these situations.

Secondary design boundaries are usually hydraulically restrictive horizons that inhibit vertical percolation through the soil (figure 5-2). Water can perch above these boundaries, and the perching can affect performance in two significant ways. If the perched water encroaches into the unsaturated zone, treatment capacity of the soil is reduced and reaeration of the soil below the infiltrative surface might be impeded. Depending on the degree of impedance, anoxic or anaerobic conditions can develop, resulting in excessive clogging of the infiltrative surface. Also, water will move laterally on top of the boundary, and partially treated wastewater might seep from the exposed boundaries of the restrictive soil strata downslope and out onto the ground surface. Therefore, the contour (linear) loading along the boundary surface contour must be low enough to prevent water from mounding



above the boundary to the point that inadequately treated wastewater seeps to the surface and creates a nuisance and possible risk to human health. Organic loadings at these secondary boundaries are seldom an issue because most organic matter is typically removed as the wastewater passes through the infiltrative surface boundary layer.

Hydraulic and wastewater constituent loadings are the critical design loadings at the water table boundary. Low aquifer transmissivity creates ground water mounding (figure 5-4), which can encroach on the infiltrative surface if the daily hydraulic loading is too high. Mounding can affect treatment and percolation adversely by inhibiting soil reaeration and reducing moisture potential. A further potential consequence is undesirable surface seepage that can occur downslope. Constituent loadings must be considered where protection of potable water supply wells is a concern. Typical wastewater constituents of human health concern include pathogenic microbes and nitrates (see chapter 3). Water resource pollutants of concern include nitrogen in coastal areas, phosphorus near inland waters, and toxic organics and certain metals in all areas. If the wastewater constituent loadings are too high at the water table boundary, pretreatment before application to the infiltrative surface might be necessary.

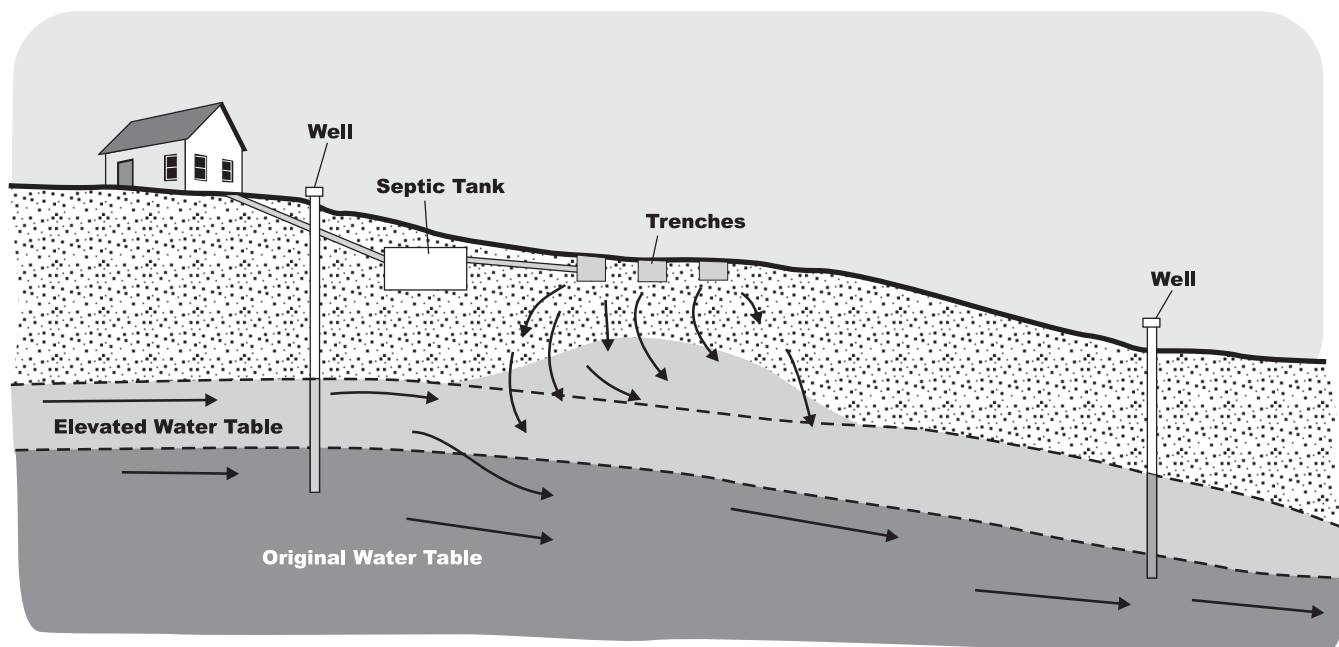
## 5.4.2 Surface water discharging system design boundaries and loadings

Surface water discharging systems typically consist of a treatment plant (aeration/activated sludge/sand filter “package” system with disinfection) discharging to an outfall (pipe discharge) to a surface water. The important design boundaries for these systems are the inlet to the treatment plant and the outfall to the surface water. The discharge permit and the performance history of the treatment process typically establish the limits of mass loading that can be handled at both the inlet to and the outlet from the treatment process. The loadings are often expressed in terms of daily maximum flow and pollutant concentrations (table 5-3). The effluent limits and wastewater characteristics establish the extent of treatment (performance requirements) needed before final discharge.

## 5.4.3 Atmospheric discharging system design boundaries and loadings

Evapotranspiration systems are the most commonly used atmospheric discharging systems. They can take several forms, but the primary design bound-

Figure 5-4. Effluent mounding effect above the saturated zone



Source: Adapted from NSFC diagram.

ary is the evaporative surface. Water (effluent) flowing through the treatment system and site hydrology must be considered in the design. Water balance calculations in the system control design (table 5-4). These loadings are determined by the ambient climatic conditions expected. Procedures for estimating these loadings are provided in chapter 4 (Evapotranspiration Fact Sheet).

## 5.5 Evaluating the receiving environment

Evaluation of the wastewater receiver site is a critical step in system selection and design. The objective of the evaluation is to determine the capacity of the site to accept, disperse, and safely and effectively assimilate the wastewater discharge. The evaluation should

- Determine feasible receiving environments (ground water, surface water, or atmosphere)
- Identify suitable receiver sites
- Identify significant design boundaries associated with the receiver sites
- Estimate design boundary mass loading limitations

Considering the importance of site evaluation with respect to system design, it is imperative that site evaluators have appropriate training to assess

receiver sites and select the proper treatment train, size, and physical placement at the site. This section does not provide basic information on soil science but rather suggests methods and procedures that are standardized or otherwise proven for the practice of site evaluation. It also identifies specific steps or information that is crucial in the decision-making process for the site evaluator.

### 5.5.1 Role and qualifications of the site evaluator

The role of the site evaluator is to identify, interpret, and document site conditions for use in subsurface wastewater treatment system selection, design, and installation. The information collected should be presented in a manner that is scientifically accurate and spatially correct. Documentation should use standardized nomenclature to provide geophysical information so that the information can be used by other site evaluators, designers, regulators, and contractors.

The site evaluator needs considerable knowledge and a variety of skills. A substantial knowledge of soils, soil morphology, and geology is essential because most onsite systems use the soil as the final treatment and dispersal medium. Many states no longer accept the percolation test as the primary

**Table 5-3. Types of mass loadings for point discharges to surface waters**

Mass loading type	Units	Typical loading rates
<b>Hydraulic</b>		
• Daily	Volume per day through outfall	Determined by local regulatory agency based on water resource classification and mixing zone.
<b>Constituent</b>		
• Designated pollutant	Concentration of pollutant in mg/L through outfall	Determined by local regulatory agency based on water resource classification and mixing zone.

Source: Otis, 1999.

**Table 5-4. Types of mass loadings for evapotranspiration systems**

Mass loading type	Units	Typical loading rates
<b>Hydraulic</b>		
• Daily	Volume per day per unit area of boundary surface	Dependent on net evaporation, evapotranspiration potential, solar energy, wind, exposure, mean temperature, and other factors.
• Annual	Volume per day per unit area of boundary surface	Based on monthly water budget.

Source: Otis, 1999.

### North Carolina guidelines for OWTS site evaluations

The Division of Environmental Health of the North Carolina Department of Environment, Health, and Natural Resources uses a 10-point guide for conducting site evaluations. The ten guidelines can be grouped into the following components:

Collecting information before the site visit

Assessing the site and soil at the location

Recording site evaluation data for system design

Relaying the information to the system designer and the applicant.

1. Know the rules and know how to collect the needed information. Applicable codes for sewage treatment and dispersal systems are usually established by the local agency.
2. Determine the wastewater flow rate and characteristics. Information on wastewater quantity and quality is used to determine the initial size and type of the onsite system to be installed at a particular site.
3. Review preliminary site information. Existing published information will help the evaluator understand the types of soils and their properties and distribution on the landscape.
4. Understand the septic system design options. Site evaluators must understand how onsite systems function in order to assess trade-offs in design options.
5. View the onsite system as part of the soil system and the hydrologic cycle. Typically, onsite systems serving single-family homes do not add enough water to the site to substantially change the site's hydrology, except in areas of high densities of onsite systems.
6. Predict wastewater flow through the soil and the underlying materials. The soil morphological evaluation and landscape evaluation are important in predicting flow paths and rates of wastewater movement through the soil and underlying materials.
7. Determine if additional information is needed from the site. Site and soil conditions and the type of onsite system being considered determine whether additional evaluation is required. Some additional evaluations that may be required are ground water mounding analysis, drainage analysis, hydrogeologic testing, contour (linear) loading rate evaluation, and hydraulic conductivity measurements.
8. Assess the treatment potential of the site. The treatment potential of the site depends on the degree of soil aeration and the rate of flow of the wastewater through the soil.
9. Evaluate the site's environmental and public health sensitivity. Installing onsite systems in close proximity to community wells, near shellfish waters, in sole-source aquifer areas, or other sensitive areas may raise concerns regarding environmental and public health issues.
10. Provide the system designer with soil/site descriptions and your recommendations. Based on the information gathered about the facility and the actual site and soil evaluation, the evaluator can suggest loading rates, highlight site and design considerations, and point out special concerns in designing the onsite system.

Source: North Carolina DEHNR, 1996.

suitability criterion. A significant number of permitting agencies now require a detailed soil profile description and evaluation performed by professional soil scientists or certified site evaluators.

In addition to a thorough knowledge of soil science, the site evaluator should have a basic understanding of chemistry, wastewater treatment, and water movement in the soil environment, as well as knowledge of onsite system operation and construction. The evaluator should also have basic skills in surveying to create site contour maps and

site plans that include temporary benchmarks, horizontal and vertical locations of site features, and investigation, sample, or test locations. A general knowledge of hydrology, biology, and botany is helpful. Finally, good oral and written communication skills are necessary to convey site information to others who will make important decisions regarding the best use of the site.

## 5.5.2 Phases of a site evaluation

Site evaluations typically proceed in three phases: a preliminary review of documented site information, a reconnaissance of potential sites, and a detailed evaluation of the most promising site or sites. The scale and detail of the evaluation depend on the quantity and strength of the wastewater to be treated, the nature of local soils and the hydrogeologic setting, the sensitivity of the local environment, and the availability of suitable sites. Using a phased approach (table 5-5) helps to focus the site evaluation effort on only the most promising sites for subsurface systems.

## 5.5.3 Preliminary review

The preliminary review is performed before any fieldwork. It is based on information available from the owner or local agencies or on general resource information. The objectives of the preliminary review are to identify potential receiver sites, determine the most feasible receiving environments, identify potential design boundaries, and develop a relative suitability ranking. Preliminary screening of sites is an important aspect of the site evaluator's role. More than one receiving environment might be feasible and available for use. Focusing the effort on the most promising receiving environments and receiver sites allows the evaluator to reasonably and methodically eliminate the least suitable sites early in the site evaluation process. For example, basic knowledge of the local climate might eliminate evaporation or evapotranspiration as a potential receiving environment immediately. Also, the applicable local codes often prohibit point discharges to surface waters from small systems. Knowledge of local conditions and regulations is essential during the screening process. Resource materials and information to be reviewed may include, but are not limited to, the following:

- *Property information.* This information should include owner contact information, site legal description or address, plat map or boundary survey, description of existing site improvements (e.g., existing onsite wastewater systems, underground tanks, utility lines), previous and proposed uses, surrounding land use and zoning, and other available and relevant data.
- *Detailed soil survey.* Detailed soil surveys are published by the U.S. Department of Agriculture's Natural Resources Conservation

Table 5-5. Site characterization and assessment activities for SWIS applications

Preliminary activities	Information from research
Preliminary review	<ul style="list-style-type: none"> <li>✓ Site survey map</li> <li>✓ Soil survey, USGS topographic map</li> <li>✓ Aerial photos, wetland maps</li> <li>✓ Source water protection areas</li> <li>✓ Natural resource inventories</li> <li>✓ Applicable regulations/setbacks</li> <li>✓ Hydraulic loading rates</li> <li>✓ Criteria for alternative OWTS</li> <li>✓ Size of house/facility</li> <li>✓ Loading rates, discharge types</li> <li>✓ Planned location of water well</li> </ul>
Scheduling	<ul style="list-style-type: none"> <li>✓ Planned construction schedule</li> <li>✓ Date and time for meeting</li> </ul>
Field activities	Information from field study
Identification of unsuitable areas	<ul style="list-style-type: none"> <li>✓ Water supply separation distances</li> <li>✓ Regulatory buffer zones/setbacks</li> <li>✓ Limiting physiographic features</li> </ul>
Subsurface investigations	<ul style="list-style-type: none"> <li>✓ Ground water depth from pit/auger</li> <li>✓ Soil profile from backhoe pit</li> <li>✓ Presence of high water table</li> <li>✓ Percolation tests</li> </ul>
Identification of recommended SWIS site	<ul style="list-style-type: none"> <li>✓ Integration of all collected data</li> <li>✓ Identification of preferred areas</li> <li>✓ Assessment of gravity-based flow</li> <li>✓ Final selection of SWIS site</li> </ul>

Source: Adapted from ASTM, 1996a.

Service (NRCS), formerly the Soil Conservation Service (SCS). Detailed soil surveys provide soil profile descriptions, identify soil limitations, estimate saturated soil conductivities and permeability values, describe typical landscape position and soil formation factors, and provide various other soil-related information. Soil surveys are typically based on deductive projections of soil units based on topographical or landscape position and should be regarded as general in nature. Because the accuracy of soil survey maps decreases as assessments move from the landscape scale to the site scale, soil survey data should be supplemented with detailed soil sampling at the site (table 5-5). Individual surveys are performed on a county basis and are available for most counties in the continental United States, Alaska, Hawaii, and the U.S. territories. They are available from county extension offices or

the local NRCS office. Information on available detailed soil surveys and mapping status can be obtained from the National Soil Survey Center through its web site at <http://www.statlab.iastate.edu/soils/nssc/>. The NRCS publication *Fieldbook for Describing and Sampling Soils* is an excellent manual for use in site evaluation. It is available at [http://www.statlab.iastate.edu/soils/nssc/field\\_gd/field\\_gd.pdf](http://www.statlab.iastate.edu/soils/nssc/field_gd/field_gd.pdf).

- *Quadrangle maps.* Quadrangle maps provide general topographic information about a site and surrounding landscape. These maps are developed and maintained by the U.S. Geological Survey (USGS) and provide nationwide coverage typically at a scale of 1 inch = 2000 feet, with either a 10- or 20-foot contour interval. At this scale, the maps provide information related to land use, public improvements (e.g., roadways), USGS benchmarks, landscape position and slope, vegetated areas, wetlands, surface drainage patterns, and watersheds. More information about USGS mapping resources can be found at <http://mapping.usgs.gov/mac/findmaps.html>. Quadrangle maps also are available through proprietary software packages.
- *Wetland maps.* Specialized maps that identify existing, farmed, and former wetlands are available in many states from natural resource or environmental agencies. These maps identify wetland and fringe areas to be avoided for wastewater infiltration areas. On-line and published wetland maps for many parts of the United States are available from the U.S. Fish and Wildlife Service's National Wetlands Inventory Center at <http://www.nwi.fws.gov/>.
- *Aerial photographs.* If available, aerial photographs can provide information regarding past and existing land use, drainage and vegetation patterns, surface water resources, and approximate location of property boundaries. They are especially useful for remote sites or those with limited or difficult access. Aerial photographs may be available from a variety of sources, such as county or regional planning, property valuation, and agricultural agencies.
- *Geology and basin maps.* Geology and basin maps are especially useful for providing general information regarding bedrock formations and depths, ground water aquifers and depths, flow direction and velocities, ambient water quality, surface water quality, stream flow, and seasonal fluctuations. If available, these maps can be obtained from USGS at <http://www.nationalatlas.gov/> or Terra Server at <http://www.terraserver.microsoft.com>.
- *Water resource and health agency information.* Permit and other files, state/regional water agency staff, and local health department sanitarians or inspectors can provide valuable information regarding local onsite system designs, applications, and performance. Regulatory agencies are beginning to establish Total Maximum Daily Loads (TMDLs) for critical wastewater constituents within regional drainage basins under federal and state clean water laws. TMDLs establish pollutant "budgets" to ensure that receiving waters can safely assimilate loads of incoming contaminants, including those associated with an onsite system (e.g., bacteria, nutrients). If the site lies in the recharge area of a water resource listed as impaired (not meeting its designated use) because of bacteria or nutrient contamination, site evaluators need to be aware of all applicable loading limits to ground water or surface water in the vicinity of the site under review.
- *Local installer/maintenance firms.* Helpful information often can be obtained from interviews with system installation and maintenance service providers. Their experience with other sites in the vicinity, existing technology performance, and general knowledge of soils and other factors can inform both the site evaluation and the selection of appropriate treatment system components.
- *Climate.* Temperature, precipitation, and pan evaporation data can be obtained from the National Oceanic and Atmospheric Administration (NOAA) at <http://www.nic.noaa.gov>. This information is necessary if evapotranspiration systems are being considered. The evaluator must realize, however, that the data from the nearest weather station might not accurately represent the climate at the site being evaluated.



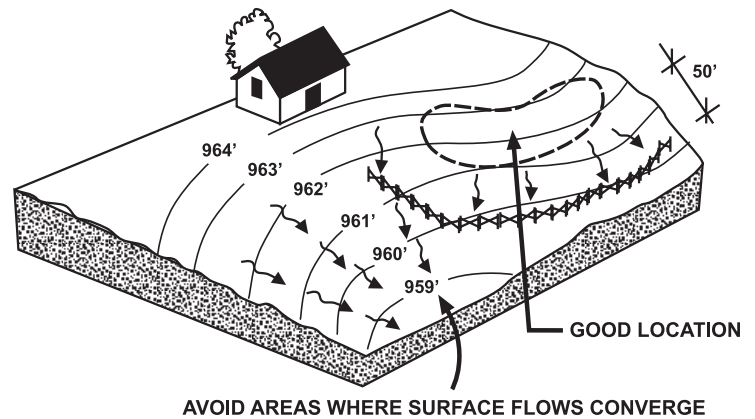
### 5.5.4 Reconnaissance survey

The objectives of the reconnaissance survey are to obtain preliminary site data that can be used to determine the appropriate receiving environment, screen potential receiver sites, and further focus the detailed survey to follow. A reconnaissance survey typically includes visual surveys of each potential site, preliminary soils investigation using hand borings, and potential system layouts. Information gathered from the preliminary review, soil sampling tools, and other materials should be on hand during the reconnaissance survey.

The site reconnaissance begins with a site walkover to observe and identify existing conditions, select areas to perform soil borings, or view potential routes for piping or outfall structures. The site evaluator should have an estimate of the total area needed for the receiver site based on the projected design flow and anticipated soil characteristics. It is advisable to complete the site walkover with the owner and local regulatory staff if possible, particularly with larger projects. Selection of an area for soil investigation is based on the owner's requirements (desired location, vegetation preservation, and general site aesthetics), regulatory requirements (setbacks, slope, and prior land use), and the site evaluator's knowledge and experience (landscape position, local soil formation factors, and geologic conditions). Visual inspections are used to note general features that might affect site suitability or system layout and design. General features that should be noted include the following:

- **Landscape position.** Landscape position and landform determine surface and subsurface drainage patterns that can affect treatment and infiltration system location. Landscape features that retain or concentrate subsurface flows, such as swales, depressions, or floodplains, should be avoided. Preferred landscape positions are convex slopes, flat areas with deep, permeable soils, and other sites that promote wastewater infiltration and dispersion through unsaturated soils (figures 5-5 and 5-6).
- **Topography.** Long, planar slopes or plateaus provide greater flexibility in design than ridges, knolls, or other mounded or steeply sloping sites. This is an important consideration in gravity-flow treatment systems, collection

Figure 5-5. General considerations for locating a SWIS on a sloping site



Source: Purdue University, 1990.

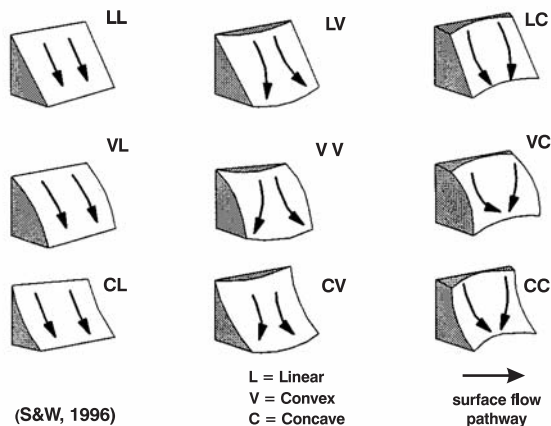
piping for cluster systems, treatment unit sites, and potential routes for point discharge outfalls.

- **Vegetation.** Existing vegetation type and size provide information regarding soil depth and internal soil drainage, which are important considerations in the subsurface wastewater infiltration system layout.
- **Natural and cultural features.** Surface waters, wetlands, areas of potential flooding, rock outcrops, wells, roads, buildings, buried utilities, underground storage tanks, property lines, and other features should be noted because they will affect the suitability of the receiver site.

A good approach to selecting locations for soil investigations is to focus on landscape position. The underlying bedrock often controls landscapes, which are modified by a variety of natural forces. The site evaluator should investigate landscape positions during the reconnaissance phase to identify potential receiver sites (figures 5-5, 5-6 and 5-7; table 5-6). Ridgelines are narrow areas that typically have limited soil depth but often a good potential for surface/subsurface drainage. Shoulderslopes and backslopes are convex slopes where erosion is common. These areas often have good drainage, but the soil mantle is typically thin and exposed bedrock outcrops are common. Sideslopes are often steep and erosion is active. Footslopes and depressions are concave areas of soil accumulation; however, depressions usually have poor drainage. The deeper, better-drained

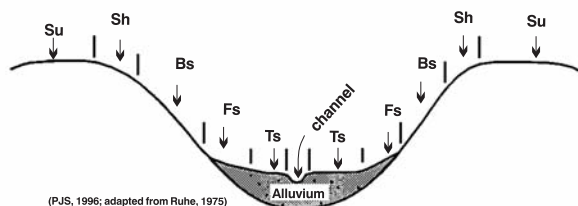
**Figure 5-6. Landscape position features**  
(see table 5-6 for siting potential)

**Slope Shape** - Slope shape is described in two directions: up and down slope (perpendicular to the contour), and across slope (along the horizontal contour); e.g., *linear, convex, or LV*.



**Hillslope - Profile Position** (Hillslope Position in PDP) - Two-dimensional descriptions of parts of line segments (slope position) along a transect that runs up and down the slope; e.g., *backslope or BS*. This is best applied to transects or points, not areas.

Position	Code
summit	SU
shoulder	SH
backslope	BS
footslope	FS
toeslope	TS



Source: NRCS, 1998.

**Table 5-6. SWIS siting potential vs. landscape position features**

Landscape position	SWIS siting potential	Comments
LC VC CC	Poor	Converging flows could overload SWIS hydraulically
LV VV CV	Fair	Might not be able to add additional trench length later
LL VL CL	Best	Parallel flow across SWIS provides best siting potential

soils are found on ridgelines, lower sideslopes, and footslopes. Bottomlands might have deeper soils but might also have poor subsurface drainage.

The visual survey might eliminate candidate receiver sites from further consideration. Preliminary soil borings should be examined on the remaining potential sites unless subsurface wastewater infiltration as a treatment or dispersal option has been ruled out for other reasons. Shallow borings, typically to a depth of at least 5 feet (1.7 meters), should be made with a soil probe or hand auger to observe the texture, structure, horizon thickness, moisture content, color, bulk density, and spatial variability of the soil. Excavated test pits are not typically required during this phase because of the expense and damage to noncommitted sites. Enough borings must be made to adequately characterize site conditions and identify design boundaries. To account for grade variations, separation distances, piping routes, management considerations, and contingencies, an area sufficient to provide approximately 200 percent of the estimated treatment area needed should be investigated. A boring density of one hole per half-acre may be adequate to accomplish the objectives of this phase. On sites where no reasonable number of soil borings is adequate to characterize the continuity of the soils, consideration should be given to abandoning the site as a potential receiver site.

Onsite treatment with a point discharge (permitted under the National Pollutant Discharge Elimination System) requires evaluation of the potential receiving water and an outfall location. The feasibility of a point discharge is determined by federal and state rules and local codes, if enacted by the local jurisdiction. Where the impacts and location of the discharge are considered acceptable by the regulating agency, effluent concentration limits will be stipulated and an NPDES permit will be required.

The final step of the reconnaissance survey is to make a preliminary layout of the proposed system on each remaining candidate site based on assessed site characteristics and projected wastewater flows. This step is necessary to determine whether the site has sufficient area and to identify where detailed soils investigations should be concentrated. In practice, this step becomes integrated into the field reconnaissance process so the conceptual design

unfolds progressively as it is adapted to the growing body of site and soil information.

### 5.5.5 Detailed evaluation

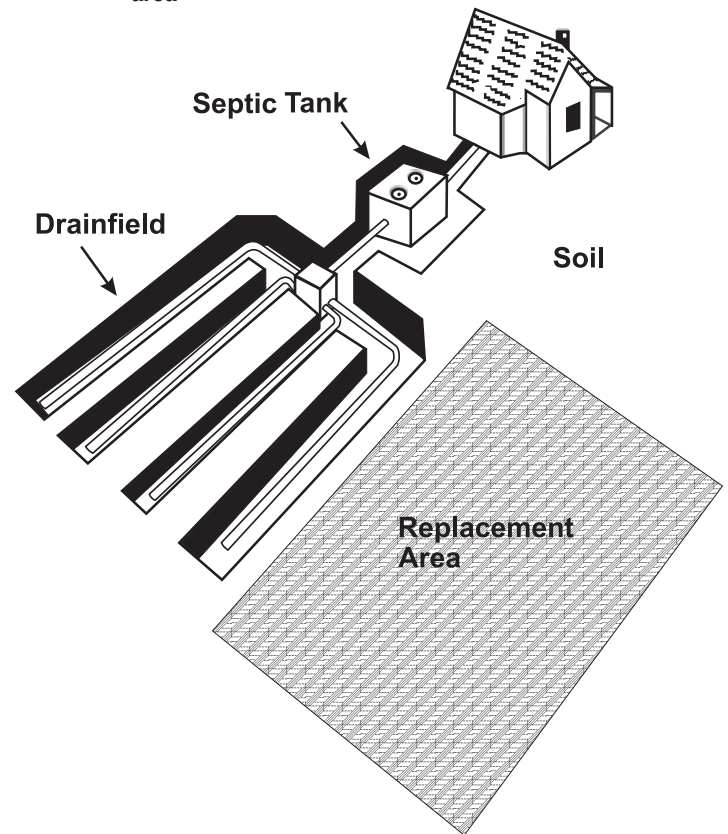
The objective of the detailed evaluation is to evaluate and document site conditions and characteristics in sufficient detail to allow interpretation and use by others in designing, siting, and installing the system. Because detailed investigations can be costly, they should not be performed unless the preliminary and reconnaissance evaluations indicate a high probability that the site is suitable. Detailed site evaluations should attempt to identify critical site characteristics and design boundaries that affect site suitability and system design. At a minimum, the detailed investigation should include soil profile descriptions and topographic mapping. (See figure 5-8, Site Evaluation/Site Plan Checklist.) Several backhoe pits, deep soil borings, soil permeability measurements, ground water characterizations, and pilot infiltration testing processes may be necessary for large subsurface infiltration systems. For evapotranspiration systems, field measurements of pan evaporation rates or other parameters, as appropriate, might be necessary. This information should be presented with an accurate site plan.

The detailed evaluation should address surface features such as topography, drainage, vegetation, site improvements, property boundaries, and other significant features identified during the reconnaissance survey. Subsurface features to be addressed include soil characteristics, depth to bedrock and ground water, subsurface drainage, presence of rock in the subsoil, and identification of hydraulic and treatment boundaries. Information must be conveyed using standardized nomenclature for soil descriptions and hydrological conditions. Testing procedures must follow accepted protocol and standards. Forms or formats and evaluation processes specified by regulatory or management agencies must also be used (for a state example see [http://www.deh.enr.state.nc.us/oww/LOSWW/soil\\_form.pdf](http://www.deh.enr.state.nc.us/oww/LOSWW/soil_form.pdf)).

### 5.5.6 Describing the soil profile

Descriptions and documentation of soil profiles provide invaluable information for designing onsite systems that use soil as the final wastewater

Figure 5-7. Conventional system layout with SWIS replacement area



treatment and dispersal medium. Detailed soil characterizations are provided through observation, description, and documentation of exposed soil profiles within backhoe-excavated test pits. Profiles can be described using a hand auger or drill probe for any single-home SWISs site in known soil and hydrogeology. However, backhoe-excavated test pits should be used wherever large SWISs or difficult single-home sites are proposed because of the quality of information gained. The grinding action or compression forces from soil borings taken with a hand auger or drill probe limit the information obtained for some soil characteristics, especially structure, consistency, and soil horizon relationships. Depending on project size, it might be necessary to supplement soil evaluation test pits with deep borings to provide more detail regarding soil substratum, ground water, and bedrock conditions. Table 5-7 summarizes the processes and procedures discussed below.

It might not be possible to identify all design boundaries, such as the permanent water table

**Figure 5-8. Site evaluation/site plan checklist**

<b>Owner/Client Information</b>	
Name _____	Contact nos. _____
Address _____	
Projected design flow _____ GPD	
Existing use _____	Intended use _____
Legal description _____	
Directions to site _____	
<b>Surface Features</b>	
_____ Benchmark description	_____ Assigned elevation _____ ft
_____ Property boundaries	_____ Surface water features
_____ Existing/proposed structures	_____ Existing/proposed water supply wells
_____ Existing/proposed wastewater systems	_____ Utility locations
_____ Soil investigation points	_____ Location of area of suitable soils
_____ Contour elevations	_____ Slope aspect & percent
_____ Proposed system component locations	_____ Other significant features
_____ North arrow	_____ Scale
Comments _____	

Figure 5-8. Site evaluation/site plan checklist (cont.)

**Subsurface Features**

\_\_\_\_\_ Detailed soil descriptions (horizon depth, texture, color, structure, redoximorphic features, consistence, moisture, roots, and boundaries) (Use USDA nomenclature)

\_\_\_\_\_ Depth and thickness of strong textural contrasts

\_\_\_\_\_ Depth to seasonal saturation                      \_\_\_\_\_ Depth to perched water table

\_\_\_\_\_ Soil testing results                                      \_\_\_\_\_ Soil samples collected

\_\_\_\_\_ Parent material    \_\_\_\_\_ Soil formation factors

\_\_\_\_\_ Deep completed    \_\_\_\_\_ Depth

\_\_\_\_\_ Depth to bedrock    \_\_\_\_\_ Type of bedrock

\_\_\_\_\_ Depth to permanent water table                      \_\_\_\_\_ Sample

\_\_\_\_\_ Ground water flow direction                      \_\_\_\_\_ Ground water gradient

Comments \_\_\_\_\_

\_\_\_\_\_

\_\_\_\_\_

\_\_\_\_\_

\_\_\_\_\_

\_\_\_\_\_

\_\_\_\_\_

\_\_\_\_\_

\_\_\_\_\_

\_\_\_\_\_

\_\_\_\_\_

Site Evaluator \_\_\_\_\_

\_\_\_\_\_

\_\_\_\_\_ Date \_\_\_\_\_

\_\_\_\_\_

\_\_\_\_\_

Site Evaluation Type:                      Desktop \_\_\_\_\_ Preliminary \_\_\_\_\_ Detailed \_\_\_\_\_



Table 5-7. Practices to characterize subsurface conditions through test pit inspection

Description of activity	Process steps	Information to be collected
Select backhoe pit site	Pick site near but not in proposed drain field; orient pit so sunlight illuminates vertical face of pit	Location of soil absorption field
Excavate pit	Excavate to depth required by agency regulations	Required ground water or seasonally high water table separation distance, soil profile depth
Enter test pit	Take safety precautions; beware of cave-ins; select area of pit wall to examine	Safe depths for unbraced pit walls
Expose natural soil structure	Use soil knife, blade, screwdriver or other tool to pick at area 0.5 m wide along full height of pit wall	Soil structural type (e.g., prismatic, columnar, angular blocky, subangular blocky, platy, granular)
Describe soil horizons	Note master soil horizon layers; describe features of each horizon	<ul style="list-style-type: none"> <li>✓ List soil horizon features:</li> <li>✓ Depth of horizon, thickness</li> <li>✓ Moisture content</li> <li>✓ Color (hue, value, chroma)</li> <li>✓ Volumetric percentage of rock</li> <li>✓ Size, shape, type of rock</li> <li>✓ Texture of &lt; 2 mm fraction of horizon</li> <li>✓ Presence/absence of mottles</li> <li>✓ Soil structure by grade</li> <li>✓ Level of cementation</li> <li>✓ Presence/absence of carbonates</li> <li>✓ Soil penetration resistance</li> <li>✓ Abundance, size, distribution of roots</li> </ul>
Determine soil changes	Look for lateral changes in soil profile; use auger and/or compare to profile of second pit	Determine changes, if any, in soil profile across proposed site
Interpret results	Identify limiting depths	<ul style="list-style-type: none"> <li>✓ Check vertical separation distances</li> <li>✓ Identify mottled layers, concretions</li> <li>✓ Determine depth to saturation</li> <li>✓ Measure depth to confining layer</li> <li>✓ Identify highly permeable layers</li> </ul>
Issue site report	Log all data onto required survey forms in required format	Develop system type, size location, and installation recommendations

Source: ASTM, 1996b.

surface or bedrock, if they are beyond shallow exploration depths (5 to 8 feet). However, it is imperative to identify and characterize secondary design boundaries that occur within the range of subsurface investigation. Soil characteristics should be described using USDA NRCS nomenclature and assessed by using standardized field soil evaluation procedures as identified in the *Field Book for Describing and Sampling Soils* (Shoeneberger et al., 1998), which is available on

the Internet at [http://www.statlab.iastate.edu/soils/nssc/field\\_gd/field\\_gd.pdf](http://www.statlab.iastate.edu/soils/nssc/field_gd/field_gd.pdf).

Another source for the description of soils in the field is American Society for Testing and Materials (ASTM) Standard D 5921-96, *Standard Practice for Subsurface Site Characterization of Test Pits for On-Site Septic Systems* (ASTM, 1996), which is summarized in table 5-7. The primary ASTM soil characterization reference is *Standard Practice for Classification of Soils for Engineering Purposes (Unified Soil Classification System)*, ASTM D 2487-00. The ASTM and

NRCS soil classification systems have many similarities; both describe and categorize soils according to silt, clay, and sand composition and relative plasticity. However, the NRCS guide cited above is a field guide and is based on soil characterization procedures that can be conducted through tactile and visual techniques in the field (e.g., the feel of a soil sample, visual identification of the presence and color of concretions and mottles) with minimal equipment. The ASTM approach requires laboratory analysis of soil particle size (with a series of sieves), plasticity, and organic content (ASTM, 2000) and is more commonly used in the engineering profession. Both approaches meet the technical requirements for conducting the site evaluation process described in this section.

Based on the proposed design flow, an area equal to approximately 200 percent of the estimated required treatment area should be investigated. Test pits should be spaced in a manner that provides a reasonable degree of confidence that conditions are similar between pits. For small cluster systems, three to five test pits may be sufficient if located around the periphery and in the center of the proposed infiltration area. Large projects require more test pits. Test pit spacing can be adjusted based on landscape position and observed conditions. Hand auger borings or soil probes may be used to confirm conditions between or at peripheral test pit locations. Soil profiles should be observed and documented under similar conditions of light and moisture content. Features that should be noted include the following:

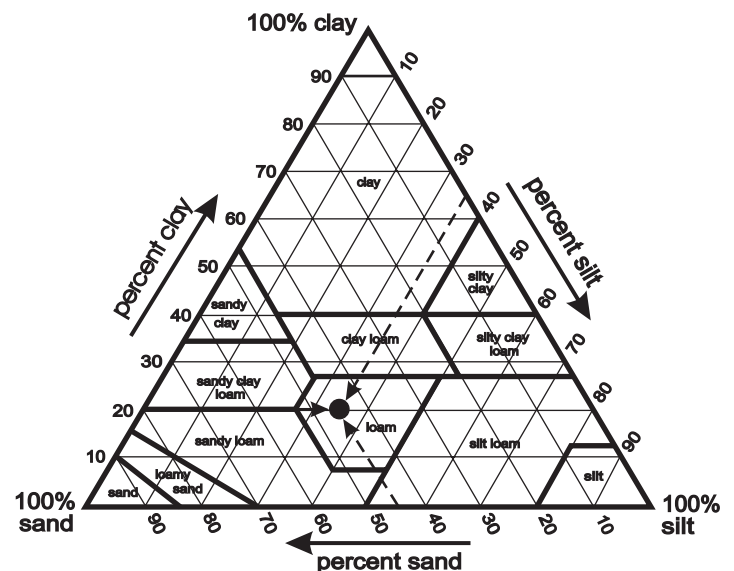
- Soil depth.* Test pits should be excavated to a safe depth to describe soil conditions, typically 4 feet below the proposed infiltrative surface. A vertical wall exposed to the sunlight is best for examination. The wall should be picked with a shovel or knife to provide an undisturbed profile for evaluation and description. Horizon thickness should be measured and the soil properties described for each horizon.

Restrictive horizons that may be significant secondary design boundaries must be noted. The depths of each horizon should be measured to develop a relationship with conditions in other test pits. Soil below the floor of the backhoe pit can be investigated by using hand augers in the excavated pit bottom or by using deep boring equipment.

Key soil properties that describe a soil profile are horizons, texture, structure, color, and redoximorphic features (soft masses, nodules, or concretions of iron or manganese oxides often linked to saturated conditions). Other properties include moisture content, porosity, rupture resistance (resistance to applied stress), penetration resistance, roots, clay mineralogy, boundaries, and coatings. Attention to the listed key soil properties will provide the most value in determining water movement in soil.

- Horizons.* A soil horizon is a layer of soil that exhibits similar properties and is generally denoted based on texture and color. Soil horizons result from natural soil-forming processes and human practices. Horizons are designated as master horizons and layers with subordinate distinctions. All key soil properties and associated properties that are relevant to water movement and wastewater treatment should be described. Particular attention should be given to horizons with strong textural contrast, stratified materials, and redoximorphic indicators that suggest a restriction to vertical water movement. Certain soil conditions that create a design boundary can occur within a soil horizon or layer. These include horizons with low perme-

Figure 5-9. Soil textural triangle



Source: USDA, 1951.

ability that perch water, indurated or massive horizons, or substrata of dense glacial till.

- **Texture.** Soil texture is defined as the percentage by weight of separates (sand, silt, and clay) that make up the physical composition of a given sample. It is one indicator of a soil's ability to transmit water. The textural triangle (figure 5-9) is used to identify soil textures based on percentage of separates (Schoeneberger et al., 1998).

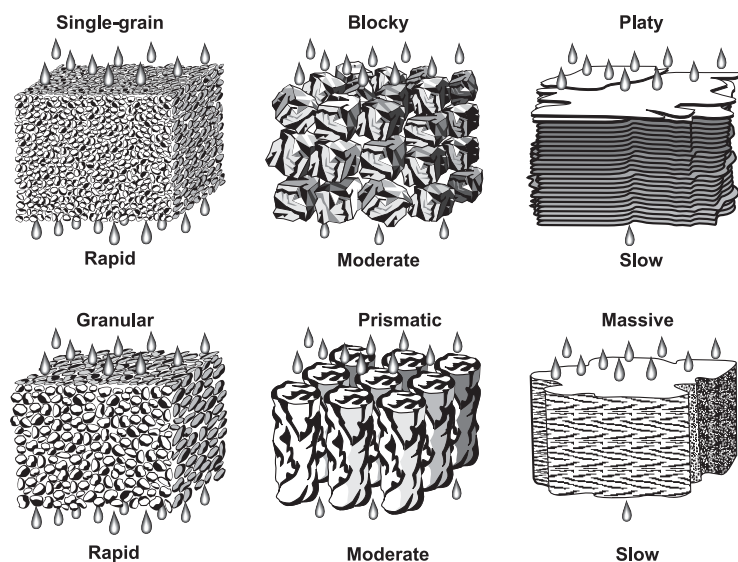
The texture of soil profiles is typically identified in the field through hand texturing. The evaluator's skill and experience play an important role in the accuracy of field texturing. Several field guides, typically in the form of flow charts, are available to assist the evaluator in learning this skill and to assist with identifying the texture of soils that occur at or near texture boundaries. (ASTM, 1997)

- **Structure.** Structure is more important than texture for determining water movement in soils. Soil structure is the aggregation of soil particles into larger units called peds. The more common types of structure are granular, angular blocky, subangular blocky, and platy (figure 5-10). Structureless soils include single-grain soils (e.g., sand) and massive soils (e.g., hardpan). The grade, size, shape, and orientation of soil peds influence water movement in the soil profile. This is especially true in fine-textured

soils. Smaller peds create more inter-pedal fractures, which provide more flow paths for percolating water. Grade, which defines the distinctness of peds, is important for establishing a soil loading rate for wastewater dispersal. A soil with a "strong" grade of structure has clearly defined fractures or voids between the peds for the transmittance of water. The inter-pedal fractures and voids in a soil with a "weak" grade are less distinct and offer more resistance to water flow. Soils with a strong grade can accept higher hydraulic loadings than soils with a weak grade. Platy and massive soils restrict the vertical movement of water.

- **Color.** Color is an obvious property of soil that is easily discernible. It is an excellent indicator of the soil's aeration status and moisture regime. Soil colors are described using the Munsell color system, which divides colors into three elements—hue, value, and chroma (Munsell, 1994). Hue relates to the quality of color, value indicates the degree of lightness or darkness, and chroma is the purity of the spectral color. Munsell soil color books are commercially available and are universally accepted as the standard for identifying soil color. The dominant or matrix color is determined for each horizon, and secondary colors are determined for redoximorphic features, ped coatings, mineral concretions, and other distinctive soil features. Dark colors generally indicate higher organic content, high-chroma colors usually suggest highly oxygenated soils or high iron content, and low-chroma soils imply reduced conditions often associated with saturation. The site evaluator must be aware that colors can be modified by temperature, mineralogy, vegetation, ped coatings, and position in the soil profile.
- **Redoximorphic features.** Redoximorphic features are used to identify aquic moisture regimes in soils. An aquic moisture regime occurs when the soil is saturated with water during long periods, an indicator of possible restrictive horizons, seasonal high water tables, or perched water tables. The presence of redoximorphic features suggests that the surrounding soil is periodically or continuously saturated. This condition is important to identify because saturated soils prevent reaeration of the vadose zone below infiltration systems and reduce the hydraulic gradients necessary for

Figure 5-10. Types of soil structure



Source: USDA, 1951.

adequate drainage. Saturated conditions can lead to surfacing of wastewater or failure due to significant decreases in soil percolation rates. Redoximorphic features include iron nodules and mottles that form in seasonally saturated soils by the reduction, translocation, and oxidation of iron and manganese oxides (Vespaskas, 1996). Redoximorphic features have replaced mottles and low-chroma colors in the USDA NRCS soil taxonomy because mottles include carbonate accumulations and organic stains that are not related to saturation and reduction. It is important to note that redoximorphic features are largely the result of biochemical activity and therefore do not occur in soils with low amounts of organic carbon, high pH (more than 7 standard pH units), low soil temperatures, or low amounts of iron, or where the ground water is aerated. Vespaskas (1996) provides an excellent guide to the identification of redoximorphic features and their interpretation. As noted, the NRCS online guide to redoximorphic and other soil properties at [http://www.statlab.iastate.edu/soils/nssc/field\\_gd/field\\_gd.pdf](http://www.statlab.iastate.edu/soils/nssc/field_gd/field_gd.pdf) addresses key identification and characterization procedures for redoximorphic and other soil features.

- *Soil consistence.* Soil consistence in the general sense refers to attributes of soil as expressed in degree of cohesion and adhesion, or in resistance to deformation or rupture. Consistence includes the resistance of soil material to rupture; the resistance to penetration; the plasticity, toughness, or stickiness of puddled soil material; and the manner in which the soil material behaves when subjected to compression. Consistence is highly dependent on the soil-water state. The general classifications of soil consistence are loose, friable, firm, and extremely firm. Soils classified as firm and extremely firm tend to block subsurface wastewater flows. These soils can become cemented when dry and can exhibit considerable plasticity when wet. Soils that exhibit extremely firm consistence are not recommended for conventional infiltration systems.
- *Restrictive horizons.* Soil properties like penetration resistance, rooting depth, and clay mineralogy are important indicators of soil porosity and hydraulic conductivity. Penetration resistance is often correlated with the soil's bulk

density. The greater the penetration resistance, the more compacted and less permeable the soil is likely to be. Rooting depth is another measure of bulk density and also soil wetness. Clay mineralogies such as montmorillonite, which expand when wetted, reduce soil permeability and hydraulic conductivity significantly. A discussion of these properties and their description can also be found in the USDA Soil Survey Manual (USDA, 1993) and the USDA NRCS *Field Book for Describing and Sampling Soils* (Schoeneberger et al., 1998).

- *Other soil properties.* Other soil properties that affect nutrient removal are organic content and phosphorus adsorption potential. Organic content can provide a carbon source (from decaying organic matter in the uppermost soil horizons) that will aid denitrification of nitrified effluent (nitrate) in anoxic regions of the SWIS. Phosphorus can be effectively removed from wastewater effluent by soil through adsorption and precipitation reactions (see chapter 3). Soil mineralogy and pH affect the soil's capacity to retain phosphorus. Adsorption isotherm tests provide a conservative measure of the potential phosphorus retention capacity.
- *Characterization of unconsolidated material.* Geologists define unconsolidated material as the material occurring between the earth's surface and the underlying bedrock. Soil forms in this parent material from the actions of wind, water, or alluvial or glacial deposition. Soil scientists refer to the soil portion of unconsolidated material as the solum and the parent material as the substratum. Typically, site evaluators expose the solum and the upper portion of the substratum. Knowledge of the type of parent material and noted restrictions or boundary conditions is important to the designer, particularly for large wastewater infiltration systems. Often, if the substratum is deep, normal test pit depth will be insufficient and deep borings may be necessary.

### 5.5.7 Estimating infiltration rate and hydraulic conductivity

Knowledge of the soil's capacity to accept and transmit water is critical for design. The infiltration rate is the rate at which water is accepted by the soil. Hydraulic conductivity is the rate at which



water is transmitted through the soil. As wastewater is applied to the soil, the infiltration rate typically declines well below the saturated hydraulic conductivity of the soil. This occurs because the biodegradable materials and nutrients in the wastewater stimulate microbiological activity that produces new biomass (see chapter 3). The biomass produced and the suspended solids in the wastewater create a biomat that can fill many of the soil pores and close their entrances to water flow. The flow resistance created by the biomat can reduce the infiltration rate to several orders of magnitude less than the soil's saturated hydraulic conductivity. The magnitude of the resistance created by the biomat is a function of the BOD and suspended solids in the applied wastewater and the initial hydraulic conductivity of the soil.

Estimating the design infiltration rate is difficult. Historically, the percolation test has been used to estimate the infiltration rate. The percolation test was developed to provide an estimate of the soil's saturated hydraulic conductivity. Based on experience with operating subsurface infiltration systems, an empirical factor was applied to the percolation test result to provide a design infiltration rate. This method of estimating the design infiltration rate has many flaws, and many programs that regulate onsite systems have abandoned it in favor of detailed soil profile descriptions. Soil texture and structure have been found to correlate better with the infiltration rate of domestic septic tank effluent (Converse and Tyler, 1994). For other applied effluent qualities such as secondary effluent, the correlation with texture and structure is less well known.

Information on the hydraulic conductivity of the soil below the infiltrative surface is necessary for ground water mounding analysis and estimation of the maximum hydraulic loading rate for the infiltration area. There are both field and laboratory methods for estimating saturated hydraulic conductivity. Field tests include flooding basin, single- or double-ring infiltrometer, and air entry permeameter. These and other field test procedures are described elsewhere (ASTM, 1997; Black, 1965; USEPA, 1981; 1984). Laboratory methods are less accurate because they are performed on small soil samples that are disturbed from their natural state when they are taken. Of the laboratory tests, the concentric ring permeameter (Hill and King, 1982) and the cube method (Bouma and Dekker, 1981) are

the most useful techniques. The American Society for Testing and Materials posts permeameter information on its Internet site at <http://www.astm.org> (see *ASTM Store*, *ASTM Standards*).

## **5.5.8 Characterizing the ground water table**

Where ground water is present within 5 feet below small infiltration systems and 10 to 15 feet below large systems, the hydraulic response of the water table to prolonged loading should be evaluated. The ground water can be adversely affected by treated wastewater and under certain conditions can influence system performance. This information is valuable for understanding potential system impacts on ground water and how the system design can mitigate these impacts.

The depth, seasonal fluctuation, direction of flow, transmissivity, and, where possible, thickness of the water table should be estimated. With shallow, thin water tables, depth, thickness, and seasonal fluctuations can be determined through soil test pit examination. However, deeper water tables require the use of deep borings and possible installation of piezometers or monitoring wells. At least three piezometers, installed in a triangular pattern, are necessary to determine ground water gradient and direction of flow, which might be different from surface water flow direction. Estimating the saturated hydraulic conductivity of the aquifer materials is necessary to determine ground water travel velocity. Slug tests or pumping tests can be performed in one or more existing or new wells screened in the shallow water table to estimate the hydraulic conductivity of the aquifer (Bouwer, 1978; Bouwer and Rice, 1976; Cherry and Freeze, 1979). In some cases, it may be possible to estimate the saturated hydraulic conductivity from a particle size analysis of aquifer materials collected from the test pit, if the material is accessible (Bouwer, 1978; Cherry and Freeze, 1979). Pumping tests may also be used to determine the effective porosity or specific yield of the saturated zone.

Ground water mounding beneath an infiltration system can reduce both treatment and the hydraulic efficiency of the system. Ground water mounding occurs when the rate of water percolating vertically into the saturated zone exceeds the rate of ground water drainage from the site (figure 5-4). Mounding



is more likely to occur where the receiver site is relatively flat, the hydraulic conductivity of the saturated zone is low, or the saturated zone is thin. With continuous application, the water mounds beneath the infiltrative surface and reduces the vertical depth of the vadose zone. Reaeration of the soil, treatment efficiency, and the infiltration system's hydraulic capacity are all reduced when significant mounding occurs. A mounding analysis should be completed to determine site limits and acceptable design boundary loadings (linear hydraulic loading) for sites where the water table is shallow or the soil mantle is thin, or for any large infiltration system.

Both analytical and numerical ground water mounding models are available. Because of the large number of data points necessary for numerical modeling, analytical models are the most commonly used. Analytical models have been developed for various hydrogeologic conditions (Brock, 1976; Finnemore and Hantzshe, 1983; Hantush, 1967; Kahn et al., 1976). Also, commercial computer software is available to estimate mounding potential. The assumptions used in each model must be compared to the specific site conditions found to select the most appropriate model. For examples of model selection and model computations, see EPA's process design manual (USEPA, 1981, 1984). A USEPA Office of Ground Water and Drinking Water annotated bibliography of ground water and well field characterization modeling studies can be found on the Internet at <http://www.epa.gov/ogwdw000/swp/wellhead/dewell.html#analytical>. USGS has available a number of software packages, which are posted at [http://water.usgs.gov/software/ground\\_water.html](http://water.usgs.gov/software/ground_water.html). For links to software suppliers or general information, visit the National Ground Water Association web site at <http://www.ngwa.org/>.

### 5.5.9 Assessments for point source and evapotranspiration discharges

Sites proposed for point discharges to surface waters require a permit from the National Pollutant Discharge Elimination System (see <http://www.epa.gov/owm/npdes.htm>) and a suitable location for an outfall to a receiving water body. Considerations for locating an outfall structure include NPDES regulatory requirements, outfall

structure siting, routing from the treatment facility, construction logistics and expense, and aesthetics. Regulatory requirements generally address acceptable entry points to receiving waters and hydraulic and pollutant loadings. The state regulatory agency typically sets effluent limits based on the water resource classification, stream flow, and assimilative capacity of the receiving water. Assimilative capacities take into account the entire drainage basin or watershed of nearby receiving waters to ensure that pollutant levels do not exceed water quality criteria. (See table 3-21 for applicable Drinking Water Standards; USEPA Drinking Water Standards are posted at <http://www.epa.gov/ogwdw000/creg.html>.) In the case of state-listed impaired streams (those listed under section 303(d) of the Clean Water Act), discharges must consider pollutant loads established or proposed under the Total Maximum Daily Load provisions of the Clean Water Act. Piping from the treatment facility needs to consider gravity or forcemain, route, existing utilities, and other obstacles to be avoided.

Evapotranspiration (ET) systems treat and discharge wastewater by evaporation from the soil or water surface or by plant transpiration. These systems are climate-sensitive and require large land areas. ET systems function best in arid climates where there is large annual net evaporation and active vegetative growth year-round. In the United States this generally means only the southwestern states, where humidity is low, rainfall is minimal, and temperatures are warm enough to permit active plant growth during the winter season (figure 5-11). Although the macroclimate of an area might be acceptable for the use of ET systems, evaluation of the microclimate is often required because it can significantly influence system performance. In addition to temperature, precipitation, and pan evaporation data, exposure position and prevalent wind direction should be considered as part of the evaluation process. Southern exposures in the northern hemisphere provides greater solar radiation. Exposure to wind provides greater drying of the soil and plant surfaces. Surface drainage patterns should also be assessed. Well-drained sites have a lower ambient humidity to enhance evaporation than poorly drained sites.

## 5.6 Mapping the site

At the completion of the site evaluation, a site map or sketch should be prepared to show physical features, locations of soil pits and borings, topography or slopes, and suitable receiver sites. If a map or aerial photograph was used, field measurements and locations can be noted directly on it. Otherwise it will be necessary to take measurements and sketch the site. The level of effort for developing a good site map should be commensurate with the results of the site evaluation and whether the site map is being completed for a preliminary or detailed site evaluation.

In addition to the features of the site under consideration, the site map should show adjacent lands and land uses that could affect treatment system layout, construction, and system performance. Maps with a 1- or 2-foot contour interval are preferred.

## 5.7 Developing the initial system design

Developing a concept for the initial system design is based on integration of projected wastewater volume, flow, and composition information; the controlling design boundaries of the selected receiving environment; the performance requirements for the chosen receiving environment; and the needs and desires of the owner (figure 5-12). The site evaluation identifies the critical design boundaries and the maximum mass loadings they can accept. This knowledge, together with the performance requirements promulgated by the regulating authority for the receiving environment, establishes the design boundary loadings. Once the boundary loadings are established, treatment trains that will meet the performance requirements can be assembled.

Figure 5-11. Potential evaporation versus mean annual precipitation

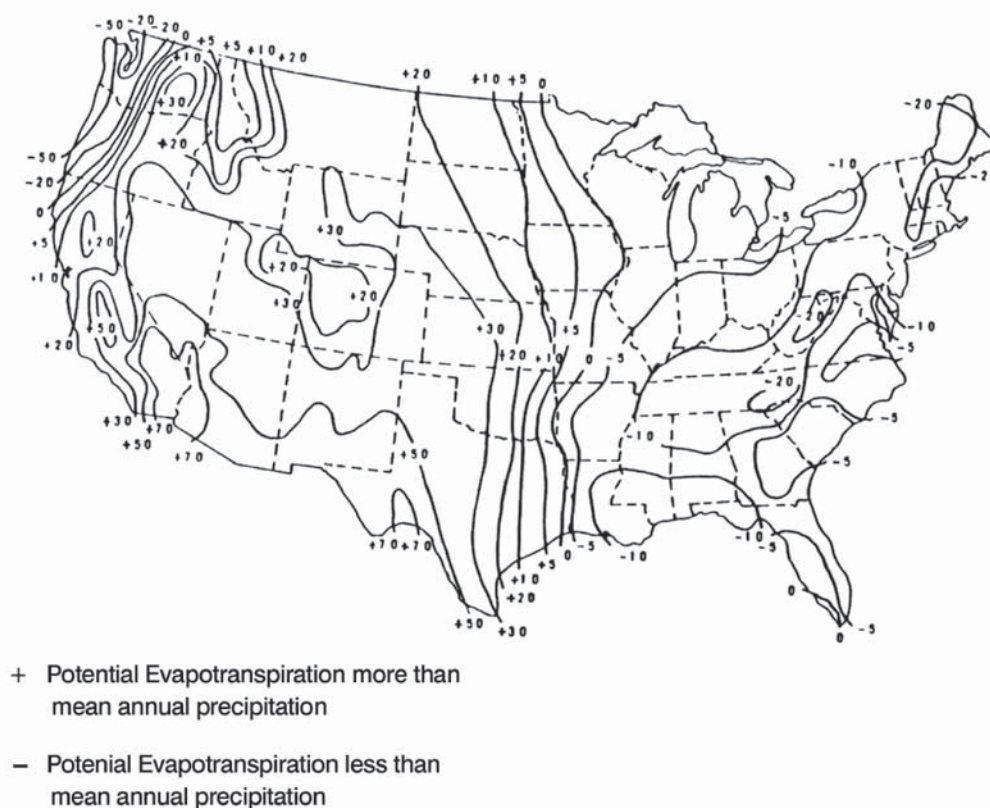
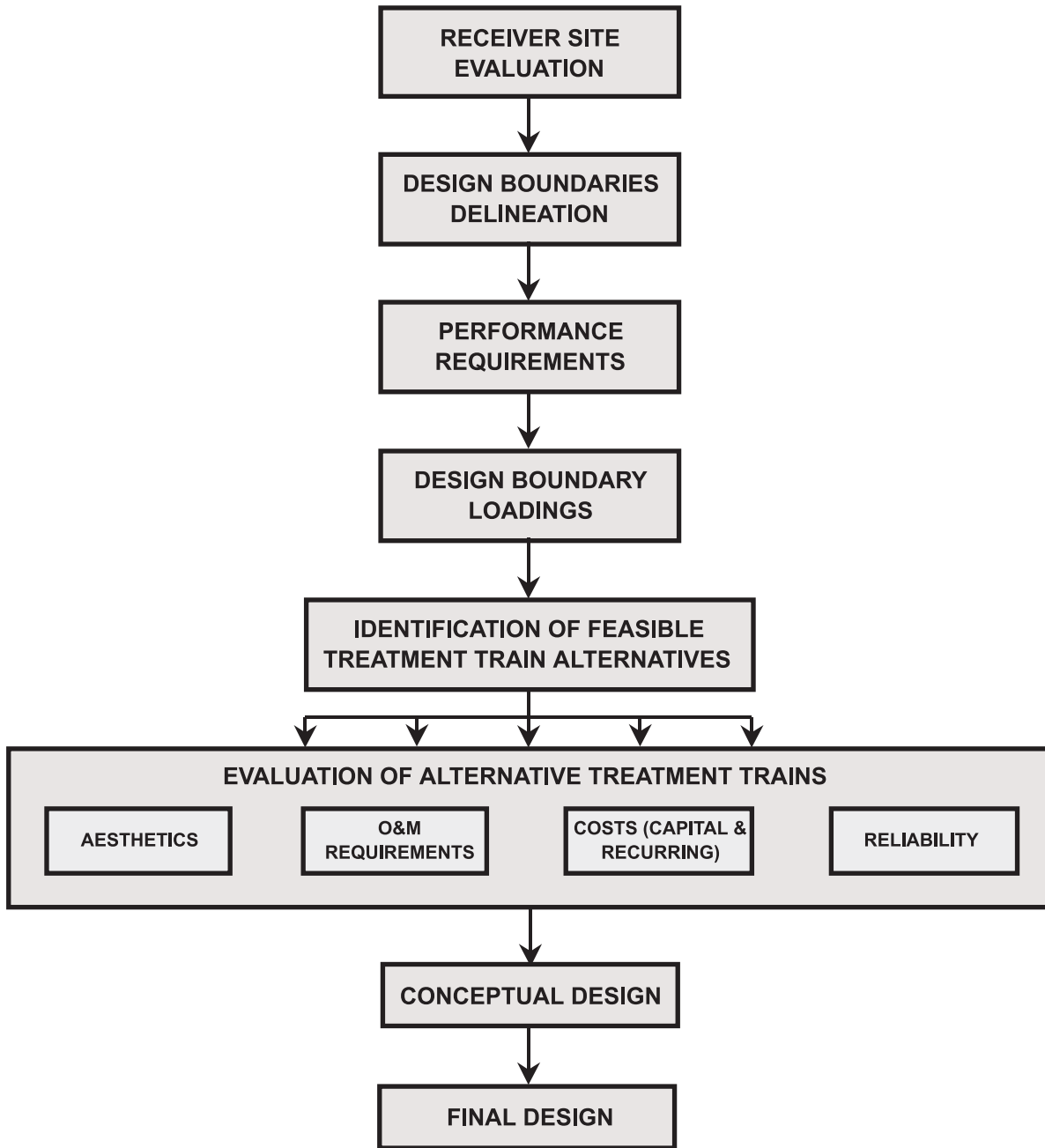


Figure 5-12. Development of the onsite wastewater system design concept



## Assembling SWIS treatment trains for a site with shallow, slowly permeable soils over bedrock

### Site description

A single-family residence is proposed for a lot with shallow, finely textured, slowly permeable soil over creviced bedrock. The depth of soil is 2 feet. The slope of the lot is moderate and is controlled by bedrock. Ground water is more than 5 feet below the bedrock surface.

### Design boundaries

Three obvious design boundaries that will affect the SWIS design are present on this site: the infiltrative surface, the bedrock surface, and the water table. The site evaluation determined that no hydraulically restrictive horizon is present in the soil profile above the bedrock.

### Performance requirements

The regulatory agency requires that the wastewater discharge remain below ground surface at all times, that the ground water contain no detectable fecal coliforms, and that the nitrate concentrations of the ground water be less than 10 mg-N/L at the property boundary. In this case study, wastewater modification (reducing mass pollutant loads or implementing water conservation measures; see chapter 3) was not considered.

### Design boundary mass loadings

**Infiltrative surface:** Referring to table 5-2, the mass loadings that might affect the infiltrative surface are the daily, instantaneous, and organic mass loadings. The selected hydraulic and instantaneous (dose volume per square foot) loading rates must be appropriate for the characteristics of the soil to prevent surface seepage. Assuming domestic septic tank effluent is discharged to the infiltrative surface and that the surface is placed in the natural soil, the organic mass loading is accounted for in the commonly used daily hydraulic loading rates. Typical hydraulic loading rates for domestic septic tank effluent control design. Reducing the organic concentration through pretreatment will have little impact because the resistance of the biomat created by the organic content is typically less than the resistance to flow through the fine-textured soil.

**Bedrock boundary:** The bedrock boundary is a secondary design boundary where a zone of saturation will form as the wastewater percolates through the soil. This boundary is affected by the daily and linear hydraulic loadings (table 5-2). If these hydraulic loadings exceed the rate at which the water is able to drain laterally from the site or percolate to the water table through the bedrock crevices, the saturated zone thickness will increase and could encroach on the infiltrative surface, reducing its treatment and hydraulic capacity. Because the site is sloping, the linear, rather than the daily, hydraulic loading will control design.

**Water table boundary:** The wastewater percolate will enter the ground water through the bedrock crevices. The daily and linear hydraulic loading and constituent loadings are the mass loadings that can affect this boundary (table 5-2). Because of the depth of the water table below the bedrock surface and the porous nature of the creviced bedrock, the daily and linear hydraulic loadings are not of concern. However, nitrate-nitrogen and fecal coliforms are critical design loadings because of the water quality requirements. Table 5-2 summarizes the critical design boundary mass loadings that will affect design.

### Assembling feasible treatment train alternatives

Because control of the wastewater is lost after it is applied to the soil, the bedrock and water table boundary loading requirements must be satisfied through appropriate design considerations at or before the infiltrative boundary. Therefore, the secondary and water table boundary loadings must be considered first.

Constituent loading limits at the ground water boundary will control treatment requirements. Although the performance boundary (the point at which performance requirements are measured) may be at the property boundary, mixing and dilution in the ground water cannot be certain because the bedrock crevices can act as direct conduits for transporting undiluted wastewater percolate. Therefore, it would be prudent to ensure these pollutants are removed before they can leach to the ground water. Research has demonstrated that soils similar to those present at the site (fine-textured, slowly permeable soils) can effectively remove the fecal

coliforms if the wastewater percolates through an unsaturated zone of 2 to 3 feet (Florida HRS, 1993). Because the soil at the site extends to only a 2-foot depth, the infiltrative surface would need to be elevated 1 foot above the ground surface in a mound or at-grade system. Alternatively, disinfection prior to soil application could be used. Nitrate is not effectively removed by unsaturated, aerated soil; therefore, pretreatment for nitrogen removal is required.

Maintaining the linear loading at the bedrock surface below the maximum acceptable rate determines the orientation and geometry of the infiltrative surface. The infiltrative surface will need to be oriented parallel to the bedrock surface contour. Its geometry needs to be long and narrow, with a width no greater than the maximum acceptable linear loading (gpd/ft) divided by the design hydraulic loading on the infiltrative surface (gpd/ft<sup>2</sup>). Note: If a mound is used on this site, an additional design boundary is created at the mound fill/natural soil interface. The daily hydraulic loading will affect this secondary design boundary.

If the perched saturated zone above the bedrock is expected to rise and fall with infiltrative surface loadings, the instantaneous loading to the infiltrative surface should be controlled through timed dosing to maximize the site's hydraulic capacity. Failure to control instantaneous loads could lead to transmission of partially treated wastewater through bedrock crevices, driven by the higher hydraulic head created during periods of peak system use. Applying the wastewater through a dosing regime will maximize retention time in the soil while ensuring cyclical flooding of the infiltration trenches, creating optimum conditions for denitrifying bacteria to accomplish nitrogen removal. The daily and instantaneous hydraulic loadings to the infiltrative surface are dependent on the characteristics of the soil or fill material in which the SWIS is placed.

Alternative	Pretreatment	Dosing	Infiltration
1	Nitrogen removal	Timed dosing	Mound with pressure distribution
2	Nitrogen removal with disinfection	Timed dosing	In-ground trenches with pressure distribution

From this boundary loading analysis, potential treatment train alternatives can be assembled. Table 4-1 and the fact sheets in chapter 4 should be used to select appropriate system components.

**Alternative 1** elevates the infiltrative surface in a mound of suitable sand fill. With at least a foot of fill and the unsaturated 2 feet of natural soil below, fecal coliform removal will be nearly complete. The mound would be designed as long and narrow, oriented parallel to the bedrock surface contours (equivalent to the land surface contours since the slope is bedrock-controlled) to control the linear loading on the interface between the sand fill and natural soil or at the bedrock surface. The infiltrative surface would be time-dosed through a pressure or drip distribution network to distribute the wastewater onto the surface uniformly in time and space.

**Alternative 2** places the infiltrative surface in the natural soil. With this design, there would be an insufficient depth of unsaturated soil to remove the fecal coliforms. Therefore, disinfection of the treated wastewater prior to application to the soil would be necessary. The trenches would be oriented parallel to the bedrock surface contours (equivalent to the land surface contours since the slope is bedrock-controlled) to control the linear loading on the bedrock surface. If multiple trenches are used, the total daily volume of treated wastewater applied per linear foot of trench parallel to the slope of the bedrock surface would be no greater than the design linear loading for the site. Loadings to the infiltrative surface would be time-dosed through a pressure or drip distribution network to distribute the wastewater uniformly in time and space.

Note that for the alternatives listed, multiple options exist for each of the system's components (see table 4-1).

Source: Otis, 2001.



### Subsurface wastewater infiltration system design in a restricted area

Often, the available area with soils suitable for subsurface infiltration of wastewater is limited. Because local authorities usually do not permit point discharges to surface waters, subsurface infiltration usually is the only option for wastewater treatment. However, a SWIS can perform as required only if the daily wastewater flow is less than the site's hydraulic capacity.

The hydraulic capacity of the site is determined by the subsurface drainage capacity of the site. The drainage capacity is defined by the soil profile and the daily hydraulic or linear mass loading to secondary or ground water boundary surfaces. In some cases, however, the infiltration rate of the wastewater into the soil at the infiltrative boundary is more limiting. Therefore, it is important to distinguish between the two boundaries if use of the site is to be maximized. Where hydraulic loadings to secondary boundaries are the principal control feature, the only option is to limit the amount of water applied to the secondary boundaries. This can be accomplished through the following:

#### **Orientation, geometry, and controlled dosing of the infiltrative surface**

The infiltrative surface should be oriented parallel to and extended as much as possible along the surface contour of the secondary boundary. Southern, eastern, and western exposures may provide better evaporation than north-facing slopes. The daily hydraulic loading rate onto the total downslope projection of "stacked" infiltration surfaces (multiple, evenly spaced SWIS trenches placed on the contour on sloping terrain) should be limited to the maximum linear loading of the secondary boundary. Timed dosing to the infiltrative surfaces should be used to apply wastewater uniformly over the full length of the infiltrative surfaces to minimize the depth of soil saturation over the secondary boundary. Note that the presence of other SWIS-based treatment systems above or below the site should be considered in load calculations and design concept development.

#### **Installation of water-conserving plumbing fixtures in the building served**

The total daily volume of wastewater generated can be significantly reduced by installation of water-conserving fixtures such as low-volume flush toilets and low-flow showerheads (see chapter 3). Also, wastewater inputs from tub spas and automatic regenerating water softeners should be eliminated.

#### **Maximizing the evapotranspiration potential of the infiltration system**

Where the growing season is long or use of the property is limited to the summer months, evapotranspiration can help to reduce the total hydraulic loading to the secondary boundary. The infiltrative surfaces should be shallow and located in open, grassed areas with southern exposures (in the Northern Hemisphere).

#### **If the infiltration capacity at the soil's infiltrative surface is the limiting condition, measures to increase infiltration can be taken. These measures include the following:**

Reducing the mass loadings of soil clogging constituents on the infiltrative surface

The mass loadings to the infiltrative surface can be reduced either by increasing the infiltrative surface area to reduce the mass constituent loading per unit of area or by removing the soil-clogging constituents before soil application. Where the suitable area for the SWIS is limited, increasing the infiltrative surface area might not be possible.

#### **Controlled dosing of the infiltrative surface**

Timed dosing and alternate "resting" of infiltrative surfaces allow organic materials that might clog the soil surface to oxidize, helping to rejuvenate infiltrative capacity. Using multiple timed doses throughout the day with intervals between doses to allow air diffusion maximizes the reaeration potential of the subsoil (Otis, 1997). Dual infiltration systems that can be alternately loaded allow for annual resting of the infiltrative surfaces to oxidize the biomat. On small lots dual systems are often not feasible because of space limitations.

Source: Otis, 2001.

### 5.7.1 Identifying appropriate treatment trains

Multiple treatment trains (system designs) are often feasible for a particular receiver site and expected wastewater flow. More than one receiving environment may be suitable for a treated discharge. For example, subsurface infiltration or a point discharge to surface water might be feasible. Multiple sites on a property might be suitable as a receiver site. In addition, more than one treatment train might meet established or proposed performance requirements. Each of these alternatives must be considered to select the most appropriate system for a given application.

Evaluation of the feasible alternatives is a continuous activity throughout the preliminary design process. It is beneficial to eliminate as many potential options as possible early in the preliminary design process so that time can be spent on the most probable alternatives. Typically, receiving environments are the first to be eliminated. For example, in temperate climates atmospheric discharges are rarely feasible because there is insufficient net evaporation to evaporate the wastewater. Surface water discharges usually can be eliminated as well because often they are not permitted by the local regulatory agency. Where such discharges are permitted, subsurface infiltration is usually less costly if the site meets the regulatory agency's requirements because monitoring costs for compliance with point discharge permit requirements can be substantial.

At the completion of the site evaluation, the receiving environment has been tentatively selected (see section 5.5). For each potential receiver site, the design boundaries have been identified. Integrating information on physical limitations and established or proposed performance requirements helps to define the maximum mass loadings to the design boundaries (see section 5.3). Defining and characterizing the controlling design boundaries and their maximum acceptable mass loadings, estimating the characteristics of the wastewater to be treated, and evaluating the site conditions inform the development of a feasible set of potential treatment trains. Treatment train assembly is usually straightforward for surface water discharges because the effluent concentration limits at the outfall control design. With soil-based systems

such as SWISs, however, treatment train selection is more complex because multiple design boundaries can be involved.

Because direct control of SWIS performance is lost once the partially treated wastewater enters the soil at the infiltrative surface, management of the loadings to any secondary design boundaries and water table boundaries must be accomplished indirectly through appropriate adaptations at the primary infiltrative surface. For hydraulic loadings, control can be achieved by changing the geometry or size of the infiltrative surface or the dosing volume, frequency, and pattern. For organic or constituent loadings, control is achieved either by pretreating the wastewater before it is applied to the infiltrative surface or by increasing the size of the infiltrative surface.

### 5.7.2 Treatment train selection

Where multiple treatment trains are feasible and technically equivalent, each must be evaluated with respect to aesthetics, operation and maintenance requirements, cost, and reliability before selection of the final design concept.

### 5.7.3 Aesthetic considerations

Aesthetics are an intangible factor that must be addressed with the owner, users, adjacent property owners, and regulators. They include considerations such as system location preferences, appearance, disruption during construction, equipment and alarm noise, and odor potential. It is important that these and possibly other aesthetics issues be discussed with the appropriate parties before selecting the design concept to be used. If the expectations of the concerned parties are not met, their dissatisfaction with the system could affect its use and care.

### 5.7.4 Operation and maintenance requirements

Specific and appropriate operation and maintenance tasks and schedules are essential if a wastewater system is to perform properly over its intended service life. Important considerations include

- Types of maintenance functions that must be performed
- Frequency of routine maintenance
- Time and skills required to perform routine maintenance
- Availability of operation and maintenance service providers with appropriate skills
- Availability of factory service and replacement parts

Traditional onsite systems are passive in design, requiring little operator attention or skill. Unskilled owners can usually access maintenance services or be trained to perform basic maintenance tasks. Septage removal usually requires professional services, but these are readily available in most areas. More complex wastewater systems, however, require elevated levels of operator attention and skill. The designer must weigh the availability of operator services in the locale of the proposed system against the consequences of inadequate operation and maintenance before recommending a more complex system. The availability of factory service is also an important consideration. Where operation and maintenance services are not locally available and the use of alternative systems that have fewer operation and maintenance requirements is not an option, the prospective system owner should be advised fully before proceeding.

### 5.7.5 Costs

Costs of the feasible alternatives should be arrayed based on the *total cost* of each alternative. Total costs include both the capital costs incurred in planning, designing, and constructing the system and the long-term costs associated with maintaining the system over its design life (20 to 30 years in most cases; see table 5-8). This method of cost analysis is an equitable method of comparing alternatives with higher capital costs but lower annual operating costs to other alternatives with lower capital costs but higher annual operating costs. Often, owners are deceived by systems with lower capital costs. These systems might have much higher annual operating costs, a shorter design life, and possibly higher replacement costs, resulting in much higher total costs. Systems with higher capital costs might have lower total costs because the recurring operation and maintenance costs are less.

Choosing between alternatives with varying total cost options is a financing decision. In some cases, capital budgets are tighter than operating budgets. Therefore, this is a decision the prospective owner must make based on available financing options. Table 5-8 is an example of such a comparative analysis.

The USEPA Office of Wastewater Management posts financing information for onsite wastewater treatment systems or other decentralized systems (cluster systems not connected to a wastewater treatment plant) on the Internet at <http://www.epa.gov/owm/decent/funding.htm>. Links are available at that site to financing programs supported by a variety of federal, state, and other public and private organizations.

### 5.7.6 Reliability

The reliability of the proposed system and the risks to the owner, the public, and the environment if malfunctions or failures occur must be considered. Potential risks include public health and environmental risks, property damage, personal injury, medical expenses, fines, and penalties. Where these or other potential risks are significant, contingency plans should be developed to manage the risks. Contingencies include storage, pump and haul (holding tank), redundant components, reserve capacity, and designation of areas for repair or replacement components (e.g., replacement leach field). These come at additional cost, so their benefit must be weighed against the potential risks.

### 5.7.7 Conceptual design

After evaluating the feasible options, the preliminary treatment train components can be selected. At this point in the development of the design, the unit processes to be used and their sequence are defined. A preliminary layout should be prepared to confirm that the system will fit on the available site. Sufficient detail should be available to prepare a preliminary cost estimate if needed. It is recommended that the conceptual system design and preliminary layout be submitted to the regulatory agency for conditional acceptance of the chosen system. Final design can proceed upon acceptance by the owner and regulatory agency.

Table 5-8. Example of a total cost summary worksheet to compare alternatives<sup>a</sup>.

System	Total materials & installation	Present value of total O&M cost	Total cost over life of system	Amortized monthly materials & installation costs	Avg monthly present value of O&M costs	Avg monthly cost over life of system
Septic tank & gravity distribution	\$2,504	\$6,845	\$9,349	\$20	\$19	\$39
Septic tank & gravity distribution with chambers	\$3,336	\$7,032	\$10,368	\$27	\$20	\$46
Septic tank & gravity distribution with styrene foam	\$2,846	\$6,920	\$9,767	\$23	\$19	\$42
Septic tank & gravity distribution with large diameter pipes	\$3,816	\$7,156	\$10,971	\$31	\$20	\$51
Septic tank & gravity distribution with pressure manifold	\$4,774	\$7,707	\$12,482	\$38	\$21	\$60
Septic tank & gravity distribution with pressure manifold and chambers	\$5,593	\$7,889	\$13,482	\$45	\$22	\$67
Septic tank & gravity distribution with pressure manifold and styrene foam	\$5,103	\$7,777	\$12,881	\$41	\$22	\$63
Septic tank & gravity distribution with pressure manifold large diameter pipes	\$6,073	\$8,013	\$14,085	\$49	\$22	\$71
Septic tank & gravity distribution with sand filter pretreatment	\$7,296	\$12,069	\$19,364	\$59	\$34	\$92
Septic tank & gravity distribution with peat filter pretreatment	\$11,808	\$12,604	\$24,412	\$95	\$35	\$150
Septic tank & gravity distribution with recirculating sand filter pretreatment	\$6,226	\$12,059	\$18,285	\$50	\$33	\$84
Septic tank & LPP distribution	\$4,523	\$12,319	\$16,843	\$36	\$34	\$71
Septic tank & LPP distribution with sand filter pretreatment	\$10,223	\$13,338	\$23,561	\$82	\$37	\$119
Septic tank & LPP distribution with recirculating sand filter pretreatment	\$8,232	\$13,007	\$21,239	\$66	\$36	\$102
Septic tank & drip distribution	\$11,163	\$13,082	\$24,245	\$90	\$36	\$126
Septic tank & drip distribution with sand filter pretreatment	\$15,994	\$14,101	\$30,095	\$129	\$39	\$168
Septic tank & drip distribution with recirculating sand filter pretreatment	\$14,872	\$14,094	\$28,966	\$120	\$39	\$159
Septic tank & drip distribution with sand filter pretreatment & chlorine disinfection	\$16,408	\$21,244	\$37,652	\$132	\$59	\$191
Septic tank & drip distrib. with recirc. sand filter pretreatment & chlorine disinfection	\$15,285	\$21,237	\$36,522	\$123	\$59	\$182
Septic tank & drip distribution with sand filter pretreatment & UV disinfection	\$17,867	\$21,655	\$39,522	\$144	\$60	\$204
Septic tank & drip distribution with recirc. sand filter pretreatment & UV disinfection	\$16,744	\$21,757	\$38,501	\$135	\$60	\$195
Septic tank & spray irrigation with sand filter pretreatment and chlorine disinfection	\$11,890	\$20,670	\$32,580	\$96	\$57	\$153
Septic tank & spray irrigation with recirc. sand filter pretreatment and chlorination	\$10,768	\$20,663	\$31,431	\$87	\$57	\$144
Septic tank & spray irrigation with sand filter pretreatment and UV	\$13,349	\$21,190	\$34,539	\$107	\$59	\$166
Septic tank & spray irrigation with recirculating sand filter pretreatment and UV	\$12,227	\$21,183	\$33,410	\$98	\$59	\$157
Septic tank and gravity distribution with wetland cell	\$5,574	\$23,231	\$28,805	\$45	\$65	\$109
Aerobic treatment unit and gravity distribution	\$8,037	\$36,406	\$44,443	\$65	\$101	\$166
Denitrification system blackwater & graywater separation and gravity distribution	\$9,963	\$13,508	\$23,471	\$80	\$38	\$118
Denitrification system blackwater & graywater separation and LPP distribution	\$12,565	\$15,070	\$27,635	\$101	\$42	\$143
Septic tank & gravity distribution with 18 inch fill mound	\$4,507	\$6,850	\$11,357	\$36	\$19	\$55
Septic tank & gravity distribution with 18 inch fill mound and chambers	\$5,326	\$7,032	\$12,357	\$43	\$20	\$62
Septic tank & LPP distribution in at-grade system	\$4,590	\$12,345	\$16,935	\$37	\$34	\$71
Septic tank & pressure-dosed sand mound system	\$4,863	\$12,407	\$17,269	\$39	\$34	\$74

Source: Hoover, 1997.

<sup>a</sup>Costs displayed are not typical for all states. Costs in other states are significantly higher.



**Table 5-9. Common onsite wastewater treatment system failures**

Type of failure	Evidence of failure
Hydraulic failure	Untreated or partially treated sewage pooling on ground surfaces, sewage backup in plumbing fixtures, sewage breakouts on hill slopes
Pollutant contamination of ground water	High nitrate levels in drinking water wells; taste or odor problems (e.g., sulfur, household cleaners) in well water caused by untreated, poorly treated, or partially treated wastewater; presence of toxics (e.g., solvents, cleaners) in well water
Microbial contamination of ground and surface water	Shellfish bed bacterial contamination, recreational beach closures due high bacterial levels, contamination of drinking water wells with fecal bacteria or other fecal indicators
Nutrient contamination of surface water	Algae blooms, high aquatic plant productivity, low dissolved oxygen concentrations

## 5.8 Rehabilitating and upgrading existing systems

Onsite wastewater treatment systems can fail to meet the established performance requirements. When this occurs, corrective actions are necessary. Successful rehabilitation requires knowledge of the performance requirements, a sound diagnostic procedure, and appropriate selection of corrective actions.

### 5.8.1 Defining system failure

Failure occurs when performance requirements are not met (see table 5-9). Under traditional prescriptive rules, onsite wastewater systems must comply with specific siting and design requirements, maintain the discharged wastewater below ground surface, and not cause backup in fixtures. Typically, failures are declared when wastewater is observed on the ground surface or is backing up in the household plumbing. However, systems also may be declared as failed if they do not comply with the prescriptive design rules. Thus, except for hydraulic failures, systems can be declared failed based on their design, but rarely based on treatment performance to date.

When failure is strictly a code compliance issue rather than a performance issue, enforcing corrective actions can be problematic because corrective actions for code-based compliance might not reduce (and might even elevate) the potential risk to human health or the environment. Also, code compliance failures can be much more difficult to correct because site or wastewater characteristics might prevent compliance with the prescriptive

requirements. In such instances, variances to the rule requirements are needed to remove the noncompliant condition. Performance codes, on the other hand, define failures based on performance requirements consisting of specific and measurable criteria. Usually, treatment options are feasible to achieve compliance, though costs can be a significant impediment.

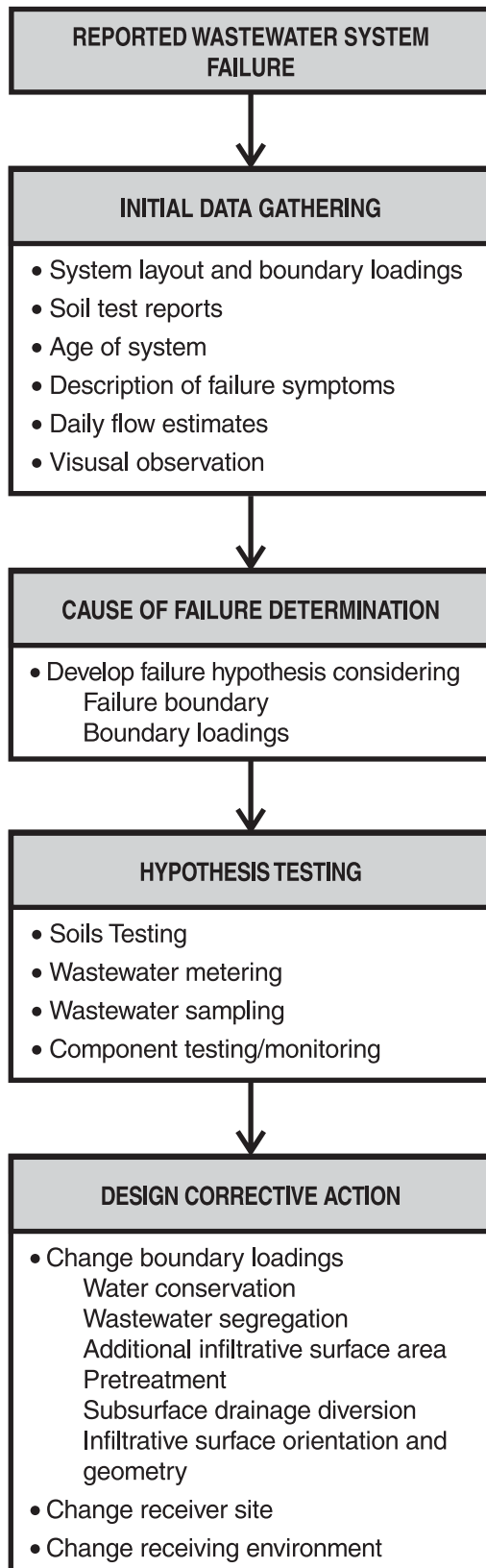
### 5.8.2 Failure diagnosis

Wastewater system failures occur at the design boundaries when the acceptable boundary loadings are exceeded. Prescribing an effective corrective measure requires that the failure boundary and the unsuitable boundary loading be correctly identified.

The manifestations of boundary failures can be similar in appearance despite different locations or causes of failure. For example, the primary infiltrative surface might fail to accept the daily wastewater load, causing the discharged wastewater to seep onto the ground surface. The cause of failure might be that the daily hydraulic capacity of the infiltrative surface was exceeded, the instantaneous hydraulic loading (dose volume) was too great, or the organic load was too high. In other instances, the linear loading on a site might be exceeded, causing a saturated zone above a secondary restrictive horizon to rise and encroach on the infiltrative surface (effluent mounding). The potential gradient across this surface is reduced in this situation, and the reaeration of the subsoil is inhibited. As a result of the reduced gradient and increased clogging, the infiltrative surface can no longer accept the daily



Figure 5-13. Onsite wastewater failure diagnosis and correction procedure



loading and allows wastewater to back up in the trenches and possibly to surface. Though the causes of failure in these two instances are different, the symptoms are similar. Thus, it is important that a systematic approach to failure diagnosis be used. Failures occur for a reason. The reason for failure should be determined before corrective actions are implemented; if not, failures can recur. The diagnostic procedure should be comprehensive, but based on deductive reasoning to avoid excessive testing and data gathering (figure 5-13). Another example of a failure diagnosis, *Failure Analysis Chart for Troubleshooting Septic Systems* (FACTS) is provided in Adams et al., 1998.

In addition to specific design boundary failures, failures can be caused by system age. Tanks and pipes buried in the ground begin to deteriorate after 20 or more years of use and may require repair or replacement. In addition, the treatment capabilities of soils below infiltration fields that have been in use for several decades might not be adequate for continued use. Years of treatment use can cause the interstitial spaces between soil particles to become filled with contaminants (e.g., TSS, precipitates, biomass). Soil structure can also be affected after many years of use. Finally, changes in design and construction practices in the past 25 years have led to marked improvements in system performance and treatment capacity. These issues make consideration of system age a vital component of the overall failure investigation.

### 5.8.3 Initial data gathering

When a failure is reported, relevant information regarding the system should be gathered.

- *Visual observation.* A visual observation of the failure should be made to confirm the information provided. Also, the owner should be interviewed regarding the owner's observations, use of the building, and other relevant information. Each of the system components should be inspected and mechanical components (e.g., float switches, flow diverters) tested.
- *Past operation and maintenance practices.* Assessing operation and maintenance actions taken over the past 3 to 5 years can often aid in detecting relatively simple problems. Perhaps the tank has not been pumped, the tank filter (if used) has not been cleaned, the electrical supply

to the pumps has not been checked, or the switches have not been examined.

- *System layout and boundary design loadings.* The system layout can be obtained from the design drawings or from a site survey. From the layout, the design boundary loadings should be determined or estimated based on the original design flow.
- *Soil test reports.* Soil test reports should be obtained. If none are available, soil auger testing between the trenches or just outside the SWIS perimeter might be necessary to provide a simple description of the soil profile to determine whether any significant secondary design boundaries might be present.
- *Age of system.* If the system age is less than 2 years, it is likely the design boundary loadings were in error or improper construction techniques (e.g., operation of heavy equipment on SWIS area, installation during wet conditions) that significantly altered the soil characteristics were used. If the age of the system is greater than 2 years, it is likely that the design conditions changed. Changed conditions could include changes in the building's use, increased wastewater flows, infiltration and inflow into the system, surface runoff over the system, improper maintenance, compaction of SWIS soils by vehicle traffic, and others.
- *Description of failure symptoms.* The symptoms of failure are important. Historically, reported failures have usually been hydraulic in nature and tended to be manifested by surface seepage. Information on the location and frequency of the surface seepage helps to determine the specific design boundary at which the failure occurred and possible causes of the failure. For example, surface seepage above the infiltration system suggests that the infiltrative surface is overloaded, either hydraulically or organically. Seepage downslope from the system suggests that a secondary design boundary exists and is overloaded hydraulically. If the failure is seasonal, wet weather conditions are likely to be the cause; that is, clear water is infiltrating into the system or causing inadequate subsurface drainage.
- *Daily flow estimates.* Estimates of daily wastewater flows derived from water meter data or

other sources are needed to compare the design loadings with actual loadings. In the absence of data, water use should be estimated (see chapter 3) with the caveat that such estimates are seldom accurate. Where practical, water meters should be read or installed as soon as the failure is reported so that metered data can be collected. Initially, daily flow estimates might need to suffice for the purposes of failure analysis. Leaking plumbing fixtures, such as improperly seated toilet tank flapper valves, should be investigated.

### 5.8.4 Determining the cause of failure

From the gathered data, hypotheses of potential causes of failure should be formulated. Formulating hypotheses is an important step in diagnosing the problem because the hypotheses can be tested to provide a systematic and efficient analysis of possible causes of failure (see case study). Testing can take many forms (see table 5-10 as an example of a local approach) depending on the hypotheses to be tested. It may include soil profile descriptions, soil hydraulic conductivity testing, wastewater characterization, equipment testing and monitoring, and other tests.

### 5.8.5 Designing corrective actions

If the design boundary failure can be identified and its cause identified, selecting an appropriate corrective action is straightforward. Table 5-11 can be used to select the appropriate corrective action for a given boundary failure. This table presents classes of corrective actions and the impacts they can be expected to have on boundary mass loadings. Several options typically exist for each class of corrective action. Specific actions will be determined by the particular needs of the system and site.

The failure diagnosis and correction procedure outlined in figure 5-13 provides a summary of activities required to identify and characterize the cause of failure. As noted in the previous discussion, data collection, failure cause determination, and testing of hypotheses (e.g., as in the case study above) provides key information needed to develop corrective actions. Failures at design boundaries (e.g., exceeding mass pollutant or hydraulic load limits) can be rectified by changing boundary

**Table 5-10. General OWTS inspection and failure detection process<sup>a</sup>**

Inspection process steps	Field procedures
Notification of inspection	<ul style="list-style-type: none"> <li>✓ Owner is sent a notice of inspection 1 month before inspection date indicating time and date of inspection (waived for failure investigations)</li> <li>✓ Information and requirements concerning provision of access to system are included with notice</li> </ul>
File review	<ul style="list-style-type: none"> <li>✓ Review system design features</li> <li>✓ Review prior inspection reports</li> <li>✓ Review other relevant file information</li> <li>✓ Note unusual circumstances on inspection form</li> </ul>
General site review	<ul style="list-style-type: none"> <li>✓ Walk property to confirm location of tank, SWIS, other system features, water resources, wells (if present), drainage patterns (relative to SWIS)</li> <li>✓ Check tank and SWIS area for effluent surfacing, odors, graywater bypass, selective fertility, unusual conditions</li> <li>✓ Check diversion valves (if present); confirm location of operating SWIS (if more than one)</li> </ul>
Inspection of septic tank and appurtenances	<ul style="list-style-type: none"> <li>✓ Open tank; examine for structural problems (cracking, settling, decay)</li> <li>✓ Check inlet and outlet ports for positioning, scum accumulation, rocks, root matter, obstructions</li> <li>✓ Check liquid level in tank; measure scum/sludge levels</li> <li>✓ Inspect risers (if present) for structural integrity and watertightness</li> <li>✓ Check pump basins for structural integrity</li> <li>✓ Check pumps and switches (if present); operate float switches to confirm operation</li> </ul>
SWIS inspection	<ul style="list-style-type: none"> <li>✓ Visually inspect SWIS for signs of wetness, odor, effluent pooling, selective fertility, presence of shrubs or trees, settling, signs of vehicles driving over SWIS, new structures (driveways, outbuildings) encroaching on SWIS, runoff across SWIS surface</li> <li>✓ Conduct hydraulic load test to assess SWIS operation (see table 5-11)</li> </ul>

<sup>a</sup> Inspection program requirements of The Sea Ranch in California. See table 5-11.  
Source: Adapted from Hantzsche, 1995.

**Table 5-11. Response of corrective actions on SWIS boundary mass loadings.**

CORRECTIVE ACTION	BOUNDARY LOADINGS							
	INFILTRATION BOUNDARY			SECONDARY BOUNDARY		WATER TABLE BOUNDARY		
	Daily hydraulic (gal/d-ft <sup>2</sup> )	Instantaneous hydraulic (gal/dose-ft <sup>2</sup> )	Organic (lb cBOD/ft <sup>2</sup> )	Daily hydraulic (gal/d-ft <sup>2</sup> )	Linear hydraulic (gal/d-ft)	Daily hydraulic (gal/d-ft <sup>2</sup> )	Linear hydraulic (gal/d-ft)	Constituent (lb xyz/ft <sup>2</sup> )
Water conservation	↓	No Impact	No Impact	↓	↓	↓	↓	No Impact
Wastewater segregation	↓	No Impact	↓	↓	↓	↓	↓	↓
Elimination of I/I	↓	No Impact	No Impact	↓	↓	↓	↓	No Impact
Surface drainage diversion	No Impact	No Impact	No Impact	↓	↓	↓	↓	No Impact
Subsurface drainage diversion	No Impact	No Impact	No Impact	↓	↓	↓	↓	No Impact
Timed dosing	No Impact	↓	No Impact	No Impact	No Impact	No Impact	No Impact	No Impact
Additional infiltration area; resting existing SWIS	↓	↓	↓	↓	↓	↓	↓	↓
Pretreatment	No Impact	No Impact	↓	No Impact	No Impact	No Impact	No Impact	↓
Infiltration surface orientation and geometry	No Impact	No Impact	No Impact	↓	↓	↓	↓	No Impact

Notes: Assumes uniform application of wastewater over the infiltrative surfaces for the action to have a significant impact.  
↓ indicates reduced loading rate.

Source: Otis, 2001.

### Failure hypothesis testing at a system serving a highway rest area

A wastewater system serving a highway rest area used a drip distribution system for final treatment and dispersal of the wastewater. After the first summer of use, water was observed above the dispersal system. The original soil test results indicated that the soils were deep, loamy sands with no apparent secondary boundaries. The system design appeared to use appropriate loadings on the infiltrative surfaces.

A visual inspection and interviews with the maintenance staff at the rest area provided important clues:

- ✓ The site of the dispersal system had been significantly regraded after the soil testing had been completed. Up to 5 feet of material had been removed from the site.
- ✓ The system was a replacement for another system that had also failed. The existing septic tanks were used in the new system.
- ✓ Water use was metered and recorded daily.
- ✓ The rest area had a sanitary dump station that discharged into the wastewater system. The dump station received very heavy use on weekends during the summer. This load was not accounted for in the metering data.

From these clues, several hypotheses were formulated for testing.

- a. *Water discharges to the system exceed the hydraulic and constituent design loadings.*

This hypothesis can be tested by estimating daily wastewater discharges. The recorded water meter data provide an accurate estimate of water use at the rest area. The metered data would need to be corrected for turf irrigation at the rest area. Turf irrigation can be estimated from staff interviews of irrigation schedules. Unaccounted water from the sanitary dump station must be estimated. Counting the number of vehicles using the dump station and assuming an average volume of wastewater discharged per vehicle would provide a reasonable estimate. Because of the strength of the dump station wastewater, wastewater samples at the septic tank outlets should be taken to determine organic loadings.

Another issue that might need to be considered is load inputs from disinfectants or other chemicals used in holding tanks that are discharged into the dump station. Significant concentrations of these chemicals could affect biological processes in the tank and infiltrative zone.

- b. *Infiltration/inflow of clear water into the system or into the SWIS is excessive.*

Only the septic tanks were left in place during the reconstruction of the existing system. All new components were leak tested during construction. It can be assumed that the new portion of the system does not leak if inspection records exist and can be verified. The existing septic tanks could be expected to be the source of any inflow or infiltration. Infiltration of surface runoff from the area over the septic tanks, revealed by the existence of saturated soils around the tanks, could result in significant inflow/infiltration contributions. If there is evidence that such conditions exist, the septic tanks should be pumped and tested for leakage. Runoff of storm water onto the SWIS surface could also cause ponding and might require regrading of the surrounding site or a diversion to route runoff elsewhere.

- c. *The actual soil characteristics at the receiver site are different from the soil test results.*

The characteristics of the soils after regrading might be different from those reported by the original soil tests because of the depth of soil removed. Also, the regrading operations might have compacted the subsoil, creating a secondary design boundary that was not anticipated. Soil tests could be performed to determine if the existing profile below the dispersal system is different in texture, structure, and bulk density from that reported earlier. Also, the source of the surface seepage should be investigated. If the seepage occurs immediately above a dripperline but the soil is not saturated between the lines, the infiltrative surface surrounding the dripperline is hydraulically or organically overloaded. If the soil between the lines is saturated, a secondary boundary that is hydraulically overloaded probably exists. If such a boundary is present, the soil below the boundary would be unsaturated.

By developing these hypotheses, determination of the failure can be systematic and efficient. The most probable hypothesis can be tested first, or appropriate tests for all the hypotheses formulated can be performed at one time for later evaluation.

Source: Otis, 2001.



loadings to accommodate the hydraulic or mass pollutant assimilative capacities at the design boundary. Loading adjustments may require lowering water usage through water conservation measures, eliminating clear water inputs, or separating graywater; increasing the area of the infiltrative surface; or diverting precipitation and/or shallow ground water from the SWIS with berms or curtain drains.

Approaches for lowering mass pollutant loads include improving pretreatment by upgrading the existing system and/or adding treatment units, improving user habits (e.g., removing food, kitchen, or dishwashing wastes from the wastewater stream), reducing or eliminating inputs of cleaners or other strong chemical products, and reducing solid waste in the wastewater stream (e.g., ground garbage from garbage disposals). If measures to correct failures within the existing receiver site are not possible, corrective actions may involve changing the receiver site or changing the receiver site conditions. These options include adoption of different treatment technologies, physical alteration of the receiver site, and installation of a new infiltration system, thereby resting the existing system for future alternate dosing.

Attention to established performance requirements and the design boundaries where they are measured helps to ensure that corrective actions meet the overall goals of the management entity and protect human health and the environment. Implementation of corrective actions should follow the same processes and procedures outlined in the preceding sections for new or replacement OWTSS.

## References

- Adams, A., M.T. Hoover, W. Arrington, and G. Young. 1998. FACTS: Failure Analysis Chart for Troubleshooting Septic Systems. In *Onsite wastewater Treatment: Proceedings of the Eighth National Symposium on Individual and Small Community Sewage Systems*. American Society of Agricultural Engineers, St. Joseph, MI.
- American Society for Testing and Materials (ASTM). 1996a. *Standard Practice for Surface Site Characterization for Onsite Septic Systems*. ASTM Practice D5879-95 el. American Society for Testing and Materials, West Conshohocken, PA.
- American Society for Testing and Materials (ASTM). 1996b. *Standard Practice for Subsurface Site Characterization of Test Pits for Onsite Septic Systems*. ASTM Practice D5921-96 el. American Society for Testing and Materials, West Conshohocken, PA.
- American Society for Testing and Materials (ASTM). 1997. *Standards Related to On-Site Septic Systems*. ASTM publication code 03-418197-38. American Society for Testing and Materials, West Conshohocken, PA.
- American Society for Testing and Materials (ASTM). 2000. *Standard Practice for Classification of Soils for Engineering Purposes (Unified Soil Classification System)*. ASTM D 2487-00. American Society for Testing and Materials, West Conshohocken, PA.
- Ayres Associates. 1993. *Onsite Sewage Disposal System Research in Florida—An Evaluation of Current OSDS Practices in Florida*. Report to the Department of Health and Rehabilitative Services. Ayres and Associates, Tallahassee, FL.
- Black, C.A., ed. 1965. *Methods of Soil Analysis. Part I: Physical and Microbiological Properties, Including Statistical Measurement and Sampling*. American Society of Agronomy, Madison, WI.
- Bouma, J., and L.W. Dekker. 1981. A method of measuring the vertical and horizontal hydraulic saturated conductivity of clay soils with macropores. *Soil Science Society of America Journal* 45:662.
- Bouwer, H. 1978. *Groundwater Hydrology*. McGraw-Hill Book Company, New York, NY.
- Bouwer, H., and R.C. Rice. 1976. A slug test for determining hydraulic conductivity of unconfined aquifers with completely or partially penetrating wells. *Water Resources Research* 12:423-428.
- Brock, R.P. 1976. Dupuit-Forcheimer and potential theories for recharge from basins. *Water Resources Research* 12:909.



- Finnemore, E.J., and N.N. Hantzshe. 1983. Ground-water mounding due to onsite sewage disposal. *Journal of the American Society of Civil Engineers Irrigation and Drainage Division* 109:999.
- Florida Department of Health and Rehabilitative Services (Florida HRS). 1993. Onsite Sewage Disposal System Research in Florida. Tallahassee, FL.
- Freeze, R.A., and J.A. Cherry. 1979. *Groundwater*. Prentice-Hall, Englewoods Cliffs, NJ.
- Fredrick, J.C. 1948. Solving disposal problems in unsewered areas. *Sewage Works Engineering* 19(6):292-293, 320.
- Glegg, G.L. 1971. *The Design of Design*. Cambridge University Press, London, England.
- Hantush, M.S. 1967. Growth and decay of ground water mounds in response to uniform percolation. *Water Resources Research* 3:227.
- Hantzshe, N.N. 1995. Data Management System for On-Site Wastewater Inspection Program at The Sea Ranch, California. In *Proceedings of the Sixth International Symposium on Individual and Small Community Sewage Systems*. American Society of Agricultural Engineers, St. Joseph, MI.
- Hill, R.L., and L.D. King. 1982. A permeameter which eliminates boundary flow errors in saturated hydraulic conductivity measurements. *Soil Science Society of America Journal* 46:877.
- Hoover, M.T. 1997. *A Framework for Site Evaluation, Design, and Engineering of On-site Technologies Within a Management Context*. Marine Studies Consortium, Waquoit Bay National Estuarine Research Reserve, and ad hoc Task Force for Decentralized Wastewater Management. Marine Studies Consortium, Chestnut Hill, MA.
- Kahn, M.Y., D. Kirkham, and R.L. Handy. 1976. Shapes of steady state perched groundwater mounds. *Water Resources Research* 12:429.
- Munsell. 1994. *Munsell Soil Color Charts*. GretagMacbeth LLC, New Windsor, NY.
- North Carolina Department of Environment, Health, and Natural Resources (North Carolina DEHNR). 1996. *On-Site Wastewater Management: Guidance Manual*. North Carolina Department of Environment, Health, and Natural Resources, Division of Environmental Health, On-Site Wastewater Section, Raleigh, NC.
- National Small Flows Clearinghouse. 2000. National Environmental Service Center. West Virginia University, Morgantown, WV.
- Natural Resources Conservation Service (NRCS). 1998. *Field Book for Describing and Sampling Soils*. Version 1.1. U.S. Department of Agriculture, Natural Resources Conservation Service, National Soil Survey Center, Lincoln, NE. <[http://www.statlab.iastate.edu/soils/nssc/field\\_gd/fieldgd.pdf](http://www.statlab.iastate.edu/soils/nssc/field_gd/fieldgd.pdf)>.
- Otis, R.J. 1997. Considering Reaeration. In *Ninth Northwest On-Site Wastewater Treatment Short Course and Equipment Short Course*, University of Washington, Seattle.
- Otis, R.J. 1999. Designing on the Boundaries: A Strategy for Design of Onsite Treatment Systems. In *Proceedings of the Eighth Annual NOWRA Conference and Exhibit*. National Onsite Wastewater Recycling Association, Northbrook, IL.
- Otis, R.J. 2001. Boundary Design: A Strategy for SWIS Designed and Rehabilitation. In *Onsite Wastewater Treatment Proceedings of the Ninth National Symposium on Individual and Small Community Sewage Systems*. ASAE, St. Joseph, MI.
- Powell, G.M. 1990. *Why Do Septic Systems Fail?* Kansas State University Cooperative Extension Service, Manhattan, KS. <<http://hermes.ecn.purdue.edu:8001/cgi/convertwq?5862>>. Accessed August 6, 2000.
- Purdue University. 1990. *Steps in Constructing a Mound (Bed-Type) Septic System*. Cooperative Extension Service, Purdue University, West Lafayette, IN. <<http://www.agcom.purdue.edu/AgCom/Pubs/ID/ID-163.html>>.
- Schoeneberger, P.J., D.A. Wysocki, E.C. Benham, and W.D. Broderson. 1998. *Field Book for Describing and Sampling Soils*. U.S. Department of Agriculture, Natural Resources

Conservation Service, National Soil Survey Center, Lincoln, NE.

Sprehe, T.G. 1997. *Onsite Wastewater Management Practices in the Upper Patuxent Watershed*. Submitted to the Washington Suburban Sanitary Commission, Laurel, MD, by George, Miles & Buhr, Hunt Valley, MD.

Tyler, E.J., and J.C. Converse. 1994. Soil Acceptance of Onsite Wastewater as Affected by Soil Morphology and Wastewater Quality. In *On-Site Wastewater Treatment: Proceedings of the Seventh International Symposium on Individual and Small Community Sewage Systems*, ed. E. Collins. American Society of Agricultural Engineers, St. Josephs, MI.

U.S. Department of Agriculture (USDA), Soil Survey Staff. 1993. *Soil Survey Manual*. USDA handbook no. 18. U.S. Government Printing Office, Washington, DC.

U.S. Department of Agriculture (USDA), Soil Survey Staff. 1951. *Soil Survey Manual*. USDA handbook no. 18. U.S. Government Printing Office, Washington, DC.

U.S. Environmental Protection Agency (USEPA). 1984. *Land Treatment of Municipal Wastewaters Process Design Manual—Supplement on Rapid Infiltration and Overland Flow*. EPA/625/1-81-013a. U.S. Environmental Protection Agency, Cincinnati, OH.

U.S. Environmental Protection Agency (USEPA). 1981. *Land Treatment of Municipal Wastewaters Process Design Manual*. EPA/625/1-81-013. U.S. Environmental Protection Agency, Cincinnati, OH.

Vespaskas, M.J. 1996. *Redoximorphic Features for Identifying Aquic Conditions*. Technical bulletin 301. North Carolina Agricultural Research Service, North Carolina State University, Raleigh, NC.



# Glossary

**Absorption:** The process by which one substance is taken into and included within another substance, such as the absorption of water by soil or nutrients by plants.

**Activated sludge process:** A biological wastewater treatment process in which biologically active sludge is agitated and aerated with incoming wastewater. The activated sludge is subsequently separated from the treated wastewater (mixed liquor) by sedimentation, and most of it is returned to the process. The rest is wasted as needed.

**Adsorption:** The increased concentration of molecules or ions at a surface, including exchangeable cations and anions on soil particles. The adherence of a dissolved solid to the surface of a solid.

**Aerobic:** Having molecular oxygen as a part of the environment, or growing or occurring only in the presence of molecular oxygen, as in “aerobic organisms.”

**Aerobic treatment unit (ATU):** A mechanical onsite treatment unit that provides secondary wastewater treatment by mixing air (oxygen) and aerobic and facultative microbes with the wastewater. ATUs typically use a suspended growth treatment process (similar to activated sludge extended aeration) or a fixed film treatment process (similar to trickling filter).

**Alternative onsite wastewater treatment system:** An onsite treatment system that includes components different from those used in a conventional septic tank and drain field system. An alternative system is used to achieve acceptable treatment and dispersal/discharge of wastewater where conventional systems may not be capable of meeting established performance requirements to protect public health and water resources. (e.g., at sites where high ground water, low-permeability soils, shallow soils, or other conditions limit the infiltration and dispersal of wastewater or where additional treatment is needed to protect ground water or surface water quality). Components that might be used in alternative systems include sand filters, aerobic treatment units, disinfection devices, and

alternative SWISs such as mounds, gravelless trenches, and pressure and drip distribution.

**Anaerobic:** Characterized by the absence of molecular oxygen, or growing in the absence of molecular oxygen (as in “anaerobic bacteria”).

**Anaerobic upflow filter:** A high-specific-surface anaerobic reactor filled with a solid media through which wastewater flows; used to pretreat high-strength wastewater or to denitrify nitrified wastewater.

**Biochemical oxygen demand (BOD):** A commonly used gross measurement of the concentration of biodegradable organic impurities in wastewater. The amount of oxygen, expressed in milligrams per liter (mg/L), required by bacteria while stabilizing, digesting, or treating organic matter under aerobic conditions is determined by the availability of material in the wastewater to be used as biological food and the amount of oxygen used by the microorganisms during oxidation.

**Biomat:** The layer of biological growth and inorganic residue that develops at the wastewater-soil interface and extends up to about 1 inch into the soil matrix. The biomat controls the rate at which pretreated wastewater moves through the infiltrative surface/zone for coarse- to medium-textured soils. This growth may not control fluxes through fine clay soils, which are more restrictive to wastewater flows than the biomat.

**Blackwater:** Liquid and solid human body waste and the carriage waters generated through toilet usage.

**Centralized wastewater treatment system:** A wastewater collection and treatment system that consists of collection sewers and a centralized treatment facility. Centralized systems are used to collect and treat wastewater from entire communities.

**Chemical oxygen demand (COD):** A measure of oxygen use equivalent to the portion of organic matter that is susceptible to oxidation by a strong chemical oxidizing agent.

**Chlorine residual:** The total amount of chlorine (combined and free available chlorine) remaining in water, sewage, or industrial wastes at the end of a specified contact period following disinfection.

**Clarifiers:** Settling tanks that typically remove settleable solids by gravity.

**Class V injection well:** A shallow well used to place a variety of fluids at shallow depths below the land surface, including a domestic onsite wastewater treatment system serving more than 20 people. USEPA permits these wells to inject wastes below the ground surface provided they meet certain requirements and do not endanger underground sources of drinking water.

**Clay:** A textural class of soils consisting of particles less than 0.002 millimeters in diameter.

**Cluster system:** A wastewater collection and treatment system under some form of common ownership and management that provides treatment and dispersal/discharge of wastewater from two or more homes or buildings but less than an entire community.

**Coliform bacteria:** A group of bacteria predominantly inhabiting the intestines of humans or other warm-blooded animals, but also occasionally found elsewhere. Used as an indicator of human fecal contamination.

**Colloids:** The solids fraction that is described as the finely divided suspended matter that will not settle by gravity and is too large to be considered dissolved matter.

**Compliance boundary:** A performance boundary with enforceable performance limits (through an operating permit).

**Consistence:** Attribute of soil expressed in degree of cohesion and adhesion, or in resistance to deformation or rupture. Consistence includes the resistance of soil material to rupture; resistance to penetration; the plasticity, toughness, or stickiness of puddled soil material; and the manner in which the soil material behaves when subjected to compression. General classifications of soil consistence include loose, friable, firm, and extremely firm.

**Constructed wetland:** An aquatic treatment system consisting of one or more lined or unlined basins,

some or all of which may be filled with a treatment medium and wastewater undergoing some combination of physical, chemical, and/or biological treatment and evaporation and evapotranspiration by means of macrophytes planted in the treatment medium.

**Construction permit:** A permit issued or authorized by the regulatory authority that allows the installation of a wastewater treatment system in accordance with approved plans and applicable codes.

**Continuous-flow, suspended-growth aerobic system:** A typical activated sludge process.

**Conventional onsite system:** A wastewater treatment system consisting of a septic tank and subsurface wastewater infiltration system.

**Decentralized system:** Onsite and/or cluster wastewater systems used to treat and disperse or discharge small volumes of wastewater, generally from dwellings and businesses that are located relatively close together. Decentralized systems in a particular management area or jurisdiction are managed by a common management entity.

**Denitrification:** The biochemical reduction of nitrate or nitrite to gaseous molecular nitrogen or an oxide of nitrogen.

**Digestion:** The biological decomposition of organic matter in sludge, resulting in partial gasification, liquefaction, and mineralization.

**Disinfection:** The process of destroying pathogenic and other microorganisms in wastewater, typically through application of chlorine compounds, ultra-violet light, iodine, ozone, and the like.

**Dissolved oxygen (DO):** The oxygen dissolved in water, wastewater, or other liquid, usually expressed in milligrams per liter (mg/L), parts per million (ppm), or percent of saturation.

**Dissolved solids:** The fraction of solids dissolved in water.

**Drain field:** Shallow, covered, excavation made in unsaturated soil into which pretreated wastewater is discharged through distribution piping for application onto soil infiltration surfaces through porous media or manufactured (gravelless) components



placed in the excavations. The soil accepts, treats, and disperses wastewater as it percolates through the soil, ultimately discharging to groundwater.

**Effluent:** Sewage, water, or other liquid, partially or completely treated or in its natural state, flowing out of a septic tank, subsurface wastewater infiltration system, aerobic treatment unit, or other treatment system or system component.

**Effluent filter** (also called an **effluent screen**): A removable, cleanable device inserted into the outlet piping of the septic tank designed to trap excessive solids due to tank upsets that would otherwise be transported to the subsurface wastewater infiltration system or other downstream treatment components.

**Effluent screen:** See *Effluent filter*.

**Engineered design:** An onsite or cluster system that is designed to meet specific performance requirements for a particular site as certified by a licensed professional engineer or other qualified and licensed or certified person.

**Environmental sensitivity:** The relative susceptibility to adverse impacts of a water resource or other environments that may receive wastewater discharges.

**Eutrophic:** A term applied to water that has a concentration of nutrients optimal, or nearly so, for plant or animal growth. In general, nitrogen and phosphorus compounds contribute to eutrophic conditions in coastal and inland fresh waters, respectively.

**Evapotranspiration:** The combined loss of water from a given area and during a specified period of time by evaporation from the soil or water surface and by transpiration from plants.

**Fixed-film wastewater treatment system:** A biological wastewater treatment process that employs a medium such as rock, plastic, wood, or other natural or synthetic solid material that will support biomass on its surface. Fixed-film systems include those in which the medium is held in place and is stationary relative to fluid flow (tricking filter), those in which the medium is in motion relative to the wastewater (e.g., rotating biological disk), and dual process systems that include both fixed and suspended biomass together or in a series.

**Graywater:** Wastewater drained from sinks, tubs, showers, dishwashers, clothes washers, and other non-toilet sources.

**Hydraulic conductivity:** As applied to soils, the ability of the soil to transmit water in liquid form through pores.

**Laminar:** Used to describe flat, sheet-like ground water flows that migrate laterally along the upper surface of a confining layer of soil or rock.

**Management entity:** An entity similar to a responsible management entity, but managing a limited set of management activities (e.g., homeowners' association, contracted provider of management services).

**Management services:** Planning, design, permitting, inspection, construction/installation, operation, maintenance, monitoring, enforcement, and other services required to ensure that the wastewater treatment performance requirements established by the regulatory authority are achieved. Management services should be provided by properly trained personnel and tracked by means of a comprehensive management information system.

**Mineralization:** The conversion of an element from an organic form to an inorganic state as a result of microbial decomposition.

**Mottling:** Spots or blotches of different colors or shades of color interspersed with the dominant soil color caused in part by exposure to alternating unsaturated and saturated conditions.

**Nitrification:** The biochemical oxidation of ammonium to nitrate.

**Nonconventional onsite wastewater treatment system:** System using technologies or combinations of technologies that are used where conventional onsite treatment systems cannot meet established performance or prescriptive requirements because of limiting site conditions. Also referred to as *Alternative onsite wastewater treatment systems*.

**Onsite wastewater treatment system (OWTS):** A system relying on natural processes and/or mechanical components that is used to collect, treat, and disperse/discharge wastewater from single dwellings or buildings.

**Operating permit:** A renewable and revocable permit to operate and maintain an onsite or cluster treatment system in compliance with specific operational or performance requirements.

**Organic nitrogen:** Nitrogen combined in organic molecules such as proteins and amino acids.

**Organic soil:** A soil that contains a high percentage (more than 15 to 20 percent) of organic matter throughout the soil column.

**Package plant:** Term commonly used to describe an aerobic treatment unit serving multiple dwellings or an educational, health care, or other large facility.

**Particle size:** The effective diameter of a particle, usually measured by sedimentation or sieving.

**Particle-size distribution:** The amounts of the various soil size fractions in a soil sample, usually expressed as weight percentage.

**Pathogenic:** Causing disease; commonly applied to microorganisms that cause infectious diseases.

**Ped:** A unit of soil structure such as an aggregate, crumb, prism, block, or granule, formed by natural processes.

**Perched water table:** The permanent or temporary water table of a discontinuous saturated zone in a soil.

**Percolation:** The flow or trickling of a liquid downward through a contact or filtering medium.

**Performance-based management program:** A program designed to preserve and protect human health and environmental resources by focusing on the achievement of specific, measurable performance requirements based on site assessments.

**Performance boundaries:** The point at which a wastewater treatment performance requirement corresponding to the desired level of treatment at that point in the treatment sequence is applied. Performance boundaries can be designated at the discharge point of the pretreatment system (e.g., septic tank, package plant discharge to surface waters), at physical boundaries in the receiving environment (impermeable strata, ground water table), at a point of use (ground water well), or at a property boundary.

**Performance requirement:** Any requirement established by the regulatory authority to ensure future compliance with the public health and environmental goals of the community. Performance requirements can be expressed as numeric limits (e.g., pollutant concentrations, mass loads, wet weather flows, structural strength) or narrative descriptions of desired performance, such as no visible leaks or no odors.

**Permeability:** The ability of a porous medium such as soil to transmit fluids or gases.

**pH:** A term used to describe the hydrogen ion activity of a system.

**Physical boundaries:** Points in the flow of wastewater through the treatment system where treatment processes change. A physical boundary can be at the intersection of unit processes or between saturated and unsaturated soil zones. A physical boundary may also be a performance boundary if so designated by the regulatory authority.

**Plastic soil:** A soil capable of being molded or deformed continuously and permanently by relatively moderate pressure.

**Platy structure:** Laminated or flaky soil aggregate developed predominantly along the horizontal axes.

**Prescriptive-based management program:** Program that applies predetermined requirements such as site characteristics, design standards, and separation distances to permit or otherwise allow the operation of onsite wastewater treatment systems. This type of program requires that proposed sites meet preset specifications that are perceived to protect public health and the environment.

**Prescriptive requirements:** Standards or specifications for design, siting, and other procedures and practices for onsite or cluster system applications. Proposed deviations from the specified criteria, procedures, or practices require formal approval by the regulatory authority.

**Pretreatment system:** Any technology or combination of technologies that precedes discharge to a subsurface wastewater infiltration system or other final treatment unit or process before final dissemination into the receiving environment.

**Regulatory authority (RA):** The level of government that establishes and enforces codes related to the permitting, design, placement, installation, operation, maintenance, monitoring, and performance of onsite wastewater treatment systems.

**Residuals:** The solids generated and retained during the treatment of domestic sewage in treatment system components, including sludge, scum, and pumpings from grease traps, septic tanks, aerobic treatment units, and other components of an onsite or cluster system.

**Responsible management entity (RME):** An entity responsible for managing a comprehensive set of activities delegated by the regulatory authority; a legal entity that has the managerial, financial, and technical capacity to ensure the long-term, cost-effective operation of onsite and/or cluster water treatment systems in accordance with applicable regulations and performance requirements (e.g., a wastewater utility or wastewater management district).

**Sand filter:** A packed-bed filter of sand or other granular materials used to provide advanced secondary treatment of settled wastewater or septic tank effluent. Sand/media filters consist of a lined (e.g., impervious PVC liner on sand bedding) excavation or structure filled with uniform washed sand that is placed over an underdrain system. The wastewater is dosed onto the surface of the sand through a distribution network and allowed to percolate through the sand to the underdrain system, which collects the filter effluent for further processing or discharge.

**Septage:** The liquid, solid, and semisolid material that results from wastewater pretreatment in a septic tank, which must be pumped, hauled, treated, and disposed of properly (i.e., in accordance with 40 CFR Part 503).

**Septic tank:** A buried, preferably watertight tank designed and constructed to receive and partially treat raw wastewater. The tank separates and retains settleable and floatable solids suspended in the raw wastewater. Settleable solids settle to the bottom to form a sludge layer. Grease and other light materials float to the top to form a scum layer. The removed solids are stored in the tank, where they undergo liquefaction in which organic solids are partially broken down into dissolved fatty acids

and gases. Gases generated during liquefaction of the solids are normally vented through the building's plumbing stack vent.

**Sequencing batch reactor:** A sequential suspended-growth (activated sludge) process in which all major steps occur in the same tank in sequential order. Sequencing batch reactors include intermittent-flow batch reactors and continuous-flow systems.

**Settleable solids:** Matter in wastewater that will not stay in suspension during a designated settling period.

**Silt:** A textural class of soils consisting of particles between 0.05 and 0.002 millimeters in diameter.

**Soil horizon:** A layer of soil or soil material approximately parallel to the land surface and different from adjacent layers in physical, chemical, and biological properties or characteristics such as color, structure, texture, consistence, and pH.

**Soil map:** A map showing the distribution of soil types or other soil mapping units in relation to the prominent physical and cultural features of the earth's surface.

**Soil morphology:** The physical constitution, particularly the structural properties, of a soil profile as exhibited by the kinds, thickness, and arrangement of the horizons in the profile and by the texture, structure, consistence, and porosity of each horizon.

**Soil structure:** The combination or arrangement of individual soil particles into definable aggregates, or peds, which are characterized and classified on the basis of size, shape, and degree of distinctness.

**Soil survey:** The systematic examination, description, classification, and mapping of soils in an area.

**Soil texture:** The relative proportions of the various soil separates (e.g., silt, clay, sand) in a soil.

**Soil water:** A general term emphasizing the physical rather than the chemical properties and behavior of the soil solution.

**Subsoil:** In general, that part of the soil below the depth of plowing.

**Subsurface wastewater infiltration system**

**(SWIS):** An underground system for dispersing and further treating pretreated wastewater. The SWIS includes the distribution piping/units, any media installed around or below the distribution components, the biomat at the wastewater-soil interface, and the unsaturated soil below.

**Topsoil:** The layer of soil moved in agricultural cultivation.

**Total Kjeldahl nitrogen (TKN):** An analytical method for determining total organic nitrogen and ammonia.

**Treatment system:** Any technology or combination of technologies (treatment trains or unit processes) that discharges treated wastewater to surface waters, ground water, or the atmosphere.

**Unsaturated flow:** Movement of water in a soil that is not filled to capacity with water.

**Vegetated submerged bed:** A constructed wetland wastewater treatment unit characterized by anaerobic horizontal subsurface flow through a fixed-film medium that has a growth of macrophytes on the surface.

**Water quality-based performance requirement:** A specific, measurable, and enforceable standard that establishes limits for pollutant concentrations or mass loads in treated wastewater discharged to ground water or surface waters.

**Water quality criteria:** A set of enforceable requirements under the Clean Water Act that establish measurable limits for specific pollutants based on the designated use(s) of the receiving water body. Water quality criteria can be expressed as numeric limits (e.g., pollutant concentrations or mass loads) or narrative descriptions of desired conditions (e.g., no visible scum, sludge, sheens, or odors).

**Water quality standards:** A set of enforceable requirements under the Clean Water Act that include classification of receiving waters in accordance with their federal or state designated use(s), use-based water quality criteria that establish measurable limits for specific pollutants, and antidegradation provisions to ensure that water quality is maintained or improved.

**Water table:** The level in saturated soil at which the hydraulic pressure is zero.

# Resources

## USEPA Office Web Sites:

- Home Page - <http://www.epa.gov/>
- Office of Water - <http://www.epa.gov/ow/>
- Office of Wastewater Management - <http://www.epa.gov/owm/>
- Office of Science and Technology - <http://www.epa.gov/waterscience/>
- Onsite/Decentralized Treatment Site – <http://www.epa.gov/owm/decent>
- Environmental Technology Verification - <http://www.epa.gov/etv/>
- Nonpoint Source Pollution - <http://www.epa.gov/owow/nps/>
- Source Water Protection - <http://www.epa.gov/safewater/protect.html>
- Surf Your Watershed - <http://www.epa.gov/surf/>
- Total Maximum Daily Load Program (TMDL) - <http://www.epa.gov/owow/tmdl/>
- Underground Injection Control Program (UIC) - <http://www.epa.gov/safewater/uic.html>

## USEPA Documents:

- Guidelines for Management of Onsite/Decentralized Wastewater Systems - <http://www.epa.gov/owm/decent/downloads/guidelines.pdf>
- Constructed Wetlands for Wastewater Treatment and Wildlife Habitat - <http://www.epa.gov/owow/wetlands/construc/content.html>
- Onsite Wastewater Treatment and Disposal Systems (1980) - <http://www.epa.gov/cgi-bin/claritgw?op-Display&document=clserv:epa-cinn:5276;rank=3&template=epa>
- Response to Congress on the Use of Decentralized Wastewater Treatment Systems - <http://www.epa.gov/owm/decent/response/index.htm>
- Small Community Wastewater Systems - <http://www.epa.gov/oia/tips/scwsint.htm>

- Wastewater Treatment publications (OWM) - <http://www.epa.gov/owm/secttre.htm>

## Other Links of Interest:

- American Society of Agricultural Engineers - <http://asae.org/>
- American Water Works Association - <http://www.awwa.org/>
- American Society of Civil Engineers - <http://www.asce.org/>
- Association of State and Interstate Water Pollution Control Administrators - <http://www.asiwpc.org/>
- Clean Water Network - <http://www.cwn.org/>
- Conservation Technology Information Center - <http://www.ctic.purdue.edu/CTIC/CTIC.html>
- Consortium of Institutions for Onsite/Decentralized Wastewater Management - <http://www.dal.ca/%7Ecwrs/cdwt/>
- Council of State Governments - <http://www.statesnews.org/>
- Environmental Council of the States - <http://www.sso.org/ecos/>
- Groundwater Foundation - <http://www.groundwater.org/>
- National Association of Counties (NACo) - <http://www.naco.org/>
- National Association of County and City Health Officials (NACCHO) - <http://www.naccho.org/>
- National Association of Home Builders - <http://www.nahb.com/>
- National Association of Regional Councils - <http://www.narc.org/>
- National Association of Towns and Townships (NATaT) - <http://natat.org/natat/Default.htm>



- National Environmental Health Association (NEHA) - <http://www.neha.org/>
  - National Environmental Training Center for Small Communities (NETCSC) <http://www.nesc.wvu.edu>
  - National Center for Small Communities - <http://natat.org/ncsc/Default.htm>
  - National Onsite Wastewater Recycling Association (NOWRA) - <http://nowra.org/>
  - National Small Flows Clearinghouse (NSFC) - <http://www.nesc.wvu.edu>
  - New England Interstate Water Pollution Control Commission (NEIWPCC) - <http://www.neiwpcc.org>
  - National Sanitation Foundation (NSF) - <http://www.nsf.org>
  - Rural Community Assistance Program (RCAP) - <http://rcap.org>
  - USDA-Rural Utilities Service (RUS) - <http://www.usda.gov/rus/>
  - USEPA Onsite/Decentralized Wastewater Toolbox - [http://www.epa.gov/owm/decent/tool\\_right.htm](http://www.epa.gov/owm/decent/tool_right.htm)
- Fact Sheets:**
- Onsite/Decentralized Treatment Technologies Fact Sheets - [http://www.epa.gov/owm/decent/tech\\_right.htm](http://www.epa.gov/owm/decent/tech_right.htm)
  - Barnstable County, Massachusetts, Department of Health and Environment - <http://www.capecod.net/alternativesepic/>
  - City of Austin, Texas - <http://www.ci.austin.tx.us/wri/fact.htm>
  - The Municipal Technologies Branch of EPA - <http://www.epa.gov/owmitnet/mtbfact.htm>
  - National Small Flows Clearinghouse - [http://www.estd.wvu.edu/nsfc/NSFC\\_ETI.html](http://www.estd.wvu.edu/nsfc/NSFC_ETI.html)
  - University of Rhode Island Onsite Wastewater Training Center - <http://www.edc.uri.edu/homeasyst/page11.htm>
  - University of Minnesota Extension Septic System Owner's Guide - <http://www.extension.umn.edu/distribution/naturalresources/DD6583.html>