



## Urban River Basin Enhancement Methods

# MANUAL OF URBAN RIVERS REHABILITATION TECHNIQUES

A Contribution to Work Package 8, Chapter 5  
October 2005

Dresden University of Technology (TU Dresden)  
Prof. Joachim T. Tourbier, Prof. Richard N. Westmacott

October 2005

EVK-CT-2002-00082

### **Research Contractor Contact Details**

Prof. Joachim Tourbier  
Institute of Landscape Architecture  
Dresden University of Technology (TUD)  
D-01069 Dresden, Germany  
tourbier@rcs.urz.tu-dresden.de  
Tel: +49 (0) 351/ 4633 3453  
Fax: +49 (0) 351/ 4633 7081

© 2005

All methodologies, ideas and proposals in this document are the copyright of the URBEM project participants. These methodologies, ideas and proposals may not be used to change or improve the specification of any project to which this project relates, to modify an existing project or to initiate a new project, without first obtaining written approval from TU DRESDEN as an URBEM participant who owns the particular methodologies, ideas and proposals involved. This report is a contribution to research generally and it would be impudent for third parties to rely on it in specific application without first checking its suitability. Various sections of this report rely on data supplied by or drawn from third party sources (see data sources in Appendix 1). The URBEM partner organizations accept no liability for loss or damage suffered by the client or third parties as a result of errors or inaccuracies in such third party data.

### **Report Authors:**

Prof. MLA J.T. Tourbier and Prof. MLA R.N. Westmacott  
Dresden University of Technology (TU Dresden)

### **Technical support and realisation:**

Ines Gersdorf, Silke Molch, Thomas Schwager, Krzysztof Tarnawski

<b>Table of Contents</b>	<b>Page Number</b>
Abstract	5
1. Planning procedures for re-naturalizing flow regimes	5
1.1 Identification of stream type	6
1.2 Defining existing conditions	6
1.3 Setting goals and objectives	6
1.4 Evaluation of streams sections	6
1.5 Setting timeframe targets	6
1.6 Selection of measures	8
1.7 Conceptualisation of stream rehabilitation and design	8
1.8 Implementation, monitoring, evaluation of effectiveness and communication	8
<b>2 Drainage Basin – Measures to be practiced throughout the watershed</b>	
2.1 Group 1 - Lessening the volume of runoff close to its source	9
2.2 Group 2 - Runoff quality improvement	9
2.3 Group 3 - Control of erosion and sedimentation	10
2.4 Group 4 - Maintaining groundwater recharge	11
2.5 Group 5 - Detaining peak flows	11
2.6 Group 6 - Minimizing pollution from sewage	12
<b>3 Channel Bank and Riparian areas -- Measures for urban stream rehabilitation</b>	
3.1 Group 7 - Channel rehabilitation through transverse structures	13
3.2 Group 8 - Channel rehabilitation through parallel structures	13
3.3 Group 9 - Point protection and stabilization of streambank	14
3.4 Group 10 - Stabilization of upper streambank and floodplain areas	15
3.5 Group 11 - In-stream habitat improvement	16
3.6 Group 12 - Flood damage control	17
3.7 Technique Fact Sheets Introduction	18

Number	Group Name / Measure Name	
<b>1</b>	<b>Lessening the volume of runoff close to its source</b>	
1.1	Porous Paving Modular	20
1.2	Porous Paving Asphalt	22
1.3	Vegetated Roof Covers	24
<b>2</b>	<b>Runoff quality improvement</b>	
2.1	Wet Ponds with Extended Detention	26
2.2	Oil Grit Separators	28
2.3	Sand Filters and Peat-Sand Filters	30
2.4	Constructed Wetlands	32
2.5	Grassed Swales	34
2.6	Vegetated Filter Strips	36
2.7	Bio Retention	38
<b>3</b>	<b>Control of erosion and sedimentation</b>	
3.1	Cover Crops, Temporary Mulches	40
3.2	Temporary Runoff Diversions and Chutes	42
3.3	Silt Fence and Trap Devices	44
3.4	Sediment Basins	46
3.5	Hydroseeding and Chemical Stabilization	48
3.6	Management of Construction Sites and Traffic	50
<b>4</b>	<b>Maintaining groundwater recharge</b>	
4.1	Vegetated infiltration Swales with Check Dams	52
4.2	Infiltration Basins	54
4.3	Seepage Beds	56
4.4	Gravel Filled Trenches	58
4.5	Wells and Gravity Shafts	60
4.6	Infiltration Berms	62
<b>5</b>	<b>Detaining peak flows</b>	
5.1	Wet Pond Detention Basins	64
5.2	Dry Pond Detention Basins	66
<b>6</b>	<b>Minimizing pollution from sewage</b>	
6.1	Combined Sewer Source Control	68
<b>7</b>	<b>Channel rehabilitation through transverse structures</b>	
7.1	Sills or Weirs with Plunge Pool	70
7.2	Rock Rakes	72

7.3	Rock Cascades	74
7.4	Rough Bed Channels	76
<b>8</b>	<b>Channel rehabilitation through parallel structures</b>	
8.1	Fibre Rolls and Reed Rolls	78
8.2	Live piling revetments, Live barriers	80
8.3	Terraced Streambanks	82
8.4	Branch Packing	84
8.5	Riprap and Vegetated Riprap	86
8.6	Jacks, Jack Fields, and Tetrahedrons	88
<b>9</b>	<b>Point protection and stabilization of streambanks</b>	
9.1	Brush Packing	90
9.2	Live Willow Deflectors	92
9.3	Live Slope Gratings, Timber Framing	94
9.4	Wing Deflectors	96
9.5	Rootwad and Boulder Revetment	98
9.6	Whole Tree Revetment	100
9.7	Brush Mattresses	102
9.8	Live Cribwalls	104
9.9	Live Fascines	106
9.10	Live Wattle Fences	108
9.11	Vegetated Rock Gabions	110
<b>10</b>	<b>Stabilization of upper streambank and floodplain areas</b>	
10.1	Hedge Layers, Brush Layers, Hedgebrush Layers	112
10.2	Reforestation of Riparian Forest	114
10.3	Maintenance of Existing Riparian Forest	116
10.4	Live Stakes and Dormant Posts	118
10.5	Seeding Grass and Legumes	120
<b>11</b>	<b>In-stream habitat improvement</b>	
11.1	Fish Ladders	122
11.2	Log, Brush or Rock Shelters	124
11.3	Lunker Structures	126
11.4	Boulder Clusters	128
<b>12</b>	<b>Flood damage control</b>	
12.1	Levees and Floodwalls	130
12.2	Flood Proofing and Water Pollution Control	132
12.3	Emergency Access and Flood Warning Systems	134

12. 4	References	137
-------	------------	-----

Table of Figures:

1.	Procedure chart for renaturalizing flow regimes	7
2.	Summary table of techniques	19

## **Abstract**

This manual consist of selected technical measures for urban stream rehabilitation measures, which can be become a component of urban river enhancement projects, dealing with river channels, banks as well riparian areas. Techniques presented can be integrated into urban settings to prevent or reduce problems affecting water resources. Techniques presented here improve the hydro-morphological condition of rivers and the runoff that drains into them. Urban runoff control, also called “sustainable urban drainage” is being seen as a component of urban river basin enhancement. Techniques are divided into groups related to certain aspects, such as control of the amount and quality of runoff, or channel rehabilitation. Fact sheets contain construction guidelines, maintenance aspects, advantages, disadvantages, an illustration sketch, photos and references and suggested reading. For each technique individually covered are description, application, advantages and disadvantages, maintenance. They are designed to provide an overview for professionals, decision makers, non-governmental organizations and the general public.

## **1 Planning Procedures for re-naturalizing flow regimes**

The Implementation of the EU Water Framework Directive (WFD) is expected to improve water quality and the ecologic conditions of rivers within Europe. As a result, rivers with improved water quality will flow through cities increasing the attractiveness of waterfront property for public uses, aid real estate development, and in turn help to shape the city of tomorrow. Cities that have classified their rivers as “heavily modified waterbodies” need to meet provisions of the WFD and achieve a “good ecological potential” for their urban rivers. The “Excisting Case Studies” work package of URBEM shows how selected cities in Europe and abroad have achieved good ecological conditions by combining water resources management and city planning, hence improving the quality of life. These examples may achieve the status of “best practicable technology” to guide cities how to achieve good ecological potential.

URBEM teams conducting case studies learned that the regeneration and re-naturalization of flow regimes takes much more than the mere installation of measures. Many of the successful installations in Toronto, Canada, Washington DC and in Europe presented in case studies were found to be the result of a planning process that was started more than 10 years ago and was aided by planning procedures such as those for “Natural Channel Systems: An Approach to Management and Design“ issued by the State (Ontario M. N. R. 1994). Similar guidelines were found in the United States (USDA, 2002) and in Germany ( DVWK, 1996). These guidelines advocate a transparent planning process, leading to the implementation of measures involving stakeholders that are defining goals and objectives and setting quantifiable targets that can be monitored. Procedures for the re-naturalization of flow regimes that have emerged on the international scale are remarkably similar and generally contain the following elements below in this section.

### **1.1 Identification of stream type**

The existing case studies survey form of URBEM is using the stream classification system by Rosgen (Ontario M. N. R. 1994). The classification utilized expresses physical attributes of the channel such as slope, sinuosity, width-to-depth ratio, particle size of sediments in bed and banks, stream entrenchment ratio, landform features by stability class and others. It offers a morphological tool for the classification of rivers by type.

### **1.2 Defining existing conditions**

The URBEM identification of stream types needs to be supplemented with information about flow regimes, habitat characteristics, water quality data and other information pertaining to existing conditions.

### **1.3 Setting goals and objectives**

The WFD as well as international laws call for stakeholder participation in planning. Goals may be influenced by a preferred state and “best practicable technologies” that have been demonstrated elsewhere. The setting of general goals and more numerous detailed objectives is a planning level when the public needs to be involved in a democratic process that ideally leads to the establishment of a partnership between stakeholder groups and project related agencies.

### **1.4 Evaluation of streams sections**

When the stream type, it’s existing conditions and the goals and objectives that have been defined for them are compared, deficiencies will emerge. This evaluation for rivers is best done by stream section and by following a defined procedure that can be applied equally.

### **1.5 Setting time frame targets**

Specific targets can be set for rivers, or river sections that are turned into projects. The ecological and chemical state, the flow conditions, the social and economic well-being and the implementation achievements are all targets that have been investigated in the existing case studies task of URBEM. They can be expressed in quantitative terms and linked to a timeframe. These targets are “indicators of success” (URBEM work task 10) and are necessary in order to administer projects that take years to complete.

Figure 1 - Procedure chart for renaturalizing flow regimes

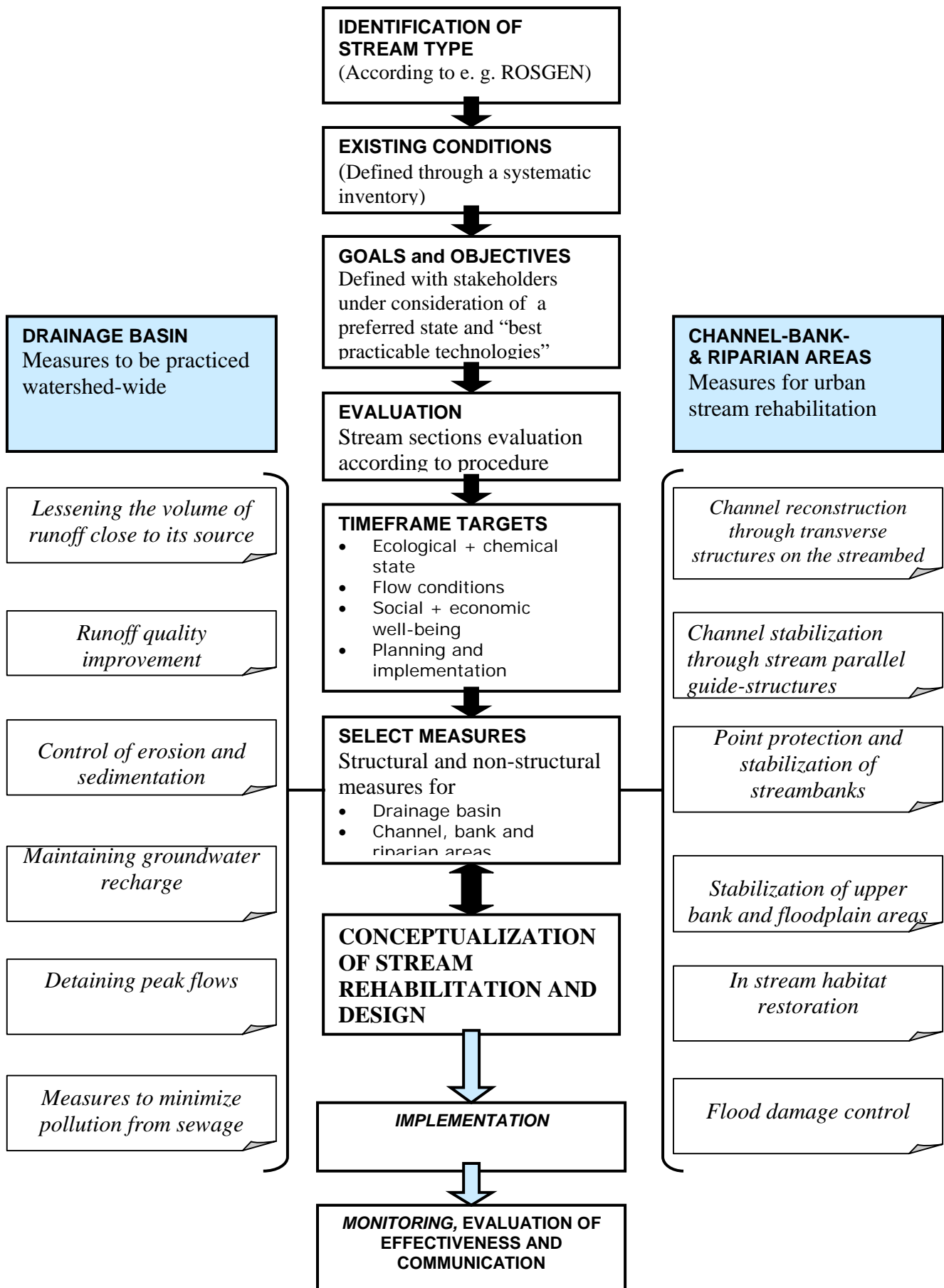

## **1.6 Selection of measures**

All the previous steps are required to be taken before a first selection of potential measures is being made. Here we differentiate between; (1) measures for a river basin or sub-drainage area and (2) measures for a channel bank or riparian area of a river section. Both types of measures are required for a comprehensive project (see Figure 4) and are described here.

## **1.7 Conceptualisation of stream rehabilitation and design**

Measures for a drainage basin and a river site need to be combined, in turn forming “treatment trains” of measures that supplement each other to meet planning targets. This requires conceptualisation for a pre-design and a final design for construction by which measures are sized to meet the conditions of a site.

## **1.8 Implementation**

Here non-structural management practices may be carried out, or structural measures may be built. This requires approved plans, construction specifications, a bidding process and construction observation.

## **1.8 Monitoring: evaluation of effectiveness and communication**

The effectiveness of a project is determined by inventorying pre-development conditions at its beginning (1.2), by comparing them to post-development conditions, and by applying criteria that are indicators of success. Monitoring costs involved are well spent when findings are communicated and used in order to convince the public and its representatives that projects financed with the taxpayers money have been a success.

## **2 Drainage Basin - Measures to be practiced throughout a watershed**

Impervious surfaces, which are often affiliated with urban land uses, have a dramatic impact on the natural functions of streams. Effects include; flooding, erosion, stream channel alterations, runoff pollution, ecological damage, reduced groundwater recharge, and base flows of watercourses. Studies suggest that aquatic biological systems begin to degrade when impervious levels of a watershed reach 10% (Schueler, 1992). Paved surfaces increase volume and velocity of runoff and directly relate to frequency and severity of flooding. Peak flows in streams among urban and urbanizing areas are many times greater than in a natural basin. Such urban peak flows cause streambank erosion and a widening of the streambed.

A remedy is a stormwater management approach that features a combination of measures that supplement each other (Tourbier, 2002). While cities are learning that an “end of pipe” treatment approach not only taxes its financial resources, it also is insufficient to meet requirements of the WFI. Furthermore, combined sewer overflows pollute rivers, major flood control dams disrupt the ecology of streams and the constriction of rivers through levies increases flood damage elsewhere. The solution should be a comprehensive approach to treat problems in the context of the drainage basin of a river, internalising costs and assigning responsibilities to property owners through a “user pays” concept. Most of the measures contained in the description that follows are best incorporated into new development, though some can be used to retrofit existing uses.



## **2.1 Measures to lessen the volume of runoff close to its source**

On natural terrain 40% of precipitation evapotranspires and up to 50% infiltrates. In urban areas similar results can be achieved through vegetated roof covers and through surfaces that infiltrate runoff. Both can be retro-fitted to existing roofs and parking lots. Measures are as follows

### **Porous Paving Modular**

Modular pavers can be made of either concrete blocks and brick, or plastic grids. They provide a surface of up to 75% permeable gravel or soil and thus allow water to gradually infiltrate. Below the filter course or bedding layer, a choker course is installed.

### **Porous Paving Asphalt**

A permeable paving system that consists of a top course of an aggregate mix of bituminous asphalt paving material. In the asphalt openings are created by exclusion of fines in the mix. Underneath is a gravel layer that acts as a temporary reservoir, permitting the slow-rate percolation of rainwater into the soil.

### **Vegetated Roof Covers**

Here a veneer of living vegetation is installed on top of a conventional flat or sloping roof. Depth of the growing medium layer determines the choice of appropriate plant societies (divided into extensive/ intensive VCR's). The foliage and the lightweight soil mixture evapotranspires, absorbs, filters, and detains rainfall.

## **2.2 Measures to improve the quality of runoff**

The first flush of urban runoff is most often severely polluted water. This includes nitrogen and phosphorus from atmospheric deposition. These two elements are the limiting factors that control algae blooms in surface waters. Depending on the intensity of their uses, urban surfaces can be divided into "harmfulness classes" and the measures to improve the quality of runoff can be related to them. The measures are as follows.

### **Wet Ponds with Extended Detention**

Wet ponds with extended detention are an effective way to combine water quality improvement, peak flow control, and other multiple uses including water-based recreation. Runoff is released via a spillway that control rate and time of discharge.

### **Oil Grit Separators**

Oil/Grit Separators are multi-chambered structures designed to remove coarse sediment and oils from stormwater prior to delivery to a storm drain network. Separators are often used as pre-treatment for infiltration BMP's such as Porous Asphalt Pavements, Modular Pavements or Infiltration Trenches. They are generally used on parking lots, on streets or other areas that receive vehicular traffic. Each separator would generally receive runoff from a drainage area of less than one acre.

### **Vegetated Filter Strips**

A vegetated boundary characterized by uniform mild slopes. Filter strips may be used on down gradients of developed tracts or on impervious sites to trap sediment and sediment-borne pollutants.

### Grassed Swales

Grassed swales are linear areas of grass, generally designed to convey runoff from one location to another. The main purpose of the swale, in addition to conveyance, is to trap suspended solids.

### Constructed Wetlands

These facilities treat runoff by utilizing the water-quality enhancement processes of sedimentation, filtration, adsorption, extended retention, as well as biological processes. Control of an adequate water level is essential.

### Bio Retention

A bioretention system is a multifunctional landscaped area that provides for the retention of a design storm and for water-quality improvement. They contain a soil aggregate of 3 feet depth and are drained underneath by a layer of crushed stone with an optional drain pipe. The surface is vegetated and improves water quality through infiltration and evapo-transpiration. They also offer owners site enhancement benefits.

## **2.3 Measures to control erosion and sedimentation**

Sheet erosion and streambank erosion are sources of sedimentation and a form of water pollution. Sediments abrade and coat aquatic organisms and clog the gills of fish and aquatic invertebrates. By the sediment blanketing the stream bottom, it is reducing the juvenile fish survival rate, impairing fish spawning grounds, and inhibiting photosynthesis of aquatic vegetation and its oxygen production. Furthermore, pollutants tend to cling to sediments and their deposits and re-suspension in urban drainage ways during flood events are a severe problem. Wherever a soil cover is removed steps need to be taken to control erosion.

### Management of Construction Sites and Traffic

Minimizing erosion during construction activities results in the reduction of one of the major sources of sediments. It not only results in faster reestablishment of vegetation, but also in an enhanced appearance. On all the sites susceptible to erosion attention should be paid to the layout of construction roads.

### Temporary Runoff Diversions and Chutes

Temporary flow diversion structures (such as gutters, drains, dikes, berms, swales, and graded pavement) are used to collect and divert stormwater to prevent the contamination of runoff and receiving water. Stormwater that is potentially contaminated can be directed to a treatment facility.

### Silt Fence and Trap Devices

Silt fences are temporary structures used to prevent or minimize transport of sediment in stormwater runoff that is leaving a construction site. They consist of a linear filter barrier constructed of synthetic filter fabric (geo-fabric), posts, and depending upon the strength of the fabric used, wire fencing for support.

### Sediment Basins

A sediment basin is formed by a barrier across a drainage way, forming an impoundment that functions as a sediment basin. The size of the basin is calculated to store expected sediment yields of disturbed sites. Once a site is stabilized the basin may be put to another use.

### Hydroseeding and Chemical Stabilization

Hydroseeders are truck-mounted and enable the forced application of a slurry of seed, water, fertilizer, soil conditioner and a fiber mulch. Steep areas, and areas of vast scale, may be seeded and fertilized economically in just one operation. Chemical soil stabilizers may also be added to the slurry to help prevent seed loss and erosion during germination.

### Cover Crops, Temporary Mulches

This measure is used to protect temporarily disturbed areas from erosion with a quick growing annual crop and/or mulch. Cover crops may be used to improve soil conditions for permanent crop by discing residue of cover crop into the soil.

Temporary mulches of shredded straw may be applied through a power blower.

## **2.4 Measures to maintain groundwater recharge**

Over 80 percent of the dry weather base flow of streams comes from groundwater. In urban areas impervious cover is reducing groundwater recharge. This particularly affects small tributary streams where severe conditions are encountered during low flow periods in the summer. Some streams fall dry at times and others have a reduced permanent flow that is needed to dilute surges of pollution from spills or to thin the discharges from sewage treatment plants. Groundwater recharge can be achieved through depression storage, surface infiltration of runoff and through below ground infiltration devices. Examples are as follows.

### Infiltration Berms

These are shallow depressions that are constructed to follow the contours of the natural landscape. The depression and ridge top are built level to intercept surface flows and to detain and infiltrate stormwater. Once the storage capacity of a channel has been reached, the berms overflow and act as a level-spreading device that converts concentrated flow into sheet flow.

### Vegetated infiltration Swales with Check Dams

A constructed open-channel drainage way used to convey stormwater at non-erosive velocities to a designed discharge point. When check dams are placed across them, they are transformed into infiltration and pollutant-removal devices.

### Infiltration Basins

A water impoundment made by excavation or construction of an embankment to intercept runoff and to maintain or increase natural groundwater recharge by infiltration through the bed and sides of a pond or basin. It is sized to hold and infiltrate the runoff from a design storm (e.g. a two year frequency storm).

### Seepage Beds

An area of excavated earth filled with crushed stone into which surface water is directed for infiltration into the ground.

### Gravel Filled Trenches

Gravel filled trenches (with an optional distribution pipe in their base) are groundwater infiltration and pollutant removal devices installed close to runoff-generating surfaces. Water is stored within the void volume of the gravel and gradually filters into the subsoil. Trenches remove both soluble and particulate pollutants through interaction with soil.

### Wells and Gravity Shafts

Wells and gravity shafts can be used where poorly drained soils or strata overlie porous substrata. By penetrating the impermeable strata, the recharge rate will be increased. They are unsuitable for areas with a shallow bedrock or watertable.

## **2.5 Measures to detain peak flow**

Urbanization will not only increase the volume of runoff, but will also decrease the time of concentration. This means that streams that receive urban runoff need to accommodate high volume peak flows that are reached in a shorter time versus streams in rural areas. This results in flooding and related flood damages. De-centralized stormwater detention

has been widely accepted as a means of guarding against increased peak rates of discharge and prolonged flooding. Detention facilities temporarily hold water and provide for a delayed discharge.

#### Dry Pond Detention Basins

These basins consist of a dry depression in the ground designed to temporarily detain and slowly release stormwater runoff at a predetermined rate. Shallow basins can be maintained with a cover of grass and may permit multiple uses.

#### Wet Pond Detention Basins

A permanent pool of water is the distinct characteristic of a wet detention basin. It provides the multi-purpose benefits of wildlife and recreation. Water quality should be maintained and the pool should be integrated into urban uses through careful design.

## **2.6 Measures to minimize pollution from sewage**

Combined sewers that carry both sanitary sewage and stormwater runoff during rainfall events service most of our cities. Most sewage treatment plants have been sized to treat only dry weather flows of sewage. During storm events the combined sewer overflow (CSO's) lighten the load on treatment plants by discharging untreated sewage into local streams. Most CSO's are located in heavily populated urban centers and are universally considered to be an urban problem. The concept of CSO's is that stormwater was expected to dilute the sanitary flow, but was then found to have a considerable pollution load of its own. Effective measures described here are source control and off-line storage.

#### Combined Sewer Source Control

Source control reduces the quantity of pollutants entering the system. This includes control of illicit connections, street sweeping, catch basin cleaning, and stormwater management measures that reduce or delay the volume of runoff entering the system. Measures to conserve water used in households will also reduce loads on treatment plants.

## **3 Channel Bank and Riparian Areas - Measures for Urban Stream Rehabilitation**

To achieve the "good ecological potential" of urban streams one will require a new approach. A more natural approach needs to be taken to manage and design channel form and function. In the past, many rivers were stabilized and hardened with concrete and steel in order to accommodate navigation and to protect urban uses from flooding and erosion. River shorelines were typically designed for a single purpose. Today there is a growing support for ecology and multiple uses as well as an interest in using "soft engineering" of shorelines at appropriate locations. Such an approach incorporates flood conveyance concerns, aquatic habitat, riparian habitat, water quality, recreation and aesthetics.

Streambank protection designs that include vegetation satisfy these multiple objectives. In Germany, federal and state laws have made strides to support such an approach. The Federal Nature Protection Act is requiring to avoid a merely mechanical improvement of rivers and is asking to replace those that occurred in the past with "biological" measures (BnatSchG). The Water Law of the State of Saxony calls for the "re-naturalization" of channalized rivers within an appropriate time frame when it is not contrary to public welfare. Natural channel design can well be accomplished with soil-bioengineering

measures that use a combination of living plant material and mechanical means to achieve specific engineering functions (Schiechl 1994). As an ancient technique soil-bioengineering was revived and further developed in Austria and Germany and is now also being advocated by government agencies in the US and Canada (USDA, 2003). On urban rivers soil-bioengineering is highly suited for reconstruction, stabilization, introduction of vegetative features and hydro-morphological improvements.

### **3.1 Channel reconstruction through transverse structures on the streambed**

Pools and riffles are a characteristic of naturally meandering stream. On average they tend to occur at intervals of 5 to 7 times the bankfull channel width of streams (Leopold 1964). Transverse structures that cross the streambed can re-establish the functions of riffles that have unfortunately been removed through ill-guided maintenance in most urban streams. Rocks and boulders placed in the streambed re-create a stream feature that provides habitat for macro invertebrates (a vital component of the food chain). They raise turbulence that aerates streams, and raise dissolved oxygen levels that are critical for fish survival. Furthermore, pools and riffles stabilize the streambed against erosion by reducing the riverbed gradient. Measures included are as follows below.

#### **Sills or Weirs with Plunge Pool**

Timber logs and/or rocks creating a weir that is less than 30 cm high. Like other transverse structures it collects and retain gravel for spawning habitat, deepens existing resting/ jumping pools, creates new pools above and/or below the structure and promote deposition of organic debris. Sills also hinders scouring of the channel bed and stabilize it.

### **3.2 Channel stabilization through stream parallel flow guiding structures**

Urban space demands along the waters edge has led to the erection of stream parallel pilings, piers and walls which in turn permits shipping, easy access and also guides stormwater flows. Shoreline enhancement that adds vegetation and wildlife value can be practiced here, though prior functions need to be retained. As a result installation often have to take the form of space-efficient, stream parallel flow guiding structures. Such soil-bioengineering structures can have a bearing and retaining strength similar to “hard engineering” and conventional pilings.

#### **Live piling revetments, Live barriers**

Revetments consist of a single or double row of pilings connected by wattle, slotted boards, heavy woven wire or geogrid fencing. The space between double row revetments is filled with brush and rocks. It is constructed parallel to the shoreline and creates a zone of quiet water behind which is protected against wave action. They are generally used where water next to the bank is more than 1m deep.

#### **Branch Packing**

A technique in which alternate layers of compacted backfill and live branches are used to restore voids, slumps, and eroded holes in stream banks. Trapped sediment refills the localized slumps or holes, while roots spread throughout the backfill and surrounding earth to form a unified mass. Conditions for colonization through native vegetation are enhanced. When certain types of willow (e.g. *Salix helvetica*) are used as a lower layer of branch packing, their roots extend into the water and create a sleeve that traps sediments which forms an additional protective toe.

#### Fibre Rolls and Reed Rolls

Cylindrical, earth filled coconut fiber rolls, approximately 6m in length and 30 cm in diameter. They are staked into place at the foot of the streambank. Rolls have a life expectancy of 6 to 10 years. Vegetation is planted behind rolls secures the streambank. Biologs of steel netting are filled with a mix of earth, gravel and reed rhizomes containing herbaceous plants that sprout through the netting and secure the bank with their roots.

#### Riprap and Vegetated Riprap

Rock rip-rap is a lining of stream banks with stone that dissipates the energy of flowing water and minimizes scouring problems. Live cuttings of at least 4 cm diameter are placed or inserted deep enough to reach groundwater to aid sprouting.

### **3.3 Point protection and stabilization of stream banks**

Point protection is practiced at pockets along streambanks that pose problems and warrant enhancement. Point protection is an efficient method that can harvest fluvial processes, leading to the deposition of gravel that modifies flow to improve the hydromorphology of streams. Their influence often extends to untreated portions downstream. Vegetated nodes have a habitat improvement function that can be combined with architectural features in urban areas. Alternative techniques are listed below.

#### Wing Deflectors

Made of logs or stone, current deflectors are a widely used structure, jutting into a stream to divert currents away from the bank to minimize erosion. When installed in a series the first groyne should be kept short, while consecutive groynes increase in length uniformly. Deflectors may be used to cause the stream to deepen the channel and so establish its course.

#### Live Willow Deflectors

Living willow racks are groin-like structures of stone and cuttings of sturdy live willow branches driven into the ground in an angle of 30-45 degrees. The willow branches are placed in the direction of flow and are secured with large stones. After sprouting willow racks will slow down floodwater flows and lead to the deposition of sediments, stabilizing streambends.

#### Brush Mattresses

Here thick layers of live branch cuttings of more than 1,50 m length are placed to cover and protect the ground. Rows of dead stout stakes are driven in 1 m spacing and connected with wire. Branches are covered with a thin layer of soil to enhance ground contact. The toe of the installation may be protected through rocks and a live fascine.

#### Live Fascines

Bound, elongated sausage-like bundles of live cut branches are placed in shallow trenches, partly covered with soil, and staked in place to arrest erosion and shallow mass wasting.

#### Live Wattle Fences

Shallow trenches are excavated parallel to the slope and dead stout pegs are driven into the trenches at 1 m spacing. Live posts are placed between stakes and live wattle bundles are woven between posts and stakes and partially backfilled with soil. Wattle fences are installed in parallel sequence with a spacing of 1 m – 2,5 m depending on the steepness of slope. The roots of the cuttings improve stability of steep banks and a brush edge will be established.

#### Live Cribwalls

Chambers of interlocking logs are filled with alternating layers of soil and live branches creating a nearly vertical wall with a slight incline. Live cribwalls are usually more than 2 m high. Construction starts with rock filled chambers below water level, and with logs secured with reinforcing bars. Cribwalls may be covered with vegetation in a single growing season.

#### Live Slope Gratings, Timber Framing

Similar to a cribwall, a live slope grating is a lattice-like arrangement of vertical and horizontal timbers laid to the surface of a steep slope. Openings in the structure are filled with backfill material and live branch cuttings are placed in a manner similar to brush layering. On the toe of the slope a trench of approximately 1 m depth is established to secure the grating against slippage.

#### Vegetated Rock Gabions

Gabions are rectangular wire baskets made of heavily galvanized or coated wire mesh. They are filled with small to medium sized rock and soil. Gabions are laced together to form terraces or a wall. Placing live branches between each layer of rock filled baskets incorporates vegetation.

#### Rootwad and Boulder Revetment

In deeper streams tree trunks can be buried into the streambank at a 90 degrees angle to the streamflow with their rootwads exposed underwater. The logs are weighed down with boulders 1.5 times the diameter of the trunk. Exposed roots slow the flow of water, trap sediments, and create in-stream habitat structure for fish spawning and rearing. Log rootwads and boulder revetments can be used as a secured foundation for further soil-bioengineering installations.

### **3.4 Stabilization of upper streambanks through surface protection measures**

Water laws in most countries make it a point to define a stream to include riparian areas that are subject to frequent and periodic flooding. The floodplain may be divided into an open floodway of high velocity flows and to an adjacent flood fringe area subject to ponding. Flood events are usually measured according to their 2, 5, 10, 20, 50 and 100 year frequency of occurrence. Vegetation on the floodplain can be divided into the reed bank zone, the softwood zone and the hardwood zone. Vegetated floodplains play a vital role in stream hydromorphology, water quality, water temperature and aquatic life. It is essential that vegetation be established and maintained in these areas, using the following techniques.

#### Seeding Grass and Legumes

These measures are used on sites not susceptible to serious erosion. Seeding with a mixture of grass and legumes will give a quick, effective, and cheap soil protection. Sod may be used when a cover is required in a short period of time.

#### Live Stakes and Dormant Posts

Cuttings from living branches (4.5 cm diameter minimum) that are inserted into the ground will root and leaf out. They are an alternative to planting rooted stock.

#### Hedge Layers, Brush Layers, Hedgebrush Layers

When providing for a long-term plant community, brush layers of cuttings are combined with rooted nursery stock plants. A hedge brush layer stabilizes cuts and fills and can be used to protect steep slopes. Hedge layers, rooted nursery stock of hedge plants, are placed horizontally into cuts made on steep slopes with the ends

of the plants extruding on the slope. Rooted woody plants are resistant to rock fall and soil coverage. Various types of rooted stock are mixed. A first pioneer stage of shrubs is established and can be followed by a forest stand community with closed canopy.

#### Reforestation of Riparian Forest

Riparian forest buffers should be re-established adjacent and upgradient from water bodies. They should be re-established along all permanent streams through a combination; the controlling invasive exotic species, the allowing of natural regeneration, and the planting of forest vegetation. Stands of exotic plants should be cut, dug, or pulled out.

#### Maintenance of Existing Riparian Forest

Riparian forests that grow at the edges of water bodies play an important role in cleansing surface water and groundwater. High quality groundwater is essential as the supply of baseflow for streams. During rain events stormwater flows towards streams both in the form of surface runoff and as shallow groundwater flow. Groundwater near the surface is often contaminated with nitrogen and phosphorus. Research has shown that forest soils and the roots of riparian forests retain nitrogen through assimilation, nitrification and denitrification.

### **3.5 Habitat Improvement**

Aquatic habitat provides cover, food, nesting and spawning sites, shelter and escape cover for fish, amphibians and other wildlife. Habitat protection and improvement refers to in-stream conditions and to riparian habitat. Both are connected. Vegetation on the waters edge provides shade and an input of leaves that directly affects the quality of the aquatic habitats. The riparian habitat as a transition area between terrestrial and aquatic environment is particularly rich in life forms. In-stream habitats such as gravel riffles, deep pools, driftwood piles, sandbars, and boulder clusters are points of interest to any sport-fisherman's association, which often willingly organizes to support improvements. These measures include the following.

#### Fish Ladders

This is a technique in which changes are made to the stream channel to eliminate natural or manmade barriers, which obstruct the migration of fish to upstream areas to spawn. Fish passages provide access to upstream areas, habitat utilization, and an improved fishery value.

#### Log, Brush or Rock Shelters

This measure may consist of an underwater, bench-like, log or brush or flat rock extension of the streambank in order to provide shelter for fish. Best located in low gradient stream bends and where open pools are already present. Such shelters function in the following ways; to provide overhead cover, to trap detritus for supporting insects and other organisms, to provide food for fish, and to supply shade that creates a cooling effect in open areas.

#### Boulder Clusters

Boulders are strategically placed groups of large rock established along a channel bend in order to break up flows and to form scour pools used by juvenile fish as resting areas. They establish shelter for aquatic life and breeding areas.



### Lunker Structures

A crib wall of logs and rocks are embedded into the toe of the stream bank, creating a fore bay that extends over the water. Lunker structures combine toe streambank protection to curb bank erosion. They also serve as shelter to aquatic life.

### 3.6 Safety and flood damage control

Enhancement of urban rivers brings social responsibilities. It is the clean water in urban rivers that will attract people who would want to experience them. These beloved riverfronts have the aesthetic qualities of tranquillity, peace, a cooling effect as well as beauty. In turn through this demand, water also has an upgrading effect on real-estate value. Waterfront property has been reported to sell at a 50% higher price than units that are removed from the water, and units that have a water view but no frontage sell for 20 to 30 % higher, depending on proximity (Tourbier 1992). Cities have recognized this and are marketing abandoned harbours and related derelict industrial sites for waterfront development.

A problem that needs to be addressed though are public health and safety concerns, particularly flood damage. Continuous increases in paved surfaces have led to more frequent flooding events throughout Europe. Cities that improve the attractiveness of rivers also must assume a responsibility not to place people in harms way. At the least, authorities must be held accountable for arranging the flood proofing of sewer lines, oil-tanks and below ground garages as well as organizing adequate emergency access and flood warning systems for residents. This requires mapping the extent of an “open floodway district” and “flood fringe areas”, as well as legislative passage of building codes for flood proofing. Possible measures are listed below:

#### Flood Proofing and Water Pollution Control

New buildings that have been permitted to be constructed on the floodplains should be built on stilts in order to avoid the reduction of flood storage capacities. Existing structures should be flood proofed to include provisions for intentional flooding of spaces below flood stages to balance internal and external pressure. Openings and doors should be reinforced. Structures should be equipped to be flood resistant hence having sufficient strength to withstand the pressure and the impacts of floating debris.

Below flood level oil tanks should be anchored to prevent flotation and leakage. Sewer lines should be equipped with flood proof lids and sewage treatment plants should be flood proofed. The storage of materials that are toxic, explosive when exposed to water, or buoyant (drift solids) should be prohibited.

#### Levees and Floodwalls

Dikes and levies should not be built in the “open floodway” district. Wherever possible existing levies should be set back to give a river more space for flooding. Temporary floodwalls to divert floodwater flows can protect critical sites. In areas that are subject to tidal flooding, dikes need to be equipped with tidal gates or backwater valves.

#### Emergency Access and Flood Warning Systems

Structures should be accessible by elevated access ramps and catwalks. For structures with high intensity uses access ramps need to be suitable to be used by emergency vehicles. Flood warning systems for communities should be developed to be timely, accurate and neighbourhood specific.

### **3.7 Technique Fact Sheets**

The technique fact sheets that follow permit a review of measures according to their purpose, application, construction guidelines, maintenance, advantages, disadvantages, including an illustration sketch, photos and references and suggested reading.

Techniques are presented in the following groups:

1. Lessening the volume of runoff close to its source
2. Runoff quality improvement
3. Control of erosion and sedimentation
4. Maintaining groundwater research
5. Detaining peak flow
6. Minimizing pollution from sewage
7. Channel rehabilitation through transverse structures
8. Channel rehabilitation through parallel structures
9. Point protection and stabilization of streambanks
10. Stabilization of upper streambanks and floodplain areas
11. In-stream habitat improvement
12. Flood damage control

This manual and its technique fact sheets should give planners of river rehabilitation projects data to select and design measures that in their combination, then constitute river enhancement schemes. A comprehensive approach has been taken to not only present measures that are being taken on the banks of a river but also to include those taken in the urban catchment area and beyond, to ensure that water as a resource is being protected. “Blue- green technologies“ can be used as a term to describe the many land based measures that not only help to achieve the “good ecological condition” called for by the EU Water Framework Directive but also provide for enhancement of banks of a river, its tributary streams and riparian areas. Fig. 2 below shows an overview of all individual technique fact sheets arranged in groups.

Number	Group Name/Measure Name	Page
<b>1</b>	<b>Lessening the volume of runoff close to its source</b>	<b>20</b>
1.1	Porous Paving Modular	20
1.2	Porous Paving Asphalt	22
1.3	Vegetated Roof Covers	24
<b>2</b>	<b>Runoff quality improvement</b>	<b>26</b>
2.1	Wet Ponds with Extended Detention	26
2.2	Oil Grit Separators	28
2.3	Sand Filters and Peat-Sand Filters	30
2.4	Constructed Wetlands	32
2.5	Grassed Swales	34
2.6	Vegetated Filter Strips	36
2.7	Bio Retention	38
<b>3</b>	<b>Control of erosion and sedimentation</b>	<b>40</b>
3.1	Cover Crops, Temporary Mulches	40
3.2	Temporary Runoff Diversions and Chutes	42
3.3	Silt Fence and Trap Devices	44
3.4	Sediment Basins	46
3.5	Hydroseeding and Chemical Stabilization	48
3.6	Management of Construction Sites and Traffic	50
<b>4</b>	<b>Maintaining groundwater recharge</b>	<b>52</b>
4.1	Vegetated infiltration Swales with Check Dams	52
4.2	Infiltration Basins	54
4.3	Seepage Beds	56
4.4	Gravel Filled Trenches	58
4.5	Wells and Gravity Shafts	60
4.6	Infiltration Berms	62
<b>5</b>	<b>Detaining peak flows</b>	<b>64</b>
5.1	Wet Pond Detention Basins	64
5.2	Dry Pond Detention Basins	66
<b>6</b>	<b>Minimizing pollution from sewage</b>	<b>68</b>
6.1	Combined Sewer Source Control	68
<b>7</b>	<b>Channel rehabilitation through transverse structures</b>	<b>70</b>
7.1	Sills or Weirs with Plunge Pool	70
7.2	Rock Rakes	72
7.3	Rock Cascades	74
7.4	Rough Bed Channels	76
<b>8</b>	<b>Channel rehabilitation through parallel structures</b>	<b>78</b>
8.1	Fibre Rolls and Reed Rolls	78
8.2	Live piling revetments, Live barriers	80
8.3	Terraced Streambanks	82
8.4	Branch Packing	84
8.5	Riprap and Vegetated Riprap	86
8.6	Jacks, Jack Fields, and Tetrahedrons	88
<b>9</b>	<b>Point protection and stabilization of streambanks</b>	<b>90</b>
9.1	Brush Packing	90
9.2	Live Willow Deflectors	92
9.3	Live Slope Gratings, Timber Framing	94
9.4	Wing Deflectors	96
9.5	Rootwad and Boulder Revetment	98
9.6	Whole Tree Revetment	100
9.7	Brush Mattresses	102
9.8	Live Cribwalls	104
9.9	Live Fascines	106
9.10	Live Wattle Fences	108
9.11	Vegetated Rock Gabions	110
<b>10</b>	<b>Stabilization of upper streambank and floodplain areas</b>	<b>112</b>
10.1	Hedge Layers, Brush Layers, Hedgebrush Layers	112
10.2	Reforestation of Riparian Forest	114
10.3	Maintenance of Existing Riparian Forest	116
10.4	Live Stakes and Dormant Posts	118
10.5	Seeding Grass and Legumes	120
<b>11</b>	<b>In-stream habitat improvement</b>	<b>122</b>
11.1	Fish Ladders	122
11.2	Log, Brush or Rock Shelters	124
11.3	Lunker Structures	126
11.4	Boulder Clusters	128
<b>12</b>	<b>Flood damage control</b>	<b>130</b>
12.1	Levees and Floodwalls	130
12.2	Flood Proofing and Water Pollution Control	132
12.3	Emergency Access and Flood Warning Systems	134

Fig. 2 Summary table of techniques

Group No

1.1

Group of measures

Lessening the volume of runoff close to its source

Measure name

Porous Paving Modular

Synonym

Rasengittersteine

Purpose

Modular pavers can be made of either concrete blocks and brick, or plastic grids. They provide a surface of up to 75% permeable gravel or soil and thus allow water to gradually infiltrate. Below the filter course or bedding layer, a choker course is installed.

Applications

Modular paving is most effective when used in drainage areas below six acres. It is recommended for parking areas where more than half of the parking spaces are used less than 20 percent of the time (i.e. retail stores or recreational facilities, and other paved areas not under continuous use). Lattice blocks are often used for overflow parking. They can also be used to create permeable strips or networks within larger areas of impermeable pavement, or as permeable covers for gravel filled trenches. They should only be installed for parking spaces and not used for the travel lanes in parking lots. The underlying soils must be well- or moderately-well drained. The depth to bedrock should not be less than 3.0 feet. Modular pavers should be designed to operate in conjunction with other measures.

Description

Modular pavers are concrete lattice blocks, monoslab concrete blocks, or perforated bricks which are overlaid upon a permeable base. The hollow areas in the pavers are filled with a soil and thereafter planted with grass. Stormwater falling upon the paved surface infiltrates through holes in the pavers or at their joints. The pavers functions as a porous wearing surface.

Modular pavers are used where a grassed load bearing surface is desired. Pavers are laid in one or two inches of sand, or in sand over 4 to 6 inches of crushed stone. The depth of the crushed stone base is increased when more temporary storage is needed.

Modular paving functions like porous paving. It disposes of first flush runoff through percolation and helps to reduce flood peaks and capacity requirements for subsequent detention facilities. It also provides for groundwater recharge, and helps to sustain the dry weather flow of streams.

The following trap efficiencies have been reported for modular paving: 80-100% suspended solids removal. 60-80% total phosphorus removal. 60-80% total nitrogen removal. 60-80% oxygen demand removal, and 80-100% trace metals removal.

Illustration /Sketch

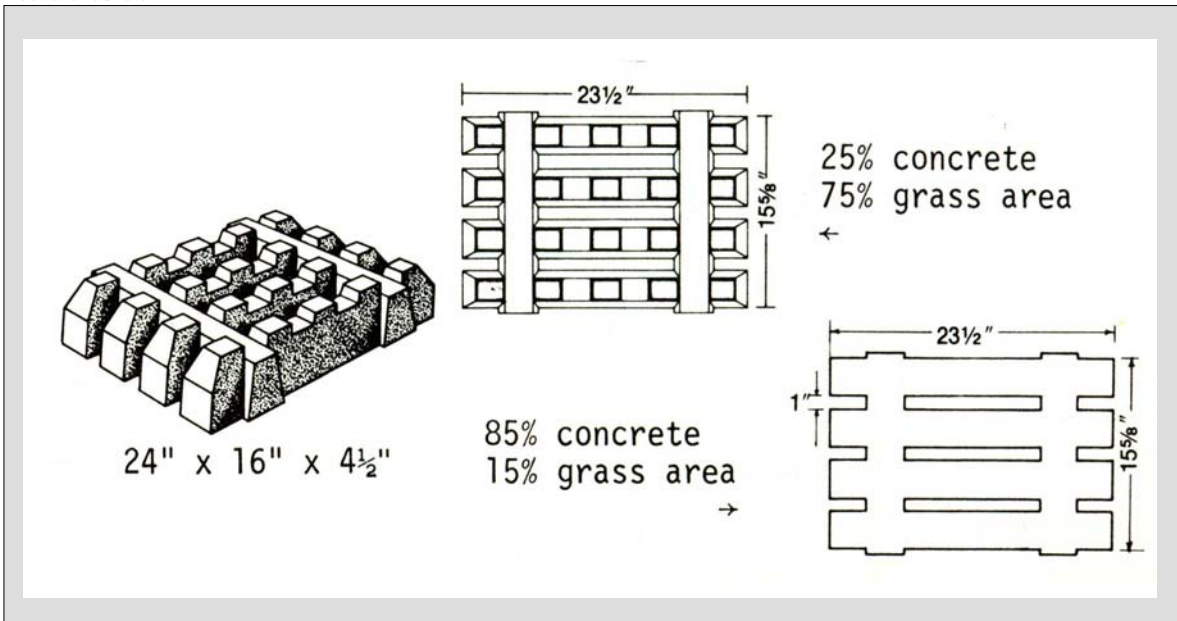

Group No

1.1

Group of measures

Lessening the volume of runoff close to its source

Measure name

Porous Paving Modular

Synonym

Rasengittersteine

Maintenance

Special maintenance provisions include weed control and reseeded of traffic-worn areas. Herbicides should not be used to control weeds due to high permeability of such a device.

Advantages

When Modular pavers are seeded with grass or filled with gravel, they present a more attractive surface than asphalt. Small sections can be lifted to reach underground utilities. Pavement is flexible and can withstand minor movement without cracking. Modular pavers and must be laid by hand. They do not provide a good walking surface. The infiltration capacity is easily clogged with fine sediments.

Disadvantages

Examples

References and suggested reading

Tourbier & Walmsley, Inc.: London Grove Township Stormwater Management Guidance Manual. London Grove Township Board of Supervisors, Philadelphia 1996;

Example Photos

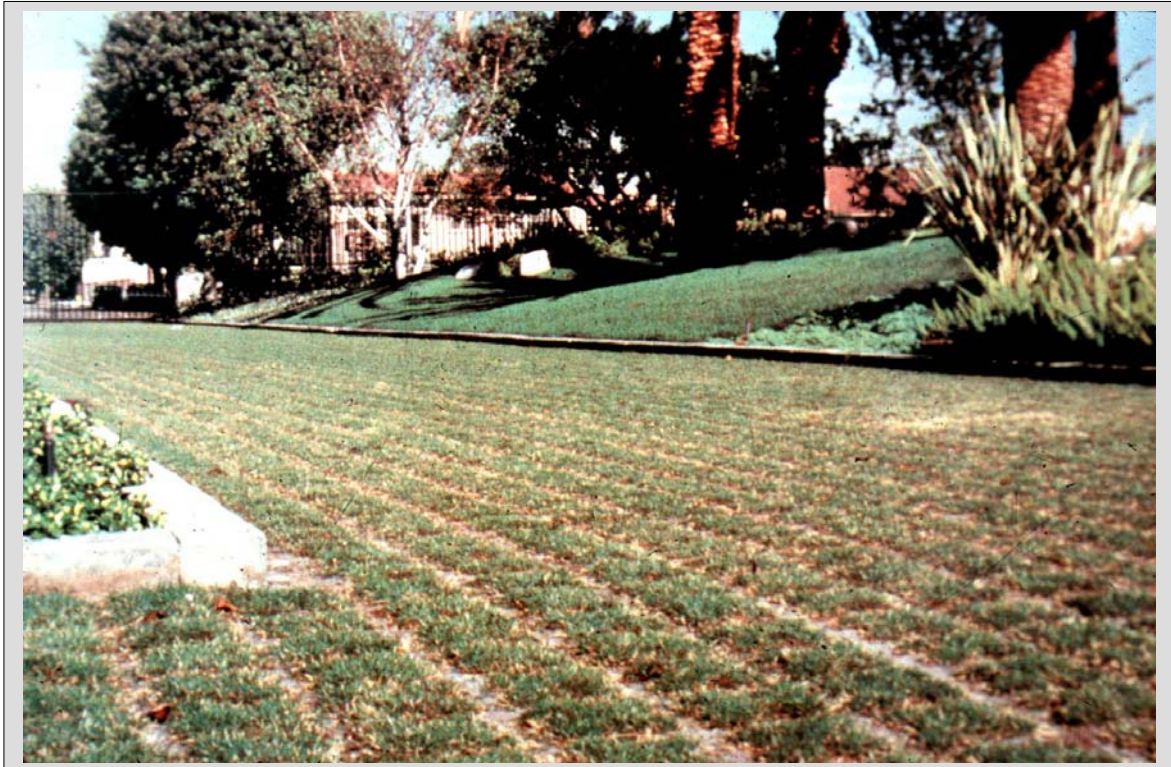

Group No	Group of measures
1.2	Lessening the volume of runoff close to its source

Measure name	Synonym
Porous Paving Asphalt	Poröser Asphalt

**Purpose**

A permeable paving system that consists of a top course of an aggregate mix of bituminous asphalt paving material. In the asphalt openings are created by exclusion of fines in the mix. Underneath is a gravel layer that acts as a temporary reservoir, permitting the slow-rate percolation of rainwater into the soil.

**Applications**

Porous pavement should only be used when the other above ground infiltration devices have been shown to be unfeasible. It is most effective in drainage areas less than 6 acres. Porous asphalt rarely is designed to stand alone, and is mostly used in conjunction with other devices.

Being a below-ground seepage device, porous asphalt permits the utilization of the surface area. It is particularly applicable to high density areas, where space is a premium commodity. Its Application is to infiltrate precipitation falling on small parking lots, individual parking stalls within larger parking lots, cul-de-sacs, and light access streets.

Porous pavement is not recommended where large volume or heavy vehicle traffic is anticipated. It is important that this measure be only used in areas where restrictions on the use of heavy trucks and where maintenance (no sand or deicing chemicals) can easily be enforced.

Underlying soils must be well- or moderately-well drained. Soils containing a seasonally high water table and shallow depths to bedrock (less than 3.5 feet) should be avoided. The grade of paved area should not exceed 3 percent..

**Description**

Porous asphalt consists of a porous top course of asphalt on a gravel layer. It is often designed to infiltrate the runoff of a 1-inch storm that will pass through the porous top course. The gravel layer acts as a temporary reservoir permitting slow-rate percolation into the soil. The top course is an aggregate mix of bituminous asphalt paving material in which openings are created by the exclusion of fines in the mix. A synthetic filter fabric is used between the sub-base and soil mantle to prevent fines migrating into voids while allowing infiltration into the soil.

Porous asphalt consists of a 2-2.5 inch wearing course with a void volume of 16%, and a 2-inch filter course of 0.5 inch crushed stone. A variable-depth reservoir footing consists of a clean, coarse layer of stone with a 40% void ratio. The subgrade should consist of undisturbed soil.

The following trap efficiencies have been reported for porous asphalt paving: 80-100% suspended solids removal; 60-80% total phosphorus removal; 60-80% total nitrogen removal; 60-80% oxygen demand removal; 80-100% trace metals removal.

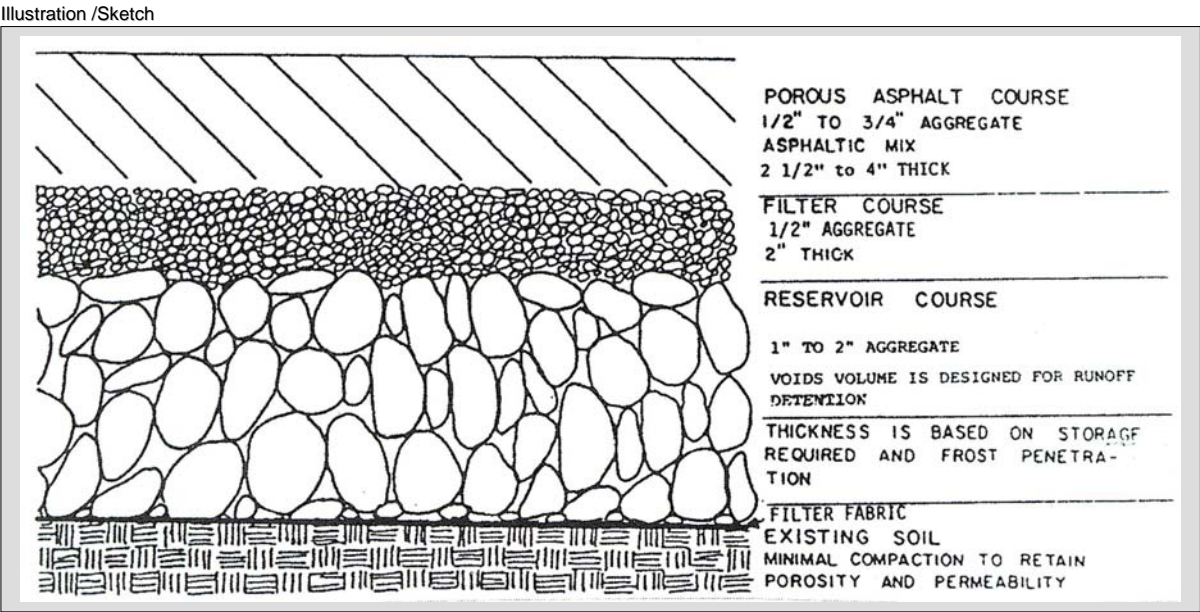

Group No

1.2

Group of measures

Lessening the volume of runoff close to its source

Measure name

Porous Paving Asphalt

Synonym

Poröser Asphalt

Maintenance

A two-part maintenance program of quarterly sweeping/ vacuuming and jet hosing is required to maintain pore openings. Monitoring wells can be installed to observe the water level in the gravel pit at 0, 24, and 48 hours after a storm event.

Advantages

Porous pavement infiltrates and filters contaminants from runoff. As a storage measure it reduces peak flooding. As a recharge device it maintains groundwater recharge which sustains the dry weather flow of streams, and preserves natural drainage patterns. Anaerobic organisms in the subsoil beneath the gravel layer improve water quality by assimilating and breaking down contaminants in the stormwater. High sediment loads and oil can clog the permeable layer and gravel bed which would result in the failure of the system.

Disadvantages



Examples

Photo below – design by Cahill Associates, West Chester, PA

References and suggested reading

Tourbier & Walmsley, Inc.: London Grove Township Stormwater Management Guidance Manual. London Grove Township Board of Supervisors, Philadelphia 1996; Tourbier, J. Toby; Westmacott, Richard: Water Resources Protection Technology. A Handbook of Measures to Protect Water Resources in Land Development. ULI- The Urban Land Institute; Washington, D.C. 1981; Tourbier, J. Toby: Blue-Green Technologies. Integrated Practices to Manage Stormwater as an Asset. Great Swamp Watershed Ass.; Madison, N.J. 2002;

Example Photos

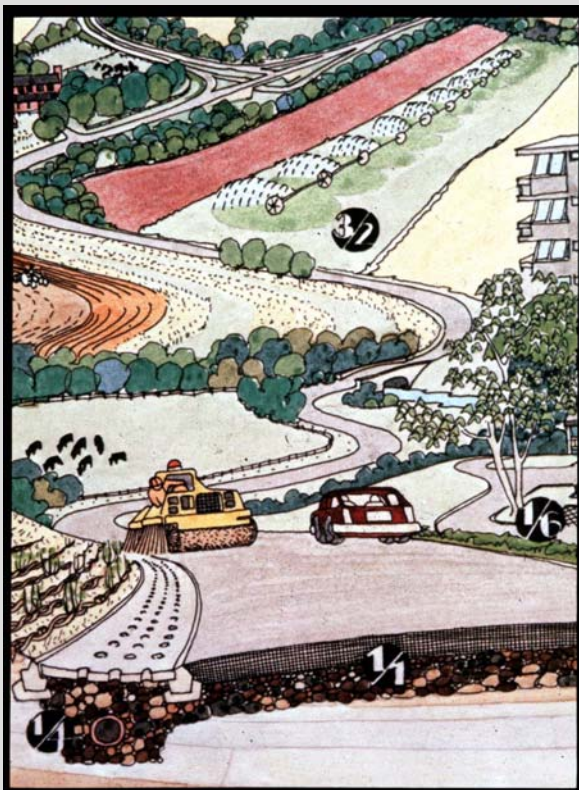

Group No

1.3

Group of measures

Lessening the volume of runoff close to its source

Measure name

Vegetated Roof Covers

Synonym

Dachbegrünung

Purpose

Here a veneer of living vegetation is installed on top of a conventional flat or sloping roof. Depth of the growing medium layer determines the choice of appropriate plant societies (divided into extensive/ intensive VCR's). The foliage and the lightweight soil mixture evapotranspirates, absorbs, filters, and detains rainfall.

Applications

By mimicking natural hydrologic processes, VCRs can achieve runoff characteristics that closely approximate open-space conditions. Plants are essential elements in the functioning of vegetated roof covers, intercepting and delaying rainfall runoff by holding precipitation in the plant foliage and absorbing water in the root zone for eventual transpiration. Even the simplest VCRs will achieve reductions in total runoff volume of 50% or greater.

Description

The VRC is a veneer of living vegetation that is installed on top of a conventional flat or sloping roof. It consists of three primary layers: (1) foliage; (2) growth medium and principal root zone; (3) drain layer. These overlay the waterproofing membrane of the roof deck. Roof covers can be designed to detain water within the roof profile.

In order to minimize weight, the drain can consist of synthetic material. Often the total load of a saturated, fully vegetated roof system is less than the weight of gravel ballast on conventional bituminous roofs. During the initial stages of a rainfall, the foliage intercepts nearly all of the precipitation. But as rainfall continues, water percolates into and saturates the growth medium and the plant root zone. When the volume of rainfall exceeds the growth medium's field capacity, significant runoff begins for the first time.

VCRs are a diverse group of systems that can meet a wide range of performance and appearance objectives.

Illustration /Sketch

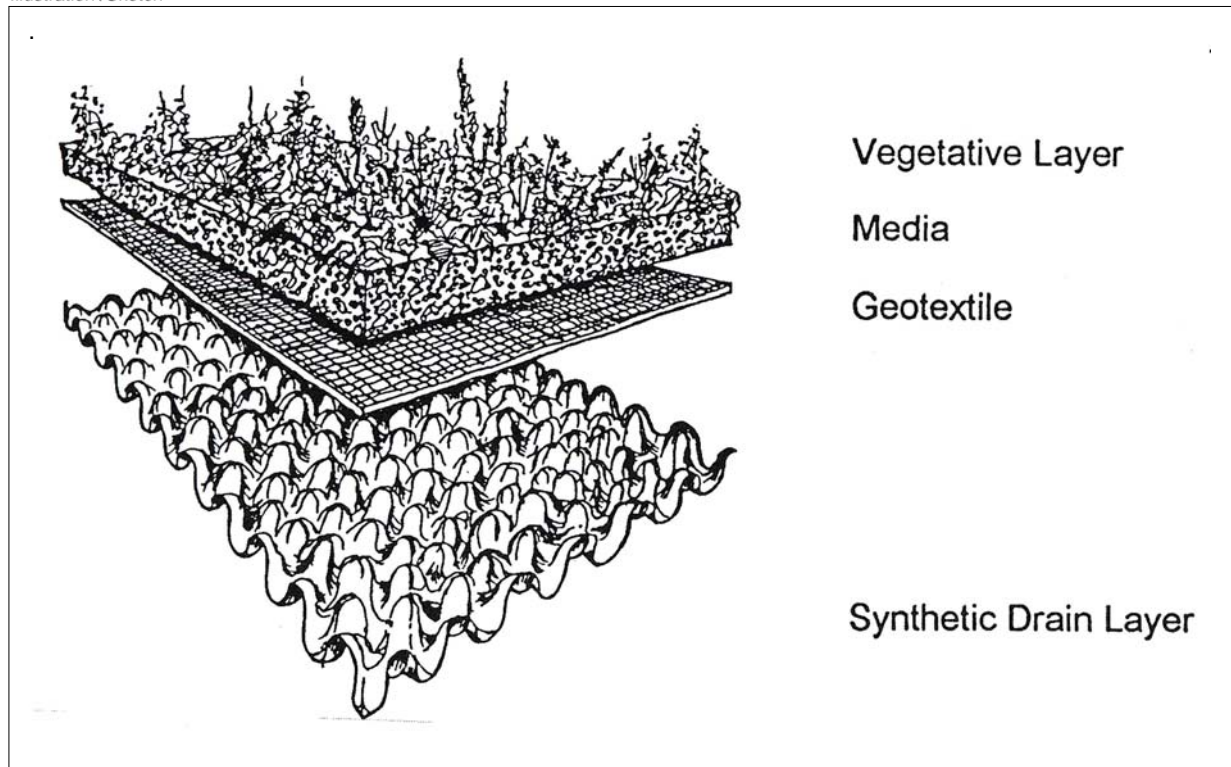



Group No

1.3

Group of measures

Lessening the volume of runoff close to its source

Measure name

Vegetated Roof Covers

Synonym

Dachbegrünung

Maintenance

The key to low-maintenance designs is the selection of plants that can thrive under the severe growing conditions without the need for routine irrigation or fertilisation. It takes 1 to 2 years for the VCR foliage layer to become fully established. During this time periodic watering and fertilisation are generally recommended. Once the cover is established, many roofs require little or no routine maintenance.

Advantages

Large reductions in cumulative annual runoff volume are readily achieved by using VCR. This is particularly important in highly urbanized areas, where runoff is correlated with flushing of pollutants into receiving streams and water bodies. VCRs are generally more effective in controlling runoff peak rates produced by rainfall events equal or smaller than 2-year storm. An evaluation will frequently show that most stormwater impacts are associated with small storms, whose impact include transport of road pollutants, chronic overflows of combined sewer systems, stream bank erosion in receiving streams, and nuisance flooding on roads and pedestrian walkways.

Disadvantages



Examples

Installation through Optigrün, Krauchenwies – Göggingen, DE

References and suggested reading

Tourbier, J.T.: Blue-Green Technologies. Integrated Practices to Manage Stormwater as an Asset. Great Swamp Watershed Ass.; Madison, N.J. 2002;

Example Photos



Group No	Group of measures
2.1	Runoff quality improvement

Measure name	Synonym
Wet Ponds with Extended Detention	Teiche mit langer Rückhaltung

**Purpose**

Wet ponds with extended detention are an effective way to combine water quality improvement, peak flow control, and other multiple uses including water-based recreation. Runoff is released via a spillway that control rate and time of discharge.

**Applications**

Wet ponds are most cost-effective in residential or commercial developments greater than 20 acres where they can be used as a landscape amenity. There is a ratio of the drainage area to the permanent pool surface area, and the infiltration rates of the underlying soil should be considered in designing the basin. Exceptions can be made when wet ponds have a dependable water supply.

**Description**

A wet pond with extended detention provides for runoff pollution control and for peak flow reduction through a permanent pool. Extended detention will permit water quality improvement by physical and biological means. The permanent pool should at least contain one-half inch of runoff distributed over the impervious portion of the contributing watershed area (Schueler, 1987). The pond should be designed to retain runoff for two weeks. Incoming stormwater (new water), displaces improved water (old water) which has been subject to extended detention and quality enhancement. The displaced water will be automatically released through the spillway. The pond should be wedge shaped, with the inlet at the narrow end and the embankment at the wide end. The pond should be shallow near the inlet end and about 6 feet deep at the embankment end. The pond should have a level underwater bench of 10 feet width, one foot below the water level, surrounding the portions of the pond where water is more than 4 feet deep. New flow is intended to displace flow from previous storms that are retained in the permanent pool. Wet extended detention basins have a trap efficiency of the following rates: (1) suspended sediment removal. 90-100%, (2) total phosphorus removal. 40-60%, (3) total nitrogen removal. 20-40%, (4) oxygen demand removal. 40-60%, (5) trace metals removal. 60-80%.

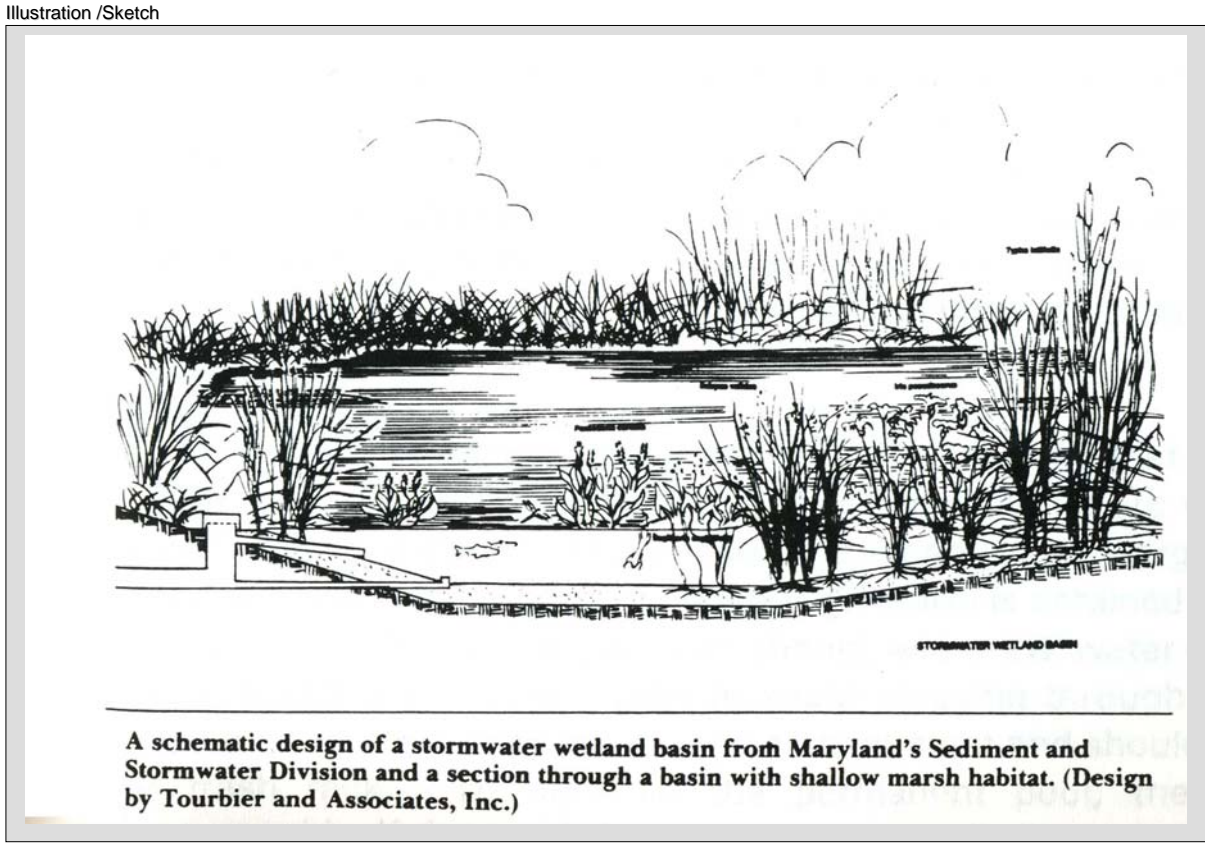

Group No	Group of measures
2.1	Runoff quality improvement

Measure name	Synonym
Wet Ponds with Extended Detention	Teiche mit langer Rückhaltung

**Maintenance**

Debris, potential algal growth, and sediment deposits need to be addressed through maintenance. The wet pond should be inspected at least once a year during a storm. Accumulations of debris around the riser should be removed on a regular basis. The permanent pool volume must be restored by dredging accumulated sediments. It is recommended that ponds contain a forebay (10 % of the total pond volume) to trap sediments to be removed in 10 year intervals.

**Advantages**

Wet ponds with extended detention are an effective way to combine water quality improvement, peak flow control, and other multiple uses including water based recreation. They serve as a landscape amenity and provide wildlife habitat including opportunities for wildlife observation. Wet ponds can be a potential safety hazard. Discharged water may at times cause stream warming affecting downstream habitats. They require maintenance.

**Disadvantages**

**Examples**

Photo below:  
Wet stormwater detention basin  
Dover Mall, Dover, DE

**References and suggested reading**

Tourbier, J. Toby: Blue-Green Technologies. Integrated Practices to Manage Stormwater as an Asset. Great Swamp Watershed Ass.; Madison, N.J. 2002.

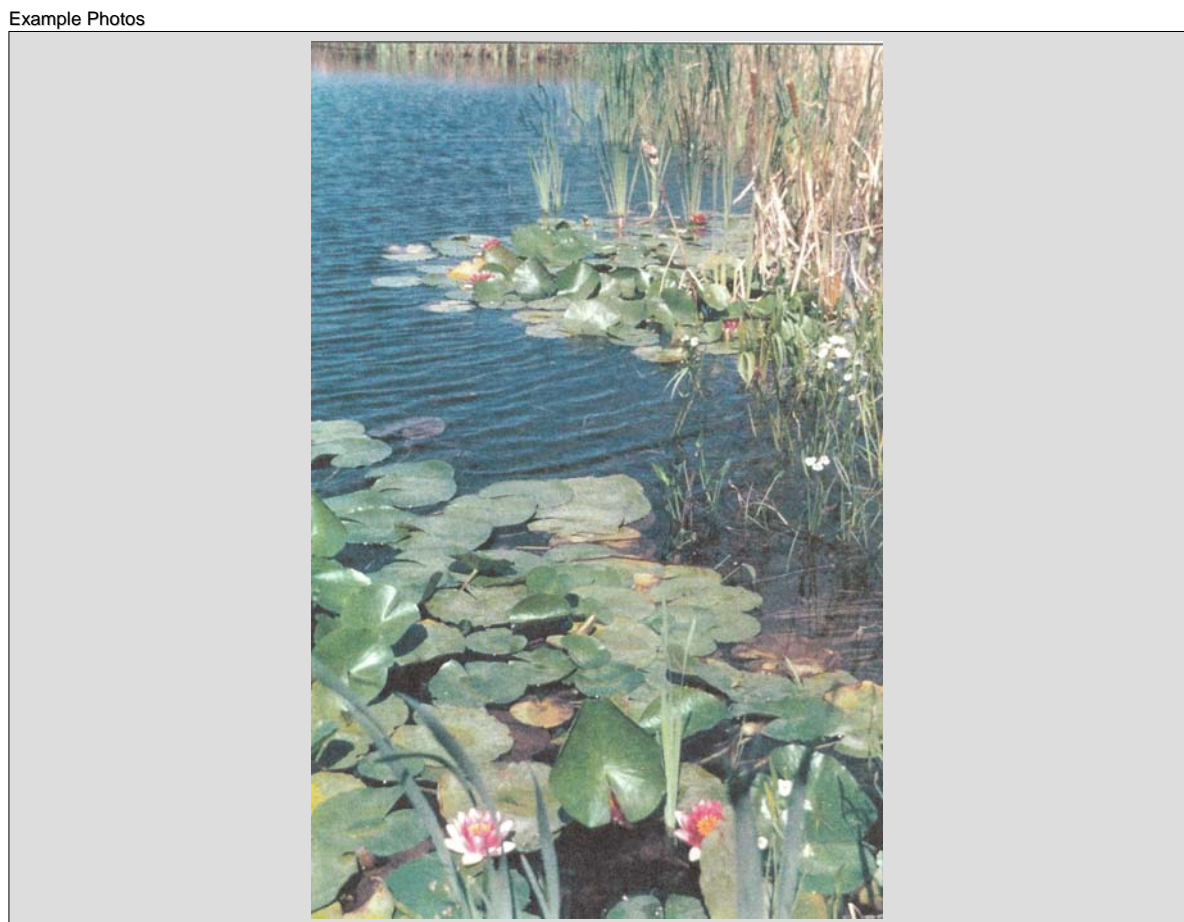

Group No	Group of measures
2.2	Runoff quality improvement

Measure name	Synonym
Oil Grit Separators	Leichtstoff Abscheider/Feststoffabscheider

Purpose	Applications
Oil/Grit Separators are multi-chambered structures designed to remove coarse sediment and oils from stormwater prior to delivery to a storm drain network. Separators are often used as pre-treatment for infiltration BMP's such as Porous Asphalt Pavements, Modular Pavements or Infiltration Trenches. They are generally used on parking lots, on streets or other areas that receive vehicular traffic. Each separator would generally receive runoff from a drainage area of less than one acre.	Oil/grit separators are particularly applicable to areas that receive high volumes of vehicular traffic or runoff containing petroleum products, i.e. gasoline/service stations, industrial parks, and loading areas. They usually serve areas of less than one acre. Due to their small volume, they have no effect on peak flow discharge rates from a two-year design storm.

**Description**

It is a pre-fabricated measure, below grade, baffled concrete chamber with a stormwater inlet. Its primary purpose is to remove suspended sediments and undissolved hydrocarbons from stormwater runoff prior to discharge.

The separator should be at least 4 feet deep and have 400 cubic feet of permanent storage for each acre of impervious surface draining into it. It contains three chambers. The first chamber settles grit and sediments via gravity and traps floating debris. The second traps floating oils and other non-aqueous liquids by drawing water from the bottom through an inverted elbow pipe. The final chamber contains an adjustable elevated outlet to form a permanent pool for additional settling. Vertical baffle plates on the floors of the chambers help to prevent resuspension of sediments in subsequent storms. This system removes up to 20% of suspended sediments as well as oil and gasoline films.

Illustration /Sketch

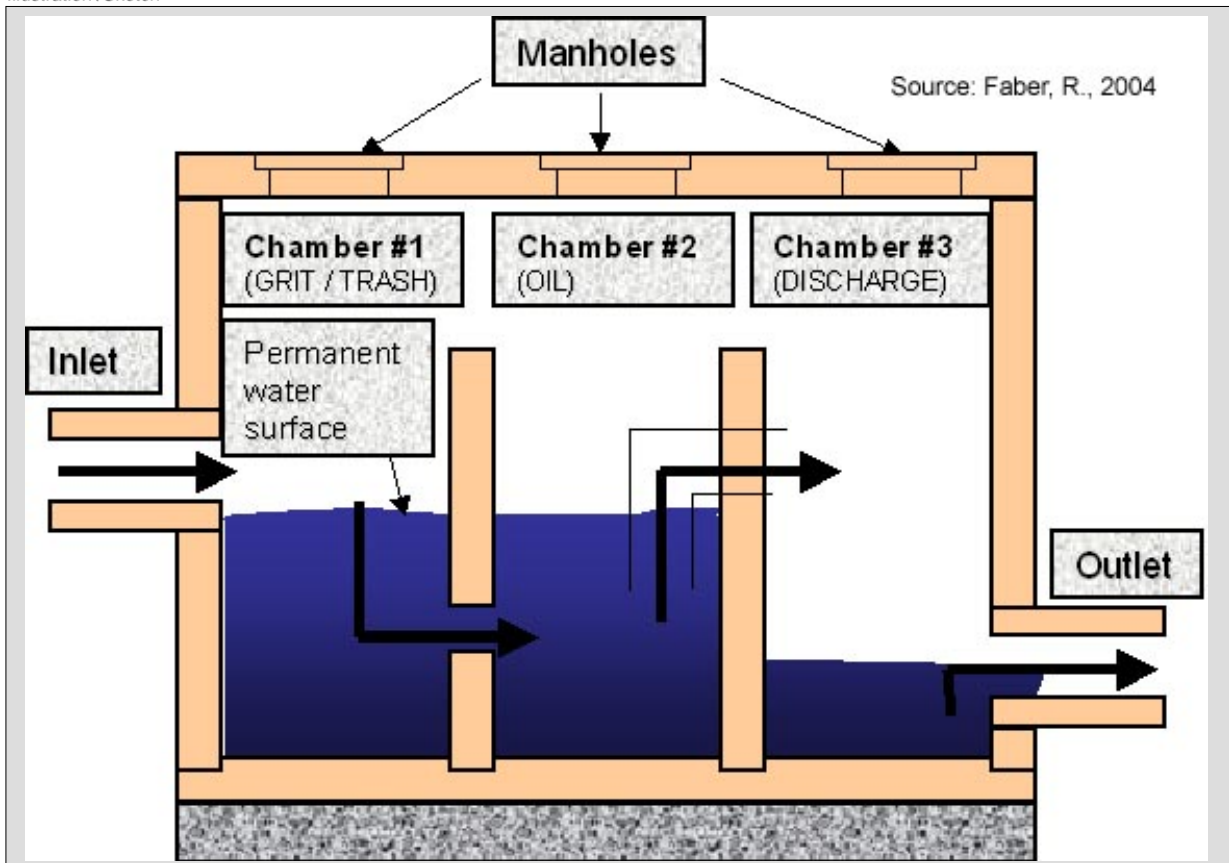

Group No	Group of measures
2.2	Runoff quality improvement

Measure name	Synonym
Oil Grit Separators	Leichtstoff Abscheider/Feststoffabscheider

**Maintenance**

Oil/grit separators must be cleaned out at least twice a year to retain trapping efficiencies. The clean out is accomplished through manhole access to each chamber by vacuum pumping or siphoning of the permanent pool and disposal on a grass filter strip or in a sanitary sewer line. Sediments are then removed manually and landfilled.

**Advantages**

Oil/grit separators require minimal land area. They can be used to retrofit small drainage areas with pollutant control capturing coarse sediments, floating hydrocarbons, and drift solids. Maintenance requirements are high. There is a potential difficulty in disposing of accumulated sediments and oils.

**Disadvantages**

**Examples**

**Example Photos**

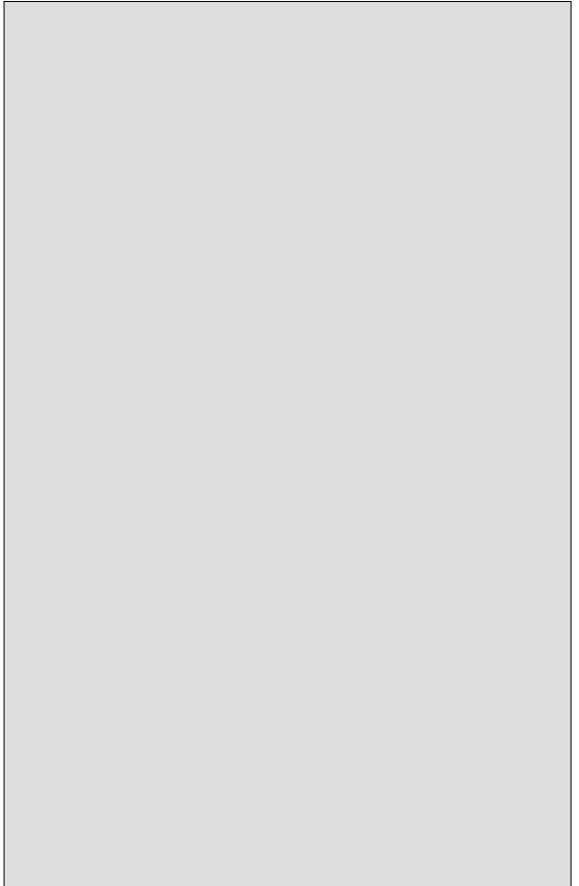

**References and suggested reading**

Tourbier & Walmsley, Inc.: London Grove Township Stormwater Management Guidance Manual. London Grove Township Board of Supervisors, Philadelphia 1996;  
 Schueler, T.R. Controlling Urban Runoff: A practical Manual for Planning and Designing Urban PMP's Washington DC., Metropolitan Washington Council of Governments, p. 8.1–8.10. 1987;

Group No	Group of measures
2.3	Runoff quality improvement

Measure name	Synonym
Sand Filters and Peat-Sand Filters	Torfmullfilter/Sandfilter

Purpose	Applications
<p>Sand filters improve runoff quality at most sites, such as infill development, downtown areas, parking lots, gas stations, and other highway-orientated commercial uses, small shopping centers, high density residential development, and dense industrial areas. Sand filters are suitable to filter runoff from impervious areas of up to two hectares</p>	<p>Sand filters are partially suitable for smaller development sites such as infill developments, downtown areas, parking lots, gas stations, and other highway-orientated commercial uses, small shopping centers, high density residential development, and dense industrial areas. Sand filters are suitable to filter runoff from impervious urban areas up to 10 acres. They should not be used where owners lack incentives or resources to maintain them properly.</p>

**Description**

Sand filters are off-line devices designed to improve water quality by filtering the first flush of runoff from impervious surfaces. The device consists of a sediment chamber, larger particles are settled out. Typically, sand filters are housed in a concrete box. Where protection of ground water quality is not vital, the sides and bottom of the filter bed can be lined with a permeable filter fabric to allow infiltration. Water is spread over the surface of the sand bed and filters through the sand by gravity. Perforated pipes in a gravel bed beneath collect the filtered runoff for downstream release. Runoff that exceeds the capacity of sand filters (amounting to 10 to 20 percent of the annual flow) should be directed to a subsequent quality control structure.

Sand filters should be designed: (1) To minimize maintenance requirements. (2) To be readily located for maintenance. (3) To fit into the landscape. (4) In a way that makes their purpose as a BMP evident to future property owners.

Sand filters remove 75 percent or more of total suspended solids, lead, zinc, organic carbon, and organic nitrogen from runoff. Removal rates for bacteria, phosphate, and copper are lower and quite variable. Higher water quality results when sand filters are combined with other BMPes.

**Illustration /Sketch**

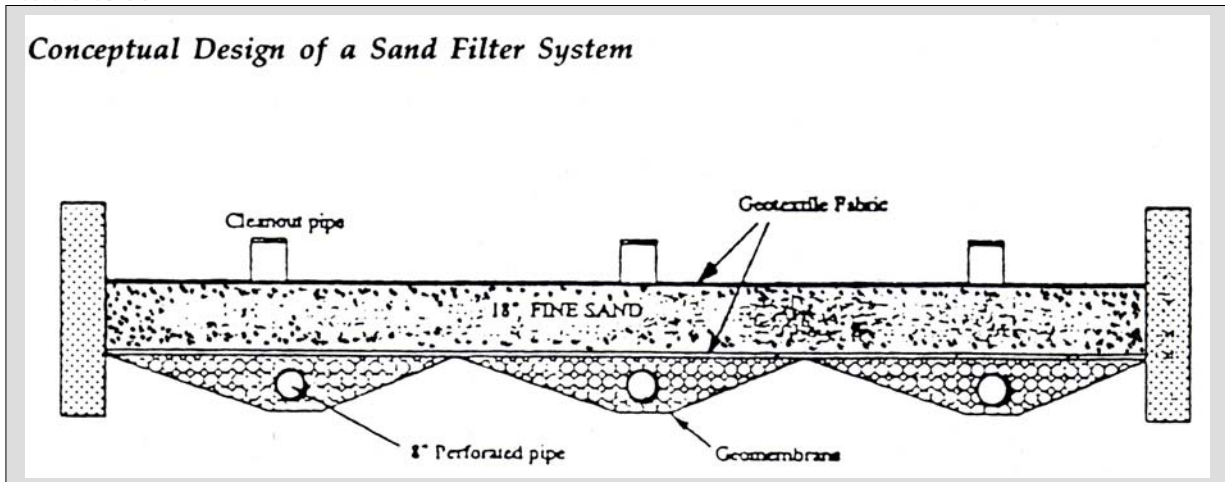

Group No

2.3

Group of measures

Runoff quality improvement

Measure name

Sand Filters and Peat-Sand Filters

Synonym

Torfmullfilter/Sandfilter

Maintenance

Sand filters must be maintained regularly. Over time, they become clogged with organic matter, fine silt, particulate hydrocarbons, and algal growth. They should be inspected at least once a year after a storm to determine the filtration capacity of the bed. Maintenance consists of removal of the top several inches of sand and replacement with fresh sand. Old sand is dewatered, then landfilled.

Advantages

Sand filters require little land, have moderate to high pollutant removal capacity, can be used on most development sites, and have fewer limitations and constraints compared to other BMP's used in urban areas.

Disadvantages

Sand filters are expensive in respect to other BMP's. Significant economies of scale can be realized with larger installations. Sand filters can freeze in cold weather, rendering them ineffective until they are thawed.

Examples



Example Photos

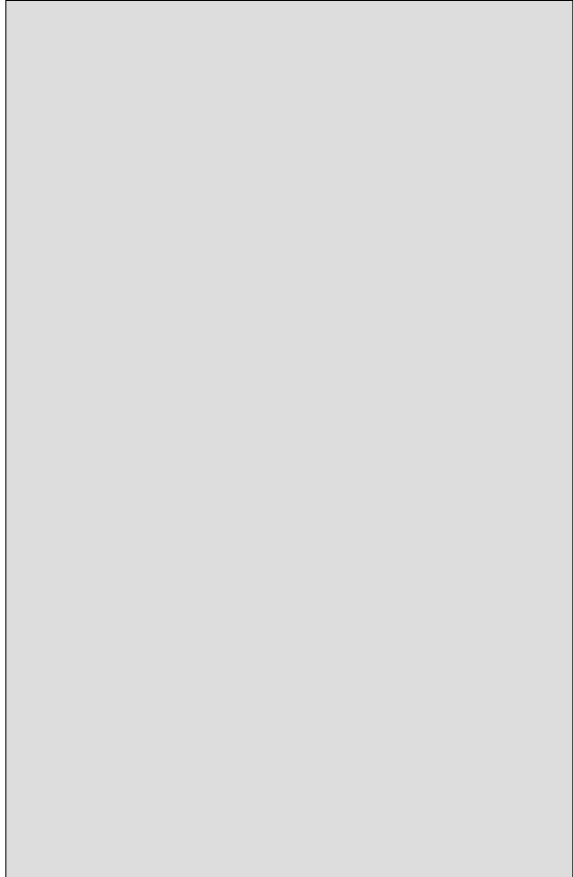

References and suggested reading



Group No	Group of measures
2.4	Runoff quality improvement

Measure name	Synonym
Constructed Wetlands	Feuchtbiotop

Purpose	Applications
<p>These facilities treat runoff by utilizing the water-quality enhancement processes of sedimentation, filtration, adsorption, extended retention, as well as biological processes. Control of an adequate water level is essential.</p>	<p>This facility may be constructed on sites where a permanent pool of water can be maintained. It can be achieved when groundwater is intercepted, or when a sufficiently large water supply is present. Shallow wetland and pond/wetland types of stormwater wetland basins are most effective in watersheds of 25 acres or more. Constructed stormwater wetland basins are applicable to most urban and rural situations.</p>

Description
<p>The purpose is stormwater flow and most importantly stormwater quality improvement. For the latter, wetlands are the most effective management practices available. There are four basic types shallow marsh, pond/wetland, extended detention wetland, and pocket wetland. Each is suitable for a specific watershed size, wetland/watershed ratios, and a desired trap efficiency. The wetland should have a treatment volume capable of capturing runoff generated by 90% of runoff producing storms and furthermore have a minimum surface area per area of contributing watershed. There should be a variety of depth zones.</p> <p>A forebay serves to still incoming water to the wetland, trap larger particulates, and spread the flow into the wetland. A micropool at the discharge end of the wetland needs to have sufficient depth for a reverse slope outlet pipe to extend into the pool where it will not be clogged by floating material or sediments. The wet zone should be planted with marsh species adapted to growth for the depth range.</p> <p>The flow path through the wetland should be as long as possible to take advantage of the variety of depth and plants, thereby increasing pollutant removal, particularly for smaller storms.</p> <p>Five to seven emergent wetland species native to the area should be planted in the marsh zones.</p> <p>Stormwater wetland basins should be sized not to exceed a loading of 45 pounds of phosphorus, or 225 pounds of nitrogen per acre, within a year.</p> <p>The typical trap efficiencies for planted wetlands are: (1) suspended sediment removal: 90-100%, (2) total phosphorus removal: 60-80%, (3) total nitrogen removal: 40-60%, (4) oxygen demand removal: 40-60%, (5) trace metals removal: 60-80%.</p>

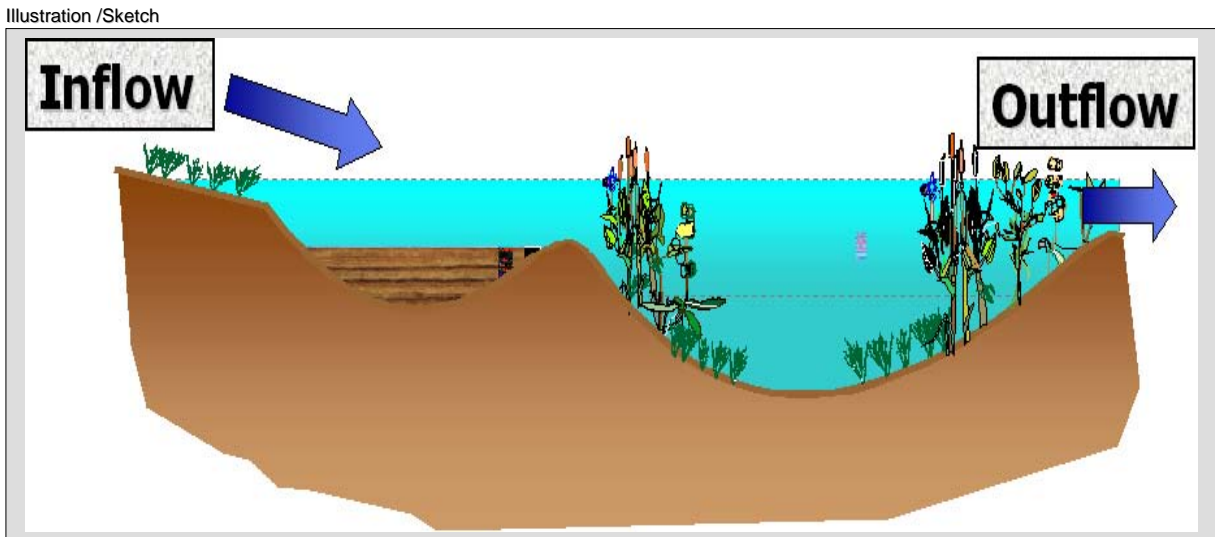



Group No	Group of measures
2.4	Runoff quality improvement

Measure name	Synonym
Constructed Wetlands	Feuchtbiootope

**Maintenance**

Stormwater wetlands should be inspected twice a year for three years after construction and once a year thereafter for species distribution and survival, water elevations, condition of the outlet, and sediment accumulation. Sediments in the forebay should be removed every three to five years. Access areas and the embankment should be mowed twice a year to discourage the growth of woody vegetation.

**Advantages**

Constructed wetlands can be designed to be a visually pleasing natural element in the landscape. They are space efficient since they can be placed within conventional stormwater detention basins. Constructed stormwater wetland design requires a good understanding of hydrology and wetland ecology.

**Disadvantages**

**Examples**

Photo below: Kaethe Seidel, Max Planck Institute

**References and suggested reading**

Tourbier & Walmsley, Inc.: London Grove Township Stormwater Management Guidance Manual. London Grove Township Board of Supervisors, Philadelphia 1996; Reeder, Rachel (Ed.): A Watershed Approach to Urban Runoff. Handbook for Decisionmakers. Terrene Institute; Washington, D.C. 1996;

**Example Photos**



Group No	Group of measures
2.5	Runoff quality improvement

Measure name	Synonym
Grassed Swales	Rasenrinne

Purpose	Applications
Grassed swales are linear areas of grass, generally designed to convey runoff from one location to another. The main purpose of the swale, in addition to conveyance, is to trap suspended solids.	Swales will be effective if and only if water has maximum contact with the vegetation and soil surface. To prevent the flow of water downward from the biofilter and the subsequent contamination of groundwater, the bed should be sealed with clay or geotextile. Plant swales with a uniform, densely growing grass with appropriate conditions for long-term survival. If the swale intercepts groundwater, emergent wetland vegetation can be used.

Description
Grassed swales are linear areas of grass (preferably native), generally designed to convey runoff from one location to another. The main purpose of the swale in addition to conveyance is to trap suspended solids and promote sheet flow. The longitudinal slope of the swale should be no greater than 4% and generally no less than 2%. If slopes are less than 2%, underdrains may need to be installed to ensure proper infiltration and drainage. If slopes are greater than 4%, energy dissipation may be needed (check dams or riprap flow spreaders). Side slopes should not be steeper than 3:1. If 2:1 side slopes are used, permanent stabilisation may be required. Flow entry into the swale must be low-energy sheet flow (i.e., not concentrated). Install flow spreading devices such as shallow weirs, stilling basins, or perforated pipes across the width of the inlet to the swale - and energy dissipators such as stilling basins and riprap pads. Hydraulic residence time should generally be 9 minutes but no less than 5 minutes; flow velocity no greater than 0.9 ft/sec.; depth of flow no more of 1/3rd the height of the palings; maximum width of 8 ft, with a minimum width of 2 ft; and a minimum length of 100 ft.

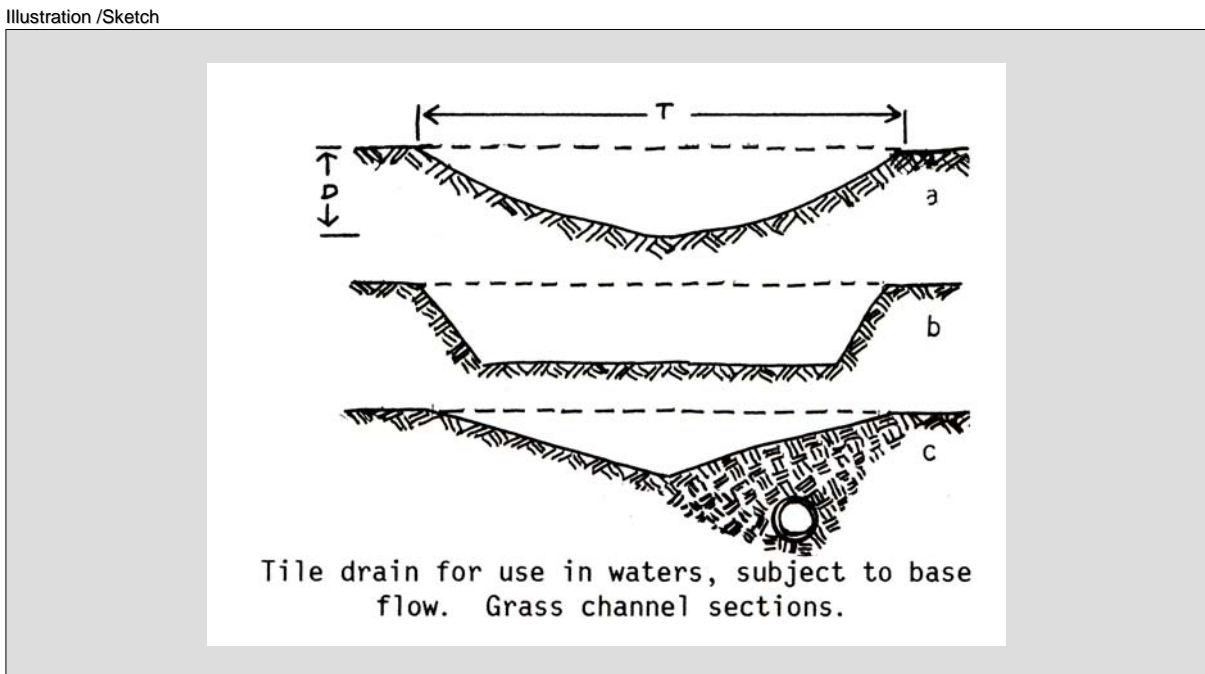

Group No

2.5

Group of measures

Runoff quality improvement

Measure name

Grassed Swales

Synonym

Rasenrinne

Maintenance

The inlet flow spreader should be kept even and free of leaves, rocks and other debris. Regular mowing during the summer will promote growth and pollutant uptake.

Advantages

Grass channels are inexpensive to construct and to maintain  
The grass itself is reducing the velocity of flow and is trapping sediments, improving the quality of runoff  
Grass swales will increase infiltration of runoff and the availability of moisture to vegetation nearby

Disadvantages

Reduction of potential surface uses in comparison to below ground drainage

Examples

Examples

Example Photos

Photos

References and suggested reading

Reeder, Rachel (Ed.): A Watershed Approach to Urban Runoff. Handbook for Decisionmakers. Terrene Institute; Washington, D.C. 1996;

Measure No	Group of measures
2.6	Runoff quality improvement

Measure name	Synonym
Vegetated Filter Strips	Bewachsene Filterstreifen

**Purpose**

Vegetated filter strips are wide, gently sloping strips of vegetation that intercept sheet runoff and remove sediment. Pollutant removal is most effective when soil is porous enough to allow infiltration but infiltration is not their primary purpose. Filter strips are not intended to reduce peak flows although they do lengthen the time of concentration. They are commonly used as protective strips along streams, rivers, and lakes. Filter strips are located downslope of the source of polluted runoff.

**Applications**

Vegetated filter strips will function only for sheet runoff that is not concentrated. They are most effective when the catchment area is less than 2 hectares. On larger sites, each filter strip should be limited to a catchment of 2 hectares or less. Soils with a permeability of more than about 1.25 cm per hour are preferred as the filtering action of the soil will increase the effectiveness in removing fine suspended and dissolved pollutants. Filter strips can be placed at the outlets of stormwater management structures only if the discharge is converted to sheet flow via a level spreader which can be fitted with an underground distribution pipe.

**Description**

Vegetated filter strips may be existing natural areas or they may be newly constructed. To be effective in pollutant removal, runoff must be in sheet form. To prevent any concentrated runoff flowing across the strip, a shallow gravel-filled trench running along the contour and precisely levelled will spread the runoff as sheet flow. Concentrated discharge from any drainage structure upslope of the strip should be distributed along the trench via an underground perforated distribution pipe. Constructed vegetated strips should be graded with a uniform slope as gentle as possible. They are not effective on slopes in excess of 15% (Schueler, 1987 p. 9:2). For the effective removal of pollutants, water must flow slowly in sheet form across a wide band of dense, vigorous vegetation growing on a permeable soil. Important effectiveness factors are the width of strip, density of vegetation, permeability and biological activity of the soil, degree of slope, and the volume and velocity of runoff. Catchment areas of more than 2 hectares should be served by separate filter strips (Schueler, 1987). Strips should be at least 6 m wide but performance will be improved if the strip is 15-25 m wide. As a rule of thumb add an additional 1.5 m to the width for every percent increase in slope (Schueler 1987). Filter strips, natural or constructed should be densely vegetated to provide effective erosion protection and trapping efficiency for suspended solids. Vegetation can range from natural woodland to mowed grass. Newly constructed strips can be allowed to develop in a natural succession. The efficiency of filter strips in trapping particulates is good but results for soluble pollutants are inconclusive. It is reasonable to expect removal of soluble pollutants to be most effective when soil is porous and vegetation is dense.

**Illustration /Sketch**

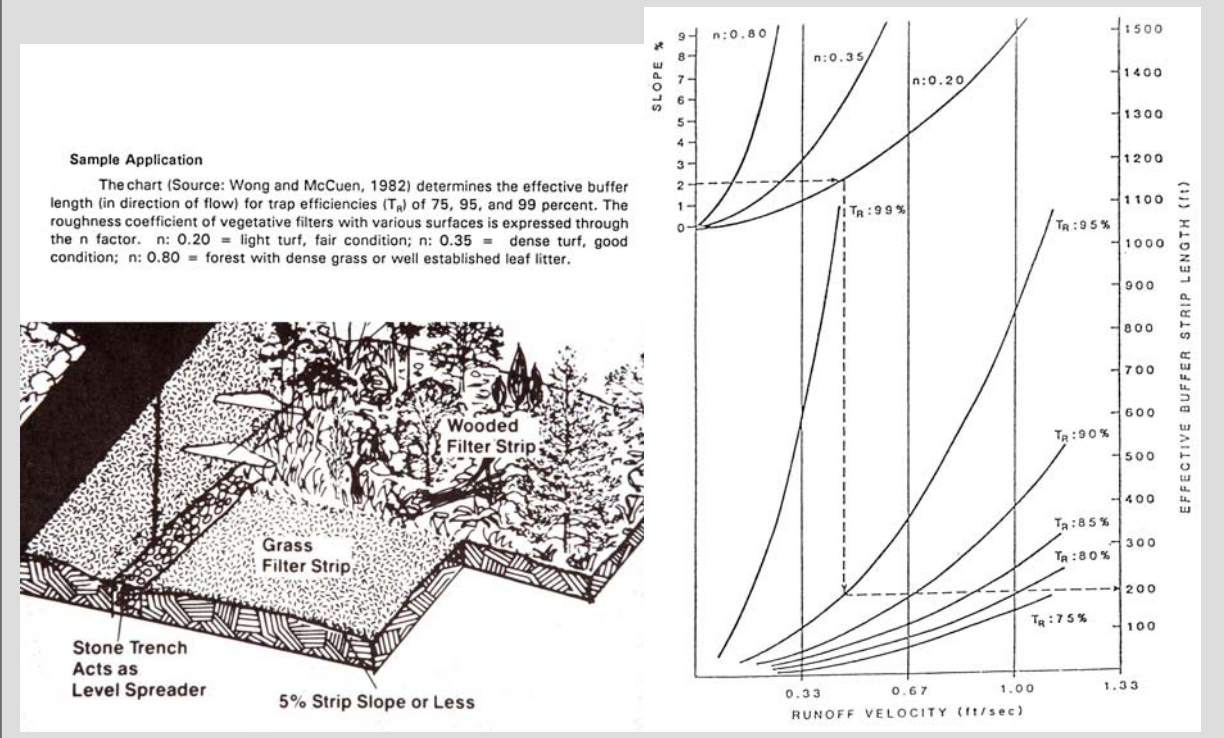

Group No	Group of measures
2.6	Runoff quality improvement

Measure name	Synonym
Vegetated Filter Strips	Bewachsene Filterstreifen

**Maintenance**

Sheet flow must be maintained if a vegetated filter strip is to be effective. Maintenance must insure that gullying does not occur. Following severe storms, strips should be inspected and any signs of runoff concentration and gullying be corrected to restore sheet flow. This is especially important while new vegetation becomes fully established and when natural succession is allowed and shading begins to reduce the density and vigour of ground-cover vegetation. Grass filter strips should be mowed at least once during or at the end of the growing season. If natural succession proceeds, any undesirable invasive species should be removed, taking special care to prevent domination by aggressive exotic species. Any accumulation of sediments should be removed regularly. Maintenance inspections should include careful observation of signs of wear caused by recreational access. Gully erosion is likely to begin along sloping pathways across the strip. Compaction can also reduce the effectiveness of the measure.

**Advantages**

In addition to water quality improvement, filter strips can significantly increase infiltration and, as a result, base flow in streams. Filter strips preserve a natural vegetated corridor along streams and lake shores that will provide important habitat for wildlife and be a visual enhancement to any development. Setbacks from streams and bodies of water are usually required in development plans and therefore vegetated filter strips may not represent a significant loss of development land.

**Disadvantages**

If flows are allowed to concentrate, gullying will occur and filter strips will become ineffective. Gullies will often form along downhill paths used for recreational access. The effectiveness of filter strips in removing dissolved pollutants is inconclusive. If the required filter strips are very wide in order to achieve higher levels of fine particulate and nutrient removal, there may be a significant loss of prime development land, which will be resisted by developers

**Examples**

Example photo below  
 Design: Tourbier  
 Construction: Pohlig Construction,  
 Philadelphia, PA

**References and suggested reading**

Reeder, Rachel (Ed.): A Watershed Approach to Urban Runoff. Handbook for Decisionmakers. Terrene Institute; Washington, D.C. 1996.  
 MWCG Schueler 1987

**Example Photos**



Group No

2.7

Group of measures

Runoff quality improvement

Measure name

Bio Retention

Synonym

Rückhalt mit biologischer Aufwertung

Purpose

Bioretention areas are planted areas of deep absorptive soils that improve runoff quality and recharge the groundwater. They can also significantly increase the time of concentration and reduce the total volume of runoff and so reduce flood peaks. Shallow depressions (natural or man-made) are filled with a free draining soil mix (with under-drainage if necessary) to form a sponge-like lens capable of retaining and infiltrating runoff. The areas are landscaped.

Applications

Bioretention should be used in upstream areas as close as possible to the source of runoff. The areas can be beautifully landscaped and can be located in private gardens or public open space. Bioretention should not be used where the water table is less than 2 m below the surface or on slopes greater than 20%. Nor should they be used where mature trees (such as beech) are intolerant of periods of inundation, however brief. Bioretention beds can be used manage water from rooftops and other impermeable areas and greywater from residential uses.

Description

Bioretention essentially mimics the hydrological function of natural woodland. The quality of stormwater is greatly improved and secondary benefits include the absorption of a large proportion of precipitation and the enhancement of infiltration and groundwater recharge. Bioretention systems can be used on-line or off-line. On-line systems are located in grass swales or other linear conveyance systems where space permits. Small check dams can be used to create shallow depressions to retain stormwater (see also Measure 4.1 Vegetated Infiltration Swales with Check Dams). These depressions can extend (by excavation if desired) beyond the regular parallel boundaries of the swale. Off-line bioretention areas are located to receive runoff directly from impervious surfaces and roof drains or can be diverted from a storm drain. They may also receive residential greywater. Natural depressions in the terrain are selected or shallow depressions 1-1.5 m deep are dug. On the base is placed a 15cm layer of crushed stone which is covered with a filter fabric/root barrier. Above this is placed 1m of free draining soil mix. This soil mix should have a pH between 6.0 and 7.0 to maximise pollutant removal by microbial activity, and should have an organic content of at least 3%. Any concentrated flow should be spread over the bed with a level spreader. Underdrainage with a perforated pipe system in the crushed stone layer is optional. Bioretention areas are planted with species that are tolerant of occasional brief periods of inundation. If runoff contains a large amount of coarse sediment that can quickly clog the system, an upstream pre-treatment area can be used. Bioretention should be designed to treat runoff associated with the "water quality design storm". If a design storm is not specified, a 6-month storm should be used. Peak discharges from larger storms should be by-passed.

Illustration /Sketch

Schematic of a bioretention area serving a parking lot (Source: Prince George's County, MD)

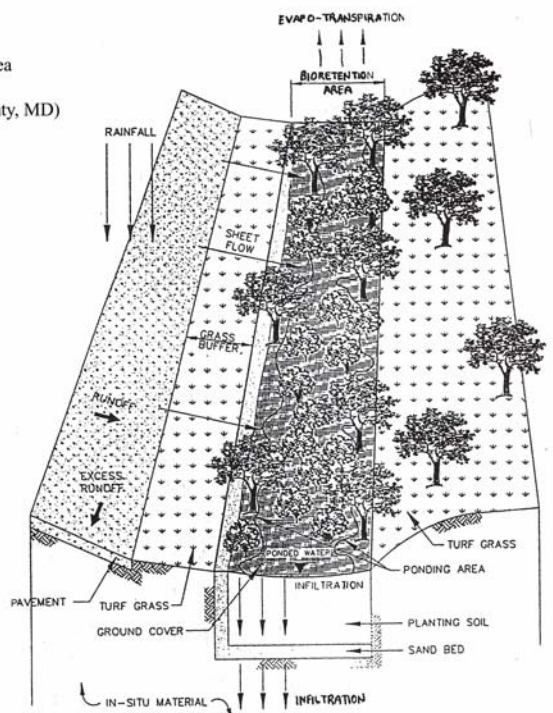

Group No	Group of measures
2.7	Runoff quality improvement

Measure name	Synonym
Bio Retention	Rückhalt mit biologischer Aufwertung

**Maintenance**

Monthly inspections are advocated until plants are well established. Annual inspections should then be satisfactory. When inspected the accumulated sediment behind check dams should be removed periodically. Furthermore, collector pipe systems in the gravel bed of the underdrainage system can also become clogged. Therefore, periodic pipe clean-outs (backwashing) are recommended.

**Advantages**

Second only to wetlands, bioretention systems offer the best pollution removal capabilities of all measures. Sometimes called "rain gardens" this measure allows owners to landscape the area to their tastes. They are space-efficient and, for instance, can be fitted into parking lot islands. There are no concentrated release points that could cause streambank erosion and no thermal impacts. The design of bioretention systems can be varied to suit different soil conditions, habitat requirements, ecological and hydrological objectives, watershed hydrology, and aesthetic preferences.

**Disadvantages**

Private land owners may neglect maintenance but maintenance requirements are very few so problems are rare. Systems that include underdrainage are most likely to require more maintenance.

**Examples**

Example Photo below:  
Bioretention at Beltway Plaza Shopping Mal, Greenbelt, MD

**References and suggested reading**

Reeder, Rachel (Ed.): A Watershed Approach to Urban Runoff. Handbook for Decisionmakers. Terrene Institute; Washington, D.C. 1996.  
Tourbier, J. Toby: Blue-Green Technologies. Integrated Practices to Manage Stormwater as an Asset. Great Swamp Watershed Ass.; Madison, N.J. 2002.

Example Photos



Group No

Group of measures

3.1

Control of erosion and sedimentation

Measure name

Cover Crops, Temporary Mulches

Synonym

Decksaaften, Mulchen

Purpose

The purpose of this measure is to protect temporarily disturbed areas from erosion with a quick growing annual crop and/or mulch. Cover crops may be used to improve soil conditions in the long term by disking the residue into the soil.

Applications

This measure is applicable on all sites which are disturbed over a full growing season and where it is not feasible to install permanent cover

Description

Cover crops are often agricultural crops adapted for rapid germination and growth. Small grains such as rye, wheat or oats are commonly used and also annual grasses such as annual rye-grass. They are often applied with a synthetic or chopped straw mulch using a hydroseeder. Temporary mulches of shredded straw alone may be used and also applied with a hydroseeder blower.

Illustration /Sketch

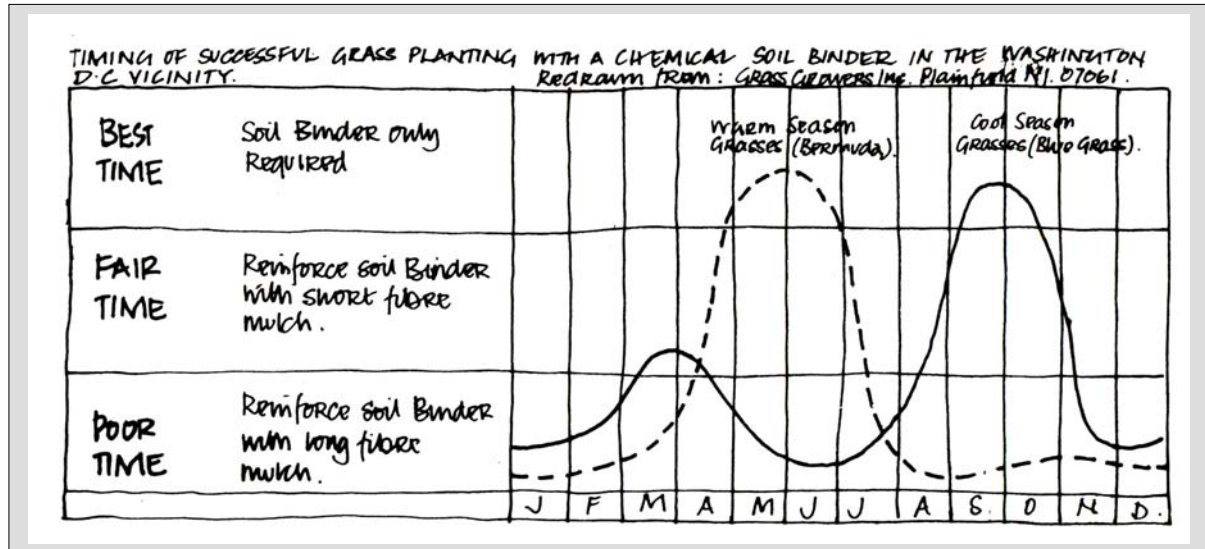



Group No	Group of measures
3.1	Control of erosion and sedimentation

Measure name	Synonym
Cover Crops, Temporary Mulches	Decksaaaten, Mulchen



**Maintenance**  
 As this is a temporary measure maintenance is not usually required. If the crop fails, or only germinates in patches, reseeding might be necessary. The correct choice of cover crop is the key to effectiveness and low maintenance

**Advantages**  
 Erosion on construction sites can be costly to the developer and correction measures can be costly

**Disadvantages**

**Examples**  
 Examples

**Example Photos**

**References and suggested reading**  
 Tourbier, J. Toby; Westmacott, Richard: Water Resources Protection Technology. A Handbook of Measures to Protect Water Resources in Land Development. ULI- The Urban Land Institute; Washington, D.C. 1981;

Group No

3.2

Group of measures

Control of erosion and sedimentation

Measure name

Temporary Runoff Diversions and Chutes

Synonym

Temporäre Umleitungen

Purpose

Temporary flow diversion structures (such as gutters, drains, dikes, berms, swales, and graded pavement) are used to collect and divert storm water to prevent the contamination of runoff and receiving water. Storm water that is potentially contaminated can be directed to a treatment facility.

Applications

This measure is used to protect temporarily disturbed areas from erosion by diverting erosive flows away from susceptible areas. It is also used to divert unpolluted stormwater around a disturbed site where it is likely to pick up sediments and other pollutants.

Description

A **diversion**, also called **Interceptor Dike**, consists of a channel and a berm. It is normally created by a cut and fill, though temporary diversions may be created by placing a well-compacted earth berm on a slope. This will withstand slight storms and will divert runoff where washouts could cause serious problems. Diversions are designed to convey runoff along the contour at safe flow velocities. Channels that are constructed on cut can convey runoff at greater velocities than channels constructed wholly or in part on fill. Temporary diversions are designed by calculating peak runoff for a design storm of two-year frequency for roads and playing fields and five-year frequency storms for building sites. A freeboard is usually not required. The side slope of a temporary diversion that is frequently passed by construction traffic should not exceed 4:1. The cross section may be parabolic, v-shaped or trapezoidal. Gradients should generally be between 0.5-1.0 percent **Temporary Chutes** are best used on cut slopes where they are formed with a cover of bituminous concrete, or Portland cement concrete. They require an apron at their discharge point to extend at least 1,0 m beyond the toe of the slope. Discharges should occur on undisturbed ground or onto a load of riprap. **Flexible Down Drains** are ideal for fill slopes. They are usually constructed of heavy-duty canvas or plastic, need to be staked down and also require a discharge apron and energy dissipater at their point of discharge.

Illustration /Sketch

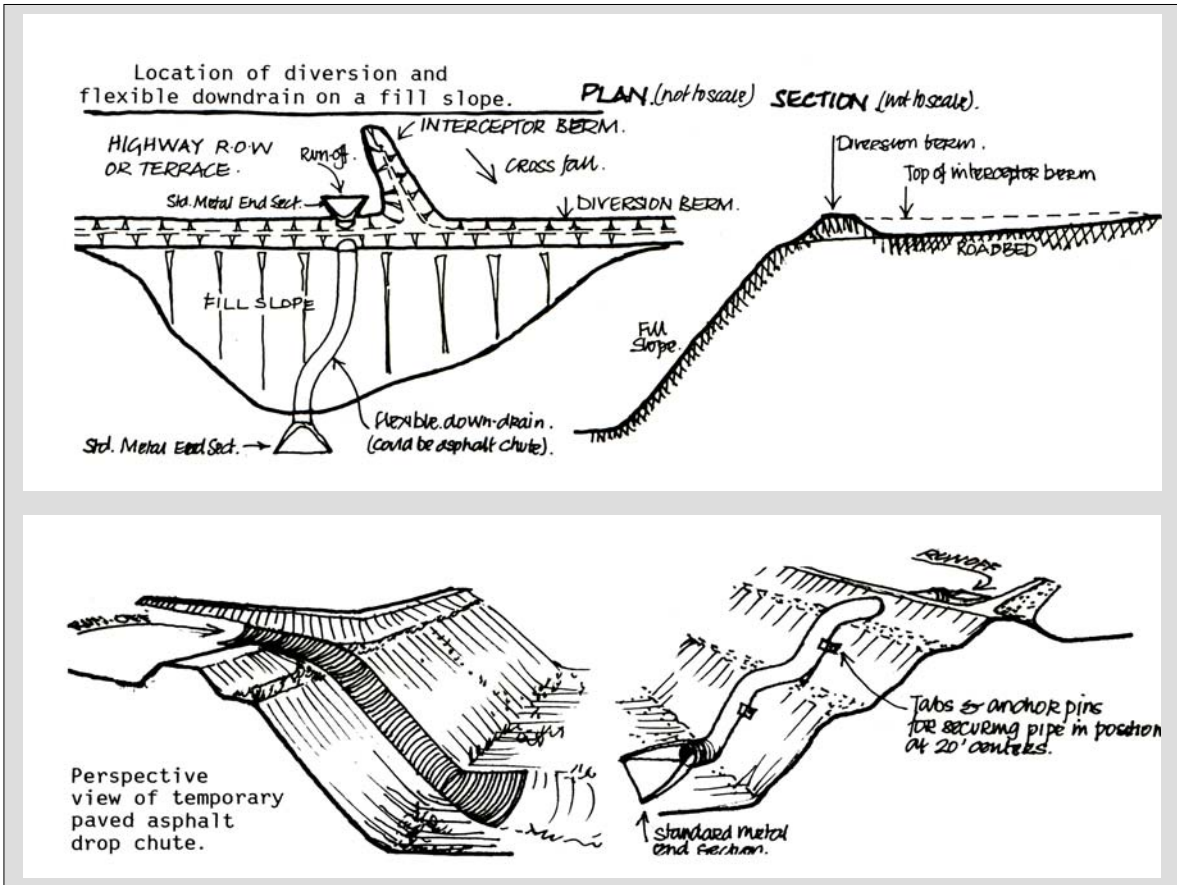

Group No	Group of measures
3.2	Control of erosion and sedimentation

Measure name	Synonym
Temporary Runoff Diversions and Chutes	Temporäre Umleitungen

**Maintenance**  
 All temporary measures should be inspected for washouts regularly and should be promptly repaired

**Advantages**

Temporary diversions protect areas where final grading has been completed from erosion by overland flow, permitting vegetation to root for final soil stabilization.

Temporary diversions may be used to prevent runoff entering partially completed storm drainage systems.

The amount of re-grading and repair is minimized.

**Disadvantages**

Diversions may actually cause an increase of infiltration into fill slopes, resulting in slumping and instability problems.

Additional costs are often high enough a deterrent to take a gamble on the weather, rather than to incur costs.

**Examples**  
 The photograph below shows a flexible downdrain used in contract work for the Delaware Department of Transportation, USA.

**References and suggested reading**  
 Tourbier, J. Toby; Westmacott, Richard: Water Resources Protection Technology. A Handbook of Measures to Protect Water Resources in Land Development. ULI- The Urban Land Institute; Washington, D.C. 1981;

Example Photos



Group No	Group of measures
3.3	Control of erosion and sedimentation

Measure name	Synonym
Silt Fence and Trap Devices	Feststoff Filterzeune

Purpose	Applications
<p>Straw bales were once used to form a linear barrier to trap sediment in runoff from construction sites. Bales continue to be used but silt fences made of synthetic geotextile are now more common. These are temporary structures that consist of a linear barrier of synthetic filter fabric supported by posts and if needed, wire fencing for support.</p>	<p>Silt fences are used on the downslope boundaries of all construction sites where earth disturbing activities are planned. In many areas they are required under erosion and sediment control ordinances. Silt fences are not reliable where boundaries cross drainage swales that carry large volumes of concentrated stormwater. At these points sediment basins will be more effective (Measure 3.4). Silt barriers or fences are also used within construction sites to prevent drainage structures being clogged by sediment.</p>

**Description**

Silt fences are installed along the downslope boundaries of construction sites. After marking the alignment of the proposed fence, a narrow trench 15 cm deep is dug along the alignment, and fence posts driven at 1m intervals at the downslope edge of the trench. Filter fabric (width 1m) is then stapled to the upslope side of the posts with the lower edge buried in the soil. If it is desired to give the fence greater strength, wire mesh may be attached to the fence posts before installing the fabric. The fabric can then be laced to the mesh. Some contractors prefer to place the trench about 0.5m upslope from the fence. One edge of 1.5m wide filter fabric is buried in the trench and then stapled to the posts to form a channel above the fence (fig. WRPT 2:6) Where the fence crosses gullies or existing drainage swales, a double parallel fence can be installed. Sometimes it is recommended to pack the space between with straw.

If straw bales are to be used they should be placed end to end along the boundary to be protected and then staked down with 5cm X 5cm wooden stakes (length 1m). Each bale should be secured by two stakes. Steel reinforcing-rod may also be used to stake down bales. Where the alignment crosses small drainage swales a double line of bales should be used. Where larger swales, a double fence of wire mesh should be constructed across the swale, spaced so as to allow straw bales to fit tightly between them. Or larger swales can be protected with sediment basins (Measure 3.4)

There are a number of manufactured devices available to protect existing or newly installed stormwater inlets from clogging by sediment. If filter fabric is used it is best to construct wooden box frames slightly larger than the outside dimensions of the inlet, and staple the fabric to these frames. Straw bales may also be used to surround the inlet. These should be secured with two wooden stakes per bale.

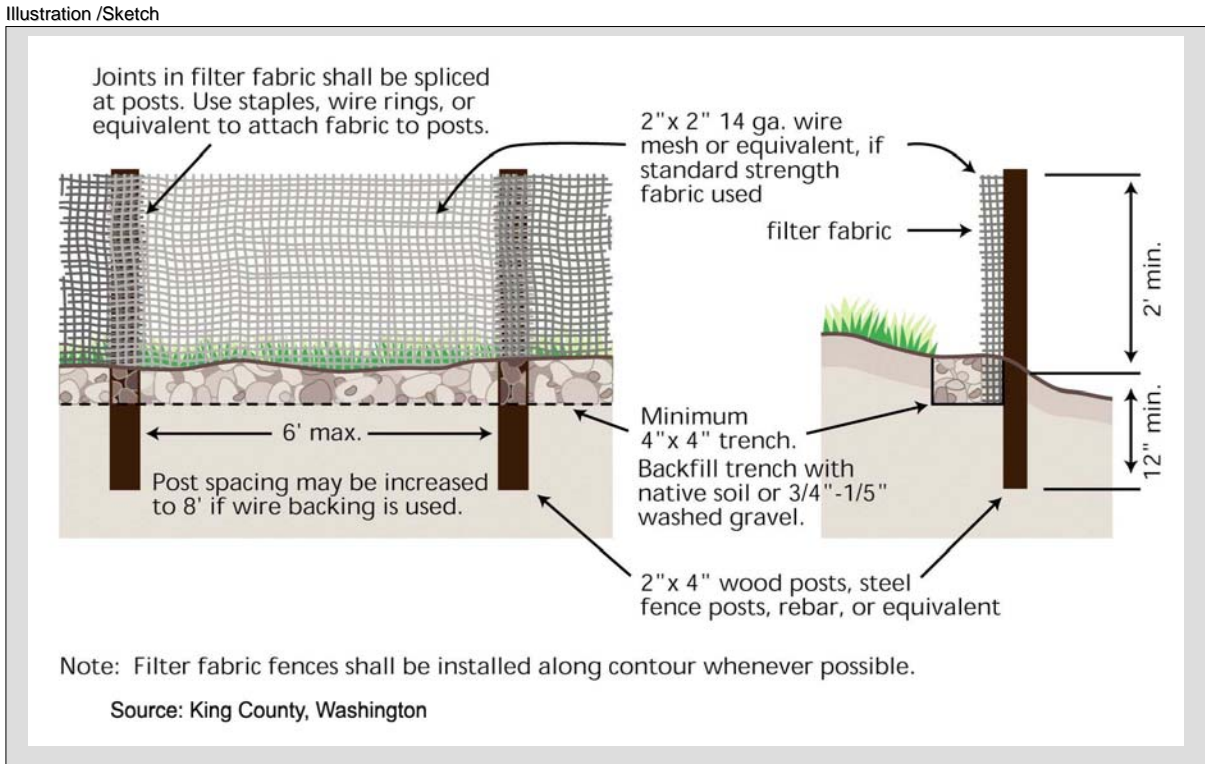

Group No	Group of measures
3.3	Control of erosion and sedimentation

Measure name	Synonym
Silt Fence and Trap Devices	Feststoff Filterzeune

**Maintenance**

These are temporary structures designed to be removed as soon as the site has been stabilized. However, during construction they must be inspected regularly for any damage that may have occurred and also to remove excess sediment that may be reducing the effectiveness of the structure. Sometimes stormwater will undercut a fence and flow unfiltered from the site. These problems must be corrected promptly. If straw bale barriers have been used, the straw may be recycled as mulch for new permanent plantings.

**Advantages**

When functioning properly, these devices can remove most of the sediment in runoff before it is discharged from the site. The filters can also slow and even divert some stormwater and reduce on-site erosion problems. Even if these measures are not required by law, developers will avoid nuisance law suits brought by neighbouring owners whose property has been damaged by sediment

**Disadvantages**

Silt fences can be unsightly, especially if they have been damaged in storms. Unless accumulated sediment is removed regularly the effectiveness of the installation will be compromised

**Examples**

Examples

**References and suggested reading**

WRPT sheet 2:6

**Example Photos**



Workers installing a silt fence. Source: In Stream Corridor Restoration: Principles, Processes, and Practices (10/98). By the Federal Integrity Stream Restoration Working Group (FISRWG)

Group No

3.4

Group of measures

### Control of erosion and sedimentation

Measure name

Sediment Basins

Synonym

Feststoff Absetzbecken

Purpose

A sediment basin is formed by a barrier across a drainage way, causing the impoundment of stormwater giving larger sediment (usually more than 10 microns) sufficient time to be precipitated. Once a site is stabilized, sediment basins may be removed or retrofitted for another use.

Applications

Sediment basins are effective in precipitating suspended sediment in runoff that has begun to accumulate in gulleys and drainage ways before it is allowed to leave construction sites. They are often used in combination with silt fences (Measure 3.3) which are most effective in controlling sediments in sheet runoff.

Description

Sediment basins are located on major swales and drainage ways at points just before they leave construction sites. They impound the concentrated runoff for sufficient time to allow sediment to settle out. The required settlement time will determine the size of basin necessary. The settling rate increases dramatically for smaller particles. WRPT sheet 2:7 shows that coarse sand (dia. 1000 microns) settles at a rate of 10 cm/sec, fine sand (dia. 60 microns) settles at 0.38 cm/sec and fine clay (dia. 0.1 micron) at 0.0000015 cm/sec. Sediment basins are normally fitted with trickle tube overflows that are perforated to allow the basin to empty completely at a rate calculated to meet the settlement time. Additional volume is allowed to give space for sediment accumulation.

Basins are usually constructed with earth dams, by excavation or by some combination. Care should be taken to minimize disturbance of natural drainage ways bearing in mind that the purpose of the measure is to protect downstream reaches of the stream from sediment damage. Although in theory sediment basins with a large surface area to depth ratio are most effective, disturbance of large areas will result. Practicality will normally dictate basins with depths of 2-3m.

Flocculants can be used to increase the settlement of smaller particles.

Illustration /Sketch

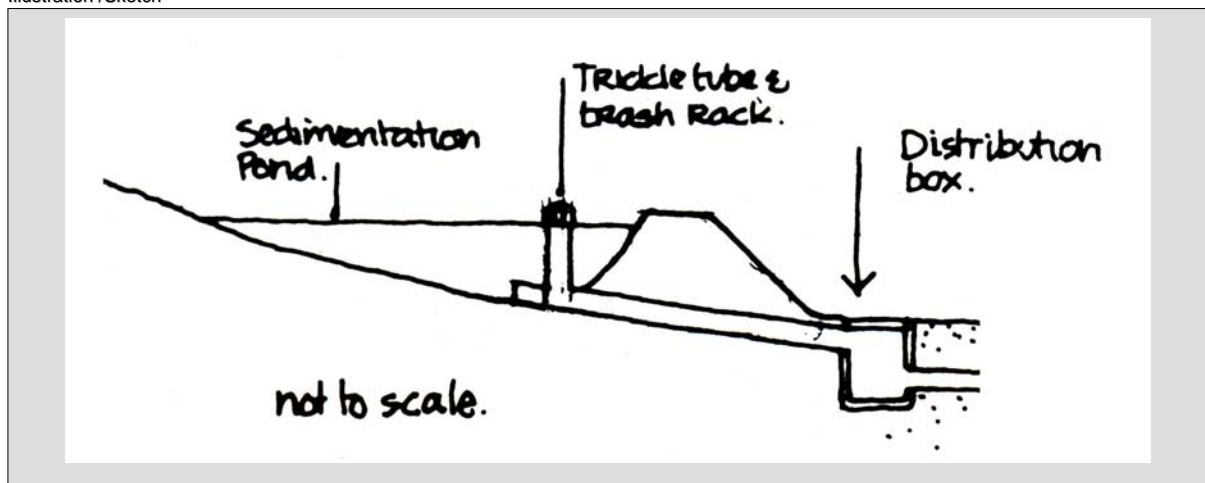

Group No

3.4

Group of measures

**Control of erosion and sedimentation**

Measure name

Sediment Basins

Synonym

Feststoff Absetzbecken

Maintenance

Sediment basins should be designed to allow some accumulation of sediment without loss of the desired effectiveness. Most sediment will be carried by a few large storms and following such storms ,basins should be inspected to make sure accumulations of sediments do not exceed the space allocated. If removal is required a backhoe with a wide bucket will usually be used.  
It may be necessary to fence the installation to prevent potential danger to trespassers.

Advantages

There has been considerable experiece using sediment basins.  
Sediment basins are very effective in removing larger sediments from concentrated flows of stormwater.  
Basins can often be sited in existing drainge ways with a small earth dam. If necessary capacity can be increased by excavation.

Disadvantages

Sediment basins usually require clean-out after large storms.  
Residual mud left in an empty basin is unsightly. Mud also smothers existing stream life in the basin.  
Sediment basins are rarely adaptable for use after construction is complete, although they are sometimes retrofitted for runoff detention.

Examples

Examples

Example Photos

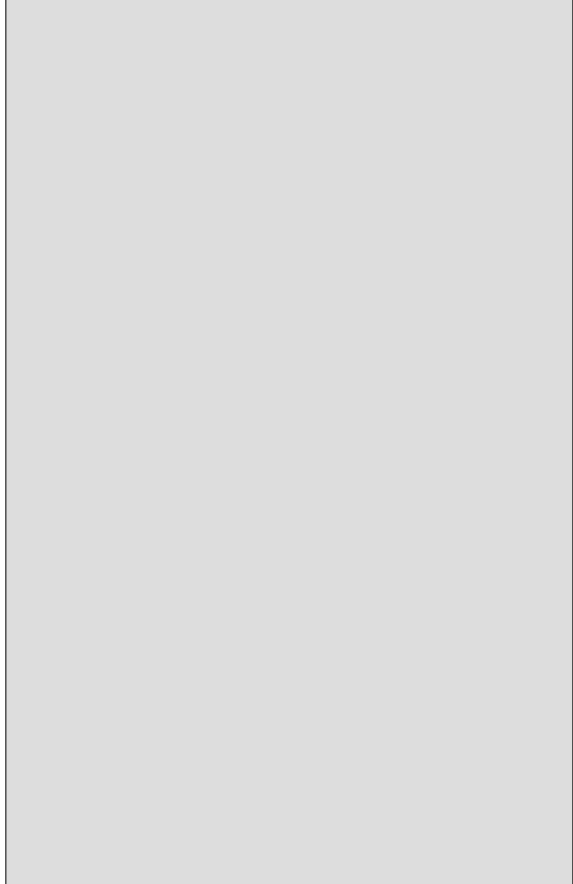

References and suggested reading

WRPT Sheet 2:11

Group No

3.5

Group of measures

### Control of erosion and sedimentation

Measure name

Hydroseeding and Chemical Stabilization

Synonym

Hydroansaat, Chemische Stabilisatoren

Purpose

Hydroseeders use a pressure spray to apply a slurry of seed, water, fertilizer, soil conditioner and mulch in one process. Rough and steep areas that are difficult to access with farm machinery may be seeded and fertilized economically. Chemical binders may be added to the slurry to help keep the seed and mulch in place during germination and to reduce water loss and erosion.

Applications

Hydroseeding is becoming increasingly common as the service becomes more available at reasonable cost. The use of standard farm machinery to prepare the soil and drill seed is generally more economical but cannot be used on steep sites. The most common application of hydroseeding is on steep highway cuts and embankments which are within easy reach of spray equipment located on the shoulder of the highway.

Description

Hydroseeding equipment consists of a high pressure spray unit and a large tank in which the slurry is mixed. If chopped straw is to be used as a mulch, a chopper accompanies the unit. The tank features an agitation system to keep the slurry mix in suspension. The slurry normally contains a green dye to assist the operator get an even application. Most commercial spraying equipment has a range of more than 60m. and a hectare can be seeded in about 20 minutes.

Some operators recommend that if straw or other organic mulch is to be used it is applied in a second application. Otherwise the mulch reduces the contact of the seed with the soil and germination is poor. In WRPT (sheet 2:11), three types of chemical binders are identified. 1. Soil Binders that are used in lieu of mulches when mulches are not readily available. The binder penetrates the soil to about 1 cm. stabilizing the seed bed and also helping to retain soil moisture. However they are permeable enough to allow rainwater to reach the soil. 2. Soil Binders used in combination with seed and wood fibre mulch. More of the binding agent is required than when it is used without mulch. 3. Chemical stabilizers with surface action. Asphalt emulsions fall into this category but they are difficult to apply and rarely used.

Illustration /Sketch

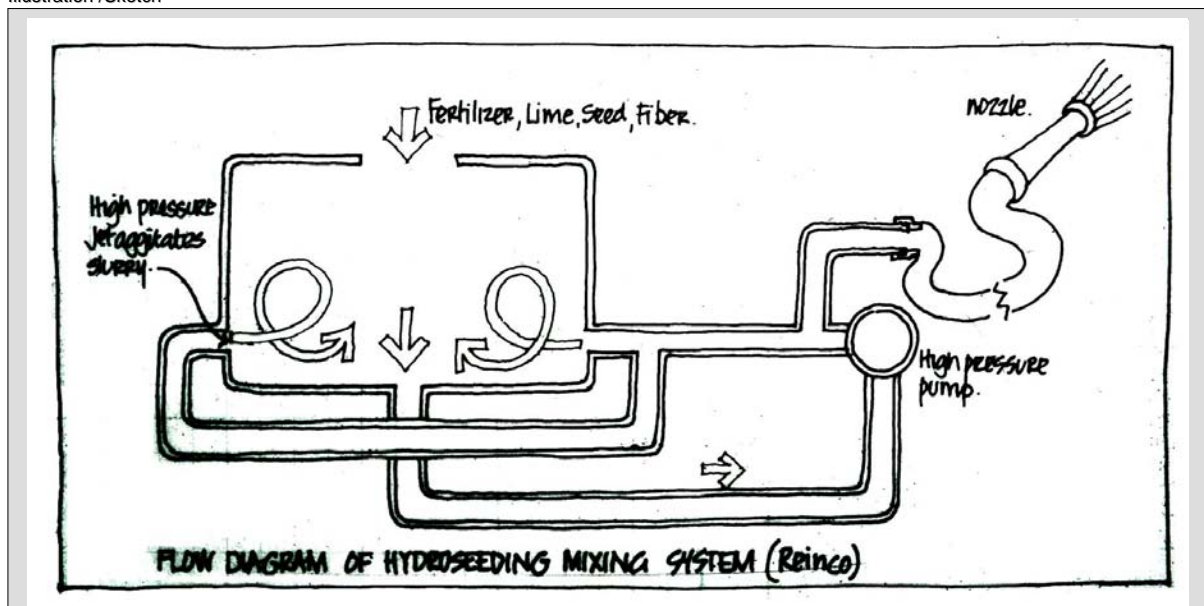



Group No

3.5

Group of measures

**Control of erosion and sedimentation**

Measure name

Hydroseeding and Chemical Stabilization

Synonym

Hydroansaat, Chemische Stabilisatoren

Maintenance

No maintenance is required but reapplication may be necessary if seeding fails. Even if hydroseeding is used, correct timing and careful choice of species is essential to ensure successful germination and growth

Advantages

Hydroseeding can be used on sites inaccessible for standard farm equipment  
The use of mulch and chemical binders in the slurry increases germination rates on all sites.  
The application of seed, mulch, fertilizer, soil conditioners and binders all in one slurry makes this an efficient and fast process which will often easily justify additional cost.

Disadvantages

Hydroseeding can be expensive especially for jobs carried out in small increments.  
Although spray equipment has a long reach, the tanker must have access to within about 60 m of the farthest point to be seeded.  
Hydroseeding is usually subcontracted which may make scheduling difficult.

Examples



Example Photos



Hydroseeding of a streambank. Source: In Stream Corridor Restoration: Principals, Processes, and Practices (10/98). By the Federal Integrcy Stream Restoration Working Group (FISRWG)

References and suggested reading

Wrpt sheet 2 :11  
Tourbier, J. Toby;  
Westmacott, Richard:  
Water Resources  
Protection Technology.  
A Handbook of  
Measures to Protect  
Water Resources in  
Land Development.  
ULI- The Urban Land  
Institute; Washington,  
D.C. 1981.



Group No

Group of measures

3.6

### Control of erosion and sedimentation

Measure name

Management of Construction Sites and Traffic

Synonym

Bauverkehr

Purpose

Construction activities are one of the most serious sources of soil erosion and sediment pollution. Construction sites should be managed to minimize the period during which the site is disturbed, to minimize the area that is disturbed, and to layout construction roads and yards to minimize erosion. Muddy conditions result in delays and a poor working environment. Soil damage and excessive compaction during construction can seriously reduce the survival and growth of new and existing vegetation.

Applications

Applicable to all construction sites, especially in dense developments where the compaction due to construction traffic should be confined to areas planned for future roadbeds and parking areas. Access to areas close to existing trees and areas designated for future planting should be off-limits for construction traffic.

Description

The following actions should be taken on all construction sites:  
 Minimize the areas to be disturbed and schedule work to minimize the period of construction. If possible, schedule construction activities during the dry season. Protect all trees and shrubs to be saved with geogrid fencing placed outside the drip line. Avoid excessive compaction around existing trees or of areas designated for future planting. Confine construction traffic whenever possible to areas planned for future roads, parking or buildings. Where possible, grade and lay a geotextile blanket and crushed stone subgrade on all areas designated for future roads and parking. Divert as much runoff as possible around the site. This will avoid polluting the runoff and reduce muddy conditions and dewatering operations on site. Divert runoff generated on site away from heavily used areas. Erect a silt fence around the downslope boundary of the site to intercept any sediment polluted runoff before it leaves the site (Measure 3.3). Sediment basins should be placed on all major drainage ways at or near the points they leave the site (Measure 3.4). Seed a cover crop on all disturbed areas that are to remain open for long periods during the growing season. Mulch these areas if seasonal constraints prevent seeding (Measure 3.1). Seed a cover crop or mulch all temporary stockpiles of topsoil or subsoil (Measure 3.1).

Illustration /Sketch

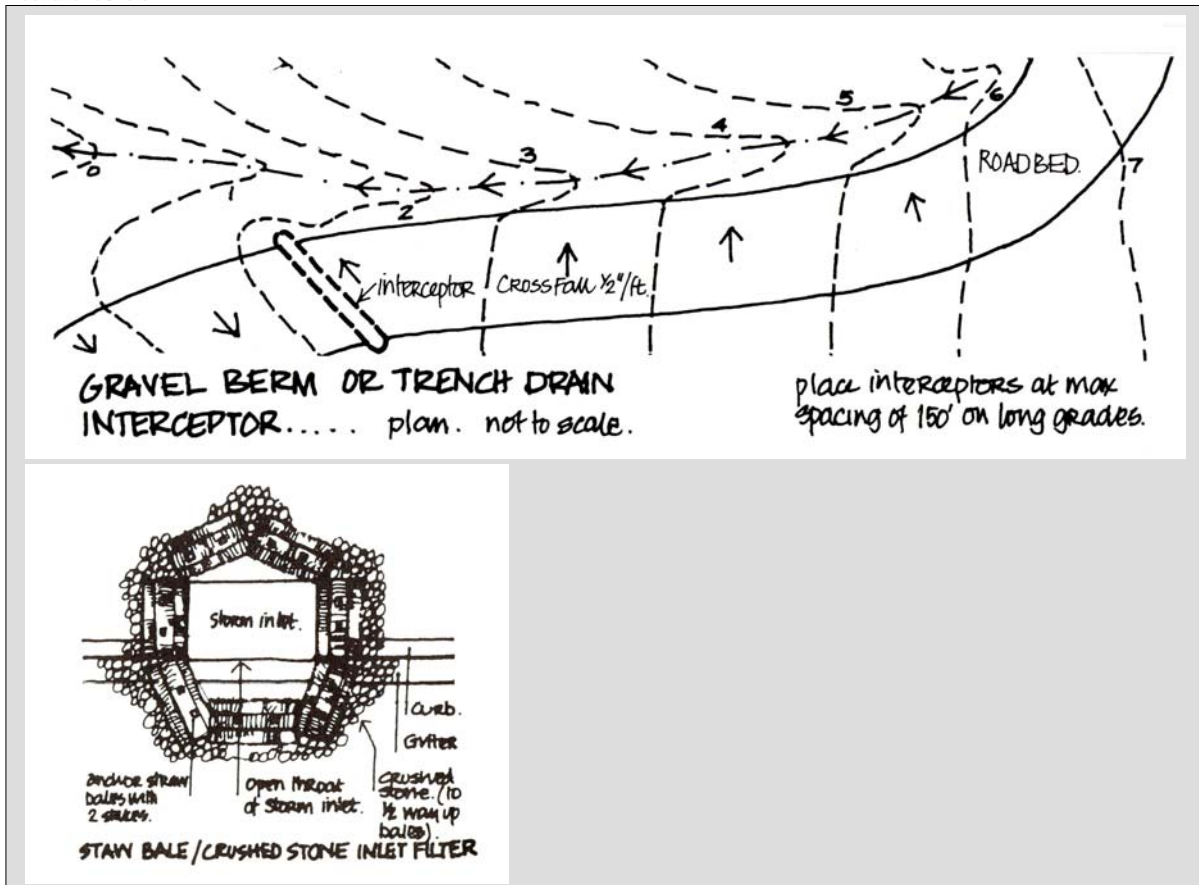

Group No

3.6

Group of measures

**Control of erosion and sedimentation**

Measure name

Management of Construction Sites and Traffic

Synonym

Bauverkehr

Maintenance

Regular inspections of the site should be carried out to identify any areas where problems are occurring or where improvements could be made.

After all large storms, any damage should be identified and repaired, excessive sediment accumulations should be removed. If there are any areas of standing water, the drainage system needs modification to ensure that the areas drain properly in future.

Advantages

A well managed construction site, not only will have the benefit of better working conditions and fewer delays but environmental problems will be minimized.

Erosion and sedimentation are reduced and muddy conditions minimized.

Complaints and possible legal action from neighboring landowners are avoided.

When construction is finished, the growth of new vegetation is more vigorous and healthy.

Disadvantages

If sites are very confined, it may be difficult to keep contractors off sensitive areas.

Examples

Examples

Example Photos

Photos

References and suggested reading

Group No

Group of measures

4.1

### Maintaining groundwater recharge

Measure name

Vegetated infiltration Swales with Check Dams

Synonym

Infiltrationsrinnen

Purpose

A constructed open-channel drainage way used to convey stormwater at non-erosive velocities to a designed discharge point. When check dams are placed across them, they are transformed into infiltration and pollutant-removal devices.

Applications

Vegetated swales with check dams are an inexpensive alternative to conventional curb and gutter and below ground stormsewer systems. Roadside swales are less feasible where driveway entrances requiring culverts are frequent. Since swales are on the surface, they have to follow natural drainage patterns. Vegetated swales with check dams are most effective in watersheds of up to 5 acres (Schueler, 1987). Swales are typically part of a larger stormwater management system, and alone cannot capture and infiltrate all the runoff from design storms. Groundwater should be more than two feet below the swale surface. Swales should not be used if peak discharge exceeds 5 cubic feet per second or if runoff velocities exceed 1.5 feet per second (EPA, 1993).

Description

A vegetated swale is a wide and shallow plant-lined trench used to convey stormwater at non-erosive velocities to a designed discharge point. As a stormwater management device, swales act to slow runoff, and reducing peak discharge rates. The flow velocity of swales are reduced and they made to act as infiltration and pollutant removal devices through check dams placed across them. They create a series of triangular shaped ponds, where detained water infiltrates into the soil. The performance of vegetative swales with check dams is as follows: (1) Suspended sediment removal: 20-40%, (2) total phosphorus removal: 20-40%, (3) total nitrogen removal: 20-40%, (4) oxygen demand removal: 20-40%, and (5) trace metals removal: 0-20% (Schueler, 1987). The swale should be graded close to level in the direction of flow. Side slopes on either side of the swale should have a ratio no greater than 3:1 (horizontal to vertical). Prior to seeding, swales should be tilled to restore infiltration capacity lost by compaction during construction. Swales along front yards should be planted with a water tolerant, erosion resistant grass. Check dams should be designed so that the runoff retained behind them infiltrates in 24 hours after a storm. Swales are ineffective if the gradient is greater than 5 percent due to the small pool behind check dams.

Illustration /Sketch

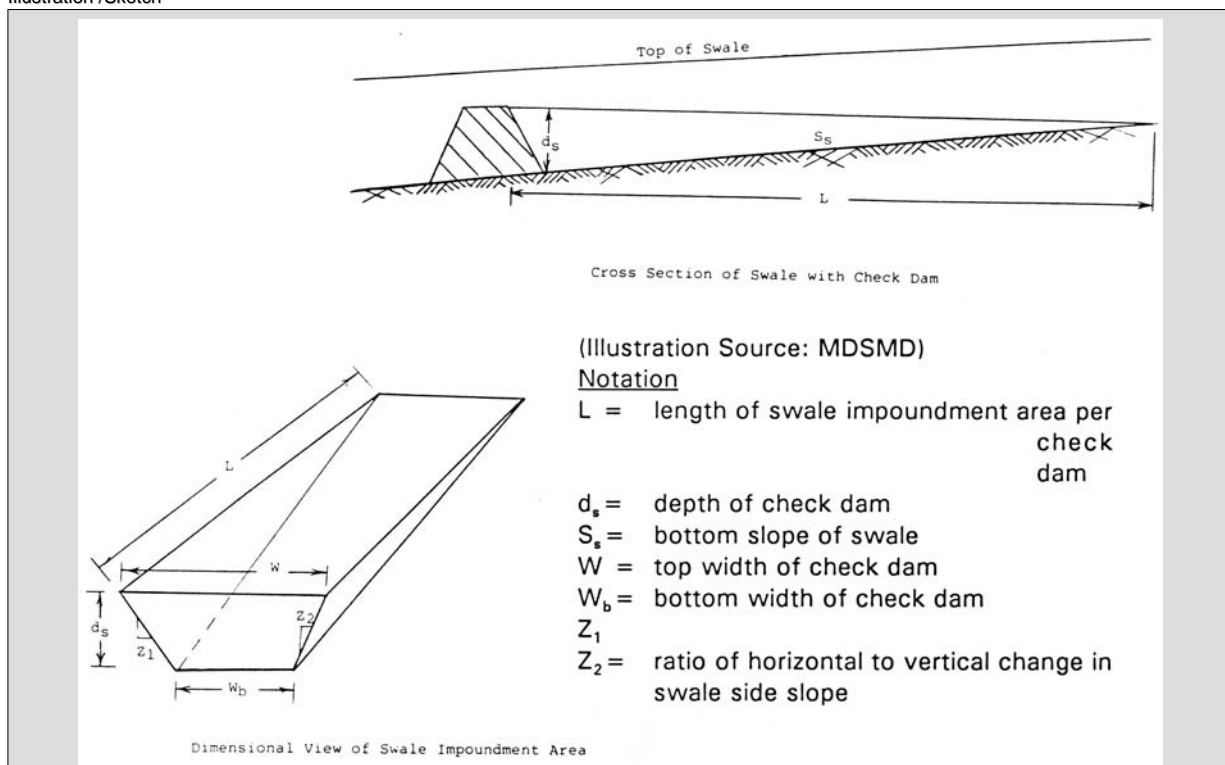

Group No

4.1

Group of measures

**Maintaining groundwater recharge**

Measure name

Vegetated infiltration Swales with Check Dams

Synonym

Infiltrationsrinnen

Maintenance

Maintenance is mainly concerned with keeping grassed cover dense and vigorous. This involves periodic (but not frequent) mowing and spot reseeding to maintain a vegetated stand that slows runoff and filters stormwater.

Accumulated debris should be removed after large storms. Where swales cross residential lots, homeowners can be made responsible for mowing and debris removal.

Sediments accumulated behind check dams and at the edges to contributing areas must be removed.

Advantages

Vegetated infiltration swales with check dams are less expensive to install than conventional curb and gutter construction. They must be used in conjunction with other stormwater detention, infiltration, and pollution reduction components. Shallow side slopes allow mechanical mowing, but require space . Vegetated swales require more maintenance than curb and gutter systems.

Disadvantages

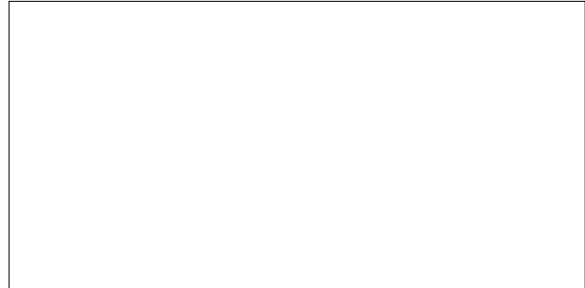

Examples

Bundestgartenschau (BUGA) Gelsenkirchen, Germany.  
Photo: Tourbier, J.T.

References and suggested reading

Tourbier & Walmsley, Inc.: London Grove Township Stormwater Management Guidance Manual. London Grove Township Board of Supervisors, Philadelphia 1996; Tourbier, J.T.: Blue-Green Technologies. Integrated Practices to Manage Stormwater as an Asset. Great Swamp Watershed Ass.; Madison, N.J. 2002;

Example Photos



Group No

Group of measures

4.2

### Maintaining groundwater recharge

Measure name

Infiltration Basins

Synonym

Sickerbecken

Purpose

A water impoundment made by excavation or construction of an embankment to intercept runoff and to maintain or increase natural groundwater recharge by infiltration through the bed and sides of a pond or basin. It is sized to hold and infiltrate the runoff from a design storm (e.g. a two year frequency storm).

Applications

Infiltration basins are most effectively used in watersheds of 5-20 acres. The infiltration rate of soils under infiltration basins should be 0.52 inches per hour or greater. The seasonal high water table and bedrock should be at least 2 to 4 feet from the bottom of the basin. Infiltration basins should not be used in limestone and other karst-sensitive areas where sinkhole formation is common due to high potential for groundwater contamination. Infiltration areas should be set back at least 100 feet from any water-supply well, as well as at least 10 feet down gradient from any

Description

An infiltration basin infiltrates the runoff from a design storm. Infiltration basins reduce peak storm flows, remove particulate and soluble pollutants, and recharge groundwater and aquifers. Their trap efficiency is as follows: (1) suspended solid removal: 80-100%, (2) total phosphorus removal: 40-60%, (3) nitrogen removal 40-60%, (4) oxygen demand removal 60-80%, (5) trace metals removal 80-100%, (6) bacteria removal 60-80%.

Infiltration basins can be "on line" or "off line". On line basins accept the entire storm flow and discharge excess through risers and spillways. With off line basins, a diverter in the storm channel directs the first flush of stormwater into the basin. When the basin is full, stormwater that can no longer enter remains in the conveyance channel and is bypassing the basin.

Infiltration basins store runoff and infiltrate it over a maximum of 3 days. A 24 hour infiltration period is preferred. When earthen banks are used sides should have a horizontal to vertical ratio of up to 3:1 and the bottom is flat. Both, the sides and the bottom should be planted with a thick stand of water tolerant grass. The turf promotes infiltration, traps particulates, and protects the basin from erosion.

Grease, oil, floatable organic material and sediments should be removed from stormwater in devices such as oil/grit separators, sediment traps, forebays, and vegetative filter strips, before release to infiltration basins.

Illustration /Sketch

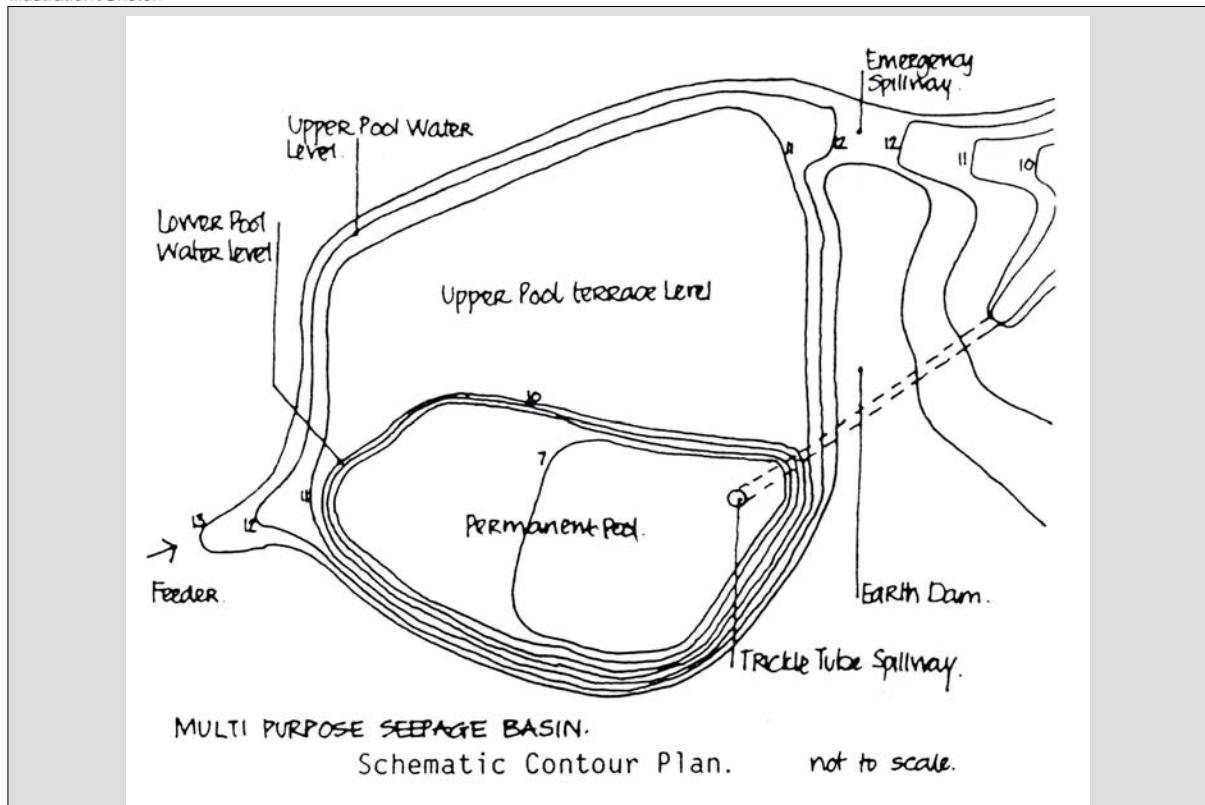

Group No

4.2

Group of measures

**Maintaining groundwater recharge**

Measure name

Infiltration Basins

Synonym

Sickerbecken

Maintenance

Infiltration basins should be inspected at least once a year and after every heavy storm. Eroded areas should be replanted and the source of the problem corrected. Sediments should be removed from basin floors that are clogged. The basin should then be plowed, disked, organic material worked in, and replanted to restore percolation rates.

Advantages

Infiltration basins preserve the natural water table of a site and can provide complete control of peak flows from the design storm. They also provide total trapping of design storm particulates and partial removal of nutrients. If they are not properly maintained, they can clog, breed mosquitoes, and become an eyesore.

Disadvantages



Examples

Examples



Example Photos

Photos

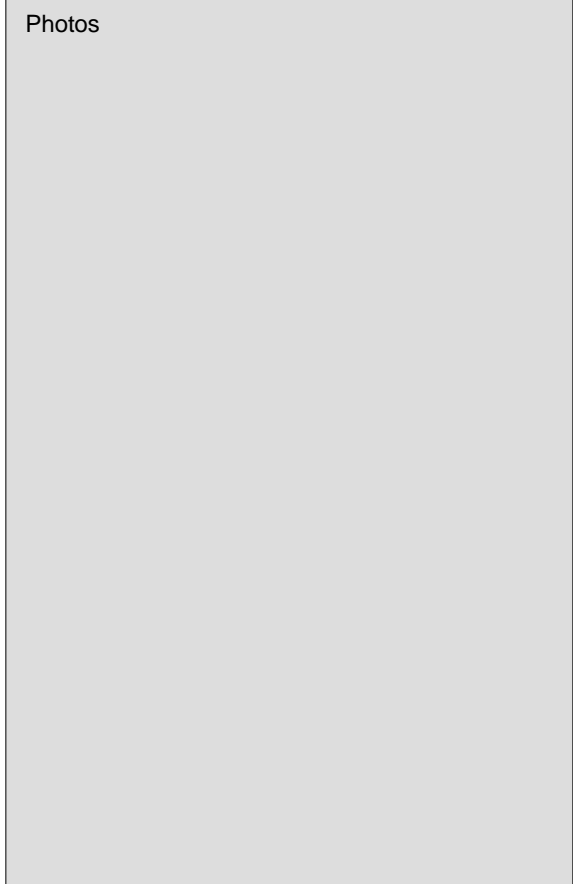

References and suggested reading

Tourbier & Walmsley, Inc.: London Grove Township Stormwater Management Guidance Manual. London Grove Township Board of Supervisors, Philadelphia 1996;

Group No

Group of measures

4.3

### Maintaining groundwater recharge

Measure name

Seepage Beds

Synonym

Sickerflächen

Purpose

Seepage beds are extensive multi use areas that are excavated to a shallow depth and filled with crushed stone. Their purpose is to cause the infiltration of stormwater which has been collected from elsewhere on site. The areas may be surfaced with porous paving, mowed grass or meadow depending on the intended use.

Applications

Applicable on well or moderately well drained sites where the bedrock and the watertable (in all seasons) is at least 5 ft. below ground level. If the soil in the catchment area is moderately or highly erodible, additional precautions should be taken to trap sediments before distribution into these areas. Alternative uses may not be feasible for brief periods following a storm event due to standing water, and this limitation may make some areas unsuitable.

Description

Seepage beds rely on the surface distribution of sediment-free stormwater at shallow depths over large porous areas. It is important that infiltration is sufficiently rapid that no standing water remains on the site for more than 4 hours following a storm. Grass areas must be well enough drained to allow full use within 24 hours following a storm. A deep crushed stone base is required for sufficient underdrainage to insure that the surface dries rapidly following a flood. To speed this process further, the area may be under drained with perforated plastic pipe to remove excess water. The area should be designed and graded so that the depth of water never exceeds 12 inches to avoid any safety hazard. When the area is used for overflow or temporary parking of automobiles, stormwater should not be impounded deeper than 6 in. It is essential for the long term effectiveness of this measure that inflow water is as sediment free as possible. To achieve this, measures to precipitate sediment before stormwater is passed onto the seepage bed should be installed in all supply channels. During large storms when the capacity of the sediment removal measures is exceeded, stormwater should be bypassed around the seepage bed.

Illustration /Sketch

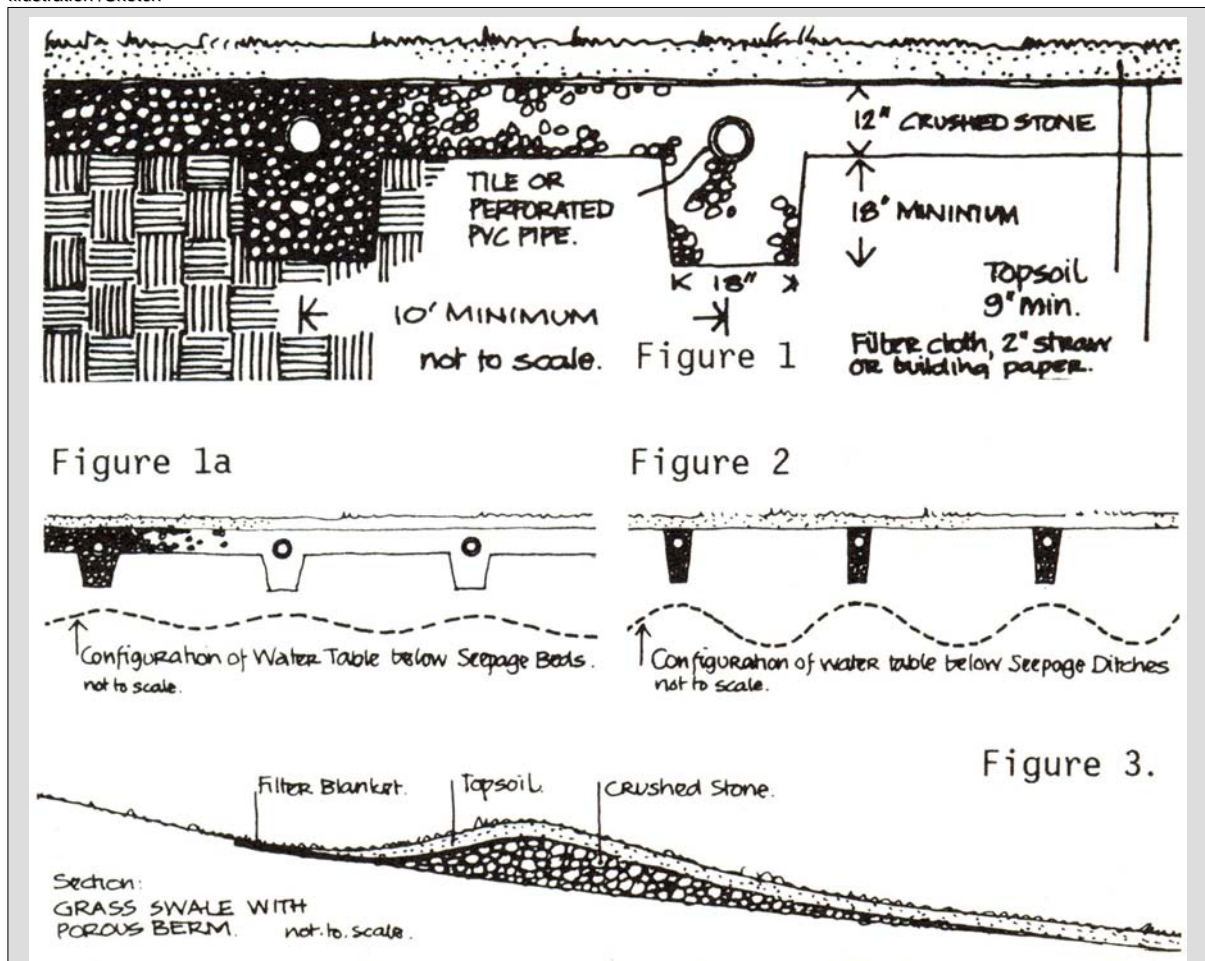



Group No

4.3

Group of measures

**Maintaining groundwater recharge**

Measure name

Seepage Beds

Synonym

Sickerflächen

Maintenance

Maintaining the infiltration capacity of the seepage bed is the essential of a maintenance program. The most likely problem will be clogging caused by sediment in the inflow water. This problem should be minimized by installing sediment control measures upstream of the seepage bed and insuring their regular cleanout. The infiltration capacity of porous pavement must be maintained by regular vacuum sweeping. Reduced infiltration of vegetated areas may be caused by sediment and also by compaction. In both cases infiltration capacity can be restored by cultivation and reseeding.

Advantages

Infiltration of stormwater by seepage beds will help to protect groundwater yields, base flow in streams and the hydrologic balance, but at the same time allow for other uses of the site. Seepage beds have a high surface area to volume ratio, but the disadvantage of the large surface needed is offset by the advantage of multi use.

Disadvantages

Multi-use may result in loss of performance of seepage beds. Heavy use, particularly during wet weather, can cause excessive compaction. Even if care is taken to remove sediments from inflow water, some sediment can be generated from worn areas on the site itself. The management of alternative uses involving timing, intensity and zoning may be complex.

Examples

Examples

Example Photos

Photos

References and suggested reading

Tourbier, J. Toby; Westmacott, Richard: Water Resources Protection Technology. A Handbook of Measures to Protect Water Resources in Land Development. ULI- The Urban Land Institute; Washington, D.C. 1981.

Group No

Group of measures

4.4

### Maintaining groundwater recharge

Measure name

Gravel Filled Trenches

Synonym

Rigolen

Purpose

Gravel filled trenches (with optional underdrainage) are infiltration and pollutant removal devices installed close to runoff-generating surfaces. They also reduce peak flows although this is not their primary purpose. Trenches remove both soluble and particulate pollutants through interaction with soil.

Applications

Gravel filled trenches can be used in a variety of urban and suburban situations to receive runoff generated by parking lots, median strips, swales, and rooftops. Soil should be well drained, have a favourable cation-exchange rate, and an infiltration rate of 0.5 inches per hour or greater. The water table and bedrock should be at least 2 to 4 feet below the bottom of the trench during all seasons. Their low surface area to volume ratio makes trenches useful in areas where space is limited.

Description

Stormwater entering trenches is stored within the void volume of the gravel and moves gradually into the subsoil. Trenches are typically 3 to 8 feet deep and designed to drain within three days. The infiltration rate of the soil, depth to bedrock, and the level of the water table will determine the trench depth. The sides of trenches are lined with filter fabric and when the trench is filled, 6" of sand is first placed on the bottom. Gravel or crushed stone should be 1.5 to 3 inches in size. If there is a vegetated surface over the trench, gravel should be covered with filter fabric before placing the topsoil. Metal gratings or a perforated concrete slabs may also be used above the gravel to pass overland flow into the trench. These should be set with a 6 inch void beneath and filter fabric on top of the gravel. In sloping terrain trenches at various levels may be connected by distribution pipes with overflow valves. To avoid clogging with sediments, trenches should not be installed until all contributing areas have been stabilized. Simple monitoring wells, consisting of vertical perforated plastic pipes, should be installed in each gravel filled trench to check infiltration rates after storms and to observe how fast sediments accumulate. Runoff quality improvement is considerable: (1) suspended sediment removal: 80-100%, (2) total phosphorus removal 40-60%, (3) total nitrogen removal 40-60%, (4) oxygen removal 60-80%, (5) trace metal removal 80-100%. and (6) bacterial removal 60-80%.

Illustration /Sketch

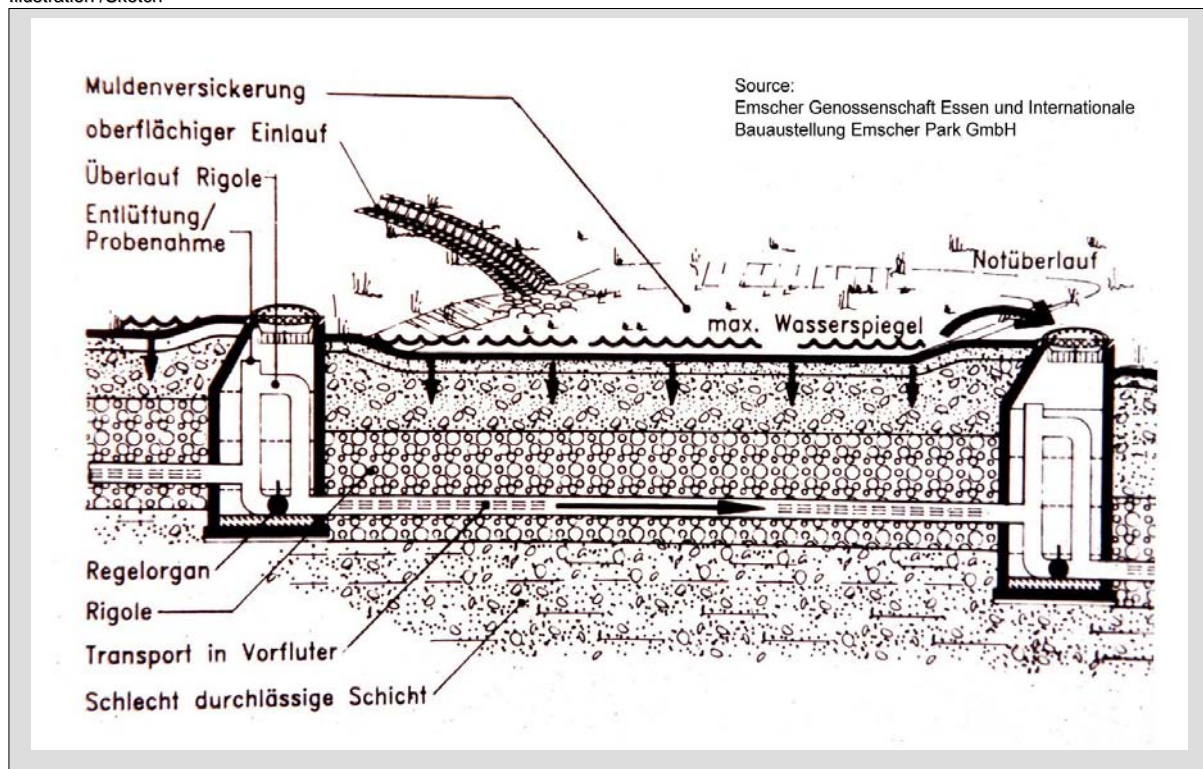

Group No

4.4

Group of measures

**Maintaining groundwater recharge**

Measure name

Gravel Filled Trenches

Synonym

Rigolen

Maintenance

Monitoring wells should be examined quarterly and following every large storm. When sediment accumulation causes the draining time to exceed three days, the trench should be dug up and remade. When the inflow is through a grating and there is accumulation of sediment on the filter fabric, the fabric should be lifted and replaced.

Advantages

Gravel filled trenches provide good to excellent pollutant removal for small drainage areas or infill developments. They make efficient use of limited space through their low surface area to volume ratio.

Disadvantages

Gravel filled trenches require regular maintenance to prevent premature clogging. Digging up and replacing a badly performing trench can be disruptive and expensive.

Examples

Examples

Example Photos

Photos

References and suggested reading

Tourbier & Walmsley, Inc.: London Grove Township Stormwater Management Guidance Manual. London Grove Township Board of Supervisors, Philadelphia 1996;

Group No

Group of measures

4.5

### Maintaining groundwater recharge

Measure name

Wells and Gravity Shafts

Synonym

Sickerschächte

Purpose

Recharge wells or seepage pits are used to infiltrate stormwater from adjacent impermeable areas when the water table is more than 5m (for wells) or 3m (for pits) below the surface in all seasons. Unlike seepage beds which have a large surface/depth ratio, recharge wells have a very small area/depth ratio. Seepage pits have a larger area/depth ratio than wells but much smaller than beds. Wells and pits can also be used where poorly drained soils or strata overlay porous substrata. By penetrating the impermeable strata, recharge of the groundwater is made possible. This measure does not include pressure injection recharge wells.

Applications

Recharge wells require very little surface area although they can handle large volumes of water. However the recharge water must be sediment free otherwise the performance of the well will drop. Recharge water must also be unpolluted or groundwater contamination will occur. Recharge wells are clearly unsuitable for areas with a shallow bedrock or water table.

Description

Recharge wells can be as small as 15 cm in diameter but will often have a diameter of 1m. The term gravity shaft is sometimes used for larger diameter wells. Wells may extend to the watertable or terminate above it. They may be lined with pre-cast concrete sections or perforated pipe. Well must be protected from clogging by sediment either by fitting inlets with a filter or by using a sediment basin.

Wells are sometimes backfilled with granular material in a sleeve of filter fabric. If backfilled and if wells receive direct overland flow, they will usually have a cone of porous material covering their mouths to protect them from sediment in the stormwater. Periodic replacement of the cone of granular material may be required to restore recharge rates of backfilled wells. Typical recharge rates vary enormously, but are normally at least 250 litres/min. (Higher rates can be achieved using pressure injection)

A series of simple low-tech pits can be installed using a tractor mounted post hole auger (dia 40 cm) to bore holes upto 2m deep. The soil is removed, a 5m square of filter fabric placed over the hole and the hole backfilled with crushed stone, wrapping the excess fabric over the top of the stone.

The performance of most measures to recharge groundwater will be higher if water is pumped from the aquifer close to the recharge point, causing a cone of depression in the watertable at that point and a negative hydraulic pressure (Induced Infiltration). However this poses a threat of polluting the groundwater. The measure is frequently used along river valleys. By pumping the groundwater, recharge through the river bed increases. Filtering through the riverbed significantly increases the quality of the river water before it reaches the aquifer. However, in the case of wells injecting stormwater directly into the aquifer this quality improvement does not occur.

Illustration /Sketch

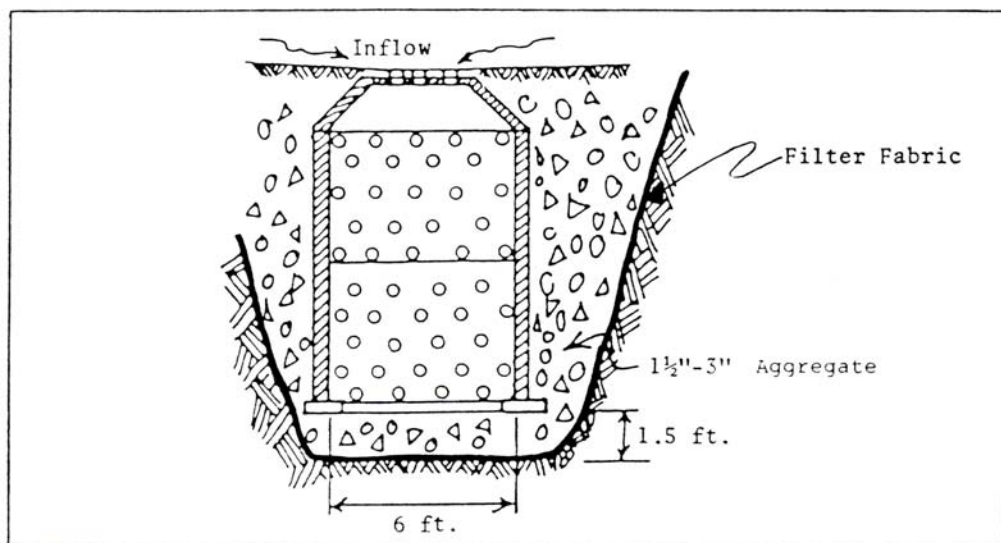

(a)

Source: Modified from Sullivan (1981)

Group No

4.5

Group of measures

**Maintaining groundwater recharge**

Measure name

Wells and Gravity Shafts

Synonym

Sickerschächte

Maintenance

Clogging is generally the worst problem affecting the performance of recharge wells. The only effective means of perpetuating the life of a well is to remove silt by filtration before the stormwater enters the well. However filters will only remove sediments 25 microns or larger (WRPT sheet 2:7). Filters can be cleaned by reverse flushing or can be replaced.

A sediment basin with the necessary storage volume to allow sufficient time for sediments to settle can be used. But the required size is very large to remove smaller sediments (measure 3.4). In the case of backfilled wells, the cone of porous material protecting its mouth is intended to filter sediments from the stormwater.

Advantages

Recharge wells require less space than any other recharge measure.

When water quality is good, induced infiltration can be used.

Disadvantages

Because of relatively high cost of wells and their susceptibility to clogging by sediments, the water used for recharge must be sediment free. This requires various upstream measures and filtration. Shallow backfilled wells can be protected by a filter cone, but backfilling reduces their storage capacity.

When wells become clogged there is no practical alternative than re-drilling a new well close by.

Examples

Examples

Example Photos

Photos

References and suggested reading

WRPT measure 1;12.  
 Tourbier, J. Toby; Westmacott, Richard: Water Resources Protection Technology. A Handbook of Measures to Protect Water Resources in Land Development. ULI- The Urban Land Institute; Washington, D.C. 1981.

Group No

Group of measures

4.6

### Maintaining groundwater recharge

Measure name

Infiltration Berms

Synonym

Sicker Berme

Purpose

Infiltration terraces are constructed across a slope with a berm along the downslope edge to impound runoff on the terrace. This allows the runoff to infiltrate. They vary in width and spacing. They are usually sized to hold and infiltrate the runoff from a two year design storm. Similar to depression storage found in nature, infiltration berms can be designed to blend harmoniously into the landscape.

Applications

Infiltration terraces are well suited for rolling topography with long slopes and permeable soils. This measure was traditionally used in agriculture, but can be applied to urban development sites if the terraces are planned as part of the open space network. They can be very compatible in developments where vehicular access and structures are designed to run parallel to the contours.

Description

Infiltration berms are shallow embankments designed to impound water on terraces constructed parallel to the contours on a sloping site. The terrace and the berm are built level to intercept surface flow. The width of terraces may vary depending on the steepness of slope. Side slopes of berms should not be steeper than 3:1 and the crests of berms should be level with a minimum width of 5 feet. Topsoil should be stripped from terrace areas before they are graded. During grading, great care should be taken to avoid the compaction of the base of the terrace. The berm however may be compacted. Sod may be used to protect the top and the downslope of the berm. Otherwise topsoil should be spread over the terrace and berm, harrowed and seeded. Where possible berms should not be constructed on areas of fill, but when this is not possible the whole area and the berms must be thoroughly compacted.

Terraces may be kept in woody vegetation, herbaceous vegetation or in grass, but berms are best kept in grass, mowed regularly. Woody vegetation on the terraces will help to keep the soil structure open and thus provide a self sustaining infiltration system that requires little long-term maintenance.

To enhance infiltration, one or more infiltration trenches (see Measure 4.4) filled with crushed stone wrapped in filter fabric may be constructed running along the length of each terrace. Infiltration trenches may contain (optional) a 10cm perforated pipe to improve subgrade distribution of water.

All terrace systems must be designed with an emergency spillway capable of handling stormwater flows in excess of the design storm.

The crest of the berm is a ideal location for pathways but access to the base of terrace should be discouraged as the resulting compaction will decrease infiltration.

Illustration /Sketch

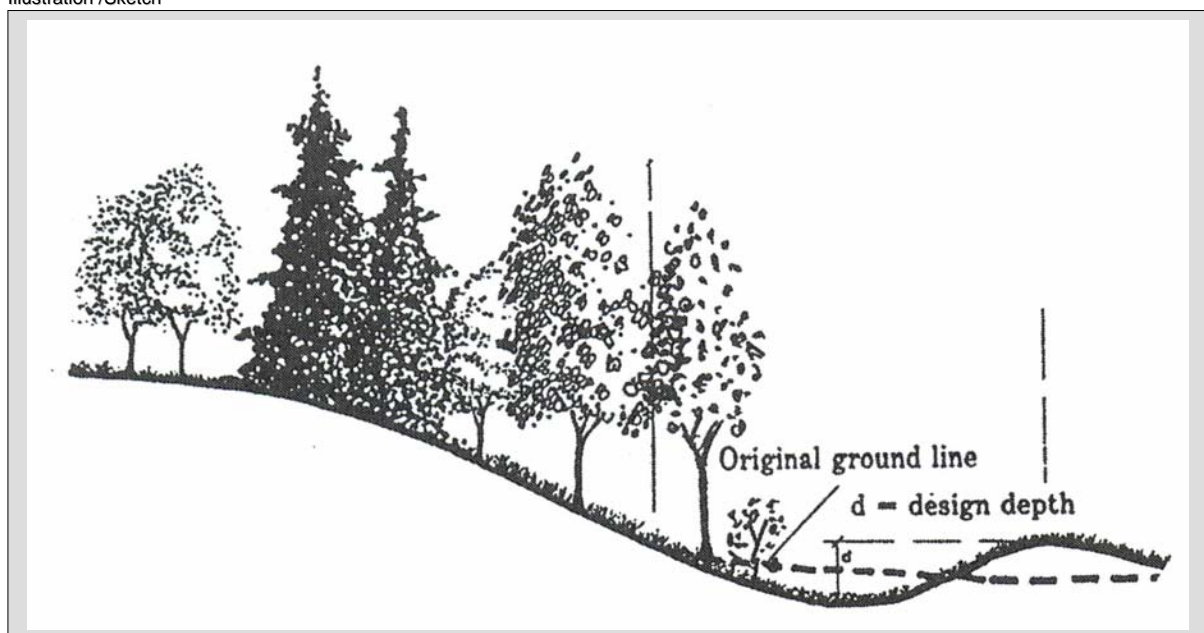

Group No

4.6

Group of measures

**Maintaining groundwater recharge**

Measure name

Infiltration Berms

Synonym

Sicker Berme

Maintenance

All silt that accumulates on the terraces during and after construction should be removed. The berms should be mowed regularly and should be inspected after storms. Any erosion gullies should be repaired immediately. If the rate of infiltration of the terraces falls below the required rate, they can be retrofitted with infiltration trenches running along the terrace. However if woody vegetation is established on the terrace a series of infiltration pits installed with a post hole auger (measure 4.5) should be used. These will cause much less disturbance than the installation of an infiltration trench.

Advantages

Infiltration terraces can effectively infiltrate runoff from a two year storm which will maintain pre-development infiltration rates and the natural baseflow of streams.  
This measure will blend well in the landscape if planned in advance.  
This measure is simple and requires very little maintenance.

Disadvantages

Infiltration terraces require careful grading to be effective and their location is determined by the contours on site. A development therefore must be planned around the terraces which may impose constraints that are not acceptable. It may be difficult or impossible to incorporate the long linear horizontal open spaces that result in the design of a development.  
In very dense developments, terraces may become severely compacted with a resulting loss of effectiveness.

Examples

Examples

Example Photos

Photos

References and suggested reading

Tourbier & Walmsley, Inc.: London Grove Township Stormwater Management Guidance Manual. London Grove Township Board of Supervisors, Philadelphia 1996; Tourbier, J. Toby: Blue-Green Technologies. Integrated Practices to Manage Stormwater as an Asset. Great Swamp Watershed Ass. Madison, N.J. 2002.

Group No

Group of measures

5.1

### Detaining peak flows

Measure name

Wet Pond Detention Basins

Synonym

Ruckhaltebecken mit permanentem Einstau

Purpose

The purpose of wet pond detention basins is to provide sufficient flood storage capacity to reduce peak stormwater flows but also to maintain a permanent pool for wildlife and aesthetic benefits. Wet pond detention basins will also give some improvement in the quality of runoff and reduce sedimentation but these are secondary benefits. They will also increase infiltration to the ground water which may not be acceptable if stormwater is badly polluted.

Applications

Wet pond detention basins are particularly appropriate in areas of urban development with high visibility where their aesthetic, wildlife and recreational benefits can be realized. If a site has high permeability and the quality of the inflow water is poor, this measure can be applicable but the base of the permanent pool must be lined with an impermeable membrane or clay to prevent infiltration.

Description

Wet pond detention basins are designed to control peak discharges of stormwater by detaining a large volume of stormwater for delayed release above a permanent pool. The primary purpose of these basins is not to improve the water quality which requires that water be detained for a substantial time (see Measure 2.1 Wet Ponds with Extended Detention). The permanent pools provide amenity features and habitat for plants and wildlife. Surveys have shown that a majority of residents in new communities prefer basins with a permanent pool to dry ponds.

The temporary storage capacity of these basins requires several feet between the surface of the permanent pool and the spillway elevation. Careful design is required to avoid the appearance of a pond at the bottom of a depression, and the site should be also integrated carefully into the urban fabric.

Basins may be created with an earthen dam, by excavation or by a combination of both. The crest of the dam should have a minimum width of 3m to provide for vehicular access. The spillway is designed to allow discharge of water at the desired rate from the storage above the permanent pool but to prevent discharge of water below permanent pool level. Because detention basins will trap any debris floating in stormwater, spillway devices should be fitted with trash racks to insure they function properly. An emergency spillway must be provided and there should be a minimum of 30 cm of freeboard above the spillway elevation. A forebay with a volume of approximately 10 % of the total pond should be placed at the pond inlet to settle out heavier bulky sediments. A bench\*\* or safety ledge 3m wide should surround the perimeter of the pond where the water would be no deeper than 1m when the pond is full.

If the permanent pool is managed for fish that are to remain during the winter, some of the permanent pool should be at least 2m deep.

Illustration /Sketch

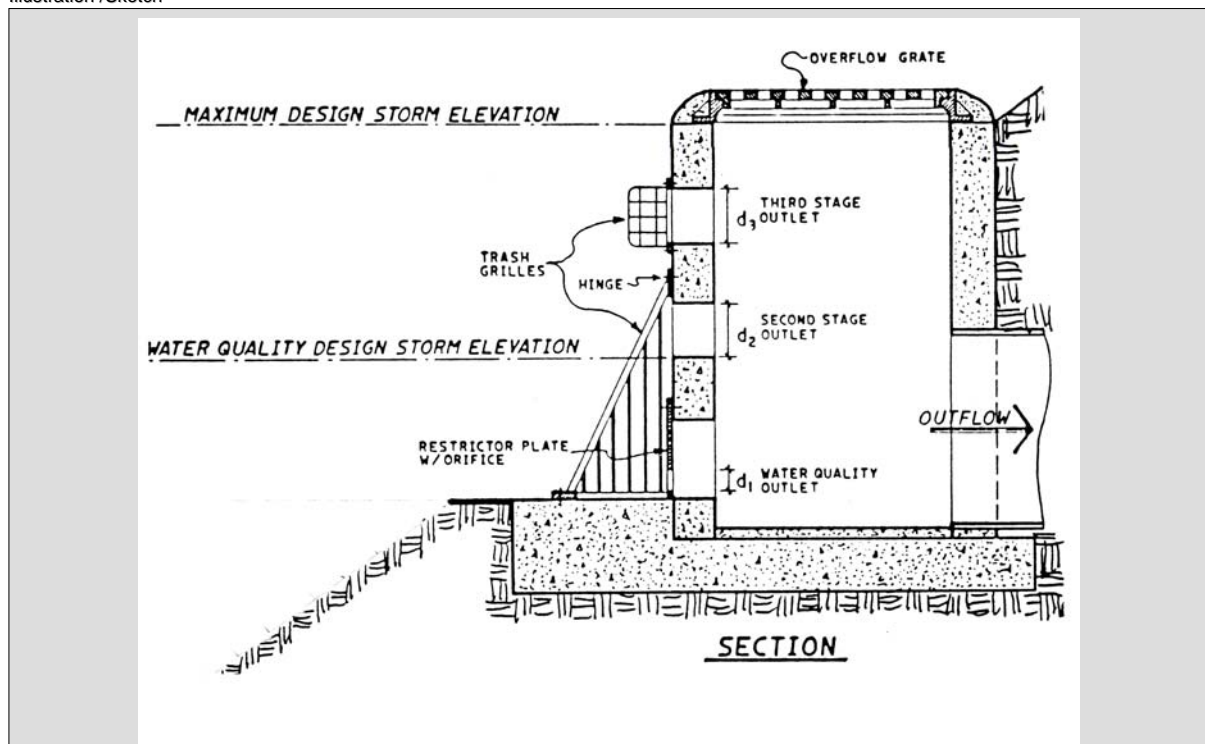



Group No

5.1

Group of measures

**Detaining peak flows**

Measure name

Wet Pond Detention Basins

Synonym

Ruckhaltebecken mit permanentem Einstau

Maintenance

Wet pond detention basins are designed to control peak discharges of stormwater by detaining a large volume of stormwater for delayed release above a permanent pool. The primary purpose of these basins is not to improve the water quality which requires that water be detained for a substantial time (see Measure 2.1 Wet Ponds with Extended Detention). The permanent pools provide amenity features and habitat for plants and wildlife. Surveys have shown that a majority of residents in new communities prefer basins with a permanent pool to dry ponds.

The temporary storage capacity of these basins requires several feet between the surface of the permanent pool and the spillway elevation. Careful design is required to avoid the appearance of a pond at the bottom of a depression, and the site should be also integrated carefully into the urban fabric.

Basins may be created with an earthen dam, by excavation or by a combination of both. The crest of the dam should have a minimum width of 3m to provide for vehicular access. The spillway is designed to allow discharge of water at the desired rate from the storage above the permanent pool but to prevent discharge of water below permanent pool level. Because detention basins will trap any debris floating in stormwater, spillway devices should be fitted with trash racks to insure they function properly. An emergency spillway must be provided and there should be a minimum of 30 cm of freeboard above the spillway elevation. A forebay with a volume of approximately 10 % of the total pond should be placed at the pond inlet to settle out heavier bulky sediments. A bench\*\* or safety ledge 3m wide should surround the perimeter of the pond where the water would be no deeper than 1m when the pond is full. If the permanent pool is managed for fish that are to remain during the winter, some of the permanent pool should be at least 2m deep.

Advantages

The aesthetic attraction of wet ponds can more than double real estate value of adjacent properties. Additional construction costs are nominal compared to a dry pond. In addition to their primary purpose of reducing flood peaks, these basins will also improve stormwater quality, remove sediment and increase infiltration. Aquatic vegetation in the permanent pool can remove significant amounts of dissolved pollutants in stormwater. Dry detention basins do not have this advantage.

Disadvantages

The banks of the temporary pool will be exposed following drawdown and the removal of flood debris may be necessary. If stormwater is badly polluted and soils are highly permeable, the permanent pool needs to be lined which is costly. A supply of water is required to maintain the water level of the permanent pool during dry weather if there is no base flow. Eutrophication and algae may cause problems particularly when inflow water is rich in nutrients.

Examples

Examples

References and suggested reading

Tourbier & Walmsley, Inc.: London Grove Township Stormwater Management Guidance Manual. London Grove Township Board of Supervisors, Philadelphia.  
Schueler, T.R., 1987. Controlling Urban Runoff. Washington Metropolitan Water Resources Planning Board. Washington DC.  
1996; Reeder, Rachel (Ed.): A Watershed Approach to Urban Runoff. Handbook for Decisionmakers. Terrene Institute; Washington, D.C. 1996

Example Photos

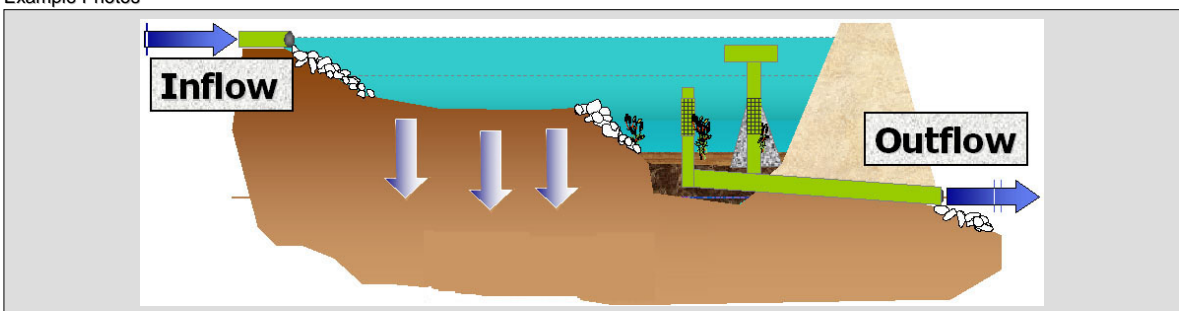

Group No	Group of measures
5.2	<b>Detaining peak flows</b>

Measure name	Synonym
Dry Pond Detention Basins	Trockene Rückhaltebecken

Purpose	Applications
<p>Dry pond detention basins provide temporary storage of runoff to reduce peak flows. After a storm, stormwater is released at a predetermined rate until the basin is completely empty. The spillway is normally designed to allow complete release of impounded water within 12 hours. Very shallow basins can be maintained with a cover of grass to permit other uses during dry weather. Dry pond detention basins will also give minor improvement in the quality of runoff and reduce sedimentation but these are secondary benefits. They will also increase infiltration to the ground water which may not be desirable if stormwater is badly polluted.</p>	<p>Dry detention basins do not have the visual appeal of wet basins and do not enhance adjacent property values. Because dry detention basins are usually more than 1m deep and they pose a potential safety hazard and fencing may be necessary. This can be visually displeasing. On sites where impoundments can be large but not deep enough to cause a safety hazard, multi use can be permitted (see also Measure 4.3) .</p>

Description
<p>Dry pond detention basins are designed to detain and release stormwater runoff at a controlled rate in order to lower flood peaks. The spillway will normally be designed to release all detained water within 12 hours. Clearly if a second storm event occurs before the pond is empty, the storage capacity and hence its effectiveness will be reduced. Spillways may be tricked tubes with perforated risers or other design. Because detention basins will trap any debris floating in stormwater, spillway devices should be fitted with trash racks to insure they are not blocked. An emergency spillway is essential, with the crest of the spillway at least 30 cm below the crest of the dam.</p> <p>If a site has high permeability and the quality of the inflow water is poor the detention time should not exceed 12 hours. Otherwise it may be required that basin must be lined with an impermeable membrane or clay to prevent infiltration. The depth of the basin is variable, depending on land availability and other factors. Deeper basins pose a safety hazard and may require a perimeter fence. Side slopes also vary and may be as steep as 2(h):1(v) but only if the basin is fenced. Large grassy depressions can also function as dry basins. Because of the filtering action of the grass sward, a impermeable liner is not necessary on permeable soils.</p> <p>Because of the short period of detention, soluble pollutants, such as nitrate and phosphate, pass through dry ponds undiminished. Detention of stormwater for 12 hours will remove no more than 10% of particulates but 24 hour detention can result in removal of up to 90% of particulate pollutants (ASCE, 1992, p. 503). Longer detention times with some loss of effectiveness in flood control may be desirable if stormwater carries heavy sediment loads. Dry basins are not normally designed with a forebay (as are wet detention basins) to trap large sediment. Sediments instead will settle in the base of the pond whence it is removed during dry conditions.</p>

Illustration /Sketch

Group No

5.2

Group of measures

**Detaining peak flows**

Measure name

Dry Pond Detention Basins

Synonym

Trockene Rückhaltebecken

Maintenance

Floating debris in stormwater will be trapped in detention basins and must be removed from trapping devices on the spillway and in the basin after every storm event.  
 When they are planted with grass, dry ponds require regular mowing.  
 Dry detention basins are not designed with a forebay (as are wet basins – Measure 5.1 ) where sediment deposits are concentrated. Sediment will accumulate in the basin itself. A hard surface strip 2m wide can be installed across the lowest part of the basin to allow easy removal of sediment with a front end loader.

Advantages

As a single purpose flood detention device, dry ponds are effective when no runoff pollution control or infiltration is desired.

Disadvantages

If not carefully graded, dry ponds often contain depressions that retain puddles of water which can interfere with mowing and where mosquitoes can breed.  
 Unless very well designed, fenced ponds can be visually unsightly.  
 Because of the short detention time, dry basins offer only minor secondary benefits such as stormwater quality improvement and infiltration.  
 If stormwater is badly polluted a maximum detention time of 12 hours should be used.

Examples

Examples

References and suggested reading

WRPT measure 1:13  
 Tourbier & Walmsley, Inc.: London Grove Township Stormwater Management Guidance Manual. London Grove Township Board of Supervisors, Philadelphia 1996;  
 Reeder, Rachel (Ed.): A Watershed Approach to Urban Runoff. Handbook for Decisionmakers. Terrene Institute; Washington, D.C. 1996.

Example Photos



Group No

Group of measures

6.1

### Minimizing pollution from sewage

Measure name

Combined Sewer Source Control

Synonym

Mischkanalisation – Überflüsse

Purpose

Sewers that combine septic sewage and stormwater put severe loads on treatment plants. The latter usually are constructed to only treat dry weather flows and to bypass untreated sewage during storm events. In most developed countries wet weather overflows are a common practice and a severe source of water pollution in cities. Cities, such as Washington DC have set goals to capture 85 % of its CSO on an annual basis or have no more than four overflows per year.

Applications

Measures to reduce CSO are applicable to all urban areas with combined sewers. Measures include (1) localized upstream detention, (2) retard inflows, (3) pollution prevention programs, (4) Pre-treatment and detention of non-domestic sources, (5) Control of solid and floatable materials in CSO, (6) maximize use of the collection system for storage, (7) provide for off-line storage of combined sewage, (6) Monitoring

Description

(1) Localized upstream detention - provide for the attenuation of stormwater runoff (1-3), for measures to reduce peak flows of stormwater (23,24) and maintaining ground water recharge (measures 4.1-4.6). (2) Retard inflows – here special gratings or Hydrobrakes are being used to modify catch basin inlets to restrict the rate at which surface runoff is permitted to enter the system. (3) Pollution prevention programs – Many of the measures 2.1-2.7 (Runoff quality improvement) and 3.1-3.6 (Control of Erosion and Sedimentation) reduce and /or delay runoff in addition to reducing the pollution hazard. This especially applies to the first flush of stormwater following dry periods carrying heavy pollution loads. Street sweeping and catch basin cleaning also helps. (4) Pre-treatment and detention of non-domestic sources – industrial and commercial sources, including restaurants, and gas stations may be required to pre-treat and retain their wastewater during wet-weather conditions. (5) Control of solid and floatable materials in CSO – baffles, screens, catch basin modifications, and nets may be used. (6) Maximize use of the collection system for storage – refers to the use of existing sewers to hold a portion of the surplus flows during storm events. (7) Provide for off-line storage of combined sewage – Many cities are considering consolidated storage in underground tunnels, from which the CSO is pumped to an existing treatment plant when the capacity becomes available. (6) Monitoring – should be conducted to effectively characterize CSO impacts and the efficiency of CSO control.

Illustration /Sketch

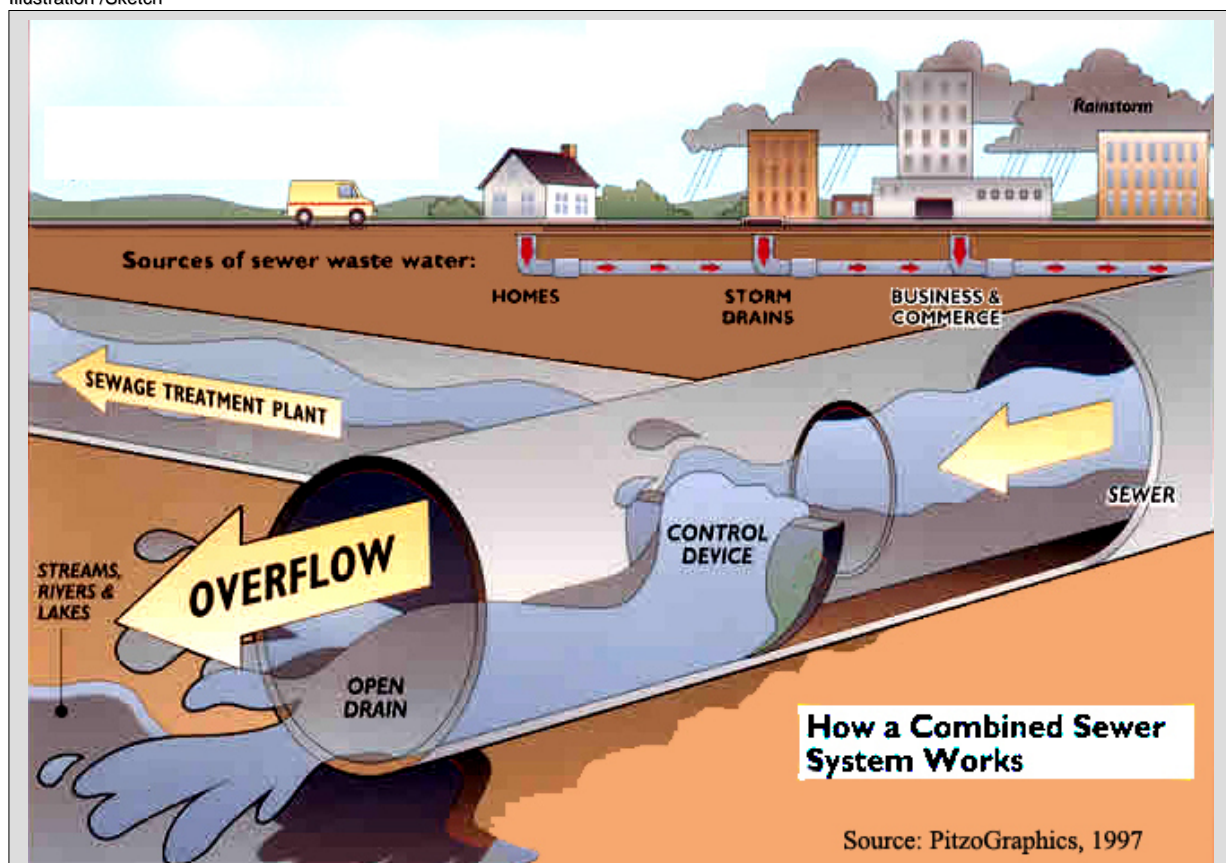

Group No

6.1

Group of measures

**Minimizing pollution from sewage**

Measure name

Combined Sewer Source Control

Synonym

Mischkanalisation – Überflüsse

Maintenance

Maintenance requirements for all measures referred to here are discussed under each measure contained in this document and referred too by sheet number.

Advantages

Water that enters cities in streams is relatively unpolluted and leaves the city with a considerable pollution load. Contrary to public perception treatment plants do not function sufficiently during wet weather conditions. Measures outlined here help citizens to enjoy their rivers without interruptions through periods of heavy pollution.

Disadvantages

In many cities CSO are ignored and unknown to the general public and not being considered a problem by environmental groups. As a result there may not be a constituency that insists on the considerable expenditures for CSO control. The most effective control – storage in underground tunnels – has a phenomenal price tag, often measured in billions of €

Examples

The city of San Francisco has implemented a range of measures to reduce pollution of the Bay. It has maximized the use of sewer lines for in-line storage and practices baffling to remove floatable and settling to remove solids. Solids are flushed to the treatment plant after a storm passes. Since 1983 the city has routinely been monitoring overflows, using automatic samplers and analysed for BOD, TSS, oil and grease, phenols, and metals (source (1)).

References and suggested reading

(1) NPDES # CA0037681, BPT/BCT/BAT Determination, 29 pp.  
(2) Anacostia Watershed Restoration Indicators and Targets for Period 2001-2010, Washington DC: Department of Environmental Programs, Metropolitan Washington Council of Governments, August 2001, 49 pp,

Example Photos



Group No

Group of measures

7.1

### Channel rehabilitation through transverse structures

Measure name

Sills or Weirs with Plunge Pool

Synonym

Sohlgurt - Rundholzschwelle

Purpose

Sills or weirs less than 30 cm high built across a stream will create a shallow pool upstream which will gradually fill with sediment. Or the upstream pool can be backfilled with rock and gravel to increase spawning habitat. In both cases a plunge pool will tend to form below the structure. The pool will be broad and shallow if flow is across the whole length of the sill, or smaller and deeper if spillway flow is concentrated to one point. Sills will tend to lessen scouring of the channel bed by dissipating energy in the plunge pool. This measure increases the diversity of habitat in streams. Live material can be used in these structures.

Applications

Sills have been used to rehabilitate streams that have been channelized and where the inevitable disturbance is outweighed by the improvement in habitat. Live sills are used to dissipate energy in streamflow in small streams that have a high ratio of stormwater to base flow. They will only be successful in drainage swales or small streams where live material placed across the stream channel not only can survive and grow but will not cause obstruction to streamflow that will result in other problems.

Description

Sills can be constructed of timber cribwork, rock, fascines, logs and gabions in various combinations and configurations. A cribwork sill is described here. Cribwork sills are constructed of logs (min.dia. 0.2m.). The sill should be aligned at a right angle to the banks and should be angled into the streambed at 45 degrees. A trench (depth 1m.) is dug across the stream channel and filled with large rock to form the toe of the sill. As the stream begins to form a plunge pool this rock will be displaced slightly. A long footer log is then laid at the upstream edge of the rock toe across the stream and secured by 1.5cm. rebar driven into the streambed (1m.deep or to refusal) through predrilled holes in the log. Logs, 1.5m. long, that have been pointed at one end are driven into the streambed at 45 degrees resting against the footer log. These are spaced at no more than 1m. Between these, 1.5m. long live branches may be placed. Another long log is placed across the stream creating the desired angle with the footer log for the face of the sill. Pointed logs are then driven into the streambed at 45 degrees resting against the long log and, if desired more live branches placed. All joints are secured with 1.5 cm. rebar driven through predrilled holes. This process is repeated until the sill has reached the height required. The crib frame that has been built up should be filled with rock and gravel. Additional live material, usually live stakes should be used to reinforce the point at which the sill meets the bank. Live sills contain live branches as an integral part of the structure. If the baseflow level in the stream is high, live material growing in the structure will not survive. Therefore, live sills should be used only in streams that carry a high ratio of stormwater to base flow or as drop structures in stormwater channels. Live branches increase the deposition of sediment and provide self-healing protection to the structure. The vegetation also increases habitat diversity. Live material must be dormant, and branches (usually willow) should be 1.5 -2m long with a minimum basal diameter of 3cm.

Illustration /Sketch

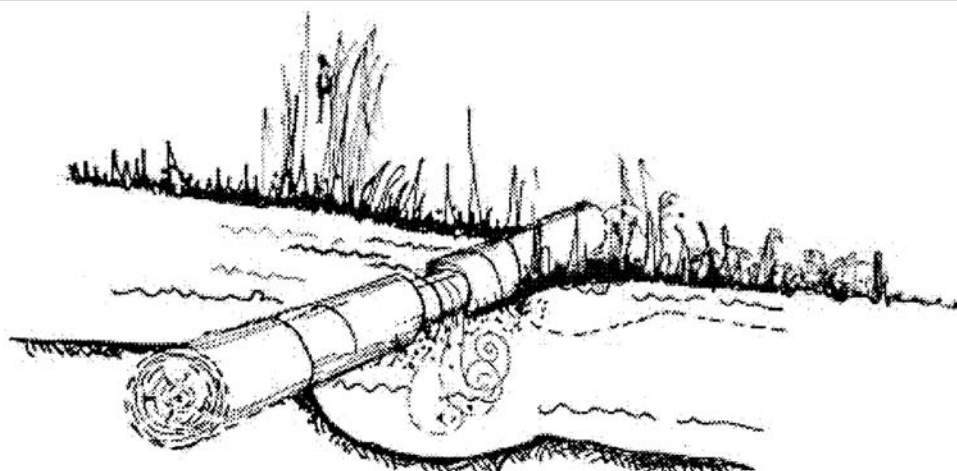

Single Log Dam Weir  
Section-Perspective View

Source: Stream Corridor Restoration Handbook, USDA

Group No

7.1

Group of measures

**Channel rehabilitation through transverse structures**

Measure name

Sills or Weirs with Plunge Pool

Synonym

Sohlgurt - Rundholzschwelle

Maintenance

As the stream begins to form a plunge pool, the rock forming the toe of the sill may be displaced somewhat. Maintenance may require additional rock if erosion is seriously undercutting the structure. The logs used to construct cribwork sills will gradually deteriorate and lose effectiveness. If a more permanent sill is required a gabion or rock structure should be considered. However the cribwork may give sufficient protection for a long enough period for a stream to establish a relatively stable condition, especially in case where live material has been included in the structure. However, if a live sill has been used in too large a stream, the vegetation will not flourish sufficiently well to provide long-term protection for the structure. The measure is used in situations where it will be difficult to predict stream behaviour and the consequent damage to the structure. Maintenance requires regular monitoring and appropriate response to any undesirable changes in stream behaviour.

Maintenance of the vegetation will involve periodic coppicing of the willow to maintain its vigour, and the removal of any snags that are resulting in erosion.

Advantages

Crib sills are useful on sites where rock is difficult and expensive to obtain.  
 If suitable logs can be harvested on site, cost can be low.  
 Live sills can be used to increase diversity of habitat in small streams

Disadvantages

Driving posts at 45 degrees requires special equipment and skill.  
 Although willow can grow in permanently saturated ground it will have a low survival rate when rooting and growing in water. This limits the use of live material in providing long-term, self-healing protection for live sills.

Examples

Examples

Example Photos

Photos

References and suggested reading

Schiechl p.139

Group No

Group of measures

7.2

**Channel rehabilitation through transverse structures**

Measure name

Rock Rakes

Synonym

Rechen, Kies-Rechen

Purpose

Rock ramps are transverse stream structures of packed rock designed to allow a stream to flow to down a small drop in elevation without causing erosion. The roughness of the rock dissipates the energy in the streamflow. A plunge pool should not develop. The rock is packed so as to spread the streamflow over a broad front. Live materials can be used to give the structure more permanence, especially where the structure meets the streambanks. Schiechl calls rock ramps "live ground sills" if they contain live materials

Applications

Rock ramps are most useful to dissipate excess energy in flows in smaller streams with steep gradients. For applications where plunge pools are not acceptable, rock ramps dissipate energy in the flow by the roughness of the rock and a plunge pool is not formed. If large rock is not available smaller rock can be used in gabions but the surface will be less rough and less effective in energy dissipation. Live ramps are used in small streams that have a high ratio of stormwater to base flow, or drainage swales that carry only stormwater.

Description

Each rock for rock ramps is individually placed. The structure secured in place with wooden or steel pegs. Some of these may be live stakes (see measure 10.4) particularly close to the stream bank. Schiechl (p. 141) shows cuttings inserted between hand packed rocks. Schiechl also proposes for "rock or gabion ground sills" that live branches be placed as the rock is packed with the tops pointing downstream (p.142). When gabions are appropriate, they may be fabricated on site using 3m. wide galvanized wire mesh or geogrid. A 1m. wide trench (about 1m. deep) is dug across the channel and the wire mesh laid over it. Rock and gravel is then dumped on the mesh forcing it down into the trench. During this process live branches can be laid into the fill. The edges of the mesh are then pulled and laced together with binding wire. Live ramps contain live branches as an integral part of the structure. If the baseflow level in the stream is high, live material growing in the structure will not survive. Therefore, live ramps should be used only in streams that carry a high ratio of stormwater to base flow or as drop structures in stormwater channels. Live branches increase the deposition of sediment and provide self-healing protection to the structure. The vegetation also increases habitat diversity. Live material must be dormant, and branches (usually willow) should be 1.5 -2m long with a minimum basal diameter of 3cm.

Illustration /Sketch

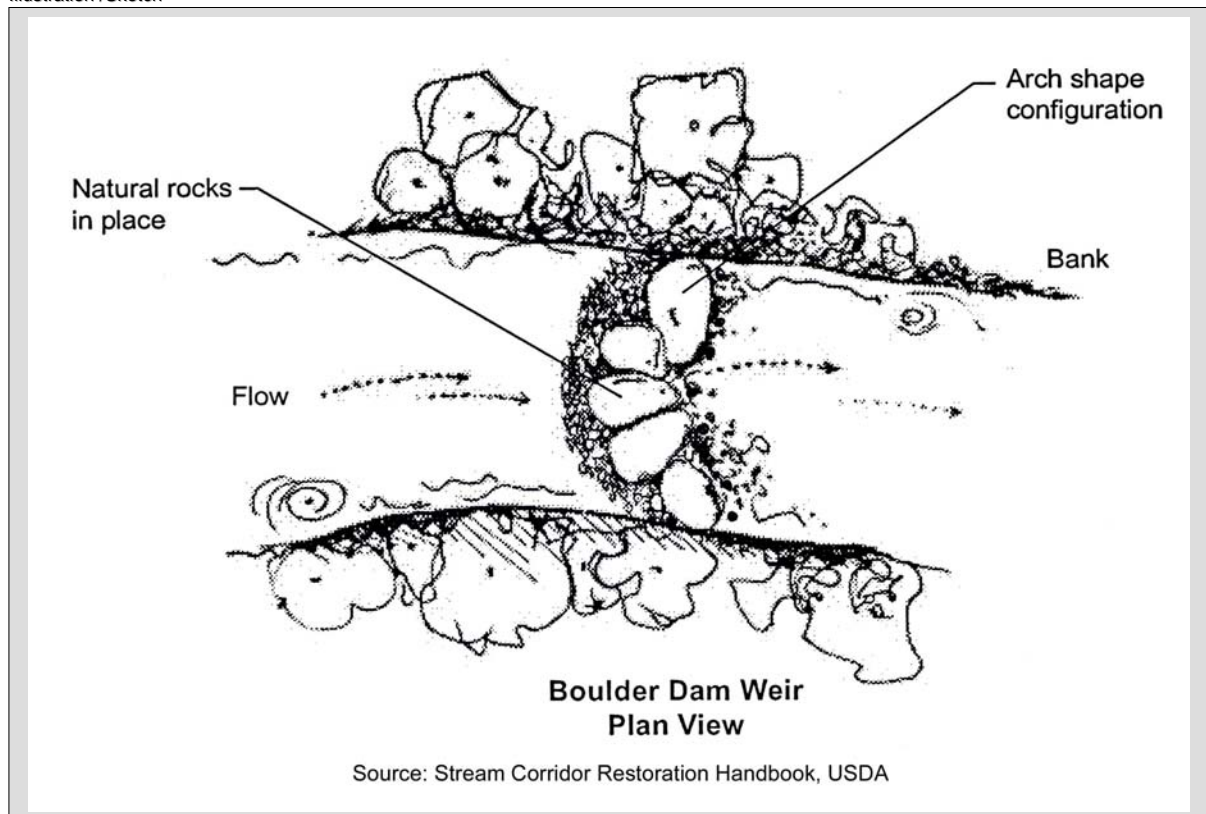



Group No

7.2

Group of measures

**Channel rehabilitation through transverse structures**

Measure name

Rock Rakes

Synonym

Rechen, Kies-Rechen

Maintenance

If rock size is of sufficient size and has been well packed and secured, rock ramps should require little maintenance. If a plunge pool begins to form, there is still excess energy in the streamflow. If the plunge pool is not causing a problem it can be allowed to remain or it can be filled with large riprap. As in the case of sills (measure 7.1), ramp installations require regular monitoring and appropriate response to any undesirable changes in stream behavior. Maintenance of the vegetation will involve periodic coppicing of the willow to maintain its vigour, and the removal of any snags that are resulting in erosion.

Advantages

Hand packing of rock will cause much less disturbance than placing with machinery. If large rock is not available gabions are an option.

Disadvantages

Hand packing rock is labor intensive. Live materials will have a low effectiveness and survival rate when live ramps are used in larger streams.

Examples

Stones placed into streams to form rock rakes are secured in place by steel pins cut off at the water surface. The appearance is totally natural.

References and suggested reading

Schiechl p.141-142  
Schiechl, Hugo M.; Stern, Roland: Handbuch für naturnahen Wasserbau. Eine Anleitung für ingenieurbio-logische Bauweisen. Österreichischer Agrarverlag, Wien 1994; 8

Example Photos

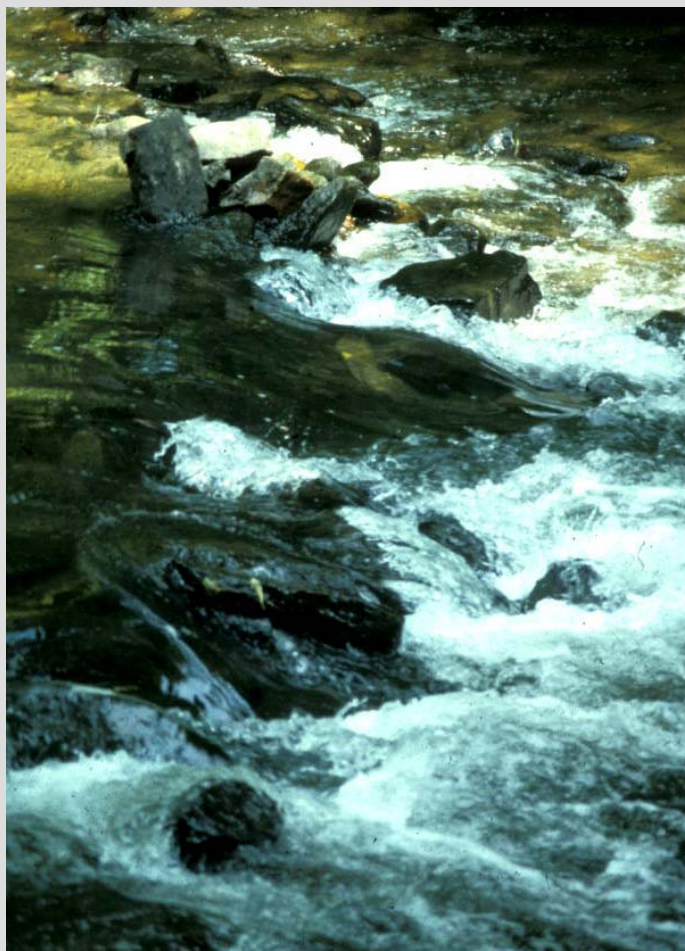

Group No

7.3

Group of measures

### Channel rehabilitation through transverse structures

Measure name

Rock Cascades

Synonym

Höckerschwelle, Blockschwelle

Purpose

Where streams must negotiate a drop in elevation in a short distance, a ramp of large rocks, placed loosely into the streambed can dissipate the energy without eroding. The rocks are secured in place by their own weight. The structure is mimicking rapids in a natural stream channel.

Applications

Cascades are useful when streamflow has excessive energy and a drop structure is required, and where a cascading effect is desirable.

Description

Rock cascades require large rock and heavy equipment to handle it on site. It also requires careful placement as the rock will determine the direction of flow. Wood piling can be used downstream of the structure to provide additional stability during the first years. A structure designed to have multiple cascades will be more effective in dissipating energy without forming a large plunge pool, which can undercut the structure. However, the structure should be flexible enough to permit slight shifting during flood events. Gabions have been used to create cascades but they have a very artificial appearance. Live materials can be used to give the structure additional stability where it meets the bank. The live material can be placed in various configurations.

Illustration /Sketch



Source: Stream Corridor Restoration Handbook, USDA

Group No

7.3

Group of measures

**Channel rehabilitation through transverse structures**

Measure name

Rock Cascades

Synonym

Höckerschwelle, Blockschwelle

Maintenance

In the situations where cascades are installed, streamflow has very high energy. However, if rock size is of sufficient size and has been well packed and secured, rock cascades should require little maintenance. A plunge pool will usually form below the cascade, but it is not causing serious instability to the structure it can be allowed to remain.

As in the case of sills (measure 7.1), ramp installations require regular monitoring and appropriate response to any undesirable changes in stream behaviour.

Maintenance of the vegetation will involve periodic coppicing of the willow to maintain its vigour, and the removal of any snags that are resulting in erosion.

Advantages

If well designed, rock cascades can effectively dissipate energy and be attractive visually. They will also increase habitat diversity in the stream.

Disadvantages

Rock must be similar to that found locally. Careful design and placement is required to achieve both effectiveness and the desired visual effect.

Examples

Examples

References and suggested reading

Begemann, Wolf; Schiechl, Hugo M.: Ingenieurbilogie. Handbuch zum ökologischen Wasser- und Erdbau. Bauverlag, Wiesbaden 1994; Zeh, Helgard: Ingenieurbilogische Bauweisen, Studienbericht Nr. 4, 1993. Eidgenössisches Verkehrs- und Energiedepartement, Bundesamt für Wasserwirtschaft, Bern 1993;

Example Photos

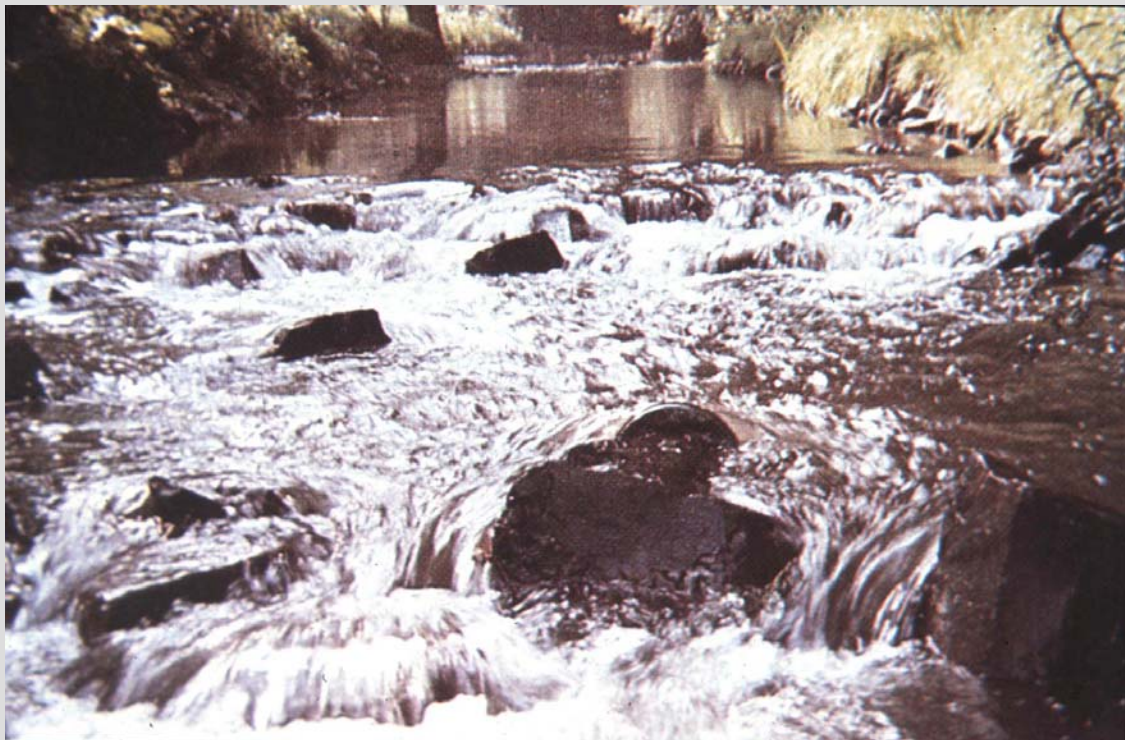

Group No

Group of measures

7.4

### Channel rehabilitation through transverse structures

Measure name

Rough Bed Channels

Synonym

Rauhe Rampe, seitlich gerümmte Sohlrampe

Purpose

Roughening the bed of a stream channel will dissipate much of the energy in the streamflow without altering the gradient. Rock must be of sufficient size to resist any movement during high flows.

Live materials can be inserted between rock near the banks.

This measure can also increase spawning areas for some fish species especially when gravel is included with the rock during installation. Rough bed channels will increase stream habitat diversity.

Larger rocks can also be included that emerge above normal water level (Boulder clusters-SCRH 2).

Applications

Useful for streams that do not have a gravel bed and which are susceptible to bed scouring.

Also for streams which have little suitable spawning habitat for desired species of fish

Description

Rock that is used to roughen the bed of a stream must exceed in size the natural „capability“ of the stream (The largest size of rock that can be moved physically by the stream). The method used to select the correct size of rock for riprap can be used to find the rock size necessary (see measure 8.5) In the U.S., the USDA, the U.S. Corps of Engineers and the U.S. Highway Administration use slightly different methods that are summarized in USDA 1996 (p. 16-49). Some very large rock may be included that will emerge above the normal flow level of the stream. These will increase diversity of habitat but great care must be taken to ensure that the boulders do not result in bank erosion.

Smaller rock and gravel may be included during installation as this will be protected by larger rock and will result in the formation of gravel bars. However unless it is replenished from an upstream source gravel will gradually move downstream. Gravel bars can be protected as they form with live material inserted into them. Live material inserted between the rock during installation will also encourage the build up of sediment deposits and gravel bars.

When vegetation is to be used to stabilize banks, live stakes (dia. 4 cm. min. length 0.7-1.0m.) are inserted so that about 75% of their length is below the soil. When the stakes are being inserted through rock a steel probe should be used to find gaps in the stone and to make a hole in the streambed. After inserting into the hole prepared with the probe, the stake should be driven with a wooden mallet. It is essential that the stakes have been freshly prepared and should be inserted immediately after preparation. Side branches should be removed cleanly and each stake pointed at its lower end. After insertion any split or frayed ends should be pruned off cleanly.

If the riprap is being hand packed, willow branches with smaller diameters can be used and inserted as the packing proceeds.

Illustration /Sketch

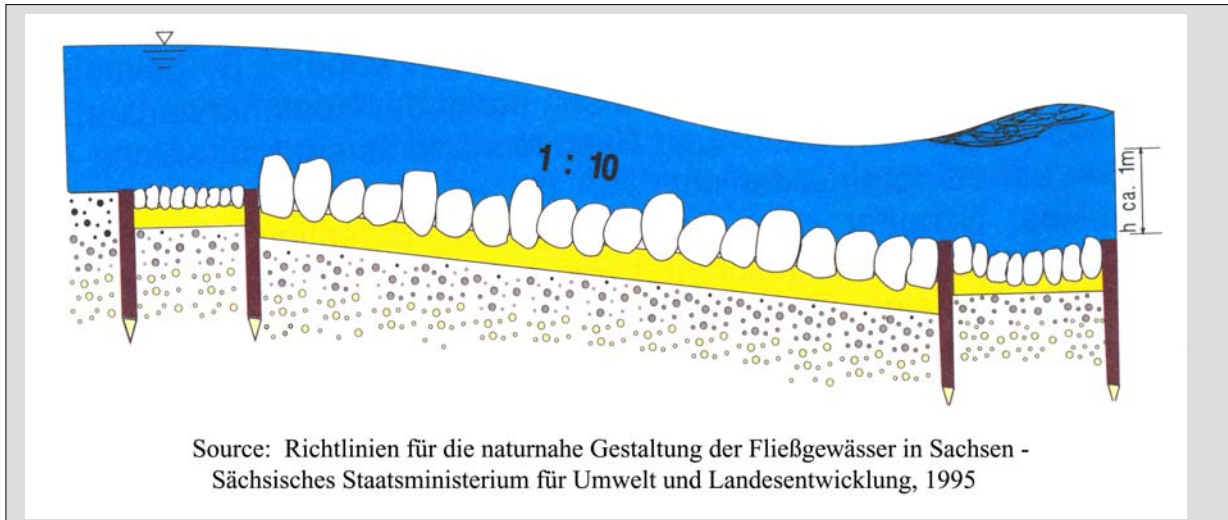

Group No

7.4

Group of measures

### Channel rehabilitation through transverse structures

Measure name

Rough Bed Channels

Synonym

Rauhe Rampe, seitlich gerümmte Sohlrampe

Maintenance

If the correct rock size has been used maintenance should not be minimal, but the measure will likely result in some unforeseen stream behavior and careful observation of the stream following installation will reveal any places where additional rock is required. As the sorting mechanism of the stream results in the formation of gravel bars these can be stabilized with live stakes. Periodically, it may be desirable to provide an additional source of gravel upstream of the installation by dumping small loads in the stream. Obviously dump sites must be chosen carefully to avoid adverse effects.

If clusters of very large boulders emerging above the water are used, their effect in diverting streamflow should be carefully observed. If they are causing unacceptable bank erosion, they must be repositioned. In cases where vegetation has been included in the installation, it must be remembered that willow is not shade tolerant and there may be a loss of effectiveness of the measure after adjacent plants begin to shade each other out. Periodic coppicing will keep the plants vigorous and effective.

Advantages

This measure is simple, but if long reaches are to be treated it is not necessarily low cost. It requires little hand labor unless the rock is hand packed.

The large rocks can effectively dissipate much of the excess energy in the streamflow and at the same time allow the build up of gravel between them.

Disadvantages

Placing large rock along the length of the stream will be destructive and it will take the stream time to reestablish habitat diversity. The site must be accessible by dump trucks.

Rock will tend to sink into the stream bed in very silty soils, and may need replacement.

Newly mined rock can be very unsightly and should be chosen to suit the site. If rock is not quarried locally, transportation costs will be high. Probing holes to insert stakes through existing or dumped rock can be time consuming.

Examples

Photo: Rough bed channel at Route 72 Underpass, Dresden  
Designer: Ökoplan, Dresden

Example Photos



References and suggested reading

SCRH 4

Schiechtl, Hugo M.; Stern, Roland: Handbuch für naturnahen Wasserbau. Eine Anleitung für ingenieurbio-logische Bauweisen. Österreichischer Agrarverlag, Wien 1994; 8.

Group No

Group of measures

8.1

### Channel rehabilitation through parallel structures

Measure name

Fibre Rolls and Reed Rolls

Synonym

Röhrichtwalze

Purpose

Manufactured fibre rolls are available. These erosion resistant rolls are staked along the foot of a streambank to prevent lateral scouring. Rooted aquatic plants can be inserted into the roll or the roll can be staked down with live stakes to increase its long term effectiveness. Rolls can also be fabricated on site using wire mesh or geogrid filled with rootstocks of appropriate aquatic plant species, and placed in a trench at the toe of the bank.

Applications

This measure is used in streams that have little fluctuation in water level but where scouring is occurring at the toe of the bank. It is also useful for the margins of lakes. It tends to be used in high profile situations to stabilize the water's edge. Manufactured rolls are easy and quick to install and result in a finished appearance.

Description

Manufactured rolls are cylindrical (dia. 30cm. and 6m. long) and are fabricated from coconut fibre and have an effective life of about 5-10 years. They are placed in a shallow trench at the toe of the streambank and staked down. They contain no live plant material and, if it is desired that plants should gradually take over the function of the roll, rooted plants or live stakes must be used in the installation. In situations where the roll is kept constantly saturated rooted aquatic plants may be inserted into cuts made in the roll, or they may be planted behind the roll. If large rootwads of aquatic plants are available on site this would be desirable. Live stakes (see Measure 10.4) can also be used to stake down the rolls.

Rolls that are fabricated on site are usually made of wire netting or geogrid 1.5 m. wide and as long as is necessary. Jute or other biodegradable fabric may be used if there is concern about the hazard of wire or the unsightliness of geogrid. The mesh is paced over a shallow trench, filled with rootwads of aquatic plants, soil and gravel in various proportions and then laced at the top to form a continuous roll, the top of which should be just above the normal flow level. Rolls may be secured in place with live or dead stakes. Schiechl (p.147) suggests that a line of stakes is first driven close to the normal water level and spaced at approximately 1-1.5m. Above this line the trench (.0.4mX0.4m.) is dug and boards used to secure the sides of the ditch during installation of the roll. The stakes are then driven until their tops are flush with the roll. If live stakes are used, the growth of willow may shade out the aquatic vegetation in the roll. Schiechl also suggests (p.148) that, where the water is deeper at the streambank, the roll can be placed on a layer of brush. A second parallel roll can be installed 1-2m. above the first, but care should be taken to select plants suitable for the drier conditions. Vegetation may also be planted upslope of the rolls to provide protection of the upper streambank.

Illustration /Sketch

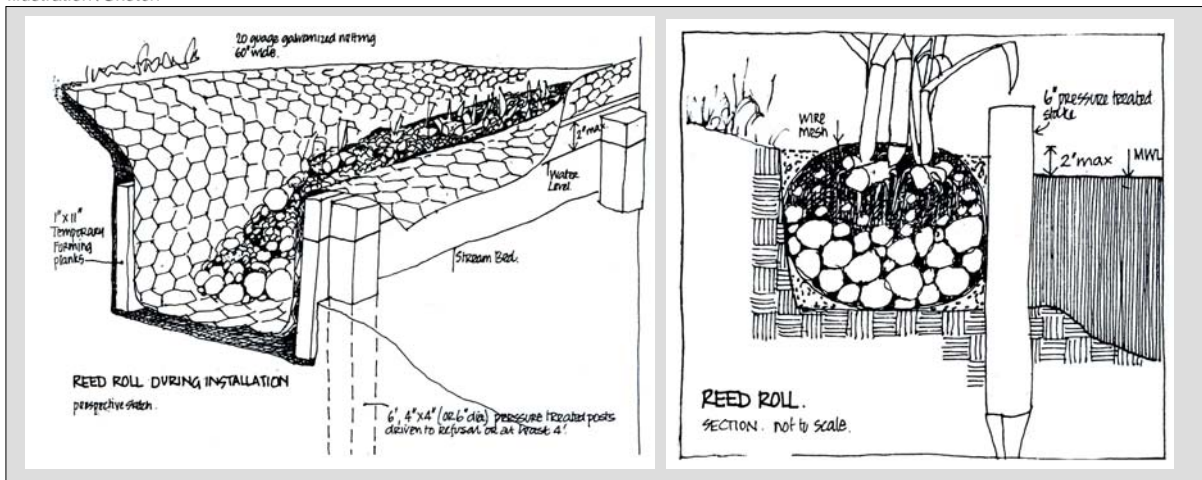

Group No

8.1

Group of measures

**Channel rehabilitation through parallel structures**

Measure name

Fibre Rolls and Reed Rolls

Synonym

Röhrichtwalze

Maintenance

After a manufactured roll disintegrates some repair work may be needed, but if aquatic plants were included during installation it should be self-healing. Reed rolls normally require no maintenance except in cases where they were placed on a brush, riprap or gabion footing in which case some damage from slumping may occur. A technique appropriate to the specific type of damage must be selected to make repairs if they are necessary. If live stakes were used to secure the roll in place, the willow growth may require regular coppicing to prevent shade killing the aquatic plants.

Advantages

The expense of manufactured rolls is offset by the ease and speed of installation. Both manufactured rolls and reed rolls give immediate protection following installation. If reed clumps are available on site this is a very cost effective measure, that will quickly result in a finished appearance.

Disadvantages

Fibre rolls give no long term protection unless vegetation is included in the installation. If wire mesh is used for rolls fabricated on site, it may pose a potential hazard to users on the streambank as it rusts and deteriorates. Geogrid may be unsightly. The measure is not suitable for streams with widely fluctuating water level and fast erosive flows.

Examples

Photo:  
Bestmann Ingenieurbiologie GmbH  
Wedel, Germany

References and suggested reading

Schiechl p.147  
USDA, 1996. „Streambank and Shoreline Protection“. Chapter 16 from the Engineering Field Handbook. Washington DC.  
Schr 20, schr 24

Example Photos



Group No

Group of measures

8.2

### Channel rehabilitation through parallel structures

Measure name

Live piling revetments, Live barriers

Synonym

Lebende Ufer Lahnung, Lebende Barre

Purpose

To protect and stabilize zones along the shore of rivers and other bodies of water against wave action. To create a "stillwater zone" as a habitat for microorganisms, submerged and emergent aquatic vegetation and aquatic fauna (salamanders, fish, water birds).

Applications

Where water surfaces are large enough to result in wave action that can cause shoreline erosion. Also on rivers where boat traffic can generate damaging waves that can also adversely affect stands of emergent aquatic vegetation.

Description

Both, live piling revetments and live barriers create protected stillwater zones. Live piling revetments consist of brush packing and fascines between a double row of wooden posts (see Drawing ). Live barriers consist of underwater berms created from dredge material . Both measures extend to the mean water line and live willow whips that will root and provide long-term stability are used in construction. The measures should be orientated at 45 degrees to 90 degrees angle to the direction of the potentially most damaging wind and waves. Construction should be carried out during low water levels, but insertion of willow whips should be delayed until mean water level has been reached. When measures are installed parallel to the shore, they should be built with overlapping sections to provide for fish passage between the stillwater zone and the stream. **Live Piling Revetments** consist of two parallel rows of posts (diameter 8-15 cm, length 1-3m, depending on water depth) with 1/3 of their length driven into the streambed (usually working from pontoons). Spacing between posts is 1-1.5 m with 40-70 cm between parallel rows. Packing of 2 m long branches bound into dead fascines (diameter 30-40 cm) is placed onto the streambed diagonally to the rows of posts. The fascines are placed with the tips of branches facing into the flowing water, all in the same direction. Normally, fascines are also placed between the posts, with willow whips inserted between them. Ungalvanized smooth wire (3 – 4 mm) is used to secure fascines. **Live barriers** are constructed by first driving a row of posts to the height of the mean water level parallel to the shore. Then dredge is used to create an underwater earth embankment that is secured by a fascine mattress laid diagonally on the side exposed to the current. The fascines are wired down to wooden pegs and to the posts. At the foot of the embankment, a tubular gabion basket packed with crushed stone is used to protect the toe of the slope. Live willow whips are set into the crest of the embankment to provide long-term protection.

Illustration /Sketch

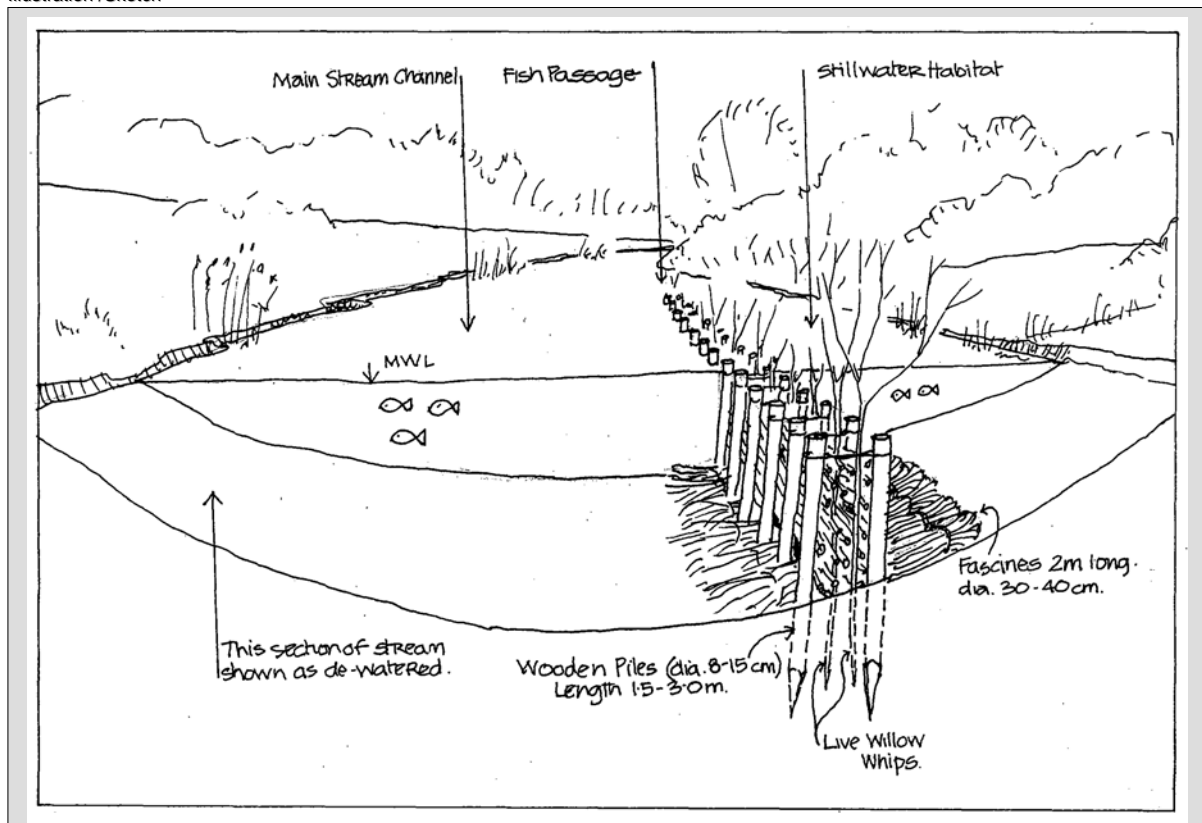



Group No

8.2

Group of measures

**Channel rehabilitation through parallel structures**

Measure name

Live piling revetments, Live barriers

Synonym

Lebende Ufer Lahnung, Lebende Barre

Maintenance

Live piling revetments are more prone to damage than are live barriers and may require repairs or reconstruction. Installations should be inspected after severe storms but little maintenance is normally needed.

Advantages

The roughness of the vegetation in both these measures provides immediate mechanical protection from wave action. They are effective barriers between wave generating boat traffic and recreation areas along waterways

Disadvantages

Measures require considerable amounts of materials for their construction. In rivers with heavy sediment loads both measures may lead to a deposit of sediments in the stillwater zone. This may be intentional and can be an advantage or disadvantage. Measures are not permanent and will eventually require reconstruction.

Examples

Examples

Example Photos

Photos

References and suggested reading

Schiechtl, Hugo M.; Stern, Roland: Handbuch für naturnahen Wasserbau. Eine Anleitung für ingenieurbio-logische Bauweisen. Österreichischer Agrarverlag, Wien 1994;  
Begemann, Wolf; Schiechtl, Hugo M.: Ingenieurbio-logie. Handbuch zum ökologischen Wasser- und Erdbau. Bauverlag, Wiesbaden 1994

Group No

Group of measures

8.3

## Channel rehabilitation through parallel structures

Measure name

Terraced Streambanks

Synonym

Terrassierung

Purpose

To create a stepped streambank above or below water stabilized by vegetation. The risers can be retained by walls, pilings or cribwork. If it is desired to stabilise a steep bank beneath the water along a deep channel, pilings can be driven parallel to an existing structure, backfilled with soil and planted with wetland vegetation.

Applications

A stepped bank may be desirable when access is desired at various levels. This may be vehicular access, or access for pedestrians or cyclists. A terrace might also be suitable for siting an underground sewer which needs vehicular access. Vegetation for terraces should be appropriate for its use and the anticipated frequency of flooding. Each terrace will be subject to different flood frequencies.

Description

The „risers“ of a stepped streambank can be vertical or steeply sloping. The „treads“ will normally have a gentle fall toward the stream. Vertical steps are usually created with steel or timber piling, or gabions. Timber crib walls (see measure 9.8) can also be used. However any of these structures will gradually deteriorate and generally live material cannot stabilize vertical banks effectively. However vegetation can provide long-term protection for steeply sloping banks. Measures suitable for steep slopes include Cribwalls (see measure 9.8), Gabions (see measure 9.11). These can be set at any angle but will normally be 45 degrees or steeper. Slopes that are more than 2m. high are generally not recommended. The lowest terrace slope is most critical as this will withstand most frequent inundation and it is essential that it is founded on a stable footing. Cribwork for instance should begin below streambed level by excavating a trench about 2.0 m. wide and 0.5-1.0 m. deep at the toe of the slope. The trench should be lower toward the outside so the wall will be tilted toward the bank at the desired angle.

Measures for each of the structures mentioned should be consulted for the specific method of placing live material. The choice of plant material will change for each terrace as soil conditions become drier higher on the bank. In the case of woody plants, it may be desirable to use rooted material on upper terraces and when construction cannot take place during the dormant season.

When unrooted cuttings are being used it is essential not only to complete installation before the end of dormancy but to minimize the time between cutting the branches and installation. Branches could be wrapped in moist burlap and a tarpaulin during transportation and while awaiting installation.

Illustration /Sketch

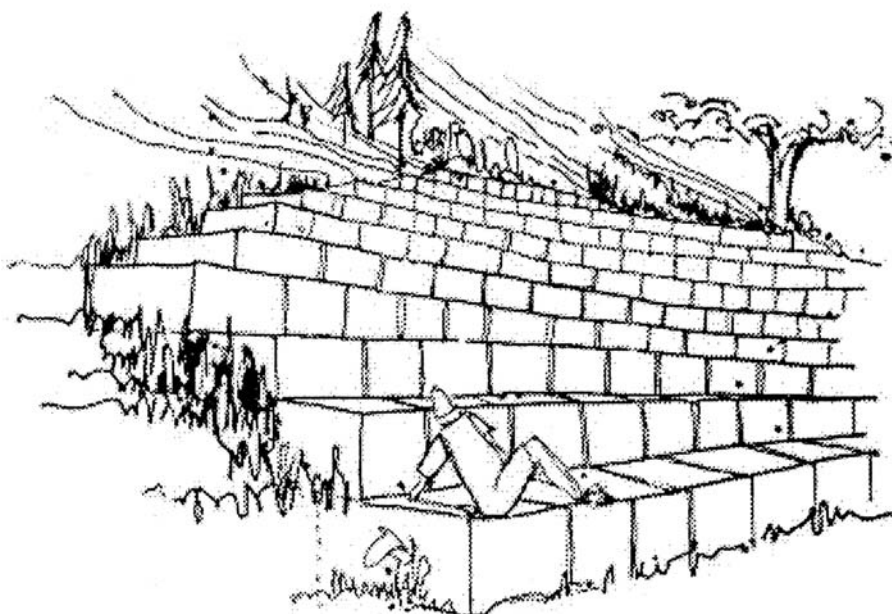

Source: Stream Corridor Restoration Handbook, USDA; The Restoration of Rivers and Streams, Gore, James A.; Engineering Field Handbook, NRSC

Group No

8.3

Group of measures

**Channel rehabilitation through parallel structures**

Measure name

Terraced Streambanks

Synonym

Terrassierung

Maintenance

It is critical that vegetation on terrace slopes continue to perform the function of the structure after the latter begins to lose effectiveness. To be fully effective vegetation must be adapted perfectly to its site and must be kept in a vigorous condition. Shade tolerance is an important factor and an intolerant species may be shaded out by another species or by another individual of the same species. Most grasses for instance are not shade tolerant and will not grow below trees. But nor is willow shade tolerant and will lose vigor or be killed by shade from a larger neighbor. Maintenance therefore may include a regular program of coppicing tree and shrub species (willow or dogwood for instance), mowing grass and occasional fertilizer applications. In addition it is important to repair any damage to slopes as soon as possible. If the level terraces are used for access, vegetation that will withstand wear should be chosen, but if excessive wear is destroying the vegetation the maintenance program must address the problem.

Advantages

Terraced streambanks may be more stable than sloping banks as only the lower bank will be threatened by most high flows. Terracing allows easy access to the streambank for a variety of purposes, including recreation and emergencies.

Disadvantages

Terraced streambanks can have a very artificial appearance. Excessive wear on the terraces may result in erosion during flood events. Vegetation growing on a series of terrace slopes may block views of the stream.

Examples

Photo: seating steps by the Limat River, Zürich, Switzerland  
Designer: Stern Landschaftsarchitekten

References and suggested reading

Example Photos



Group No

Group of measures

8.4

### Channel rehabilitation through parallel structures

Measure name

Branch Packing

Synonym

Packwerk

Purpose

To repair and stabilize eroding streambanks using layers of live branches and compacted soil. USDA (1996, p.16-19 and scrh 36) recommend the measure for slumps and holes ranging from about 0.7-1.3m in height and depth. As the live branches form roots and begin to grow, the structure traps sediment which fills any voids while roots spread throughout the backfill and into the bank to form a unified mass.

For more extensive stabilization projects where the streambank can be regraded to a gentle slope, brush mattresses are effective (see measure 9.7).

Applications

This measure is usually used to repair or stabilize small localized erosion damage rather than extensive lengths of streambank.

A careful assessment should be made whether erosion damage can be repaired effectively or whether the erosive flows need to be diverted away from the susceptible area to prevent the damage recurring.

The measure is suitable to repair damage between the normal and bankful flows when the drainage area is less than about 2000ha. For larger drainage areas use only on damaged near or above bankful stage.

Description

Drive live (dia. About 10cm.) or dead stakes (5X5cm.) 2-3m. long into the streambank in a triangular pattern about 1m. apart. Lay a layer of live branches (dia. 2.0-5.0 cm.) diagonally between the stakes, cover with soil, pack and repeat but laying the next layer of branches to make a criss-cross pattern. Four or more layers of branches and soil are used depending on the size of the hole. Each layer of branches can be laced down with twine from post to post, but the tips of some branches should be allowed to emerge from the final layer of soil. Some species of willow (e.g. Salix helvetica) used as a lower layer of branch packing will extend their roots into the water and trap sediments which build up to form an additional protective toe.

The success rate depends very largely on minimizing the time between cutting branches and installation and correct timing. Branches should be wrapped in moist burlap and a tarpaulin during transportation and while awaiting installation. Rooting of branches will be most successful when harvested and installed a few weeks before leafing.

Illustration /Sketch

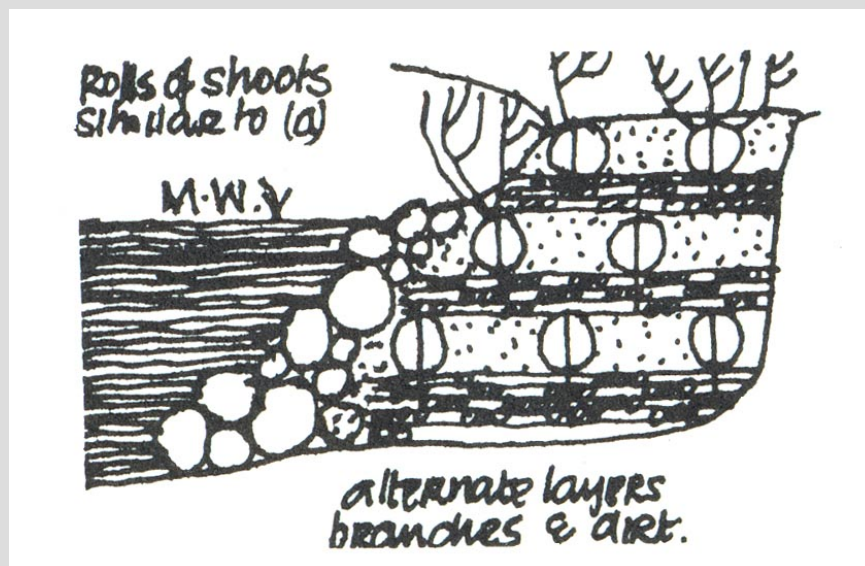

Group No

8.4

Group of measures

**Channel rehabilitation through parallel structures**

Measure name

Branch Packing

Synonym

Packwerk

Maintenance

Branch packing should be maintenance free. Occasional coppicing or harvesting willow branches will keep the stand vigorous and effective. If damage is observed immediately upstream or downstream of the repair, it suggests that the erosive flows that are causing the damage need to be diverted away from the bank.

Advantages

This is a low cost, simple technique. The technique can be easily accomplished using unskilled hand labor and can be used in remote areas inaccessible for machinery. The technique is not highly labor intensive. Installation can be accomplished very rapidly if there is a locally available source of willow branches.

Disadvantages

Repair of erosion damage may simply result in the damage recurring up or downstream. In these cases attention must be given to diverting erosive flows away from the bank or using a measure that protects the whole length of the bank that is impacted with the erosive flows.

Examples

Photos - see photos during installation, after covering with topsoil and after a growing season. USDA 1996, p. 16-21

Example Photos

Photos

References and suggested reading

USDA, 1996. „Streambank and Shoreline Protection“. Chapter 16 from the Engineering Field Handbook. Washington DC.  
Schiechl, Hugo M.; Stern, Roland: Handbuch für naturnahen Wasserbau. Eine Anleitung für ingenieurbiologische Bauweisen. Österreichischer Agrarverlag, Wien 1994;  
Tuttle, Ronald W.: Soil Bioengineering for Upland Slope Protection and Erosion Reduction. In: U.S. Dept. of Agriculture, Soil Conservation Service: Engineering Field Handbook, Chapter 18. Washington 1992;  
Begemann, Wolf; Schiechl, Hugo M.: Ingenieurbiologie. Handbuch zum ökologischen Wasser- und Erdbau. Bauverlag, Wiesbaden 1994; Zeh, Helgard: Ingenieurbiologische Bauweisen, Studienbericht Nr. 4, 1993

Group No

Group of measures

8.5

### Channel rehabilitation through parallel structures

Measure name

Riprap and Vegetated Riprap

Synonym

Stein Berollung

Purpose

Riprap has been used very widely to stabilize streambanks. It can be dumped and then positioned with a backhoe or it can be hand packed. The rock should preferably be quarried locally and be similar to that found locally. By including live vegetation, the role of riprap in providing immediate protection from erosion and dissipating much of the energy of the stream is combined with the role of vegetation in providing long term effectiveness and self-healing capacity. Existing riprap or rock installations can also be vegetated.

Applications

The low cost and simplicity of riprap has made it an attractive solution in low profile situations, where the site can be accessed by heavy dump trucks. Live stakes (see measure 10.4 ) are usually used to vegetate riprap installations. Handpacking will give a more finished appearance but may not be as effective in dissipating energy in the streamflow. Smaller willow cuttings can be inserted as packing proceeds. Live willow stakes can be inserted through existing riprap installations to improve its appearance, habitat characteristics and its long term self healing capacity

Description

The key to the use of riprap is the selection of the correct size of rock. USDA, the US Corps of Engineers and the US Highway Administration use slightly different methods that are summarized in USDA 1996 (p. 16-49). Before placing the rock, the bank should be graded to a uniform slope extending to a trench below streambed level. A geogrid or coarse woven geotextile is layed on the slope and a bedding layer of crusher-run is placed on the geotextile. The minimum thickness of the riprap should exceed the maximum size of the rock. The rock should be of a similar type as that found on the site. Ideally it should be quarried locally (which will reduce transportation costs) but should not be mined from the streambed. If rock of sufficient size is not available, the effective size of smaller rock can be increased by using gabions (see measure 9.11 ). These can also be used in combination with vegetation. Cellular concrete blocks can also be used on slopes of 3(h):1(v) and less, but must be hand placed.

When vegetation is to be used, live stakes (dia. 4 cm. min. length 0.7-1.0m.) are inserted so that about 75% of their length is below the soil. When the stakes are being inserted through riprap a steel bar should be used to probe through the rock, through the geotextile, and into the soil to minimize the damage to the stake. After inserting into the hole prepared with the probe, the stake should be driven with a wooden mallet. It is essential that the stakes have been freshly prepared and should be inserted immediately after preparation. Side branches should be removed cleanly and each stake pointed at its lower end. After insertion any split or frayed ends should be pruned off cleanly.

If the riprap is being hand packed, willow cuttings with smaller diameters can be used and inserted as the packing proceeds. After installation the tops of the cuttings can be pruned to a height of about 10cm. above the riprap.

Illustration /Sketch

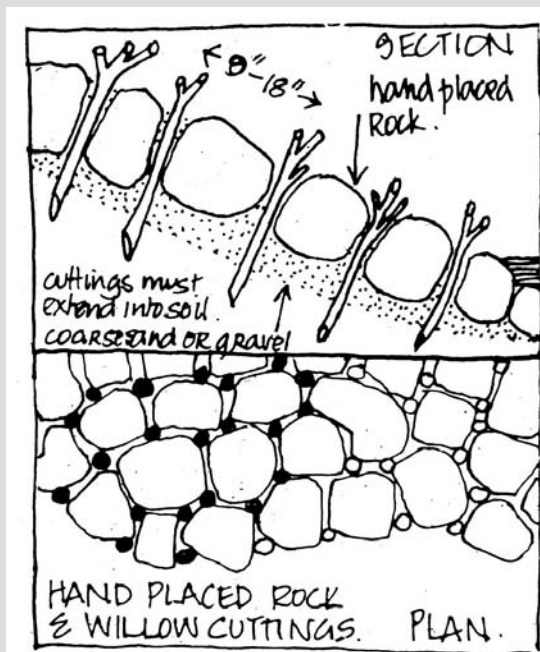

Group No

8.5

Group of measures

**Channel rehabilitation through parallel structures**

Measure name

Riprap and Vegetated Riprap

Synonym

Stein Berollung

Maintenance

If the correct rock size has been used maintenance should not be necessary. However if regular inspections of the installation reveal damage it can be repaired by adding additional riprap. In cases where vegetation has been included in the installation, damage is likely to be self-healing and minimum maintenance should be necessary.

Willow is not shade tolerant and there may be a loss of effectiveness of the measure after adjacent plants begin to shade each other out. Periodic coppicing or even cutting with a tractor mounted hedge trimmer would keep the stand vigorous and effective. However it may be desired to permit a more natural streamside plant community to develop.

Advantages

This measure is simple and low cost. It requires little hand labor unless the riprap is hand packed.

The riprap can effectively dissipate much of the excess energy in the streamflow and at the same time the willow provide long term self healing capability, sediment deposition and habitat improvement.

Disadvantages

Riprap can be very unsightly if vegetation is not used or does not grow well.

Placing riprap can be highly destructive of the riparian environment as it must extend below the streambed to prevent undercutting.

Probing holes to insert stakes through existing or dumped riprap can be time consuming.

If rock is not quarried locally, transportation costs will be high.

Riprap can only be used when the site can be accessed by dump trucks.

Examples

Examples

References and suggested reading

USDA, 1996. „Streambank and Shoreline Protection“. Chapter 16 from the Engineering Field Handbook. Washington DC. Scrh 8, scrh 18

Example Photos

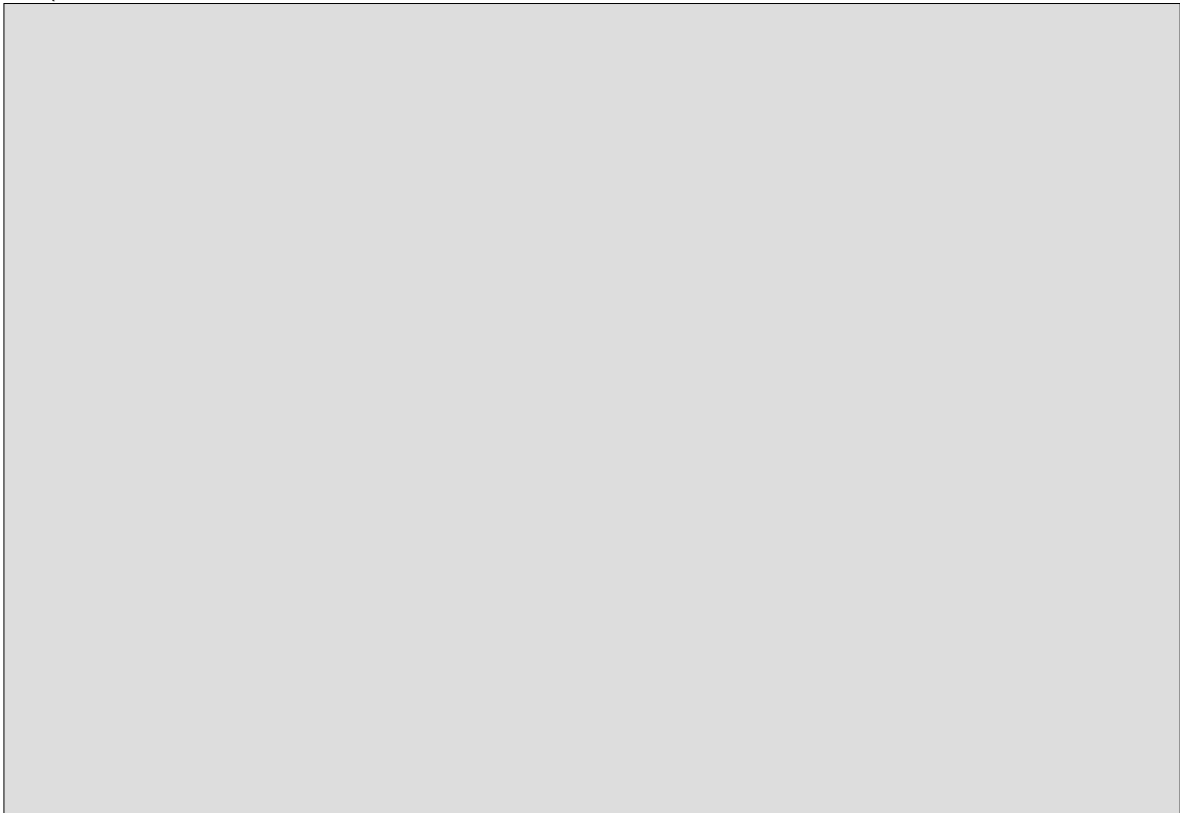

Group No

8.6

Group of measures

## Channel rehabilitation through parallel structures

Measure name

Jacks, Jack Fields, and Tetrahedrons

Synonym

Purpose

Jacks are made of three crossed members of wood, steel or concrete tied together with wire to form a reticulated structure that, when placed on an eroding streambank will trap debris and accumulate sediment. Several jacks are usually installed at one time in a "jack field".

Applications

Jacks are mostly useful to trap debris and build up sediment on long bends in fast flowing streams carrying heavy sediment loads. They can however present a hazard to canoeists and other recreationists in the stream. The hazard can continue for many years. Jacks make access to the streambank difficult and dangerous, and they can also be very unsightly

Description

The members of a jack vary in length from 3m.– 5m. Concrete jacks are usually cast as one piece. The three members of a steel jack are usually welded at the crossing point and may be predrilled for wire. Wooden jacks are best joined with a steel bracket. Square (10cmX10cm) or round timbers (dia.10-15cm) may be used. They are usually preassembled and placed in position parallel to the bank with a back-hoe or front-end loader. If the site is inaccessible wooden jacks can be assembled on site. They are placed almost touching in a continuous line and are cabled together with steel cables (min.dia 1cm.) and these are anchored securely to deadmen buried 1.5m. deep above the streambank upstream and downstream from the installation Dead men should be tree trunks (dia. 0.5m and 2m long). Wooden stakes (dia.10cm. and 2m.long) driven to half their length, are used to anchor each jack to the streambank. A row of jacks requires a width of 3-5m. of reasonably level streamside.

Illustration /Sketch

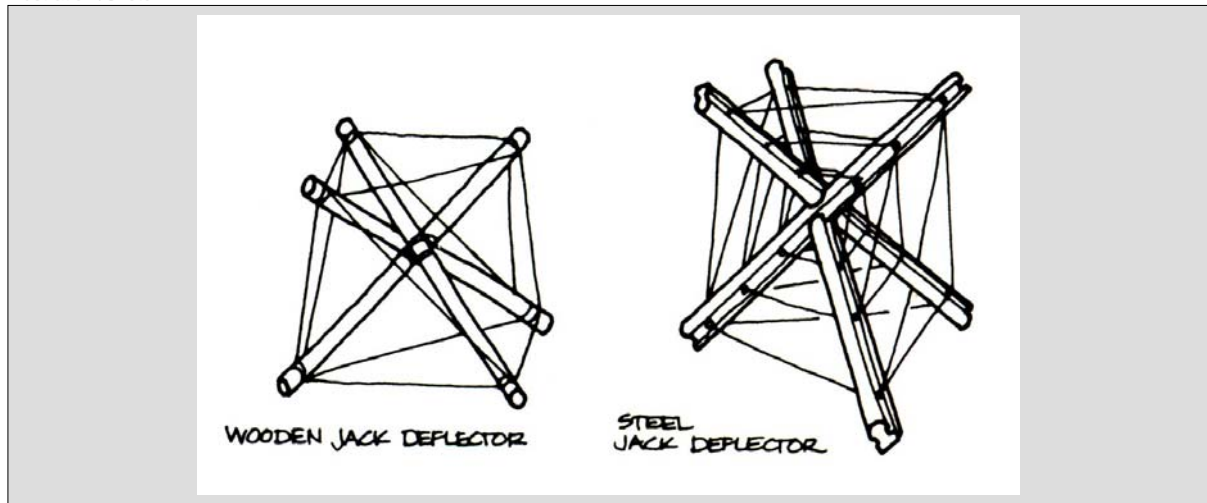



Group No

8.6

Group of measures

**Channel rehabilitation through parallel structures**

Measure name

Jacks, Jack Fields, and Tetrahedrons

Synonym

Maintenance

Jacks should require no maintenance but they are best seen as the first step in streambank stabilization to be followed by subsequent steps to increase the permanence and the self-healing capability of the structure and to reduce its potential hazard and unsightliness. As sediment begins to accumulate biotechnical measures using live materials should be installed. This will result in long term protection of the bank by vegetation. Sections of jacks and wire that remain protruding from the ground after the structure is well vegetated should be cut off.

Advantages

This is a cost effective solution to halt erosion of long bends in fast flowing streams. Jacks can be used at or below water level.

Disadvantages

The hazard to stream users both on the water and on the bank is severe. The measure is unsightly. The measure should be followed up with more permanent and user-friendly techniques.

Examples

Examples

Example Photos

Photos

References and suggested reading

USDA, 1996. „Streambank and Shoreline Protection“. Chapter 16 from the Engineering Field Handbook. Washington DC.  
Tourbier, J. Toby; Westmacott, Richard: Water Resources Protection Technology. A Handbook of Measures to Protect Water Resources in Land Development. ULI- The Urban Land Institute; Washington, D.C. 1981; Schiechtl, Hugo M.; Stern, Roland: Handbuch für naturnahen Wasserbau. Eine Anleitung für ingenieurbio-logische Bauweisen. Österreichischer Agrarverlag, Wien 1994; Patt, Heinz; Jürging, Peter; Kraus, Werner: Naturnaher Wasserbau. Entwicklung und Gestaltung von Fließgewässern. Springer-Verlag, Berlin 1998; Begemann, Wolf; Schiechtl, Hugo M.: Ingenieurbio-logie. Handbuch zu

Group No

Group of measures

9.1

## Point protection and stabilization of streambanks

Measure name

Brush Packing

Synonym

Ausbuschung, Runsenausbuschung

Purpose

To stabilize upper streambanks using live willow branches set on a series of benches. It performs a similar function as a measure known as Vegetated Slope Geogrid Wraps, but is less costly but also less effective.

Applications

This measure offers little mechanical support before the vegetation is established. It is best suited for use on the upper streambank but only when there is sufficient soil moisture to ensure good root development. It is suitable in situations where considerable regrading of the streambanks has occurred.

Description

On cut slopes, live branches (dia.2-4cm. and 2m long) are laid in trenches (1.0-3.0m. apart) running along the contour so that, at any point, three branches are overlapping. The trenches are then backfilled with soil and well compacted so that the tips of the branches are visible. Erosion control fabric can be pegged down with live stakes on the slope between the trenches. On fill slopes, longer branches (up to 4m. long) can be used and placed in layers on benches that have a slight reverse fall into the bank. The branches are placed at right angles to the slope with their tips protruding. Each layer is covered with fill and compacted before the next layer is placed. Schiechl recommends that the branches are placed at an angle to the branches in the layer below (p.160). Schiechl (p.162) also suggests that long stakes can be driven into damaged areas before brushlayers are placed and each layer of brush laced down to these. Dormant posts can be used for the stakes if available.

On slopes that are unstable or susceptible to frequent high velocity flows consider the use of Vegetated Slope Geogrids Wraps. In this measure each layer of fill is wrapped in a geogrid. These "wraps" give additional protection before the vegetation develops roots.

Illustration /Sketch

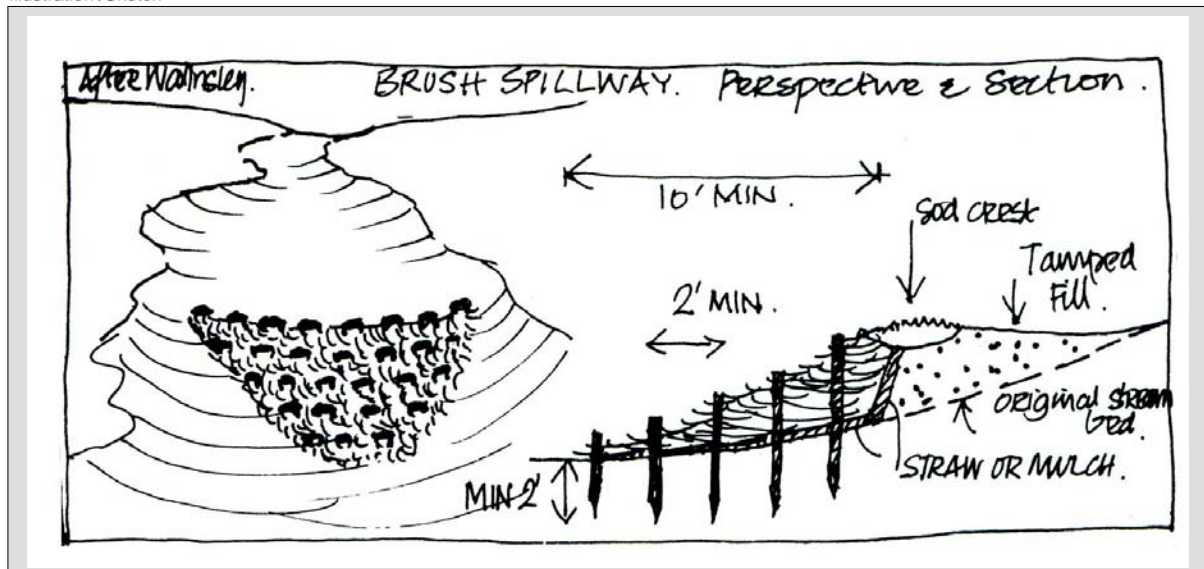

Group No

9.1

Group of measures

**Point protection and stabilization of streambanks**

Measure name

Brush Packing

Synonym

Ausbuschung, Runsenausbuschung

Maintenance

Brushlayers are susceptible to damage before the vegetation is well established. Maintenance may be required during this period. Damage repair will be much easier if most of the vegetation has rooted in which case vigorous shoots can be bent over and pegged down on damaged areas. This technique allows the repair to be made during the same growing season, rather than waiting until the next dormant season. After establishment of vegetation the maintenance priority is to keep it vigorous and effective. Periodic coppicing will help to prevent the willow shading out adjacent plants.

Advantages

This is a low cost measure if plenty of suitable live material is available locally.

Disadvantages

The measure offers very little mechanical protection before the vegetation is established. Because the rooting of live material is so critical, careful scheduling and timing of installation is necessary to ensure effectiveness. Because success is highly dependent on the rate of rooting of the branches, careful handling of live material is essential.

Examples

Examples

Example Photos

Photos

References and suggested reading

Scrh 34  
Schiechtl p.160-162

Schiechtl, Hugo M.; Stern, Roland: Handbuch für naturnahen Wasserbau. Eine Anleitung für ingenieurbiologische Bauweisen. Österreichischer Agrarverlag, Wien 1994;  
Tuttle, Ronald W.: Soil Bioengineering for Upland Slope Protection and Erosion Reduction. In: U.S. Dept. of Agriculture, Soil Conservation Service: Engineering Field Handbook, Chapter 18. Washington 1992;  
Begemann, Wolf; Schiechtl, Hugo M.: Ingenieurbiologie. Handbuch zum ökologischen Wasser- und Erdbau. Bauverlag, Wiesbaden 1994; Zeh, Helgard: Ingenieurbiologische Bauweisen, Studienbericht Nr. 4, 1993.

Group No

Group of measures

9.2

**Point protection and stabilization of streambanks**

Measure name

Live Willow Deflectors

Synonym

Lebende Weidenkämme – Buschbau Traverse

Purpose

To stabilize eroding bends in small streams using a structure of live willow branches and large stones jutting into the current and causing the deposition of sediment.

Schiechtl (p.155) also recommends the use of "live brushlayer barriers" in eroded breaks in the streambank that are not in the main current of the streamflow.

Applications

This measure may be used to prevent bank erosion on bends where bank stabilization is not feasible. It is also useful to deflect erosive currents away from potential damage areas as an alternative to bank stabilization.

The measure is applicable only on small streams where failure of the installation will not result in serious downstream damage

Description

Live willow deflectors are jetty-like structures of stone and sturdy live willow stakes. The deflector points downstream at an angle of about 45 degrees to the bank. The stakes are driven into the streambed with their tops pointing downstream an angle of 30-45 degrees. They are secured with large rock. Deflectors can also be constructed using gabions when rock of sufficient size is not available. The gabions are positioned and stakes driven through the bottom mesh before they are backfilled. After sprouting the willow deflectors will slow down flood flows, leading to the deposition of sediments and stabilization of the stream bend.

USDA also recommend for small streams, "barbs" which are essentially rock sills that project out from the streambank to deflect erosive flows away from an installation or a damaged area, but barbs always point upstream and extend across the stream's thalweg. USDA suggests that biotechnical techniques using live material can be used in combination with rock barbs.

USDA (1996p.16-54) gives details for constructing stone jetties on larger streams, which are usually to protect specific structures such as bridges. It is noted that jetties may be oriented perpendicular to the bank or pointing up or downstream but suggest that a fluvial geomorphologist should be consulted for the detailed design. USDA also suggests that stone jetties can be used in combination with biotechnical techniques using live material. USDA recommends that the size of rock be determined by determining the size needed for riprap at bankfull stage (see measure 8.5) and doubling it.

Illustration /Sketch

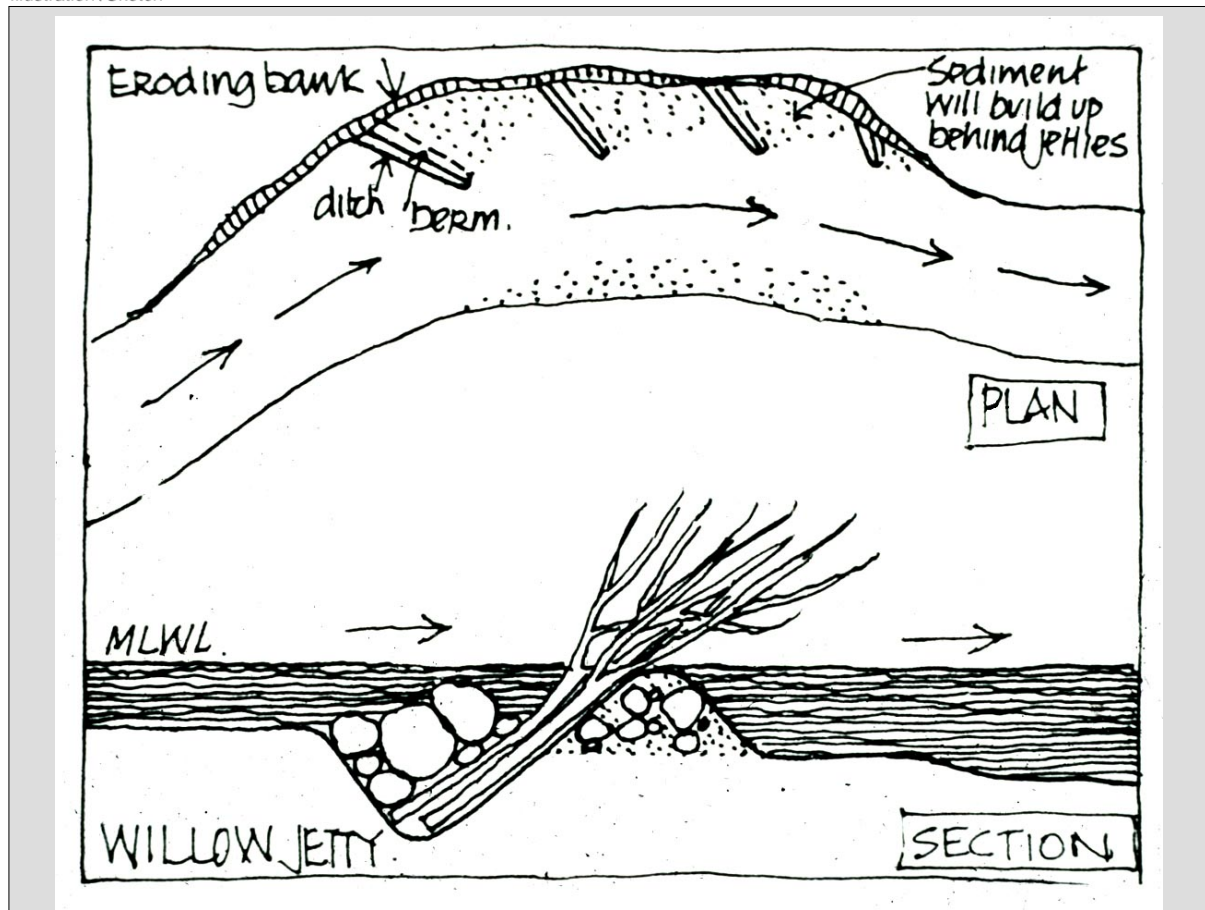

Group No

9.2

Group of measures

**Point protection and stabilization of streambanks**

Measure name

Live Willow Deflectors

Synonym

Lebende Weidenkämme – Buschbau Traverse

Maintenance

Unless properly designed deflectors and jetties can be severely damaged by flood flows and exacerbate problems elsewhere. The use of live material, particularly to stabilize the junction between the structure and the bank can reduce maintenance.

A program to use live material to stabilize accumulations of sediment as they occur can effectively lengthen the life and increase the effectiveness of a structure.

Advantages

Deflectors and jetties can be useful to deflect erosive flows away from hazardous areas when bank treatment is impractical.

The structures can create pools and resting places for fish and generally improve fish habitat.

Disadvantages

Jetties on larger streams are complex and expensive to design, and can be hazardous if not properly installed.

Structures can be hazardous for boaters and canoeists when covered by high flows

Examples

Examples

Example Photos

Photos

References and suggested reading

USDA, 1996. "Streambank and Shoreline Protection". Chapter 16 from the Engineering Field Handbook. Washington DC.

Schiechtl (p.155 "live brushlayer barriers")

Group No

Group of measures

9.3

### Point protection and stabilization of streambanks

Measure name

Live Slope Gratings, Timber Framing

Synonym

Lebende Hangroste

Purpose

A framework of timbers placed against a regraded slope gives protection from erosion while live material becomes established.

Applications

This measure is sometimes used to stabilize highway embankments but is rarely along streams and then only on very steep sections of the upper streambank where extensive regrading has occurred.  
The measure is not suitable for use on sections of bank subject to frequent high flows.

Description

A lattice framework of 5cm.X 10cm. timber on edge is assembled with square cells (0.5-1m.) This is placed on the slope which should have been carefully graded to allow the frame to lie flat the soil. The frame is secured by nailing to wooden pegs at alternate intersections. The cells are then filled with topsoil and seeded. A jute erosion control fabric is spread and stapled to the framework. Live cuttings of woody plants can be inserted through the jute fabric into the bank and/or rooted sprigs of ground cover plants. The correct timing of installation and handling of live materials is essential for success of the vegetation.

Illustration /Sketch

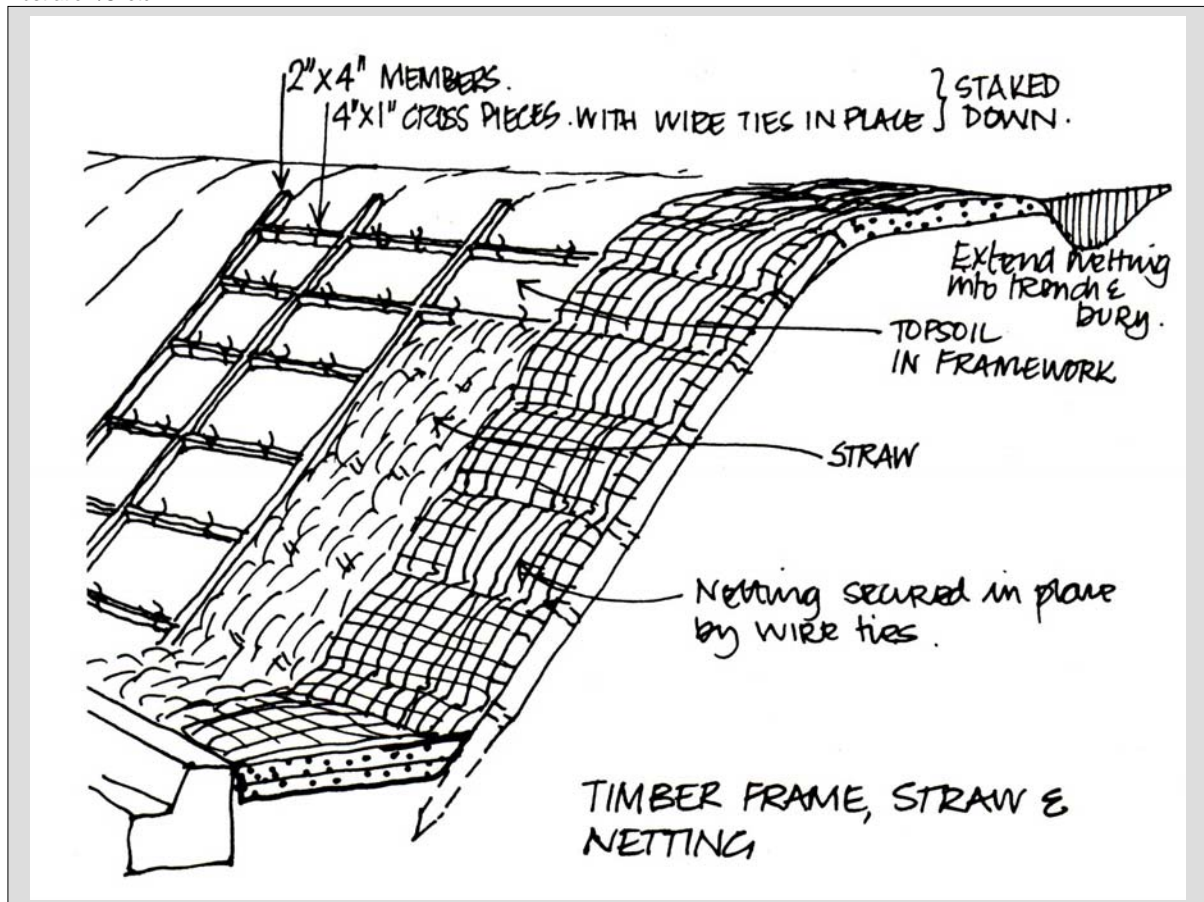

Group No

9.3

Group of measures

**Point protection and stabilization of streambanks**

Measure name

Live Slope Gratings, Timber Framing

Synonym

Lebende Hangroste

Maintenance

If properly installed the measure should provide maintenance free protection for the slope. The measure will generally be used only on slopes that are too steep to mow and the long term protection will be given by woody vegetation and or groundcovers. Some management of the woody species may be required if shading is excessive. Periodic coppicing of species such as willow and dogwood may be needed.

Advantages

Good protection from erosion is provided by the timber framework.

Disadvantages

Installation requires extensive and precise grading.  
The measure is expensive to install and there are other options (brush mattresses, measure 9.7) that give similar results at lower cost and without so much grading.  
The measure cannot withstand high velocity streamflows and is suitable for use only on the upper stream bank.

Examples

Photo: Demonstration at the „Landesgartenschau Sachsen“ in Lichtenstein, Germany

References and suggested reading

SCRH 26  
T&W Sheet 2:15

Example Photos



Wing deflectors divert erosive currents away from an eroding streambank. This can result in deepening the channel opposite and create a pool and improve fish habitat. If a series of deflectors are used they will promote deposition of sediment between the structures. Deflectors may be used to direct flow to the center of the stream causing it to deepen its channel and to establish its course. Deflectors may be only one log in height or can be constructed of cribwork upto 4 logs in height.

This is a measure appropriate only on small streams (less than 5m. wide) either to prevent bank erosion or to improve fish habitat. The deflectors should not be used if washout could seriously exacerbate flood damage downstream. On larger streams jetties or barbs (see measure 9.2) are more suitable to divert erosive flows.

Wing deflectors are triangular cribwork structures. They are installed to jut out from the bank into the streamflow to divert currents. The purpose may be to divert flow away from an eroding bank, or it may be to direct flows towards the opposite bank to scour the bed and form a pool. It is sometimes recommended to anchor a log or series of logs against the opposite bank to provide cover for fish (scrh 17). Cribwork should be constructed of logs (min. dia. 0.3m.). If the deflector is only one log high, the logs should extend to half their length into the streambank. At the apex of the triangle one log should be notched and the joint secured with 1.5 cm. rebar. On the upstream side another log should be placed behind the first. The structure should be secured to the bed of the stream with 1.0m. lengths of rebar driven through the logs (predrill the holes). The triangular space should be filled with large rock and live stakes inserted through the rock (see measure 10.4) into the stream bed below. Live material should be used to reinforce the point at which the deflector meets the bank. If the cribwork is to be several logs high, the bank should be cut back to allow a third log to form a complete triangle. The logs can be overlapped vertically and secured with rebar. The sides of the cribwork should be lined with woven fabric geotextile and filled with rock and soil below normal flow level. Above normal flow level backfill should be soil. The excess width of geofabric should then be laced together over the deflector and then punctured to allow the insertion of live stakes. On long eroding bends deflectors can be installed in a series in which case the first deflector should be kept short and the next deflectors increase gradually in length. Sediment will tend to build up in the protected areas between deflectors and can be stabilized with live stakes or other biotechnical measures.

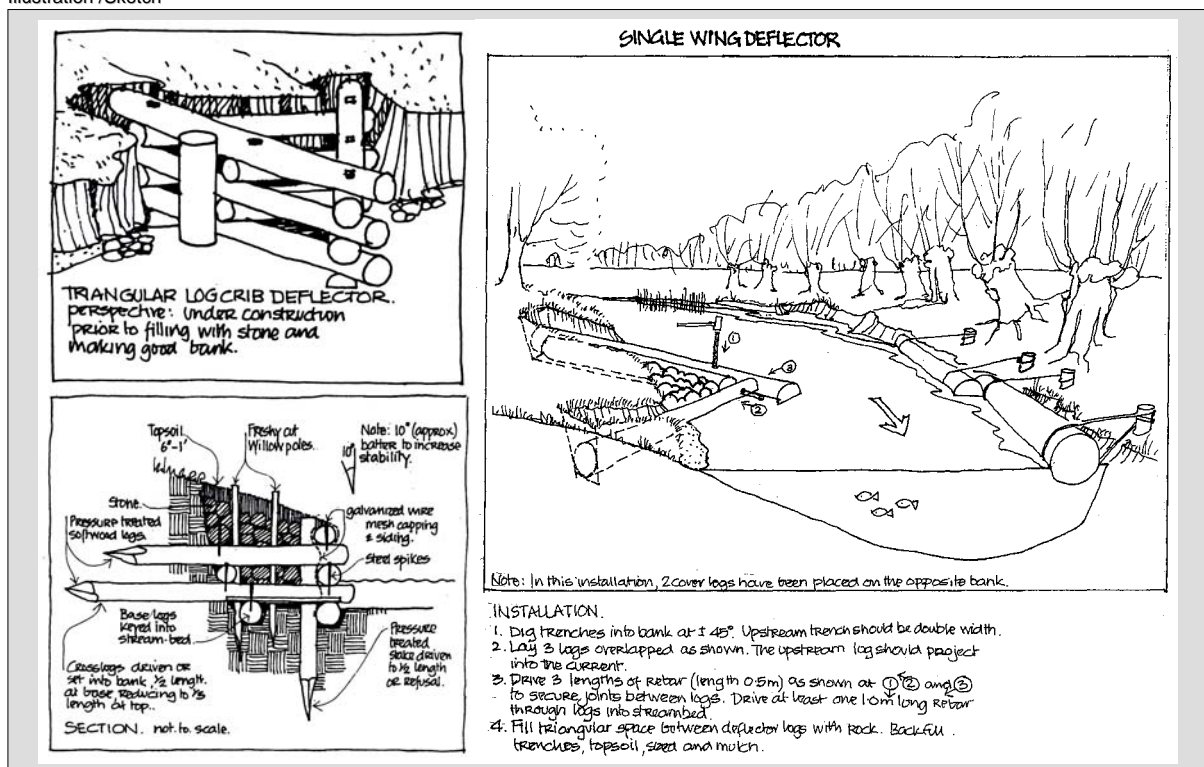



Group No

9.4

Group of measures

**Point protection and stabilization of streambanks**

Measure name

Wing Deflectors

Synonym

Buhnen

Maintenance

Deflectors are not high cost structures designed to solve major problems but rather to make minor adjustments to correct minor erosion problems or to improve habitat. The stream's behaviour should be constantly observed by the manager. If a deflector is not performing as anticipated it should be removed or modified. If sediment is building up in desired locations, live materials should be used to stabilize it. If the growth of live material is being seriously inhibited by shade from riparian vegetation, selective coppicing should be practiced. The aim of maintenance and management should be for vegetation to take over the role of the deflector as the logs deteriorate.

Advantages

Deflectors are low cost structures designed to make minor adjustments to steamflow in order to correct erosion problems or to improve habitat.  
They are easy to adapt and modify with changing stream behaviour

Disadvantages

Deflectors should be used only on small streams and are generally unsuitable for streams with deeply incised channels.

Examples

Photo source:  
In Stream Corridor Restoration: Principles, Processes, and Practices, 10/98.  
Interagency Stream Restoration Working Group (FISR WG)(15 Federal agencies of the US).

References and suggested reading

Scr 17  
Tourbier, J. Toby; Westmacott, Richard: Water Resources Protection Technology. A Handbook of Measures to Protect Water Resources in Land Development. ULI- The Urban Land Institute; Washington, D.C. 1981; Schiechl, Hugo M.; Stern, Roland: Handbuch für naturnahen Wasserbau. Eine Anleitung für ingenieurbioologische Bauweisen. Österreichischer Agrarverlag, Wien 1994; Patt, Heinz; Jürging, Peter; Kraus, Werner: Naturnaher Wasserbau. Entwicklung und Gestaltung von Fließgewässern. Springer-Verlag, Berlin 1998; Begemann, Wolf; Schiechl, Hugo M.: Ingenieurbioologie. Handbuch zum ökologischen Wasser- und Erdbau.

Example Photos



## Purpose

To protect and stabilize streambanks by diverting erosive flows away from susceptible banks using buried tree trunks with their rootwads still attached and protruding into the stream. Exposed roots slow the flow of water, trap sediments, and create in-stream habitat for fish spawning and rearing.

## Applications

This is a low cost measure if the site is accessible for heavy machinery. The measure can be unsightly unless carefully installed and is generally most suitable for rural sites. The technique is useful in deeper streams and especially when it is desired to increase the diversity of habitat for fish. The structure will resist high stream velocities if properly anchored.

## Description

Tree trunks are buried in the streambank at 90 degrees to the direction of flow with their rootwads exposed underwater. Tree trunks (min. dia. 0.5m) should be up to 4m. long, and weighed down with boulders 1.5 times their diameter. USDA (1996, p. 16-37) recommend the use of a footer log placed parallel to the streamflow in a trench excavated to below streambed level. It is also noted that, if suitable boulders are not available to weigh down the footer log and the rootwads, rebar can be used to anchor the footer log to the streambed and cables can be used to anchor the rootwads to the footer and to deadmen in the upper streambank (see measure 9.6). After placement of the rootwads and boulders the structure should be backfilled. This backfill should be stabilized using live materials such as live stakes (see measure 10.4) or branch packing (see measure 8.4) which will increase the long-term effectiveness and self-healing capacity of the structure.

## Illustration /Sketch

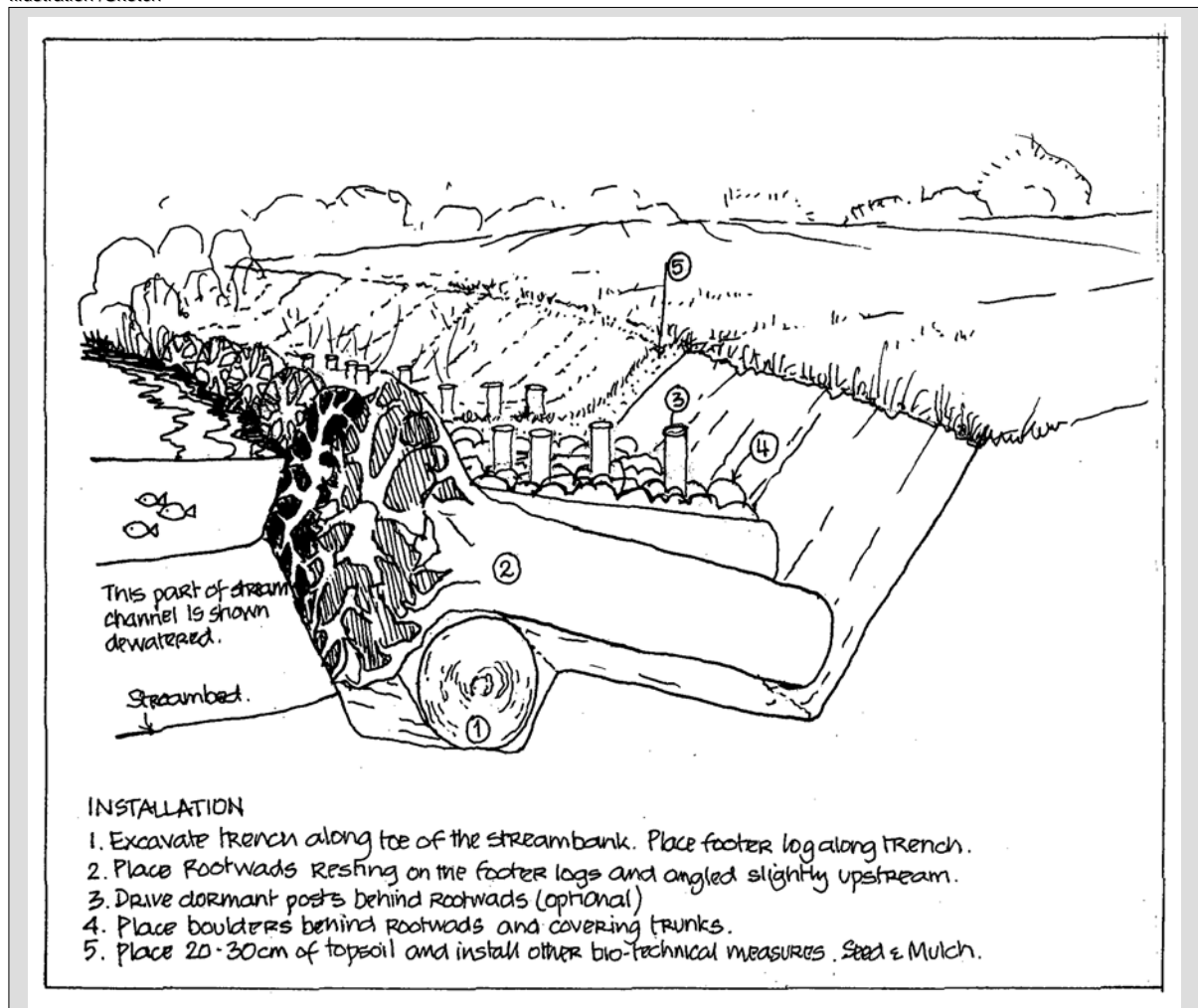

Group No

9.5

Group of measures

**Point protection and stabilization of streambanks**

Measure name

Rootwad and Boulder Revetment

Synonym

Wurzelkneul und Steinverkleidung

Maintenance

If species of willow or sometimes poplar have been used for rootwads, they may root and become permanent. However, it is difficult to find willow rootwads that are sufficiently large. Most root wads will gradually deteriorate and unless the structure is stabilized with live materials that will take root it will be susceptible to future damage and require costly maintenance.

Advantages

Rootwads are low cost, low labor intensity installations that can be used to repair seriously eroding banks of fast flowing streams in rural areas. They can significantly increase habitat diversity for fish.

Disadvantages

If rootwads are not available on site the feasibility of the measure is doubtful. The installation can be quite unsightly unless the rootwads are carefully placed. If heavy machinery cannot access the site the measure is not feasible. If steel cables are used they can be a long-term hazard to stream users

Examples

Photos: Installation of logs with intact rootwads and complete system after two years.  
Source: In Stream Corridor Restoration: Principles, Processes, and Practices, 10/98. Interagency Stream Restoration Working Group (FISR WG)(15 Federal agencies of the US).

References and suggested reading

USDA, 1996. „Streambank and Shoreline Protection“. Chapter 16 from the Engineering Field Handbook. Washington DC. Scrh 25

Example Photos

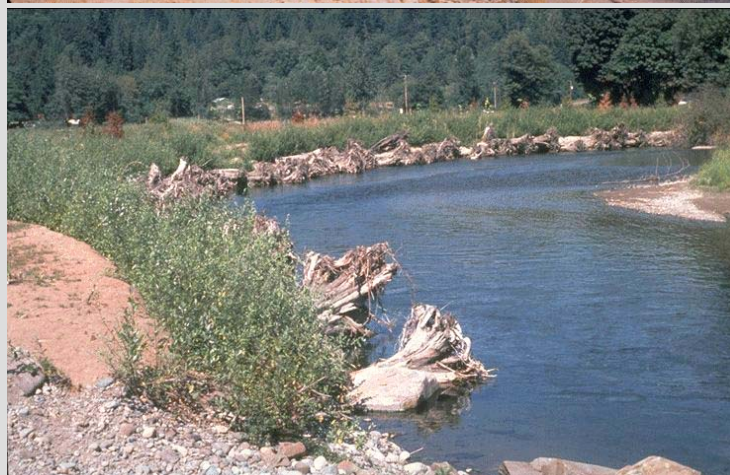

A series of whole trees, securely anchored to deadmen buried in the upper streambank, are placed with the bases of their trunks pointing upstream along eroding sections of streambanks. This will protect the eroding bank and result in sediment accumulation. Large live stakes (see measure 10.4) can be driven into the bank before tree placement. These will increase the permanence of the structure and can be used to lash down tree branches. Can be used effectively in combination with smaller live stakes (see measure 10.4) to stabilize sediment after it has begun to accumulate.

Useful for repairing eroding bends on streams in low profile situations in rural areas where suitable trees are available on site. The site must be accessible for heavy machinery which is necessary for installation. The most suitable trees will have a caliper of 0.3 - 0.4 m with a dense branch system. Preferably tree limbs should not be brittle or they may be broken off by machinery during installation.

Trees with calipers 0.3 - 0.4m. and dense branching systems are selected on site, cut and skidded to the streambank. Trees are placed starting at the downstream end of the damaged section, with the top of the tree downstream. If large live stakes (dia. 10-20 cm. and 3.0m. long) are being used, drive these into the bank at 2 m. spacing leaving about 2 m above ground. A steel cable (dia. 1.0 cm) is secured from the butt end of the tree to a deadman anchor buried in the upper streambank. Another cable should be attached about halfway up the trunk of the tree. Deadmen should be heavy sections of tree trunk (min. dia. 0.4m. and 1.5-2.0m long) placed in trenches parallel to the stream 1.5m deep and covered in well compacted fill. It is necessary to cut a narrow trench to accommodate the cable. Up to four cables may be attached to each deadman and tightened with turnbuckles. NRCS suggest connecting up to four cables to one heavy cable running to the deadman. Each subsequent tree should be overlapped with the previous tree (by one half if serious scour is occurring) working towards the upstream end of the damaged section. Pack down the branches gently using a backhoe bucket and lash the trees together (and to the live stakes if being used) using nylon rope. The whole process can be repeated so that the packed trees reach to the top of the streambank. Drive the stakes about 0.3 m. deeper after lashing down the trees. Do not attempt to place any fill over the structure. Sediment will immediately begin to accumulate among the branches. If it is feasible, small live stakes may be driven into the sediment as it accumulates, which will increase the permanence and self healing capacity of the structure. Although installations using small caliper trees (min. dia. 5cm) and hand labor are feasible, they are not as effective as measures using live materials.

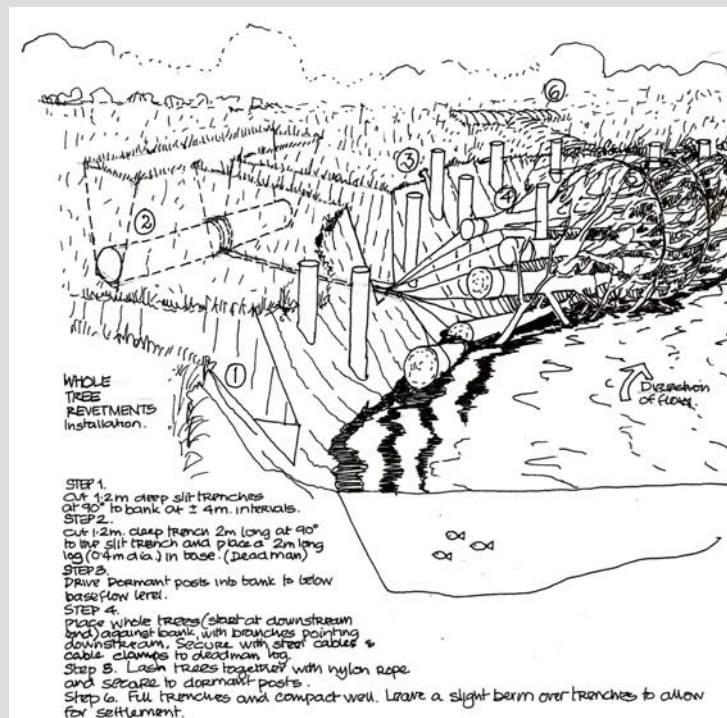

Group No

9.6

Group of measures

**Point protection and stabilization of streambanks**

Measure name

Whole Tree Revetment

Synonym

Rauhbaum

Maintenance

This installation is constructed from dead material which will deteriorate. If sediment accumulation has occurred and has had sufficient time to be stabilized with riparian vegetation, damage may not recur. The susceptibility of damage recurring can be reduced by the use of large live stakes during installation, and by driving smaller live stakes (see measure 10.4) into the sediment as it accumulates. Spot treatment using branch packing (see measure 8.4) can also be used to repair small damaged sections. By encouraging the stabilization of sediment with live materials as it accumulates the permanence and self-healing capability of the structure is enhanced, and maintenance reduced.

If no measures are taken using live materials to permanently stabilize the structure there is a risk that it will be washed out as it deteriorates leaving a tangle of steel cables, and the whole structure will have to be replaced.

Advantages

Tree revetments are low cost, low labor intensity installations that can be used to repair seriously eroding streambanks in low profile situations in rural areas

Disadvantages

If trees are not available on site the feasibility of the measure is doubtful.  
 The installation can be quite unsightly unless the trees are carefully placed.  
 The measure is not suitable for streams used for recreation as there is a potential hazard of entanglement in cables and rope.  
 If heavy machinery cannot access the site the measure is not feasible.

Examples

Examples

Example Photos

Photos

References and suggested reading

USDA, 1996. „Streambank and Shoreline Protection“. Chapter 16 from the Engineering Field Handbook. Washington DC. Scrh 14

NRCS Elberton (call for full reference)

Schiechtl, Hugo M.; Stern, Roland: Handbuch für naturnahen Wasserbau. Eine Anleitung für ingenieurbioologische Bauweisen. Österreichischer Agrarverlag, Wien 1994; Tuttle, Ronald W.: Soil Bioengineering for Upland Slope Protection and Erosion Reduction. In: U.S. Dept. of Agriculture, Soil Conservation Service: Engineering Field Handbook, Chapter 18. Washington 1992; Begemann, Wolf; Schiechtl, Hugo M.: Ingenieurbioogie. Handbuch zum ökologischen Wasser- und Erdbau. Bauverlag,

Group No

Group of measures

9.7

### Point protection and stabilization of streambanks

Measure name

Brush Mattresses

Synonym

Weiden Spreitlage

Purpose

A thick layer of live branches staked and wired down to protect gently sloping streambanks from erosion. The measure is sometimes used in combination with fascines (see measure 8.4) and live stakes (see measure 10.4). A brush mattress gives temporary mechanical protection during establishment and, after rooting the branches give long term protection.

Applications

Most useful where the streambank can be graded to a uniform 3(h):1(v) slope. The measure can be used on fast flowing streams above normal streamflow level and extend to above the bankful level. A plentiful local source of suitable willow branches is a great advantage.

Description

Brush mattresses are thick layers of live branch cuttings 1.50 m to 3 m. long and about 2cm in diameter placed to cover and protect streambanks. Banks should be graded to a uniform slope of about 3:1. A trench should be excavated from about the mean streamflow level to below the streambed. Live stakes (dia. 4-5cm and 0.7m long) should be driven into the surface of the slope in a triangular pattern about 0.5 -1.0m apart and to half their length. One or two layers of branches are placed on the slope at right angles to the contours and with their lower ends in the trench at the toe of the slope. A layer of riprap 0.5m. thick is placed in the trench covering the lower ends of the branches. The mattress is wired down securely to the stakes using binding wire or smooth wire. After wiring the branches down the stakes can be driven into the slope to about 75% of their lengths. This will tighten down the whole installation. The branches should then be covered with a thin layer of soil to enhance ground contact but smaller branches should be allowed to protrude. USDA (1996 p.16-30) recommends that the toe of the mattress be protected with a live fascine (Measure 9.9). This would be placed in a trench over the lower ends of the branches, and staked down securely. The successful rooting of the live branches depends very largely on minimizing the time between cutting branches and installation and correct timing. Branches should be wrapped in moist burlap and a tarpaulin during transportation and while awaiting installation. Rooting of branches will be most successful when harvested and installed a few weeks before leafing.

Illustration /Sketch

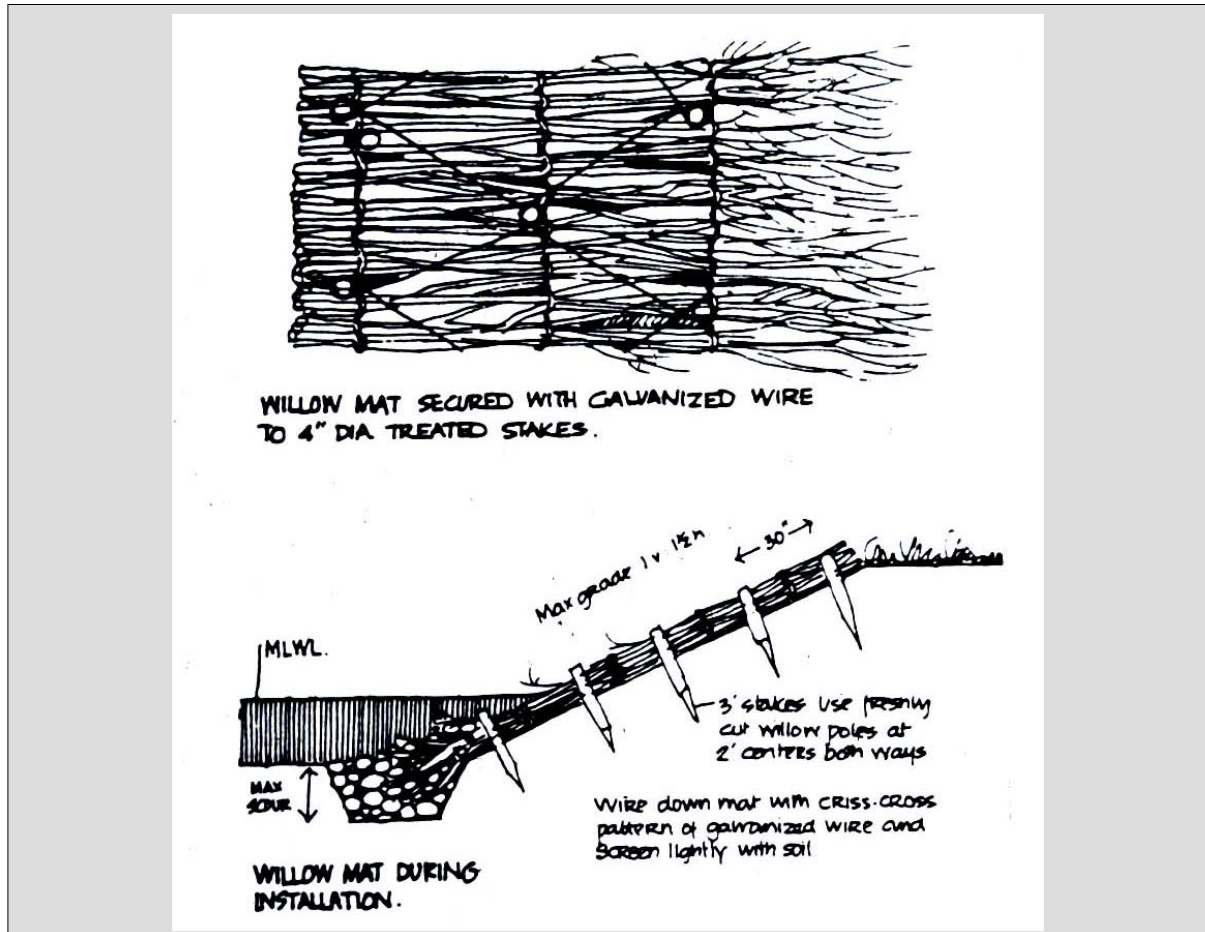

Group No

9.7

Group of measures

**Point protection and stabilization of streambanks**

Measure name

Brush Mattresses

Synonym

Weiden Spreitlage

Maintenance

If live branches root and grow vigorously the installation should be self-healing and require little maintenance. If gaps in the protective stand are observed, adjacent vigorous willow branches can be bent over and lashed down to live stakes to heal the scar. This can be done during the growing season. Willow is not shade tolerant and there may be a loss of effectiveness of the measure after adjacent plants begin to shade each other out. Periodic coppicing or even cutting with a tractor mounted hedge trimmer would keep the stand vigorous and effective.

Advantages

Brush mattresses are extremely effective even on fast flowing streams especially when the bank can be regraded to a uniform slope. After rooting, the installation becomes largely self-healing if damage does occur, and will result in accumulation of sediment. The willow will also dry out wet patches on the bank.

Disadvantages

Because successful rooting of live branches depends so much on timing (towards the end of dormancy but before leafing), a major constraint is imposed on this and all other all measures using live materials. The measure requires a plentiful supply of live branches which should preferably be available locally. Slopes should not exceed 2(h):1(v)

Examples

Photo: Brush mattress and plantings after spring runoff, Winooski River, VT  
Source: In Stream Corridor Restoration: Principles, Processes, and Practices, 10/98. Interagency Stream Restoration Working Group (FISR WG)(15 Federal agencies of the US).

References and suggested reading

USDA, 1996. „Streambank and Shoreline Protection“. Chapter 16 from the Engineering Field Handbook. Washington DC.  
Schiechtl, Hugo M.; Stern, Roland: Handbuch für naturnahen Wasserbau. Eine Anleitung für ingenieurbioologische Bauweisen. Österreichischer Agrarverlag, Wien 1994; Begemann, Wolf; Schiechtl, Hugo M.: Ingenieurbioologie. Handbuch zum ökologischen Wasser- und Erdbau. Bauverlag, Wiesbaden 1994; Zeh, Helgard: Ingenieurbioologische Bauweisen, Studienbericht Nr. 4, 1993. Eidgenössisches Verkehrs- und Energiedepartement, Bundesamt für Wasserwirtschaft, Bern 1993.

Example Photos



Group No

Group of measures

9.8

### Point protection and stabilization of streambanks

Measure name

Live Cribwalls

Synonym

Krainer-Wand, Holzgrünschwelle

Purpose

To protect and stabilize steep streambanks from erosion using chambers of interlocking logs filled with alternating layers of soil and live branches creating a nearly vertical wall with a slight incline. As the structural function of the cribwork gradually deteriorates, the bank is stabilized by the rooted vegetation.

Applications

Live cribwalls can be used to stabilize or rebuild streambanks where a near vertical slope is required. The measure is often used to stabilize critical sections of streambanks from the streambed to bankfull level. It can be used on the upper slopes, if a stable footing can be established. The complexity and expense of the measure tends to limit its use to critical areas such as the outside of bends where space is a limitation. Cribwalls can be used to create a terrace or series of terraces on a sloping site to improve access for pedestrians or vehicles (see measure 8.3)

Description

The structure of a live cribwall is made of dead materials, usually logs (dia. 10 -15 cm.) or square timbers (10 X10 cm.), secured by drilling and driving 20 cm. lengths of rebar. The cribwork should begin below streambed level by excavating a trench about 2.0 m. wide and 0.5-1.0 m. deep at the toe of the slope. The trench should be lower toward the outside so the wall will be tilted toward the bank at the desired angle. Two rows of timbers should be laid parallel, 1.5m. apart along the length of the trench. Cross timbers 2.0 m. long are then laid crosswise, spaced 1.5m. apart and secured with rebar. Repeat this process building up a series of cells. Backfill the structure with rock (dia. 10 cm.) up to the low flow level. Lay the first layer of live branches (2.0 m. long) with their cut ends against the cut slope and the tips protruding from the face of the cribwork. Backfill with a mixture of rock. Lay the second layer of live branches protruding from the next higher opening in the cribwork and backfill with soil and keep repeating the process until the desired bank height is reached. The total height of the wall should not exceed 2 m. Grade the bank over the top of the cribwork to blend with the existing contours and lay erosion control fabric over the disturbed area. Live stakes (measure 10.4) may be inserted through the fabric into the soil if desired. A series of parallel cribwalls may be appropriate to stabilize long banks or where a terraced effect is desired. The timing of any installation using live material is critical. Harvest and installation must occur in the dormant season in early spring. It is essential to minimize the time between cutting the willow branches and installation. Branches could be wrapped in moist burlap and a tarpaulin during transportation and while awaiting installation.

Illustration /Sketch

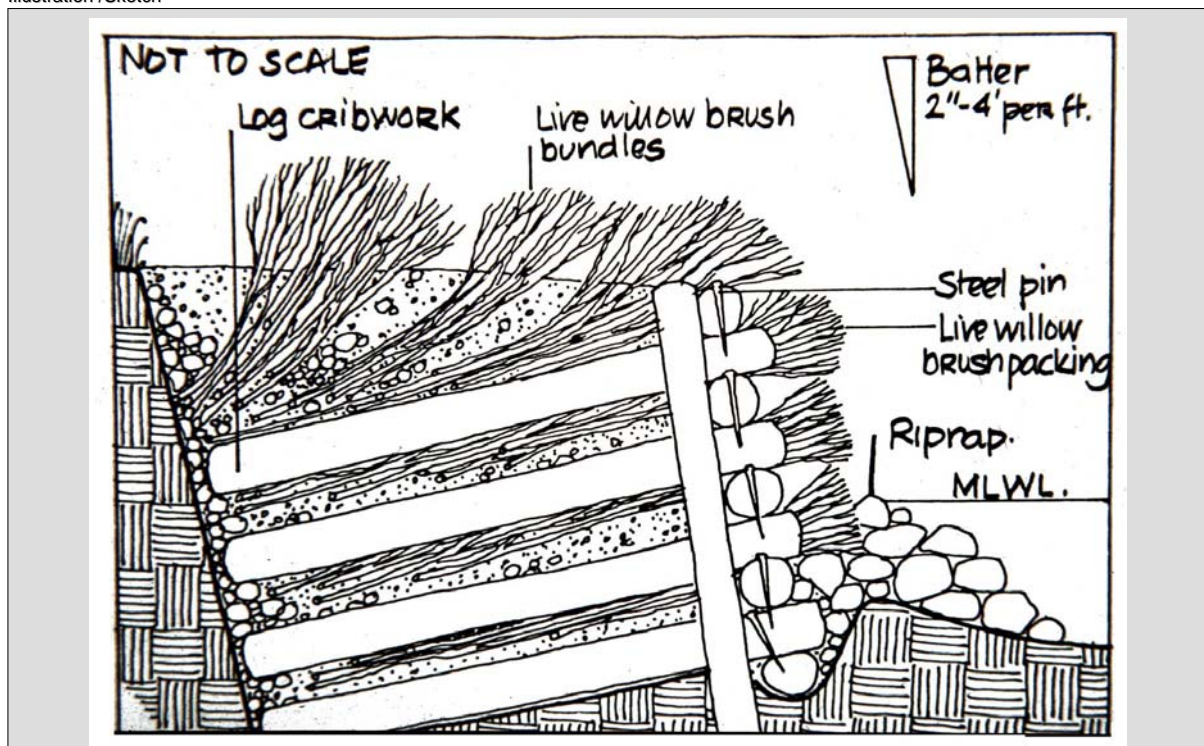



Group No

9.8

Group of measures

**Point protection and stabilization of streambanks**

Measure name

Live Cribwalls

Synonym

Krainer-Wand, Holzgrüenschwelle

Maintenance

This measure normally requires little maintenance. If the branches root and grow vigorously, it will become a self-healing structure as the structural timbers deteriorate and if damage does occur. But because this measure tends to be used only in critical highly erodible areas, it should be inspected frequently for damage. Willow is not shade tolerant and there may be a loss of effectiveness of the measure after adjacent plants begin to shade each other out. Periodic coppicing would keep the stand vigorous and effective. Where breaks in the stand occur, young willows growing adjacent can be bent over and lashed down to help heal the scar. This can be done during the growing season.

Advantages

The measure can be used to stabilize near vertical banks, and is useful when space is limited. Cribwalls are effective for fast flowing streams and on critical bends. Crib walls provide good protection immediately following installation, but effectiveness increases as live branches develop roots even after the structural timbers begin to deteriorate. Growth of the willow branches will also increase the build up of sediment and will remove excess soil moisture from the streambank.

Disadvantages

The high expense and labor intensity of this measure limits its use to critically steep banks. The measure can only be installed during low flows.

Examples

Live cribwall greened one year after installation  
Photo: Robin B. Sotir & Associates, Inc.  
Marietta, Georgia, USA

Example Photos



References and suggested reading

USDA, 1996. „Streambank and Shoreline Protection“. Chapter 16 from the Engineering Field Handbook. Washington, DC. Scrh 29  
Schiechtl, Hugo M.; Stern, Roland: Handbuch für naturnahen Wasserbau. Eine Anleitung für ingenieurbioologische Bauweisen. Österreichischer Agrarverlag, Wien 1994;  
Tuttle, Ronald W.: Soil Bioengineering for Upland Slope Protection and Erosion Reduction. In: U.S. Dept. of Agriculture, Soil Conservation Service: Engineering Field Handbook, Chapter 18. Washington 1992;  
Begemann, Wolf; Schiechtl, Hugo M.: Ingenieurbioologie . Handbuch zum ökologischen Wasser- und Erdbau. Bauverlag,

Group No

9.9

Group of measures

## Point protection and stabilization of streambanks

Measure name

Live Fascines

Synonym

Lebendfaschinen

Purpose

Elongated, sausage-like bundles of live branches are placed in shallow trenches, partly covered with soil, and staked in place to arrest erosion and shallow bank slippage. A series of fascines are often used in parallel. The branches are expected to root forming continuous living erosion barriers along streambanks that will extract soil moisture, and trap silt and debris.

Applications

USDA (1996, p.16-16) recommend that this measure be used above bankful stage except for sites with very small drainage areas. The measure can be highly effective below bankful stage but above the normal flow where the drainage area is less than about 1000 ha. It is resistant to damage even before the branches take root. The measure is useful in situations where either erosion or slope slippage is anticipated.

Description

Bundles of willow branches, 15-20 cm. in diameter are overlapped and bound with twine to form long (1.5-3.0m) cylinders. These are placed in parallel trenches running along the bank spaced 1-2m. apart depending on susceptibility to erosion. SCRH 28 also recommends alder, or shrub dogwood (such as *Cornus alba* or *C. stolonifera*), but these species do not root as easily as willow. USDA (1996,p.16-16) recommend the trenches are horizontal on dry sites and gently sloping on wet banks.

The size of the trench should be sufficient to allow the top of the fascine to be just visible above the ground after backfilling. Each fascine is secured in place with stakes spaced about 1m. apart. These may be live stakes (dia.10 cm.) about 70 cm. long or they may be dead stakes (5cm.X 5cm.). Erosion control fabric should be laid in the base of the trench and extend over the slope between the parallel trenches, after first seeding the area. Schiechl (p. 150) recommends the placement of a layer of live branches at 90 degrees to the streamflow before placing the fascine. Before backfilling around the fascines insert live stakes (75% of their length below ground- see measure 10.4) along the downslope edge of the fascines.

The timing of any installation using live material is critical. Harvest and installation must occur in the dormant season in early spring. It is essential to minimize the time between cutting the branches and installing the fascines. Branches should be wrapped in moist burlap and a tarpaulin during transportation and while awaiting fabrication and installation of the fascines.

Illustration /Sketch



Group No

9.9

Group of measures

**Point protection and stabilization of streambanks**

Measure name

Live Fascines

Synonym

Lebendfaschinen

Maintenance

Fascines should require little maintenance, but the installation should be inspected regularly, and if a section is damaged appropriate measures need to be selected for repair. Willow is not shade tolerant and there may be a loss of effectiveness of the measure after adjacent plants begin to shade each other out. Periodic coppicing or even cutting with a tractor mounted hedge trimmer would keep the stand vigorous and effective. However it may be desired to permit a more natural streamside plant community to develop.

Advantages

Fascines have been proven to be highly effective and can withstand some high flows even before establishment. Willow will reduce excessive soil moisture in wet areas. The growth of willows helps to cause deposition of sediment and debris. If a local source of willow is available, the measure can be used in remote areas difficult to access with machinery.

Disadvantages

Fascines are very labor intensive, requiring harvest, fabrication and installation as well as site preparation, but can be an excellent project for volunteer labor. If a local source of willow is not available, great care has to be taken to prevent the branches drying out while transporting them to the site and fabricating the fascines.

Examples

Photo: Fascines built and installed by students of the chair of Landscape Construction, Faculty of Architecture, TU Dresden, Germany

References and suggested reading

USDA, 1996. „Streambank and Shoreline Protection“. Chapter 16 from the Engineering Field Handbook. Washington DC. Scrh 28 Schiechl p.150  
Schiechl, Hugo M.; Stern, Roland: Handbuch für naturnahen Wasserbau. Eine Anleitung für ingenieurbioologische Bauweisen. Österreichischer Agrarverlag, Wien 1994; Tuttle, Ronald W.: Soil Bioengineering for Upland Slope Protection and Erosion Reduction. In: U.S. Dept. of Agriculture, Soil Conservation Service: Engineering Field Handbook, Chapter 18. Washington 1992; Patt, Heinz; Jürging, Peter; Kraus, Werner: Naturnaher Wasserbau. Entwicklung und Gestaltung von Fließgewässern.

Example Photos



Group No

Group of measures

9.10

### Point protection and stabilization of streambanks

Measure name

Live Wattle Fences

Synonym

Lebender Flechtzahn

Purpose

To protect and stabilize moderately to steeply sloping streambanks by constructing low, live wattle retaining fences at intervals on the slope which, after backfilling will take root and provide long term protection. To reduce erosion and slippage of upper soil layers on sloping banks, and to reduce slumping. Live wattle fences are often used to create a stable framework on banks that are to be seeded and planted with permanent vegetation.

Applications

Effective to create linear protection along streams. The measure will tend to confine the stream to its channel and will also prevent floating debris from littering the floodplain during flood events. For streams with high velocity flows, live fences can be managed as a traditional hedge by periodically bending down the vertical growths and weaving them between stakes spaced about 1m. apart to form a dense live hedge. This structure will resist the most destructive flows

Description

Shallow trenches are excavated along sloping banks to provide a footing for the wattle fence. Wooden poles (dia. 2 cm) are driven into the trenches 25-30 cm apart with approximately 50 cm above the ground. Live willow branches spaced 25-30 cm apart are pushed into pilot holes (min. depth 30 cm.) made with a steel bar in the soil between stakes. The branches which should be at least 200-300 cm long should then be bent over and woven between the stakes. A tie wire can be run along the top of the structure joining the stakes and holding the branches down. The wedge behind the fence is partially backfilled with soil. A series of parallel live wattle fences can be installed in one of three ways (Drawing ). 1) Continuous Parallel Fences 100-300 cm apart and angled at 20-30 degrees to the contour. 2) Parallel Fences with Staggered Interruptions. 400-1000 cm lengths of fence are angled at 10 degrees to the contour in opposite directions. 3) Constantina Cells. Fences form a grid spaced at 150-300 cm and angled at 30-45 degrees to the contours. A fascine (see measure 9.9) can be staked down along the outside edge of the lowest fence if additional protection at the water line is required. After installation sediment will immediately begin to accumulate behind the fences.

Illustration /Sketch

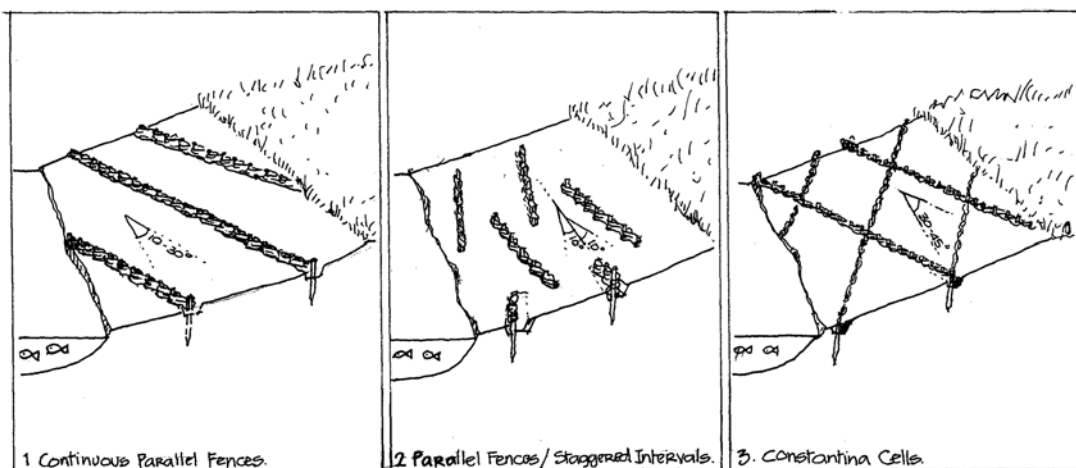
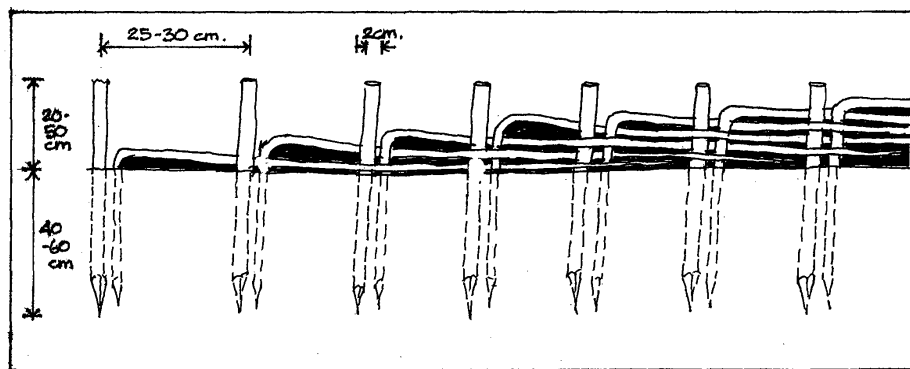

Group No

9.10

Group of measures

**Point protection and stabilization of streambanks**

Measure name

Live Wattle Fences

Synonym

Lebender Flechtzahn

Maintenance

If the live material roots and grows vigorously these structures should be self-healing if damaged. Sediment will be deposited behind the fences. This process can be encouraged until sediment levels build up to the top of the fence, but to do this, about every 4 years, the vertical growths of willow (dia. 3-7cm.) should be bent down and woven between selected willow trunks (dia 10-15cm.) that have been cut at the desired height. Sediment can be stabilized with live material as it accumulates.

Advantages

The fences give immediate mechanical protection after installation. Very little if any machinery is needed on site.

Disadvantages

Installation is labour intensive and requires skill. Not suitable on stony or rocky terrain. Rooting and growth of live material may not occur if conditions are excessively dry.

Fences can obstruct access to the water's edge (In some circumstances this could be an advantage)

Examples

Photo source: Faber, R., BOKU Austria 2004

References and suggested reading

Schiechtl, Hugo M.; Stern, Roland: Handbuch für naturnahen Wasserbau. Eine Anleitung für ingenieurbio-logische Bauweisen. Österreichischer Agrarverlag, Wien 1994; Patt, Heinz; Jürging, Peter; Kraus, Werner: Naturnaher Wasserbau. Entwicklung und Gestaltung von Fließgewässern. Springer-Verlag, Berlin 1998; Begemann, Wolf; Schiechtl, Hugo M.: Ingenieurbio-logie. Handbuch zum ökologischen Wasser- und Erdbau. Bauverlag, Wiesbaden 1994; Zeh, Helgard: Ingenieurbio-logische Bauweisen, Studienbericht Nr. 4, 1993. Eidgenössisches Verkehrs- und Energiedepartement, Bundesamt für Wasserwirtschaft, Bern 1993.

Example Photos



Group No

Group of measures

9.11

### Point protection and stabilization of streambanks

Measure name

Vegetated Rock Gabions

Synonym

Begrünte Drahtschotterkörbe

Purpose

Gabions are rectangular wire baskets that are filled with small to medium sized rock to create a massive structure which (unlike a monolithic concrete structure) has some flexibility, and can adapt to some undercutting or other instability. Gabions can be laced together in various configurations to form terraces or walls. Gabions are also available to fabricate rock mattresses which are sometimes used to protect streambeds subject to excessive scour.

Applications

Gabions are particularly useful when rock of sufficient size is not available locally, and for applications where a vertical or very steeply sloping structure is required. The wide range of gabions that are available including rectangular box gabions, mattress gabions and cylindrical gabions make them adaptable for many uses. Because of their inherent flexibility and ability to adjust to minor instability in their foundations, gabions are useful in many stream stabilization applications.

Description

Gabions are wire baskets of various sizes and configurations, constructed of heavily galvanized or coated wire mesh. The most commonly used size is 1X1X2m. When being used to protect streambanks, a trench is excavated to about 0.7m. below the streambed with the base angled so that the gabion will take up the desired bank angle. If the proposed structure is more than one gabion in height, the trench should be sufficiently wide to accommodate two gabions staggered, side by side. Adjacent gabions should be laced together with tie wire. Place geotextile fabric in the base of the trench with the excess width on the bank. After the first layer of gabions has been filled with rock, wrap the geotextile up and over the gabion. Place a 10cm. layer of crusher-run on the top of the fabric and then lay freshly cut dormant willow branches (dia. 2.5cm and 2-3m. long) with their cut ends against the surface of the cut slope. Backfill with soil behind the gabion to cover the branches and compact well. Place the next layer of gabions and repeat the process, and then backfill, compact, and grade the bank smoothly. Additional live materials can be used to stabilize the upper bank. More than two layers of gabions (2m. high) should only be used with a design from a qualified engineer. Box gabions can also be used to construct deflectors(see measure 9.2) sills or weirs (see measure 7.1) and mattress gabions can be used to prevent excess scouring of a streambed and to provide a good footing for structures that are susceptible to scour at the toe.

Illustration /Sketch



Group No

9.11

Group of measures

**Point protection and stabilization of streambanks**

Measure name

Vegetated Rock Gabions

Synonym

Begrünte Drahtschotterkörbe

Maintenance

The wire mesh of gabions will gradually deteriorate, more rapidly below water if subject to scour and acidic water. The goal should be to design a structure and maintenance program that will ensure that vegetation takes over the role of the gabions in the long term. In addition to including live branches during installation, the structure should be inspected regularly and in early spring each year additional live material placed to maintain the self-healing capability of the structure.

Willow is not shade tolerant and there may be a loss of effectiveness of the measure after adjacent plants begin to shade each other out. Periodic coppicing will keep the stand vigorous and effective and provide live material that can be used for any remedial and maintenance measures that are needed.

Advantages

The flexibility of gabions enable them to withstand slight instability of foundation without damage, unlike monolithic concrete structures. On very remote sites, gabions are light enough to carry by hand and backfill on site using stones collected locally.

Gabions increase the effective size of rock when sufficiently large rock is not available. The wide variety of configurations of gabions that are available make them adaptable for many different uses.

Disadvantages

When wire mesh begins to rust and decompose, it may be hazardous for stream users.

The effectiveness of the installation may be compromised if measures have not been taken to provide for long term stability using vegetation. Due to their stark geometric forms, it may be difficult to blend gabion structures into the landscape

Examples

Vegetated rock gabions shortly after installation. Photo courtesy of the Cold Creek Fly Fishers Inc., Orland, Ontario Canada 2005

References and suggested reading

USDA, 1996. „Streambank and Shoreline Protection“. Chapter 16 from the Engineering Field Handbook. Washington DC. Scrh 10

Example Photos



Group No

Group of measures

10.1

### Stabilization of upper streambank and floodplain areas

Measure name

Hedge Layers, Brush Layers, Hedgebrush Layers

Synonym

Heckenlage, Heckenbuschlage, Buschlage

Purpose

This measure uses live materials to form a linear hedgelike barrier on slopes parallel to the contour. The measure was developed by Schiechl and others mainly for upland slope protection and erosion control on steep dam and highway embankments (Schiechl p. 54). The measure is similar to „live wattle fences“ (measure 9.10) used to stabilize stream banks. In floodplain areas hedge layers can be used to stabilize steep banks that sometimes occur between floodplain terraces. They can also be used as longitudinal barriers to trap flood debris before it spreads over the whole floodplain.

Applications

Hedge layers are useful for stabilizing the steep embankments that are often seen between terraces on floodplains. They are also used to trap floating debris during flood events and are therefore useful on rivers and streams that carry large debris loads. The filtering effect of these hedges will also trap sediment which will gradually build up forming levee like structures that will tend to reduce the extent of flooding. Hedge layers are not appropriate where the floodplain is being managed as riparian woodland

Description

Schiechl (p 54) recommends that live branches of willow (0.7m-1.5m long) are placed in trenches (min depth 0.5 m) excavated parallel to the contour and buried with one quarter of their length protruding above the ground. This should be carried out during dormancy. If soil moisture is sufficient, the branches should root. Ideally the trench should be deep enough so that the base of the branches is close to ground water table. On drier sites, rooted nursery stock of alder, willow, osier dogwood or other flood plain shrub species can be planted 0.5m apart during the dormant season. Most flood plain species are tolerant of periodic inundation and accumulation of sediment above the root collar. Rooted plants will be effective more quickly than unrooted branches. If appropriate, hedge layers can be managed as traditional hedges once they are established. In cases where it is desired to restrict access to the river channel or to all or some of the flood plain these hedges can be highly effective. In late winter or very early spring every 5 years, strong vertical growths spaced at 1m intervals should be selected and cut off 1m high. Or fencing stakes can be used spaced 1m apart. The old growth in the hedge is then thinned out leaving young, supple vertical growths 3m and longer. These are then bent down and woven between the stakes forming a woven live barrier.

Illustration /Sketch

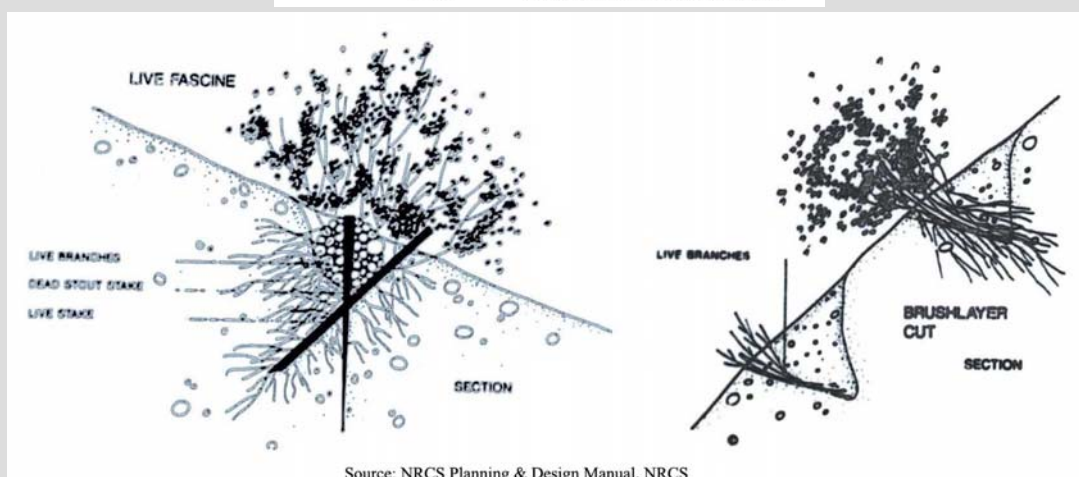
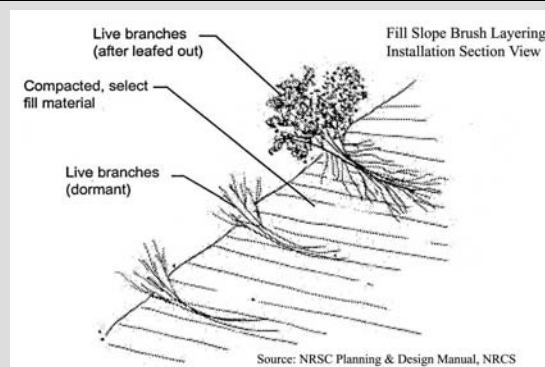



Group No

10.1

Group of measures

**Stabilization of upper streambank and floodplain areas**

Measure name

Hedge Layers, Brush Layers, Hedgebrush Layers

Synonym

Heckenlage, Heckenbuschlage, Buschlage

Maintenance

If the live hedge material roots and grows vigorously these structures should be self-healing if damaged by floods. Sediment will build up along the hedge but the plants will root into these deposits as they accumulate. Gradual build up of sediment along the length of the hedges could form a levee and significantly reduce the frequency of flooding of flood fringe areas upslope. In some cases this could be beneficial. If not, it might be necessary to remove the hedge. Clean up of flood debris will be necessary after a storm event but a hedge layer will make this maintenance task easier by trapping the debris along a single line.

Advantages

This measure can be installed with very little if any machinery.  
The measure can be used to restrict access to certain areas of the stream corridor without using fences

Disadvantages

The measure will be ineffective if rooting and growth of live material does not occur.  
If it is desired to manage the hedge to restrict access from some areas of the stream corridor, the maintenance requirements to make the hedge impassable are costly

Examples

Photo courtesy of Robin B. Sotir & Associates, Inc. Marietta, Georgia, USA

References and suggested reading

Schiechtl, p 54  
Schiechtl, Hugo M.; Stern, Roland: Handbuch für naturnahen Wasserbau. Eine Anleitung für ingenieurbio-logische Bauweisen. Österreichischer Agrarverlag, Wien 1994; Begemann, Wolf; Schiechtl, Hugo M.: Ingenieurbio-logie. Handbuch zum ökologischen Wasser- und Erdbau. Bauverlag, Wiesbaden 1994; Zeh, Helgard: Ingenieurbio-logische Bauweisen, Studienbericht Nr. 4, 1993. Eidgenössisches Verkehrs- und Energiedepartement, Bundesamt für Wasserwirtschaft, Bern 19

Example Photos



Group No

10.2

Group of measures

### Stabilization of upper streambank and floodplain areas

Measure name

Reforestation of Riparian Forest

Synonym

Gehölzbestandene Uferstrandstreifen

Purpose

To restore the beneficial filtering effect of riparian forests in removing pollutants from surface runoff and shallow groundwater flow. Also to restore the infiltration capacity of riparian soils to reduce runoff flowing directly into the water body.

Applications

Reforestation should be considered wherever the forest has been removed from the riparian zone and where urban development has not pre-empted the space. It is valuable for stream reaches needing of bank stabilization where bioengineering methods are employed. Reforestation is also useful in farming areas where runoff contains high nutrient and/or sediment loads and where the land has been cleared unto the edge of the water

Description

Whenever possible riparian forest buffers should be re-established adjacent to water bodies through a combination of natural regeneration, and replanting. Stands of exotic plants should be cut, dug, or pulled out. A study of nearby healthy riparian forests will provide a useful guide for the choice of plant species and the appropriate diversity of the plant community. Unstable areas along streambanks should be identified and appropriate stabilization measures should be implemented before reforestation begins. In areas designated for natural regeneration, a no-mow zone should be established and carefully monitored to encourage growth of native species. This strategy is most successful if the area was cleared of forest recently and seed of indigenous species is still viable. Exotic species that emerge should be removed. Planting of forest is most effectively carried out using small, bare-rooted plants, closely spaced and thinned as they become established and start to compete. Larger, container-grown stock is only appropriate on sites where an immediate effect is necessary. As the forest becomes established the available light will diminish. Pioneer species are usually intolerant of shade and will die as a canopy of longer-lived trees becomes established. Successful reforestation requires a balance between species with differing light requirements. Care should also be taken to establish a community of understory and herbaceous plants. This is essential for a healthy riparian forest.

Illustration /Sketch

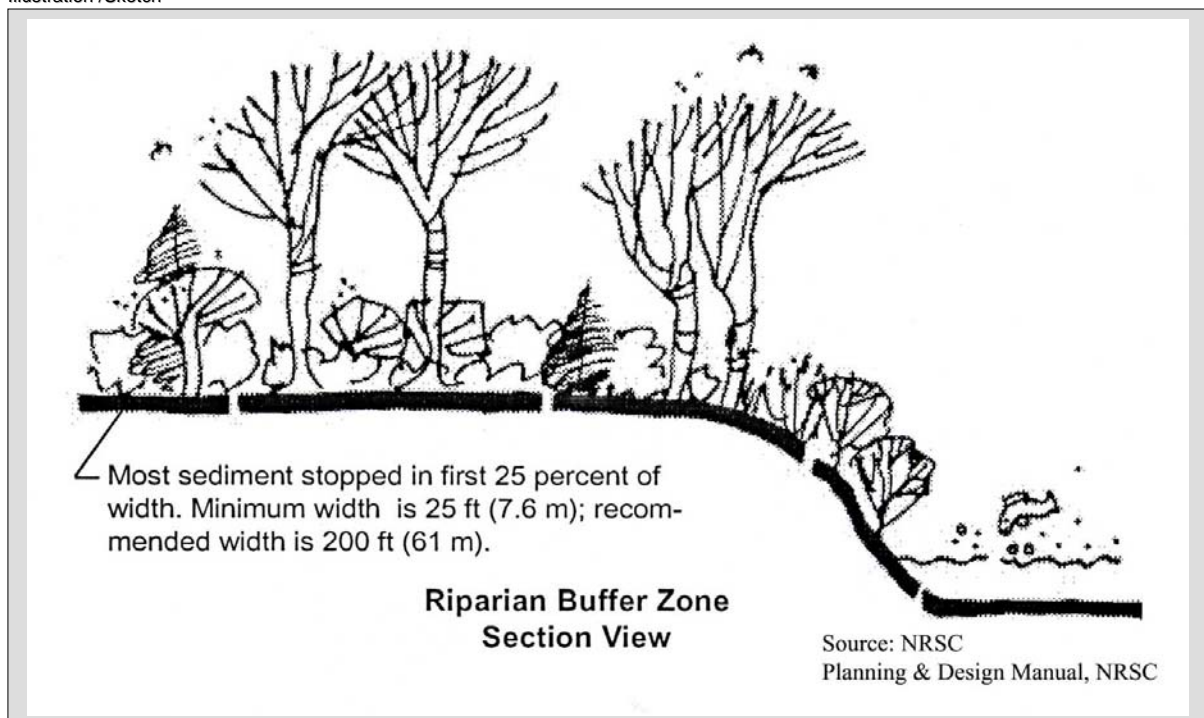

Group No

10.2

Group of measures

**Stabilization of upper streambank and floodplain areas**

Measure name

Reforestation of Riparian Forest

Synonym

Gehölzbestandene Uferrandstreifen

Maintenance

Sites should be inspected at least twice per year during the first three years of reforestation. Mulch may be added where needed to suppress unwanted growth during the early years. A management plan covering at least 15 years after planting should be prepared at the same time as the planting plan. This should focus on the process for selective thinning of trees as the forest develops

Advantages

The advantages of restored riparian forest are numerous and the same as for existing forest (see Measure 10.3)

Disadvantages

There are few disadvantages to restoring riparian forest. But it is a fairly lengthy process requiring management for at least 15 years particularly in the selective thinning of trees

Examples

Photo: Banks of the Winooski River, VT, in the 1930s compared to the 1990s after a successful reforestation  
Source: In Stream Corridor Restoration: Principles, Processes, and Practices, 10/98. Interagency Stream Restoration Working Group (FISR WG)(15 Federal agencies of the US).

Example Photos



References and suggested reading

Tourbier & Walmsley, Inc.: London Grove Township Stormwater Management Guidance Manual. London Grove Township Board of Supervisors, Philadelphia 1996;

Group No

Group of measures

10.3

### Stabilization of upper streambank and floodplain areas

Measure name

Maintenance of Existing Riparian Forest

Synonym

Gehölzbestandene Uferandstreifen

Purpose

To make use of the filtering effect of riparian forests in removing pollutants from surface runoff and shallow groundwater flow. Also to promote the infiltration of runoff into the forest floor before flowing into the water body.

Applications

The buffering effect of riparian forests should be protected on sites where they still exist and buffers should be re-established (see Measure 10.3) where the forest has been removed.

Description

Riparian forests that grow along the edges of water bodies play an important role in cleansing surface and groundwater. A high quality groundwater will insure the quality of baseflow for streams. During rain events, stormwater flows towards streams as both surface runoff and shallow groundwater flow (Dunne and Leopold, 1976). Runoff and groundwater near the surface is often contaminated with nitrogen and phosphorus.

Research has shown that forest soils and the roots of riparian vegetation can retain nitrogen through assimilation, nitrification and denitrification. Forests furthermore utilize other nutrients in the growth process (Correll, 1986). Riparian forest buffers can be divided into three zones.

Zone 1 is about 15 feet wide beginning at the top of the stream bank. Its principal roles are to provide soil/water contact to facilitate nutrient buffering, to provide shade to reduce water temperature encouraging the production of beneficial algae and to contribute necessary detritus and large woody debris to the stream ecosystem. Zone 2, begins at the upland edge of Zone 1 and occupies a strip at least 60 feet wide. Its role is to provide a carbon energy source and sufficient contact time for sediment and nutrient removal by soil, forest litter, and the uptake of nutrients by forest plants. Zone 3 may be omitted on sites where additional stormwater management measures are being used. It begins at the upland edge of Zone 2 and has a minimum width of 20 feet. Its roles are to provide for conversion of concentrated flows into sheet flow and for sediment filtering.

Illustration /Sketch

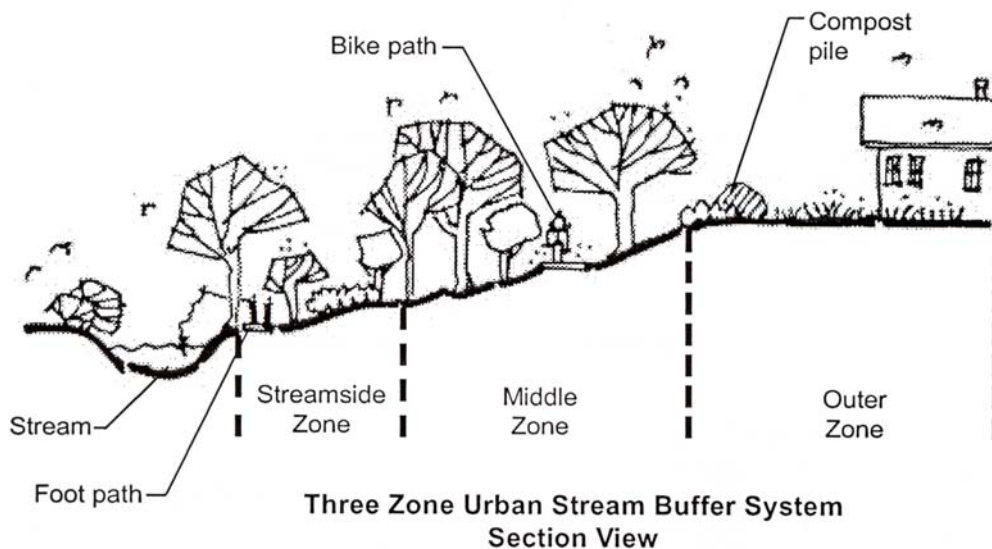

Source: NRCS Planning & Design Manual, NRCS.

Group No

10.3

Group of measures

**Stabilization of upper streambank and floodplain areas**

Measure name

Maintenance of Existing Riparian Forest

Synonym

Gehölzbestandene Uferrandstreifen

Maintenance

In all zones, invasive plant species should be controlled. In Zone 1 any areas where erosion damage is observed should be repaired. After flood events the removal of drift solids snagged in riparian vegetation may be necessary

Advantages

The leaf litter and humus layers of riparian forest soils support microbes that assimilate nitrogen, cause nitrification and denitrification, and remove soluble pollutants through oxidation and reduction. Riparian forests will utilize other nutrients in stormwater including phosphorous. They dissipate rainfall energy, thus reducing erosion, and filter sediments from runoff. They help to stabilize stream banks and increase infiltration and base flow. They shade the water providing lower water temperatures and more dissolved oxygen. They are also valuable habitat for wildlife.

Disadvantages

There are few disadvantages to a healthy riparian forest. Views of the water may be obstructed. Fly fishermen may have difficulty casting. The vegetation may snag drift solids but this prevents them being a problem downstream.

Examples

Photo Source: In Stream Corridor Restoration: Principles, Processes, and Practices, 10/98. Interagency Stream Restoration Working Group (FISR WG)(15 Federal agencies of the US).

References and suggested reading

Tourbier & Walmsley, Inc.: London Grove Township Stormwater Management Guidance Manual. London Grove Township Board of Supervisors, Philadelphia 1996.

Example Photos



Group No

Group of measures

10.4

### Stabilization of upper streambank and floodplain areas

Measure name

Synonym

Live Stakes and Dormant Posts

Steckhölzer, Palisaden

Purpose

To stabilize banks using short live stakes driven into the ground at varying spacing. These live stakes, usually species of willow, will root and not only stabilize the bank, but also extract soil moisture. Live stakes are also used to peg down mattresses (measure 9.7), rolls(8.1) and other bio-technical devices. Larger live stakes (called "Dormant Posts" by USDA,1996.p. 16-38 and SCRH 32), also harvested during dormancy can be used on lower sections of the streambank. Successful rooting rate for large stakes is lower than for smaller stakes.

Applications

A simple, low cost technique, applicable on all sloping sites that do not require substantial mechanical protection during establishment (when Measure 9.7 Brush Mattresses would be appropriate). Valuable for stabilizing persistently wet areas. Live stakes can also be used in combination with several other measures. The measure is usually used to stabilize banks above bankfull stage but may be used on lower slopes if combined with an erosion control fabric or other bio-technical measure. Larger dormant posts are more appropriate on the lower bank.

Description

Live stakes should be 0.5-1m. long and 1.5 – 4.0 cm in diameter are driven into the ground in early spring, well before leafing. Stakes will root and provide long-term stabilization. Willow species have the highest rate of success. After driving, stakes should be cut off to a uniform height of about 30 cm. The spacing between stakes can vary from 30 cm. to 1 m. usually in a triangular pattern. The stakes may be driven through a coarse geotextile to protect the intervening spaces during establishment. USDA (1996 p.16-14) recommends that stakes are driven vertically to the slope and slanting slightly downstream. It is essential that the stakes have been freshly prepared and should be inserted immediately after preparation. Side branches should be removed cleanly and each stake pointed at its lower end. In hard ground, a pilot hole should be made with a steel bar and stakes driven with a wooden mallet to prevent splitting. At least three quarters of the length of the stake should be below ground. Any split or frayed ends should be pruned off cleanly. Larger live stakes can be used in more unstable conditions lower on the streambank. They should also be freshly harvested (dia 10-15cm and 2-3m. long) and sharpened at the lower end. At least on half of the stake should be below ground extending well into the saturated water table. They should usually be spaced at about 1m. apart. USDA (1996, p.16-38) recommend a triangular or square pattern. They may be driven by hand, with a tractor mounted post driver or with a hydraulic jet. It is essential to avoid damage to the post and any frayed tops should be cut off cleanly. Larger live stakes can effectively be used as a first step in repairing seriously eroding sections of lower streambanks. The rooted posts can then be used to anchor measures installed as a second step designed to respond to the stream's behaviour.

Illustration /Sketch

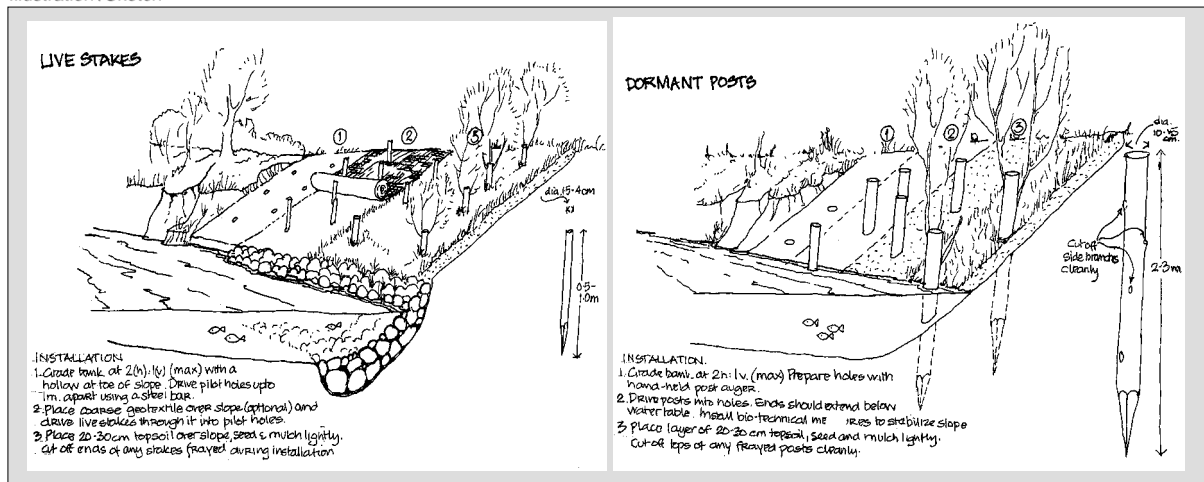

Group No

10.4

Group of measures

**Stabilization of upper streambank and floodplain areas**

Measure name

Live Stakes and Dormant Posts

Synonym

Steckhölzer, Palisaden

Maintenance

Willow is not shade tolerant and there may be a loss of effectiveness of the measure after adjacent plants begin to shade each other out. Periodic coppicing or even cutting with a tractor mounted hedge trimmer would keep the stand vigorous and effective. However it may be desired to permit a more natural streamside plant community to develop. Live stake installations should be inspected regularly and any points of failure noted and repaired using an appropriate technique. In situations subject to particularly erosive flows, a line of rooted willow stakes can be 'laid' as a traditional hedge to form a living woven barrier (see measure 9.10). Large live stake installations will almost always require maintenance or some retrofitting, especially when used to repair serious erosion on the lower streambank. However, any posts that have rooted will provide valuable anchors for any further repair measures.

Advantages

This is a low cost and simple measure. If there is a local supply of willow, the delay between cutting and installation can be minimized resulting in a high rate of success. Live stakes can be used in many configurations and combinations with other measures.

Disadvantages

Live stakes give little protection during their establishment period. Even if they are inserted through an erosion control blanket, the risk of failure by installing this measure alone in the bank zone between normal and bankful stages is high. Larger live stakes used on the lower bank can be subject to ice damage.

Examples

Live stakes with a substantial diameter have a better chance to sprout rapidly.  
Photo source: Faber, R., BOKU Austria 2004

References and suggested reading

USDA, 1996. „Streambank and Shoreline Protection“. Chapter 16 from the Engineering Field Handbook. Washington DC. Scrh 32  
Schiechtl, Hugo M.; Stern, Roland: Handbuch für naturnahen Wasserbau. Eine Anleitung für ingenieurbio-logische Bauweisen. Österreichischer Agrarverlag, Wien 1994; Tuttle, Ronald W.: Soil Bioengineering for Upland Slope Protection and Erosion Reduction. In: U.S. Dept. of Agriculture, Soil Conservation Service: Engineering Field Handbook, Chapter 18. Washington 1992; Begemann, Wolf; Schiechtl, Hugo M.: Ingenieurbio-logie. Handbuch zum ökologischen Wasser- und Erdbau. Bauverlag, Wiesbaden 1994;

Example Photos



Group No

10.5

Group of measures

**Stabilization of upper streambank and floodplain areas**

Measure name

Seeding Grass and Legumes

Synonym

Deckbauweisen Grass Leguminose

Purpose

Seeding of grass or a mix of grass and legumes is used to stabilize sites not susceptible to serious erosion. Sod may be used when soil protection is required immediately

Applications

Seeding with grass can be used on sites not susceptible to serious erosion and where a quick, low-cost solution is required. Legumes may be included in the seed mix if pH conditions are correct.

Description

**Temporary Cover Crops.** Disturbed areas subject to erosion can be protected through a temporary cover crop until a permanent cover is established. Cover crops are usually agricultural crops, selected for rapid growth and good coverage. Small grains, which can be planted in the spring or an over-winter crop in the fall, are often used. Species chosen may be Barley, Oats, Rye, Italian ryegrass, Millet, Boer or Lehmann's Lovegrass or Sudangrass. **Permanent Cover.** Erosion characteristics, as well as the intended use of a site and growing conditions should be considered when selecting a seed mix. It is also important to select a seed mixture suitable for a maintenance program, which is realistic on the long term. Legumes are capable of fixing atmospheric nitrogen and should be included in seed mixes for areas where regular fertilization cannot be relied upon. Seeding mixtures may include Kentucky Fescue, Crownvetch, Weeping Lovegrass, Reed Canarygrass, and others. **Seedbed preparation** on compacted sites may require a ripper attachment on a crawler tractor to break up the subsoil and the spreading of topsoil. Lime, fertilizer, seed and a fibre mulch may be applied with a hydroseeder or by using conventional agricultural techniques

Illustration /Sketch

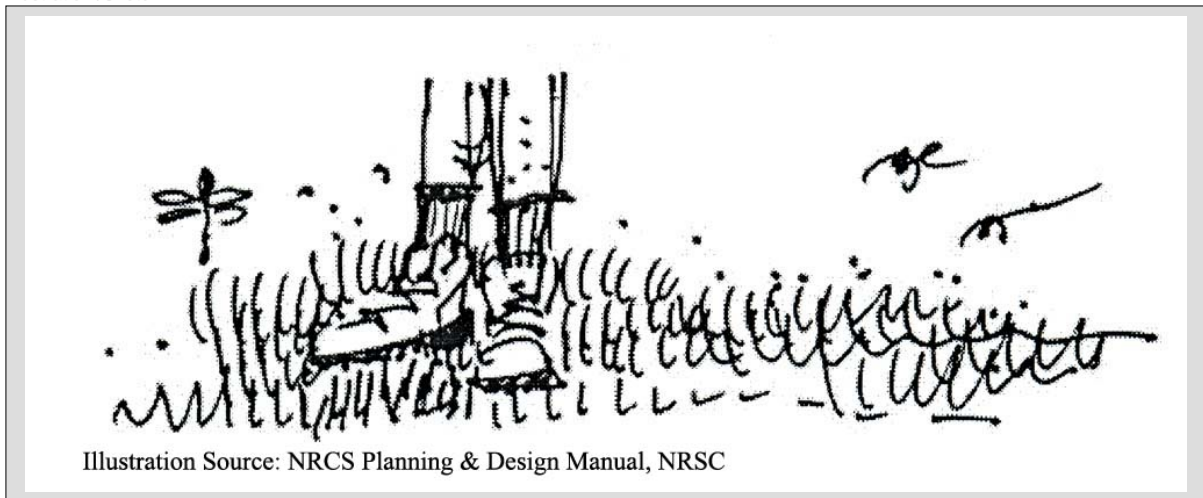



Group No

10.5

Group of measures

**Stabilization of upper streambank and floodplain areas**

Measure name

Seeding Grass and Legumes

Synonym

Deckbauweisen Grass Leguminose

Maintenance

Temporary cover crops are left on the ground for soil stabilization as long as possible and worked into the ground prior to establishing a permanent vegetative cover. A permanent cover can be maintained as a meadow that is being mowed twice annually or can be mowed more frequently, depending on the surface use intended.

Advantages

Temporary cover crops provide an effective erosion control in a short time.  
Decaying temporary cover crops can act as mulch.

Disadvantages

The planting of temporary cover crops on slopes exceeding 20 % is hazardous when agricultural equipment is being used.  
Temporary and permanent cover on very steep slopes is ineffective without additional protection (Soil Bioengineering).  
Grass requires regular mowing to maintain its resistance to erosion. Un-mown grass may be a fire hazard

Examples

Examples

Example Photos

Photos

References and suggested reading

Tourbier, J. Toby; Westmacott, Richard: Water Resources Protection Technology. A Handbook of Measures to Protect Water Resources in Land Development. ULI- The Urban Land Institute; Washington, D.C. 1981; Schiechl, Hugo M.; Stern, Roland: Handbuch für naturnahen Wasserbau. Eine Anleitung für ingenieurbio-logische Bauweisen. Österreichischer Agrarverlag, Wien 1994; Begemann, Wolf; Schiechl, Hugo M.: Ingenieurbio-logie. Handbuch zum ökologischen Wasser- und Erdbau. Bauverlag, Wiesbaden 1994; Zeh, Helgard: Ingenieurbio-logische Bauweisen, Studienbericht Nr. 4, 1993. Eidgenössisches Verkehrs- und Energiedepartement, Bundesamt für Wasserwirtschaft, Bern 1993.

Group No

11.1

Group of measures

**In-stream habitat improvement**

Measure name

Fish Ladders

Synonym

Fisch-Aufstiegshilfen

Purpose

Measures to eliminate natural or manmade barriers which obstruct the migration of fish to upstream areas to spawn and measures to provide passages for migrating fish to reach their spawning grounds.

Applications

Applicable on all streams and rivers that support or could potentially support a population of migratory fish, but where barrier obstruct their passage.

Description

Fish ladders in the form of rectangular channels with diagonal walls, forming a series of basins have been in regular use and have in Germany been mentioned as early as the 17<sup>th</sup> Century (Frischholz 1924). It is recommended that basins have a minimum length of 1.2 m and minimum width of 1.0 m. The drop between basins should not exceed 0.2 m and the flow are to be kept lower than 1,5 m/s. **Basin Passage Fish ladders** have often been integrated into Dams and usually do not work well. The volume and velocity of flows that emerge from them needs to be calibrated to lure and lead fish to them. This lead flow needs to occur prior to the violent flows emitted by dams with turbines (DVWK 1994), which usually have a devastating effect on fish. A variation of basin passages has been introduced from North America in the form of the **Vertical-Slot-Pass** (see sketch below). Instead of indentures in basin walls vertical slots are arranged over the full height of the of the basin walls. Water is led in a fashion that creates resting zones for fish with lesser turbulence. The difference in the height of chambers should not exceed 0,2 m to create flows in slots that permit the passage of smaller fish. The vertical-slot-pass is suitable for dams with variations of flow and is not as susceptible to getting plugged up through debris as conventional Basin Passages. **Denilpasses** take the form of a channel with multiple prefabricated slats that can be installed with a relatively high slope. Examinations have shown (Gunkel, 1993) that this device is only suitable for very strong swimmers and that those that are not cannot navigate it. **Bypass-channels** are suitable, not only for anadromous fish but also for the movement of other aquatic life forms who wander for spawning, search of food sources, search for areas of retreat or spread during their lifecycle sustaining genetic variability. The bypass-channel around a dam consists of a series of cascades, formed through stones that form resting areas with low flow velocities. In order to be successful there needs to be a nearly constant water level above the dam, a channel drop of not more than 1:20 and sufficient space to accommodate them. A **Ground Ramp (Sohlrampe)** of the streambed is a riffle constructed on a 1.20 slope by dumping stone or by hand setting stone, either as a continuous ramp, or as an interrupted series of ramps. They can stretch across the entire width of a stream as a replacement for a weir, or be constructed at one side of a weir.

Illustration /Sketch

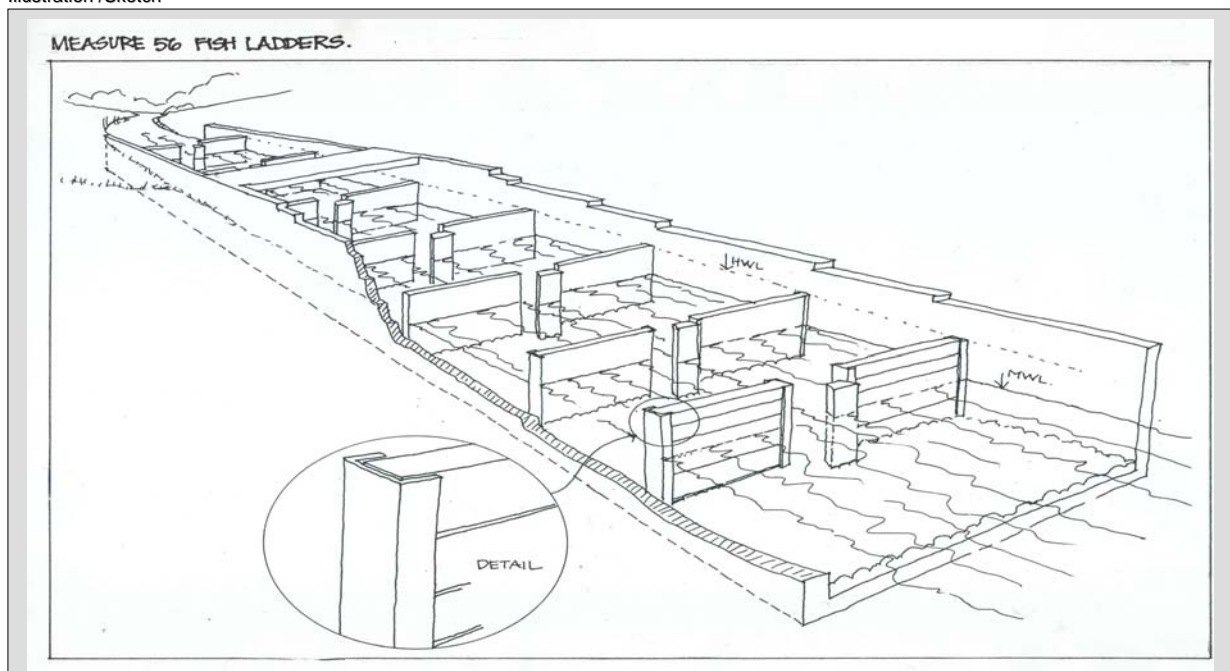

Group No

11.1

Group of measures

**In-stream habitat improvement**

Measure name

Fish Ladders

Synonym

Fisch-Aufstiegshilfen

Maintenance

All fish passages tend to clog with floating debris during storm events and require frequent maintenance. This particularly applies to Basin Passage Fish ladders and Vertical-Slot-Passes. Denilpasses and Ground Ramps are less susceptible to clogging.

Advantages

**Vertical-Slot-Passes** functions during all kind of flows, permits passage of smaller fish and is less prone to clogging than Basin Passage fish ladders.

**Ground Ramps of the streambed** offer migration opportunities for all forms of aquatic life.

Disadvantages

**Bypass-channels** need sufficient space to be constructed and require a near constant water level above the dam.

**Basin Passage Fish ladders** tend to have too low a velocity of flow to form to lure fish to use them, they tend to clog and do not permit passage of fish that are weak swimmers.

**Denilpasses** can only be navigated by fish that are very strong swimmers.

Examples

Examples

Example Photos

Photos

References and suggested reading

DVWK Fischaufstiegsanlagen. – Merkblätter zur Wasserwirtschaft. Deutscher Verlag für Wasserwirtschaft und Kulturbau, 1994  
Gunkel, G. Renaturierung kleiner Fließgewässer, Stuttgart: Fischer Verlag, 1996  
Frischholz, E, Anlage und Betrieb von Fischpässen. – Handbuch der Binnenfischerei Mitteleuropas. BD 6 Stuttgart: Schweitzerbart'sche Verlagsbuchhandlung, 1924

Group No 11.2	Group of measures <b>In-stream habitat improvement</b>
------------------	---

Measure name <b>Log, Brush or Rock Shelters</b>	Synonym Fischuhlterstande mit Auflage
--	--

**Purpose**  
To improve fish habitat by providing shelter in the form of overhead cover, to trap detritus for insects and other organisms that are a source of food for fish, and to shade and cool the water. "Digger Logs" (SCRH sheet 12) are also designed to improve habitat for fish. They are large logs set across small streams to create a constriction of flow beneath in order to scour a pool in the streambed downstream of the log.

**Applications**  
Applicable to all streams but especially to those where past alterations have destroyed much of the habitat diversity and eliminated much of the natural shelter and pools for fish.

**Description**  
Shelters may consist of underwater, shelf-like extensions of the streambank under which fish can lie. They may be constructed of floating logs (SCRH sheet 6) or fixed half logs. Floating logs can be used only where water depth is more than 30 cm. The logs (min dia 40 cm) at least 3m long are usually strapped together in pairs and secured to stakes or deadmen in the bank with steel cable. Half logs (min. dia 40 cm) are cut lengthways and then staked to the stream bed with 1m long lengths of 10mm rebar driven through the half log at each end. At these points, short logs (15-20 cm dia) are placed at 90 degrees under the half log to create a space beneath. The underside (flat side) of the half log should be set just below normal water level. They are best located in low gradient stream bends and where open pools are already present. Shelters may also be constructed of large flat rocks. SCRH (sheet 6) recommends that both floating logs and half logs are secured parallel or at a slight angle to the stream flow. Overhanging sections of the bank (SCRH sheet 44) can be created by constructing log cribwork frames (about 0.7 m square) close to the bank in water at least 50 cm deep where the streambed is roughly level. Logs that are at 90 degrees to the bank should extend into the bank. When the logs almost break the surface, a fine geogrid should be secured horizontally over the structure and extend into the streambank. On this is placed a 30 cm layer of rock and coarse stone and 30 cm of soil. Live stakes can be driven into the structure where it meets the bank, and live branches can be placed horizontally in the soil layer with their bases extending well into the streambank. "Digger Logs" (SCRH sheet 12) are large logs that are set across small streams with a space of 5-12 cm above the stream bed. This causes a constriction of flow which will scour a small pool in the streambed downstream of the log.

Illustration /Sketch

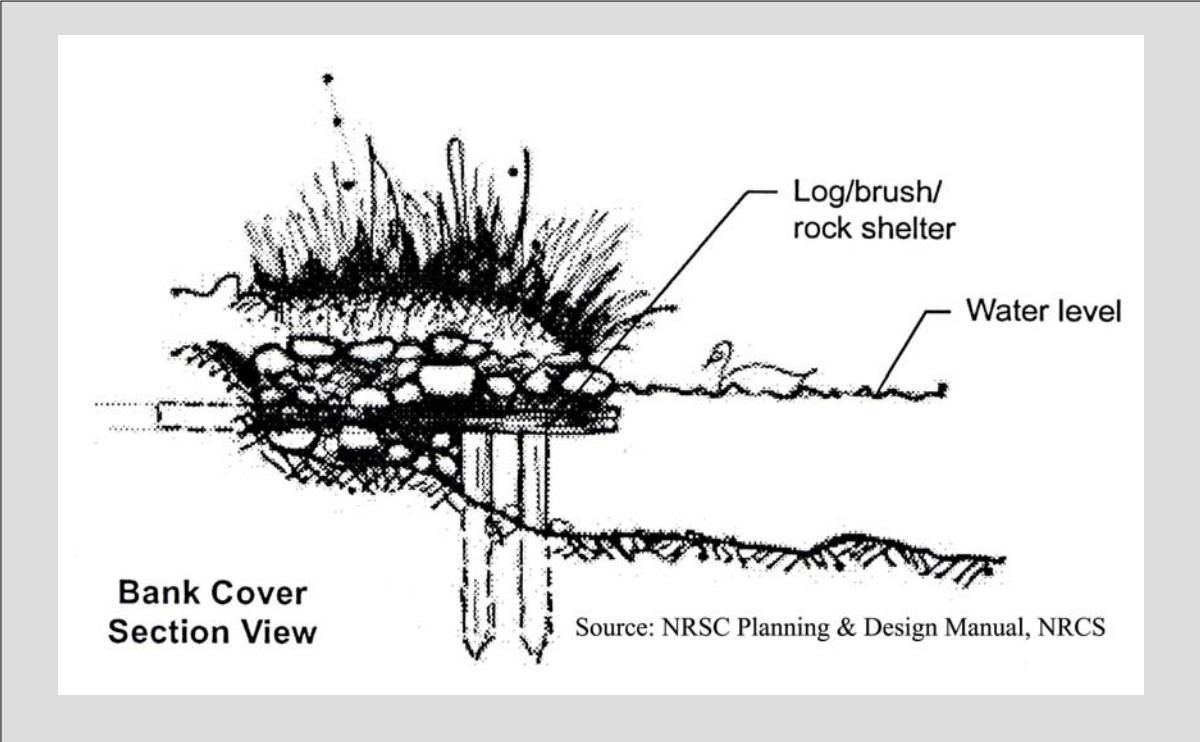

Group No

11.2

Group of measures

**In-stream habitat improvement**

Measure name

Log, Brush or Rock Shelters

Synonym

Fischuhlteerstände mit Auflage

Maintenance

Structures constructed of logs will gradually deteriorate and are liable to washout during large storms. They are temporary structures and stream managers should use them as a step in making permanent improvements. The objective of a maintenance program should be to take actions that will permanently improve the habitat diversity of the stream. Stream behaviour will continually change stream habitats and a skilled observer who can suggest appropriate ways to adjust stream behaviour to improve habitat should be regularly consulted. These structures may trap debris causing log jams and regular inspections are essential to remove any obstructions that are causing damage. In some cases however, obstructions can result in habitat improvement.

Advantages

All these structures are relatively easy and cheap to install. Floating log structures have less impact on channel capacity and flow characteristics than fixed structures.

Disadvantages

Any of these structures (particularly digger logs) can trap debris and cause log jams, which can divert stream flow and cause serious bank erosion. All of these structures should be regarded as temporary in nature. Unless they are properly installed they may seem to be visually intrusive. Logs washed out during flood events can cause damage to structures downstream. Overhanging bank structures can pose a safety hazard for recreational users of the streambank.

Examples

Examples

Example Photos

Photos

References and suggested reading

Schiechtl, Hugo M.; Stern, Roland: Handbuch für naturnahen Wasserbau. Eine Anleitung für ingenieurbioologische Bauweisen. Österreichischer Agrarverlag, Wien 1994;

Group No

Group of measures

11.3

### In-stream habitat improvement

Measure name

Synonym

Lunker Structures

Lunker Fischunterstand

Purpose

The principal purpose of a Lunker structure is to improve stream habitat by providing an undercut shelter for fish. The structure will also give some protection of eroding streambanks but other bank protection techniques are more cost effective unless habitat improvement is important.

Applications

Applicable for sites where the improvement of fish habitat is a high priority and where streambank erosion protection is also needed. The outside of bends where a deep shaded pool is desired are usually most suitable sites. Lunker structures should be used on streambanks where the depth of water during baseflow conditions is at least 25 cm. This is to insure that the structure is always below water level and permanently waterlogged. Otherwise wetting and drying cycles will cause the structure to decompose rapidly

Description

Lunker structures are cell-like structures made of two pallets of stout oak boards separated by wooden spacing blocks. One pallet is placed horizontally on the bed of the stream against an eroding bank. Oak spacing blocks are placed at each corner and a second pallet laid on top. This top pallet should be below baseflow water level. Large rock and crushed stone are then placed over the structure and finally topsoil graded smooth with the existing bank. Pallets should be pre-constructed off-site. Both pallets are 80 cm square. The bottom pallet is constructed of two stringers 5 X 20 cm and three cross boards with the same dimensions nailed at 90 degrees. For the top pallet the stringers are 160cm long allowing 80 cm to be buried in the stream bank. Four crossboards are used, butted tightly together. Spacing blocks should be 20 cm square and predrilled with 1.5 cm holes for rebar spikes. These holes should be aligned with four holes drilled in both pallets, aligned with the holes in the spacing blocks on each corner. The structure may consist of one or a series of cells along the streambank. The length of streambank to be treated is first prepared by cutting back with a backhoe and levelling the stream bed. The streambed must be perfectly level or pitched very slightly into the bank. The bottom pallets are placed in position and weighed down temporarily. Spacing blocks are placed at each corner and the second pallet on top with the excess stringers extending into the bank. The structure is then secured by driving 1.5 m lengths of 1.5 cm rebar through the predrilled holes in the pallets and spacing blocks into the bed of the stream channel. A 5 X 25 cm oak backboard is then placed vertically against the rear side of the structure. The space between the bank and the structure is then backfilled with rock (dia 30 cm) which should extend over the „roof“ of the structure. Crushed stone is placed over the rock followed by a 30 cm layer of topsoil. Dormant willow posts (measure 54) can be used to provide long-term bank protection and habitat improvement.

Illustration /Sketch

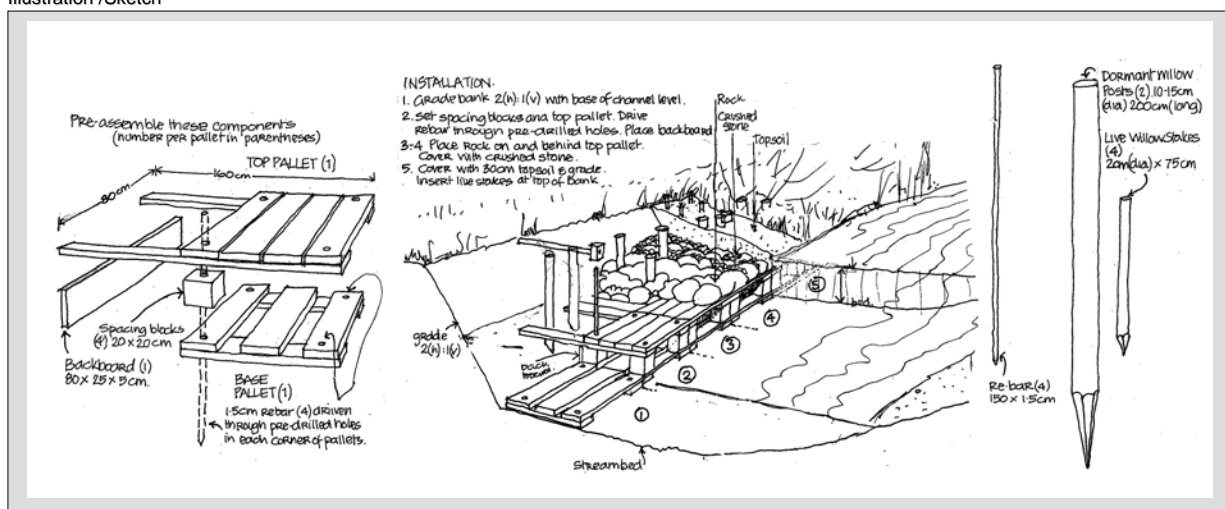

Group No

11.3

Group of measures

**In-stream habitat improvement**

Measure name

Lunker Structures

Synonym

Lunker Fischunterstand

Maintenance

Once this measure has been installed there is no maintenance to be carried out other than to manage the willow if dormant posts have been used to provide long-term protection and shade. If the oak structure deteriorates and fails, the stream manager must decide whether the disturbance and expense involved in demolishing and rebuilding the structure is justified.

Advantages

The shelter provided for fish by Lunker structures is highly effective and can significantly improve fish habitat on channelized streams which typically have very little shelter.

Disadvantages

Lunker structures are expensive to install and require access for heavy machinery to the streambank. To justify the expense, the deterioration of the timber structure should be minimized by installing below the baseflow water level.

References and suggested reading

Palone & Todd. 1997 Chesapeake Bay Riparian Handbook. pp 18-20  
SCRH sheet 45

Schiechtl, Hugo M.; Stern, Roland: Handbuch für naturnahen Wasserbau. Eine Anleitung für ingenieurbio-logische Bauweisen. Österreichischer Agrarverlag, Wien 1994; Begemann, Wolf; Schiechtl, Hugo M.: Ingenieurbio-logie. Handbuch zum ökologischen Wasser- und Erdbau. Bauverlag, Wiesbaden 1994; Zeh, Helgard: Ingenieurbio-logische Bauweisen, Studienbericht Nr. 4, 1993. Eidgenössisches Verkehrs- und Energiedepartement, Bundesamt für Wasserwirtschaft, Bern 1993.

Examples

Below one of possible designs of lunker structures. Source: Savanna Springs, WI

Example Photos



Group No

Group of measures

11.4

### In-stream habitat improvement

Measure name

Boulder Clusters

Synonym

Gruppe vor Störstein

Purpose

Large boulders are strategically placed in clusters to confine streamflow and scour out pools in the stream bed. These pools used by fish for shelter and as resting areas.

Applications

Applicable in small streams particularly those where past alterations have eliminated much of the habitat diversity. Not applicable on streams with sand or silt beds into which boulders will sink. Only applicable where the streambank is accessible to heavy lifting equipment necessary to place large boulders.

Description

Boulders must be large enough to withstand movement even during flood events. They should normally be 1-2m in diameter. Irregular, angular shapes will resist movement better than rounded rocks. Smaller rock can be laced together but this is time consuming and steel cables can pose a hazard for stream users. SCRH (sheet 2) recommends freshly quarried rock but this may look „raw“ until weathering has occurred. The rock type should be geologically appropriate for the site. Constrictions in the channel caused by the boulders will increase flow velocity, especially between closely spaced rocks. The scouring that results will create small pools and sheltering areas for fish. Boulders are placed singly or in clusters well away from the bank on a firm gravel bed. Access for heavy lifting equipment needed to place the boulders may be a problem on some sites. An experienced geomorphologist should supervise placement of boulders as the deflection of streamflow that results can cause serious bank erosion and other unforeseen consequences. Boulders can also be used to deflect flows away from eroding banks.

Illustration /Sketch

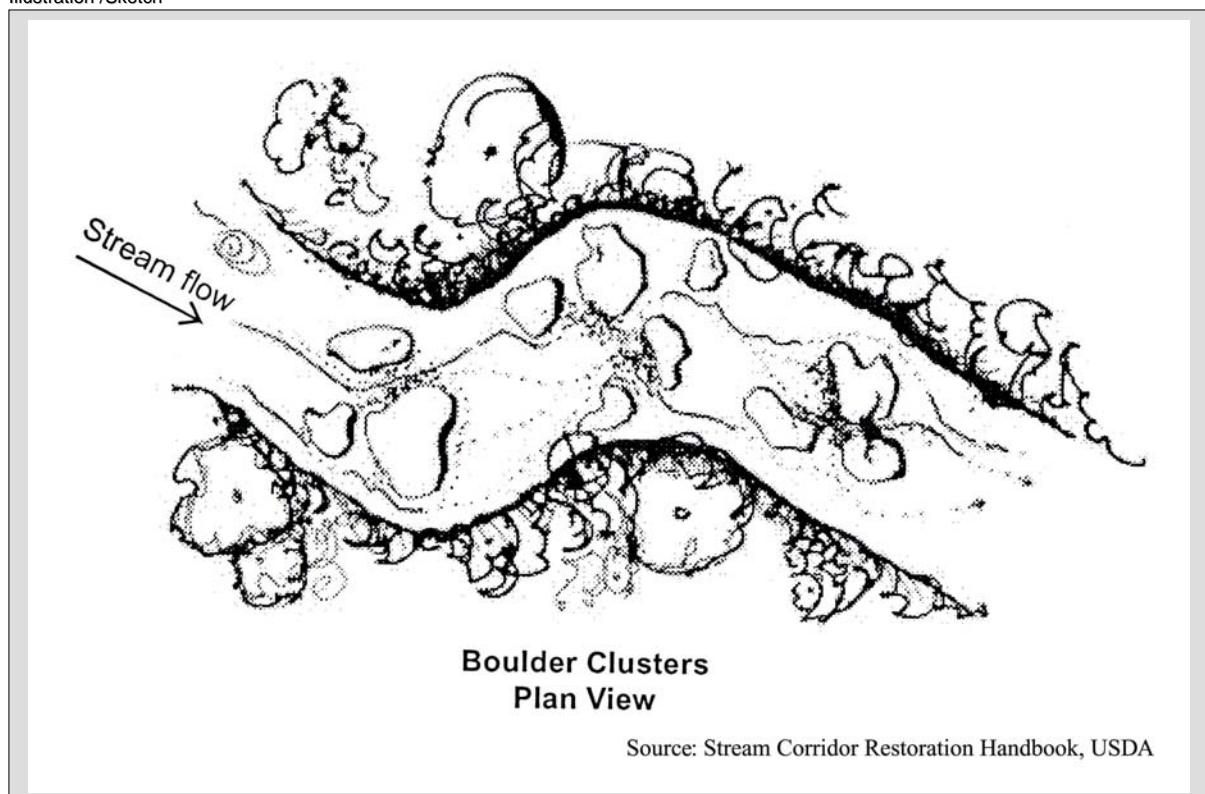



Group No

11.4

Group of measures

**In-stream habitat improvement**

Measure name

Boulder Clusters

Synonym

Gruppe vor Störstein

Maintenance

Boulder clusters are installed as part of a long term stream habitat improvement program and should require no maintenance. However even if they were placed by an experienced geomorphologist, stream behaviour is notoriously unpredictable and the geomorphologist should inspect the stream regularly to observe changes that are occurring and to suggest any remedial actions required to further improve stream habitat.

Advantages

Boulder clusters can appear quite natural. If properly placed, boulder clusters can divert erosive flows away from hazard areas. On small streams, boulders can be used as stepping stones.

Disadvantages

Boulder clusters can cause undesirable and unforeseen changes in streamflow. This may require rock to be repositioned at high cost. Freshly quarried rock will look „raw“ until weathering has taken place. Boulders must be very large to be effective and to resist movement. Large machinery is needed to place the boulders and access can be destructive of the riparian environment.

Examples

Examples

References and suggested reading

SCRH sheet 2  
Schiechtl, Hugo M.; Stern, Roland: Handbuch für naturnahen Wasserbau. Eine Anleitung für ingenieurbio-logische Bauweisen. Österreichischer Agrarverlag, Wien 1994; Begemann, Wolf; Schiechtl, Hugo M.: Ingenieurbio-logie. Handbuch zum ökologischen Wasser- und Erdbau. Bauverlag, Wiesbaden 1994; Zeh, Helgard: Ingenieurbio-logische Bauweisen, Studienbericht Nr. 4, 1993. Eidgenössisches Verkehrs- und Energiedepartement, Bundesamt für Wasserwirtschaft, Bern 1993.

Example Photos

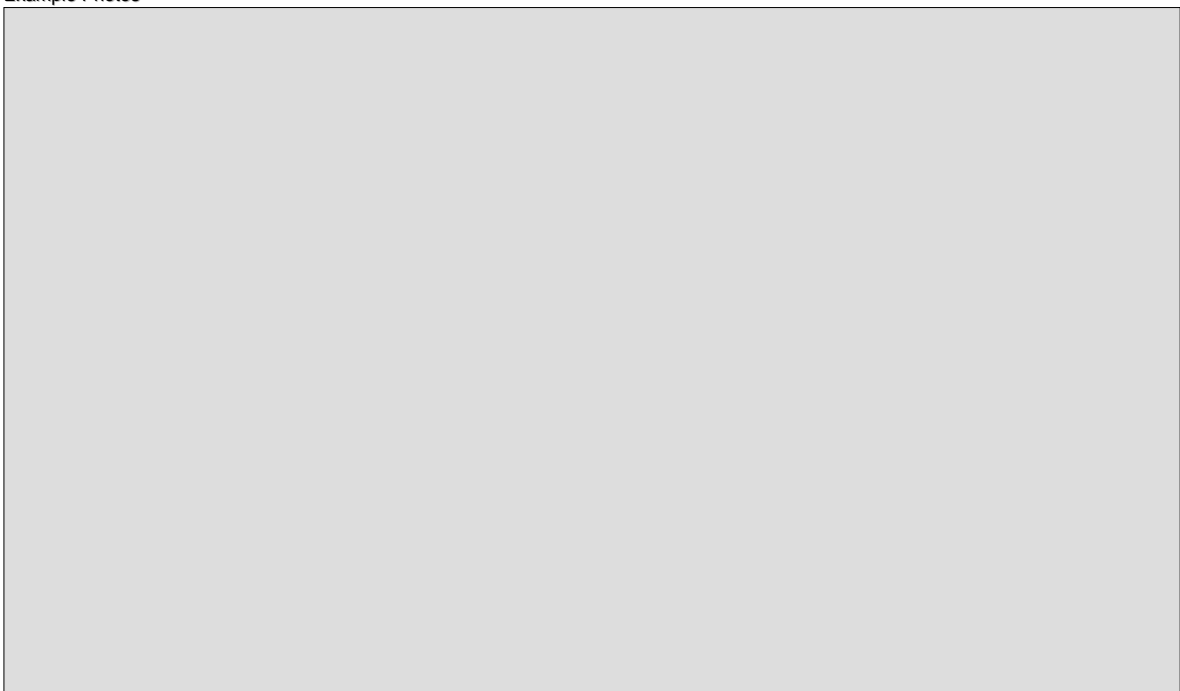

Group No

Group of measures

12.1

### Flood damage control

Measure name

Levees and Floodwalls

Synonym

Deiche, Hochwasserschutz

Purpose

Walls or embankments, usually parallel to the river channel designed to prevent flooding of critical sites on the floodplain. Sometimes they are used to prevent smaller floods but to allow flooding during exceptionally large storm events

Applications

Applicable to protect structures in all flood-prone areas. However they should not be used for new development which should not be permitted in flood-prone areas. It must be understood that preventing flooding in an area will reduce the storage capacity of the flood plain and exacerbate flooding elsewhere. In the past, levees have also been used to prevent flooding of agricultural land. This should not be permitted unless provisions are made to allow land to be flooded during very large storm events.

Description

Rivers and streams build natural levees along their banks. As soon as a flood spills out of the channel onto the flood plain, its velocity will fall and sediment will be deposited. The bulk of the sediment, made up of larger particles will be deposited first, gradually building up a shallow embankment. Finer sediments are deposited on the flood plain beyond. Man has reinforced these naturally occurring embankments, at first to reduce the frequency of flooding on the flood plain in order to farm it. Levees also confined larger flows to the channel and the scouring effect of higher velocities avoided the need for constant dredging to make the channel navigable. However, the embankments were not large enough to prevent larger floods which continued to spread over the flood plain. As earthmoving capabilities have grown, levees were made larger and larger until it appeared that they gave total flood protection and more development followed the agriculture. But that was optimistic, and it will never be cost effective to construct a levee that gives complete protection. Levees can still be used to reduce the frequency of flooding on agricultural land, but it should not be permitted unless provisions are made to allow land to be flooded during very large storm events (as is the case with several major river systems). New agricultural development in the flood plain is rarely appropriate as it requires drainage of wetland. Levees should not be built in the "open floodway" district where they will not only obstruct flood flows but also reduce flood storage capacity and increase the chance of catastrophic failure. Levees must also be fitted with valves or gates that allow the area behind the levee to drain if flooding has occurred. This also applies to areas subject to tidal flooding. Flood walls are used instead of levees where space is limited. They are one of four types; cantilever with sheet piling, cellular, gravity or counterfort.

Illustration /Sketch

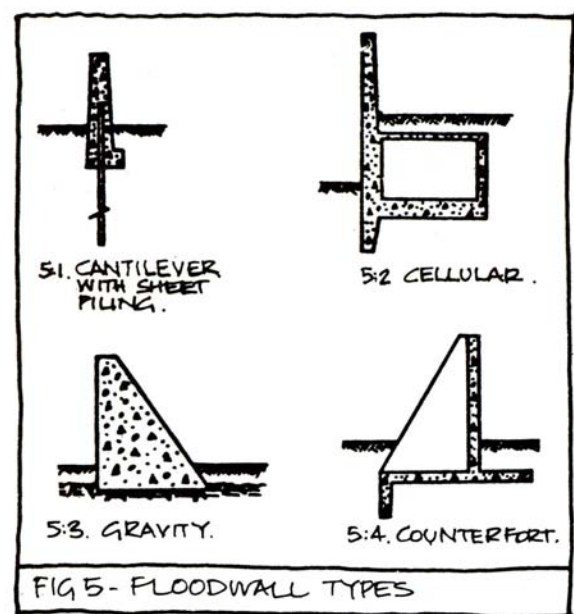
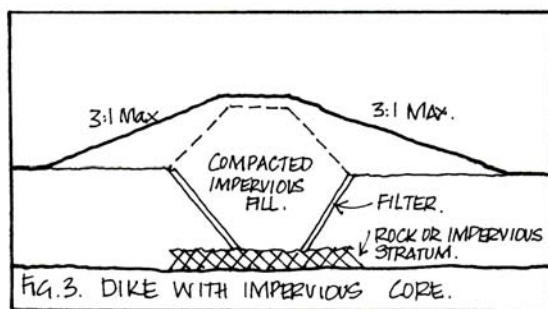

Group No

12.1

Group of measures

**Flood damage control**

Measure name

Levees and Floodwalls

Synonym

Deiche, Hochwasserschutz

Maintenance

The maintenance of levees and flood walls is mostly concerned with insuring their structural integrity. Any crack or hole will rapidly enlarge due to the pressure differential on each side of the structure. It is also important to drain the toe of the slope on the landward side and to keep the water level depressed by pumping into the river. This will also make it possible to drain the developed area behind the levee or wall. It may be feasible to retrofit existing levees with sluices to allow the land beyond to be flooded during critical flood events. In these cases, it is essential for a clear priority to be established for flooding areas that enjoy only partial protection from levees and that the authority to flood the areas is clearly assigned and based on a sound interpretation of flood warning systems.

Advantages

When development already exists in the flood plain, some flood protection can be achieved using levees or flood walls. Levees will often provide an ideal access route for many uses including maintenance and recreation.

Disadvantages

Areas protected from flooding by levees or flood walls represent a corresponding loss of flood storage. These structures can never give total protection from flooding and the false sense of security which they tend to engender often leads to inappropriate development of flood-prone areas. Levees or flood walls can totally obscure views of the river from the landward side.

Examples

Photo: A temporary floodwall assembled after a flood warning  
Source: Aqua-Stop Hochwasserschutz GmbH, Neuwied, Germany

References and suggested reading

WRPT sheet 1:22  
Tourbier, J. Toby; Westmacott, Richard: Water Resources Protection Technology. A Handbook of Measures to Protect Water Resources in Land Development. ULI- The Urban Land Institute; Washington, D.C. 1981.

Example Photos



Group No

Group of measures

12.2

### Flood damage control

Measure name

Flood Proofing and Water Pollution Control

Synonym

Struktur Hochwasserschutz

Purpose

Below flood level oil tanks should be anchored to prevent flotation and leakage. Sewer lines should be equipped with flood proof lids and sewage treatment plants should be flood proofed. The storage of materials that are toxic, explosive when exposed to water, or buoyant (drift solids) should be prohibited. Storage facilities, trunk sewers, and wastewater treatment plants are often located in flood plains and are sources of water pollution during flood events. Pollutants may include sewage, stored gasoline, LNG, various toxins and also materials such as lumber and empty containers. Relocation of facilities is the preferred solution but if this is not feasible, various measures are required to prevent these problems.

Applications

All floodplains should be carefully inspected to identify possible sources of pollution during flooding and measures taken to minimize the problem.

Description

Effective and well enforced development control in flood-prone areas is the key to preventing sources of water pollution in the flood plain. But some remedial measures will probably be needed. Any storage tanks below flood level must be anchored to prevent flotation and leakage but storage of any toxic or explosive material should be prohibited entirely in the flood plain. Sewer lines should be equipped with flood proof manhole covers and sewage treatment plants should be flood proofed with a levee or flood wall (see measure 12.1) built to exclude a 100 year flood. The storage of materials that are buoyant should be prohibited in flood prone areas. Lumber yards fall into this category. Graveyards that are already in flood-prone areas should be retrofitted to prevent flotation of coffins but new cemeteries should not be permitted in the flood plain.

Illustration /Sketch

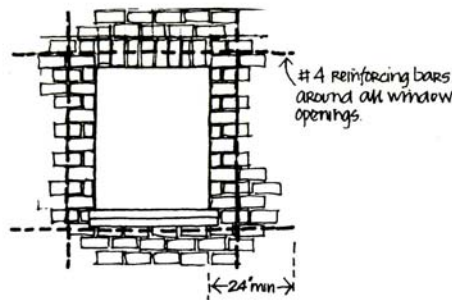

Reinforced window openings.

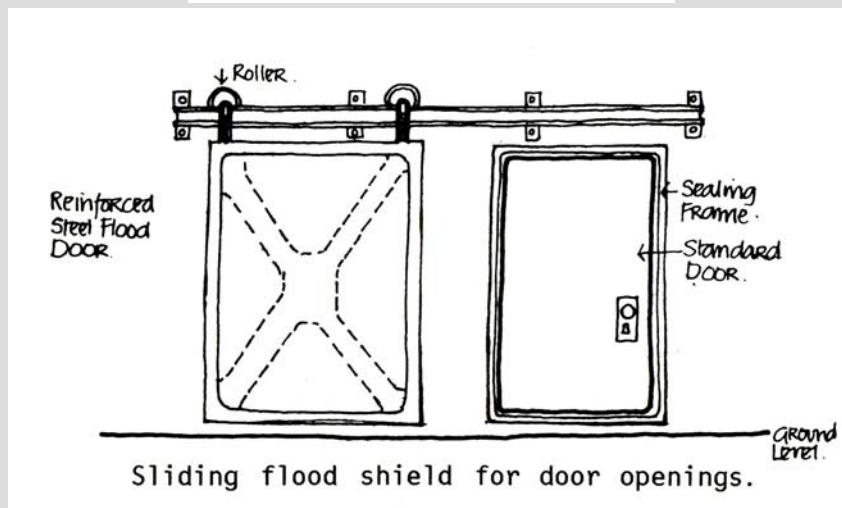

Group No

12.2

Group of measures

**Flood damage control**

Measure name

Flood Proofing and Water Pollution Control

Synonym

Struktur Hochwasserschutz

Maintenance

The effectiveness of these measures is mostly dependent on enforcement of regulations rather than maintenance. Failure to enforce the measures will result in a large maintenance task in clearing and disposing of drift solids. Large drift solids can also result in damage to riverine structures downstream. Leakage of sewers and treatment facilities during flood events may also result in pollution fines. Effectiveness also depends on good maintenance and management of private businesses and properties.

Advantages

Control of sources of water pollution from development in the flood plain will also have aesthetic benefits. Controlling the source of bouyant materials will reduce the problem of drift solids littering the riparian zone downstream of a developed area.

Disadvantages

In older urban areas, there are large numbers of developments in the flood plain that pose different problems each requiring a different solution. It may be difficult to get individual property owners to clean up debris after a flood event.

Examples

Photo: Gates at windows in the City of Wörth a. Main, Germany permit flood proofing of structures, avoiding flood damage and flood related water quality problems.

References and suggested reading

Lebensqualität durch Hochwasserschutz - Alt - Wört,- Stadtteil mit Zukunft.  
Herausgeber: Wasserwirtschaftsam  
Aschaffenburg, Germany

Example Photos



Group No

Group of measures

12.3

### Flood damage control

Measure name

Emergency Access and Flood Warning Systems

Synonym

Zugang für Rettungsfahrzeuge, Flut Warnsystem

Purpose

Structures should be accessible by elevated access ramps and catwalks. For structures with high intensity uses access ramps need to be suitable to be used by emergency vehicles. Flood warning systems for communities should be developed to be timely, accurate and neighbourhood specific. To provide early warning of potentially damaging flood events that are as accurate and area specific as possible. To provide access to critical facilities located in flood prone areas during flood events.

Applications

Flood warning systems are applicable to all flood prone areas. Access to facilities in the flood plain during a flood event may be critical for some uses such as wastewater treatment plants. Early warning is also critical for flood managers on controlled river systems who are responsible for allowing flooding of some rural areas to relieve pressure on urban areas.

Description

Early flood warning systems are essential for all food-prone areas to avoid danger and property damage. Flooding due to the cresting of flood flows in major river systems are easier to predict than local flash flooding due to convectional storms. On controlled river systems, it is usual to allow some rural areas to flood to relieve pressure on urban areas downstream. In these cases, it is essential that the sequence of flooding be based on a sound interpretation of flood warning systems. Clearly assigned responsibilities and procedures on receiving food warnings are critical. Structures can be made accessible during floods by elevated access ramps and catwalks, but care should be taken to avoid exacerbating the turbulence of flood flows. For some structures with high intensity uses, access ramps must be accessible by emergency vehicles. The columns on which elevated structures are built must be designed not only to withstand storm flows but also the accumulation of floating debris that may increase loading greatly.

Illustration /Sketch

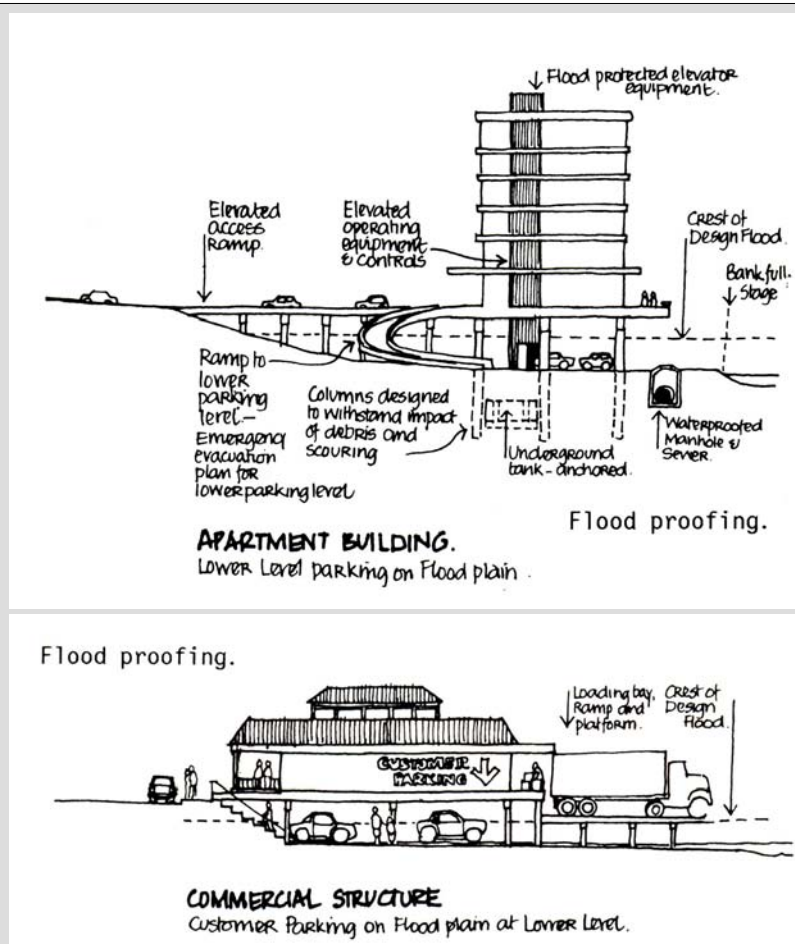

Group No  
12.3

Group of measures  
**Flood damage control**

Measure name  
Emergency Access and Flood Warning Systems

Synonym  
Zugang für Rettungsfahrzeuge, Flut Warnsystem

Maintenance  
Periodic practice of flood drills are advisable and help to educate all who live or work in food-prone areas about the nature of floods and effective actions that can be taken. These drills will also draw attention to emergency routes that must be kept clear at all times in case of emergency.

Advantages  
Flood warning systems can allow sufficient time to evacuate threatened areas. They can also give time for emergency prevention measures to be taken.

Disadvantages  
Electronic warning devices, such as TV and radio may be damaged by the storm causing the flood

Examples  
The Master Plan for the "Hafencity" waterfront development calls for elevated emergency routes and pedestrian catwalks at an elevation of 7.20 m to permit evacuation during flood events.  
Source: City of Hamburg, Germany

References and suggested reading  
Tourbier, J. Toby; Westmacott, Richard: Water Resources Protection Technology. A Handbook of Measures to Protect Water Resources in Land Development. ULI- The Urban Land Institute; Washington, D.C. 1981.

Example Photos

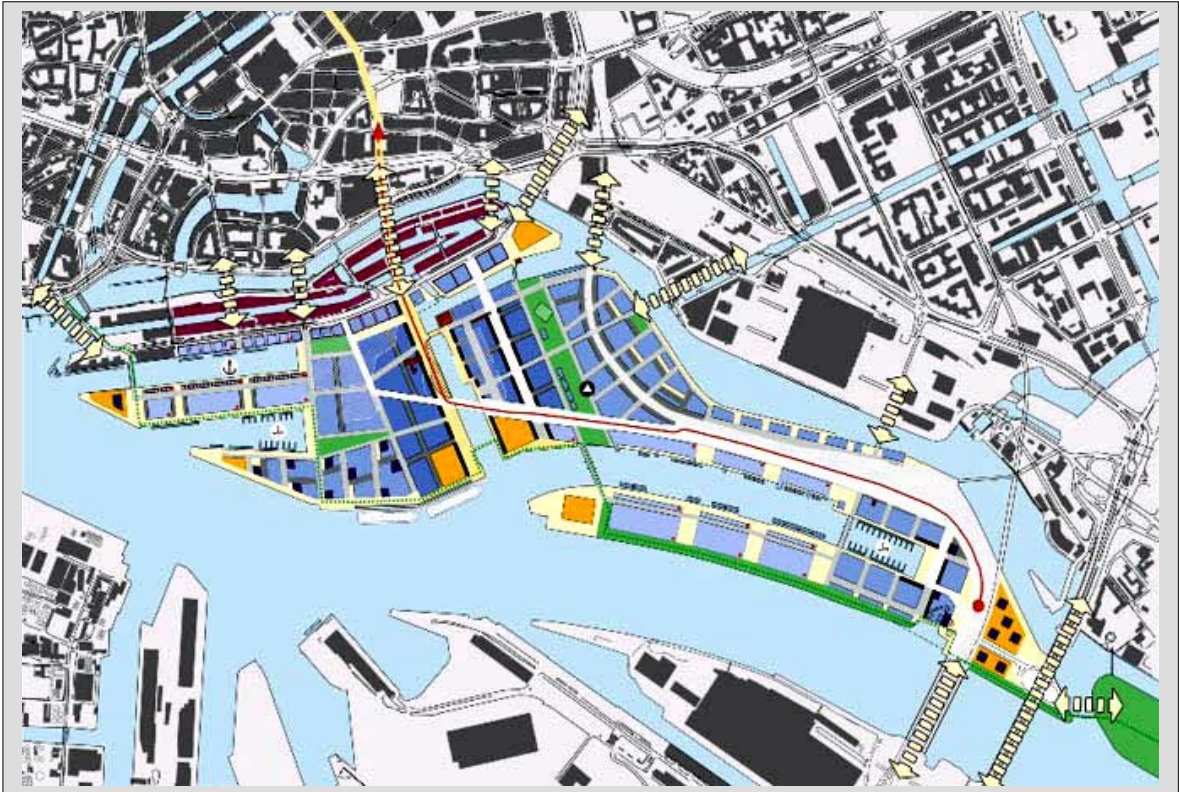

## References

- Begemann, Wolf; Schiechtl, Hugo M.: *Ingenieurbiologie. Handbuch zum ökologischen Wasser- und Erdbau*. Bauverlag, Wiesbaden 1994.
- BNatSchG, Gesetz über Naturschutz und Landschaftspflege, § 1, §2.
- DVWK, Deutscher Verband für Wasserwirtschaft und Kulturbau e.V.: *Fluss und Landschaft – ökologische Entwicklungskonzepte*. Wirtschafts- und Verlagsges. Gas und Wasser, Bonn 1996
- Galli, John : *Peat-Sand Filters : A proposed Stormwater Management Practice for Urbanized Areas*. Metropolitan Washignton Council of Governments, Dept. of Environmental Programs; Washington, D.C. 1990.
- Leopold, L.B., M.G. Wolmann, and J.P. Miller, *Fluvial Processes in Geomorphology*, W.H. Freeman, 1964.
- Ministry of Natural Ressources: *Natural Channel Systems. An Approach to Management and Design*. Natural Ressources Information Centre, Ontario 1994.
- Olson, Julie (Ed.): *Stream Corridor Restoration. Principles, Processes, and Practices*. The Federal Interagency Stream Restoration Working Group, 1998.
- Patt, Heinz; Jürging, Peter; Kraus, Werner: *Naturnaher Wasserbau. Entwicklung und Gestaltung von Fließgewässern*. Springer-Verlag, Berlin 1998.
- Reeder, Rachel (Ed.): *A Watershed Approach to Urban Runoff. Handbook for Decisionmakers*. Terrene Institute; Washington, D.C. 1996.
- Schiechtl, Hugo M.; Stern, Roland: *Naturnaher Wasserbau. Anleitung für ingenieurbiologische Bauweisen*. Ernst& Sohn, Berlin 2002
- Schueler, Tom: *Site Planning for Urban Stream Protection*. The Center for Watershed Protection, Silver Spring; Metropolitan Washignton Council of Governments, Dept. of Environmental Programs; Washington, D.C. 1995.
- SWG, Sächsisches Wassergesetz § 78 Abs. (2).
- Tourbier & Walmsley, Inc.: *London Grove Township Stormwater Management Guidance Manual*. London Grove Township Board of Supervisors, Philadelphia 1996.
- Tourbier, J. Toby; Westmacott, Richard: *Lakes and Ponds – Second Edition*. ULI- The Urban Land Institute, Washington, D.C. 1992.
- Tourbier, J. Toby; Westmacott, Richard: *Water Resources Protection Technology. A Handbook of Measures to Protect Water Resources in Land Development*. ULI- The Urban Land Institute, Washington, D.C. 1981.
- Tourbier, Joachim Toby: *Blue-Green Technologies. Integrated Practices to Manage Stormwater as an Asset*. Great Swamp Watershed Ass.; Madison, N.J. 2002.
- Tuttle, Ronald W.: *Soil Bioengineering for Upland Slope Protection and Erosion Reduction*. In: U.S. Dept. of Agriculture, Soil Conservation Service: *Engineering Field Handbook*, Chapter 18. Washington 1992.
- USDA, <http://www.wcc.nrcs.usda.gov/wtecoilbio.html> , 2003
- Zeh, Helgard: *Ingenieurbiologische Bauweisen, Studienbericht Nr. 4, 1993*. Eidgenössisches Verkehrs- und Energiedepartement, Bundesamt für Wasserwirtschaft, Bern 1993.



