



# Illinois Biodiversity Basics

a biodiversity education program of

Illinois Department of Natural Resources  
Chicago Wilderness  
World Wildlife Fund







Adapted from *Biodiversity Basics*, © 1999,  
a publication of World Wildlife Fund's *Windows on the Wild*  
biodiversity education program. For more information see  
<[www.worldwildlife.org/windows](http://www.worldwildlife.org/windows)>.

# TABLE OF CONTENTS

About <i>Illinois Biodiversity Basics</i> .....	2
Biodiversity Background .....	4
<i>Biodiversity of Illinois</i> CD-ROM series .....	6

## Activities

<b>Section 1: What is Biodiversity?</b> .....	7
 Activity 1-1: What's Your Biodiversity IQ? .....	8
Activity 1-2: Sizing Up Species .....	19
Activity 1-3: Backyard BioBlitz .....	31
Activity 1-4: The Gene Scene .....	43
<b>Section 2: Why is Biodiversity Important?</b> .....	61
 Activity 2-1: The Nature of Poetry .....	62
Activity 2-2: The Spice of Life .....	67
Activity 2-3: Secret Services .....	72
<b>Section 3: What's the Status of Biodiversity?</b> .....	87
 Activity 3-1: Endangered Species Gallery Walk .....	88
Activity 3-2: The Case of the Greater Prairie-Chicken .....	101
Activity 3-3: Space for Species .....	111
<b>Section 4: How Can We Protect Biodiversity?</b> .....	133
 Activity 4-1: Future Worlds .....	134
Activity 4-2: Career Moves .....	147

## Appendices

Vocabulary .....	162
Scientific Names .....	166
Conceptual Framework and Correlation to <i>Illinois Biodiversity Basics</i> .....	168
Correlations and Planning Charts	
 Cross-Reference and Planning Charts .....	170
Correlation to Illinois Learning Standards and Benchmarks .....	174
Correlation to Subject Areas .....	175
Correlation to Skills .....	176
Correlation to Time Required .....	177
Resources .....	178
Action Projects .....	179
Distribution Information .....	181
Credits .....	182
Illustration List By Common Name and By Page Number .....	183
Activities (alphabetical order) .....	184

Equal opportunity to participate in programs of the Illinois Department of Natural Resources (IDNR) and those funded by the U.S. Fish and Wildlife Service and other agencies is available to all individuals regardless of race, sex, national origin, disability, age, religion or other non-merit factors. If you believe you have been discriminated against, contact the funding source's civil rights office and/or the Equal Employment Opportunity Officer, IDNR, One Natural Resources Way, Springfield, IL 62702-1271; 217/785-0067; TTY 217/782-9175. This information may be provided in an alternative format if required. Contact the IDNR Clearinghouse at 217/782-7498 for assistance. Printed by the authority of the State of Illinois 1M - 5/02



## About *Illinois Biodiversity Basics* Relevance of Biodiversity

Humans are part of an incredibly complex and interdependent web of life, and we're just beginning to understand our place in it. We're beginning to realize how dependent we are on biodiversity for most, if not all, our needs. We're also beginning to realize that a significant loss of biodiversity could seriously undermine our long-term economic, intellectual, physical and emotional well-being. Why haven't we been more aware of biodiversity and its importance before now? The answer may be partly due to our loss of intimacy with other living things. In many cases we've lost contact with the natural foundations on which our lives are built. Our ignorance of nature and the way it works may be catching up with us. The challenge now is to learn as much as we can to gain a new perspective on our place in the natural world, so that not only will we be better able to protect living things, but we'll also create a more sustainable and responsible society.

The diversity of life on earth shapes and nourishes every facet of our existence. But the connections between species are seldom obvious. Due to a variety of factors (see page 4), biodiversity is rapidly declining. To ensure the long-term health of the planet, an informed and motivated citizenry needs to be developed that understands what biodiversity is and why it's important. Citizens are needed who have the skills and confidence to rise to the challenge of protecting biodiversity and who feel empowered to do so. Education is one of the best tools for achieving this goal.

In education, biodiversity is an important topic that encompasses many disciplines and provides real-world contexts and issues that promote critical- and creative-thinking skills, citizenship skills and informed decision-making. Biodiversity also illustrates the complexity of environmental issues and the many perspectives and much uncertainty connected with them.

## Overview

*Illinois Biodiversity Basics*, adapted from World Wildlife Fund's *Windows on the Wild: Biodiversity Basics*, is designed to provide ideas for integrating biodiversity into your teaching. The activities are **targeted to grades five through eight** but several may be adapted for use at other grade levels as well. The Illinois-specific activities are not meant to cover every aspect of biodiversity, but you should find plenty of information to introduce the topic and take students through levels of increasing complexity. The activities may be completed in any order and may be used singly or in units. Use as many as you have time for to supplement your teaching and bring biodiversity to life for students.

## Goal and Outcomes

The goal in developing this booklet was to provide Illinois educators with a method to introduce students in grades five through eight to local biodiversity concepts, issues and conservation. Upon completing the entire unit students should: 1) possess a basic understanding of species, ecosystem and genetic diversity; 2) be able to explain the role biodiversity plays in ecosystem stability and health; 3) be able to report on the current status of biodiversity; and 4) know strategies to employ for biodiversity conservation and preservation.

## Concepts and Principles

The conceptual framework for *Illinois Biodiversity Basics* was developed and organized around four major themes (pages 168-169):

- What is Biodiversity?**
- Why is Biodiversity Important?**
- What's the Status of Biodiversity?**
- How Can We Protect Biodiversity?**

The themes were chosen because they encompass the essential components of quality environmental education materials: awareness; knowledge; attitudes; skills; and participation. Standards-led learning objectives accompany each of these themes as does the exploration of clearly identified concepts (for a correlation of the activities to standards-based concepts see the Conceptual Framework and Correlation to *Illinois Biodiversity Basics* on page 168).

---

*Illinois Biodiversity Basics* is built on a set of underlying principles about education. The activities are based on many familiar strategies and approaches from constructivist learning to innovative assessment strategies, group-learning, problem-solving and interdisciplinary teaching.

## Format

*Illinois Biodiversity Basics* was designed to give educators access to as much information as possible in an easy-to-use format. You'll find an overview of Illinois biodiversity (pages 4-5) followed by 12 field-tested, standards-led activities. While designed with specific learning standards in mind (standards-led), the activities also allow educators to help meet other learning standards. Each activity provides basic information and detailed procedures. The Appendices include supplemental material such as vocabulary definitions, scientific names for species used in the text, the conceptual framework and activity correlations to the Illinois Learning Standards and Benchmarks, subject areas and skills. Cross reference and planning charts provide an overview of all 12 activities "at-a-glance."

### ***Illinois Biodiversity Basics and Windows on the Wild***

*Illinois Biodiversity Basics* is adapted from World Wildlife Fund's (WWF) publication, *Windows on the Wild: Biodiversity Basics*.<sup>\*</sup> Through the cooperative efforts of WWF, the Illinois Department of Natural Resources and Chicago Wilderness, Illinois has become the first state to publish its own version of this curriculum guide to exploring the web of life.

### ***Windows on the Wild***

If you are interested in teaching more about biodiversity, you may want to obtain a copy of the educator and student guides for *Windows on the Wild: Biodiversity Basics* and/or other materials from WWF. The core of the *Windows on the Wild* (WOW) program is a series of middle school modules on key topics related to biodiversity, including *Biodiversity Basics*, *Wildlife*

*for Sale*, *Marine Biodiversity* and *Building Better Communities*. Each module contains background information, resource ideas and unit plans for the educator, as well as creative and challenging interdisciplinary activities for students. *WOW* curriculum materials are designed to help students explore the social, scientific, economic and ethical issues surrounding biodiversity and to give them the knowledge and skills they need to build a more sustainable future. Working with partners around the world, WWF developed a Biodiversity Education Framework to help guide people in life-long learning about biodiversity, sustainability and conservation.

*Windows on the Wild: Biodiversity Basics* is available for purchase from Acorn Naturalists at [www.acornnaturalists.com](http://www.acornnaturalists.com) or 800/422-8886. Visit WWF's Internet site at <http://www.worldwildlife.org/windows/biobasics.html> for more information.



<sup>\*</sup>*Windows on the Wild* is funded with major support from Eastman Kodak Company. Additional support has been provided by the Environmental Education and Training Partnership, the Evan Frankel Foundation, the Ittleson Foundation, John and Adrienne Mars, the Mars Foundation, the McKesson Foundation, the National Environmental Education and Training Foundation, the National Fish and Wildlife Foundation, the Pew Charitable Trusts, the U. S. Fish and Wildlife Service and the U. S. Environmental Protection Agency.



## Biodiversity Background

### What is Biodiversity?

Biodiversity is the variety of life on earth. There are three levels of biodiversity: species diversity; ecosystem diversity; and genetic diversity. *Species diversity* includes all living things from the tiniest bacterium to the large white-tailed deer and white oak tree. As of 2002, about 1.7 million species had been identified worldwide. It has been estimated that the number of species on earth is somewhere between 10 million and 300 million. Biodiversity also includes *ecosystem diversity*, the habitats that house all life forms and the interconnections that tie living things together. Ecosystem diversity includes the prairies, marshes, swamps, deciduous forests and all other environments where species live. Ecosystems not only provide habitat for species but also perform functions such as flood control and water purification. Biodiversity includes the variety within species, which is determined by the genes. *Genetic diversity* makes every living thing unique. Each species is like a book of genetic information, containing billions of genetic letters that give it a particular code of life. Its traits are the result of coded messages in the genes that are passed from one generation to the next. When a species becomes extinct, all the information is lost. Genetic diversity is a safeguard against future problems, such as disease or natural disasters.



## Why is Biodiversity Important?

Biodiversity is important for many reasons. It helps maintain the atmosphere, keeps the soil fertile, purifies water and provides other functions that enable life to exist on this planet. It provides a variety of resources and products for humans, including many foods and medical products, and is the potential source for many more. Species variety may provide the ability to avert major disasters, such as crop failures from drought and disease. Biodiversity provides products that help to boost the economy. The natural world also offers us a place to relax and reflect. Many people believe that biodiversity is important not just because it is valuable, but simply because it exists.

## What is the Status of Biodiversity?

According to the world's leading scientific and environmental experts, loss of biodiversity is one of the most urgent environmental problems facing the planet. As human populations grow, they exert increasing pressure on natural resources—pressure that is endangering species and ecosystems around the world. Habitat loss, introduced species, pollution, population growth and over-consumption are the main threats to biodiversity. The extinction of any species brings the irreversible loss of unique genetic codes and the potential loss of medicines, foods, products and jobs. At the same time, degradation of natural systems threatens the very services, such as water purification and nutrient recycling, that support all life on earth.

## Illinois: Biodiversity and the Natural Divisions

Some people believe that Illinois is a state with little more diversity than corn and soybeans. However, Illinois actually has a surprising variety of organisms and habitats. Nearly 54,000 species have been identified in Illinois so far, not including bacteria. It is believed that millions of bacterial species may exist. The rich diversity of life in Illinois is due to the variety of habitat types provided by 14 natural divisions.

The natural divisions concept is a classification system of natural environments and biotic communities based on the bedrock, glacial history, topography, soils and distribution of organisms. Each natural division contains its own similar landscapes, climate, soils and bedrock and supports similar vegetation and wildlife. In general,

---

the more natural divisions, the more species diversity. Some species live in only one or a few of the natural divisions while others are more generalized in their needs and can survive in many different habitats.

Illinois' natural divisions include the Wisconsin Driftless, Rock River Hill Country, Grand Prairie, Northeastern Morainal, Illinois and Mississippi Rivers Sand Areas, Wabash Border, Southern Till Plain, Shawnee Hills, Coastal Plain, Lower Mississippi River Bottomlands, Ozark, Middle Mississippi Border, Western Forest-Prairie and Upper Mississippi and Illinois River Bottomlands. The largest natural division in Illinois is the Grand Prairie Division. Each of these areas contains unique habitats and species. Because they are so diverse, the biodiversity in Illinois is very diverse. For more information about Illinois' natural divisions, and to see a map of them, visit <http://dnr.state.il.us/lands/education/biodiversity> on the Internet or obtain an *Illinois' Natural Divisions* poster from the Illinois Department of Natural Resources (see the "Resources" section, page 178).

## People and Biodiversity

The people of Illinois make a significant impact on the landscape and its diversity. Clearing forests, plowing prairies, draining wetlands, developing urban areas, building roads and conducting other human activities have drastically reduced the diversity of habitats in Illinois and the overall biodiversity of the state. When people alter habitats they kill and/or force out the organisms that live in them, upset ecological relationships and reduce the ecosystem's ability to perform services like flood control, water purification and nutrient recycling. Some of the habitats that originally occurred in our state can only be found in nature preserves, state parks, conservation areas and other protected sites that shelter the state's biological diversity. However, we can help protect biodiversity, a task that involves all of us. All species are significant, many in unknown but, perhaps, vitally important ways. We must value biodiversity and try to preserve it.

## How Can We Protect Biodiversity?

One of the greatest challenges we face in protecting biodiversity is how to balance the needs of the present without jeopardizing those of the future. There is no one way to address this challenge, partially because there is no single reason why we are losing biodiversity. There are several goals, however, which can be attained by people working together. One proposal is to maintain a state of relative equilibrium with our environment, called sustainability. A society that reaches sustainability is one that is able to persist for many generations without producing significant amounts of pollution, depleting natural resources and causing a decline in biodiversity. Many different points of view need to be taken into consideration before sustainability can be achieved. Land-use planning is needed so that space may continue to exist for species and ecosystems. Restoration of habitats is an important goal. Research must be done rapidly to find out as much as possible about what species exist, how they depend on their habitats and how habitats can be managed to ensure healthy populations. Legal protection is necessary for some species. Stewardship of natural resources should be considered when corporations make business decisions. Captive breeding can be used to increase the population of some species. Gene banks are being developed to store seeds and plant parts to preserve biodiversity for future generations. Citizens can take action in their own communities to solve biodiversity problems. Educating people about the problem will lead to better understanding and solutions. Ensuring the survival of species, genes and ecosystems will require a combination of approaches, and the collective thinking of people from all disciplines and backgrounds. It will mean fostering compassion for other species, educating ourselves about the connections among all elements of biodiversity and coming to terms with the consequences of our behavior for other people and other species.

---

Want to learn more about biodiversity? For additional information and materials about biodiversity contact the organizations responsible for bringing you this book. See the "Resources" section of the guide.



## *Biodiversity of Illinois* CD-ROM Series

You will find frequent reference made in this guide to the *Biodiversity of Illinois* CD-ROM series from the Illinois Department of Natural Resources (IDNR). The *Biodiversity of Illinois* series of CD-ROMs was developed for and mailed free of charge to Illinois schools which contain any of grades five through nine. The three CD-ROMs in the series are Illinois-specific, supplemental and searchable. The field guide design offers full-color images, life history information, sounds, tracks, Illinois range, status, habitat descriptions and images and more. Information from the CD-ROMs can be printed. The CD-ROMs run on both Windows® and Macintosh® operating systems.

For more information about the CD-ROMs, contact the IDNR Division of Education.

Illinois Department of Natural Resources  
Division of Education  
One Natural Resources Way  
Springfield, IL 62702-1271  
217/524-4126  
teachkids@dnrmail.state.il.us

### ***Biodiversity of Illinois*** ***Volume I: Aquatic Habitats***

Nine Illinois aquatic habitats and 400 Illinois species are featured in this CD-ROM that was mailed to Illinois schools in September 1999.

### ***Biodiversity of Illinois*** ***Volume II: Woodland Habitats***

Learn about 409 Illinois woodland species and four Illinois woodland habitats on this CD-ROM that was mailed to Illinois schools in March 2000.

### ***Biodiversity of Illinois*** ***Volume III: Prairie and Edge Habitats***

The final CD-ROM in the series was mailed to Illinois schools in February 2001. It contains 505 Illinois species and seven prairie and edge habitats.



## Activity 1-1 What's Your Biodiversity IQ?

### AT A GLANCE

Take a "gee-whiz quiz" to find out how much you know about biodiversity, especially in Illinois.

### OBJECTIVES

Define biodiversity, discuss facts and issues related to Illinois biodiversity, and list reasons why biodiversity is important.

### SUBJECTS

English language arts, science

### SKILLS

analyzing (discussing), interpreting (inferring, reasoning), applying (synthesizing)

### LINKS TO ILLINOIS BIODIVERSITY BASICS CONCEPTUAL FRAMEWORK

biological diversity

### VOCABULARY

biodiversity, ecosystems, genes, migration, species, plus review "What's Your Biodiversity IQ?" for words that may be unfamiliar

### TIME

one class period

### MATERIALS

copy of the "Student Pages" and copies of the "Answer Pages" for each group (or for each individual)

### CORRELATION TO ILLINOIS LEARNING STANDARDS

English language arts 1.C.2a, 1.C.3a  
science 12.B.2a, 12.B.2b, 12.B.3a, 12.B.3b

Did you know that there are insects that masquerade as plant parts, birds that map their migration by the stars, and fungi that find their way into your favorite foods? In Illinois alone, there are more than 54,000 different species of organisms. When it comes to biodiversity, these and other fascinating facts prove that truth really is stranger than fiction.

Have your students take the biodiversity quiz to learn about some of the tantalizing stranger-than-fiction tidbits that biodiversity has to offer. In the process, they'll become familiar with some important biodiversity basics.

## BEFORE YOU BEGIN

For each group of three or four students, make a copy of the quiz and the answers. Or, if you wish to place the quiz in the student's portfolio, you may have each student take the quiz.

## WHAT TO DO

### 1. Distribute the quizzes and review vocabulary.

Divide the class into groups of three or four students and give each group a copy of the quiz. Review any words that may be unfamiliar to the students. For now, don't define the word "biodiversity."

### 2. Give groups time to complete the quiz.

Assure the students that this is not a real quiz; it's simply a fun introduction to biodiversity. Also tell them that their answers won't be graded and that it's OK if many of their answers are wild guesses.

### 3. Distribute answers to the quiz.

Have the students score their tests. Afterward, discuss each of the questions and answers. How did they do? Were they surprised by any of the answers? Which ones? You may want to suggest that they take the quiz home to test family members and talk about the answers.

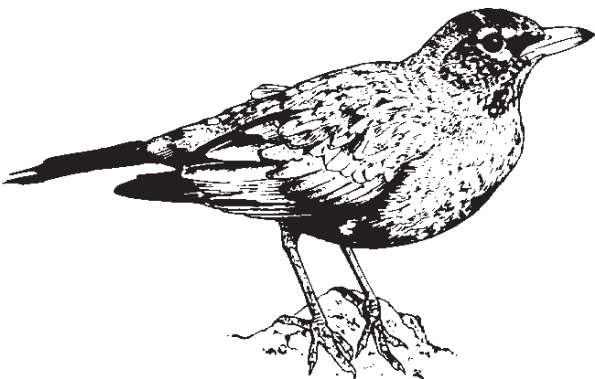





## Activity 1-1 Whats Your Biodiversity IQ? (continued)

### 4. Develop a class definition of biodiversity and a list of reasons why it's important.

Explain to the students that the quiz was designed to point out some interesting facts about the natural world, as well as to introduce the concept of biodiversity. Ask the students what they think biodiversity means, and have them write their ideas on the board. Then use the background information, along with the glossary, to explain the three levels of biodiversity (genes, species and ecosystems).

Next, have the students use the information on the board and in the quiz to list reasons biodiversity is important. Afterward, combine their group lists to form a single class list. Your class list might include food, clothing, housing, ecosystem services, natural beauty, camping and hiking.

## WRAPPING IT UP

### Assessment

1. Write each letter of the alphabet on a separate slip of paper. Fold the slips, put them into a container and have each student pick one. Then have each student write a poem or limerick about an animal, plant or other life form that lives in Illinois and starts with his or her letter. As an option, have the students draw or cut out pictures to go along with their writings and compile them into a book. Possible titles for the book include *Biodiversity A to Z*, *An Encyclopedia of Biodiversity* or *A Poetic Look at Biodiversity*. You could also have the students present their poems to younger students.
2. Students could use the *Biodiversity of Illinois* CD-ROMs from the Illinois Department of Natural Resources to write their own Illinois Biodiversity IQ quiz. They can test other students in the class or test students who are not currently studying biodiversity.

### Portfolio

Either at the beginning or end of a unit, the quiz can serve as documentation of the students' general knowledge of biodiversity, if you have each student take the quiz separately. Have the students note why

they answered as they did and record their own definition of biodiversity on the quiz.

### Extensions

1. Create a bulletin board or other display featuring the class definition of biodiversity and magazine photos and student artwork that illustrate biodiversity. Students should choose photos and create artwork that portray the different levels of biodiversity. Encourage students to connect facts from the quiz with their artwork or photos. If the class continues studying biodiversity, the bulletin board can be updated to include new knowledge and ideas.
2. Have students develop a TV or radio informational program of one to three minutes to help people understand the meaning of biodiversity. They can use the IQ test as part of the program content. Remind students that the more creative and entertaining their spots are, the more likely others are to get the message. When they've finished, have them share their efforts with the rest of the class.
3. Create a collage or diorama about Illinois biodiversity. Create and hang mobiles featuring Illinois species in the classroom.
4. Have each student select a quiz question that he/she answered incorrectly or a question that interests him/her. Ask the students to research the subject of the question and use the information they find to write a paragraph that either explains the correct answer or gives more details on the subject.
5. You can turn this activity into a quiz show game with you as the host. Give each group a copy of the quiz and choose a spokesperson for each team. Then start the game by reading a quiz question aloud. Give the groups a minute or so to discuss possible answers. Have team spokespersons raise their hands to indicate their team's readiness to answer the question and have the groups answer on a first-come, first-served basis. Score one point for each correct answer per question. If the first group misses an answer, other groups may try. Tally the points on the board and see which team wins!



## Activity 1-1 What's Your Biodiversity IQ? (continued)

### Resources

- Borror, D. J. and R. E. White. 1970. *A field guide to insects*. Houghton Mifflin Company, Boston. 404 pp.
- Hoffmeister, D. F. 1989. *Mammals of Illinois*. University of Illinois Press, Urbana, Illinois. 348 pp.
- Illinois Department of Natural Resources. *Illinois' living alphabet*. Illinois Department of Natural Resources, Springfield, Illinois. Poster.
- O'Toole, Christopher. 1995. *Encyclopedia of insects*. Checkmark Books, New York. 160 pp.
- Schwartz, C. W. and E. R. Schwartz. 1981. *The wild mammals of Missouri*. University of Missouri Press, Columbia, Missouri. 356 pp.
- Wilson, Edward O. 1992. *The diversity of life*. Belknap Press, Cambridge, Massachusetts. 424 pp.
- World Almanac Books. 1995. *1996 world almanac and book of facts*. World Almanac Books, New York. 976 pp.

---

***“Biodiversity, or natural riches, is a new term  
that describes something very old.”***

*—Alfredo Ortega, writer*

---



## Educator Page

# What's Your Biodiversity IQ? — ANSWERS

Each correct answer is worth one point, even if there is more than one correct answer per question. Maximum possible = 62 points.

**1. Which of the following could the fastest human outrun in a 100-yard race?**

- c. American woodcock
- e. wild turkey

Lots of animals are quick on their feet (or wings, or scales, or fins), but speed doesn't necessarily count much these days in the race for survival. Cheetahs, for example, are the fastest land animals in the world (may reach speeds of about 70 miles per hour)—but they're also among the world's most endangered. The fastest humans can finish a 100 yard dash in under 10 seconds. That calculates to about 25 miles per hour; although humans can't sustain that speed long term. The wart hog and domestic cat can both attain speeds of about 30 miles per hour. The wild turkey can run at about 20 miles per hour, and the American woodcock flies slowly at about five miles per hour maximum.

**2. Which of the following actually exist?**

- a. ants that "herd" aphids for food
- b. slime molds that creep across the ground
- c. trees that can grow with their roots under water

Certain kinds of ants eat the sugary substances excreted by aphids, which are insects that suck plant juices. The ants actually herd colonies of aphids by moving them from place to place and protecting them from enemies. Some slime molds have two distinct phases in their life cycle. In the reproductive phase they are stationary, like a plant with a stalk. From this stalk they produce spores. These slime molds may also exist as mobile amoeba-like organisms that feed by engulfing material. Bald cypress trees grow in swamps in southern Illinois, as well as in the southern United States. These huge trees can grow with their roots continually submerged because of their unique feature, called "knees."

**3. Which of the following animals can consume at least half of its body weight in food each day?**

- a. little brown bat
- b. masked shrew
- c. ruby-throated hummingbird

These small animals need huge amounts of food each day to survive. In fact, a mother little brown bat that is feeding babies must consume more than her body weight in insects each night.

**4. Which of the following best describes the word "biodiversity"?**

- c. the variety of all life on earth

The variety of life on earth includes plants, animals, microorganisms, ecosystems, genes, habitat diversity and more.

**5. United States Fish and Wildlife Service agents at O'Hare International Airport in Chicago once found which of the following?**

- c. 10 baby turtles

Agents at O'Hare found the baby turtles rolled up in a sock inside the back of a camera. Annual trade in wildlife and wildlife products is estimated at \$10 billion and up to 25 percent of the trade is illegal. That amounts to \$2.5 billion in black market wildlife trade—one of the largest black markets in the world!

**6. Scientists studying bug zappers have learned some interesting facts. Which of the following are among them?**

- c. Bug zappers could be bad news for certain bird, fish, bat and flower species.
- d. There are more than four million bug zappers being used in the United States.

A recent study at the University of Delaware on bug zappers came up with some "shocking" results. It revealed, for example, that many species of mosquitoes are not attracted to bug zappers at all. Instead,



## Educator Page

# What's Your Biodiversity IQ? — ANSWERS (continued)

the zappers' blue light attracts harmless insects in droves, many of which provide food for birds, bats and fishes. Some of the insects that zappers zap are also important to plants, which need the insects for pollination.

**7. Blackpoll warblers are tiny birds that migrate between North America and South America each year. Which of the following statements about them are true?**

- a. They use the stars for navigation.
- d. If they burned gasoline instead of body fat for fuel, they'd get 720,000 miles to the gallon.

Animals that migrate often have remarkable navigational skills. Many use the sun, stars, land patterns and other means to reach their destination, which may be thousands of miles and several countries away. And many migrators are able to get where they're going on very little fuel. For example, migrating birds often travel huge distances and eat very little along the way. They have incredibly energy-efficient bodies that "burn" body fat for fuel. Some birds, such as the tiny blackpoll warbler, get the equivalent of thousands of miles per gallon of fuel! But being able to get from point A to point B doesn't matter much if the habitat an animal is traveling to has been destroyed. That's one reason why international efforts to conserve habitat are so important.

**8. Which of the following can be considered an enemy of the Great Lakes?**

- a. zebra mussel
- b. spiny water flea
- c. mercury
- d. sea lamprey

The Great Lakes are the world's largest source of fresh water. But this incredible ecosystem is facing serious threats. Nonnative species, such as the zebra mussel, sea lamprey and spiny water flea, compete for food or threaten the health of native animals. Chemicals, such as mercury, that end up in the

Great Lakes, often last forever and even enter the food chain, making fish in certain areas unsafe for humans and other animals to eat.

**9. What's the most serious threat to biodiversity?**  
b. habitat loss

All over the world habitats are being turned into agricultural land, harvested for wood and fuel, and destroyed or changed to build roads, schools, malls and other human developments. Because the human population is growing so quickly and consuming so many natural resources, habitat loss is occurring at a rapid pace.

**10. The items on the left have been (or are being) developed into important medicines for humans. Match each item with the medicine made from it by writing the letters in the appropriate blanks.**

- b** bread mold (antibiotic)
- c** willow tree (pain reliever)
- d** vampire bat saliva (medicine to unclog arteries)
- a** mayapple (heart medicine)
- e** coneflower (immune system booster)

Biodiversity is like a gigantic pharmacy. Consider plants: more than one-fourth of the drugs commonly used today were originally derived from plants. Animals are a potentially important source of medicines, too. In fact, you never know where a future medicine might pop up. Who would have thought that vampire bat saliva could be useful? No wonder researchers are looking to biodiversity to find treatments and cures for cancer, AIDS and a host of other diseases.

**11. Which of the following are true statements about little brown bats?**

- a. Baby bats weigh 20 to 25 percent of their mother's weight at birth.
- b. Heart rate during flight can reach 1,000 beats per minute.
- d. A little brown bat may live 20 to 30 years.



## Educator Page

# What's Your Biodiversity IQ? — ANSWERS (continued)

Bats are amazing animals. Though bats reproduce at a relatively slow rate, the large size of the babies, called pups, helps to increase the chance of survival. Little brown bats only eat insects they catch while flying. All this activity produces a heart rate of up to 1,000 beats per minute. They also have an unusually long life span for a small mammal and may live 20 to 30 years.

### 12. Without fungi, which of the following would you not be able to do?

- a. eat pizza topped with pepperoni and mushrooms
- b. bake bread
- c. live in a world free of dead things lying all over the place
- d. put blue cheese dressing on your salad

While some forms of fungi may seem less than noble—athlete's foot fungus, for example—the world could not function long without these humble life forms. Fungi and bacteria play a key role in breaking down organic matter and recycling it back into usable nutrients. Without them, dead things would definitely pile up! Besides, without fungi we wouldn't have tasty treats such as mushrooms, yeast bread or blue cheese.

### 13. Which of the following statements are true?

- c. More than 5,000 different kinds of potatoes have been identified in South America's Andes Mountains.

The potato actually originated in South America. In Peru, some family farmers grow as many as 12 kinds of potatoes. Can you imagine eating purple potato chips or red mashed potatoes? It's possible with the thousands of kinds of potatoes out there. Most supermarkets, however, carry only four or five different varieties. And most of the country's baking potatoes are grown in Idaho. (Washington is the second largest producer of potatoes.)

### 14. Which of the following are actual species of animals found in Illinois?

- a. antlion
- b. hoary elfin butterfly
- c. pimpleback
- d. hoop snake



These are just a few examples of some of the many strange and wonderful creatures of Illinois. The antlion is an insect that can be found throughout the state. Its larva hides in the bottom of a small, cone-shaped pit dug in dirt or sand, waiting to eat ants and other small insects that fall in. The hoary elfin butterfly is a small, gray-brown butterfly that is endangered in Illinois. It lives in northeastern Illinois, most often along the shore of Lake Michigan, and is one of the first butterflies of spring. The pimpleback mussel is found statewide. It can live up to 100 years. No snakes actually form hoops and roll like a hula hoop although there is a mud snake that is sometimes called a hoop snake.

### 15. If you decided to throw a party to celebrate the diversity of life on earth and wanted to send an invitation to each species, how many invitations would you need?

- d. more than 1.5 million

Scientists have estimated that as many as 100 million species may actually exist—they just haven't gotten around to identifying all of them yet.

### 16. Which of the following statements about short-tailed shrews are true?

- a. Your cat may bring one to you.
- b. They use a form of echolocation, like bats.
- c. Shrews are known as the "tigers of the small animal world."
- d. Shrews are venomous.

Short-tailed shrews are seldom seen in nature because of their size and ability to hide, although, house cats seem to find their share. Short-tailed shrews make up for their poor eyesight by using a



## Educator Page

# What's Your Biodiversity IQ? — ANSWERS (continued)

form of echolocation to find their food. Shrews are without a doubt one of the most ferocious mammal predators. Once they catch their prey, their venomous saliva immobilizes it.

**17. If the number of species on earth was represented by physical size, which of the following would most accurately illustrate the proportion of insects to mammals?**

- c. There are approximately 250 insect species to every mammal species—and that includes only the insects we know about. Scientists think there are millions more species yet to be discovered.

**18. Biodiversity includes:**

- a. the color of your eyes
- b. the creatures in your neighborhood soil
- c. Illinois
- d. your classmates

Biodiversity describes the incredible variety of life on earth—and that includes the diversity among genes (which control inherited traits like the color of your eyes), species (from huge whales to tiny soil creatures) and ecosystems (from lush cypress swamps to the harsh environmental conditions of a prairie).

**19. If we gave a prize for “the strongest creature for its size,” which of the following would win?**

- c. ant

An ant can carry a load up to 50 times its body weight.

**20. Which of the following would people have to do without if there were no bees?**

- a. almonds
- b. honey
- c. cucumbers
- d. apples
- e. celery



Bees are worth billions of dollars to the agriculture industry. Each year bees pollinate millions of acres of almond and apple trees, cucumbers and celery. Other favorite foods we'd miss without bee pollinators include watermelons, avocados, plums, pears, blueberries, cranberries, cherries and cantaloupes.

**21. Which of the following is an example of an ecosystem service?**

- a. a ladybird beetle that protects your garden by eating aphid pests
- c. a wetland that filters dirty water
- d. an ocean that controls the earth's climate

Ecosystem services include the “free services” provided by ecosystems around the world—and which most of us take for granted. For example, wetlands help control floods, filter pollutants from water and provide habitat for all kinds of birds, fishes and other animals. Ladybird beetles eat aphids, which are common garden pests. And oceans act as a giant thermostat, interacting with the atmosphere and land to control earth's climate.

**22. Some of the world's most fascinating creatures live in really unusual places. Which of the following is sometimes a home for another living thing?**

- a. a caterpillar's abdomen
- b. a termite's gut
- c. a white-tailed deer's intestine
- d. a human's forehead

The larva of a tomato hornworm may become host to the eggs of the parasitic ichneumon wasp. As the wasp larvae develop, they use the caterpillar for food. Deep within a termite's gut lives a tiny protozoan that helps to digest the termite's woody diet. The white-tailed deer belongs to a group of hoofed mammals that have bacteria living in their digestive tracts. The primary type of bacteria changes through the year to insure the deer can always digest the available food source, that is, green plants in the spring and summer and bark, twigs, grain and acorns in fall and winter. Without



## Educator Page

# What's Your Biodiversity IQ? — ANSWERS (continued)

knowing it, most human beings have mites on their forehead. Mites are slender creatures with a worm-like body and a spidery head. A mite is so small it is almost invisible. One species (*Demodex folliculorum*) dwells in the hair follicles, and another (*Demodex brevis*) lives in the sebaceous glands.

**23. If you had a job that put you in charge of saving all Illinois species on the edge of extinction, how many endangered and threatened species would you need to save?**

d. 478

You'd be pretty busy conserving habitats for 478 species. And that's only the number of species of plants and animals listed as threatened and endangered in Illinois by the Illinois Department of Natural Resources (1999). Some scientists estimate that up to 27,000 species become extinct worldwide each year, and we never even knew that most of them existed.

**24. The white fringed orchid was once common in the prairies of Illinois. Which of the following statements explains why this plant is now endangered in Illinois?**

c. Habitat loss due to agriculture and development.

Habitat loss is the number one threat to plants and animals. Most of the wet prairie habitat favored by the orchid has been drained and used for agriculture or development. In Illinois, only 0.07 percent of native prairies remain undisturbed.

**25. Which of the following environments on our planet are too harsh to support life?**

e. none of the above

Amazingly, life has been discovered in all of these harsh environments. Newly identified microorganisms called "extremeophiles" thrive in unimaginable conditions, like boiling sulfur springs and polar ice fields.

---

*“When it is asked how much it will cost to protect the environment,  
one more question should be asked:*

*How much will it cost our civilization if we do not?”*

*—Gaylord Nelson  
politician, conservationist*

---



## Student Page

# What's Your Biodiversity IQ?

Here's your chance to find out what you know about the world's diverse plants, animals and natural places. For each question, circle all the correct answers.

- Which of the following could the fastest human outrun in a 100-yard race?**
  - cheetah
  - wart hog
  - American woodcock
  - domestic cat
  - wild turkey
- Which of the following actually exist?**
  - ants that "herd" aphids for food
  - slime molds that creep across the ground
  - trees that can grow with their roots under water
  - none of the above
- Which of the following animals can consume at least half of its body weight in food each day?**
  - little brown bat
  - masked shrew
  - ruby-throated hummingbird
  - none of the above
- Which of the following best describes the word "biodiversity"?**
  - endangered species
  - different kinds of planets in the solar system
  - the variety of all life on earth
  - biographies about famous biologists
- United States Fish and Wildlife Service agents at O'Hare International Airport in Chicago once found which of the following?**
  - 18 California kingsnakes
  - 45 pounds of elephant ivory
  - 10 baby turtles
  - 16 vampire bats
- Scientists studying bug zappers have learned some interesting facts. Which of the following are among them?**
  - Insects are attracted to bug zappers because of the zappers' smoky smell.
  - Bug zappers are great for ridding summer nights of mosquitoes.
  - Bug zappers could be bad news for certain bird, fish, bat and flower species.
  - There are more than four million bug zappers being used in the United States.
- Blackpoll warblers are tiny birds that migrate between North America and South America each year. Which of the following statements about them are true?**
  - They use the stars for navigation.
  - They make frequent pit stops at fast-food restaurants.
  - They don't really need to migrate.
  - If they burned gasoline instead of body fat for fuel, they'd get 720,000 miles to the gallon.
- Which of the following can be considered an enemy of the Great Lakes?**
  - zebra mussel
  - spiny water flea
  - mercury
  - sea lamprey
- What's the most serious threat to biodiversity?**
  - scientists collecting specimens
  - habitat loss
  - tourists
  - pollution

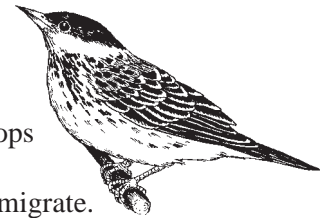





## Student Page

### Whats Your Biodiversity IQ? (continued)

**10. The items on the left have been (or are being) developed into important medicines for humans. Match each item with the medicine made from it by writing the letters in the appropriate blanks.**

- |                       |                                |
|-----------------------|--------------------------------|
| __ bread mold         | a. heart medicine              |
| __ willow tree        | b. antibiotic                  |
| __ vampire bat saliva | c. pain reliever               |
| __ mayapple           | d. medicine to unclog arteries |
| __ coneflower         | e. immune system booster       |

**11. Which of the following are true statements about little brown bats?**

- Baby bats weigh 20 to 25 percent of their mother's weight at birth.
- Heart rate during flight can reach 1,000 beats per minute.
- Little brown bats drink the blood of birds and small mammals.
- A little brown bat may live 20 to 30 years.

**12. Without fungi, which of the following would you not be able to do?**

- eat pizza topped with pepperoni and mushrooms
- bake bread
- live in a world free of dead things lying all over the place
- put blue cheese dressing on your salad

**13. Which of the following statements are true?**

- Potatoes originated in Ireland.
- The United States grows most of its baking potatoes in Washington.
- More than 5,000 different kinds of potatoes have been identified in South America's Andes Mountains.
- The French fry, invented by Madame Bonaparte during the French Revolution, became one of Napoleon's favorite snacks.

**14. Which of the following are actual species of animals found in Illinois?**

- antlion
- hoary elfin butterfly
- pimpleback
- hoop snake

**15. If you decided to throw a party to celebrate the diversity of life on earth and wanted to send an invitation to each species, how many invitations would you need?**

- 150
- about 3,000
- 652,983
- more than 1.5 million

**16. Which of the following statements about short-tailed shrews are true?**

- Your cat may bring one to you.
- They use a form of echolocation, like bats.
- Shrews are known as the "tigers of the small animal world."
- Shrews are venomous.

**17. If the number of species on earth was represented by physical size, which of the following would most accurately illustrate the proportion of insects to mammals?**

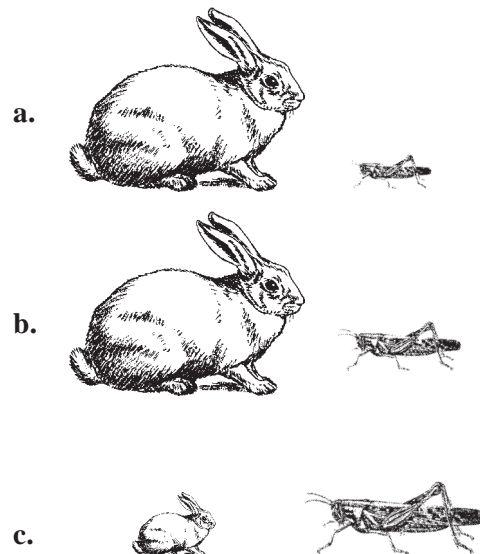

(—continued)



## Student Page

# What's Your Biodiversity IQ? (continued)

### 18. Biodiversity includes:

- a. the color of your eyes
- b. the creatures in your neighborhood soil
- c. Illinois
- d. your classmates

### 19. If we gave a prize for “the strongest creature for its size,” which of the following would win?

- a. bobcat
- b. bald eagle
- c. ant
- d. turtle

### 20. Which of the following would people have to do without if there were no bees?

- a. almonds
- b. honey
- c. cucumbers
- d. apples
- e. celery

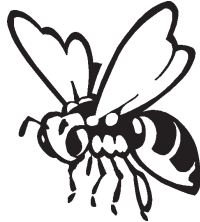

### 21. Which of the following is an example of an ecosystem service?

- a. a ladybird beetle that protects your garden by eating aphid pests
- b. a company that rakes people's yards
- c. a wetland that filters dirty water
- d. an ocean that controls the earth's climate

### 22. Some of the world's most fascinating creatures live in really unusual places. Which of the following is sometimes a home for another living thing?

- a. a caterpillar's abdomen
- b. a termite's gut
- c. a white-tailed deer's intestine
- d. a human's forehead

### 23. If you had a job that put you in charge of saving all Illinois species on the edge of extinction, about how many endangered species would you need to save (based on what we know today)?

- a. 12
- b. 250
- c. 917
- d. 478

### 24. The white fringed orchid was once common in the prairies of Illinois. Which of the following statements explains why this plant is now endangered in Illinois?

- a. The extreme temperatures due to global warming prevent this sensitive plant from producing seeds.
- b. People dig up the plants to use in their flower beds.
- c. Habitat loss due to agriculture and development.
- d. It is the favorite food of white-tailed deer.

### 25. Which of the following environments on our planet are too harsh to support life?

- a. boiling sulfur springs, where temperatures are commonly 212° Fahrenheit (100° Celsius)
- b. deep-sea hydrothermal vents called “smokers,” where the temperature can reach 662° Fahrenheit (350° Celsius)
- c. the frigid ice of the Arctic and Antarctic
- d. all of the above
- e. none of the above





## Activity 1-2 Sizing Up Species

### AT A GLANCE

Classify organisms using a classification flow chart, play a team game to find out how many species may exist within different groups of organisms, and make a graph to illustrate the relative abundance of living things.

### OBJECTIVES

Use a classification flow chart to classify organisms. Name the major groups of organisms and the relative number of species identified worldwide and statewide in each group. Construct bar graphs that compare the number of species, both worldwide and statewide, in different groups of organisms.

### SUBJECTS

mathematics

### SKILLS

organizing (classifying, estimating, graphing), analyzing (calculating), interpreting (relating)

### LINKS TO ILLINOIS BIODIVERSITY BASICS

#### CONCEPTUAL FRAMEWORK

species diversity; species

#### VOCABULARY

abdomen, antennae, appendages, arthropod, bacteria, biosphere, cephalothorax, class, classification, evolution, family, fungi, genus, kingdom, order, organism, phylum, species, taxonomy

#### TIME

two class periods

#### MATERIALS

**Part I**—copies of “Arthropod Pictures” and “Arthropod I.D. Chart” for each student; (optional: scissors and glue)

**Part II**—for each group, a stack of 100 sheets of paper, a ruler, a set of number cards; signs for organism groups; markers; tape or glue; (optional: calculator)

**Part III**—graph paper (four sheets per student or group); rulers; colored pencils

#### CORRELATION TO ILLINOIS LEARNING STANDARDS

mathematics 6.C.2a, 6.C.3a, 6.D.2, 6.D.3, 10.A.2a, 10.A.3a

Did you know that a single tree in a rain forest can be home to more than 1,000 different kinds of insects? Or that a coral reef can support as many as 3,000 varieties of fish and other organisms? Or that the deep ocean floor may be home to more than 10,000 species of living things? The sheer number of organisms living on earth is extraordinary. So far, scientists have identified about 1.7 million species worldwide, but there are actually many more. Estimates range from 3 million to more than 100 million.

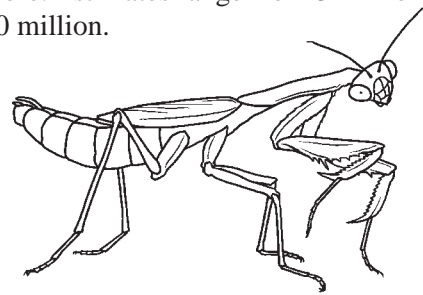

This activity will help your students understand how scientists classify organisms and how many species have been identified within various groups. They’ll discover, for example, that there are nearly 950,000 different species of insects compared to about 4,000 mammal species. And there are still vast numbers of insects that are waiting to be identified—even though about 7,000 new insect species are described every year! Did you know that the state of Illinois has about 17,000 native insects species, but only about 60 species of mammals? And that there are approximately 2,500 species of plants in Illinois? The state of Illinois has more than 54,000 species of organisms. New species are still being discovered in Illinois. For example, in 1999, three spider species were discovered in Lake County. Much work remains to be done in identification of invertebrates and microscopic species.

Part I introduces students to the biological classification system by guiding them through the identification of selected orders within the Phylum Arthropoda. In Part II, students work in teams to estimate the total number of species and the number of species in various organism groups. In Part III, students learn if their estimations were correct and then create graphs that illustrate which organism groups contain the most species that have been identified to date.



## Activity 1-2 Sizing Up Species (continued)

### BEFORE YOU BEGIN! PART I

Make a copy of the “Arthropod Pictures” and the “Arthropod I.D. Chart” for each student. Depending on your students’ choices, you may also need scissors and glue.

### WHAT TO DO! PART I

#### 1. Introduce classification.

Begin by explaining to your students that scientists classify living things into various groups. The system they use classifies organisms into ever more closely related groups and gives scientists from all over the world a common way to refer to particular organisms. To give the students a sense of how this classification system works, use the following information to compare the classification of a house cat with a dog (see “Classification Chart”). The students should notice that the cat and the dog share many classification groupings. Cats and dogs are in the same kingdom, phylum, class and order, but they belong to different families. You might also ask the students to name other species that would be in the same family as a house cat (lynx, bobcat, lion, tiger, puma and other cats) as well as other species that would be in the same family as a dog (wolf, fox, coyote, jackal and so on). You can also have the students name nonmammal chordates (animals with a backbone like fishes, amphibians, reptiles and birds) or noncat and nondog carnivores (bears, raccoons, weasels, mongooses and so on).



### Classification Chart

	<u>House Cat</u>	<u>Dog</u>
Kingdom:	Animalia	Animalia
Phylum:	Chordata	Chordata
Class:	Mammalia	Mammalia
Order:	Carnivora	Carnivora
Family:	Felidae	Canidae
Genus:	<i>Felis</i>	<i>Canis</i>
Species:	<i>Felis catus</i>	<i>Canis familiaris</i>



#### 2. Use the “Arthropod I.D. Chart” to introduce the process of classifying organisms.

Hand out a copy of the “Arthropod Pictures.” (Please note that this is a simplified chart and that all classes and orders in the Phylum Arthropoda are not represented.) Start by writing the names of the five kingdoms on the board or overhead (see page 30). Ask your students if they can describe some of the characteristics of organisms that would be classified in each kingdom. Ask them if they can name which kingdom includes humans. Then ask them which kingdom they think the organisms included in the “Arthropod Pictures” belong to (Animalia). Ask them to look carefully at the drawings and try to determine what characteristics all these organisms share. Students may notice that all the organisms pictured have jointed legs, antennae and other appendages. They may also know that all the organisms have a hard outer shell (exoskeleton). These common characteristics help organize them into a group, or phylum, within the Kingdom Animalia called Arthropoda. Arthropoda means “jointed feet.”

Hand out the “Arthropod I.D. Chart” and explain that the organisms in the Phylum Arthropoda can then be classified into different subgroups including subphyla and classes, which share more specific characteristics. For example, arthropods that are members of the class Insecta have six legs and a body that is divided into three major parts—head, thorax and abdomen. Scientists use keys such as this to identify unknown organisms and relate them to other more familiar species. Write the following vocabulary definitions on the board to help your students when using the chart.

#### appendage

any body part that extends outward from the main body, or trunk, of an animal, such as a leg, claw or antenna

#### antenna (singular), antennae (plural)

sensory appendage located on the head or cephalothorax of some arthropods

# SORTING OUT TAXONOMY

## Naming Things

The work of classifying organisms is done by scientists called taxonomists. Taxonomists divide organisms into a hierarchical series of more and more specific groupings. The most general division of life is into five kingdoms: Monera, Protista, Fungi, Plantae and Animalia. (See page 30 for a description of each kingdom.) Within each kingdom, there are groups of increasing specificity, each one containing fewer species of increasingly close evolutionary relationships to each other. These groups are phylum, class, order, family, genus and species (see page 22). This hierarchy enables taxonomists to group organisms based on their characteristics and evolutionary relationships. Species in any given order are more closely related to each other than to species in any other order; species in any given family are more closely related to each other than to species in any other family; and so on.

## What's in a Name?

Most organisms have more than one common name. For example, what some people call a woodchuck might be called a groundhog by other people. And a tree might be called downy serviceberry, shadbush or downy Juneberry, all for the same species. Or a bird might be called a house sparrow or an English sparrow, depending on who is talking about it. Common names can be very confusing! Taxonomists use Latin words to give scientific names to organisms. Not only does this clear up the confusion over common names in any one language, but it also allows scientists who speak different languages to clearly identify any particular organism or group of organisms.

When scientists refer to a particular organism by its scientific name, they are using a combination of the genus (plural: genera) and species (singular and plural) to which the organism belongs. For example, a coyote is referred to as *Canis latrans* (*Canis* is the genus name and *latrans* is the species name). The gray wolf, a closely related species, is *Canis lupus*. The genus and species names are always italicized or underlined. The genus name is capitalized, but the species name is not.

## Keeping Relationships Straight

Figuring out just where an organism belongs—how it should be classified—is not always easy. Scientists look for structural and genetic similarities among organisms that they classify together. But differences and similarities among living things are not always clear cut. Taxonomists sometimes disagree about where organisms should be classified, how genera should be arranged within families, and so on. As new information becomes available, taxonomists often revise where an organism is placed within the classification system. For example, giant pandas, which share some characteristics with raccoons and some with bears, have long been classified, along with red pandas, in their own group. However, recent genetic analysis has confirmed that giant pandas are actually true bears, and taxonomists are revising the species' classification based on those findings.

## Defining a Species

A species is a population of organisms that interbreeds and produces fertile offspring in nature.

For example, the red fox and the gray fox are different species because they coexist in many areas, but they do not interbreed.

Taxonomy organizes organisms in increasing levels of specificity. A gray squirrel, for example, would be classified like this:



- Kingdom:** Animalia (animals)
- Phylum:** Chordata (animals with backbones)
- Class:** Mammalia (mammals)
- Order:** Rodentia (rodents)
- Family:** Sciuridae (squirrels and chipmunks)
- Genus:** *Sciurus* (squirrels)
- Species:** *carolinensis*

To refer to a gray squirrel, scientists call the animal by its scientific name: *Sciurus carolinensis*.



# Sample Classification: Blackpoll Warbler

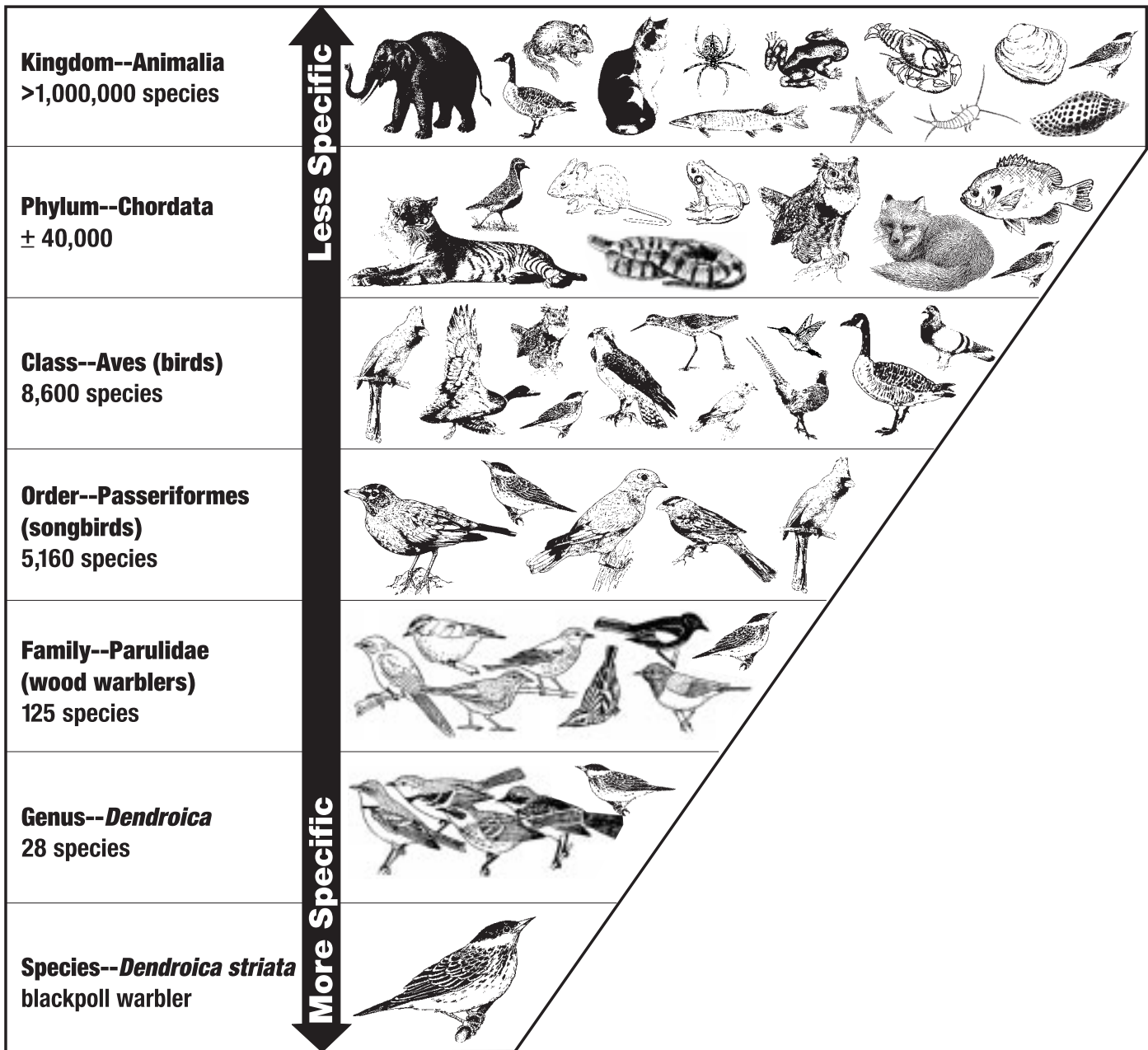

This diagram is from *Life: The Science of Biology* by Purves et al. (Sinauer Associates, Inc., 1992).



## Activity 1-2 Sizing Up Species (continued)

### 3. Use the “Arthropod I.D. Chart” to classify scorpions, spiders, centipedes and other arthropods.

Explain to your students that they will be using the identification chart to identify each of the organisms on the “Arthropod Pictures” page. Remind them that all of the organisms are in the Kingdom Animalia and the Phylum Arthropoda. Their job is to find out which class and order each organism belongs to.

Go over one example with the whole class to familiarize your students with the key. For example, hold up a picture of organism A, then ask the students to read the descriptions for each of the two subphyla on the I.D. chart and decide which subphylum organism A belongs to (Mandibulata).

Next have the students read the descriptions of each of the classes beneath Mandibulata and decide which class it belongs to (Insecta). Continue to order (Coleoptera). Once your students figure out an animal’s place on the chart, have them write the letter that corresponds to it under the order it belongs to.

Now have your students work individually or in pairs to classify each of the organisms on the “Arthropod Pictures” page. Remind the students that they need to start at the top of the chart each time. If they’d like, they can cut out the organisms and glue the pictures to the proper places on the bottom of the chart.

**Answers:** A = Coleoptera  
B = Cirripedia  
C = Scolopendromorpha  
D = Odonata  
E = Amphipoda  
F = Acari  
G = Decapoda  
H = Xiphosura  
I = Araneae  
J = Scorpionida

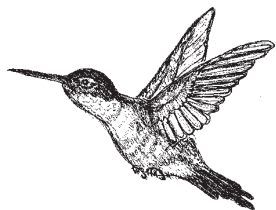

## BEFORE YOU BEGIN! PART II

Your students will be working in groups of three to five. For the math problem, each group will need a ruler and a stack of 100 sheets of paper. Calculators are optional.

You’ll also need to make a set of number cards for each group using a thick marker. To make each set of cards, you’ll need six small pieces of paper (about 4 inches x 6 inches). Write the following numbers on separate cards: 4,000; 9,000; 19,000; 72,000; 270,000; 950,000. Make another set of cards with the following numbers: 60; 400; 200; 2,500; 17,000; 20,000. (Make the numbers large enough so they can be seen from a distance.) You may want to make each set of cards a different color. (The first set relates to species worldwide, while the second set is the number of species found in Illinois.)

Next make six signs using poster-sized or butcher paper. Write one of the following words on each sheet of paper: insects; plants; mammals; birds; fungi; and fishes. Hang the signs on the walls in your classroom. Have small pieces of tape or a glue stick handy for attaching the number cards to each flip chart.

## WHAT TO DO! PART II

### 1. Discuss how many organisms there are on earth.

Ask your students to estimate how many different kinds of organisms (species) they think there are in the biosphere, both worldwide and statewide. You may first need to explain that a species is an interbreeding population of organisms that can produce fertile, healthy offspring.

Discourage students from simply guessing a total number of species. Instead encourage them to reflect on prior knowledge and observations. Allow students to discuss their reasoning. Have each student make an estimate and explain how he or she arrived at that number. If estimates are low, ask students if they considered organisms of all sizes, including microscopic organisms.



## Activity 1-2 Sizing Up Species (continued)

Finally, reveal to the students that so far scientists have identified approximately 1.7 million different organisms in the biosphere and about 54,000 species throughout the state of Illinois. But they predict that there may be an additional two to 100 million species that haven't been identified yet worldwide.

Help students gain an appreciation for how many 1.7 million is. Group the students into small teams (three to five students per team). Provide them with a ruler and a stack of 100 sheets of paper. Ask them to work together to solve this problem: If you were to write the name of every known living species (1.7 million) on a different sheet of paper and then stack up all the sheets, how tall would the stack be?

A number of different approaches may be used to solve the problem. One possible solution is to measure the height, in inches, of 100 pages, and use this measurement to calculate the height of 1,700,000 pages. Answers will vary depending on the thickness of the paper. See the "Number Crunching" box for an example.

Compare your answer to a football field, which measures 300 feet long; the Statue of Liberty, which measures 302 feet high; and the Sears Tower in Chicago which is 1,450 feet high to the top of its roof, making it the tallest building in this category in the world!

Now that students have a better feel for 1.7 million, challenge them to determine how tall the stack of paper would be if they had a sheet of paper for each species that scientists predict exists but hasn't yet been discovered—1.6 to 100 million. Have the students use the same procedure to arrive at a range representing 1.6 to 100 million. Using the same type of paper, we calculated a height of 333 feet to 20,833 feet (that's more than one to almost 70 football fields tall, or more than one to 69 Statues of Liberty tall or about one-fourth to 14 times the height of the Sears Tower.

In order to help students grasp the concept of 54,000 species in Illinois, repeat the above activity, but substitute 54,000 for 1.7 million (11.25 feet). In addition, have the students calculate what percentage 54,000 is of 1.7 million (3.18 percent).

### Number Crunching

Having trouble with the math? Follow these steps to find the height of your tower of paper.

First, measure the height in inches of a stack of 100 sheets of paper. In this example, the height is one-fourth inch. (We'll use the decimal .25.) If the height of your 100 page stack is different, substitute the measurement of your stack for the .25 used in this example.

Then, use the following ratio to find the height of 1.7 million sheets of paper.

1.  $.25/100 = x/1,700,000$
2.  $100x = .25 (1,700,000)$
3.  $100x/100 = 425,000/100$
4.  $x = 4,250$  inches
5. To calculate feet, divide by 12 inches.  
 $4,250 \text{ inches}/12 \text{ inches} = 354 \text{ feet}$

If you want to find the height of a different number of pages (1.6 million or 100 million), substitute that number of pages for 1,700,000.

### 2. Decide how many species are in each group of organisms.

Hand out a set of number cards (representing the worldwide numbers, see "Before You Begin") to each team, and explain that each card represents the number of species worldwide that scientists have identified in a particular group of organisms. Hold up a number card (for example, 19,000) and explain that 19,000 refers to the number of bird, plant,





## Activity 1-2 Sizing Up Species (continued)

mammal, insect, fish or fungi species that scientists have identified. (Remind your students that this number is not the number of individuals but the number of species—there may be millions or billions of individuals.) Now explain that each team has to work together to decide which group of organisms listed on the signs posted around the room this number refers to. Once their decisions have been made, the teams should tape their number cards on or below the appropriate signs on the wall. Teams should record their choices so they will remember them. Leave the cards on the signs. Repeat the process for the set of Illinois cards.

### 3. Discuss the students' decision-making process.

Ask your students to share the methods they used for making decisions. Did they guess or reason? Many teams may start with what they believe are

the groups with the highest and lowest number of species. Some may start with the number they are most certain about and then use a process of elimination. Other teams may base their guesses on experience and observation.

### 4. Reveal the actual numbers.

Go to each sign and tell your students the correct answers. Then have your students discuss their reactions. Did any of the answers surprise them?

#### WORLDWIDE:

Insects ..... 950,000  
Plants ..... 270,000  
Fungi ..... 72,000  
Fish ..... 19,000  
Birds ..... 9,000  
Mammals ..... 4,000

#### STATEWIDE:

Insects ..... 17,000  
Plants ..... 2,500  
Fungi ..... 20,000  
Fishes ..... 200  
Birds ..... 400  
Mammals ..... 60

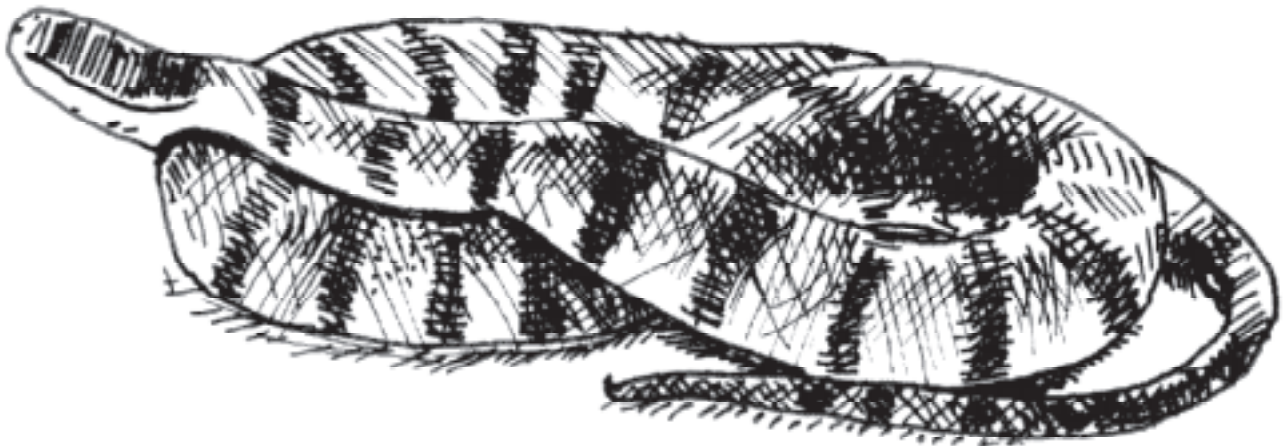



## Activity 1-2 Sizing Up Species (continued)

### BEFORE YOU BEGIN! PART III

Each student or group will need four sheets of graph paper, rulers and colored pencils.

### WHAT TO DO! PART III

#### 1. Discuss how the data can be presented in a graph. (See graph below.)

Ask your students how they would present the species data given in “Sizing Up Species” on a graph. Which format is most appropriate? (A bar graph is probably the easiest to draw, but a pie graph most dramatically illustrates the contrast in numbers of species.) Review how to set up a bar graph on the chalkboard or overhead. Explain that the vertical axis represents the number of different species in each group of organisms. The vertical axis should increase in increments of 5,000 or 10,000. They might also have each number on this

axis represent 1,000 different species, so that the number 250 on the graph would actually represent 250,000 species. The horizontal axis represents the different organism groups. You can have your students graph the groups of organisms used in Part II. Next, have them compare the species worldwide with the statewide numbers.

#### 2. Create bar graphs to illustrate the number of species in different groups of organisms.

Hand out graph paper, rulers, and colored pencils, and have your students create their own graphs of the groups of organisms used in Part II. They’ll each need about four sheets of graph paper to make room for the bar of 950,000 insect species. You can also have them make graphs using a computer. See the graph below for a sample.

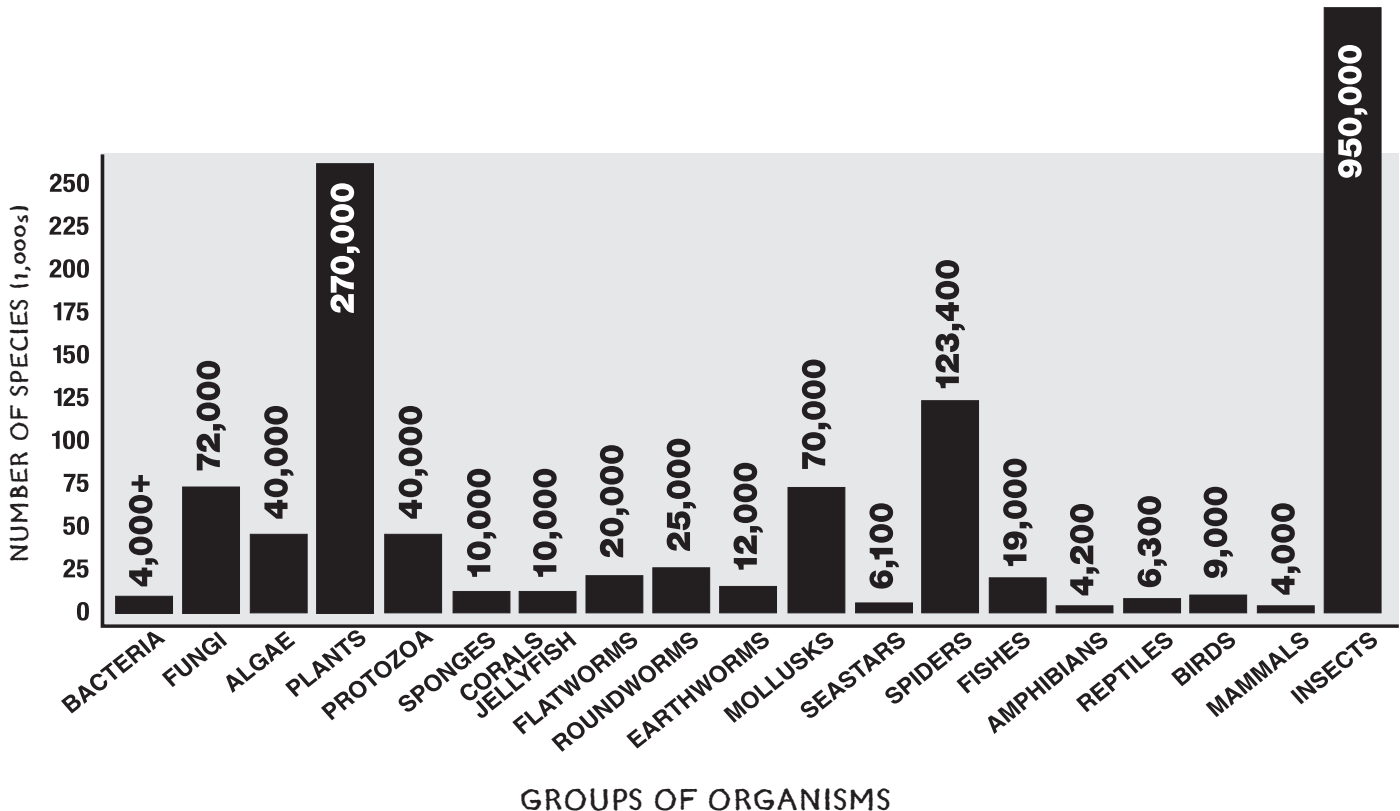



## Activity 1-2 Sizing Up Species (continued)

### WRAPPING IT UP

#### Assessment

1. Use both the classification activity and the graphing activity as bases for assessment. Have the students write an explanation of how the "Arthropod I. D. Chart" works. On the graph, have the students write the educated guesses the class discussed and how the data on the graph either do or do not support each guess.
2. Select 10 organisms from one of the *Biodiversity of Illinois* CD-ROMs. Print the information sheet for each organism and discuss the classification information. Give a set of these sheets to each student. Have the students develop their own identification chart for the organisms.
3. Have students make a collage that includes the different classifications of species or have students choose a classification, such as mammals, and make a collage of just that classification.
4. Write a short magazine article that discusses the amazing diversity of life on earth. Include illustrations and captions.

#### Portfolio

1. Graphs can be part of the portfolio. The collage could also be added to the portfolio.

#### Extensions

1. Survey the species diversity of your school grounds or a nearby park or reserve. Your students don't need to identify the species by name; they just need to be able to tell that one species is different from another. Afterward, find out if the ratios of species in different organism groups are similar to the ratios illustrated on the graphs your students made.
2. Have students research a class (or order) of organisms within the Phylum Chordata. Tell them to find out what characteristics the animals within the class share, examples of species within the class, and the approximate number of species that have been identified to date. Have each student write a para-

graph to summarize that information. Then pool the data for the group and have each student create a bar graph (on graph paper or using a computer program) that illustrates the relative numbers of species in each group. (Note: Separate the classes and orders when creating the bar graphs.)

Here are some suggested classes: Osteichthyes (bony fishes); Amphibia; Reptilia; Aves (birds); Mammalia. Here are some suggested orders: within the Class Reptilia, Testudines (turtles), Squamata (snakes, lizards); within the Class Mammalia, Insectivora (moles, shrews), Rodentia (rats, mice), Carnivora (cats, dogs, weasels, raccoons), Artiodactyla (even-toed ungulates such as deer, camels, hippos).

### Resources

- Illinois Department of Natural Resources. 1999. *Biodiversity of Illinois, volume I: aquatic habitats*. Illinois Department of Natural Resources, Springfield, Illinois. CD-ROM.
- Illinois Department of Natural Resources. 2000. *Biodiversity of Illinois, volume II: woodland habitats*. Illinois Department of Natural Resources, Springfield, Illinois. CD-ROM.
- Illinois Department of Natural Resources. 2001. *Biodiversity of Illinois, volume III: prairie and edge habitats*. Illinois Department of Natural Resources, Springfield, Illinois. CD-ROM.
- May, R. M. 1992. How many species inhabit the earth?" *Scientific American* (267): 42-48.
- Wilson, E. O. 1987. The little things that run the world. *Conservation Biology* 1(4): 344-346.
- Wilson, E. O. 1988. *Biodiversity*. National Academy Press, Washington D.C., 538 pp.
- World Wildlife Fund. 1994. *WOW!—A biodiversity primer*. Quad/Graphics, Pewaukee, Wisconsin. 67 pp.



Student Page  
Activity 1-2  
Sizing Up Species (continued)

## Arthropod Pictures

Each of the following creatures represents a general group of arthropods. First identify all 10, then write the letter of each one in the correct place on the Arthropod I.D. Chart.

     **A**     

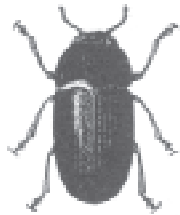

     **B**     

     **C**     

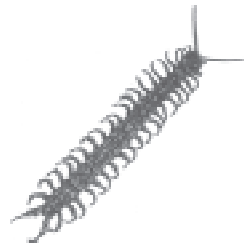

     **D**     

     **E**     

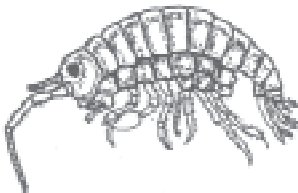

     **F**     

     **G**     

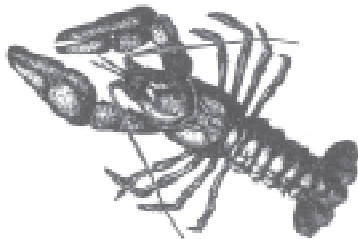

     **H**     

     **I**     

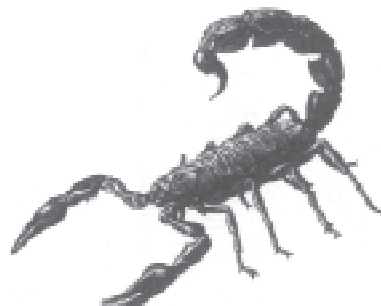

     **J**

# Arthropod I.D. Chart

**Kingdom Animalia**  
 Many-celled organisms with specialized tissues, most with organs or organ systems. Unlike plants, they cannot make their own food. Animal cells do not have cell walls.

**Phylum Arthropoda**  
 Animals with a segmented body, segmented legs, and other appendages, an external skeleton (exoskeleton) and soft internal organs.

**Subphylum Chelicerata**  
 No antennae. Mouthparts consist of fangs or pincers. Two main body segments.

**Subphylum Mandibulata**  
 One or two pairs of antennae. Mouthparts consist of mandibles adapted to chewing or sucking.

**Class Merostomata**  
 Body with a broad oval shell and long slender tail. Legs not visible from above.

**Class Arachnida**  
 Eight legs. Live mostly on land.

**Class Crustacea**  
 Two pairs of antennae and at least five pairs of leg-like appendages.

**Class Chilopoda**  
 Long and worm-like, with one pair of legs per body segment.

**Class Insecta**  
 One pair of antennae. Six legs and three body parts. Usually have wings.

**Order Xiphosura**  
 Large compared to other arthropods. Live in salt water. The only order in its class.

**Order Scorpionida**  
 Front claws. Have a tail with a poisonous stinger.

**Order Acari**  
 Tiny head. Rounded body with no waist.

**Order Araneae**  
 Thin waist. Structures for spinning silk located on abdomen.

**Order Cirripedia**  
 Most adults live firmly attached to an object and use feathery legs to filter food from water.

**Order Decapoda**  
 First pair of legs usually has large claws. Most live in salt water.

**Order Amphipoda**  
 Seven pairs of leg-like appendages.

**Order Scolopendromorpha**  
 21 or 23 pairs of legs.

**Order Odonata**  
 Large compound eyes. Four clear or patterned wings. Long abdomen.

**Order Coleoptera**  
 Hard, leathery front wings cover membranous (softer) hind wings. Chewing mouthparts.

ANSWER:

ANSWER:

ANSWER:

ANSWER:

ANSWER:

ANSWER:

ANSWER:

ANSWER:

ANSWER:

ANSWER:



Student Page  
 Activity 1-2  
 Sizing Up Species (continued)

# KINGDOMS

## Monera

The monerans are the earth's bacteria.\* They are single-celled organisms that are organized into two divisions—those that obtain energy by making their own food (autotrophs) and those that eat other organisms to obtain food (heterotrophs). Unlike the cells of other organisms, a moneran's cell has no nucleus, which is the control center in the cells of other organisms. In fact, monerans do not have many of the structures found in the cells of other living things. Monerans are one of the oldest life forms on earth. Scientists estimate that the earth is about 4 billion years old and that the monerans have been around for 3.5 billion years.

## Protista (or Protocista)

The kingdom Protista consists of single-celled organisms. Protists have a nucleus as well as other cell structures that perform specific jobs. Protists include certain types of algae, slime molds, amoebas and diatoms.

## Fungi

Most fungi are made of many cells. Mushrooms, molds, yeasts and mildews are examples of fungi. Until recently, fungi were classified as plants. Scientists now place fungi in their own kingdom because, unlike plants, they are not able to make their own food from sunlight, carbon dioxide

and water. Instead, they get their food energy by digesting the organisms on which they grow (usually plants).

## Plantae

As you might guess, this is the kingdom of plants. Most plants produce their own food energy through photosynthesis—a chemical reaction involving sunlight, carbon dioxide and water in the presence of chlorophyll. Flowering plants, mosses, ferns and certain types of algae are members of this kingdom.

## Animalia

Most animals are multicellular organisms that have specialized tissues, organs and organ systems. Unlike plants, animals cannot make their own food, and their cells don't have cell walls. Fishes, amphibians, reptiles, birds, mammals and insects and other invertebrates are all part of the Kingdom Animalia.

\*The number of kingdoms is often under debate, depending on how scientists interpret current research. For example, some scientists separate the monerans into two kingdoms: eubacteria (bacteria that get their nourishment from other living things) and archaebacteria (recently discovered bacteria that make their own food and live in extremely harsh conditions such as hot springs and hydrothermal vents).

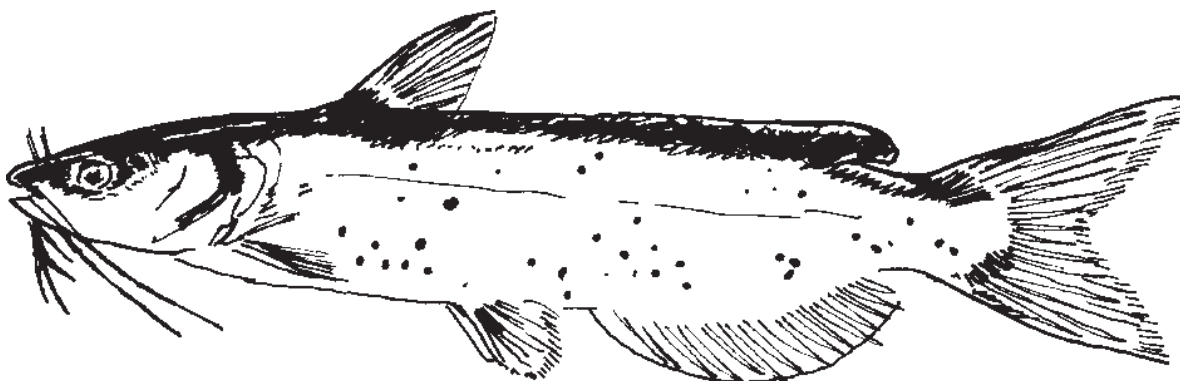



## Activity 1-3 Backyard BioBlitz

### AT A GLANCE

Answer an ecoregional survey, then take a firsthand look at biodiversity in your community.

### OBJECTIVES

Name several native Illinois plants and animals and describe your local environment. Design and carry out a biological inventory of a natural area.

### SUBJECTS

English language arts, science, social science

### SKILLS

gathering (collecting, observing, researching), organizing (classifying), analyzing (discussing, questioning)

### LINKS TO ILLINOIS BIODIVERSITY BASICS

#### CONCEPTUAL FRAMEWORK

species diversity

### VOCABULARY

ecoregion, ground-truthing, gall, migration, native species, noxious, precipitation, rapid assessment, sampling

### TIME

Part I—long-term project  
Part II—two class periods

### MATERIALS

Part I—copies of "Ecoregional Survey" for each student and for each group; field guides; and other research materials

Part II—copies of "BioBlitz Survey" for each group; (optional: thermometers; magnifying glasses; binoculars; and field guides)

### CORRELATION TO ILLINOIS LEARNING STANDARDS

English language arts 3.C.2a, 3.C.2b, 3.C.3b, 4.B.2a, 4.B.2b, 4.B.3a, 5.A.2a, 5.A.3b, 5.B.3a, 5.C.2a, 5.C.2b, 5.C.3b  
science 13.B.2e, 13.B.2f  
social science 16.E.3C

You don't have to travel to the rain forests of the Amazon or the coral reefs of Australia to discover biodiversity. Just walk out the door and you'll find an amazing diversity of life in backyards, vacant lots, streams and ponds, fields, gardens, roadsides and other natural and developed areas. In this activity, your students will have a chance to explore the diversity of life in their community. They'll also get an introduction to how scientists size up the biodiversity of an area—and why it's so hard to count the species that live there.

## BEFORE YOU BEGIN! PART I

You will need to gather field guides and other resources about your area. To best prepare your students for this activity, acquire resources in advance. Suggested Illinois resources can be found in the "Resources" list with this activity (page 37). You can use the "Ecoregional Survey" as it is written, or you can adapt it more specifically to your area and situation. You'll need a copy for each student, plus one copy for each team of four to five students. You'll also want to take the survey yourself in order to generate possible answers. If you are unsure, you can check your answers against resources found on the "Resources" list, such as the Illinois Department of Natural Resources' *Biodiversity of Illinois* CD-ROMs and the Chicago Wilderness' *An Atlas of Biodiversity*.

## WHAT TO DO! PART I

### An Ecoregional Survey

In this part of the activity, your students will get a chance to complete an "ecoregional survey." It is designed to get them thinking about their local area, the plants and animals that live there, and some of the factors that may affect where and how plants and animals live in your region.

Because some of the questions can require a good amount of research, Part I can be turned into a long-term project. Student groups can be assigned a particular set of questions or the entire survey to answer. Most of the answers can be obtained by using the resources listed in the "Resources" list but encourage the students to conduct other forms of research. Local nature centers, museums, libraries and the Internet can be great resources.



## Activity 1-3 Backyard BioBlitz (continued)

### 1. Take the ecoregional survey.

Give a copy of the “Ecoregional Survey” to each student and review any unfamiliar terms, such as native and introduced species. Then give students about 10 minutes to complete the survey. Afterward ask the students how they think they did. (Don’t share possible answers at this point.) Collect the completed sheets as a pretest of the students’ knowledge.

### 2. Divide the class into teams to complete the survey.

Divide your class into teams of about four students each. Give each team a clean copy of the ecoregional survey. Tell the students that the members of each team should work together to complete the survey as accurately as possible. Explain that the students can use whatever resources they can find to answer the questions, including the resources listed on the “Resources” list, additional resources you gathered, the library, the Internet, community elders or a local naturalist. Stress that they should find the most accurate information they can and encourage them to collect drawings or pictures of the animals and plants they list.

### 3. Set a time limit on research.

Give the students at least two days to find answers to the questions. If you plan on doing the entire “BioBlitz” activity, this is a good place to stop and skip ahead to Part II. Research for the “Ecoregional Survey” should be done as homework on the days you spend on Part II, the “BioBlitz Survey.” By the third day, Part II should be completed. You can go over the “Ecoregional Survey” results from their research as a wrap-up for this activity.

### 4. Go over the survey results.

Once the students have finished the survey, have them share the information they found and compare their answers to the pretest. Did students find different answers to some of the questions? (For example, how extensive was the group’s list of native plants?) What sources proved to be the most helpful? Were they surprised by any of the information they found?

The survey discussion can also be used as the wrap-up to Part II and as a way to discuss things the students observed during the “blitz.”

## BEFORE YOU BEGIN! PART II

You will need to find a nearby natural area where the students can conduct their “BioBlitz Survey.” School grounds, a nearby park or the grounds around a neighborhood nature center can all work. Just be sure that your area is safe for your students (no broken glass or other hazards) and that you have the permission of the owners, if needed. For example, if you’re using your own school grounds, you probably don’t need permission, but if you’re using a nearby city park, you should check with the city parks department first. You will also need to sketch a quick “site map” for the students. This map should show the boundaries of the study area and a rough delineation of different plant types. For example, areas with shrubs would look different from grassy areas (see sample below).

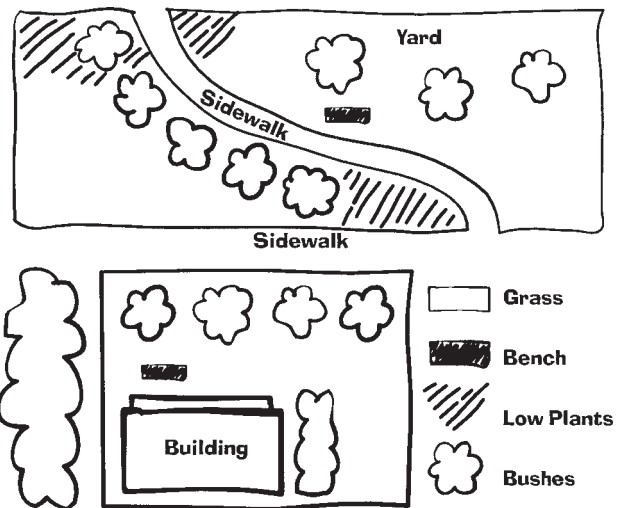

Be sure to have a copy of the “BioBlitz Survey” for each student (optional: thermometers; magnifying glasses; binoculars; and field guides). If you live in the Chicago area, you may want to borrow a *Chicago Wilderness Biodiversity Education Kit*, available from nature preserves and other sites. The kit contains field guides and rubber animal tracks that may be of value to you in this activity. Contact Chicago Wilderness (page 178) for more information and a list of checkout sites.





# Getting to Know Biodiversity

When scientists want to know what lives in a particular area or region, they rely on a number of tools and techniques. Here's a quick look at some of them.

## Bird's-Eye View

Aerial photographs and satellite images can give conservation biologists, wildlife managers and others a lot of information about a region. For example, different cover types such as coniferous forests, deciduous forests or grassy areas show up in these pictures as different colors or patterns. Scientists can use the photographs to delineate features on the ground before they ever visit an area. Knowing what grows on the ground can be useful for predicting where animals might be, whether areas could sustain certain animal populations, and for planning strategies to manage these populations. Scientists can also compare pictures taken at different times to look for changes in such things as forest cover and land-use patterns.

## See It for Themselves

No matter how much aerial photographs or satellite images tell us about a study area, scientists like to visit the area to see for themselves if the information they gleaned from the photos is accurate. The process of going to an area to verify information is called ground-truthing. Ground-truthing gives scientists a firsthand look at the areas they're interested in and can help guide further studies.

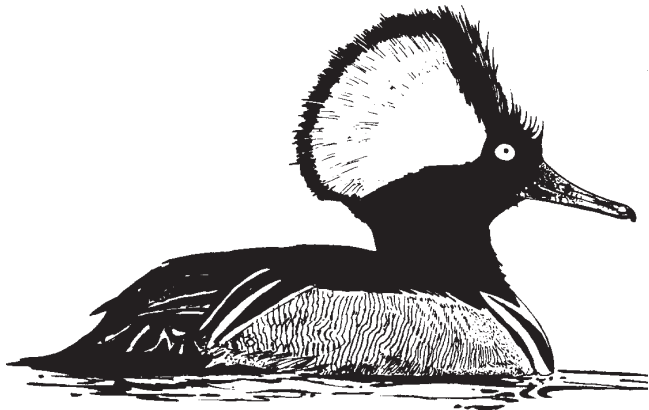

## Sampling

Scientists rarely have the time to identify every single plant and animal that lives in a particular area. And even if they did have the time, it would be extremely expensive for them to do so. For these reasons, scientists rely on statistics to get an idea of species diversity. The scientists look closely at only small portions—or samples—of the total area they're interested in. Then they use mathematics to extrapolate their findings to the larger whole. Scientists frequently use aerial photographs or satellite images to decide where to do their sampling. If an area they want to study is covered by both woodlands and grasslands, for example, scientists will take samples in both.

## Fast Fact-Finding

In the race to save the world's biodiversity, scientists have developed methods to find out as much information about a particular habitat as quickly as they can. In such rapid assessments, teams of scientists work together. Each member of the team has a specialty, such as botany (plants), entomology (insects) or ornithology (birds). The team members travel to the study area together, collect as much information as they can in the short time allowed, including carefully collecting specimens of individual organisms, and then return to their laboratories or offices to sort out and identify what they found. Rapid assessments can be particularly effective in assessing the biodiversity of remote areas where it would be too expensive to employ researchers for more extended periods of time. However, rapid assessments provide only snapshots of what's found in particular areas and usually can't cover extensive geographic areas.



## Activity 1-3 Backyard BioBlitz (continued)

### WHAT TO DO! PART II

#### A Look at Biodiversity

In this part of the activity, your students will have a chance to go outside and take a firsthand look at biodiversity in their own local environment. Observation is very important in science. This activity is a great opportunity for students to develop their observation skills. Be sure that they use objective observations: facts only; no personal feelings; no value judgements; no assumptions; no bias; measure instead of guessing.

#### 1. Set the stage.

Ask your students to imagine that the school board is planning to add a greenhouse to your school. One factor that's important in the board's decision to build is how biodiversity might be affected by the development. The board is planning to meet in just two days to decide whether or not they should add the greenhouse to the school grounds, and it has asked the students for a list, or inventory, of all the species found on the site. (Rapid assessments are usually conducted because a decision about land use must be made quickly, and the species living on the land in question are being factored into the decision. If you're in a nonformal setting or if you can't use your schoolyard for the "BioBlitz," adjust the school board scenario accordingly.)

What kinds of things would your students need to consider as they inventory the biodiversity of this area? List their ideas on the board or overhead. If the students don't suggest anything along these lines, ask them if there might be differences depending on the time of year. Would they expect to find the same species in areas covered by grass as in areas where trees grow? Do they think the relative numbers of individuals, or the population sizes, of each species might be important? Stress that knowing what lives in an area, knowing where different things live within the area and having an idea of the size of the populations of different living things are all important pieces of information that wildlife managers and conservation biologists try to find out when they investigate the biodiversity of different land areas. Save all the questions the students generate for the wrap-up (step 7).

Ask your students how they think scientists find out answers to questions like the ones they've generated. (*Scientists may use aerial photographs, satellite photos and special maps; they may interview knowledgeable people and consult historical records; and they usually go to the areas of interest and look at the plants and animals firsthand.*)

#### 2. Explain the task.

Explain to the students where their study site is located and pass out copies of the "site map" you sketched earlier. Also distribute copies of the "BioBlitz Survey." Explain each of the different biodiversity categories listed on the survey sheet and give some examples of each.

Divide the group into teams of four or five students and explain that the team members must work together to design a way to fill out their sheets as completely as possible in a relatively short time. Where are they going to look? What are they going to look for? How will they record what they find? Are they going to draw sketches of different species or take very detailed notes? How are they going to divide up the work?

Tell them they will have only 30 minutes to work at the site and let them know that they are not to bring samples back. (Remind the groups that correct identification of different species is not a necessary goal of this activity. "Green needle tree" and "shiny red bug" are as correct as "white pine" and "ladybird beetle." However, depending on your group and the time you have available, you can teach your students to use field guides and incorporate accurate species identification into the survey.)

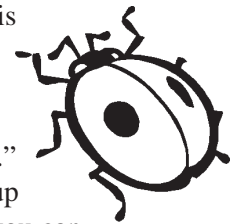

Review the range of animal signs the students should look for ("Animal Signs to Look For"). Also review the "Do's and Don'ts of Field Work," adding any additional points needed for your particular area.



## Activity 1-3 Backyard BioBlitz (continued)

Now give the students time to work in their teams to come up with their inventory plans: including roles; responsibilities (data recorder, observers, etc.); equipment needs and distribution among team members; and time allotment.

### 3. Review the inventory plans.

Once the students have designed their inventory plans, meet with each group independently and have the group explain its design. Make sure that each group has evenly divided the amount of work to be done among the group members, will be getting to all areas of the study site and has accounted for inventorying the full range of species types listed on its survey sheet.

### 4. Conduct the “BioBlitz.”

Take the students to the study area and give them approximately 30 minutes to conduct their survey. Although identification is not the ultimate goal of this activity, you might want to have field guides available for students to use to help identify what they are seeing. Remind students of safety precautions and of the “Do’s and Don’ts of Field Work.” Have the students draw sketches of items that are hard to describe or identify. Students should not collect any materials.

### 5. Finalize findings.

Give the teams time to review their results and consolidate information. Have them make notes on the sketch of the area to indicate where certain things were found or where animals or plants were concentrated.

### 6. Share results.

Have the groups report on their findings and discuss the processes they used. How many different living things did they find? Where did they find different things? Did they find any native species? Nonnative species? Were species evenly distributed across the site or did the students find greater variety in

particular areas? If there were distribution differences, where did they find the greatest diversity? Do they think that as a group they found everything out there? What factors might have affected the number of species they found? For example, would they have expected to find the same number and types of species if they’d done their “BioBlitz” at a different time of year? Or with magnifying glasses? Did one team have a way to complete the investigation that worked particularly well? What was the hardest thing about conducting their “BioBlitz?” Were they surprised by anything they found or didn’t find?

### 7. Discussion.

Have the students look back at the questions they generated in step 1 of Part II. Based on their recent field experience, is there any other information they need to know about the land in order to make a complete inventory of its biodiversity? What kinds of organisms have they probably missed? Do they think these kinds of rapid inventories are useful? *(It’s often difficult to find all the species in an area in a short amount of time. Because animals tend to come and go from different areas, they can be missed if the amount of time spent looking for them is too short. Very small or microscopic organisms can be hard to find and identify. Also, there are often seasonal changes in the organisms in an area, so an inventory conducted at one time of year might be very different from an inventory of the same area at a different time of year. But despite their problems, rapid inventories are often very useful because they are a way to quickly get a good idea of the diversity of species in an area. When time is short, a BioBlitz may be the only way to go.)*

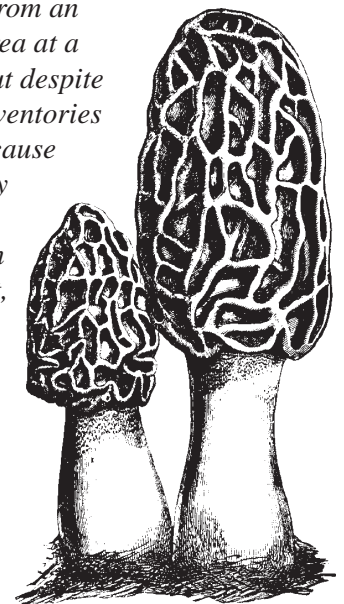



## Activity 1-3 Backyard BioBlitz (continued)

### WRAPPING IT UP

#### Assessment

1. Have each student write a newspaper article reporting the “BioBlitz” that the class conducted. The article should identify which members of the teams played what roles in the blitz, logistics of their inventory plans and biodiversity results of their “BioBlitz.”
2. Have your students write an article explaining the process they used to collect their data, including any conclusions they may have drawn during the activity. (Use the list of questions they generated in step 1 of Part II.)
3. Have student groups determine where the greenhouse should be located in the school area. This decision should be based upon the results of the “BioBlitz” and should be explained in a written

report. The written report should explore the following areas: the specific location of the greenhouse; the biodiversity that would be affected by the proposed greenhouse location; impact upon biodiversity living in the entire study area; and suggested methods of recovering biodiversity lost from habitat removal.

#### Portfolio

The “Ecoregional Survey” and “BioBlitz” survey could be added to a portfolio.

#### Extension

If you use a natural area for this activity, you can have students keep track of changes in it from season to season and year to year by comparing their data with that collected by other groups in the past. You can also do an urban blitz to identify the plants and animals that live in a city block.

---

**“One result of formal education is that students graduate without knowing how to think in whole systems, how to find connections, how to ask big questions, and how to separate the trivial from the important. Now more than ever—we need people who think broadly and who understand systems, connections, patterns, and root causes.”**

*—David Orr, writer, professor*

---



## Activity 1-3 Backyard BioBlitz (continued)

### Resources

- Alden, P. 1987. *Peterson first guide to mammals*. Houghton Mifflin Company, Boston. 128 pp.
- Chicago Wilderness. *An atlas of biodiversity*. Chicago Region Biodiversity Council, Chicago, Illinois. 65 pp.
- Chicago Wilderness. 2001. Chicago Wilderness Web site. <http://www.chicagowilderness.org>.
- Conant, R., Stebbins, R. C. and J. T. Collins. *Peterson first guide to reptiles and amphibians*. Houghton Mifflin Company, Boston. 128 pp.
- Griggs, J. L. 1997. *All the birds of North America*. Harper Collins, New York. 172 pp.
- Hogan, K. 1994. *Eco-Inquiry: a guide to ecological learning experiences for the upper elementary/middle grades*. Kendall/Hunt Publishing Company, Dubuque, Iowa. 400 pp.
- Illinois Department of Natural Resources. 1992. *Living with wildlife*. Illinois Department of Natural Resources. <http://dnr.state.il.us/lands/education/wildlife/intro.htm>.
- Illinois Department of Natural Resources. 1998. *Wings, stings and leggy things*. Illinois Department of Natural Resources, Springfield, Illinois. 24 pp.
- Illinois Department of Natural Resources. 1999. *Biodiversity of Illinois, volume 1: aquatic habitats*. Illinois Department of Natural Resources, Springfield, Illinois. CD-ROM.
- Illinois Department of Natural Resources. 2000. *Biodiversity of Illinois, volume II: woodland habitats*. Illinois Department of Natural Resources, Springfield, Illinois. CD-ROM.
- Illinois Department of Natural Resources. 2001. *Biodiversity of Illinois, volume III: prairie and edge habitats*. Illinois Department of Natural Resources, Springfield, Illinois. CD-ROM.
- Illinois Department of Natural Resources. 2001. Illinois Natural History Survey Web site. <http://www.inhs.uiuc.edu>
- Illinois Department of Natural Resources. 2001. Web site. <http://dnr.state.il.us>.
- Leahy, C. 1987. *Peterson first guide to insects*. Houghton Mifflin Company, Boston. 128 pp.
- Peterson, R. T. 1986. *Peterson first guide to birds*. Houghton Mifflin Company, Boston. 128 pp.
- Peterson, R. T. 1986. *Peterson first guide to wildflowers*. Houghton Mifflin Company, Boston. 128 pp.
- Petrides, G. A. 1993. *Peterson first guide to trees*. Houghton Mifflin Company, Boston. 128 pp.
- Snedden, R. and S. Parker. 1996. *Yuck! A big book of little horrors*. Simon and Schuster, New York. 32 pp.
- Whitaker, Jr., J. O. 1980. *The Audubon Society field guide to North American mammals*. Knopf, New York. 745 pp.



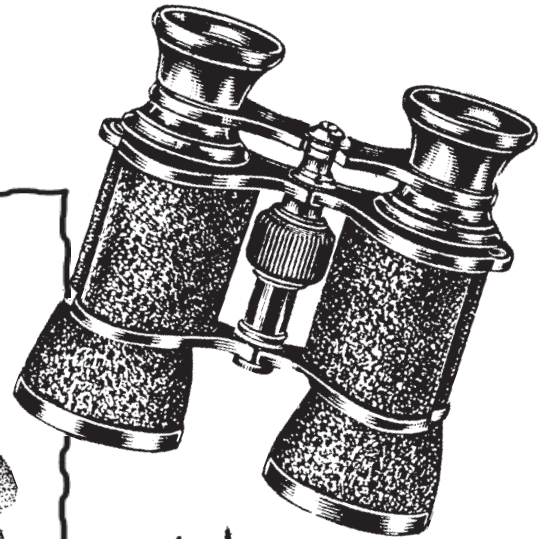

## Animal Signs to Look For

In addition to looking for animals, keep your eyes open for animal signs. These signs include the following:

- |                                |  |
|--------------------------------|--|
| ■ burrows                      | ■ nests                                |
| ■ digging and scratching marks | ■ tracks                               |
| ■ bones                        | ■ feathers                             |
| ■ insect galls                 | ■ cocoons                              |
| ■ spider webs                  | ■ nibbled leaves and branches          |
| ■ droppings                    | ■ feeding holes in dead trees and logs |
| ■ runways and trails           |  |



Also, don't forget to look everywhere, including:

- |                             |                         |
|-----------------------------|-------------------------|
| ■ on the ground             | ■ on tree trunks        |
| ■ in tree branches          | ■ in leaf litter        |
| ■ on plant stems and leaves | ■ under and around logs |
| ■ under rocks               |                         |

## Do's and Don'ts of Field Work

### Do's

- ✓ Do be sure that you have all the materials you need before you head to the study site.
- ✓ Do be a careful observer.
- ✓ Do take careful notes about what you find, including information about the locations and characteristics of plants and animals.
- ✓ Do handle animals with care—and handle them as little as possible.
- ✓ Do return animals you find to the places where you found them.
- ✓ Do replace logs and rocks to the position you found them.
- ✓ Do stay within the boundaries of your study area.
- ✓ Do try to identify unknown species while you're in the field.
- ✓ Do look for animal signs as well as actual animals.
- ✓ Do wash your hands carefully as soon as you return to the classroom.

### Don'ts

- ✗ Don't damage trees or other plants by digging them up, ripping off leaves or tearing at the bark.
- ✗ Don't put anything you find—such as berries, leaves, mushrooms and bark—in your mouth. Also, don't put your fingers in your mouth until after you have returned to the classroom and washed your hands thoroughly.
- ✗ Don't chase after, yell at or throw things at animals you see.
- ✗ Don't touch animal droppings, dead animals, mushrooms or human refuse such as bandages, broken glass, rusty cans or needles.
- ✗ Don't reach under logs or rocks, crevices or other spaces if you can't see into them.





## Student Page Ecoregional Survey

### How much do you know about where you live?

1. What major habitat type do you live in? (temperate forest, temperate rain forest, grassland, shrubland, taiga, tundra, desert and so on)
2. Name three native trees that live in your area.
3. Name five native edible plants that grow in your region and list in which season(s) each is available.
4. Name one poisonous plant that lives in your area.
5. Name ten native animals that live in your region.
6. Name three native animals that you can see in your area at any time of the year.
7. Name three migratory animals that visit or live in your area, and list in which season(s) you're able to see them.
8. Do white-tailed deer live in your area? If so, when during the year do they give birth?
9. How much average rainfall does your community get each year?
10. When (during what season or month) does your community normally get the most precipitation?



(—continued)



## Student Page Ecoregional Survey (continued)



11. How long is the growing season in your community?
12. What is the average temperature in July? In December?
13. What are some natural signs in your community that show that the seasons are changing?
14. What body of water—lake, pond, stream or river—is closest to your school?
15. How has your area changed in the past 25 years? (Ask your parents or neighbors.)
16. What types of plants and animals lived in your area 10,000 years ago? What was the climate like then?
17. What species in your area—if any—are threatened or endangered?
18. What natural events or processes influence the land around your community? How have they affected the land? (For example, have there ever been glaciers, earthquakes or volcanic eruptions in your area? Do frequent fires, high winds or flooding shape where and how things grow?)
19. Are there any threatened ecological areas in your community? (Are any wetlands, rivers or forests, for example, in trouble?)
20. Name a nonnative species that has created problems in your community.







Student Page  
Backyard BioBlitz

# BIOBLITZ SURVEY

Site \_\_\_\_\_ Date \_\_\_\_\_

\_\_\_\_\_ Weather \_\_\_\_\_

City \_\_\_\_\_ Temperature \_\_\_\_\_

State \_\_\_\_\_ Team Members \_\_\_\_\_

Description (what the area looks like in general) \_\_\_\_\_

\_\_\_\_\_

## SITE MAP



Student Page  
Backyard BioBlitz (continued)



Plants

---

---

---

---

---

Mammals

---

---

---

---

---

Birds

---

---

---

---

---

Insects

---

---

---

---

---

Other Invertebrates

---

---

---

---

---

Reptiles and Amphibians

---

---

---

---

---

Other / Animal Signs

---

---

---



## Activity 1-4 The Gene Scene

### AT A GLANCE

Play several different games that introduce genetic diversity and highlight why it's important within populations.

### OBJECTIVES

Identify and classify genetic traits using a genetic wheel.  
Explain why genetic diversity may be necessary for the long-term survival of a population of animals or plants.

### SUBJECTS

English language arts, science

### SKILLS

gathering (simulating), analyzing (identifying patterns),  
interpreting (identifying cause and effect, inferring)

### LINKS TO ILLINOIS BIODIVERSITY BASICS

#### CONCEPTUAL FRAMEWORK

genetic diversity

#### VOCABULARY

chromosome, evolution, gene, genetic diversity, inherit,  
nucleus, population, species, trait

#### TIME

three class periods

#### MATERIALS

**Part I**—copy of the "Human Genetic Wheel" and "Checking Out Your Genetic Traits" for each student

**Part II**—15 to 20 index cards

**Part III**—scissors; copies of "All About White-tailed Deer," "White-tailed Deer Genetic Wheel," "White-tailed Deer Cards," "Event Cards" and "White-tailed Deer Fawn Cards" (see Before You Begin! Part III for specific details regarding numbers and types of paper to use)

#### CORRELATION TO ILLINOIS LEARNING STANDARDS

English language arts 3.C.2a, 3.C.3b, 5.C.2a  
science 12.A.2a, 12.B.2b, 12.B.3b

From a scientific perspective, conserving biodiversity means more than just protecting the variety of different species on earth. It also means preserving the natural variation that exists among the individuals of each species. Just as humans vary in their appearances and abilities, so, too, do individual fishes, mushrooms, oak trees and amoebae. Preserving variety within populations of species is essential for preserving the ability of that species to cope with environmental change. An organism's ability to adapt to environmental change determines how well it will survive in the long run. The greater the diversity of genes in a population, the greater the chances that some individuals will possess the genes needed to survive under conditions of environmental stress. As wild populations of plants and animals become smaller and more fragmented because of habitat loss, it becomes less likely that the remaining individuals will possess the genes needed to survive environmental changes. The individual—and the species—is subject to destruction.

This three-part activity will introduce your students to the concept of genetic diversity within a population. In Part I they will observe and compare human traits within their classroom population. This exercise should demonstrate that each individual has a variety of traits that make him or her unique and that create a diverse population within the classroom. In Part II they will discover through a quick, active demonstration that increased diversity contributes to greater survivability. Part III will reinforce this idea as your students play a game in which they represent populations of white-tailed deer coping with changes in the environment over time.





## Activity 1-4 The Gene Scene (continued)

### BEFORE YOU BEGIN! PART I

For each student, make a copy of the “Human Genetic Wheel” and “Checking Out Your Genetic Traits.”

### WHAT TO DO! PART I

#### 1. Introduce genes.

Your students may know that the physical characteristics of all creatures on earth are determined by their genes. But what are genes and how do they work? Genes are sections of DNA that manifest themselves as visible traits, such as eye color and hair texture, and nonvisible traits, such as a susceptibility to a certain disease. Genes form visible bars on threadlike structures called chromosomes, which are inside the central part, or nucleus, of every plant and animal cell. Chromosomes contain the genetic material of each cell, made up mostly of DNA. Chromosomes become visible under a microscope when any animal or plant cell divides.

In mammals, most healthy cells have two copies of each chromosome—one from each parent. Reproductive cells (egg and sperm) have one copy of each chromosome. Different species have different numbers of chromosome pairs. In humans, for example, there are normally 23 pairs of chromosomes.

#### 2. Discuss genetic diversity.

Explain that in a healthy population (a group of organisms of the same species living in a certain geographic area) there is a wide variety of genes that combine in many different ways to form a broad diversity of individuals. If the population is suddenly subjected to stress, such as disease or environmental change, the genetic variety makes it likely that at least some individuals will be adapted well enough to survive and continue the species.

Populations of some species have become so small or fragmented that they have lost much of their original genetic diversity. If these populations are suddenly subjected to a disease or other stress, there might not be any individuals with the genes that provide protection from the disease and enable the individuals to survive.

#### 3. Determine the characteristics of the class population.

Give each student a copy of “Checking Out Your Genetic Traits.” Go over the list of traits with your class. Have your students work in pairs to help each other determine their traits and check the traits off their worksheets. As you read the list, instruct your students to check the box that describes the trait they possess. They can also work in pairs to observe the traits in each other. For each trait, there are two possibilities:

- Your ear lobes are either hanging loose, or they are attached to the side of your head.
- Your hair is either curly or straight.
- You can either curl your tongue, or you cannot curl it. (This trait refers to whether you can or cannot roll the sides of your tongue to make it into a tubelike shape.)
- You either have hair on your fingers, or you don’t have it. (Look at the part of your finger between your knuckle and first joint.)
- You either have light-colored eyes (blue or green), or you have dark eyes.
- You either have a widow’s peak, or you don’t have one. (If your hairline comes to a point in the middle of your forehead, you have a widow’s peak.)
- Your little finger is either straight, or it is bent.

Point out to your students that their genes have determined each characteristic on the worksheet.

#### 4. Use the Human Genetic Wheel.

Pass out a copy of the “Human Genetic Wheel” to each student. Instruct each student to start at the inner band and find the appropriate letter code that describes his or her own ear lobe type (it will be either “L” for loose or “I” for attached). Instruct them to continue moving outward on the wheel, finding their characteristics for each trait, until they have located their little finger type in band seven. Each person should then find the number next to his or her finger type and record this number on the worksheet.



## Activity 1-4 The Gene Scene (continued)



*Every individual in any population is different from every other individual. Have students look at the variations among the people in their class as an example. But these variations don't make any individual a different species. Everyone in the class, regardless of his or her differences, is still a human being.*

### 5. Pool the results.

There are 128 possible combinations of the seven traits. To find out how many different combinations are present in the class population, go around the room and have each student give his or her “Genetic Wheel” number. Record the numbers on the board. If there is more than one student with the same number, place a check next to that number.

### 6. Discuss your findings.

Are there any two students in the class who have the same seven traits? Then ask the students if they can think of an eighth trait that would set these two people apart. Are there any numbers that have clusters of classmates? Why?

going to represent a genetic trait. Tell them that once the game starts they are not allowed to

change anything about themselves.

Tell them that you’re going to read several of these cards aloud and that if anyone on either team has the characteristic listed on that card, he or she will “die.” Those students who are “dead” must sit down. The object of the game is to have at least one member of their team “alive” at the end.

## BEFORE YOU BEGIN! PART II

You will need 15 to 20 index cards. On each card, write one characteristic that distinguishes one student from another. See “Indexing Student Characteristics.”

## WHAT TO DO! PART II

### 1. Introduce the demonstration.

Divide the students into two teams and explain that they’re going to do a demonstration that illustrates why genetic diversity is important. Show them your stack of index cards and explain that each one lists a characteristic that, for the purposes of the game, is

### 2. Do the demonstration.

Have the students get into their teams and then stand facing you. Read one of the index cards you made earlier and ask all the students with the characteristic listed on the card to sit down. Repeat until you have gone through about three or four of the cards. (At least one of the teams should still have members standing.) Tell the students that if there’s anyone still standing on their team, they can all regenerate and join back in. If both teams still have members

## Indexing Student Characteristics

To do this demonstration you will need a stack of index cards, each of which has a “genetic” characteristic that can distinguish your students from one another. Because it may be difficult to come up with enough truly genetically-based traits, you should feel free to use traits, such as clothing color or type of shoes, in the demonstration. Below are some possibilities for the cards. You will need to choose characteristics that will weed out your group—but not wipe out the entire class all at once. During the demonstration, each time you read one of these traits, every student who has the trait will “die out” for the rest of the round.

- light-colored eyes
- bent little finger
- not wearing glasses
- shoes laced and tied
- shoes without laces
- wearing earring(s)
- wearing a sweater
- wearing hair clips of any kind
- wearing a watch
- a widow’s peak
- not able to curl tongue
- attached ear lobes
- wearing a hat
- not wearing red



## Activity 1-4 The Gene Scene (continued)

standing, play another round, reading through three or four additional cards. Then go on to step three.

### 3. Discuss the demonstration.

Ask the students what happened. Did any “characteristics” wipe out more people on their team than others? Did one team do better than the other? Why? (Answers will vary depending on what happens with your group. However, students should be figuring out that their team has a better chance of surviving when the characteristics of the team members are more diverse.)

### 4. Do the demonstration again.

Restore each team to its full number of “live” members. Then tell the teams that they’re going to try the demonstration again but that before you start they are allowed to make any adjustments they want on their teams. (Students should do things that give the group a wider range of traits. For example, some team members may untie their shoes while others may leave them tied, and some may add layers of clothing.) Shuffle the stack of cards and then read through several of them, having students with any of the characteristics “die” and sit down.

### 5. Wrap up.

Have the students describe what happened. Did their team last longer this time? What helped them or hurt them? What can they say about how genetic diversity might help wild populations of animals or plants survive? (Students should understand that the more diverse their team was, the greater the chance it had of having at least one member left at the end of several rounds. They should also be able to generalize that the more genetically diverse a wild population is, the greater its chances of surviving over time. However, if the students can’t quite make this leap yet, don’t worry. They’ll get a chance to apply these ideas in Part III.)

## BEFORE YOU BEGIN! PART III

Make several copies of the “White-tailed Deer Genetic Wheel” for each group. Also make two copies of the “White-tailed Deer Cards” for each group (one copy on white paper and one copy on colored paper). You’ll need to make two copies of the “White-tailed Deer Fawn Cards” on white paper and two copies on colored paper, cut the cards apart, and put them in a container. Then make one copy of the “Event Cards,” cut them apart, and put them in another container. If possible, laminate the cards for future use. (If “All About White-tailed Deer” is used as a homework assignment, copy one for each student.)

## WHAT TO DO! PART III

### 1. Introduce the white-tailed deer game.

Tell students that they will play a game that illustrates why genetic diversity is important. The game focuses on the white-tailed deer. You may want to read “All About White-tailed Deer” to the class as an introduction to the activity or give it to the students to read for homework the night before.

### 2. Set up for the game.

Divide the class into five groups and give each group its “White-tailed Deer Cards” (one set on white paper, one set on colored paper). Explain that each group of students is “watching over” a small population of white-tailed deer, represented by the “White-tailed Deer Cards.” Each card identifies the characteristics (genetic traits) that each white-tailed deer will have during the game. The traits used in the game are as follows: sex; acuity of hearing; resistance to disease; sense of smell; and home range size. Colored cards represent males and white ones represent females. The other traits are written on each card.

### 3. Determine the genetic number of the white-tailed deer.

Hand out several copies of the “White-tailed Deer Genetic Wheel” to each group. Using the traits provided on each white-tailed deer card, tell the students to work together to determine the genetic



## Activity 1-4 The Gene Scene (continued)

Genetic Numbers of Individual White-tailed Deer	5 5	8	11 11	12 12	17 17 17 17	23	24 24 24 24 24 24	30	31
Genetic Combinations	1	2	3	4	5	6	7	8	9

number of each white-tailed deer in their population. They should use the “White-tailed Deer Genetic Wheel” to find the number of each white-tailed deer in the same way they used the “Human Genetic Wheel” (Part I) to find their own numbers. Students should write the genetic number of each white-tailed deer on each white-tailed deer card.

#### 4. Determine the genetic diversity of each group’s population of white-tailed deer.

Next ask the students to determine the genetic diversity of their group of white-tailed deer. Ask the student groups to count how many different individual genetic numbers are exhibited by their 20 white-tailed deer. This is the group’s diversity number. Consider that a student group has a population of white-tailed deer with the genetic numbers shown in the table above.

In this case, the student group would have a total of nine different genetic combinations represented by their white-tailed deer group so the diversity number is nine. Write a tally on the board, recording each student group’s number of white-tailed deer and diversity number. The larger a group’s diversity number, the more genetically diverse the population of white-tailed deer.

Each student group should start with 20 white-tailed deer. The diversity number of group one should be 4, group two should be 8, group three should be 12, group four should be 14 and group five should be 20. Some students may realize that they have an advantage—or disadvantage—at this point.

#### Rules and Strategies

Before students begin the game, share the following information:

- If a white-tailed deer dies, the students should turn the card that represents that white-tailed deer face down.
- Only the dominant male white-tailed deer can mate with the females. If the dominant male dies, a new dominant male must be designated. If a group loses all its males or females, it cannot reproduce.
- Events usually affect half of a population. If you have an odd number of white-tailed deer that are affected by an event, round down to find the number of white-tailed deer affected.
- Female fawns cannot reproduce in this game.
- During reproduction events, each qualifying female will receive a fawn card. Students must choose traits for each fawn based only on the traits of that female and the dominant male. See the following example:

Female	Dominant Male
excellent hearing	poor hearing
resistant to disease	resistant to disease
poor sense of smell	good sense of smell
large home range	large home range

The fawn can have either excellent hearing or poor hearing and have either poor sense of smell or good sense of smell, but the fawn must be resistant to disease and have a large home range (because both parents have these traits). Every time a female has a fawn, the students will assign traits in this manner. Circle the traits on the fawn cards.



## Activity 1-4 The Gene Scene (continued)

### 5. Have each group select a dominant male.

Each group of students should select one male in its white-tailed deer population to be the dominant male. Students should place a big letter “D” on the dominant male white-tailed deer’s card. This white-tailed deer will be the only one that mates with the females in the population during the course of the game. If this male dies, the group will have to designate a new dominant male to take its place.

### 6. Have students choose cards from the “Event Cards” and read them to the class.

“Event Cards” depict scenarios of environmental change that the white-tailed deer populations must confront. Italicized text on the cards indicates the impact that the environmental change has on individuals in the population: loss (death) and reproduction. Remind your students that this exercise is a simulation of what could happen to a real white-tailed deer population. While the events are not real, they do represent some of the many pressures exerted on populations by natural and human forces. Allow your students to take turns picking an event card at random and reading it aloud to the class. Tell your students to pay attention to the event being read and respond to that event based on the white-tailed deer they have in their population. Every group follows the directions of each event card.

### 7. Record how many white-tailed deer are left after the events have been read, and analyze the results.

After all the “Event Cards” have been read, record on the board the number of white-tailed deer (adults and fawns) surviving in each group’s population.

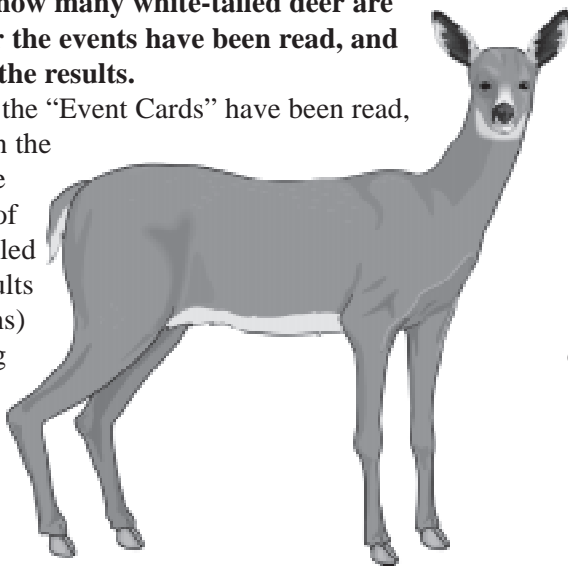

Compare different groups of white-tailed deer and determine which ones were more successful. Did genetic diversity contribute to this success? How?

### 8. Discuss the results of the game.

After you finish the game, discuss genetic diversity using the following questions:

a.

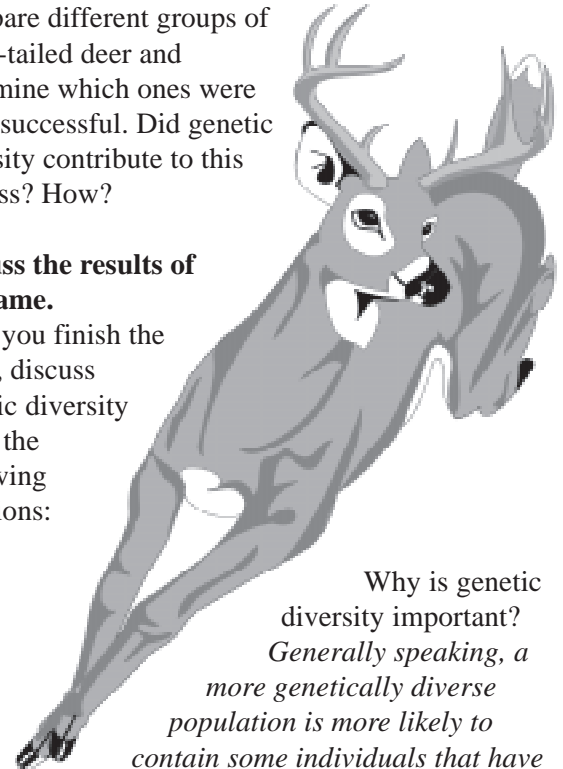

Why is genetic diversity important?  
*Generally speaking, a more genetically diverse population is more likely to contain some individuals that have the traits necessary to survive and adapt to changes in the environment than populations that aren’t as genetically diverse.*

b. What is the relationship between the size of a population and its genetic diversity?

*As a population becomes smaller, some variation in traits is lost. Because there are fewer individuals in a smaller population, it is less likely that there will be individuals with the traits necessary to survive in times of environmental stress. This is one reason smaller populations are more vulnerable to extinction. Many species that once had large populations, such as the greater prairie-chicken and American bison, have lost a great deal of their genetic diversity in a short time because of habitat loss and over-hunting.*

c. What can be done to prevent the loss of genetic diversity?

*To preserve genetic diversity, it is important that wild populations of plants and animals do not*





## Activity 1-4 The Gene Scene (continued)

*become small or fragmented. Preservation is becoming more and more challenging as human populations expand and increase their level of consumption as well as demand for space.*

- d. Did some traits seem to be favored over others? Were there any traits that were favored in one instance but selected against in another? How does this relate to the importance of genetic diversity? *A trait that is advantageous under one set of environmental conditions may be detrimental under another.*

### WRAPPING IT UP

#### Assessment

1. Pick a common animal or plant, and describe several distinct individuals, noting their physical traits. (Dogs and cats work especially well.) Students may illustrate their descriptions. How are the individuals different from one another? What sort of advantage or disadvantage might their characteristics provide?
2. Have students create displays focusing on how people have changed genetic diversity within species. Why do they do it? Each student should make a presentation about his/her display to the rest of the class. After student presentations, ask how human manipulation of genes might help or hinder biodiversity.

#### Portfolio

Have students record their ideas about using a genetic wheel to compare human traits and their understanding of genetic diversity from the game.



### Resources

- Burt, W. H. and R. P. Grossenheider. 1980. *A field guide to the mammals*. Houghton Mifflin Company, Boston. 289 pp.
- Gonick, L. and M. Wheelis. 1991. *The cartoon guide to genetics*. Harper Perennial Library, New York. 224 pp.
- Grzimek, B. 1972. *Grzimek's animal life encyclopedia*. Van Nostrand Reinhold Co., New York. 13 volumes.
- Hoffmeister, D. F. 1989. *Mammals of Illinois*. University of Illinois Press, Urbana, Illinois. 348 pp.
- Illinois Department of Natural Resources. 1999. *Biodiversity of Illinois, volume I: aquatic habitats*. Illinois Department of Natural Resources, Springfield, Illinois. CD-ROM.
- Illinois Department of Natural Resources. 2000. *Biodiversity of Illinois, volume II: woodland habitats*. Illinois Department of Natural Resources, Springfield, Illinois. CD-ROM.
- Illinois Department of Natural Resources. 2001. *Biodiversity of Illinois, volume III: prairie and edge habitats*. Illinois Department of Natural Resources, Springfield, Illinois. CD-ROM.
- Schwartz, C. W. and E. R. Schwartz. 1981. *The wild mammals of Missouri*. University of Missouri Press, Columbia, Missouri. 356 pp.
- Southern Regional 4-H Wildlife Literature Committee. 1996. *Wildlife project: white-tailed deer*. University of Illinois Extension 4-H, Urbana, Illinois. 14 pp.

The genetic wheel approach was inspired by similar activities in *Losing Biodiversity* by Katherine Barrett, Global Systems Science, Lawrence Hall of Science, University of California at Berkeley (1996); and in *Biological Science: A Molecular Approach*, D. C. Heath and Co., Boston (1985).



## CHECKING OUT YOUR GENETIC TRAITS

Which of the following traits did you inherit from your parents? Check the box next to the trait that best describes you.

1. ear lobes

attached (ll)

loose (L)

5. pigmented iris

light eyes (ee)

dark eyes (E)

2. hair type

straight (tt)

curly (T)

6. widow's peak

no peak (ww)

peak present (W)

3. tongue curling

can't curl (cc)

can curl (C)

7. little finger

straight (bb)

bent (B)

4. hair on fingers

no hair on fingers (mm)

hair on fingers (M)

What is  
your number  
from the  
genetic wheel?

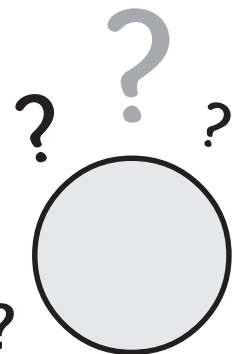



Student Page  
The Gene Scene (continued)

# HUMAN GENETIC WHEEL

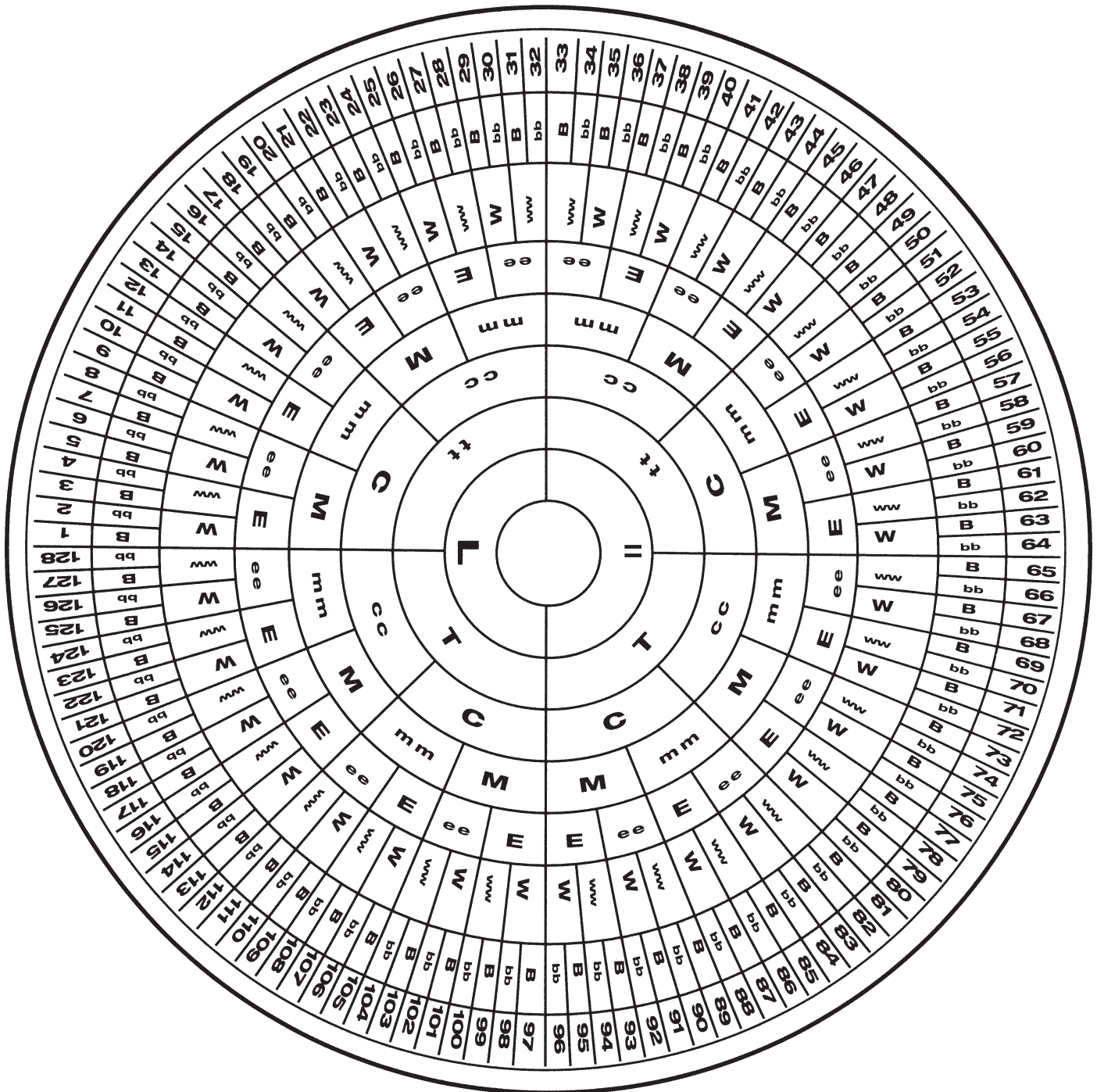



## ALL ABOUT WHITE-TAILED DEER

The white-tailed deer is a large mammal, weighing 100 to 300 pounds. Color varies seasonally. During the summer, the hair has a red tint, but during the fall and winter, it is gray-brown. The belly is white. The large tail has a white underside. Young white-tailed deer have white spots on their back. Males grow and shed antlers annually. There are no incisors or canine teeth on the upper jaw.

The white-tailed deer may be found statewide in Illinois. It lives in wooded areas but may be seen feeding far from such locations. The white-tailed deer is an herbivore, feeding on fruits, grasses, grains, vines, mushrooms, nuts and the leaves and twigs of trees and shrubs. It chews its cud, that is, bringing up material that it had chewed once and swallowed to be chewed and swallowed again.

When this animal is startled, it runs and flips up its tail to show the white side. The male's antlers are shed and replaced each year.

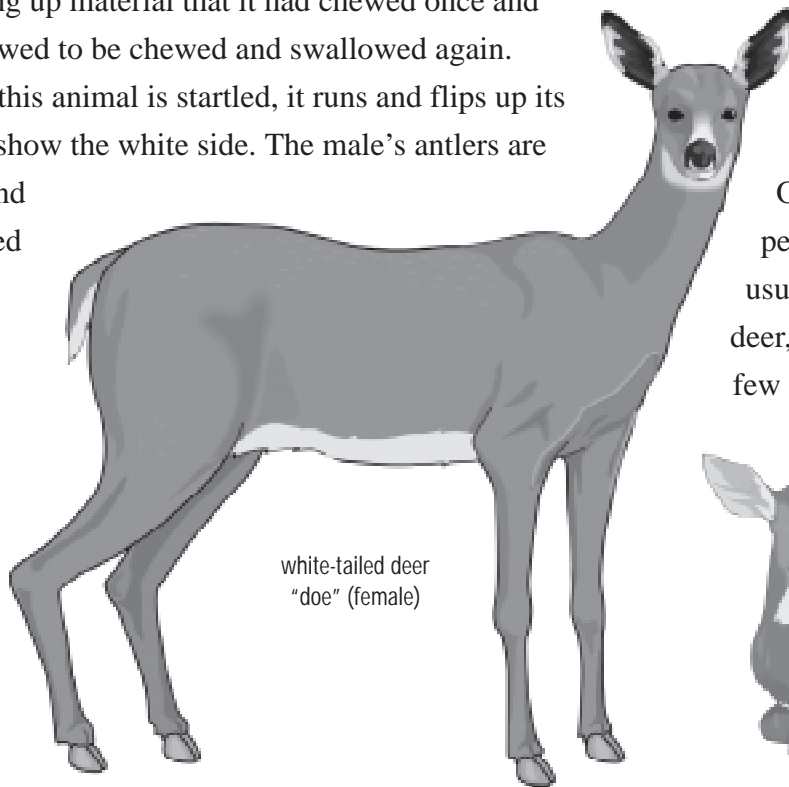

white-tailed deer  
"doe" (female)

There is a "velvet" covering over the antlers for nourishment and protection while they are growing. After the antlers are done growing in the fall, the

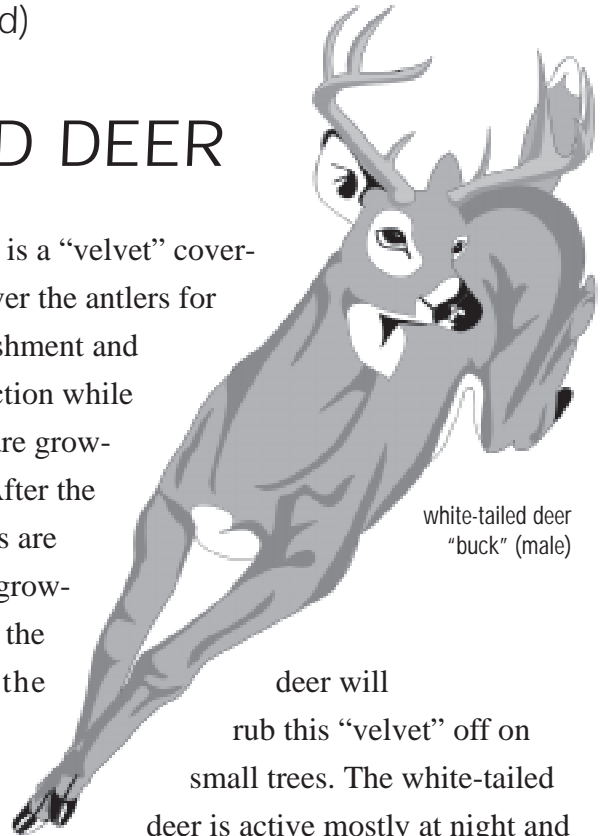

white-tailed deer  
"buck" (male)

deer will rub this "velvet" off on small trees. The white-tailed deer is active mostly at night and during the sunrise and sunset hours. The female and her offspring may stay together for several months. The male white-tailed deer is called a "buck," and the female is a "doe." A male will mate with several females. Mating occurs October through January. The gestation period is about seven months, and the doe usually produces two offspring. Young deer, called fawns, are able to run within a few hours of birth. Males drop their antlers during February and March.



white-tailed deer  
"fawn" (young)



Student Page  
The Gene Scene (continued)

# WHITE-TAILED DEER GENETIC WHEEL

Begin with the center and move outward based on your white-tailed deers traits.

Key:

Poor S of S = poor sense of smell

Good S of S = good sense of smell

LHR = large home range

SHR = small home range

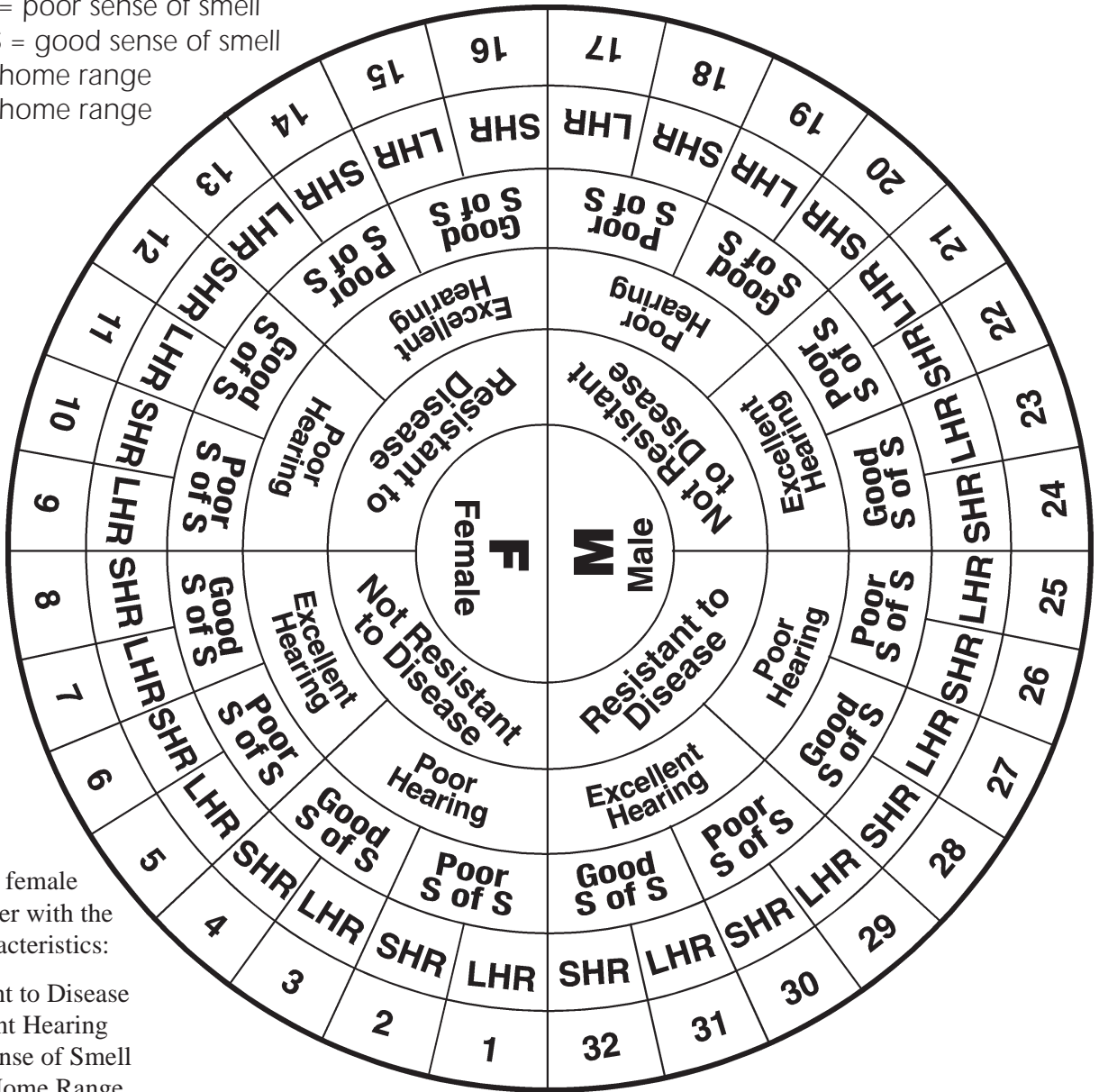

For example, a female white-tailed deer with the following characteristics:

- ✓ Resistant to Disease
- ✓ Excellent Hearing
- ✓ Poor Sense of Smell
- ✓ Large Home Range

would have a genetic number of 13.

A male with the same characteristics would have a genetic number of 29.



# WHITE-TAILED DEER CARDS—GROUP 1



## DEER CARD

Not resistant to disease  
Excellent hearing  
Good sense of smell  
Large home range



## DEER CARD

Not resistant to disease  
Excellent hearing  
Good sense of smell  
Small home range



## DEER CARD

Not resistant to disease  
Excellent hearing  
Good sense of smell  
Large home range



## DEER CARD

Not resistant to disease  
Excellent hearing  
Good sense of smell  
Small home range



## DEER CARD

Not resistant to disease  
Excellent hearing  
Good sense of smell  
Large home range



## DEER CARD

Not resistant to disease  
Excellent hearing  
Good sense of smell  
Small home range



## DEER CARD

Not resistant to disease  
Excellent hearing  
Good sense of smell  
Large home range



## DEER CARD

Not resistant to disease  
Excellent hearing  
Good sense of smell  
Small home range



## DEER CARD

Not resistant to disease  
Excellent hearing  
Good sense of smell  
Small home range





## DEER CARD

Not resistant to disease  
Excellent hearing  
Good sense of smell  
Large home range



# WHITE-TAILED DEER CARDS—GROUP 2

 <b>DEER CARD</b> Resistant to disease Excellent hearing Good sense of smell Small home range	 <b>DEER CARD</b> Not resistant to disease Excellent hearing Good sense of smell Small home range	 <b>DEER CARD</b> Not resistant to disease Excellent hearing Good sense of smell Large home range	 <b>DEER CARD</b> Not resistant to disease Excellent hearing Good sense of smell Small home range	 <b>DEER CARD</b> Not resistant to disease Excellent hearing Good sense of smell Large home range
 <b>DEER CARD</b> Not resistant to disease Excellent hearing Poor sense of smell Large home range	 <b>DEER CARD</b> Not resistant to disease Excellent hearing Good sense of smell Small home range	 <b>DEER CARD</b> Not resistant to disease Excellent hearing Poor sense of smell Large home range	 <b>DEER CARD</b> Not resistant to disease Excellent hearing Good sense of smell Small home range	 <b>DEER CARD</b> Not resistant to disease Excellent hearing Poor sense of smell Large home range



# WHITE-TAILED DEER CARDS—GROUP 3



## DEER CARD

Resistant to disease  
Excellent hearing  
Poor sense of smell  
Large home range



## DEER CARD

Not resistant to disease  
Excellent hearing  
Poor sense of smell  
Large home range



## DEER CARD

Resistant to disease  
Excellent hearing  
Good sense of smell  
Small home range



## DEER CARD

Not resistant to disease  
Excellent hearing  
Good sense of smell  
Small home range



## DEER CARD

Resistant to disease  
Excellent hearing  
Good sense of smell  
Small home range



## DEER CARD

Not resistant to disease  
Poor hearing  
Good sense of smell  
Small home range



## DEER CARD

Not resistant to disease  
Poor hearing  
Good sense of smell  
Small home range



## DEER CARD

Not resistant to disease  
Excellent hearing  
Good sense of smell  
Large home range



## DEER CARD

Resistant to disease  
Excellent hearing  
Poor sense of smell  
Large home range



## DEER CARD



Resistant to disease  
Excellent hearing  
Poor sense of smell  
Large home range





Student Page  
The Gene Scene (continued)

# WHITE-TAILED DEER CARDS—GROUP 4

 <p><b>DEER CARD</b> Resistant to disease Excellent hearing Good sense of smell Small home range</p>	 <p><b>DEER CARD</b> Not resistant to disease Excellent hearing Good sense of smell Large home range</p>	 <p><b>DEER CARD</b> Resistant to disease Excellent hearing Good sense of smell Small home range</p>	 <p><b>DEER CARD</b> Resistant to disease Excellent hearing Poor sense of smell Large home range</p>	 <p><b>DEER CARD</b> Resistant to disease Excellent hearing Poor sense of smell Large home range</p>
 <p><b>DEER CARD</b> Resistant to disease Excellent hearing Poor sense of smell Small home range</p>	 <p><b>DEER CARD</b> Not resistant to disease Excellent hearing Good sense of smell Large home range</p>	 <p><b>DEER CARD</b> Not resistant to disease Poor hearing Good sense of smell Large home range</p>	 <p><b>DEER CARD</b> Not resistant to disease Poor hearing Poor sense of smell Small home range</p>	 <p><b>DEER CARD</b> Resistant to disease Poor hearing Poor sense of smell Small home range</p>













# WHITE-TAILED DEER CARDS—GROUP 5

 <b>DEER CARD</b> Resistant to disease Excellent hearing Good sense of smell Large home range	 <b>DEER CARD</b> Not resistant to disease Excellent hearing Poor sense of smell Large home range	 <b>DEER CARD</b> Not resistant to disease Poor hearing Good sense of smell Large home range	 <b>DEER CARD</b> Resistant to disease Poor hearing Good sense of smell Large home range	 <b>DEER CARD</b> Resistant to disease Poor hearing Poor sense of smell Large home range
 <b>DEER CARD</b> Resistant to disease Excellent hearing Poor sense of smell Small home range	 <b>DEER CARD</b> Not resistant to disease Excellent hearing Poor sense of smell Small home range	 <b>DEER CARD</b> Not resistant to disease Poor hearing Good sense of smell Small home range	 <b>DEER CARD</b> Resistant to disease Poor hearing Good sense of smell Small home range	 <b>DEER CARD</b> Resistant to disease Poor hearing Poor sense of smell Small home range



Student Page  
The Gene Scene (continued)

WHITE-TAILED DEER FAWN CARDS

<p><b>DEER FAWN CARD</b> </p> <p><i>(circle the trait)</i></p> <p>Resistant to disease Not resistant to disease</p> <p>Excellent hearing Poor hearing</p> <p>Good sense of smell Poor sense of smell</p> <p>Large home range Small home range</p>	<p><b>DEER FAWN CARD</b> </p> <p><i>(circle the trait)</i></p> <p>Resistant to disease Not resistant to disease</p> <p>Excellent hearing Poor hearing</p> <p>Good sense of smell Poor sense of smell</p> <p>Large home range Small home range</p>	<p><b>DEER FAWN CARD</b> </p> <p><i>(circle the trait)</i></p> <p>Resistant to disease Not resistant to disease</p> <p>Excellent hearing Poor hearing</p> <p>Good sense of smell Poor sense of smell</p> <p>Large home range Small home range</p>	<p><b>DEER FAWN CARD</b> </p> <p><i>(circle the trait)</i></p> <p>Resistant to disease Not resistant to disease</p> <p>Excellent hearing Poor hearing</p> <p>Good sense of smell Poor sense of smell</p> <p>Large home range Small home range</p>	<p><b>DEER FAWN CARD</b> </p> <p><i>(circle the trait)</i></p> <p>Resistant to disease Not resistant to disease</p> <p>Excellent hearing Poor hearing</p> <p>Good sense of smell Poor sense of smell</p> <p>Large home range Small home range</p>
<p><b>DEER FAWN CARD</b> </p> <p><i>(circle the trait)</i></p> <p>Resistant to disease Not resistant to disease</p> <p>Excellent hearing Poor hearing</p> <p>Good sense of smell Poor sense of smell</p> <p>Large home range Small home range</p>	<p><b>DEER FAWN CARD</b> </p> <p><i>(circle the trait)</i></p> <p>Resistant to disease Not resistant to disease</p> <p>Excellent hearing Poor hearing</p> <p>Good sense of smell Poor sense of smell</p> <p>Large home range Small home range</p>	<p><b>DEER FAWN CARD</b> </p> <p><i>(circle the trait)</i></p> <p>Resistant to disease Not resistant to disease</p> <p>Excellent hearing Poor hearing</p> <p>Good sense of smell Poor sense of smell</p> <p>Large home range Small home range</p>	<p><b>DEER FAWN CARD</b> </p> <p><i>(circle the trait)</i></p> <p>Resistant to disease Not resistant to disease</p> <p>Excellent hearing Poor hearing</p> <p>Good sense of smell Poor sense of smell</p> <p>Large home range Small home range</p>	<p><b>DEER FAWN CARD</b> </p> <p><i>(circle the trait)</i></p> <p>Resistant to disease Not resistant to disease</p> <p>Excellent hearing Poor hearing</p> <p>Good sense of smell Poor sense of smell</p> <p>Large home range Small home range</p>



Student Page  
The Gene Scene (continued)

## EVENT CARDS

The deadly EHD (epizootic hemorrhagic disease), a disease spread by a virus, is killing many deer. White-tailed deer with resistance to the disease are much more likely to survive and reproduce.

**Lose half of your white-tailed deer that are "not resistant to disease."**

EVENT  
CARD

Nondominant males may wander from group to group.

**Every group should give one nondominant male white-tailed deer to the group to their left.**

EVENT  
CARD

A severe drought has hit Illinois. Because of the extreme dry conditions, white-tailed deer must travel farther to find food and water.

**Lose one white-tailed deer that has a "small home range."**

EVENT  
CARD

Young fawns are particularly vulnerable to predation by coyotes. A fawn with a poor sense of smell might not be able to detect a coyote in time to escape.

**Lose half of your fawns with a "poor sense of smell."**

EVENT  
CARD

Deer meat, otherwise known as venison, has recently become popular. Poachers are illegally hunting white-tailed deer after dark. Deer with poor hearing are easy targets as the poachers drive up in their vehicles.

**Lose half of your white-tailed deer with "poor hearing."**

EVENT  
CARD

Habitat fragmentation has resulted from construction of new housing developments and an increase in roads. As they move between the smaller habitats, white-tailed deer have a greater chance of being hit by cars and trucks on the roads.

**Lose one white-tailed deer with a "small home range."**

EVENT  
CARD

In the breeding season, males mark their territories with scents and visit the scented sites often. A female with a good sense of smell is more likely to know where the male will be when she is ready to mate, increasing her chances of successful reproduction. Add one fawn for each "good sense of smell" female white-tailed deer in your group, only if a male is present to mate with her.

Each group should take the appropriate number of fawn cards out of the fawn card container.

**Assign traits that are present in the parents (each "good sense of smell" female and the dominant male) to their fawn.**

EVENT  
CARD

It has been a mild winter this year, yielding an abundance of food. Because of good nutrition, all of your female white-tailed deer give birth in the spring.

**Add one fawn for each "small home range" female white-tailed deer, only if a male is present to mate with her.**

**Add three fawns for each "large home range" female white-tailed deer, only if a male is present to mate with her.**

**Assign traits that are present in the parents of the fawns.**

EVENT  
CARD



## Activity 1-4 The Gene Scene

### AT A GLANCE

Play several different games that introduce genetic diversity and highlight why it's important within populations.

### OBJECTIVES

Identify and classify genetic traits using a genetic wheel.  
Explain why genetic diversity may be necessary for the long-term survival of a population of animals or plants.

### SUBJECTS

English language arts, science

### SKILLS

gathering (simulating), analyzing (identifying patterns),  
interpreting (identifying cause and effect, inferring)

### LINKS TO ILLINOIS BIODIVERSITY BASICS

#### CONCEPTUAL FRAMEWORK

genetic diversity

#### VOCABULARY

chromosome, evolution, gene, genetic diversity, inherit,  
nucleus, population, species, trait

#### TIME

three class periods

#### MATERIALS

**Part I**—copy of the "Human Genetic Wheel" and "Checking Out Your Genetic Traits" for each student

**Part II**—15 to 20 index cards

**Part III**—scissors; copies of "All About White-tailed Deer," "White-tailed Deer Genetic Wheel," "White-tailed Deer Cards," "Event Cards" and "White-tailed Deer Fawn Cards" (see Before You Begin! Part III for specific details regarding numbers and types of paper to use)

#### CORRELATION TO ILLINOIS LEARNING STANDARDS

English language arts 3.C.2a, 3.C.3b, 5.C.2a  
science 12.A.2a, 12.B.2b, 12.B.3b

From a scientific perspective, conserving biodiversity means more than just protecting the variety of different species on earth. It also means preserving the natural variation that exists among the individuals of each species. Just as humans vary in their appearances and abilities, so, too, do individual fishes, mushrooms, oak trees and amoebae. Preserving variety within populations of species is essential for preserving the ability of that species to cope with environmental change. An organism's ability to adapt to environmental change determines how well it will survive in the long run. The greater the diversity of genes in a population, the greater the chances that some individuals will possess the genes needed to survive under conditions of environmental stress. As wild populations of plants and animals become smaller and more fragmented because of habitat loss, it becomes less likely that the remaining individuals will possess the genes needed to survive environmental changes. The individual—and the species—is subject to destruction.

This three-part activity will introduce your students to the concept of genetic diversity within a population. In Part I they will observe and compare human traits within their classroom population. This exercise should demonstrate that each individual has a variety of traits that make him or her unique and that create a diverse population within the classroom. In Part II they will discover through a quick, active demonstration that increased diversity contributes to greater survivability. Part III will reinforce this idea as your students play a game in which they represent populations of white-tailed deer coping with changes in the environment over time.





## Activity 1-4 The Gene Scene (continued)

### BEFORE YOU BEGIN! PART I

For each student, make a copy of the “Human Genetic Wheel” and “Checking Out Your Genetic Traits.”

### WHAT TO DO! PART I

#### 1. Introduce genes.

Your students may know that the physical characteristics of all creatures on earth are determined by their genes. But what are genes and how do they work? Genes are sections of DNA that manifest themselves as visible traits, such as eye color and hair texture, and nonvisible traits, such as a susceptibility to a certain disease. Genes form visible bars on threadlike structures called chromosomes, which are inside the central part, or nucleus, of every plant and animal cell. Chromosomes contain the genetic material of each cell, made up mostly of DNA. Chromosomes become visible under a microscope when any animal or plant cell divides.

In mammals, most healthy cells have two copies of each chromosome—one from each parent. Reproductive cells (egg and sperm) have one copy of each chromosome. Different species have different numbers of chromosome pairs. In humans, for example, there are normally 23 pairs of chromosomes.

#### 2. Discuss genetic diversity.

Explain that in a healthy population (a group of organisms of the same species living in a certain geographic area) there is a wide variety of genes that combine in many different ways to form a broad diversity of individuals. If the population is suddenly subjected to stress, such as disease or environmental change, the genetic variety makes it likely that at least some individuals will be adapted well enough to survive and continue the species.

Populations of some species have become so small or fragmented that they have lost much of their original genetic diversity. If these populations are suddenly subjected to a disease or other stress, there might not be any individuals with the genes that provide protection from the disease and enable the individuals to survive.

#### 3. Determine the characteristics of the class population.

Give each student a copy of “Checking Out Your Genetic Traits.” Go over the list of traits with your class. Have your students work in pairs to help each other determine their traits and check the traits off their worksheets. As you read the list, instruct your students to check the box that describes the trait they possess. They can also work in pairs to observe the traits in each other. For each trait, there are two possibilities:

- Your ear lobes are either hanging loose, or they are attached to the side of your head.
- Your hair is either curly or straight.
- You can either curl your tongue, or you cannot curl it. (This trait refers to whether you can or cannot roll the sides of your tongue to make it into a tubelike shape.)
- You either have hair on your fingers, or you don’t have it. (Look at the part of your finger between your knuckle and first joint.)
- You either have light-colored eyes (blue or green), or you have dark eyes.
- You either have a widow’s peak, or you don’t have one. (If your hairline comes to a point in the middle of your forehead, you have a widow’s peak.)
- Your little finger is either straight, or it is bent.

Point out to your students that their genes have determined each characteristic on the worksheet.

#### 4. Use the Human Genetic Wheel.

Pass out a copy of the “Human Genetic Wheel” to each student. Instruct each student to start at the inner band and find the appropriate letter code that describes his or her own ear lobe type (it will be either “L” for loose or “I” for attached). Instruct them to continue moving outward on the wheel, finding their characteristics for each trait, until they have located their little finger type in band seven. Each person should then find the number next to his or her finger type and record this number on the worksheet.



## Activity 1-4 The Gene Scene (continued)



*Every individual in any population is different from every other individual. Have students look at the variations among the people in their class as an example. But these variations don't make any individual a different species. Everyone in the class, regardless of his or her differences, is still a human being.*

### 5. Pool the results.

There are 128 possible combinations of the seven traits. To find out how many different combinations are present in the class population, go around the room and have each student give his or her “Genetic Wheel” number. Record the numbers on the board. If there is more than one student with the same number, place a check next to that number.

### 6. Discuss your findings.

Are there any two students in the class who have the same seven traits? Then ask the students if they can think of an eighth trait that would set these two people apart. Are there any numbers that have clusters of classmates? Why?

going to represent a genetic trait. Tell them that once the game starts they are not allowed to

change anything about themselves.

Tell them that you’re going to read several of these cards aloud and that if anyone on either team has the characteristic listed on that card, he or she will “die.” Those students who are “dead” must sit down. The object of the game is to have at least one member of their team “alive” at the end.

## BEFORE YOU BEGIN! PART II

You will need 15 to 20 index cards. On each card, write one characteristic that distinguishes one student from another. See “Indexing Student Characteristics.”

## WHAT TO DO! PART II

### 1. Introduce the demonstration.

Divide the students into two teams and explain that they’re going to do a demonstration that illustrates why genetic diversity is important. Show them your stack of index cards and explain that each one lists a characteristic that, for the purposes of the game, is

### 2. Do the demonstration.

Have the students get into their teams and then stand facing you. Read one of the index cards you made earlier and ask all the students with the characteristic listed on the card to sit down. Repeat until you have gone through about three or four of the cards. (At least one of the teams should still have members standing.) Tell the students that if there’s anyone still standing on their team, they can all regenerate and join back in. If both teams still have members

## Indexing Student Characteristics

To do this demonstration you will need a stack of index cards, each of which has a “genetic” characteristic that can distinguish your students from one another. Because it may be difficult to come up with enough truly genetically-based traits, you should feel free to use traits, such as clothing color or type of shoes, in the demonstration. Below are some possibilities for the cards. You will need to choose characteristics that will weed out your group—but not wipe out the entire class all at once. During the demonstration, each time you read one of these traits, every student who has the trait will “die out” for the rest of the round.

- light-colored eyes
- bent little finger
- not wearing glasses
- shoes laced and tied
- shoes without laces
- wearing earring(s)
- wearing a sweater
- wearing hair clips of any kind
- wearing a watch
- a widow’s peak
- not able to curl tongue
- attached ear lobes
- wearing a hat
- not wearing red



## Activity 1-4 The Gene Scene (continued)

standing, play another round, reading through three or four additional cards. Then go on to step three.

### 3. Discuss the demonstration.

Ask the students what happened. Did any “characteristics” wipe out more people on their team than others? Did one team do better than the other? Why? (Answers will vary depending on what happens with your group. However, students should be figuring out that their team has a better chance of surviving when the characteristics of the team members are more diverse.)

### 4. Do the demonstration again.

Restore each team to its full number of “live” members. Then tell the teams that they’re going to try the demonstration again but that before you start they are allowed to make any adjustments they want on their teams. (Students should do things that give the group a wider range of traits. For example, some team members may untie their shoes while others may leave them tied, and some may add layers of clothing.) Shuffle the stack of cards and then read through several of them, having students with any of the characteristics “die” and sit down.

### 5. Wrap up.

Have the students describe what happened. Did their team last longer this time? What helped them or hurt them? What can they say about how genetic diversity might help wild populations of animals or plants survive? (Students should understand that the more diverse their team was, the greater the chance it had of having at least one member left at the end of several rounds. They should also be able to generalize that the more genetically diverse a wild population is, the greater its chances of surviving over time. However, if the students can’t quite make this leap yet, don’t worry. They’ll get a chance to apply these ideas in Part III.)

## BEFORE YOU BEGIN! PART III

Make several copies of the “White-tailed Deer Genetic Wheel” for each group. Also make two copies of the “White-tailed Deer Cards” for each group (one copy on white paper and one copy on colored paper). You’ll need to make two copies of the “White-tailed Deer Fawn Cards” on white paper and two copies on colored paper, cut the cards apart, and put them in a container. Then make one copy of the “Event Cards,” cut them apart, and put them in another container. If possible, laminate the cards for future use. (If “All About White-tailed Deer” is used as a homework assignment, copy one for each student.)

## WHAT TO DO! PART III

### 1. Introduce the white-tailed deer game.

Tell students that they will play a game that illustrates why genetic diversity is important. The game focuses on the white-tailed deer. You may want to read “All About White-tailed Deer” to the class as an introduction to the activity or give it to the students to read for homework the night before.

### 2. Set up for the game.

Divide the class into five groups and give each group its “White-tailed Deer Cards” (one set on white paper, one set on colored paper). Explain that each group of students is “watching over” a small population of white-tailed deer, represented by the “White-tailed Deer Cards.” Each card identifies the characteristics (genetic traits) that each white-tailed deer will have during the game. The traits used in the game are as follows: sex; acuity of hearing; resistance to disease; sense of smell; and home range size. Colored cards represent males and white ones represent females. The other traits are written on each card.

### 3. Determine the genetic number of the white-tailed deer.

Hand out several copies of the “White-tailed Deer Genetic Wheel” to each group. Using the traits provided on each white-tailed deer card, tell the students to work together to determine the genetic





## Activity 1-4 The Gene Scene (continued)

Genetic Numbers of Individual White-tailed Deer	5 5	8	11 11	12 12	17 17 17 17	23	24 24 24 24 24 24	30	31
Genetic Combinations	1	2	3	4	5	6	7	8	9

number of each white-tailed deer in their population. They should use the “White-tailed Deer Genetic Wheel” to find the number of each white-tailed deer in the same way they used the “Human Genetic Wheel” (Part I) to find their own numbers. Students should write the genetic number of each white-tailed deer on each white-tailed deer card.

#### 4. Determine the genetic diversity of each group’s population of white-tailed deer.

Next ask the students to determine the genetic diversity of their group of white-tailed deer. Ask the student groups to count how many different individual genetic numbers are exhibited by their 20 white-tailed deer. This is the group’s diversity number. Consider that a student group has a population of white-tailed deer with the genetic numbers shown in the table above.

In this case, the student group would have a total of nine different genetic combinations represented by their white-tailed deer group so the diversity number is nine. Write a tally on the board, recording each student group’s number of white-tailed deer and diversity number. The larger a group’s diversity number, the more genetically diverse the population of white-tailed deer.

Each student group should start with 20 white-tailed deer. The diversity number of group one should be 4, group two should be 8, group three should be 12, group four should be 14 and group five should be 20. Some students may realize that they have an advantage—or disadvantage—at this point.

#### Rules and Strategies

Before students begin the game, share the following information:

- If a white-tailed deer dies, the students should turn the card that represents that white-tailed deer face down.
- Only the dominant male white-tailed deer can mate with the females. If the dominant male dies, a new dominant male must be designated. If a group loses all its males or females, it cannot reproduce.
- Events usually affect half of a population. If you have an odd number of white-tailed deer that are affected by an event, round down to find the number of white-tailed deer affected.
- Female fawns cannot reproduce in this game.
- During reproduction events, each qualifying female will receive a fawn card. Students must choose traits for each fawn based only on the traits of that female and the dominant male. See the following example:

Female	Dominant Male
excellent hearing	poor hearing
resistant to disease	resistant to disease
poor sense of smell	good sense of smell
large home range	large home range

The fawn can have either excellent hearing or poor hearing and have either poor sense of smell or good sense of smell, but the fawn must be resistant to disease and have a large home range (because both parents have these traits). Every time a female has a fawn, the students will assign traits in this manner. Circle the traits on the fawn cards.



## Activity 1-4 The Gene Scene (continued)

### 5. Have each group select a dominant male.

Each group of students should select one male in its white-tailed deer population to be the dominant male. Students should place a big letter “D” on the dominant male white-tailed deer’s card. This white-tailed deer will be the only one that mates with the females in the population during the course of the game. If this male dies, the group will have to designate a new dominant male to take its place.

### 6. Have students choose cards from the “Event Cards” and read them to the class.

“Event Cards” depict scenarios of environmental change that the white-tailed deer populations must confront. Italicized text on the cards indicates the impact that the environmental change has on individuals in the population: loss (death) and reproduction. Remind your students that this exercise is a simulation of what could happen to a real white-tailed deer population. While the events are not real, they do represent some of the many pressures exerted on populations by natural and human forces. Allow your students to take turns picking an event card at random and reading it aloud to the class. Tell your students to pay attention to the event being read and respond to that event based on the white-tailed deer they have in their population. Every group follows the directions of each event card.

### 7. Record how many white-tailed deer are left after the events have been read, and analyze the results.

After all the “Event Cards” have been read, record on the board the number of white-tailed deer (adults and fawns) surviving in each group’s population.

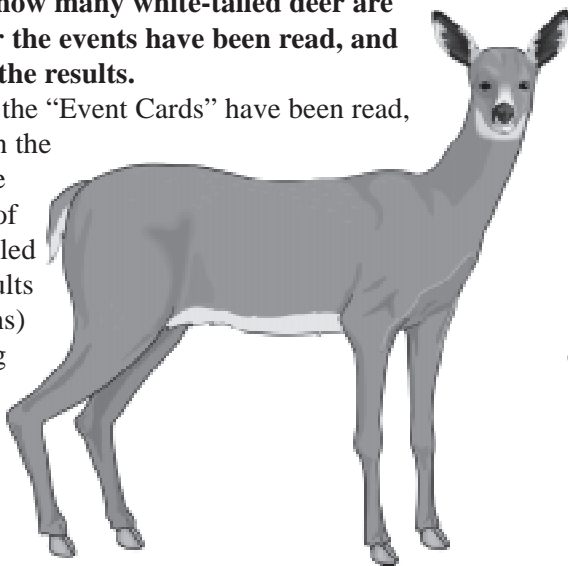

Compare different groups of white-tailed deer and determine which ones were more successful. Did genetic diversity contribute to this success? How?

### 8. Discuss the results of the game.

After you finish the game, discuss genetic diversity using the following questions:

a.

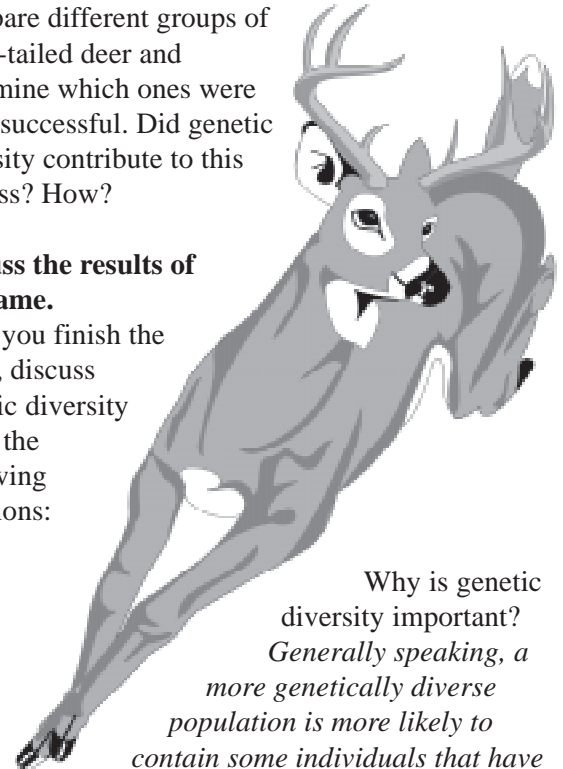

Why is genetic diversity important?  
*Generally speaking, a more genetically diverse population is more likely to contain some individuals that have the traits necessary to survive and adapt to changes in the environment than populations that aren’t as genetically diverse.*

b. What is the relationship between the size of a population and its genetic diversity?

*As a population becomes smaller, some variation in traits is lost. Because there are fewer individuals in a smaller population, it is less likely that there will be individuals with the traits necessary to survive in times of environmental stress. This is one reason smaller populations are more vulnerable to extinction. Many species that once had large populations, such as the greater prairie-chicken and American bison, have lost a great deal of their genetic diversity in a short time because of habitat loss and over-hunting.*

c. What can be done to prevent the loss of genetic diversity?

*To preserve genetic diversity, it is important that wild populations of plants and animals do not*



## Activity 1-4 The Gene Scene (continued)

*become small or fragmented. Preservation is becoming more and more challenging as human populations expand and increase their level of consumption as well as demand for space.*

- d. Did some traits seem to be favored over others? Were there any traits that were favored in one instance but selected against in another? How does this relate to the importance of genetic diversity? *A trait that is advantageous under one set of environmental conditions may be detrimental under another.*

### WRAPPING IT UP

#### Assessment

1. Pick a common animal or plant, and describe several distinct individuals, noting their physical traits. (Dogs and cats work especially well.) Students may illustrate their descriptions. How are the individuals different from one another? What sort of advantage or disadvantage might their characteristics provide?
2. Have students create displays focusing on how people have changed genetic diversity within species. Why do they do it? Each student should make a presentation about his/her display to the rest of the class. After student presentations, ask how human manipulation of genes might help or hinder biodiversity.

#### Portfolio

Have students record their ideas about using a genetic wheel to compare human traits and their understanding of genetic diversity from the game.



### Resources

- Burt, W. H. and R. P. Grossenheider. 1980. *A field guide to the mammals*. Houghton Mifflin Company, Boston. 289 pp.
- Gonick, L. and M. Wheelis. 1991. *The cartoon guide to genetics*. Harper Perennial Library, New York. 224 pp.
- Grzimek, B. 1972. *Grzimek's animal life encyclopedia*. Van Nostrand Reinhold Co., New York. 13 volumes.
- Hoffmeister, D. F. 1989. *Mammals of Illinois*. University of Illinois Press, Urbana, Illinois. 348 pp.
- Illinois Department of Natural Resources. 1999. *Biodiversity of Illinois, volume I: aquatic habitats*. Illinois Department of Natural Resources, Springfield, Illinois. CD-ROM.
- Illinois Department of Natural Resources. 2000. *Biodiversity of Illinois, volume II: woodland habitats*. Illinois Department of Natural Resources, Springfield, Illinois. CD-ROM.
- Illinois Department of Natural Resources. 2001. *Biodiversity of Illinois, volume III: prairie and edge habitats*. Illinois Department of Natural Resources, Springfield, Illinois. CD-ROM.
- Schwartz, C. W. and E. R. Schwartz. 1981. *The wild mammals of Missouri*. University of Missouri Press, Columbia, Missouri. 356 pp.
- Southern Regional 4-H Wildlife Literature Committee. 1996. *Wildlife project: white-tailed deer*. University of Illinois Extension 4-H, Urbana, Illinois. 14 pp.

The genetic wheel approach was inspired by similar activities in *Losing Biodiversity* by Katherine Barrett, Global Systems Science, Lawrence Hall of Science, University of California at Berkeley (1996); and in *Biological Science: A Molecular Approach*, D. C. Heath and Co., Boston (1985).



## CHECKING OUT YOUR GENETIC TRAITS

Which of the following traits did you inherit from your parents? Check the box next to the trait that best describes you.

1. ear lobes

attached (ll)

loose (L)

5. pigmented iris

light eyes (ee)

dark eyes (E)

2. hair type

straight (tt)

curly (T)

6. widow's peak

no peak (ww)

peak present (W)

3. tongue curling

can't curl (cc)

can curl (C)

7. little finger

straight (bb)

bent (B)

4. hair on fingers

no hair on fingers (mm)

hair on fingers (M)

What is  
your number  
from the  
genetic wheel?

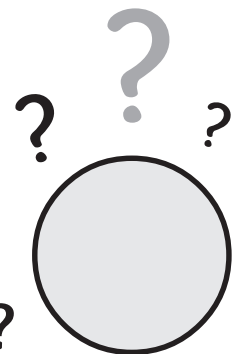



Student Page  
The Gene Scene (continued)

# HUMAN GENETIC WHEEL

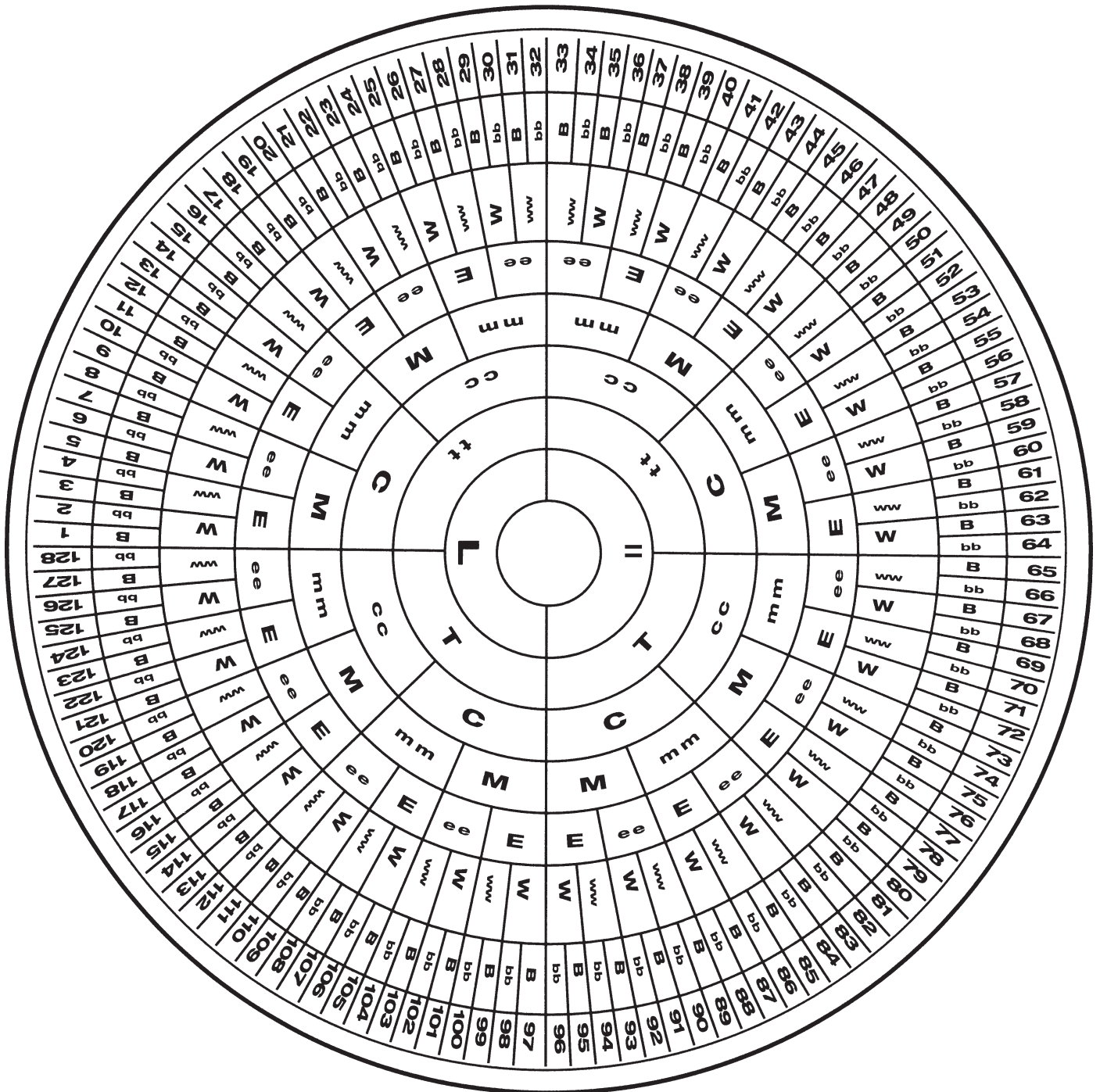



## ALL ABOUT WHITE-TAILED DEER

The white-tailed deer is a large mammal, weighing 100 to 300 pounds. Color varies seasonally. During the summer, the hair has a red tint, but during the fall and winter, it is gray-brown. The belly is white. The large tail has a white underside. Young white-tailed deer have white spots on their back. Males grow and shed antlers annually. There are no incisors or canine teeth on the upper jaw.

The white-tailed deer may be found statewide in Illinois. It lives in wooded areas but may be seen feeding far from such locations. The white-tailed deer is an herbivore, feeding on fruits, grasses, grains, vines, mushrooms, nuts and the leaves and twigs of trees and shrubs. It chews its cud, that is, bringing up material that it had chewed once and swallowed to be chewed and swallowed again. When this animal is startled, it runs and flips up its tail to show the white side. The male's antlers are shed and replaced each year.

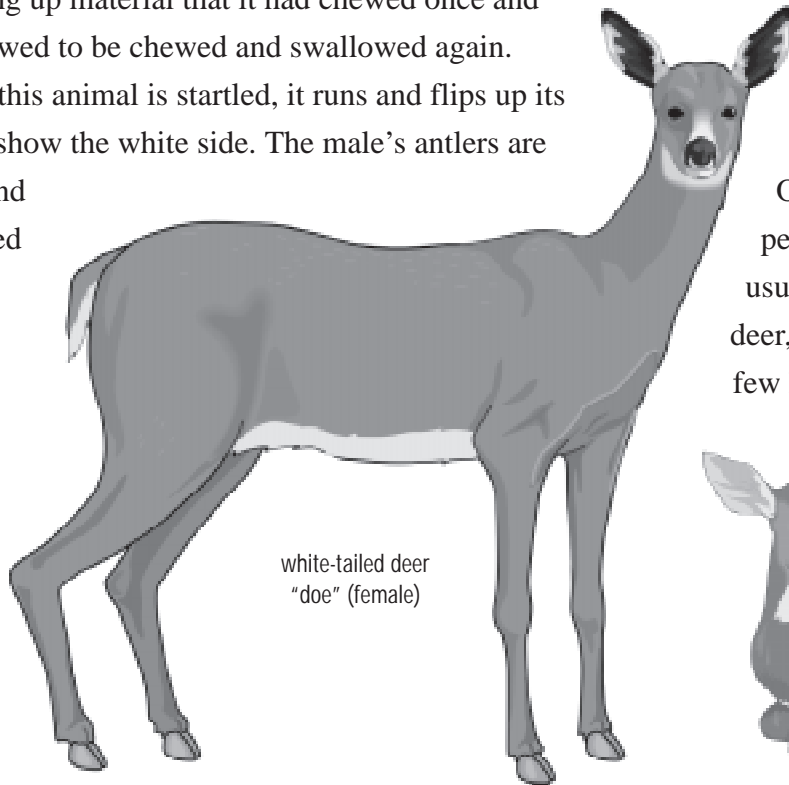

white-tailed deer  
"doe" (female)

There is a "velvet" covering over the antlers for nourishment and protection while they are growing. After the antlers are done growing in the fall, the

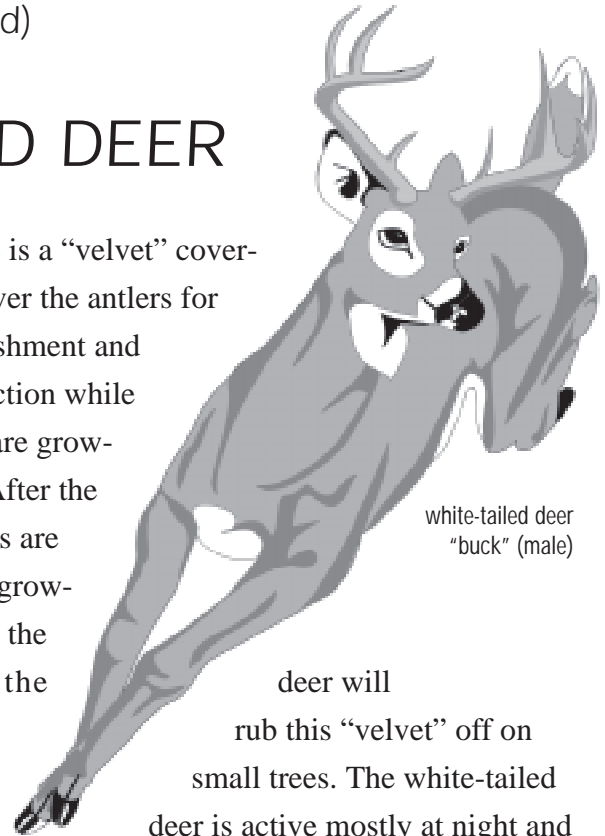

white-tailed deer  
"buck" (male)

deer will rub this "velvet" off on small trees. The white-tailed deer is active mostly at night and during the sunrise and sunset hours. The female and her offspring may stay together for several months. The male white-tailed deer is called a "buck," and the female is a "doe." A male will mate with several females. Mating occurs October through January. The gestation period is about seven months, and the doe usually produces two offspring. Young deer, called fawns, are able to run within a few hours of birth. Males drop their antlers during February and March.



white-tailed deer  
"fawn" (young)



Student Page  
The Gene Scene (continued)

# WHITE-TAILED DEER GENETIC WHEEL

Begin with the center and move outward based on your white-tailed deers traits.

Key:

Poor S of S = poor sense of smell

Good S of S = good sense of smell

LHR = large home range

SHR = small home range

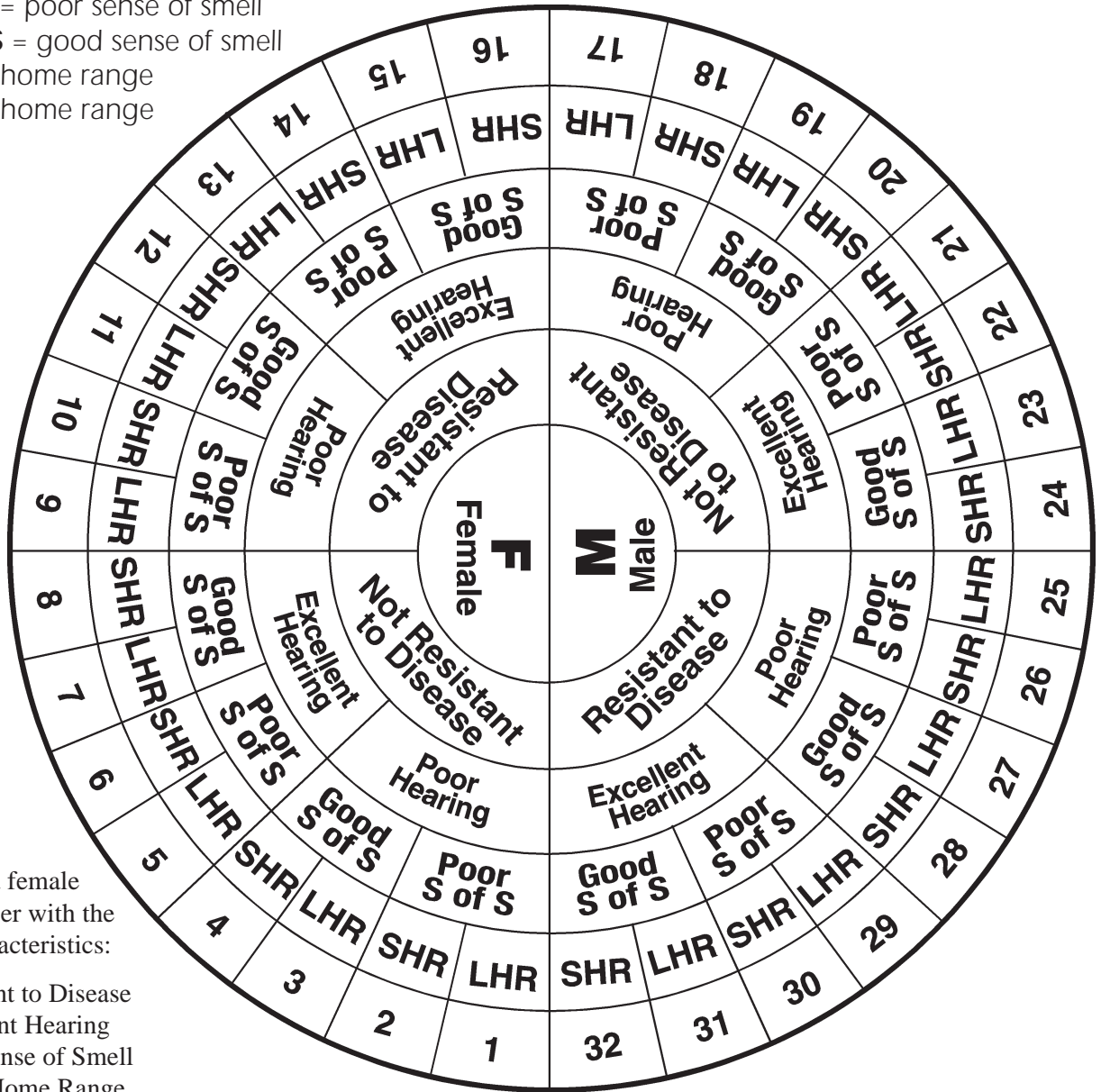

For example, a female white-tailed deer with the following characteristics:



- ✓ Resistant to Disease
- ✓ Excellent Hearing
- ✓ Poor Sense of Smell
- ✓ Large Home Range

would have a genetic number of 13.

A male with the same characteristics would have a genetic number of 29.



# WHITE-TAILED DEER CARDS—GROUP 1

 <p><b>DEER CARD</b></p> <p>Not resistant to disease Excellent hearing Good sense of smell Large home range</p>	 <p><b>DEER CARD</b></p> <p>Not resistant to disease Excellent hearing Good sense of smell Small home range</p>	 <p><b>DEER CARD</b></p> <p>Not resistant to disease Excellent hearing Good sense of smell Large home range</p>	 <p><b>DEER CARD</b></p> <p>Not resistant to disease Excellent hearing Good sense of smell Small home range</p>	 <p><b>DEER CARD</b></p> <p>Not resistant to disease Excellent hearing Good sense of smell Large home range</p>
 <p><b>DEER CARD</b></p> <p>Not resistant to disease Excellent hearing Good sense of smell Large home range</p>	 <p><b>DEER CARD</b></p> <p>Not resistant to disease Excellent hearing Good sense of smell Small home range</p>	 <p><b>DEER CARD</b></p> <p>Not resistant to disease Excellent hearing Good sense of smell Small home range</p>	 <p><b>DEER CARD</b></p> <p>Not resistant to disease Excellent hearing Good sense of smell Large home range</p>	 <p><b>DEER CARD</b></p> <p>Not resistant to disease Excellent hearing Good sense of smell Small home range</p>





# WHITE-TAILED DEER CARDS—GROUP 2

 <b>DEER CARD</b> Resistant to disease Excellent hearing Good sense of smell Small home range	 <b>DEER CARD</b> Not resistant to disease Excellent hearing Good sense of smell Small home range	 <b>DEER CARD</b> Not resistant to disease Excellent hearing Good sense of smell Large home range	 <b>DEER CARD</b> Not resistant to disease Excellent hearing Good sense of smell Small home range	 <b>DEER CARD</b> Not resistant to disease Excellent hearing Good sense of smell Large home range
 <b>DEER CARD</b> Not resistant to disease Excellent hearing Poor sense of smell Large home range	 <b>DEER CARD</b> Not resistant to disease Excellent hearing Good sense of smell Small home range	 <b>DEER CARD</b> Not resistant to disease Excellent hearing Poor sense of smell Large home range	 <b>DEER CARD</b> Not resistant to disease Excellent hearing Good sense of smell Small home range	 <b>DEER CARD</b> Not resistant to disease Excellent hearing Poor sense of smell Large home range



# WHITE-TAILED DEER CARDS—GROUP 3



## DEER CARD

Resistant to disease  
Excellent hearing  
Poor sense of smell  
Large home range



## DEER CARD

Not resistant to disease  
Excellent hearing  
Poor sense of smell  
Large home range



## DEER CARD

Resistant to disease  
Excellent hearing  
Good sense of smell  
Small home range



## DEER CARD

Not resistant to disease  
Excellent hearing  
Good sense of smell  
Small home range



## DEER CARD

Resistant to disease  
Excellent hearing  
Good sense of smell  
Small home range



## DEER CARD

Not resistant to disease  
Poor hearing  
Good sense of smell  
Small home range



## DEER CARD

Not resistant to disease  
Poor hearing  
Good sense of smell  
Small home range



## DEER CARD

Not resistant to disease  
Excellent hearing  
Good sense of smell  
Large home range



## DEER CARD

Resistant to disease  
Excellent hearing  
Poor sense of smell  
Large home range



## DEER CARD

Resistant to disease  
Excellent hearing  
Poor sense of smell  
Large home range









# WHITE-TAILED DEER CARDS—GROUP 4

 <b>DEER CARD</b> Resistant to disease Excellent hearing Good sense of smell Small home range	 <b>DEER CARD</b> Not resistant to disease Excellent hearing Good sense of smell Large home range	 <b>DEER CARD</b> Resistant to disease Excellent hearing Good sense of smell Small home range	 <b>DEER CARD</b> Resistant to disease Excellent hearing Poor sense of smell Large home range	 <b>DEER CARD</b> Resistant to disease Excellent hearing Poor sense of smell Large home range
 <b>DEER CARD</b> Resistant to disease Excellent hearing Poor sense of smell Small home range	 <b>DEER CARD</b> Not resistant to disease Excellent hearing Good sense of smell Large home range	 <b>DEER CARD</b> Not resistant to disease Poor hearing Good sense of smell Large home range	 <b>DEER CARD</b> Not resistant to disease Poor hearing Poor sense of smell Small home range	 <b>DEER CARD</b> Resistant to disease Poor hearing Poor sense of smell Small home range











# WHITE-TAILED DEER CARDS—GROUP 5

 <b>DEER CARD</b> Resistant to disease Excellent hearing Good sense of smell Large home range	 <b>DEER CARD</b> Not resistant to disease Excellent hearing Poor sense of smell Large home range	 <b>DEER CARD</b> Not resistant to disease Poor hearing Good sense of smell Large home range	 <b>DEER CARD</b> Resistant to disease Poor hearing Good sense of smell Large home range	 <b>DEER CARD</b> Resistant to disease Poor hearing Poor sense of smell Large home range
 <b>DEER CARD</b> Resistant to disease Excellent hearing Poor sense of smell Small home range	 <b>DEER CARD</b> Not resistant to disease Excellent hearing Poor sense of smell Small home range	 <b>DEER CARD</b> Not resistant to disease Poor hearing Good sense of smell Small home range	 <b>DEER CARD</b> Resistant to disease Poor hearing Good sense of smell Small home range	 <b>DEER CARD</b> Resistant to disease Poor hearing Poor sense of smell Small home range



Student Page  
The Gene Scene (continued)

WHITE-TAILED DEER FAWN CARDS

<p><b>DEER FAWN CARD</b> </p> <p><i>(circle the trait)</i></p> <p>Resistant to disease Not resistant to disease</p> <p>Excellent hearing Poor hearing</p> <p>Good sense of smell Poor sense of smell</p> <p>Large home range Small home range</p>	<p><b>DEER FAWN CARD</b> </p> <p><i>(circle the trait)</i></p> <p>Resistant to disease Not resistant to disease</p> <p>Excellent hearing Poor hearing</p> <p>Good sense of smell Poor sense of smell</p> <p>Large home range Small home range</p>	<p><b>DEER FAWN CARD</b> </p> <p><i>(circle the trait)</i></p> <p>Resistant to disease Not resistant to disease</p> <p>Excellent hearing Poor hearing</p> <p>Good sense of smell Poor sense of smell</p> <p>Large home range Small home range</p>	<p><b>DEER FAWN CARD</b> </p> <p><i>(circle the trait)</i></p> <p>Resistant to disease Not resistant to disease</p> <p>Excellent hearing Poor hearing</p> <p>Good sense of smell Poor sense of smell</p> <p>Large home range Small home range</p>	<p><b>DEER FAWN CARD</b> </p> <p><i>(circle the trait)</i></p> <p>Resistant to disease Not resistant to disease</p> <p>Excellent hearing Poor hearing</p> <p>Good sense of smell Poor sense of smell</p> <p>Large home range Small home range</p>
<p><b>DEER FAWN CARD</b> </p> <p><i>(circle the trait)</i></p> <p>Resistant to disease Not resistant to disease</p> <p>Excellent hearing Poor hearing</p> <p>Good sense of smell Poor sense of smell</p> <p>Large home range Small home range</p>	<p><b>DEER FAWN CARD</b> </p> <p><i>(circle the trait)</i></p> <p>Resistant to disease Not resistant to disease</p> <p>Excellent hearing Poor hearing</p> <p>Good sense of smell Poor sense of smell</p> <p>Large home range Small home range</p>	<p><b>DEER FAWN CARD</b> </p> <p><i>(circle the trait)</i></p> <p>Resistant to disease Not resistant to disease</p> <p>Excellent hearing Poor hearing</p> <p>Good sense of smell Poor sense of smell</p> <p>Large home range Small home range</p>	<p><b>DEER FAWN CARD</b> </p> <p><i>(circle the trait)</i></p> <p>Resistant to disease Not resistant to disease</p> <p>Excellent hearing Poor hearing</p> <p>Good sense of smell Poor sense of smell</p> <p>Large home range Small home range</p>	<p><b>DEER FAWN CARD</b> </p> <p><i>(circle the trait)</i></p> <p>Resistant to disease Not resistant to disease</p> <p>Excellent hearing Poor hearing</p> <p>Good sense of smell Poor sense of smell</p> <p>Large home range Small home range</p>



## Student Page The Gene Scene (continued)

# EVENT CARDS

The deadly EHD (epizootic hemorrhagic disease), a disease spread by a virus, is killing many deer. White-tailed deer with resistance to the disease are much more likely to survive and reproduce.

**Lose half of your white-tailed deer that are "not resistant to disease."**

EVENT  
CARD

Nondominant males may wander from group to group.

**Every group should give one nondominant male white-tailed deer to the group to their left.**

EVENT  
CARD

A severe drought has hit Illinois. Because of the extreme dry conditions, white-tailed deer must travel farther to find food and water.

**Lose one white-tailed deer that has a "small home range."**

EVENT  
CARD

Young fawns are particularly vulnerable to predation by coyotes. A fawn with a poor sense of smell might not be able to detect a coyote in time to escape.

**Lose half of your fawns with a "poor sense of smell."**

EVENT  
CARD

Deer meat, otherwise known as venison, has recently become popular. Poachers are illegally hunting white-tailed deer after dark. Deer with poor hearing are easy targets as the poachers drive up in their vehicles.

**Lose half of your white-tailed deer with "poor hearing."**

EVENT  
CARD

Habitat fragmentation has resulted from construction of new housing developments and an increase in roads. As they move between the smaller habitats, white-tailed deer have a greater chance of being hit by cars and trucks on the roads.

**Lose one white-tailed deer with a "small home range."**

EVENT  
CARD

In the breeding season, males mark their territories with scents and visit the scented sites often. A female with a good sense of smell is more likely to know where the male will be when she is ready to mate, increasing her chances of successful reproduction. Add one fawn for each "good sense of smell" female white-tailed deer in your group, only if a male is present to mate with her.

Each group should take the appropriate number of fawn cards out of the fawn card container.

**Assign traits that are present in the parents (each "good sense of smell" female and the dominant male) to their fawn.**

EVENT  
CARD

It has been a mild winter this year, yielding an abundance of food. Because of good nutrition, all of your female white-tailed deer give birth in the spring.

**Add one fawn for each "small home range" female white-tailed deer, only if a male is present to mate with her.**

**Add three fawns for each "large home range" female white-tailed deer, only if a male is present to mate with her.**

**Assign traits that are present in the parents of the fawns.**

EVENT  
CARD



## Activity 2-1

### The Nature of Poetry (continued)

“**Elm Buds**” by Carl Sandburg, from *Honey and Salt*:

*A New Volume of Poems* (see "Resources" list)

“**Tomorrow**” by Ann Carlson, from *Prairie Poetry*  
(see "Resources" list)

“**I Could Not Swallow the Lake**” by Andrea L.  
Change, from *Power Lines* (see "Resources" list)

#### 2. Discuss the poems.

Encourage your students to discuss their reactions to each of the poems. You may want to start with general questions regarding students' likes and dislikes of the poems and their reasoning for such feelings. Ask the students if any poem captured their feelings about nature and/or biodiversity. You may also want to ask specific questions about each poem. Be sure to discuss the tone, setting and images evoked by each poem. Allow the students to speak freely and give recognition to any answer that they can support thoughtfully.

#### 3. Have students write their own poetry.

To assist students in writing original poetry, it is important to help them focus their writing. You might begin by asking them to recall some of the different emotions or ideas conveyed in the poetry they have read (awe, delight, humor, fear of wildlife and so on). Have they had similar or different reactions to the plants, animals and places they have seen or read about? With the students working in small groups, encourage them to share specific emotions about significant experiences with nature that they have had. You might even want the students to share images that capture the feeling or idea they are remembering.

Alternatively, you might want to take students outside for a nature walk. Encourage them to look closely at one or a few specific elements of the natural world. They can draw pictures or jot down ideas before going back inside.

Pass out copies of the “Student Page—Types of Poems.” Go over the descriptions of the different kinds of poems to make sure the students under-

stand them. Explain to the students that they will be writing their own poems about biodiversity. They can choose any form of poetry, from one of the forms described on the sheet to rhyming verse. And they may write about any aspect of biodiversity they choose. They should write at least two poems, each using a different style.

Allow the students to begin writing their poetry. Again, they can write about any aspect of biodiversity—a specific place they have visited, a particular plant or animal, their general feelings or ideas about nature and so on. Remind the students that images and rhythms can all be used to reflect their ideas and feelings. And stress again that poetry can convey all kinds of feelings—both positive and negative.

You'll probably need to give the students more than one session to finish their poems. Assign the final poems as homework and have the students turn them in on another day. They can read them out loud to the group, also.

## WRAPPING IT UP

### Assessment

1. Ask the students to select one of their poems and copy it onto paper without their name. Collect the poems and then randomly redistribute them (making sure that the students don't get their own poems). Have students become “peer coaches” and write commentaries on the poems they receive. In their reviews they can describe the moods the poems create, the ways the words and phrases convey the moods and meanings, what the poems mean to them, strengths of the poems, suggestions for improvements, and the connections between the poems and biodiversity. Assess the reviews on the student's ability to interpret and analyze the poem, to synthesize their critical review and personal reactions, and to apply critical thinking skills.



## Activity 2-1 The Nature of Poetry (continued)

2. Have each student write another poem using one of the following leads.

**I'll always remember . . .** (Describe an experience with nature.)

**I don't understand why some people feel \_\_\_\_\_ around animals.**

3. Have the students illustrate one of their poems or draw a picture about what it describes.

### Portfolio

The poems and critiques of the poems can be used as part of the student's portfolio.

### Extensions

1. Collect the students' poems and publish them. Distribute copies of the poetry book to the student-authors, as well as to others in your school and community.
2. Have a "Biodiversity Poetry Jam." Students can invite other classes to listen as they read their biodiversity poems out loud. They can also recite the biodiversity poems they read at the beginning of this activity. You can provide refreshments to make the jam like a real coffeehouse event.
3. Have students record their poetry including natural sound effects and rhythms, available from nature stores or other sources.

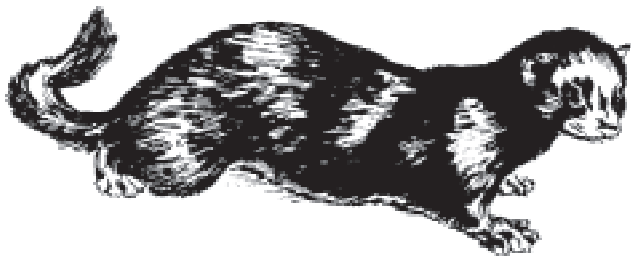

## Resources

### Philosophical

- Berry, Wendell. 1968. *Openings*. Harcourt, Brace and World, New York. 67 pp.
- Merrill, Christopher. 1991. *The forgotten language: contemporary poets and nature*. Peregrine Smith Books, Salt Lake City, Utah. 77 pp.
- Pack, Robert and Jay Parini. 1993. *Poems for a small planet: contemporary nature poetry*. University Press of New England, Hanover, New Hampshire. 320 pp.
- Roberts, Elizabeth, Amidon, Elias and Wendell Berry, editors. 1991. *Earth prayers: from around the world, 365 prayers, poems and invocations for honoring the earth*. Harper, San Francisco. 480 pp.

### Light Poetry Reading

- Armstrong, Patricia Kay. 1979. *Prairie poetry*. The Naperville Sun, Naperville, Illinois. 154 pp.
- Berry, Wendell. 1984. *The collected poems, 1957-1982*. North Point Press, Albany, California. 268 pp.
- Nash, Ogden. 1965. *The animal garden*. M. Evans and Company in association with Lippincott, Philadelphia. 48 pp.
- Parson-Nesbitt, Julie, Rodriguez, Luis. J. and Michael Warr, editors. 1999. *Power lines: a decade of poetry from Chicago's Guild Complex*. Tia Chucha Press, Chicago. 200 pp.
- Sandburg, Carl. 1963. *Honey and salt: a new volume of poems*. Harcourt, Brace, Jovanovich, New York. 111 pp.

### Poetry Collections for Children

- Adams, Adrienne, editor. 1972. *Poetry of earth*. Scribner, New York. 48 pp.





## Activity 2-1 The Nature of Poetry (continued)

Carpenter, Jill, editor. 1998. *Of frogs and toads*. Ione Press, Sawanee, Tennessee. 131 pp.

Cowden, Frances B. and Eve B. Hatchett. 1994. *Of butterflies and unicorns and other wonders of the earth*. Grandmother Earth, Germantown, Tennessee. 63 pp.

Daniel, Mark. 1986. *A child's treasury of poems*. Dial Books for Young Readers, New York. 160 pp.

Fulcrum Resources Contest Winners, Third Annual. 2000. *From ants to zorapterans: pesky poems about bugs*. Fulcrum Resources, Golden, Colorado. 144 pp.

Livingston, Myra, editor. 1992. *If you ever meet a whale*. Holiday House, New York. 32 pp.

### Teaching Poetry

Hopkins, Lee Bennett. 1987. *Pass the poetry, please*. Harper Collins Children's Books, New York. 262 pp.

Larrick, Nancy. 1991. *Let's do a poem*. Delacorte, New York. 122 pp.

Lies, Betty B. 1993. *The poet's pen: writing poetry with middle and high school students*. Libraries Unlimited, Englewood, Colorado. 201 pp.

---

***“In the end, the poem is not a thing we see; it is, rather, a light by which we may see—and what we see is life.”***

*—Robert Penn Warren, writer*

---



# TYPES OF POEMS



## Haiku

*A type of poetry from Japan with a very structured pattern.*

Line 1— 5 syllables	<b>Trees bend with strong wind</b>
Line 2— 7 syllables	<b>gusts and torrents blow so hard</b>
Line 3— 5 syllables	<b>yet ever rooted.</b>



## Free verse

*Any number of open lines with no set rhyme or pattern.*

**Sun sets gently  
through the horizon cushion  
to be absorbed  
beyond view.**



## Cinquain

*Verses with the following pattern:*

- Line 1—one word title .....▶ *Swallows*
- Line 2—two words describing title .....▶ *Sleek, deft*
- Line 3—three words showing action .....▶ *diving, soaring, flying*
- Line 4—four words showing a feeling about the title .....▶ *bringing joy to Earth*
- Line 5—one word (simile or metaphor for the title) .....▶ *dancers.*



## Diamante

*A poem written in the shape of a diamond, using a set order of grammatical words, like nouns, adjectives. Often the first half of the poem is the opposite of the second half.*

	noun				
	adjective	adjective			
participle	participle	participle	participle		
noun	noun	noun	noun		
participle	participle	participle	participle		
adjective	adjective				
	noun				

	turtle				
	bulk	cumbersome			
crawling	creeping	dragging			
shell	legs	paws	fur		
running	racing	leaping			
quick	slick				
	cheetah				





## Activity 2-2 The Spice of Life

### AT A GLANCE

Explore beliefs and values about why biodiversity is important and why it should be protected.

### OBJECTIVES

Explain personal beliefs and values about protecting biodiversity. List several reasons why people believe it is important to protect biodiversity.

### SUBJECTS

English language arts, science, social science

### SKILLS

organizing (prioritizing), analyzing (discussing), presenting (articulating), citizenship (debating, evaluating a position, taking a position, defending a position)

### LINKS TO ILLINOIS BIODIVERSITY BASICS CONCEPTUAL FRAMEWORK

values and beliefs

### VOCABULARY

ecological processes, economics, extinct, pollination

### TIME

one class period

### MATERIALS

poster-sized paper; markers

### CORRELATION TO ILLINOIS LEARNING STANDARDS

English language arts 4.B.2a, 4.B.2b

science 13.B.2f, 13.B.3d

social science 17.C.2c

People's feelings about biodiversity issues, including the importance people place on wild species and spaces and whether they think biodiversity should be protected, do not depend on just their knowledge of these issues and the sciences that relate to them (ecology, biology, sociology, political science, economics and so on). People's feelings also depend on personal belief systems and values. This activity is designed to give your students a chance to examine their values and to sharpen their own thinking by sharing their opinions and feelings with their peers. The students first discuss their points of view in small groups and then talk about biodiversity conservation as a whole group. A series of questions is provided to get the students thinking about a range of biodiversity-related concerns, as well as additional guiding questions to help direct the discussions. You may want to add your own questions to these lists and think about other ways to engage your group.

### BEFORE YOU BEGIN

Write each of the "Why Care About Biodiversity?" statements (page 71) on six separate pieces of poster-sized paper. You can adapt, shorten, add or combine as needed. Write the word "Other" on a seventh piece of poster-sized paper. Make sure that the students can read the statements from all areas of the room.

### WHAT TO DO

#### 1. Discuss the meaning of biodiversity with your students.

Biodiversity is the variety of life on earth. It includes the sheer variety of species on earth, the earth's many ecosystems and genetic diversity, which refers to the variety of genes within a species.

#### 2. Ask your students whether protecting biodiversity is important and why they feel the way they do.

Explain that many people feel that it's important to protect biodiversity and that they have diverse reasons for thinking so. Ask your students how they feel. What reasons can they give to protect biodiversity? These may be reasons they have read, reasons they have heard others express or their own,

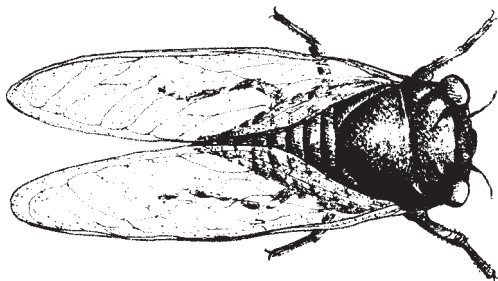



## Activity 2-2

### The Spice of Life (continued)

personal views. Write their ideas on a piece of poster-sized paper or a chalkboard. (It may also help to give them a few minutes to write their ideas before talking.)

#### 3. Put up the “Why Care About Biodiversity?” statements and read each one out loud.

Using a different location for each one, tape the seven statements you copied earlier around the room. Place each one high enough for everyone to see. Explain that the statements represent many of the key reasons people have given for why it is important to protect biodiversity. As a group, go over each of the statements. Compare the ideas represented in the statements with the lists that the students generated.

#### 4. Students choose a statement to stand near.

Ask your students to carefully consider all of the statements. Have each student pick one of the statements and then go and stand near it. Explain that the statement each student chooses should be one that he/she feels strongly about—either because he/she thinks it is an important reason to protect biodiversity, or because he/she disagrees with it. If they don’t see a sign that reflects their viewpoint, they can stand at the sign marked “Other.” Explain that there is no correct answer and that it’s OK to stand either alone or with a group.

#### 5. Discuss the choices that students made.

After everyone has made a selection, have the students at each statement discuss among themselves why they chose that particular statement. Remind them that each person will have personal reasons for making the choice he or she made and that they should explore some of those reasons. Give the students about five minutes to discuss their thoughts before asking one person from each group to summarize the discussion. You may want to record each group’s points on the piece of poster-sized paper.

#### 6. Open the discussion to the entire class.

After all the groups have given their summaries, use the “Valuing Biodiversity” questions (page 70) to spur a group discussion of some of the arguments that biologists, conservationists, ecologists, economists and others have put forth for protecting biodiversity. Read one of the numbered questions and have the students react to it. You can use the guiding questions to challenge the students’ thinking and to help direct their discussion as needed. You do not need to ask the class all the guiding questions, and the students do not need to discuss each of the numbered questions in turn. The discussion may naturally flow from one topic to another. However, during the course of the discussion, make sure that the students confront the issues highlighted by each numbered question and that they explain why they feel the way they do. Have them give examples whenever they can and be sure to challenge their ideas—especially when the students reach answers quickly or all of them seem to be agreeing with each other. Allow enough time for the students to fully discuss their points of view. Also give them an opportunity to research issues that come up.

## WRAPPING IT UP

### Assessment

1. Have the students write a personal statement about the importance of protecting biodiversity. Explain that there is no right or wrong answer to this assignment—and that they don’t even have to think protecting biodiversity is important at all. However, they should carefully consider everything they’ve learned about biodiversity as well as all of the points made during their discussion in order to make a well-reasoned and well-supported statement. Encourage the students to consider medical, economic and ecological implications of biodiversity protection, as well as recreational considerations, artistic inspiration and any obligations of present generations to future ones. Tell them to use examples to illustrate their points.



## Activity 2-2 The Spice of Life (continued)

2. Have the students use the following statement as a journal starter: “Some ideas or thoughts I had before the activity are different now. They include . . .”
3. Have the students write a dialogue between two people who have different viewpoints on protecting biodiversity.

### Portfolio

The student’s biodiversity protection statement (created in the assessment) can be included in the portfolio.

### Extension

Have each student or small group of students choose one of the “Why Care About Biodiversity?” statements to use as a theme for a collage. Have the students make a display of the collages.

## Resources

- Kellert, Stephen. 1997. *The value of life: biological diversity and human society*. Island Press, Washington, D. C. 263 pp.
- Lean, Geoffrey and Don Hinrichsen. 1996. *World Wildlife Fund atlas of the environment*. Prentice Hall Press, New York. 192 pp.
- Takacs, David. 1996. *The idea of biodiversity: philosophies of paradise*. Johns Hopkins University Press, Baltimore, Maryland. 393 pp.
- Wilson, Edward O. 1992. *The diversity of life*. Belknap Press, Cambridge, Massachusetts. 424 pp.

*“The twentieth century has been extra-ordinarily successful for the human species—perhaps too successful. As our population has grown from 1 billion to 6 billion and the economy has exploded to more than 20 times its size in 1900, we have overwhelmed the natural systems from which we emerged and created the dangerous illusion that we no longer depend on a healthy environment. As a result, humanity now faces a challenge that rivals any in history; restoring balance with nature while expanding economic opportunities for the billions of people whose basic needs—for food and clean water, for example—are still not being met.”*

*—Lester Brown, President, World Watch Institute*



## Educator Page Valuing Biodiversity

### 1. It is important to conserve the diversity of life for medical and economic reasons.

#### Guiding Questions

- Do people actually need wild plants and animals for either medicinal or economic reasons?
- Can't people synthesize in a laboratory all the medicines they need?
- If genetic material is what's important, wouldn't it be sufficient if people froze wild plant and animal tissue samples, didn't worry about the actual organisms and then used the samples when needed?
- If a plant or animal species is not known to have any medical or economic benefit to people, is it then OK to let the species die out?

### 2. It's important to protect the diversity of life because biodiversity helps maintain important ecological processes that help support life on earth.

#### Guiding Questions

- What sorts of ecological processes does biodiversity help maintain?
- People have developed an amazing array of technologies to deal with particular problems—everything from water treatment plants that purify sewage water to scrubbers that can take pollutants from factory smokestacks out of the air. Isn't it fair to assume that people will be able to develop technologies that can perform essential ecological processes in place of biodiversity?
- Are there any down sides to technological solutions?

### 3. Our lives would not be as rich if we lost species such as river otters, fireflies, red-tailed hawks, treefrogs, Illinois mud turtles and bobcats.

#### Guiding Questions

- Is there anything about these species that makes them special?

- Would you feel the same way if the species we lost were venomous snakes, biting insects and other species that may be harmful to people?
- Are there species that you think are more important to protect than others? Which ones? Why?

### 4. All species have a right to exist.

#### Guiding Questions

- Do people have the right to use any of the world's resources as they see fit? Why or why not?
- Does the right to exist apply to ugly, obscure species that are of no use to people?
- Some species have been around for millions of years—and have survived incredible periods of destruction and change on the planet. Should that influence whether we decide to protect a species?
- Do people have any responsibilities to other living things?
- Do people have the right to drive species to extinction?

### 5. No generation has the right to destroy the environment and resources that future generations will depend on.

#### Guiding Questions

- Why should people today do without things they want, when we don't even know what future generations will need or want?
- How do you feel about the state of the world? Do you feel that past generations have left you with the environment and resources you need to live?
- There used to be millions of passenger pigeons in the United States. Today these birds are extinct. Has your life been affected in any way by the lack of passenger pigeons in the world? Will future generations really care about species that disappeared before they were born?



## Educator Page Valuing Biodiversity (continued)

### 6. Diversity of life is important for inspiring inventors and artists and for spurring curiosity and imagination.

#### Guiding Questions

- What human pursuits look to nature for inspiration?
- What inventions, stories or works of art can you think of that were inspired by living things? Could these have been produced without the inspiration of nature?
- Isn't it reasonable to assume that all the photographs and films that have been made of wild plants and animals can provide inspiration to future writers and artists?

### 7. Diversity of life is important for recreational activities.

#### Guiding Questions

- What kinds of recreational activities rely on wild spaces or species?
- Can well-tended golf courses and manicured parks provide the outdoor green space people need?
- Is it right to save an area so people can hike and fish if it means that other people lose their jobs?
- Does the fact that someone has done a particular job all his or her life—and that perhaps his or her parents or grandparents also did the same job—give the person a right to keep doing that job, even if it means wiping out a species or harming the environment?
- Should people be allowed to take part in any recreational activity (such as some off-road vehicle races) even if it harms the environment? How do we balance the rights of individuals and the rights of society as a whole?

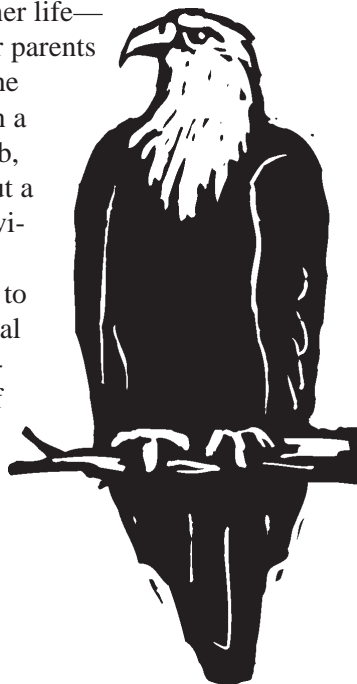

### Why Care about Biodiversity?

It is important to conserve the diversity of life for medical and economic reasons. Plants and animals could provide us with additional foods, medicines and other products that will save lives and benefit society.

It is important to protect the diversity of life because biodiversity helps maintain important ecological processes such as oxygen production, pollination and flood control that, in turn, help support all life on earth.

Our lives would not be as rich if we lost species such as river otters, fireflies, red-tailed hawks, treefrogs, Illinois mud turtles and bobcats and the habitats where they live. The rich diversity of life also allows for important recreational activities such as hiking, fishing, camping and birding.

It is important to protect the diversity of life because no generation has the right to destroy the environment and resources on which future generations depend. It is our responsibility to take care of the diversity of life.

It is important to protect the diversity of life because biodiversity provides inspiration and provokes curiosity and imagination. Diversity of life often inspires the creation of art, music and poetry, as well as many technological advances, such as flight.

It is important to conserve the diversity of life because all species have a right to exist.



## Activity 2-3 Secret Services

### AT A GLANCE

Perform simulations that demonstrate some of the important ecosystem services that biodiversity provides.

### OBJECTIVES

Perform a series of simulations that demonstrate ecosystem services. Identify and discuss the services illustrated in the simulations.

### SUBJECTS

English language arts, science, social science

### SKILLS

organizing (manipulating materials), interpreting (identifying cause and effect, inferring, making models), presenting (demonstrating, explaining), citizenship (working in a group)

### LINKS TO ILLINOIS BIODIVERSITY BASICS

#### CONCEPTUAL FRAMEWORK

genetic/species/ecological diversity

#### VOCABULARY

atmosphere, evaporation, heavy metals, impurity, mineral, pesticides, photosynthesis, sediment, toxic substance, transpiration, wetland

#### TIME

two class periods

#### MATERIALS

**station #1:** clear funnel or clear plastic soda bottle with the bottom cut off and the label removed; clear plastic cup, tall jar or flask; cotton balls or toilet paper; activated charcoal; sand; potting soil; water

**station #2:** fresh celery stalks with leaves; a jar or beaker; red or blue food coloring; water; paring knife; magnifying glass

**station #3:** several sponges; a doormat or a piece of artificial turf; two flat sheets of wood or plastic similar in size to the doormat; two shallow aluminum trays; soil; two containers of water; props to tilt the models

**station #4:** two large, clear-plastic cups; a six-inch square piece of waxed paper; geranium plant leaf with stem; cobalt chloride paper (available from science supply catalogs); petroleum jelly; paper clip; tape; water

**station #5:** large bowl; water; measuring cup; tablespoon; baking soda; drinking glass; lamp; water plant such as *Elodea* or *Anacharis* (available from stores that sell live fish)

copy of "The Secret's Out!" for each student

#### CORRELATION TO ILLINOIS LEARNING STANDARDS

English language arts 4.B.2a; 4.B.2b; 4.B.3a  
science 11.A.2e; 12.E.2a; 12.E.2b; 12.E.3b  
social science 17.B.2a; 17.B.2b; 17.B.3a

Ecosystems and the variety of species within them provide many important services that help make life possible or at least more livable. These services are happening all the time—they are so common that we often don't notice them or think about how important they are. This activity is a series of five simulations that illustrate a variety of these services. (More advanced students can try to develop their own simulations after learning more about ecosystem services.)

### BEFORE YOU BEGIN

There are a number of ways you can use this activity with your students. We suggest that students be grouped into five secret service teams. Assign each team the task of setting up and testing one of the simulations on Day 1. On Day 2, have each team present its secret service simulation to the class. After watching each presentation, students will use the handout "The Secret's Out!" to identify the ecosystem service being demonstrated in the simulations.

You will need to arrange stations for each team's simulation. Put a copy of the directions and the necessary materials at each station. Label each of the five stations. Also make one copy of "The Secret's Out!" for each student. (Please note that Station #2 is shorter than the others, yet it still requires two days. It can be combined with Station #3. Stations #2 and #3 require some preparation ahead of time. Stations #1, #4 and #5 require activated charcoal, cobalt chloride paper and *Elodea*, respectively. Activated charcoal and *Elodea* can be found in most pet stores that sell fish. Cobalt chloride paper can be ordered through science supply catalogues.)

### WHAT TO DO

#### 1. Day 1: Setting the stage.

Divide your class into five teams and assign one team to each station. Explain that the students will be working together to complete a simulation. Each team will be responsible for a different simulation. Students should not discuss their simulation with other members of the class. The simulations illus-





## Activity 2-3 Secret Services (continued)

trate various ways that ecosystems provide important services for us and the environment. Identify the five stations around the room.

When they arrive at a station, all the members of the team should read the directions completely before setting up the simulation. Students should then set up and run their simulation. Tell them that on Day 2, each team will run its simulation for the class. Each team should discuss the expected outcome of the simulation. Each member of the team should also answer the questions listed under “Think About It.”

**Note:** Remind the students that after they try their simulation, they have to get it ready for the next day, so they might have to dry their equipment and/or supplies or replace some of the parts. Stations #2, #4 and #5 require 24 hours to complete. Let the students at these three stations know that they will not need to run the simulation again on Day 2 but that they’ll have to explain what they did on Day 1.

### 2. Day 2: Presenting the simulations and matching the analogies.

Distribute the “The Secret’s Out!” page to each student. Explain to the students that each team will have a few minutes to explain their simulation to the class. Ask each team to briefly review its procedures, perform the simulation (or explain the results of an overnight simulation) and discuss the results. Students should provide information to the class that answers the “What Happened?” and “Think About It” sections on their handout. After watching each presentation, have the students use “The

Secret’s Out!” page to identify the ecosystem service being demonstrated in the simulation. Discuss student responses. (Answers: A—2, B—3, C—1, D—5, E—4)

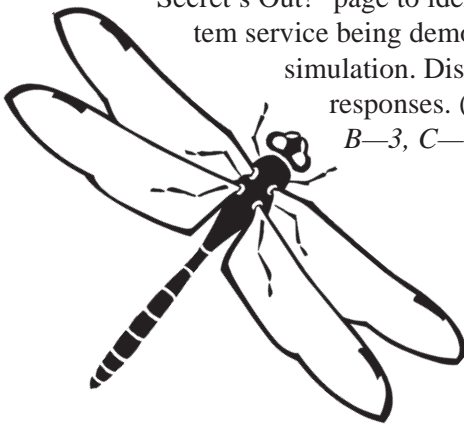

### 3. Review and summarize.

When all the teams have completed their presentations, review and summarize the different ways ecosystems provide important services to people and to the planet. The list should include flood control, water filtering and purification, erosion control, oxygen production and climate control.

## WRAPPING IT UP

### Assessment

1. Use the last step of the activity (“What to Do,” Step #3) as the assessment. Encourage students to include on each list how the service is conducted in the “real” world and to give local, regional or state examples of where the ecosystem services are taking place (e.g., local marsh, Shawnee National Forest, Volo Bog State Natural Area).
2. Students may keep a lab manual and make a report for each station. Lab reports should include an overview of the simulation, a description of what happened and an analysis of the secret service that was simulated.

### Portfolio

The lab reports for each station from Assessment #2 can be placed in the portfolio.

### Extensions

1. Identify places in your community where the ecosystem services that you simulated are occurring.
2. Have students propose or create simulations that model other ecosystem services.
3. Using the Illinois Department of Natural Resources’ *Biodiversity of Illinois* CD-ROM series, identify species that perform these ecosystem functions.
4. Ask each student to illustrate one or two ecosystem services through sculpture, photography or another art form. The student can use words to clarify points, but words should not be the focus of the illustration.



## Activity 2-3 Secret Services (continued)

### Resources

- Bernstein, Leonard, Winkler, Alan and Linda Zierdt-Warshaw. 1995. *Environmental science: ecology and human impact*. Addison-Wesley Publishing Company, Inc., Menlo Park, California. 452 pp.
- Environmental Concern, Inc., and The Watercourse. 1995. *WOW! The wonders of wetlands*. Environmental Concern, Inc., and The Watercourse, Bozeman, Montana. 332 pp.
- Illinois Department of Natural Resources. 1999. *Biodiversity of Illinois, volume I: aquatic habitats*. Illinois Department of Natural Resources, Springfield, Illinois. CD-ROM.
- Illinois Department of Natural Resources. 2000. *A field guide to the wetlands of Illinois*. Illinois Department of Natural Resources, Springfield, Illinois. 252 pp.
- Illinois Department of Natural Resources. 2000. *Biodiversity of Illinois, volume II: woodland habitats*. Illinois Department of Natural Resources, Springfield, Illinois. CD-ROM.
- Illinois Department of Natural Resources. 2001. *Biodiversity of Illinois, volume III: prairie and edge habitats*. Illinois Department of Natural Resources, Springfield, Illinois. CD-ROM.
- Oates, Maureen. 1995. *Ecosystems (science is elementary—a science teaching resource publication)*. Museum Institute for Teaching Science, Boston. 46 pp.
- Washington State Department of Publications Office. 1996. *Discover wetlands*. Washington State Department of Publications Office, Olympia, Washington. 235 pp.
- The Watercourse and Western Regional Environmental Education Council. 1995. *Project WET*. The Watercourse and Western Regional Environmental Education Council, Bozeman, Montana. 518 pp.





## Activity 2-3 Secret Services

Nearly half of a tree's biomass is hidden in a vast tangle of roots under the ground. And scientists have found that these roots, in turn, are usually woven into an even bigger web made of fungi. Fungi and trees have a symbiotic relationship that benefits both. Fungi help trees absorb important nutrients like nitrogen and phosphorus from the soil. And trees provide fungi with carbon, which the fungi absorb from the trees' roots. Scientists are also finding that this tangled relationship is even more complex than they realized and that the fungi may actually be helping to “manage” the forest by giving some trees more nutrients than others.

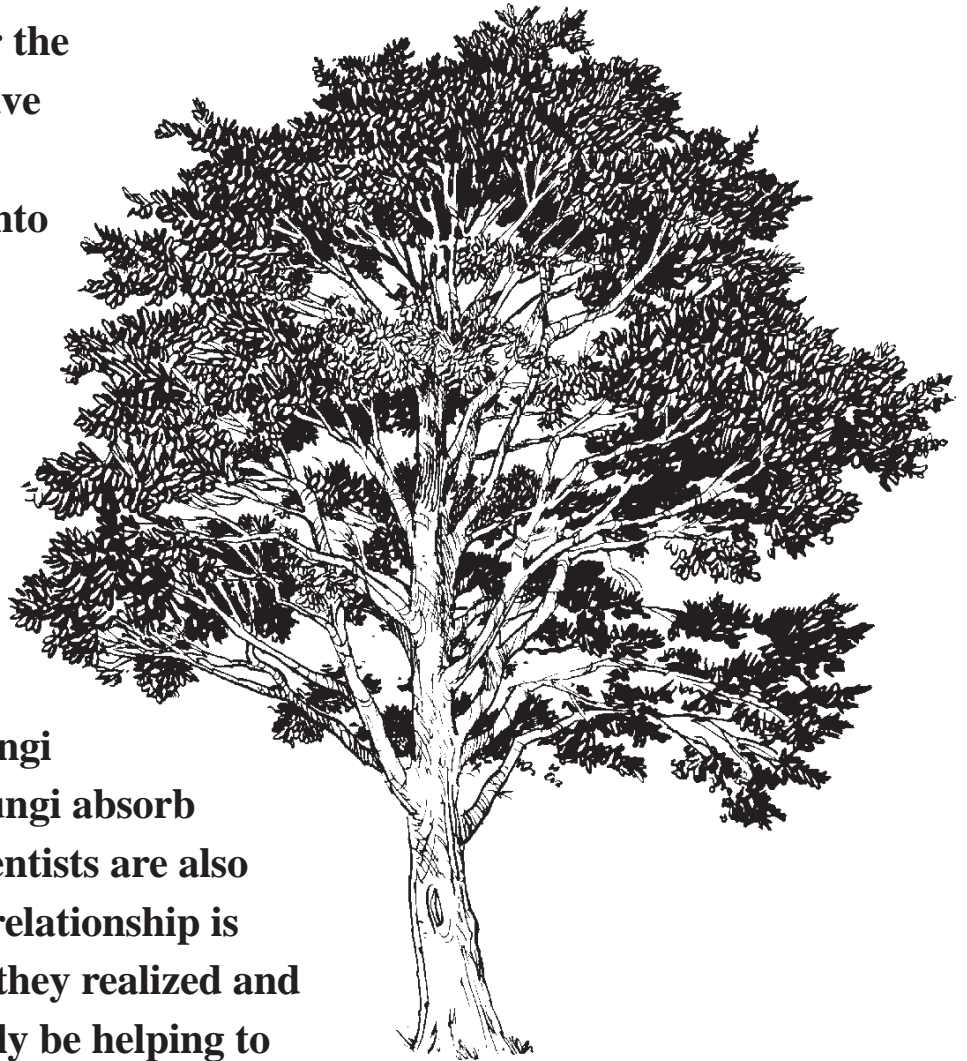

—Adapted from “The Web Below,” by Carl Zimmer in *Discover*, November 1997.



**CLASSIFIED  
INFORMATION**

**Do not share this  
information with  
other teams!**

Soil is a mixture of mineral particles, air, water, micro-organisms and other organic matter (material derived from living things). The materials that make up soil form layers. Hundreds of years may be required to form just a few inches of soil. Soil helps to purify water by filtering out some of the suspended solids (floating “dirt” particles) as they flow through the different soil layers. The makeup of the soil determines how well it will act as a filter. Soil also helps to remove chemical contaminants such as fertilizers and pesticides. Many minerals in the soil can chemically bond with contaminants, which are then stored in the soil and prevented from flowing into nearby waterways. As a result of chemical reactions, the soil can also help “detoxify” certain chemicals, making them less harmful to living things.

## STATION 1: DIRTY WATER

### MATERIALS

clear funnel or clear plastic soda bottle with the bottom cut off and the label removed; clear plastic cup; tall jar or flask; cotton balls or toilet paper; activated charcoal; sand; potting soil; water

### WHAT TO DO

1. Pack the funnel approximately one-third full with cotton balls.
2. Place a layer of charcoal on top of the cotton balls. Then place a layer of sand on top of the charcoal.
3. Place the funnel into the jar or flask. The mouth of the jar should be small enough to keep the funnel off the bottom of the jar. (See diagram.)
4. Mix one-fourth cup of potting soil with one-half cup of water in the plastic cup. Then slowly pour the water into the funnel.

### WHAT HAPPENED?

Describe the appearance of the water after filtering and any changes that you can see. Look at the different layers in your funnel. Where did most of the large soil particles get trapped? Where did the fine particles get trapped? What do you observe about your samples?

### THINK ABOUT IT

How do you explain the results of the experiment? Why do you think some materials are more effective filters than others? How would you describe the “services” that soils provide? Can you list a local example of this service?



## STATION 1: DIRTY WATER

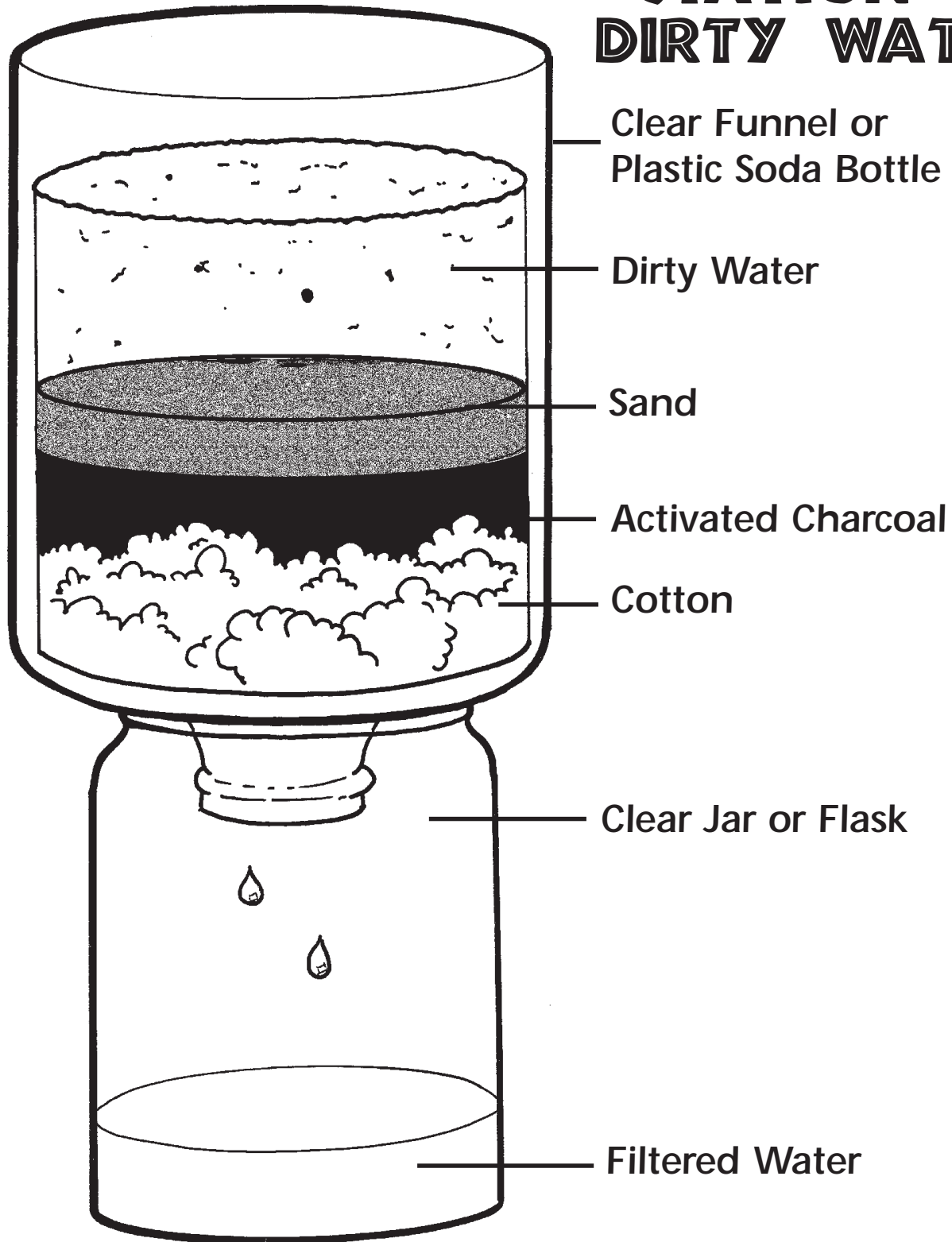



**CLASSIFIED  
INFORMATION**

**Do not share this  
information with  
other teams!**

Plants have fine “tubes” inside them that carry water from their roots to their leaves. When water contains toxic pollutants (such as pesticides or heavy metals) those pollutants may also be carried up and through the plant. Many wetland plants store toxic materials in their tissues. This doesn’t mean that the toxins disappear—usually they are excreted later. But they are released slowly, in small amounts that are less damaging than a large dose of toxins entering a river, lake or pond all at once. When the wetland plants die, the toxins are released back into the water and soil of the wetland where they may be “captured” by other plants or by soil particles. Even though wetland plants can help absorb and alter some toxins, they aren’t able to absorb all toxins. Just as there’s a limit to how much water a sponge can absorb, there’s a limit to what wetland plants can absorb—especially if toxins enter the wetland in large amounts.

Adapted from *Discover Wetlands* with permission of the Washington State Department of Ecology, Publications Office, Publication Number 88-16, P.O. Box 7600, Olympia, WA 98504.

## STATION 2: TREATMENT PLANTS

### MATERIALS

fresh celery stalks with leaves; a jar or beaker; red or blue food coloring; water; paring knife; magnifying glass

### WHAT TO DO

1. Add several drops of food coloring to a water-filled beaker or jar. The food coloring represents pollution from a toxic substance (pesticides, oil or heavy metals, such as mercury, for example).
2. Cut one-half inch from the bottom of a celery stalk and place the stalk in the colored water. Leave overnight. The celery stalk represents plants such as cattails, sedges and grasses that grow in wetlands. The colored water represents the water that flows through the wetland.
3. On the following day, cut the celery stalk into one-inch pieces so that each team member has a piece.
4. Examine the celery closely.

### WHAT HAPPENED?

Describe what you see. Observe the tubules (tubes that transport the water). Where do you see the colored water? Do you notice anything interesting about the celery leaves? (As you cut through the celery, you should see colored lines in the stalk. The colored lines are the xylem that transports water and minerals to all parts of the plant. Because the xylem distributes water throughout the plant, you should see color at the edge of the leaves. If you look carefully with a magnifying glass, you should also see the veins in the leaves tinted with color.)

### THINK ABOUT IT

Communities are increasingly using wetlands as natural water treatment facilities. How do wetland plants help purify water? Why is the water remaining in the beaker still “polluted”? What do you think happens to the pollutants? Why can’t we dump all our waste into wetlands? How does your community treat its wastewater? Where does the water from storm drains in your community go?



## STATION 2: TREATMENT PLANTS

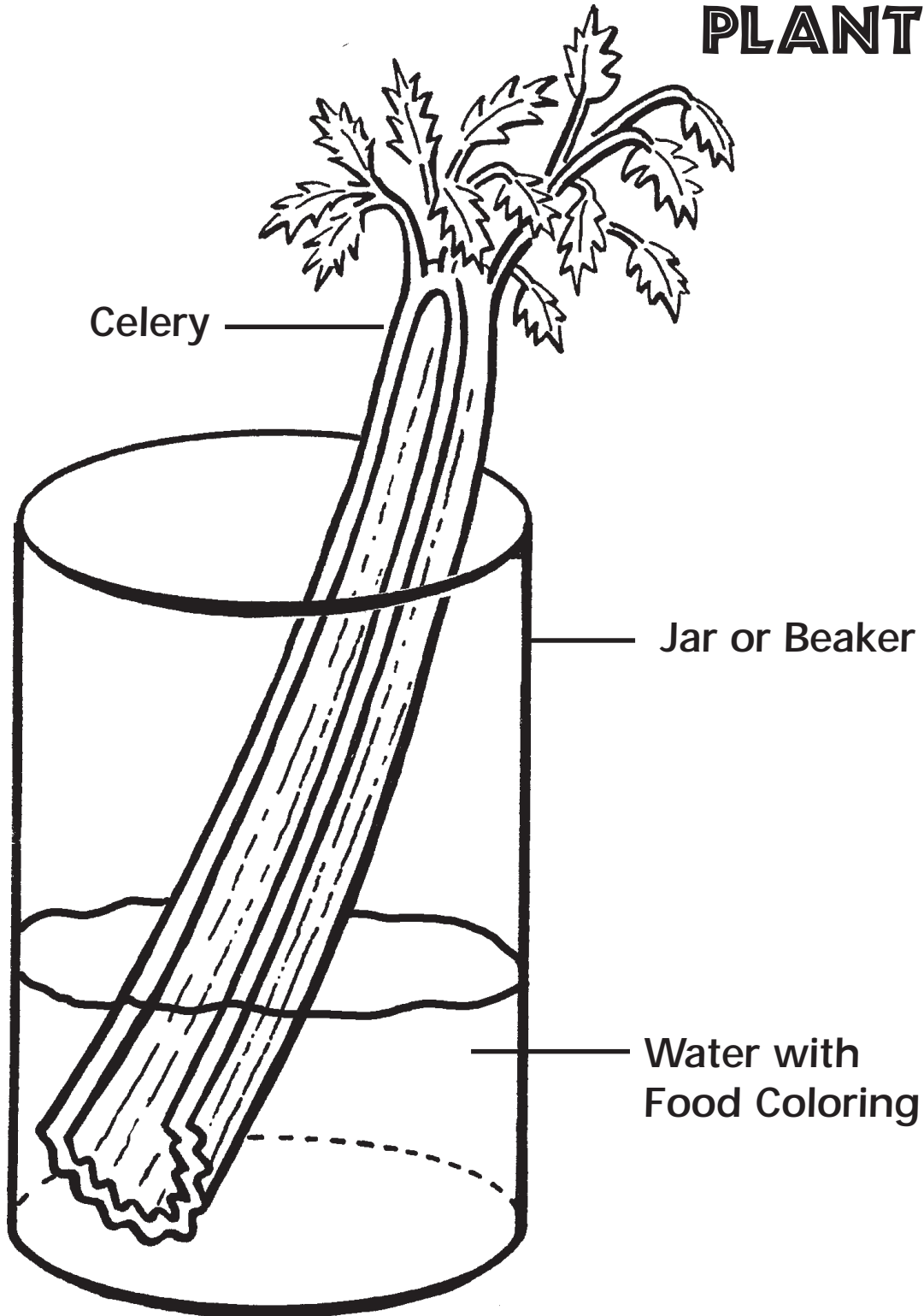



**CLASSIFIED  
INFORMATION**

**Do not share this  
information with  
other teams!**

As water flows through wetlands, the grasses slow the speed of the water by simply being in the way. When the water slows, particles of soil and other solids are deposited in the grass, making the water clearer. Larger particles usually settle out first and the smallest particles usually travel the farthest. Wetlands help protect streams, lakes, bays and other downstream water bodies from a heavy build-up of sediment. They also help protect many aquatic plants and animals. Muddy water covers filter feeders such as clams and mussels, clogs fish gills, smothers fish eggs, “blinds” aquatic animals that hunt for food by sight and blocks sunlight that aquatic plants need to grow.

## MATERIALS

several sponges; a doormat or a piece of artificial turf; two flat sheets of wood or plastic similar in size to the doormat; two shallow aluminum trays; soil; two containers of water; props to tilt the models

# STATION 3: RUNOFF RACE

## WHAT TO DO

1. Set up both boards (or sheets of plastic) on a slant. They need to be at the same angle.
2. Place the doormat (or artificial turf) on one of the boards. Then set the trays at the base of each board. (See diagram.) These boards represent wetlands. The board with the doormat represents a healthy wetland filled with plants. The other board represents an unhealthy wetland where the plants have died or have been removed.
3. Fill both water containers with equal amounts of water and soil, then mix.
4. Get a team member to stand behind the high end of each board. Now have each of them pour a container of the soil/water mixture down the board at the same time and at the same rate. This flow represents water entering the wetland as a stream, flowing through the wetland and emptying into a lake (the tray).

## WHAT HAPPENED?

Which wetland had the faster water flow? In which wetland did more soil settle out? (The model with the doormat or artificial turf should have slowed the water down and trapped more of the larger particles, keeping them from settling out into the tray.)

## THINK ABOUT IT

Based on your observations of this model, how do healthy wetlands help provide cleaner water? How could muddy water be harmful to wildlife? Why do scientists recommend natural planting along the edges of streams, rivers, ponds and lakes?





## STATION 3: RUNOFF RACE

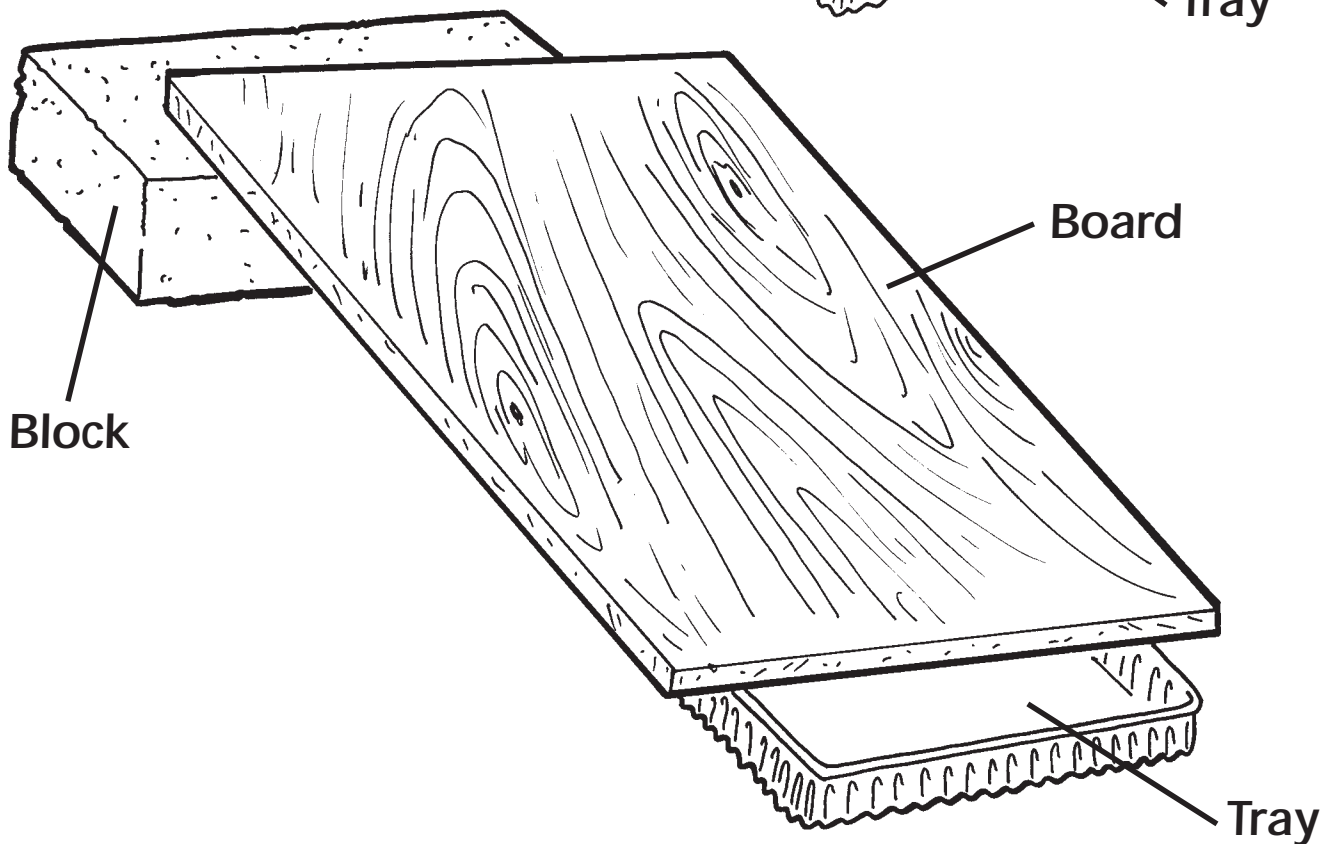
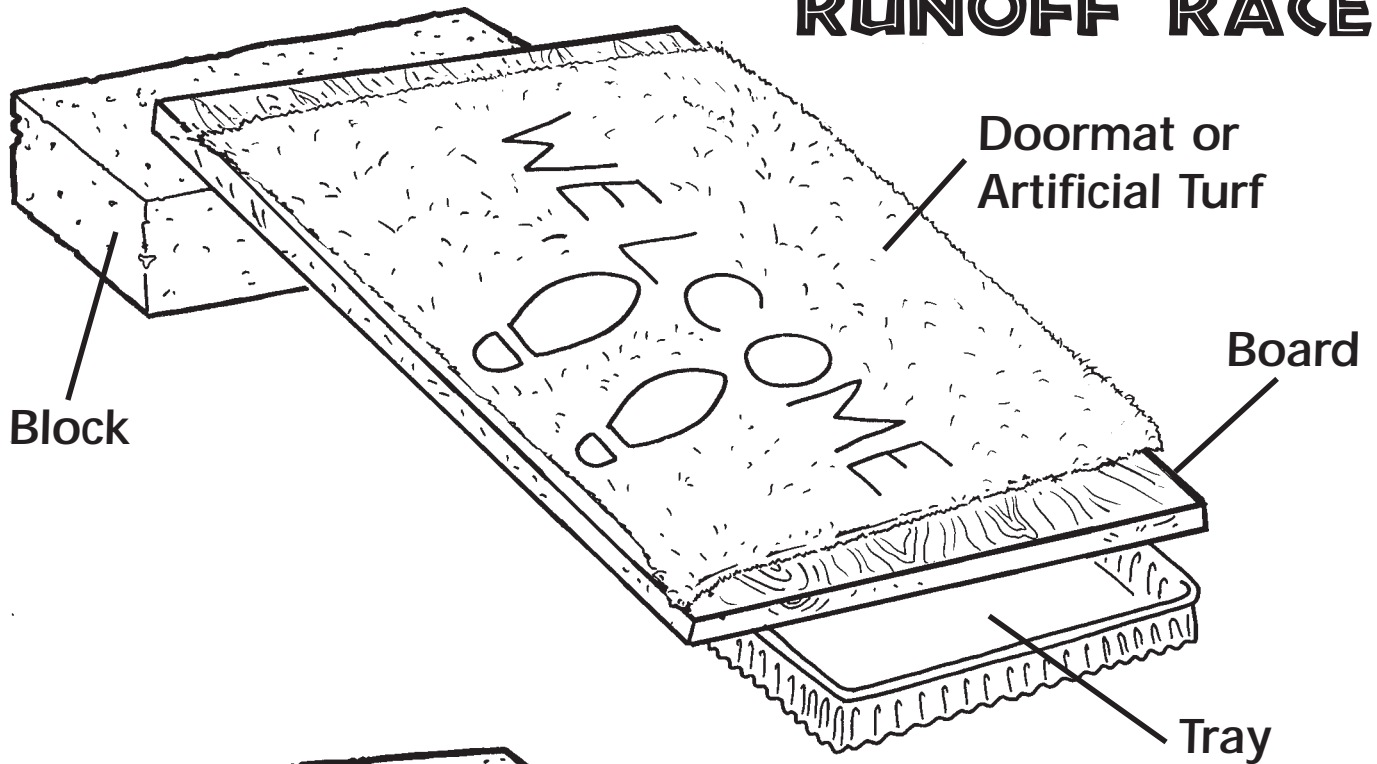



**CLASSIFIED  
INFORMATION**

**Do not share this  
information with  
other teams!**

Water is necessary for life on earth. In the water cycle, water moves from the oceans to the atmosphere, to the land, through lakes, streams and rivers back to the ocean. Living things also take part in the water cycle. Plants absorb water through their roots and release water into the atmosphere through their leaves in a process called transpiration. Transpiration is the evaporation of water through tiny openings in the leaves. When the water evaporates, any impurities that might be in it stay behind in the plant. In this way water entering the atmosphere is purified. Water released into the atmosphere also contributes to the formation of clouds. In ecosystems, plants play an important role in determining the amount of water entering the atmosphere, which has a great effect on the climate in an area.

## MATERIALS

two large, clear-plastic cups; six-inch square piece of waxed paper; geranium plant leaf with stem; cobalt chloride paper (available from science supply catalogs); petroleum jelly; paper clip; tape; water

# STATION 4: NATURAL CLIMATE CONTROL

## WHAT TO DO

1. Place a drop of water on a piece of cobalt chloride paper. Observe the change in color. Cobalt chloride paper is used to detect the presence of water.
2. Fill one of the cups with water and apply petroleum jelly to the rim.
3. Straighten the paper clip and use one end of it to poke a small hole in the center of the square of waxed paper.
4. Insert the geranium leaf stem through the hole in the waxed paper square. Apply petroleum jelly around the stem where it emerges from the waxed paper. Apply enough petroleum jelly to cover any extra space in the hole and make an airtight seal.
5. Position the leaf and waxed paper combination directly over the water-filled cup. Gently press down on the waxed paper around the rim so the waxed paper is held in place by the petroleum jelly. The stem should be in the water.
6. Tape a piece of cobalt chloride paper to the inside bottom of the other cup. Apply petroleum jelly around the rim of the cup.
7. Invert the cup with the cobalt chloride paper over the geranium leaf setup. Gently press the cups together. Do not allow the leaf to touch the cobalt chloride paper.
8. Observe the setup for five minutes. Pay particular attention to the color of the cobalt chloride paper. Leave the setup undisturbed for 24 hours.
9. On the following day make your final observations about the cobalt chloride paper.

## WHAT HAPPENED?

How do you explain the change in color of the cobalt chloride paper? (As the water made its way through the stem and leaf, it entered into the air of the second cup.

Adapted from Activity 4.1, "Plants and the Water Cycle," from Addison-Wesley *Environmental Science: Ecology and Human Impact, 2nd Edition*, by Leonard Bernstein, Alan Winkler and Linda Zierdt-Warshaw, copyright © 1996 by Addison-Wesley Publishing Company. Reprinted with permission.



## STATION 4: NATURAL CLIMATE CONTROL

Because cobalt chloride paper turns pink in the presence of water vapor, the cobalt chloride paper changed color.)

### THINK ABOUT IT

Using the results of the demonstration, what role do you think plants play in the water cycle? How do plants

affect local climates? Describe the differences in climate between two Illinois ecosystems (e.g. forest, prairie, wetland, etc.). Do you think the climate would be different in a community with many trees compared to a community with few trees?

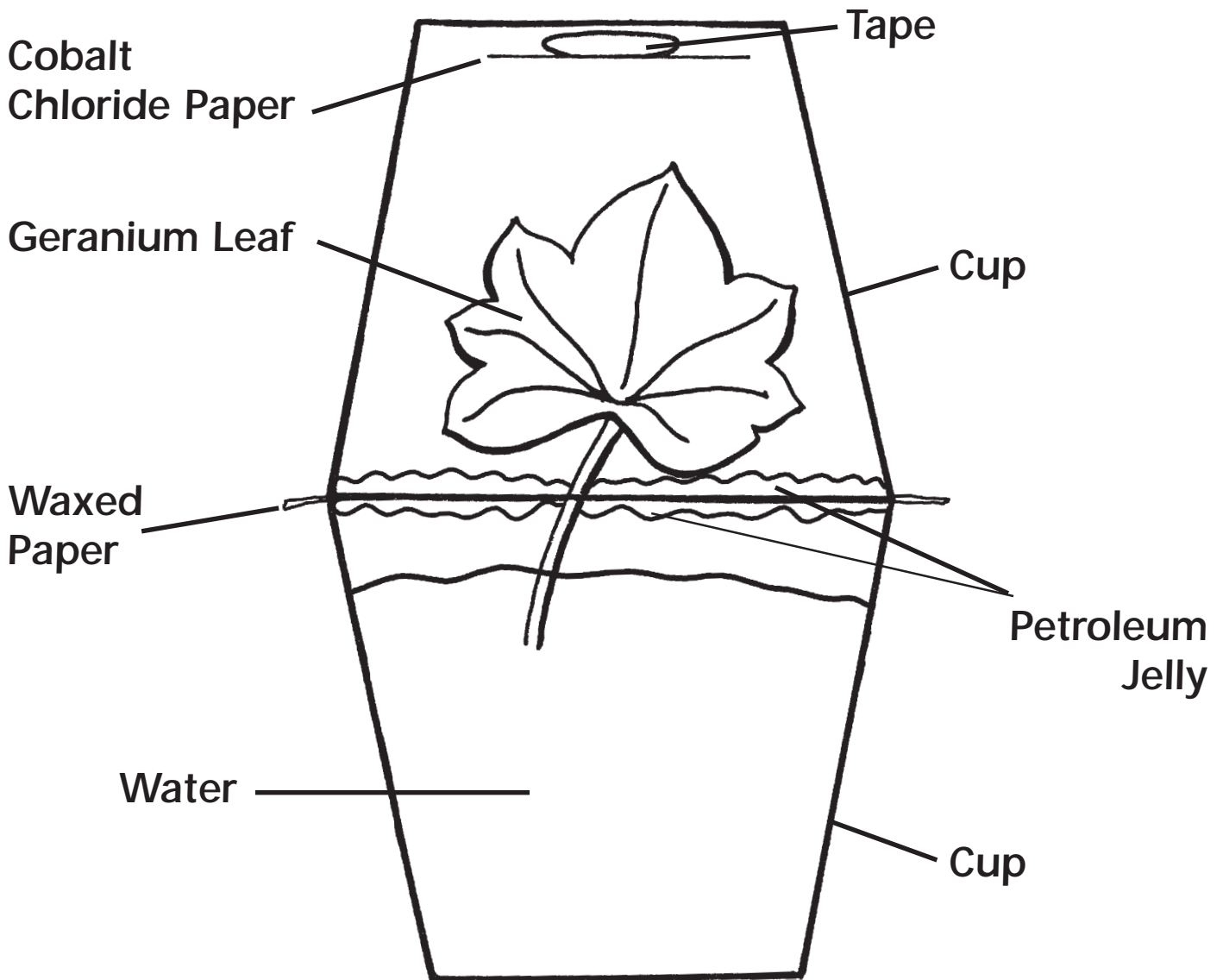



**CLASSIFIED  
INFORMATION**

**Do not share this  
information with  
other teams!**

Green plants, like animals, need food. But unlike animals, plants make their own food through a process called photosynthesis. Photosynthesis uses carbon dioxide ( $\text{CO}_2$ ), water ( $\text{H}_2\text{O}$ ) and energy from the sun to produce food and oxygen. Common indoor plants used in homes and offices may help to fight the rising levels of indoor air pollution. NASA scientists are finding plants to be useful in absorbing potentially harmful gases and cleaning the air inside modern buildings.

### MATERIALS

large bowl; water; measuring cup; tablespoon; baking soda; drinking glass; lamp; water plant such as *Elodea* or *Anacharis* (available from stores that sell live fish)

### WHAT TO DO

1. Using a measuring cup, fill a bowl with fresh water. Write down the number of cups of water used.
2. Mix in one tablespoon of baking soda for every two cups of water. (Baking soda is also known as

## STATION 5: PRODUCING OXYGEN

bicarbonate of soda. It contains carbon and in this experiment it will provide the  $\text{CO}_2$  that a plant needs in order to create its own food—to photosynthesize.)

3. Place a water plant, such as *Elodea*, inside a drinking glass. Add enough water to fill up half the glass.
4. Lower the glass sideways into the bowl of water until the glass fills with water and no air bubbles are left in the glass. Then turn the glass upside down in the bowl without letting in air. The top of the glass should rest on the bottom of the bowl.
5. Set up a light near the bowl and aim the light toward one side of the glass.
6. Leave the light on the plant overnight.
7. Observe the plant and the glass of water the next day.

### WHAT HAPPENED?

What formed the next day? Why? (You should see a bubble the next day. The light stimulates photosynthesis in the plant. As a plant goes through photosynthesis to make food, it releases oxygen. Since oxygen is lighter than water, it rises to the top and is trapped by the glass. After 24 hours, enough oxygen has gathered to form a bubble.)

### THINK ABOUT IT

How do you explain the results you see? Why might a city planning board be interested in planting trees in their community, or the people in an office building be interested in having house plants? Using the results of the demonstration, what role do you think plants play in all ecosystems? What other factors are necessary for the process of photosynthesis?

Reprinted with permission, American Forest Foundation, Copyright 1993, 1994, 1995, 1996. *Project Learning Tree Environmental Education Activity Guide Pre K-8*. The complete activity guide can be obtained by attending a PLT workshop. For more information, call the National PLT office at (202) 463-2462 or visit their Web site at [www.plt.org](http://www.plt.org).



# STATION 5: PRODUCING OXYGEN

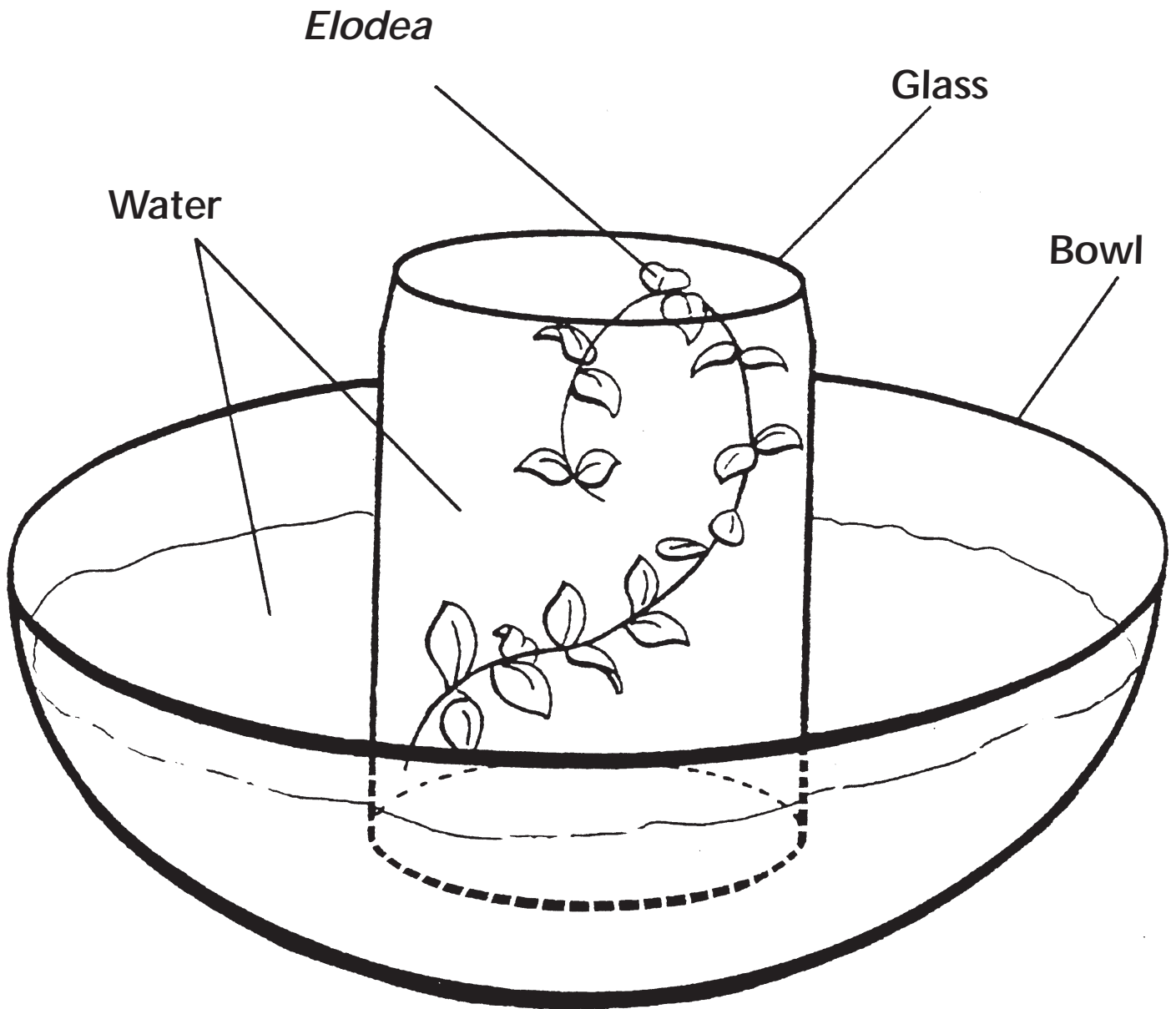



## Student Page Secret Services (continued)



Match the number of the station to the ecosystem service that is described here.

**A** \_\_\_\_\_ Plants have fine “tubes” inside them that carry water from their roots to their leaves. When water contains toxic pollutants (such as pesticides or heavy metals) those pollutants may also be carried up and through the plant. Many wetland plants store toxic materials in their tissues. This doesn’t mean that the toxins disappear—usually they are excreted later. But they are released slowly, in small amounts that are less damaging than a large dose of toxins entering a river, lake or pond all at once. When the wetland plants die, the toxins are released back into the water and soil of the wetland where they may be “captured” by other plants or by soil particles. Even though wetland plants can help absorb and alter some toxins, they aren’t able to absorb all toxins. Just as there’s a limit to how much water a sponge can absorb, there’s a limit to what wetland plants can absorb—especially if toxins enter the wetland in large amounts.

**B** \_\_\_\_\_ As water flows through wetlands, the grasses slow the speed of the water by simply being in the way. When the water slows, particles of soil and other solids are deposited in the grass, making the water clearer. Larger particles usually settle out first, and the smallest particles usually travel the farthest. Wetlands help protect streams, lakes, bays and other downstream water bodies from a heavy build-up of sediment. They also help protect many aquatic plants and animals. Muddy water covers filter feeders such as clams and mussels, clogs fish gills, smothers fish eggs, “blinds” aquatic animals that hunt for food by sight and blocks sunlight that aquatic plants need to grow.

**C** \_\_\_\_\_ Soil is a mixture of mineral particles, air, water, microorganisms and other organic matter (material derived from living things). The materials that make up soil form layers. Hundreds of years may be required to form just a few inches of soil. Soil helps to purify water by filtering out some of

the suspended solids (floating “dirt” particles) as they flow through the different soil layers. The makeup of the soil determines how well it will act as a filter. Soil also helps to remove chemical contaminants such as fertilizers and pesticides. Many minerals in the soil can chemically bond with contaminants, which are then stored in the soil and prevented from flowing into nearby waterways. As a result of chemical reactions, the soil can also help “detoxify” certain chemicals, making them less harmful to living things.

**D** \_\_\_\_\_ Green plants, like animals, need food. But unlike animals, plants make their own food through a process called photosynthesis. Photosynthesis uses carbon dioxide ( $\text{CO}_2$ ), water ( $\text{H}_2\text{O}$ ) and energy from the sun to produce food and oxygen. Common indoor plants used in homes and offices may help to fight the rising levels of indoor air pollution. NASA scientists are finding plants to be useful in absorbing potentially harmful gases and cleaning the air inside modern buildings.

**E** \_\_\_\_\_ Water is necessary for life on earth. Through the water cycle, water moves from the oceans, to the atmosphere, to the land and back to the ocean. Living things also take part in the water cycle. Plants absorb water through their roots and release water into the atmosphere through their leaves in a process called transpiration. Transpiration is the evaporation of water through tiny openings in the leaves. When the water evaporates, any impurities that might be in it stay behind in the plant. In this way water entering the atmosphere is purified. Water released into the atmosphere also contributes to the formation of clouds. In ecosystems, plants play an important role in determining the amount of water entering the atmosphere, which has a great affect on the climate in an area.



## Activity 3-1 Endangered Species Gallery Walk

### AT A GLANCE

Conduct research to create a poster about an endangered species in the state of Illinois and then take a walk through a poster “gallery” to find out more about threatened/ endangered species around the state.

### OBJECTIVES

Identify groups of animals that are threatened and/or endangered and name some species within each group. Research one species, describe why it’s threatened or endangered and compare its problems to those of other endangered species.

### SUBJECTS

English language arts, science, social science

### SKILLS

gathering (collecting, researching), analyzing (comparing and contrasting), interpreting (defining problems, generalizing), applying (creating, designing), presenting (illustrating, writing)

### LINKS TO ILLINOIS BIODIVERSITY BASICS CONCEPTUAL FRAMEWORK

endangered, threatened and extinct

### VOCABULARY

endangered species, Endangered Species Act, habitat, introduced species, range map

### TIME

three or more class periods

### MATERIALS

copy of “Illinois Threatened/Endangered Species” and “Legal Lingo/Poster Parameters” for each student or post one for all to see; poster board; magazines with pictures of threatened/endangered plants and animals; reference materials; *Biodiversity of Illinois* CD-ROM series; (optional: Internet access); (optional: poster-sized paper)

### CORRELATION TO ILLINOIS LEARNING STANDARDS

English language arts 3.A.3, 4.B.2b, 5.A.3a  
science 13.B.3d  
social science 17.B.3b, 17.C.2c

Have your students ever heard of a hellbender? Do they know what a yellow-headed blackbird looks like? Have you smelled the white lady’s slipper? By researching threatened/endangered species, your students will put a face on species biodiversity and gain insight into some of the problems that threaten all living things. As they share their research, they’ll begin to understand broader issues of biodiversity loss—such as the HIPPO dilemma. HIPPO is an acronym that represents the five major threats to biodiversity, which are caused by human activity: **H**abitat loss, **I**ntroduced species, **P**ollution, **P**opulation growth and **O**ver-consumption. This activity provides a way to help students understand the threats to biodiversity and what the word “endangered” means. It also provides students an opportunity to use their creativity to design a poster and share information with their peers.

### BEFORE YOU BEGIN

Make photocopies of the list of Illinois threatened/ endangered species for each student. Copy the “Poster Parameters” (page 100) onto a chalkboard or a poster-sized paper. Have a piece of poster board available for each student. In addition, gather magazines that the students can use to cut out pictures of their endangered species. Past issues of *National Wildlife*, *International Wildlife*, *Natural History*, *Audubon*, *Ranger Rick* and *National Geographic* are all good sources. CD-ROMs, such as the *Biodiversity of Illinois* series, and the Internet will also have information and pictures students can download. If your school has a computer lab with these resources, you may want to set up a time for your group to use the lab for their research.





## Activity 3-1 Endangered Species Gallery Walk (continued)

### WHAT TO DO

#### 1. Discuss the terms “threatened,” “endangered” and “extinct.”

Give each student a copy “Illinois Threatened/Endangered Species.” Explain that every organism on this list is threatened or endangered. Discuss the terms “threatened,” “endangered,” “extirpated” and “extinct.” (See “Legal Lingo,” page 100.)

#### 2. Explain the task and have students choose an organism to research.

Tell students that each of them should pick an organism from the list to research. Have each student select a different species, encouraging them to select one that they are unfamiliar with. Each student will need to research the organism and then create a poster to teach others about it. Point out the “Poster Parameters” you copied earlier and review what the students should be trying to find out about their species—this is the kind of information they should include on their poster. Hand out poster board and give students time to conduct research.

#### 3. Take an endangered species gallery walk.

When the students have finished their posters, use them to create a scavenger hunt. Your scavenger hunt might include statements like the following:

- Name two endangered wetland animals and explain why they’re endangered.
- Find two reptiles that are endangered. Record their names and why they’re endangered.
- List three different kinds of plants that are threatened by loss of habitat.
- Name an endangered animal that lives in woodland areas.
- Name two animals that winter in one part of the world and breed during spring or summer in another part.
- Name three animals that live in prairies and state why they’re endangered.

The questions must be developed from the students’

posters and should be designed to get students to read each other’s posters and draw conclusions about why different organisms are in trouble. You should include questions that cover the full range of organisms your students researched. Next hang the posters where everyone can see them and hand out copies of your scavenger hunt clues to the group. Explain that the students should “tour the gallery,” reading each other’s posters to find the answers to the scavenger hunt sheets.

#### 4. Share scavenger hunt results.

After students have finished their scavenger hunt, review their answers as a group. What seemed to be the biggest problem(s) facing the species in the gallery? What other generalizations can the students make about threatened/endangered species? For what reasons are prairie plants in trouble? Wetland animals? Birds of prey? Students should notice, for example, that pollution has been a big problem for many birds of prey, that many species are in trouble because of introduced species and that animals that live in woodland areas are threatened by habitat loss. What are people doing to help endangered species? Is there anything that students can do? Why do people care about losing species?

### WRAPPING IT UP

#### Assessment

1. Posters should be assessed separately, making sure that each poster meets the parameters of the assignment.
2. Have each student give examples of species that are threatened or endangered and describe why. Have him or her choose a group of species from the Illinois endangered species gallery (e.g., a group of prairie plants) and list major reasons the species are endangered. Identify and match endangered species to each reason. Can the students recognize a common reason or reasons for endangerment of different groups of plants and animals?





## Activity 3-1

# Endangered Species Gallery Walk (continued)

### Portfolio

The student's endangered species poster can be added to the portfolio.

### Extension

Have students create a group database using the information they found about their species. They can also do an Internet search to add to their information—see sample pages below in the "Resources" section. The students can use the database as a reference. It could include the following entry fields: name of species; type of species (mammal, bird, fish, reptile, amphibian, plant, etc.); method of obtaining food (herbivore, carnivore, omnivore, producer); size or height (less than 5 pounds, 6–25 pounds, 26–100 pounds, 101–500 pounds, more than 500 pounds); habitat type (woodland, prairie, wetland, etc.); and the main reason it's threatened/endangered (habitat destruction, introduced species, pollution, over hunting, over-collecting, etc.). After students have entered information on their species, they can use the database to answer questions about the species they researched. The database can be updated and expanded by other classes during the year and in future years.

## Resources

### Magazines

*Audubon*, *Illinois Steward*, *International Wildlife*, *National Wildlife*, *National Geographic*, *Natural History*, *Outdoor Illinois*, *Ranger Rick*, *Chicago Wilderness Magazine*.

### Books (General)

- Baillie, Jonathan and Brian Groombridge, editors. 1996. *IUCN red data lists of threatened and endangered species*. World Conservation Union, Gland, Switzerland. 378 pp.
- Benirschke, Kurt. 1986. *Vanishing animals*. Springer-Verlag, New York. 99 pp.

- Burton, John A. 1988. *The Collins guide to rare mammals of the world*. Greene Press, Lexington, Massachusetts. 400 pp.
- Burton, John A. 1991. *The atlas of endangered species*. Macmillan, New York. 256 pp.
- Day, David. 1981. *The doomsday book of animals*. Viking Press, New York. 288 pp.
- Halliday, Tim and Kraig Adler, editors. 1986. *The encyclopedia of reptiles and amphibians*. Facts on File, New York. 143 pp.
- Herkert, J. R., ed. 1991. *Endangered and threatened species of Illinois: status and distribution. Volume I: plants*. Illinois Endangered Species Protection Board, Illinois Department of Natural Resources, Springfield, Illinois. 158 pp.
- Herkert, J. E., ed. 1992. *Endangered and threatened species of Illinois: status and distribution. Volume II: animals*. Illinois Endangered Species Protection Board, Illinois Department of Natural Resources, Springfield, Illinois. 142 pp.
- Macdonald, David, editor. 1995. *The encyclopedia of mammals*. Facts on File, New York. 928 pp.
- Moseley, Charles, editor. 1990. *The official World Wildlife Fund guide to endangered species of North America, Vol. I–II*. Beacham Publishing, Washington, D.C. 1,180 pp.

### Books (Middle School)

- Maynard, Thane. 1992. *Saving endangered mammals: a field guide to some of the earth's rarest animals*. The Zoological Society of Cincinnati, Inc., Cincinnati, Ohio. 57 pp.
- O'Biso Socha, Laura. 1991. *Endangered species of the world*. Michael Friedman Publishing Group, New York. 127 pp.
- Sherrow, Victoria. 1995. *Endangered mammals of North America*. Twenty-First Century Books, New York. 96 pp.



## Activity 3-1 Endangered Species Gallery Walk (continued)

### Internet Sites and CD-ROMs

There are many Internet sites with great information and pictures of threatened/endangered species, and the *Biodiversity of Illinois* CD-ROMs produced by the Illinois Department of Natural Resources (see page 6 for a description) include information and photographs for many of the species on the threatened/endangered species list for Illinois. Have your students learn how to search the CD-ROMs as well as Internet sites.

Illinois Department of Natural Resources:  
<http://dnr.state.il.us>

IDNR Division of Education:  
<http://dnr.state.il.us/lands/education/classrm/classrm.htm>

IDNR Illinois Natural History Survey:  
<http://www.inhs.uiuc.edu/cbd/main/generalinfo.html>

IDNR Office of Scientific Research and Analysis:  
<http://dnr.state.il.us/offices/scientific.htm>

Illinois Plant Information Network:  
<http://www.fs.fed.us/ne/delaware/ilpin/ilpin.html>

Illinois Taxa and Number of Species:  
<http://www.inhs.uiuc.edu/cbd/ilspecies/ilsplist.html>



## Student Page Endangered Species Act

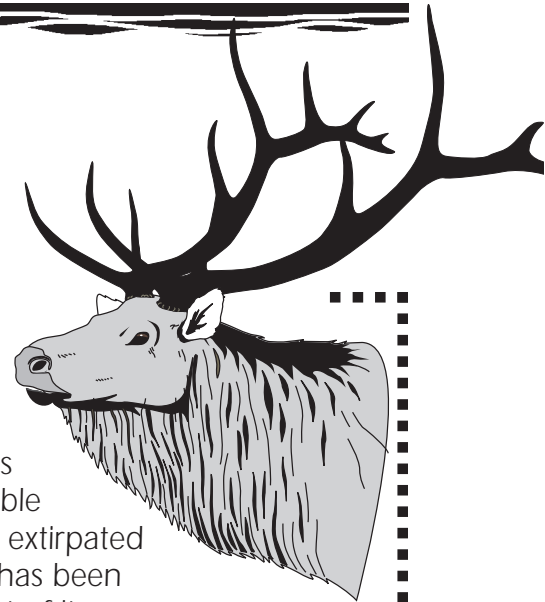

### LEGAL LINGO

In the United States, many species are protected by the Endangered Species Act. Under this act, species may be listed as threatened or endangered. Populations of threatened species are generally low or declining but not in immediate danger of extinction. Endangered species are in immediate danger of becoming extinct. Typically, their populations are critically low and require high levels of protection. A federally endangered species is one in danger of extinction throughout all or a significant portion of its range. A federally threatened species is one which is likely to become an endangered species within the foreseeable future throughout all or a significant portion of its range. A state endangered species is any species which is in danger of extinction as a breeding species in Illinois. A state threatened species is any

breeding species which is likely to become a state endangered species within the foreseeable future in Illinois. An extirpated species is one that has been eliminated from part of its range. For example, the elk has been extirpated from Illinois, although it still lives in other parts of its natural range.

The Illinois Department of Natural Resources (IDNR) maintains a list of all the animals and plants in Illinois that are threatened or endangered. This list is provided with this activity. However, you may want to visit the IDNR Web site at <http://dnr.state.il.us/esp/datelist.htm> for updates to the list.

### Poster Parameters

Your poster should include the following:

- natural history information about your species (what type of habitat it lives in, what it eats or who eats it and other natural history information such as how it gets its food, how long it lives, where it breeds or reproduces and when it is active [night? day? year round?])
- why your species is in trouble
- what people are doing to help your species
- what your species looks like (pictures or drawings)
- where your species lives (a range map)

The poster should not be a report. It should present the required information in easy-to-read chunks arranged in an informative and creative way that will capture people's attention. Pictures should have captions that explain what is shown.

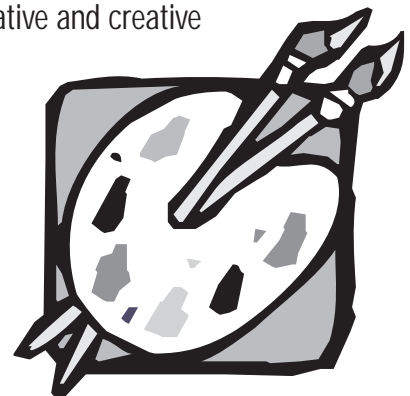



## FISHES

### Endangered

*Acipenser fulvescens* (lake sturgeon)  
*Etheostoma camurum* (bluebreast darter)  
*Etheostoma exile* (Iowa darter)  
*Etheostoma histrio* (Harlequin darter)  
*Hybognathus hayi* (cypress minnow)  
*Ichthyomyzon fossor* (northern brook lamprey)  
*Macrhybopsis gelida* (sturgeon chub)  
*Moxostoma valenciennesi* (greater redhorse)  
*Nocomis micropogon* (river chub)  
*Notropis anogenus* (pugnose shiner)  
*Notropis boops* (bigeye shiner)  
*Notropis heterolepis* (blacknose shiner)  
*Notropis maculatus* (taillight shiner)  
*Notropis texanus* (weed shiner)  
*Noturus stigmosus* (northern madtom)  
*Platygobio gracilis* (flathead chub)  
*Pteronotropis hubbsi* (bluehead shiner)  
*Scaphirhynchus albus* (pallid sturgeon)\*\*

### Threatened

*Catostomus catostomus* (longnose sucker)  
*Coregonus artedi* (cisco or lake herring)  
*Fundulus diaphanus* (banded killifish)  
*Lampetra aepyptera* (least brook lamprey)  
*Lepomis symmetricus* (bantam sunfish)  
*Moxostoma carinatum* (river redhorse)  
*Notropis chalybaeus* (ironcolor shiner)  
*Notropis heterodon* (blackchin shiner)

## AMPHIBIANS

### Endangered

*Ambystoma platineum* (silvery salamander)  
*Cryptobranchus alleganiensis* (hellbender)  
*Desmognathus fuscus* (dusky salamander)

### Threatened

*Ambystoma jeffersonianum*  
(Jefferson salamander)  
*Hemidactylium scutatum*  
(four-toed salamander)  
*Hyla avivoca* (bird-voiced treefrog)  
*Pseudacris streckeri illinoensis*  
(Illinois chorus frog)

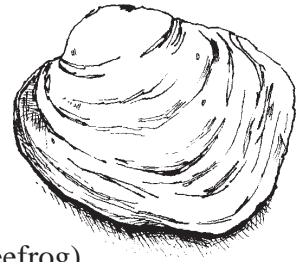

## REPTILES

### Endangered

*Clemmys guttata* (spotted turtle)  
*Kinosternon flavescens* (Illinois mud turtle)  
*Macrochelys temminckii*  
(alligator snapping turtle)  
*Masticophis flagellum* (coachwhip)  
*Nerodia fasciata* (broad-banded water snake)  
*Pseudemys concinna* (river cooter)  
*Sistrurus catenatus catenatus*  
(eastern massasauga)  
*Thamnophis sauritus* (eastern ribbon snake)

### Threatened

*Clonophis kirtlandii* (Kirtland's snake)  
*Crotalus horridus* (timber rattlesnake)  
*Elaphe guttata emoryi* (great plains rat snake)  
*Emydoidea blandingii* (Blanding's turtle)  
*Heterodon nasicus* (western hognose snake)  
*Nerodia cyclopion*  
(Mississippi green water snake)  
*Tantilla gracilis* (flathead snake)

## BIRDS

### Endangered

*Ammodramus henslowii* (Henslow's sparrow)  
*Asio flammeus* (short-eared owl)  
*Bartramia longicauda* (upland sandpiper)



## Student Page

# Illinois Threatened/Endangered Species – 2001 (continued)

*Botaurus lentiginosus* (American bittern)  
*Buteo swainsoni* (Swainson's hawk)  
*Charadrius melodus* (piping plover)\*\*  
*Chlidonias niger* (black tern)  
*Circus cyaneus* (northern harrier)  
*Egretta caerulea* (little blue heron)  
*Egretta thula* (snowy egret)  
*Falco peregrinus* (peregrine falcon)  
*Ictinia mississippiensis* (Mississippi kite)  
*Laterallus jamaicensis* (black rail)  
*Limnothlypis swainsonii*  
(Swainson's warbler)  
*Nyctanassa violacea*  
(yellow-crowned night-heron)  
*Nycticorax nycticorax*  
(black-crowned night-heron)  
*Pandion haliaetus* (osprey)  
*Phalaropus tricolor* (Wilson's phalarope)  
*Rallus elegans* (king rail)  
*Sterna antillarum* (least tern)\*\*  
*Sterna forsteri* (Forster's tern)  
*Sterna hirundo* (common tern)  
*Thryomanes bewickii* (Bewick's wren)  
*Tympanuchus cupido*  
(greater prairie-chicken)  
*Tyto alba* (common barn-owl)  
*Xanthocephalus xanthocephalus*  
(yellow-headed blackbird)



### Threatened

*Buteo lineatus* (red-shouldered hawk)  
*Certhia americana* (brown creeper)  
*Gallinula chloropus* (common moorhen)  
*Grus canadensis* (sandhill crane)  
*Haliaeetus leucocephalus* (bald eagle)\*  
*Ixobrychus exilis* (least bittern)  
*Lanius ludovicianus* (loggerhead shrike)  
*Podilymbus podiceps* (pied-billed grebe)

## MAMMALS

### Endangered

*Corynorhinus rafinesquii*  
(eastern big-eared bat)  
*Myotis austroriparius* (southeastern bat)  
*Myotis grisescens* (gray bat)\*\*  
*Myotis sodalis* (Indiana bat)\*\*  
*Neotoma floridana* (eastern woodrat)



### Threatened

*Lontra canadensis* (river otter)  
*Ochrotomys nuttalli* (golden mouse)  
*Oryzomys palustris* (marsh rice rat)

## INVERTEBRATES

### Endangered

#### Snails

*Discus macclintocki* (pleistocene disc)\*\*

#### Mussels

*Cumberlandia monodonta*  
(spectacle case mussel)  
*Cyprogenia stegaria* (fanshell mussel)\*\*  
*Epioblasma triquetra* (snuffbox mussel)  
*Lampsilis abrupta* (pink mucket)\*\*  
*Lampsilis fasciola* (wavy-rayed lampmussel)  
*Lampsilis higginsii* (Higgins eye)\*\*  
*Obovaria subrotunda* (round hickorynut mussel)  
*Plethobasus cooperianus*  
(orange-foot pimpleback)\*\*  
*Plethobasus cyphus* (sheepnose mussel)  
*Pleurobema clava* (clubshell mussel)\*\*  
*Pleurobema cordatum* (Ohio pigtoe)  
*Pleurobema rubrum* (pyramid pigtoe)  
*Potamilus capax*  
(fat pocketbook pearly mussel)\*\*



## Student Page

# Illinois Threatened/Endangered Species – 2001 (continued)

*Ptychobranhus fasciolaris* (kidneyshell mussel)

*Quadrula cylindrica* (rabbitsfoot mussel)

*Simpsonaias ambigua* (salamander mussel)

*Toxolasma lividus* (purple lilliput mussel)

*Villosa fabalis* (rayed bean mussel)

*Villosa iris* (rainbow mussel)

*Villosa lienosa* (little spectacle case mussel)

### Crustaceans

*Caecidotea lesliei* (isopod)

*Crangonyx anomalus* (amphipod)

*Crangonyx antennatus* (amphipod)

*Crangonyx packardi* (amphipod)

*Gammarus acherondytes*

(Illinois cave amphipod)\*\*

*Orconectes indianensis* (Indiana crayfish)

*Orconectes kentuckiensis* (Kentucky crayfish)

*Orconectes lancifer* (oxbow crayfish)

*Orconectes placidus* (crayfish)

*Stygobromus iowae* (Iowa amphipod)

### Dragonflies

*Somatochlora hineana*

(Hine's emerald dragonfly)\*\*

### Leafhoppers

*Paraphlepsius lupalus* (leafhopper)

### Butterflies and Moths

*Atrytone arogos* (arogos skipper)

*Calephelis muticum* (swamp metalmark)

*Lycaeides melissa samuelis*

(Karner blue butterfly)\*\*

*Papaipema eryngii*

(rattlesnake-master borer moth)

## Threatened

### Mussels

*Alasmidonta viridis* (slippershell mussel)

*Cyclonaias tuberculata* (purple wartyback)

*Ellipsaria lineolata* (butterfly)

*Elliptio crassidens* (elephant-ear mussel)

*Elliptio dilatata* (spike)

*Fusconaia ebena* (ebonyshell)

*Ligumia recta* (black sandshell)

### Crustaceans

*Gammarus bousfieldi* (Bousfield's amphipod)

### Dragonflies

*Nannothemis bella* (elfin skimmer)

### Leafhoppers

*Aflexia rubranura*

(redveined prairie leafhopper)

### Butterflies and Moths

*Hesperia metea* (cobweb skipper)

*Hesperia ottoe* (ottoe skipper)

*Speyeria idalia* (regal fritillary)

## LICHENS

### Endangered

*Phaeophyscia leana* (Lea's bog lichen)

## PLANTS

### Endangered

*Adoxa moschatellina* (moschatel)

*Alnus incana ssp. rugosa* (speckled alder)

*Amelanchier interior* (shadbush)

*Amelanchier sanguinea* (shadbush)

*Ammophila breviligulata* (beach grass)

*Amorpha nitens* (smooth false indigo)

*Arctostaphylos uva-ursi* (bearberry)

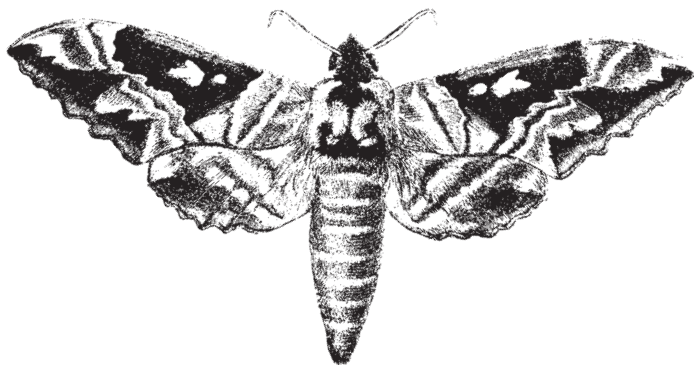



## Student Page

### Illinois Threatened/Endangered Species – 2001 (continued)

*Artemisia dracunculus* (false tarragon)  
*Asclepias lanuginosa* (woolly milkweed)  
*Asclepias meadii* (Mead's milkweed)\*  
*Asclepias ovalifolia* (oval milkweed)  
*Asclepias stenophylla*  
(narrow-leaved green milkweed)  
*Asplenium bradleyi* (Bradley's spleenwort)  
*Asplenium resiliens* (black spleenwort)  
*Astragalus crassicaarpus* var. *trichocalyx*  
(large ground plum)  
*Astragalus tennesseensis*  
(Tennessee milk-vetch)  
*Bartonia paniculata* (screwstem)  
*Beckmannia syzigachne* (American slough grass)  
*Berberis canadensis* (Allegheny barberry)  
*Berchemia scandens* (supple-jack)  
*Betula alleghaniensis* (yellow birch)  
*Betula populifolia* (gray birch)  
*Bidens beckii* (water marigold)  
*Botrychium matricariifolium*  
(daisyleaf grape fern)  
*Botrychium multifidum* (northern grape fern)  
*Botrychium simplex* (grape fern)  
*Bouteloua gracilis* (blue grama)  
*Bumelia lanuginosa* (woolly buckthorn)  
*Calamagrostis insperata* (bluejoint grass)  
*Calla palustris* (water arum)  
*Calopogon tuberosus* (grass pink orchid)  
*Camassia angusta* (wild hyacinth)  
*Cardamine pratensis* var. *palustris*  
(cuckoo flower)  
*Carex alata* (winged sedge)  
*Carex arkansana* (Arkansas sedge)  
*Carex aurea* (golden sedge)  
*Carex brunnescens* (brownish sedge)  
*Carex canescens* var. *disjuncta* (silvery sedge)  
*Carex chordorrhiza* (cordroot sedge)  
*Carex crawfordii* (crawford sedge)

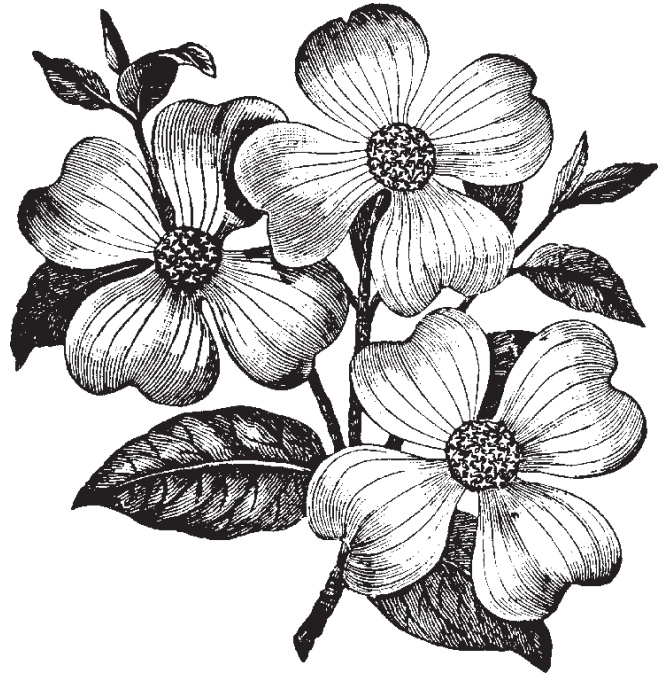

*Carex cryptolepis* (sedge)  
*Carex decomposita* (cypress-knee sedge)  
*Carex disperma* (shortleaf sedge)  
*Carex echinata* (little prickly sedge)  
*Carex garberi* (elk sedge)  
*Carex gigantea* (large sedge)  
*Carex lucorum* (sedge)  
*Carex nigromarginata* (black-edged sedge)  
*Carex oligosperma* (few-seeded sedge)  
*Carex physorhyncha* (Bellow's-beak sedge)  
*Carex reniformis* (reniform sedge)  
*Carex striatula* (lined sedge)  
*Carex trisperma* (three-seeded sedge)  
*Carex tuckermanii* (Tuckerman's sedge)  
*Carya pallida* (pale hickory)  
*Castilleja sessiliflora*  
(downy yellow painted cup)  
*Ceanothus herbaceus* (redroot)  
*Chamaesyce polygonifolia* (seaside spurge)  
*Chimaphila maculata* (spotted wintergreen)  
*Chimaphila umbellata* (pipsissewa)  
*Cimicifuga americana* (American bugbane)



## Student Page

### Illinois Threatened/Endangered Species – 2001 (continued)

- Cimicifuga racemosa* (black cohosh)  
*Circaea alpina* (small enchanter's nightshade)  
*Cladrastis lutea* (yellowwood)  
*Clematis crispa* (blue jasmine)  
*Clematis occidentalis* (mountain clematis)  
*Clematis viorna* (leatherflower)  
*Collinsia violacea* (violet collinsia)  
*Comptonia peregrina* (sweet-fern)  
*Conioselinum chinense* (hemlock parsley)  
*Cornus canadensis* (bunchberry)  
*Corydalis aurea* (golden corydalis)  
*Corydalis halei* (Hale's corydalis)  
*Corydalis sempervirens* (pink corydalis)  
*Corylus rostrata* (beaked hazelnut)  
*Cynosciadium digitatum* (finger dog-shade)  
*Cyperus lancastricensis* (galingale)  
*Cypripedium acaule* (lady's-slipper orchid)  
*Cypripedium parviflorum*  
(small yellow lady's-slipper orchid)  
*Cypripedium reginae*  
(showy lady's-slipper orchid)  
*Cystopteris x laurentiana*  
(laurentian fragile fern)  
*Dalea foliosa* (leafy prairie clover)\*\*  
*Dennstaedtia punctilobula* (hay-scented fern)  
*Draba cuneifolia* (whitlow grass)  
*Drosera rotundifolia* (round-leaved sundew)  
*Dryopteris celsa* (log fern)  
*Echinodorus tenellus* (small burhead)  
*Eleocharis olivacea* (capitate spike rush)  
*Eleocharis pauciflora* (few-flowered spike rush)  
*Equisetum scirpoides* (dwarf scouring rush)  
*Equisetum sylvaticum* (horsetail)  
*Eriophorum virginicum* (rusty cotton grass)  
*Eryngium prostratum* (eryngo)  
*Euonymus americanus* (strawberry bush)  
*Euphorbia spathulata* (spurge)  
*Filipendula rubra* (queen-of-the-prairie)  
*Fimbristylis vahlii* (Vahl's fimbristylis)  
*Galactia mohlenbrockii* (Boykin's dioclea)  
*Galium lanceolatum* (wild licorice)  
*Galium virgatum* (dwarf bedstraw)  
*Gaultheria procumbens* (wintergreen)  
*Geranium bicknellii* (northern cranesbill)  
*Glyceria arkansana* (manna grass)  
*Gymnocarpium dryopteris* (oak fern)  
*Gymnocarpium robertianum* (scented oak fern)  
*Hackelia americana* (stickseed)  
*Halesia carolina* (silverbell tree)  
*Helianthus giganteus* (tall sunflower)  
*Heliotropium tenellum* (slender heliotrope)  
*Heteranthera reniformis* (mud plantain)  
*Hexalectris spicata* (crested coral-root orchid)  
*Hudsonia tomentosa* (false heather)  
*Hydrocotyle ranunculoides* (water-pennywort)  
*Hydrolea uniflora* (one-flowered hydrolea)  
*Hymenoxys herbacea* (lakeside daisy)\*  
*Hypericum adpressum* (shore St. John's wort)  
*Hypericum kalmianum* (Kalm St. John's-wort)  
*Iliamna remota* (Kankakee mallow)  
*Iresine rhizomatosa* (bloodleaf)  
*Isoetes butleri* (quillwort)  
*Isotria medeoloides* (small whorled pogonia)  
*Isotria verticillata* (whorled pogonia)\*  
*Juncus alpinus* (Richardson's rush)  
*Juncus vaseyi* (Vasey's rush)  
*Juniperus horizontalis* (trailing juniper)  
*Justicia ovata* (water willow)  
*Lathyrus japonicus var. glaber* (beach pea)  
*Lespedeza leptostachya* (prairie bush clover)\*  
*Lesquerella ludoviciana* (silvery bladder pod)  
*Lonicera dioica var. glaucescens*  
(red honeysuckle)  
*Lonicera flava* (yellow honeysuckle)  
*Luzula acuminata* (wood rush)  
*Lycopodium clavatum* (common clubmoss)





## Student Page

### Illinois Threatened/Endangered Species – 2001 (continued)

*Lycopodium dendroideum* (ground pine)  
*Lycopodium inundatum* (bog clubmoss)  
*Lysimachia fraseri* (loosestrife)  
*Lysimachia radicans* (creeping loosestrife)  
*Malus angustifolia* (narrow-leaved crabapple)  
*Matelea decipiens* (climbing milkweed)  
*Medeola virginiana* (Indian cucumber root)  
*Melanthera nivea* (white melanthera)  
*Melica mutica* (two-flowered melic grass)  
*Milium effusum* (millet grass)  
*Mimulus glabratus* (yellow monkeyflower)  
*Mirabilis hirsuta* (hairy umbrella-wort)  
*Nothocalais cuspidata* (prairie dandelion)  
*Opuntia fragilis* (fragile prickly pear)  
*Orobanche fasciculata* (clustered broomrape)  
*Oxalis illinoensis* (Illinois wood sorrel)  
*Panicum boreale* (northern panic grass)  
*Panicum columbianum* (panic grass)  
*Panicum jorii* (panic grass)  
*Panicum ravenelii* (Ravenel's panic grass)  
*Panicum yadkinense* (panic grass)  
*Paspalum dissectum* (bead grass)  
*Penstemon brevisepalus*  
(short-sepaled beardstongue)  
*Penstemon grandiflorus*  
(large-flowered beardtongue)  
*Phacelia gilioides* (phacelia)  
*Phlox pilosa ssp. sangamonensis*  
(Sangamon phlox)  
*Pinus banksiana* (Jack pine)  
*Pinus echinata* (shortleaf pine)  
*Pinus resinosa* (red pine)  
*Plantago cordata* (heart-leaved plantain)  
*Platanthera ciliaris* (yellow fringed orchid)  
*Platanthera clavellata* (wood orchid)  
*Platanthera flava var. flava* (tuberled orchid)  
*Platanthera flava var. herbiola*  
(tuberled orchid)



*Platanthera leucophaea*  
(white fringed orchid)\*  
*Platanthera psycodes* (purple fringed orchid)  
*Poa alsodes* (woodland bluegrass)  
*Poa languida* (woodland bluegrass)  
*Poa wolfii* (meadow bluegrass)  
*Pogonia ophioglossoides* (snake-mouth)  
*Polanisia jamesii* (James clammyweed)  
*Polygala incarnata* (pink milkwort)  
*Polygonatum pubescens*  
(small Solomon's seal)  
*Polygonum arifolium*  
(halbred-leaved tearthumb)  
*Polygonum careyi* (Carey's smartweed)  
*Populus balsamifera* (balsam poplar)  
*Potamogeton praelongus* (pondweed)  
*Potamogeton pulcher* (pondweed)  
*Potamogeton robbinsii* (pondweed)  
*Potamogeton strictifolius* (pondweed)  
*Potentilla millegrana* (cinquefoil)  
*Primula mistassinica* (bird's-eye primrose)  
*Ptilimnium nuttallii* (mock bishop's weed)  
*Puccinellia pallida* (pale manna-grass)  
*Pycnanthemum albescens*  
(white mountain mint)  
*Pycnanthemum torrei* (mountain mint)  
*Quercus nuttallii* (Nuttall's oak)  
*Ranunculus cymbalaria* (seaside crowfoot)  
*Rhamnus alnifolia* (alder buckthorn)  
*Rhynchospora glomerata* (clustered beaked rush)  
*Ribes hirtellum* (northern gooseberry)  
*Rosa acicularis* (rose)  
*Rubus odoratus* (purple flowering raspberry)  
*Rubus setosus* (bristly blackberry)  
*Rudbeckia missouriensis*  
(Missouri orange coneflower)  
*Sabatia campestris* (prairie rose gentian)



## Student Page

### Illinois Threatened/Endangered Species – 2001 (continued)

*Sagittaria longirostra* (arrowleaf)  
*Salix serissima* (autumn willow)  
*Salix syrticola* (sand-dune willow)  
*Sambucus pubens* (red-berried elder)  
*Sanguisorba canadensis* (American burnet)  
*Sarracenia purpurea* (pitcher plant)  
*Saxifraga virginiana* (early saxifrage)  
*Schizachne purpurascens* (false melic grass)  
*Scirpus cespitosus* (tufted bulrush)  
*Scirpus hattorianus* (bulrush)  
*Scirpus paludosus* (alkali bulrush)  
*Scirpus purshianus* (weak bulrush)  
*Scirpus smithii* (Smith's bulrush)  
*Scirpus verecundus* (bashful bulrush)  
*Shepherdia canadensis* (buffalo berry)  
*Silene ovata* (ovate catchfly)  
*Silene regia* (royal catchfly)  
*Silphium trifoliatum* (rosinweed)  
*Sisyrinchium atlanticum* (blue-eyed grass)  
*Sisyrinchium montanum* (blue-eyed grass)  
*Sorbus americana* (American mountain-ash)  
*Sparganium americanum* (bur-reed)  
*Sparganium chlorocarpum*  
(greenfruited bur-reed)  
*Spiranthes lucida*  
(yellow-lipped ladies' tresses)  
*Spiranthes romanzoffiana*  
(hooded ladies' tresses)  
*Spiranthes vernalis* (ladies' tresses)  
*Stellaria pubera* (great chickweed)  
*Stenanthium gramineum* (grass-leaved lily)  
*Stylisma pickeringii* (Patterson bindweed)  
*Styrax grandifolia* (bigleaf snowbell bush)  
*Symphoricarpos albus* var. *albus* (snowberry)  
*Synandra hispidula* (hairy synandra)  
*Talinum calycinum* (large flower-of-an-hour)  
*Thalia dealbata* (powdery thalia)  
*Thelypteris noveboracensis* (New York fern)

*Thelypteris phegopteris* (long beech fern)  
*Tilia heterophylla* (white basswood)  
*Triadenum virginicum* (marsh St. John's wort)  
*Trichomanes boschianum* (filmy fern)  
*Trifolium reflexum* (buffalo clover)  
*Trillium cernuum* (nodding trillium)  
*Trillium erectum* (purple trillium)  
*Trillium viride* (green trillium)  
*Ulmus thomasi* (rock elm)  
*Utricularia cornuta* (horned bladderwort)  
*Utricularia intermedia* (flatleaf bladderwort)  
*Utricularia minor* (small bladderwort)  
*Vaccinium corymbosum* (highbush blueberry)  
*Vaccinium macrocarpon* (large cranberry)  
*Vaccinium oxycoccos* (small cranberry)  
*Valeriana uliginosa* (marsh valerian)  
*Valerianella chenopodiifolia* (corn salad)  
*Valerianella umbilicata* (corn salad)  
*Veronica americana* (American brookline)  
*Viola canadensis* (Canada violet)  
*Viola incognita* (hairy white violet)  
*Viola primulifolia* (primrose-leaf violet)  
*Viola viarum* (plains violet)  
*Waldsteinia fragarioides* (barren strawberry)  
*Woodsia ilvensis* (rusty woodsia)  
*Zigadenus glaucus* (white camass)

### Threatened

*Agalinis skinneriana* (pale false foxglove)  
*Arenaria patula* (slender sandwort)  
*Aristolochia serpentaria* var. *hastata*  
(narrow-leaved snakeroot)  
*Aster furcatus* (forked aster)  
*Besseyia bullii* (kitten tails)  
*Boltonia decurrens* (decurrent false aster)\*  
*Botrychium biternatum* (southern grape fern)  
*Cakile edentula* (sea rocket)  
*Carex communis* (fibrous-rooted sedge)



## Student Page

### Illinois Threatened/Endangered Species – 2001 (continued)

*Carex intumescens* (swollen sedge)  
*Carex oxylepis* (sharp-scaled sedge)  
*Carex prasina* (drooping sedge)  
*Carex viridula* (little green sedge)  
*Carex willdenowii* (Willdenow's sedge)  
*Carex woodii* (pretty sedge)  
*Chamaedaphne calyculata* (leatherleaf)  
*Cimicifuga rubifolia* (black cohosh)  
*Cirsium hillii* (Hill's thistle)  
*Cirsium pitcheri* (Pitcher's [dune] thistle)\*  
*Corallorhiza maculata*  
(spotted coral-root orchid)  
*Cyperus grayioides* (Gray's umbrella sedge)  
*Cypripedium candidum*  
(white lady's-slipper orchid)  
*Drosera intermedia* (narrow-leaved sundew)  
*Eleocharis rostellata* (beaked spike rush)  
*Epilobium strictum* (downy willow herb)  
*Equisetum pratense* (meadow horsetail)  
*Erythronium mesochoreum*  
(white dog-tooth violet)  
*Eupatorium incarnatum* (thoroughwort)  
*Galium labradoricum* (bog bedstraw)  
*Helianthus angustifolius*  
(narrow-leaved sunflower)  
*Juniperus communis* (common juniper)  
*Lactuca hirsuta* (wild lettuce)  
*Larix laricina* (tamarack)  
*Lathyrus ochroleucus* (pale vetchling)  
*Lechea intermedia* (pinweed)  
*Liatris scariosa* var. *nieuwlandii* (blazing-star)  
*Matelea obliqua* (climbing milkweed)  
*Melanthium virginicum* (bunch-flower)  
*Melothria pendula* (squirting cucumber)  
*Oenothera perennis* (small sundrops)  
*Orobanche ludoviciana* (broomrape)  
*Planera aquatica* (water elm)

*Potamogeton gramineus* (pondweed)  
*Quercus montana* (rock chestnut oak)  
*Quercus phellos* (willow oak)  
*Ranunculus rhomboideus* (prairie buttercup)  
*Rhynchospora alba* (beaked rush)  
*Rubus pubescens* (dwarf raspberry)  
*Salvia azurea* ssp. *pitcheri* (blue sage)  
*Scirpus hallii* (Hall's bulrush)  
*Scirpus polyphyllus* (leafy bulrush)  
*Solidago sciaphila* (cliff goldenrod)  
*Styrax americana* (storax)  
*Sullivantia renifolia* (sullivantia)  
*Thuja occidentalis* (arbor vitae)  
*Tofieldia glutinosa* (false asphodel)  
*Tomanthera auriculata* (earleaf foxglove)  
*Tradescantia bracteata* (prairie spiderwort)  
*Trientalis borealis* (star-flower)  
*Triglochin maritimum* (arrow-grass)  
*Triglochin palustris* (arrow-grass)  
*Urtica chamaedryoides* (nettle)  
*Veratrum woodii* (false hellebore)  
*Veronica scutellata* (marsh-speedwell)  
*Viburnum molle* (arrowwood)  
*Viola conspersa* (dog violet)

\*\* = federally endangered

\* = federally threatened





## Activity 3-2

# The Case of the Greater Prairie-Chicken

### AT A GLANCE

Work in small groups to discover how the greater prairie-chicken's decline is tied to the major causes of biodiversity loss in Illinois and discuss what people are doing to help protect the greater prairie-chicken.

### OBJECTIVES

Describe how habitat loss, introduced species, pollution, population growth and over-consumption are threatening the greater prairie-chicken and biodiversity in general. Discuss ways people are trying to protect the greater prairie-chicken.

### SUBJECTS

English language arts, science, social science

### SKILLS

gathering (reading comprehension), analyzing (comparing and contrasting, discussing), applying (proposing solutions)

### LINKS TO ILLINOIS BIODIVERSITY BASICS

#### CONCEPTUAL FRAMEWORK

endangered, threatened and extinct; the five major causes of biodiversity decline

#### VOCABULARY

endangered species, habitat loss, introduced species, over-consumption

#### TIME

two class periods

#### MATERIALS

one copy of the "Prairie-Chicken Problem" and one set of "Prairie-Chicken Cards" for each group; one copy of "Prairie-Chicken Solutions" for each student; five index cards or pieces of paper per student (for Assessment #1)

#### CORRELATION TO ILLINOIS LEARNING STANDARDS

English language arts 3.A.3, 3.B.3b, 4.A.2b, 4.B.3b, 5.A.2a, 5.A.2b, 5.A.3a, 5.A.3b, 5.C.2a, 5.C.3a  
science 13.B.2e, 13.B.2f, 13.B.3d, 13.B.3e  
social science 16.E.3c, 17.B.2a, 17.B.3b, 17.C.2c

There are less than 100 greater prairie-chickens left in the wild in Illinois, making them one of the most endangered birds in the state. Habitat loss has forced this small population into isolated groups in two counties (Jasper and Marion). In this activity, your students will learn about the threats to greater prairie-chicken survival. They will discover that prairie-chickens are beset by the same problems that threaten biodiversity around the world—something we call the HIPPO dilemma. HIPPO is an acronym for the five major problems threatening earth's biodiversity: **H**abitat loss, **I**ntroduced species, **P**ollution, **P**opulation growth and **O**ver-consumption. Students will also learn some of the ways people are trying to protect the greater prairie-chicken and to slow other kinds of biodiversity loss in Illinois.

## BEFORE YOU BEGIN

For each group of four to five students, copy one "Prairie-Chicken Problem" summary and make one set of "Prairie-Chicken Cards." For each student, make one copy of "Prairie-Chicken Solutions."

## WHAT TO DO

### 1. Divide the class into groups and describe the assignment.

Divide the class into groups of four or five students and explain that they're going to be learning about one of the endangered animals in Illinois—the greater prairie-chicken. Give each group a copy of the "Prairie-Chicken Problem" summary and have one student in each group read the summary to the rest of the group. When the students have finished, give each group a set of "Prairie-Chicken Cards." Tell the students to read each card out loud in their group. Next have them try to organize the cards into four or five major categories of threats to the prairie-chicken. Tell the students that it's OK if each group organizes the cards differently and if some categories have only one or two cards. Explain that some cards may seem to fit into more than one category. In that case, students should pick the category that seems most appropriate to them. Then have each group make a list of the categories of threats that it developed.



## Activity 3-2

# The Case of the Greater Prairie-Chicken (continued)

### 2. Discuss as a class the threats to the greater prairie-chicken.

Have each of the groups name the threats (categories) it came up with and the problems that fit into those threats. Record the ideas on the board. After all the groups have participated, have the students compare the categories. Are there categories that can be lumped together? (Draw lines to connect similar categories.)

### 3. Explain and discuss the HIPPO dilemma.

Explain that one way to think about the major threats to biodiversity worldwide is by creating broad categories that characterize the threats. Have the students compare their categories of threats to the greater prairie-chicken with those threats we've included, which are based on the thinking of many conservationists around the world. The categories are easy to remember by the acronym **HIPPO**.

Review each of the categories with the students: **H** = habitat loss; **I** = introduced species; **P** = pollution; **P** = population growth; **O** = over-consumption. Can the students assign each of the prairie-chicken problems they read about to one of the **HIPPO** categories? (See answers below.) Ask your students to compare the HIPPO categories to the categories they came up with. How are they similar? Different? Can they think of any other endangered animals and plants that are affected by one or several of the HIPPO problems? Ask students to describe ways that one type of threat can be related to another. For example, introduced species can cause habitat loss and human population growth can increase pollution.

#### Answers:

Habitat loss: B, F, H, J, K, L

Introduced species: E, G, I

Pollution: D

Population growth: A

Over-consumption: C

### 4. Discuss possible solutions and distribute copies of "Prairie-Chicken Solutions."

Once your students have a better understanding of the HIPPO dilemma and the threats to the greater prairie-chicken, have them brainstorm ways to protect the prairie-chicken. (Coach them a bit to draw out more concrete ideas than "increase habitat" or "stop pollution.") Write their thoughts on the board until they run out of ideas and then have them read the "Prairie-Chicken Solutions" handout to discover some innovative ways people are trying to protect the prairie-chicken. When they have finished, ask them if they learned any new alternatives. Did the students find out any more about the problems faced by the prairie-chicken by reading about the ways people are trying to protect them? (Students should point out that greater prairie-chickens are also threatened by having such a small population size and, therefore, limited genetic diversity. Review this problem with the students, making sure they understand that low numbers may mean a disease or a natural disaster could easily wipe out the population and that low numbers can lead to problems of inbreeding.)

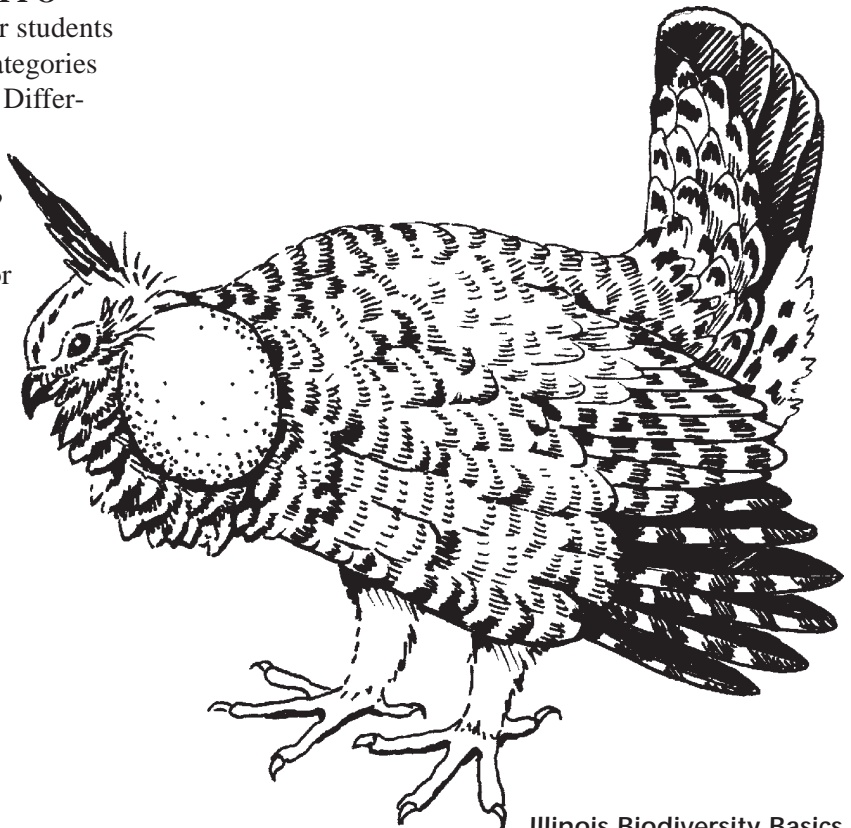



## Activity 3-2

# The Case of the Greater Prairie-Chicken (continued)

### A Note to Educators

As your students will discover, there are many different efforts taking place that are designed to assist the survival of the greater prairie-chicken in Illinois. But it's also important to understand that protecting any endangered species and/or subspecies can be controversial and that not everyone agrees on how best to conserve those species that are in the most serious trouble—or even if we should protect them. Although the issues are complex, you might want to have students explore some of them—including the Endangered Species Act—in more detail. See the “Extensions” to this activity for ideas about getting your group to examine some of these controversies.

## WRAPPING IT UP

### Assessment

1. Distribute five index cards or pieces of paper to each student. On each card, have the students write the first letter of one of the following: habitat loss; introduced species; pollution; population growth; and over-consumption. You may want them to write “Pop” on one card to separate population from pollution. Then, one at a time, read each of the statements in the list below. Ask students to hold up the card that they think portrays the threat to the species or natural area described in the statement. More than one answer may be correct! You can do a quick visual assessment of the class or have your students keep track of their individual scores.
  - The eastern sand darter is on the decline in Illinois rivers because of declining water quality. **(H, P)**
  - The demand for residential and commercial property near large Illinois cities is eliminating wetlands. **(H, Pop, O)**
  - When industries use water from rivers and lakes, the water may go back into waterways at a higher temperature, killing organisms that can't tolerate warmer water. **(P)**
  - The multiflora rose, an introduced species in the United States, took away habitat from many native plants in Illinois fields. **(I)**

- More people are moving from urban areas to the country where there is more “natural scenery.” **(H, Pop, O)**
- The main reason for the Illinois mud turtle's decline is the loss of the shallow ponds it inhabits due to drainage for agricultural use. **(H)**
- Bison were the first large animals to be killed off following European settlement of Illinois and elk followed shortly thereafter. **(H, O)**
- The numbers of eagles, peregrine falcons and ospreys declined steeply in the 1960s because pesticides sprayed on crops moved through the food chain and caused the birds to lay eggs with soft shells. These soft-shelled eggs broke before the young could develop and hatch. **(P)**

2. Have each student develop a brochure for the Illinois Department of Natural Resources that explains how Illinois' increasing human population is affecting the state's natural resources. Allow time for research.

### Portfolio

Have the students compare and match HIPPO to the list of threats their small group identified. Have them write their comparison on a piece of paper and include it in their portfolio.

### Extensions

1. Have each student research and write a short report or prepare a poster on an extinct species or one that is currently or was previously endangered or threatened because of people's activities. Students can use the following examples, or they can look for their own examples of over-exploited species using resources such as the *Biodiversity of Illinois* CD-ROMs.
  - a. reduction of egret and tern populations for decorative plumes at the turn of the 20th century
  - b. severe reduction of bison because of cultural conflicts and over-hunting for meat, hides and sport
  - c. reduction of populations of American ginseng for herbal supplements and medicines
  - d. extinction of the Carolina parakeet due to unregulated hunting and other factors



## Activity 3-2

# The Case of the Greater Prairie-Chicken (continued)

2. For older students, you may want to explore through a debate the controversy surrounding the greater prairie-chicken and other endangered species that live in Illinois. Although most people recognize the value of biodiversity, much controversy centers on the following issues:

### Saving Species Versus Saving Habitat

In the past, many conservation programs focused on saving individual species. The current Endangered Species Act is an example of the species approach to protecting biodiversity. Under the act, species and subspecies are listed as threatened or endangered. The U.S. Fish and Wildlife Service, which oversees the act, is required to develop a recovery plan for each endangered species or subspecies. Although protecting habitat is a key component of most species recovery plans, the emphasis is on individual species and subspecies. Today, many people would like to see the Endangered Species Act include more of a focus on protecting habitat than individual species. By protecting habitat, many argue that more species will be protected in the long run. They also feel that too much time and money are being spent on individual species and subspecies—and that we need to protect larger tracts of habitat if we want to protect biodiversity. Others argue that we need to do both and that there are some key species that need special protection if they are to survive.

### Saving Species Versus Subspecies

Another debate centers on the difference between species and subspecies and the importance of each. Although the Endangered Species Act currently protects species and subspecies, some people feel that subspecies are so genetically similar to their relatives (which are often not endangered) that little genetic information will be lost if a subspecies becomes extinct. This is the case with the great plains rat snake, which is a subspecies of the corn snake. The great plains rat snake is found in only a few counties along the Mississippi River in southwestern Illinois. Other conservationists argue that it's just as important to save a subspecies as it is to save

a species. A subspecies develops when a small population is isolated from its main population and, over time, develops distinct characteristics that help it adapt. For example, many subspecies form in isolated valleys and islands where breeding with the main population can't occur. Because the great plains rat snake is genetically distinct from its relatives, many conservationists think the snake is worth protecting. They feel that it's important to protect as much of the world's genetic diversity as possible. They also point out that, in many cases, a subspecies like the great plains rat snake is very important to an area's ecological health.

### Losing Genetic Diversity

Another issue focuses on efforts to protect genetic diversity within populations. Again, using the greater prairie-chicken as an example, many scientists fear that because the population of the greater prairie-chicken in Illinois is so low, continued inbreeding will weaken the small number that remain. To improve the genetic diversity of the prairie-chicken population, prairie-chickens from Kansas, Nebraska and Minnesota have been released into the Illinois prairie-chicken population. Breeding has occurred and genetic variability has increased. However, the new generations may still lose traits or gain new traits that were not previously seen in prairie-chickens in Illinois.

### Setting Priorities

Another controversial issue centers on how to set priorities for protecting species. Which species and subspecies are most important and why? In many cases, politicians, not scientists, decide how to spend national or state dollars. And that often means those species that have public appeal take precedence over those species that are less cute and cuddly but just as important ecologically. In the case of the greater prairie-chicken, some scientists may argue that other species are more important to protect and that all the effort expended protecting the greater prairie-chicken is not based on good science.



### Activity 3-2

## The Case of the Greater Prairie-Chicken (continued)

### Saving Endangered Species and Ensuring Economic Development

Your students will find a variety of articles that examine the economic issues of species and subspecies protection. There are many differing views regarding how much money we should spend on protecting endangered species, how to resolve differences between economic growth and species protection, and other issues related to the implementation of the Endangered Species Act. To help your students explore these issues, you can have them research different aspects of the Endangered Species Act or some of the issues outlined here and make presentations to the rest of the group. Or you can stage mini-debates and have several students take different sides of an issue. If your students decide to investigate the economic or policy issues surrounding the Endangered Species Act, have them write to a number of organizations so that they will get a more balanced view of how scientists, economists and others feel about the importance of the act and the value of protecting biodiversity.

### Resources

- Ambrose, Dave. 1991. Plight of the prairie chicken. *Outdoor Highlights* 19 (12): 6-13.
- Herkert, J. E., ed. 1992. *Endangered and threatened species of Illinois: status and distribution. Volume II: animals*. Illinois Endangered Species Protection Board, Illinois Department of Natural Resources, Springfield, Illinois. 142 pp.
- Stone, Sally. 1980. *These precious few*. Illinois Department of Natural Resources, Springfield, Illinois. 48 pp.
- World Wildlife Fund. 1994. *WOW!—a biodiversity primer*. Quad/Graphics, Pewaukee, Wisconsin. 67 pp.

---

**“In all my life, I never saw or dreamed of so beautiful a sight as the rolling prairies. Nothing can equal the surpassing beauty of the rounded swells and the sunny hollows, the brilliant green of the grass, the numberless varieties and splendid hues of the multitude of flowers. I gazed in admiration too strong for words.”**

—Ellen Bigelow, 1835  
as quoted in *Chicago Wilderness’ An Atlas of Biodiversity*





## Student Page

# Prairie-Chicken Problem

Have you ever heard of prairie-chickens? What about old yellowlegs, the prairie hen or the prairie grouse? All of these names describe the same species, the greater prairie-chicken. The common name of this bird comes from its chicken-like body shape and its occurrence in grasslands. A relative of the domestic chicken, this bird occurs from Canada, south to Oklahoma and Texas in the United States. It was once common in the prairies east of the Mississippi River but is now a rare resident in Wisconsin and Illinois.

Prairie-chickens are brown with dark bars, and they have dark feathers on the sides of the throat. Their feet are feathered all the way to the toes. Male prairie-chickens have fleshy orange "eyebrows" and yellow-orange sacs on the sides of the throat. The sacs are inflated as part of their courtship display. Their body is about 16 to 18 inches long, and the wingspan is about 28 inches. Males weigh about two pounds, while females are a little smaller and usually weigh between one and one-half and two pounds.

Prairie-chicken courtship behavior is unique. On spring mornings, males move onto short-grass areas known as "booming grounds." At these sites, they go through a pattern of displays to attract females. The male raises the dark feathers on his neck, inflates his air sacs, droops his wings, spreads his tail and stomps his feet while producing sounds that have been described as "booming," "hooting" or "yodeling."

Most prairie-chickens nest in April and May. The nest is built on the ground and consists of a shallow depression lined with grasses. The female lays seven to 17 eggs, which hatch in about 25 days. Young prairie-chickens are able to leave the nest just a few hours after hatching. They can fly one to two weeks after hatching.

Food for prairie-chickens consists of insects, mostly grasshoppers, from May to October each year. At other times, they eat the fruits, shoots, leaves and

seeds of various plants. They also feed on waste grain in farm fields.

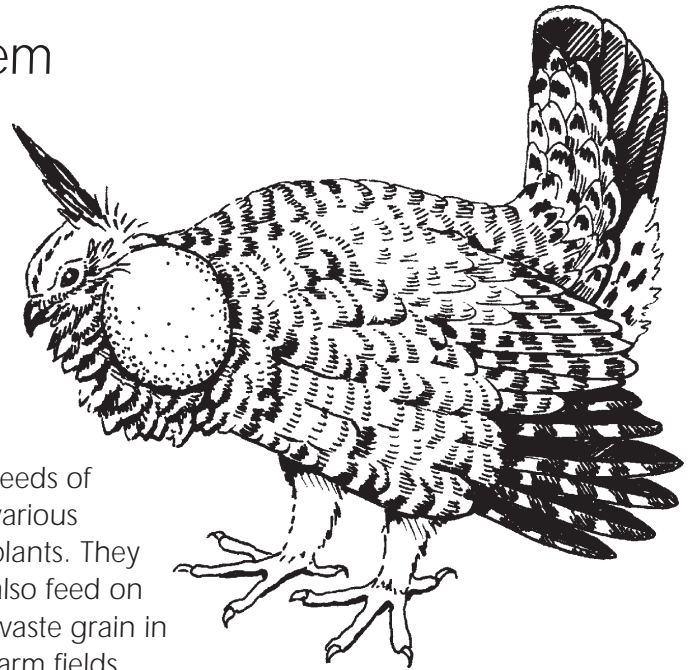

Prairie-chickens were once abundant on black soil prairies throughout the northern two-thirds of Illinois, reaching their estimated peak population of about 10 million birds by 1860. The population began to decline soon after this time, and prairie-chickens were considered on the brink of extinction by the early 1900s. Prairie-chickens were a game bird popular with hunters and at one time they were harvested by the ton. Loss of their prairie habitat to agriculture and development also contributed significantly to their removal from the state.

The greater prairie-chicken is an endangered species in Illinois, living only in Jasper and Marion counties. Instead of the native prairie that was their original habitat, the two remaining flocks live on managed preserves. Their very small population size has led to a loss of genetic diversity in the birds which affected their reproduction and survival ability. In recent years, nest parasitism by the introduced ring-necked pheasant has also been a problem. The hen pheasant may lay its eggs in a prairie-chicken nest. The prairie-chicken then incubates both its own and the pheasant eggs. The pheasant eggs hatch first and the prairie-chicken, unable to recognize that the young pheasants are not her own chicks, leaves the nest to care for the pheasants. The prairie-chicken eggs are not cared for and do not hatch.



### PRAIRIE-CHICKEN CARD

The human population in the state of Illinois in 1850 was 851,470. By 1950, the population had increased to 8,712,176.

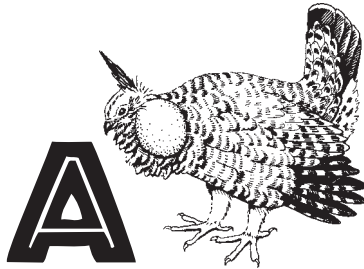

### PRAIRIE-CHICKEN CARD

Urban sprawl and agriculture have reduced original Illinois prairie land by 99 percent since the late 1800s, leaving less than one percent of the well-drained, open ground which is critical for prairie-chicken breeding rituals.



### PRAIRIE-CHICKEN CARD

Prairie-chickens were once harvested by the ton, or "cord," in times of unregulated hunting.

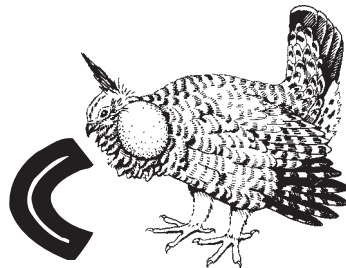

### PRAIRIE-CHICKEN CARD

Chemicals like fertilizers, herbicides and pesticides reduce soil quality and destroy ground cover. This situation leads to less cover for the birds.

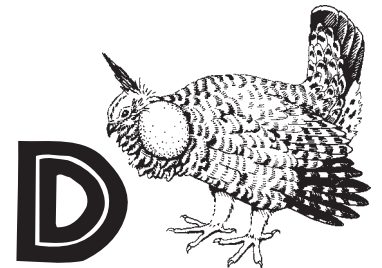



### PRAIRIE-CHICKEN CARD

*Boom-ah-boom, boom-ah-boom* is the mating song of the male prairie-chicken. The sound can carry up to two miles. During the mating season, from March until early May, courtship demonstrations and formalized fighting for females take place. These rituals lead to successful reproduction. The introduced ring-necked pheasant's breeding season overlaps with that of the prairie-chicken, leading to competition and interference between the two species.

E



### PRAIRIE-CHICKEN CARD

Many prairie plants that were part of the prairie-chicken's diet have been destroyed or are found in small, scattered areas.

F

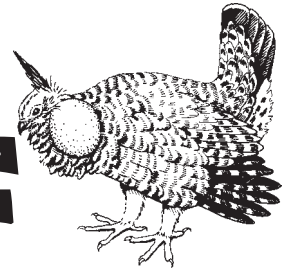

### PRAIRIE-CHICKEN CARD

The ring-necked pheasant, an introduced game bird, may lay its eggs in prairie-chicken nests. The pheasant eggs hatch in 23 days, while the prairie-chicken eggs hatch in 25 days. The prairie-chicken is unable to recognize that the first chicks in her nest to hatch are not her own. She then leaves the nest with the pheasant chicks, abandoning the prairie-chicken chicks to die within their eggs.

G

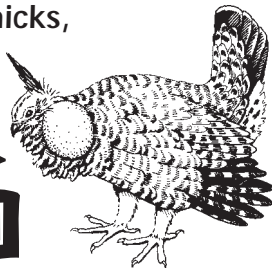

### PRAIRIE-CHICKEN CARD

In addition to the destruction of nesting sites, protective cover, such as briars, has been destroyed. Hawks, coyotes and raccoons have a better chance to prey on the prairie chicken and its eggs. The prairie-chicken population is so small that the loss of even one or two individuals may be devastating.

H





### PRAIRIE-CHICKEN CARD

The ring-necked pheasant was introduced to Illinois in the early 1890s. This species competes for the use of the same resources as the greater prairie-chicken.

I



### PRAIRIE-CHICKEN CARD

Most populations of prairie-chickens in Illinois are now found on managed preserves due to the destruction of their native habitat.

J



### PRAIRIE-CHICKEN CARD

With the development of the steel plow in the mid-1800s, farmers began to clear Illinois prairies at a rapid pace.

K

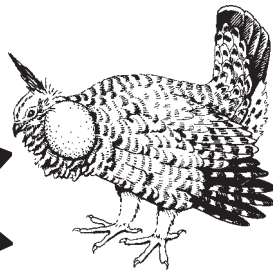

### PRAIRIE-CHICKEN CARD

Once found in 92 Illinois counties, prairie-chickens now only live in two of them.

L





## PRAIRIE-CHICKEN SOLUTIONS

Here are some examples of ways that people are trying to save the greater prairie-chicken.



Illinois laws are designed to keep people from killing, disturbing, injuring, harming or harassing prairie-chickens. People who violate these laws can be ordered to pay a large fine and/or serve time in jail.



Prairie-chickens have been imported from Nebraska, Minnesota and Kansas to help increase genetic diversity in the Illinois prairie-chicken population. As a result, fertility rates have increased.



Money from the Illinois Wildlife Preservation Fund has been instrumental in funding studies regarding the inbreeding problems in the native prairie-chicken population. This funding also contributes to the costs associated with the restoration efforts. Funds are donated by citizens through their Illinois state income tax returns.



The Illinois Department of Natural Resources now manages the ring-necked pheasant population in areas of prairie-chicken habitat.



Prairie-chickens imported to Illinois are each outfitted with a radio transmitter shortly before release so that researchers can monitor their movements.



The Conservation Reserve Program, a federal farm bill, was enacted to encourage farmers to set aside marginal and highly erodible farm land as wildlife habitat.



Some land is being restored to the native prairie condition.



In the 1960s, the Prairie Chicken Foundation began buying private property in Jasper and Marion counties on which to manage populations of prairie-chickens. Later, The Nature Conservancy purchased additional property. By 1990 the Illinois Department of Natural Resources and The Nature Conservancy owned 760 acres of sanctuary lands in Marion County and 1,350 acres in Jasper County. Individual land parcels ranged from 17 to 300 acres in size.



## Activity 3-3 Space for Species

### AT A GLANCE

Play an outdoor game, conduct a survey of plant diversity and analyze current research to explore the relationship between habitat size and biodiversity.

### OBJECTIVES

Describe factors that affect the relationship between habitat fragmentation and biodiversity loss. Create a graph that demonstrates the relationship between biodiversity and the size of a habitat. Describe different strategies for designing reserves that could help lessen the effects of fragmentation.

### SUBJECTS

English language arts, mathematics, science, social science

### SKILLS

gathering (simulating, collecting), organizing (graphing, charting), analyzing (calculating, identifying patterns), interpreting (inferring), applying (proposing solutions), citizenship (evaluating the need for citizen action, planning and taking action)

### LINKS TO ILLINOIS BIODIVERSITY BASICS

#### CONCEPTUAL FRAMEWORK

loss, degradation and fragmentation of habitats

#### VOCABULARY

biogeography, edge effect, fragmentation, habitat, immigration

#### TIME

**Part I:** one class period; **Part II:** two class periods

#### MATERIALS

**Part I:** four traffic cones or other visible markers; two ropes, each 25 feet long; two ropes, each 40 feet long; tape; two colors of tokens or poker chips (about 20 of each color); poster-sized paper; markers; stop watch

**Part II:** copies of "Leaf I.D.," "Graphing Greens Data Log" and "Ovenbirds in Illinois Woodlands" (optional) for each student; stakes (pencils or coffee stirrers work well); twine; tape measure or yardstick; (optional: poster-sized paper); marker; (optional: graph paper); clear plastic bags (such as one gallon capacity freezer bags); clear tape

#### CORRELATION TO ILLINOIS LEARNING STANDARDS

English language arts 3.A.3, 3.B.2b., 3.C.3b, 4.A.2b, 4.B.2b, 4.B.2d  
mathematics 6.B.3a, 6.C.3a, 10.A.2a, 10.A.2c, 10.A.3a, 10.C.3a  
science 11.A.2c, 11.A.2d, 11.A.2e, 11.A.3a, 11.A.3g, 13.A.3c, 13.B.2f, 13.B.3b, 13.B.3e  
social science 17.C.3a.

Habitat loss is one of the biggest threats to biodiversity. Roads, shopping centers, housing developments, agricultural fields and other types of development are breaking up our large forests and other natural areas into smaller and smaller chunks—a problem conservationists call fragmentation. Many scientists compare the remaining habitat fragments to islands because they are so isolated. And like islands, habitat fragments are often too small and isolated to support a large number or a wide variety of species. Conservationists have the tough job of trying to figure out how fragmentation is affecting biodiversity. They're asking questions like "How small is too small?," "Which species are we losing?" and "How can we balance our need for development with other species' need for space?"

Development and fragmentation can be difficult concepts for students to understand. Seeing the relationship between the two will help students realize there are certain tradeoffs that result from our decisions to develop natural areas. Most development occurs to fill people's needs for schools, homes, roads, food and income. While most people recognize that developers are not trying to destroy biodiversity when they build roads or homes, many people also feel that the value of biodiversity is not factored into our decisions to develop. Many conservation biologists would like to see communities consider how development impacts biodiversity and work to accommodate natural systems as much as possible.

In Part I of this activity, your students will play a game that will allow them to explore some of the actions we can take to try to balance human need for development

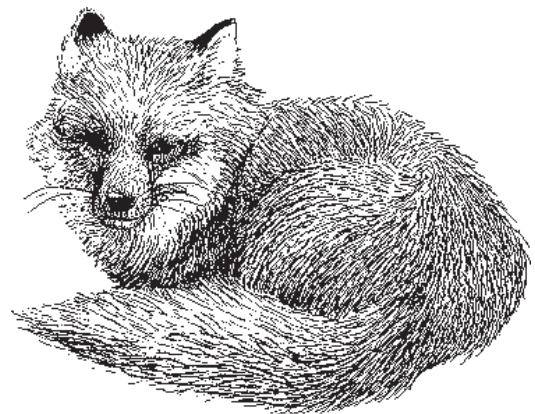



## Activity 3-3 Space for Species (continued)

and species' need for space. The students will become species trying to move between habitat fragments and they'll begin to understand why animals have such a tough time living in fragmented landscapes. The group will try to come up with some ways they can help species move between habitat fragments more easily.

In Part II, the students will take a closer look at the relationship between the size of a habitat and the biodiversity it supports. By going outside and measuring plant diversity in habitats of different sizes and then graphing their results, your group will see that, in general, smaller areas have fewer species. The "Oven-bird" option in this activity will give your students the opportunity to look at some real research about fragmentation and its effect on woodland birds in Illinois. They'll read about the fragmentation problem in Illinois, then use a graph to analyze research done by scientists.

You can use the different parts of this activity to fit your needs. Each part can stand alone, or they can be used together to help build a unit on the effects of development and fragmentation on biodiversity.

### BEFORE YOU BEGIN! PART I

You'll need an open playing area about 60 feet by 40 feet, with plenty of extra room for students to work in groups outside the playing area. Use four traffic cones or other visible markers to mark the boundaries. Use two 25-foot ropes to make two small islands with diameters of about eight feet. Use two 40-foot ropes to make two large islands with diameters of about 13 feet. Arrange the islands in the playing area as they are arranged in the diagram. If possible, tape the ropes to the playing surface so that students can't kick them out of place during the game. We recommend that you do the activity outside, if possible. You'll also need two colors of tokens or poker chips (about 20 of each color), poster-sized paper, markers and a stop watch.

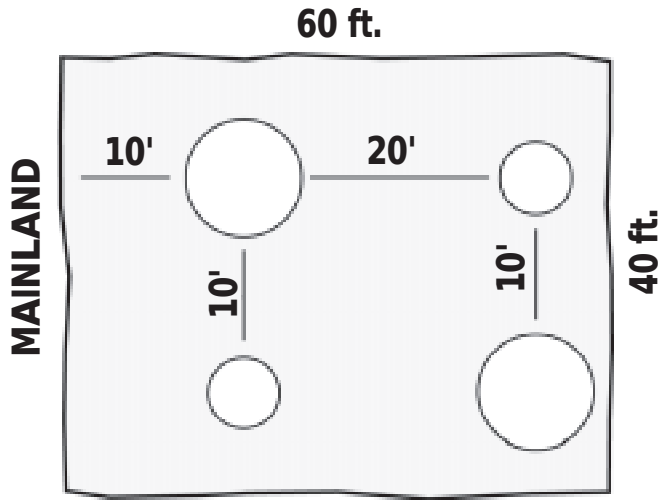

### WHAT TO DO! PART I

#### Island Hopping

In the 1960s, two scientists, Robert MacArthur and Edward O. Wilson, studied how many species lived on islands of different sizes at different distances from the mainland. Their theory, called the theory of island biogeography, has helped ecologists think about the effects of habitat fragmentation. Although the theory's name sounds complicated, its point is very simple: more species can live on islands that are large and close to the mainland than on islands that are small and far from the mainland.

Why is this theory still important to scientists today? Because it relates directly to the study of the numbers of species in habitat fragments on the mainland. In many areas, fragments of forest and other habitats are all that remain where the landscape used to be covered with vast areas of continuous natural vegetation. Scientists compare these fragments to islands because they are so isolated.

In this part of the activity, your students will learn the basics of island biogeography by imagining they are species trying to get to different-sized "islands" at different distances from the "mainland." Then they'll apply the concepts of island biogeography to habitat islands. They'll explore some of the threats facing species in habitat islands and think about ways we can



## Activity 3-3 Space for Species (continued)

reduce those threats by planning development with biodiversity in mind.

### 1. Introduce the activity.

Explain to the students that they'll be investigating a well-known ecological theory called the theory of island biogeography. Briefly explain that scientists Robert MacArthur and Edward O. Wilson wanted to study species that traveled from the mainland to nearby islands in the ocean. (You might want to introduce the scientific term "immigration" here, explaining that MacArthur and Wilson were studying species that immigrated to islands from the mainland.) The scientists wanted to know how many species from the mainland lived on islands of different sizes at different distances from the mainland. They were also interested in those species that became "locally" extinct, which means they were no longer living on the islands but could still be found living on the mainland.

Tell students that they'll be doing a similar investigation outside. Some students will be animals immigrating to "islands." Other students will be playing predators, diseases and different forces out in the "open ocean" that can cause animals to become extinct.

### 2. Explain the rules.

Familiarize the students with the playing area. Show them the islands and their sizes and distances from the mainland. Select about 22 students (or three-fourths of the group) to be species immigrating to the islands and about eight students (or one-fourth of the group) to be taggers that represent threats that can cause immigrating species to become extinct. Explain that immigrating species will have one minute to run from the mainland to an island, but they'll have to avoid being tagged by the students in the playing area because being tagged will make them extinct on the islands. As you select students to be the extinction taggers, you can have them think of some of the causes of extinction (predators, diseases, pollution, severe weather and so on) they might represent to species immigrating across the ocean.

Explain that once you give the signal, species on the mainland should begin immigrating to the islands by making a run for them. Species can be tagged out of the game only when they are out in the open ocean. If they are on an island or the mainland, they can't be tagged. Although they're safe on the mainland, tell students that at the end of the game you'll only count the species that successfully have made it to an island.

### 3. Play Round One: Immigrate!

Tell the taggers to spread out in the playing field and make sure they keep moving all the time that students are immigrating. Explain that, as in nature, threats to species are spread all around the landscape, so the taggers should also be spread out. Keep taggers from crowding around islands and not allowing any students to pass. Try to make the game fair for everyone. Yell "Immigrate!" to let students know when to begin. Keep time and tell the students to stop after one minute. Ask any students who become extinct to help you monitor the game.

### 4. Evaluate the results.

Have the students count the number of animal species on each island. Keep track of the results on a piece of easel paper (poster-sized). You can make a chart or a graph, or you can write the number of species on each island in a diagram of the playing area.

Have the students gather around to go over the results of Round One and to talk about what they'll do in Round Two. Figure out the percent of students who survived (divide the number of students who made it to an island by the total number of students who started on the mainland, then multiply by 100) and record the percentage on the poster-sized paper.

Tell the students that, according to MacArthur and Wilson, the large island close to the mainland should have the most species. Is that what your group found? Why are there more species close to the mainland? Ask students to think about their experiences while immigrating. (*Those who tried to*





### Activity 3-3 Space for Species (continued)

*run to the farthest islands faced many more threats on their journey than those who traveled only to a nearby island.)* If your students found different results than MacArthur and Wilson found, talk about some reasons they may have had a different outcome. *(Your students may have been better at getting to islands than most species are, or the extinction taggers could have made more species extinct than happens in nature.)*

Regardless of how many species made it to islands at different distances, more students should be on islands that are large than on islands that are small. Ask students why this is true. *(Small islands don't have the space or variety of different habitat types to support many different species, just as the small islands in the game were not big enough to hold many students. If a small island was overcrowded, a student could have been pushed out and, while moving to another island, would have been open to an extinction tagger.)*

#### 5. Discuss habitat islands.

Ask the students to think about what's happening to many of our natural areas and what that may have to do with ocean islands. Why might conservationists use the MacArthur and Wilson model when they think about designing reserves in natural areas?

*(Explain that many of our forests and other natural areas have been separated from each other. Only small patches of the continuous vegetation that once covered much larger areas still remain. And the things that separate these habitat islands, such as roads, buildings and agricultural fields, are often even more difficult for species to cross than the ocean.)*

Ask the students why animals need to move between habitat islands. *(Many islands are too small for all the species living in them, and they can become crowded. Competition for resources may force animals to move to find more food or shelter. Some animals need to migrate. Others may be looking for mates.)* Then ask the students what kinds of barriers the animals might face. *(Animals are often killed trying to cross roads. Many animals also become easy targets for predators to spot when they leave their habitat. Animals traveling a long distance through developed areas may not be able to find enough food and could become pests to humans by rummaging through garbage cans or waiting for people to provide food.)* Record the students' ideas on poster-sized paper if you can.

#### 6. Play Round Two: habitat island hopping.

Round Two will demonstrate what it's like for species trying to move between habitat islands. Tell students that the playing area now represents habitat islands in a sea of development rather than in an ocean.

For this round, you'll need two-thirds of the class as species in habitat islands and one-third as extinction taggers. *(Have the students think about how the extinction factors might be different in habitat islands as opposed to oceanic islands.)* You might make the species that were tagged out in the last round become taggers, and you might move some taggers into habitat islands so that the students get a chance to experience both roles. Have the students think of what the taggers might represent in the sea of development by





### Activity 3-3 Space for Species (continued)

## What's the problem with patches?

Habitat fragmentation is one of the most serious threats to biodiversity. A researcher studying birds in one part of Australia, for example, found that the numbers and ranges of almost half the birds native to the region have decreased since the early 1900s. He thinks that almost all the decline is a result of habitat fragmentation. Small, fragmented habitats, called habitat islands, usually can't hold as many species as large, more continuous ones. Here are some of the reasons we lose species, and biodiversity, in small patches of habitat:

**Luck of the draw:** When a piece of habitat is destroyed, some species could be wiped out by chance alone. If a species uses only a small part of a larger area, and that part happens to be destroyed, that species and its habitat are lost. Species that are very rare or that are found only in small populations are especially at risk when their habitats are broken up into smaller and smaller chunks.

**Less habitat, less diversity:** Large areas usually contain a wider variety of habitats than smaller ones. Since different habitats usually support different species, a fragmented area will often contain fewer habitats and fewer species than a larger area. Many scientists think this is the main reason diversity is lower in habitat patches.

**Road blocks:** Some species can live in habitat fragments if they can move from one area to another to get everything they need, such as food, shelter and mates. Unfortunately, many fragments are surrounded by barriers that

prevent species from moving between different areas. Roads are a common barrier that many species can't cross but buildings, parking lots and fences can also keep species from getting where they need to go. When a species is isolated from others of its kind, it can become subject to inbreeding and lose some of its genetic diversity. Species that need a lot of space or that spend a lot of time on the move can be very sensitive to these "road blocks."

**On the edge:** When we build developments and break a habitat into small chunks, we create more boundaries between the habitat and the outside world. Conditions at these boundaries, called edges, are very different than the conditions in the habitats interior. There may be more sunlight and wind at the edge, and because there's no canopy overhead to keep the moisture in, the edge is often much brighter and drier than the interior. These different conditions can change the plant and animal species living in the area. There can be different predators and prey, making it harder for animals to find food and to avoid being food themselves. In small fragments, edge conditions can take up most of the habitat. Scientists call this problem the edge effect, and species that can't adapt to the edge often become threatened.

Fragmentation doesn't affect all species in the same way. Some are more sensitive to habitat loss than others. And some species can even benefit from fragmentation and the edge effect. All of the factors listed above affect different kinds of species in different ways and that's what makes the problem of fragmentation so difficult for conservationists trying to protect a wide variety of species.



### Activity 3-3 Space for Species (continued)

going over the threats they came up with in their discussion in step five.

Tell students that the two different colors of tokens you have represent some of the things that species need. The tokens may be food and water, shelter and mates, or any of the other needs you discussed in step five. Tell the students that they'll be competing for these resources in the habitat islands. Count out enough tokens so that there is one of each color for every student in the habitat islands. Scatter the tokens throughout the four islands so that larger islands, which can hold more resources, have more tokens. State the following rules:

- Students must collect at least one token of each color to survive, but they can collect more if they like.
- Students can pick up only one token at a time from any island. So if a student picks up a token on the island he or she starts from, the student must run to at least one other island for another token. Students can return to their first island for tokens if they need to.

Shout "Immigrate!" to start the game again. This time give students as much time as they need to move between the islands. Stop the game when every student either has been tagged or has collected at least two tokens. Tell taggers they should spread out in the landscape, just as threats to species are spread out. They shouldn't stand in front of moving species and keep them from passing. Use your judgment about how to keep the game fair. After they finish the round, count the number of students who survived and record it on poster-sized paper.

#### 7. Go over the results of Round Two.

Have the students gather together to figure out the percent of species that survived. Most likely, a large percent became extinct. Ask students why they

think so many species didn't make it. (*There were more extinction taggers out to get them, and they were forced to leave their habitat to get all the resources they needed. Species that had to travel to several islands to get their tokens faced many threats, and most probably didn't survive.*)

Ask the students who didn't survive why they think they were tagged. Were the extinction taggers faster than they were? Did they have to go to several islands, leaving themselves open to taggers each time? Were they forced out of a small island that was too crowded? Ask them if real species are also affected by the same things. (*Species that are slow-moving are often hit by fast-moving cars; some species are forced to travel between many habitat islands to find all the resources they need and are thereby open to threats when they leave their habitat; and many species can be pushed out of overcrowded habitat islands and forced to move to other habitats.*)

Ask the students who survived why they think they were never tagged. Were they faster than the taggers? Did they have to go to only one or two islands to get their tokens? Did the taggers see them? Tell them that in real habitats, just like in the game, not every species becomes extinct. Ask the students if real species can survive in the same way that they did. (*Some species can avoid many threats that other species face. For example, birds can fly over cars that might hit other species. Some species need only a very small amount of space to get what they need, so they might not ever need to leave their habitat island, or they might not have to look far outside their habitat. Still others might not be affected by the main threats in an area. If, for example, there was a predator killing many small animals in an area, a larger species might be too big to be eaten by that predator.*)



## Activity 3-3 Space for Species (continued)

### THE EDGE EFFECT

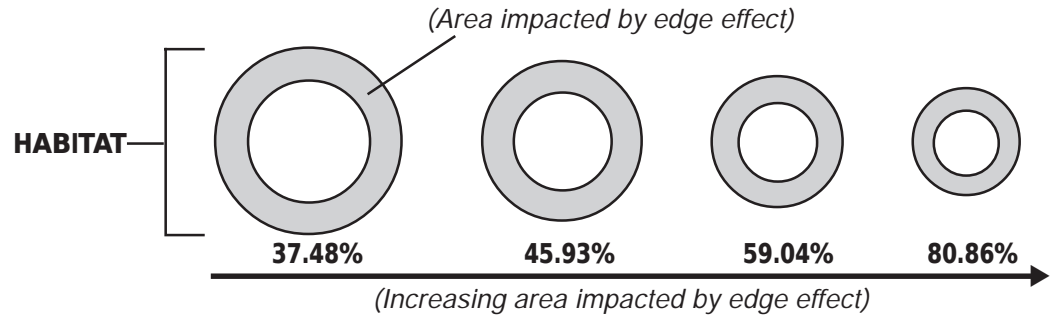

#### 8. Introduce edge effect.

Now tell the students that there is an additional threat that species face when living in habitat islands. Species are at risk not only when they travel between islands, but also while they're inside their habitat island. Many species can be lost to something called the edge effect.

The conditions at the edge of a patch of forest (as well as some other ecosystems) are quite different from those in the interior of the patch. Ask the students if they can think of some of the ways the edge of a habitat might be different from the middle. *(Often, more wind and sunlight make the edge much hotter and drier than the interior. The difference in conditions can change the plant species living in the area, and plants that are better suited to the edge might out-compete plants that would normally grow in the forest. Some of the plants that are lost could have been a source of food or shelter for animals in the forest, so these animals could be lost with the plants. Also, it is often easier for predators to find prey on the edge, so some prey species can have a hard time living on an edge.)*

The figure above illustrates the impact edge effects can have on habitats of varying sizes. Smaller habitats will have a larger proportion affected.

#### 9. Play Round Three: Life on the edge.

Tell students that they'll play another round to find out how the edge effect can affect species in habitat islands. Start the round with the same number of species and tokens that you started with in Round Two. Let some of the students who have been taggers since the first round become moving species. Collect the tokens and scatter them throughout the habitat islands as you did for Round Two. Tell the students that the rules for this round are the same as they were in the last round, except for one major change. Now the taggers will simulate the edge effect by reaching an arm's length into the islands to tag species. Their feet can't cross the rope that marks the island—they can only reach in.

Shout "Immigrate!" to start the round, then give the students as much time as they need to collect their two tokens. Once the round is over, count the students that survived and record the number on your poster-sized paper.

#### 10. Go over the results of Round Three.

Have the students gather together to calculate the percentage of surviving species. Did more or fewer species survive this round? What did the students expect would happen? Explain that in most cases some species can be lost to the edge effect, so they would expect that the percentage of surviving species is lower than in Round Two when they didn't consider the edge effect. Ask students who









### Activity 3-3 Space for Species (continued)

were tagged if they were tagged on the edge or outside an island. Students tagged on the edge are much like species that can't adapt to the new conditions or like species that are easily spotted by predators, and so can't survive as well on the edge. Had any students who were tagged outside an island been pushed out of an over-crowded island? Did they notice that their amount of "safe," or healthy, habitat had been decreased by the edge effect?

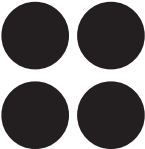
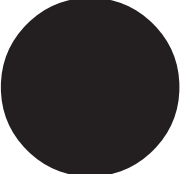
Tell the students that although many of the original species didn't survive in the game, the total number of species in real habitat islands with lots of edges can actually go up. Ask if anyone knows how this could happen. (*Many species that are well adapted to the conditions on the edge can move in and take the place of a smaller number of species that were adapted to the interior and not to the edge.*) In the game, when a species was tagged out, it wasn't

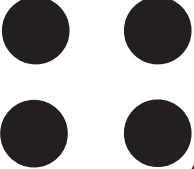
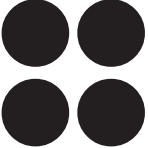
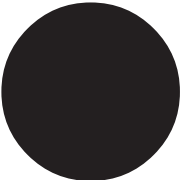
## RESERVE DESIGN CHOICES

 <span style="float: right;">A</span>	 <span style="float: right;">B</span>	<p><b>A</b> is the better choice because a large reserve can protect more species than a small one.</p>
 <span style="float: right;">A</span>	 <span style="float: right;">B</span>	<p><b>B</b> is the better choice because one continuous habitat is better than several broken-up habitats.</p>
 <span style="float: right;">A</span>	 <span style="float: right;">B</span>	<p><b>B</b> is the better choice because reserves that are connected, or that allow species to move among them are better than reserves that are not.</p>
 <span style="float: right;">A</span>	 <span style="float: right;">B</span>	<p><b>B</b> is the better choice because reserves that are close together are better than reserves that are spread far apart.</p>
 <span style="float: right;">A</span>	 <span style="float: right;">B</span>	<p><b>A</b> is the better choice because it will have more habitat that is not experiencing the edge effect than B has.</p>



## Activity 3-3 Space for Species (continued)

replaced with another species, but in nature this can happen. Some disturbed habitats actually have more species than healthy ones, but they don't necessarily play the same ecological roles as these species do in a healthy habitat. And the disturbed habitats often contain widespread, nonnative species rather than the more rare local species that are important in the area.

### 11. Discuss reserve design: Making a good plan.

Tell the students that the challenge of understanding species' need for space is in building developments like roads, homes and schools so that both people and wildlife can get the things they need. Because it's not always easy to do, many species are in trouble. But it can be done. Ask the students to think about how we can help wildlife in fragmented areas, whether in reserves or in developments.

For example, one way to make sure that there's enough habitat for species is to set aside land in reserves. Ask the students if they can think of any potential problems with reserves. *(If they have trouble thinking about problems, lead them back to the concepts they learned in the game. Many reserves are like habitat islands—they are surrounded by developments and can become isolated. Small reserves might be too small to support many species. And wildlife moving between reserves can face many threats. Your students may come up with other problems not related to the concepts of the game, but be sure that the ones listed here are covered.)*

Draw the diagrams on the previous page on poster-sized paper or on the chalkboard. Each diagram represents a possible reserve design, but in each set one is a better choice than the other. Ask the students which design in each pair they think is best, based on what they learned in the game. Ask them to explain their choices, and then give them the answer and explanation provided. Remember that there are many different ways of thinking about reserves, and your students may have many different issues in mind. The answers provided are the

best choices according to what we know today about island biogeography. As long as the students can justify their answer with an explanation that demonstrates that they understand the material, they're right. But let them know that there are many ways of looking at the problem. If you have time, you can test these different designs with more rounds of the game. Use the same rules and see if more species survive with the recommended designs.

Tell the students that these designs are often the best way to protect the largest number of species. But they're not always realistic, and they're not always the best plan because they don't consider the needs of specific species. Emphasize that there are many, many factors to consider when planning reserves. For example, does land need to be purchased? How much will it cost? What else might the land be used for? Does anyone live in the area? What species are using the area? Planners of reserves must weigh the costs and benefits of development and protection of natural areas, which can be a very complex and time-consuming process. If there are any current plans for the purchase of land for either protection or development in your area, you might discuss them here. How do your students feel about the different options available?

### 12. Talk about how people can help species in developments.

Most animals probably don't live their whole lives in reserves. Even if they use the reserves most of the time, chances are they'll need to leave them to find food, mates or other things at some point. Do your students think wildlife has a good chance of surviving outside reserves? Are there things we can do to increase the animals' chances and help preserve biodiversity?

Refer to the threats to species moving between habitat islands that your group identified in Round Two of the game. Talk again about the threats and ask students to think of ways we can help reduce them. Some ideas are listed on the following page.



## Activity 3-3 Space for Species (continued)

### On roads:

- Post wildlife crossing signs to alert drivers that they are likely to encounter an animal on the road.
- Construct highway underpasses so animals can cross roads without the threat of being hit by a car.
- Where possible, use less salt, or use an alternative to salt, on roads in the winter to reduce damage to plants along the road.

### In backyards:

- Plant native plants so that the yard is more like the surrounding habitat and attracts natural species.
- Put up bird feeders for birds traveling between habitat fragments in search of food.
- Cut down on the use of pesticides so that birds and invertebrates can use backyard habitats without the threat of being poisoned.
- Keep pet cats indoors so that they do not prey on the lizards, snakes, birds, squirrels and other wildlife that may be living in the backyard habitat.

### Around the school and other buildings:

- Convert part of your schoolyard or community center to a wildlife habitat.
- Provide water sources such as bird baths, marshy areas or ponds.
- Put up boxes that birds can use for nesting.

### In the community:

- Plan “greenways” such as bike paths and hiking trails that preserve habitat in tracts that could provide wildlife with passageways, or corridors, connecting different reserves that are far apart.
- Encourage members of the community to become involved in making decisions about what land will be developed and how it will be done. Once your students have come up with some ideas, give them the option of taking some type of action—from conducting more research to creating a wildlife habitat area nearby. You may want to try some of their ideas as part of a class or group project. The National Wildlife Federation’s Backyard Wildlife Habitat Program, which has a Web site at

[www.nwf.org/nwf/habitats](http://www.nwf.org/nwf/habitats), can give your group ideas about how to create or enhance wildlife habitat. Whether or not you decide to take action as a group, make sure that your students understand that although habitat loss and fragmentation are serious problems for wildlife, making the decision to build roads, homes or schools doesn’t mean we have decided not to protect biodiversity. There are many ways we can share space with other species.

## BEFORE YOU BEGIN! PART II

Find a natural area for your group to work in. You will need an area big enough to hold a 64-square-yard plot with plenty of extra room for the students to move around in. If your schoolyard isn’t available, a lawn (not newly planted), local park or roadside field would work. Because the species-area curve does not work well with small numbers, your students need to be able to find at least 12 different species. You should look over the area first to make sure there are enough species before you send your students out. You should also make sure there are no poisonous plants in the area. Make copies of “Leaf I.D.” Also, see the section on “Endangered Plants” (page 122).

Collect these materials: stakes (pencils or coffee stirrers work well); twine; tape measure or yardstick; poster-sized paper (optional); marker; graph paper (optional); clear plastic bags (such as one gallon capacity freezer bags); clear tape; copies of “Leaf I.D.,” “Graphing Greens Data Log” and “Ovenbirds in Illinois Woodlands” (optional).

## WHAT TO DO! PART II

### Graphing Greens: The Species-Area Curve

In this activity, your students will learn how to make and interpret the species-area curve, one tool scientists use to investigate the level of biodiversity in a habitat. The activity will also give them a firsthand look at the relationship between biodiversity and habitat size because they’ll survey plant diversity in a habitat they’re familiar with—their schoolyard, community, park or some other local area. They’ll look at it in



### Activity 3-3 Space for Species (continued)

different-sized plots to see how the number of species changes as the habitat size gets bigger and bigger. (See “Setting Up Plots” at right and “Endangered Plants,” page 122, for more information.)

The species-area curve is a graph that shows the relationship between habitat size and the number of species in the habitat. In this activity your students will look at the relationship between the size of your selected habitat and the number of plant species in it (they can also look at other kinds of species if you like). Almost every species-area curve has the same general shape: the number of species rises fairly quickly and then levels off (see the species-area curves on pages 125 and 126). The way that curves differ from this general shape can give scientists important information about the habitat or species they’re studying. This activity is designed to get students to think about graphs as tools for looking at the natural world. While this activity does not require a very advanced understanding of graphing, it is probably too advanced to be a good introduction to making and interpreting graphs.

#### DAY 1: Collecting Plants

##### 1. Introduce fragmentation.

If you’ve already done Part I of this activity, review the concept of fragmentation. Ask students to think about island biogeography and which size islands contain the largest number of species. They should recall that the larger islands hold more species. Tell them that in this activity, they’ll try to see if the same is true of larger habitats in their schoolyard or local park. They’ll be investigating plant diversity in their schoolyard or local park, and finding out how it changes as they look at larger and larger habitats.

If you haven’t done Part I, tell students that you’ll be investigating the diversity of plants in their schoolyard. Tell students they’ll be trying to see if there are different numbers of species in habitats of different sizes. Explain that many people are concerned about how the size of habitats affects biodiversity because we are breaking up many

#### Setting Up Plots

Mark off an eight yard by eight yard square and divide it into 10 plots using stakes (pencils or coffee stirrers will work) and twine (see diagram). After the plots are marked off, place a large clear plastic bag in each plot and mark the plot number on it.

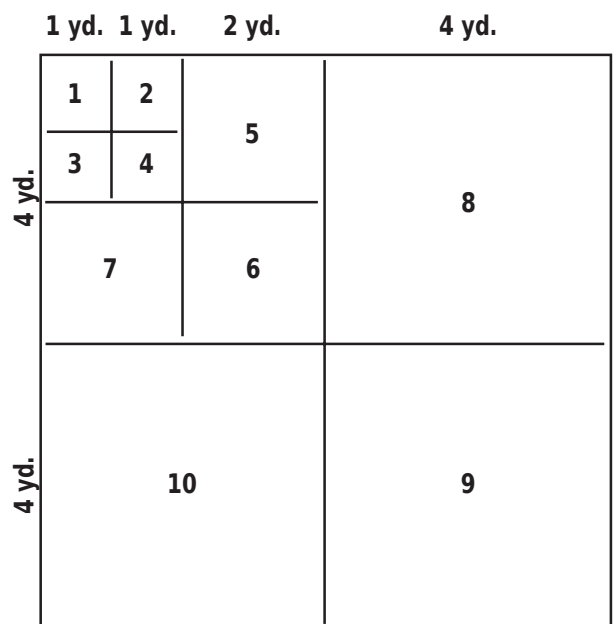

species’ habitats into small chunks by building roads, homes, shopping centers and other developments—a problem called fragmentation. Many scientists and planners are trying to better understand how fragmentation is affecting biodiversity.

Tell the students that in this activity they’ll see one way that fragmentation affects biodiversity. Explain that they’ll be counting the number of species in a sample area made up of plots of different sizes and that each plot represents a different-sized habitat. You might ask for any predictions about how they think a habitat’s area will affect the number of species it contains.





## Activity 3-3 Space for Species (continued)

### Endangered Plants

Are there any endangered plants in your area? You might want to find out before you do this activity or have your students do some research on the subject. They could start by looking at the *Biodiversity of Illinois* CD-ROMs. If there is an endangered plant in your area, and there's a chance you could find it in the area where you'll be working, have the students prepare a poster or other display about the plant that includes information about its life history, why it's endangered and how to identify it. That way, they'll be sure not to harm any endangered plants while they're collecting samples, and they'll learn about an endangered species that could live in their own backyard. Also check with a local Illinois Department of Natural Resources biologist (look in your telephone book for contact information) to verify the identity of any species that you suspect may be endangered and to let you know about other endangered plants that may be nearby.

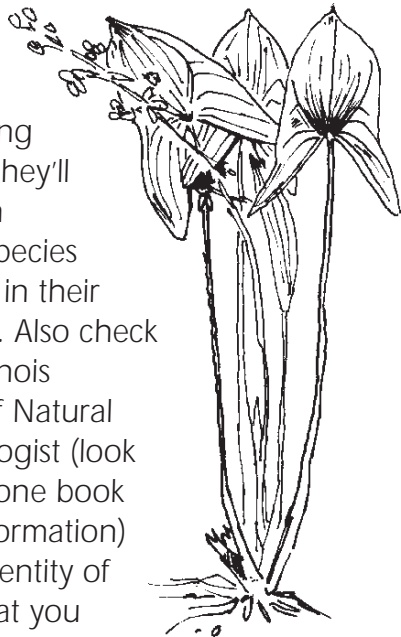

### 2. Explain the collection procedure.

Bring students to the plots (see "Setting Up Plots" page 121) and explain how they should work in groups to collect their samples. Tell each group to take a leaf from each different species they find in their plot and put it in their plastic bag. Encourage them to be as gentle as possible and not to take more than one leaf if they can avoid it. Be sure to caution them about not picking poison ivy or other poisonous plants. Always obtain landowner permission before entering the property and before collecting anything. **Note:** You may want to ask students to sketch or photograph the leaves instead of collecting them.

Review with students how to tell different plant species apart. Choose leaves of two very different species and ask the students if they think the two leaves are the same species. They should recognize that the leaves are from two different kinds of plants. Ask them how they know. (*The leaves look different.*) Ask them to be specific about what's different. Refer to the handout "Leaf I.D." for some basic leaf characteristics that students can use to tell one kind of plant from another. Make sure they understand that the names of all the different characteristics of leaves are not important for this activity. What's important is that the students realize that these characteristics, which have been named, are ways that people tell if plants are the same species or not.

Choose leaves of two different species that look more similar and ask students if the leaves are from the same kind of plant. Students should again be specific in telling how the leaves are different. Have a few copies of the "Leaf I.D." handout for students to refer to while they're collecting.

It's best if you don't allow more than 25 students in the plot area at once because it can become too crowded for them to work. You might arrange them this way: one student per one-square-yard plot, three students per four-square-yard plot and four students per 16-square-yard plot. If you have more



## Activity 3-3 Space for Species (continued)

than 25 students, have students who aren't collecting help the students working in the smallest plots identify the plants after they've finished collecting. Or have them trade the job of collecting plants. If you have fewer than 25 students, reduce the number of students in the mid-size plots first and in the large plots second.

### 3. Collect the samples.

Give the students as much time as they need to collect their samples. Times will vary according to the number of species and the number of students. Plan to spend at least 15 minutes collecting.

### 4. Log the samples.

Bring all of the samples back inside and have the groups empty their bags and sort through the samples in their collection groups. Have them make sure that each group has only one sample of each species. If they have more than one, have them select the leaf that's in the best condition to represent that species.

While the students are sorting through their samples, prepare a data log, like the "Sample Data Log," for them to use to record their data. A piece of butcher paper that you can unroll as you need more space would work well. You can also use poster-sized paper, but you'll probably have to use a few sheets to hold all the samples. **Note:** You may want to prepare the log in advance to save time while doing the activity.

Once you're ready, have the students bring their samples to the data log in order by plot number, beginning with Plot 1. Have the student(s) from Plot 1 tape up a sample of each species in the "species" column and put a circled "X" under the "Plot 1" column next to each species to show that they were first found in Plot 1. Every other time one of these species is found in a plot, simply mark an "X" to show that it is in the plot, but it isn't new to the entire sample of species.

Next have the student(s) from Plot 2 post their samples. You should tape up only samples of new species. If a student has a sample of a plant that is already on the data log, he or she should mark an "X" in that species' row. Any new species should be taped up and a circled "X" should be placed in that species' row under Plot 2 to show that it first appeared in Plot 2. Do the same for the rest of the plots.

	Plots									
Species	1	2	3	4	5	6	7	8	9	10
	⊗				×		×			
	⊗			×	×	×				
	⊗	×			×	×	×	×	×	×
	⊗			×		×	×	×	×	×
	⊗					×				
	⊗				×	×			×	
	⊗									
		⊗						×	×	
		⊗						×		×
		⊗				×				×
		⊗				×	×	×		×
		⊗	×		×					
			⊗	×	×	×			×	
				⊗	×	×		×	×	×
					⊗	×		×		×
							⊗			
								⊗	×	×
									⊗	×
										⊗



## Activity 3-3 Space for Species (continued)

### Ovenbirds in Illinois Woodlands: A Down-Time Idea

While you're filling in the data log, there will be a lot of time when most students don't have a task. If you would like to give your group an assignment related to the species-area theme, you can give them the "Ovenbirds in Illinois Woodlands" activity (page 131). This activity is designed for independent student work while you fill in the data log. It should give the students a good idea of how scientists use graphs both to make sense of data and to learn how different species use space in their habitats. You can have students work individually or in groups while students add their plants to the log.

Alternatively, you could give your students this assignment at the end of the "Space for Species" activity as a follow-up to get them thinking about other ways of graphing the species-area connection. In that case, you'll need to have some other activity for them to work on while you're making the data log. You might want them to focus on the plant samples they've collected, having the students identify the samples, classify them or make rubbings of them as a science or an art project.

*Answers to "Ovenbirds in Illinois Woodlands:" Forest Size in Acres; Chance of Encountering or Attracting Birds; 3.5 percent, 25 percent, 70 percent; large; there is an increase in nest predation and nest parasitism by cowbirds; answers will vary.*

### 5. Fill in the "Graphing Greens Data Log."

Once you have finished the data log, have the students use the information in the log to fill in the data summary table at the bottom of the "Graphing Greens Data Log." This table will help them make the species-area curve (see sample table below). They'll use the "Total Number of Species" row (the cumulative total of species found in the plots) for their y-axis and the "Total Sample Area" row (the cumulative area of plots that make up the sample area) for their x-axis when they make the graph.

Students can make this graph as a group, or they can make the graph as a homework or an in-class assignment if they need the practice. If they're going to make their graphs on their own, have each student fill in a data summary table. If you're going to make the graph as a class, you can summarize the data into one table as a group. On Day 2, you can either go over the graphs that the students made at home, or you can make one group graph.

### DAY 2: Plotting the Species-Area Curve

#### 6. Graph the results.

The graph should be labeled "Total Area" on the x-axis and "Total Number of Species" on the y-axis. Data for the x-axis will come from the "Total Sample Area" row of the data summary table. Data for the y-axis will come from the "Total Number of

**Data Summary Table**

Plot Number	1	2	3	4	5	6	7	8	9	10
New Species (first seen in sample area; ⊗s in this plot)	7	5	1	1	1	0	1	1	1	2
Total Number of Species (all ⊗s up to now)	7	12	13	14	15	15	16	17	18	20
Plot Area (sq. yd.)	1	1	1	1	4	4	4	16	16	16
Total Sample Area (total of plot areas in sq. yd.)	1	2	3	4	8	12	16	32	48	64



## Activity 3-3 Space for Species (continued)

Species” row of the data table. The number of data points will equal the number of plots (10 in this example). Your students’ graphs should look similar to the sample below.

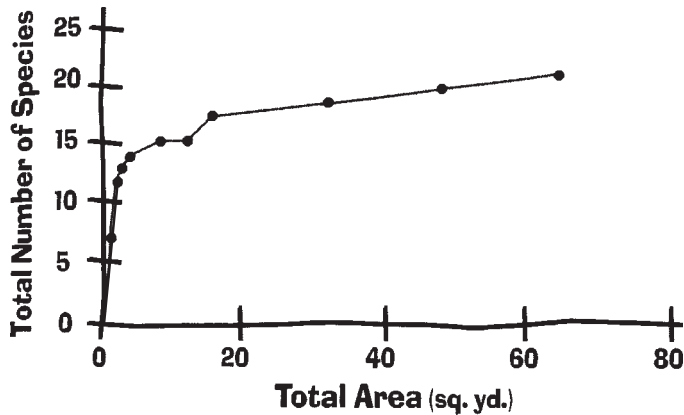

### 7. Interpret the graph.

Before you can talk about all the different uses of the species-area curve, your students have to interpret it. Did your graph have the same general shape as the sample curve? If it did, tell the students that the curve they made based on their schoolyard habitat or local park is a lot like curves made from samples in other kinds of habitats. Most species-area curves have this general shape. If your curve is very different, show them the more common type of curve so they get a better sense of how species-area curves usually look.

Ask the students why species-area curves look this way. (*In general, most species in North America are commonly found throughout their habitat. In other words, you would probably see in a 10-square-yard plot of forest most of the trees, birds or mammals that live in a 50-square-yard plot of the same forest. But as you looked at larger and larger plots, your chances of finding rare species or species that require special resources would increase. [Species that are top predators, such as big cats and birds of prey, may be rare in a habitat because they need a lot of space to find food. They might only be in a plot if their home or nest is there or if they are passing through in search of food. Species can also*

*be rare if they have more specialized needs than other species and depend on a certain type of soil or food. These species would only be found where the resources they need are found.] As you look at bigger and bigger areas of a habitat, the chances increase that you'll find these rare species, but you won't find them at the same rate that you found the more widespread species. So the curve will usually rise sharply at the small plot areas, then more slowly as the area increases.)*

### 8. Discuss how scientists use the species-area curve.

Graphs are important tools of scientists. The graphs help scientists make sense of a lot of data by putting it in a form that allows the scientists to see quickly what the numbers mean. Talk with your students about how the curve might allow them to see the connection between species and habitat area better than the log would. What kinds of things do they think they could use the species-area curve to find out?

One way scientists use the curve is to figure out how much of a habitat they have to look at in order to find most of the species living in it. If they want to take samples of most of the species in a habitat, they probably won't have time to go over every square inch of it in search of all the species. But by using the species-area curve, they can look on the graph at the plot area where the graph levels off, or where very few new species are added, and they can look at a plot of that size and feel confident that they will get most of the species in the habitat. Based on the sample curve, for example, a scientist would look at a 20-square yard plot to find most of the plant species in the habitat. Ask the students what size plot they would have to make to find most of the plants in the area they surveyed.

Another way the species-area curve can be used is to compare different habitats. Although almost all species-area curves have an initial rise in the number of species followed by a more level curve, different habitats can have curves with different shapes. The steepness of the rise, the point where



### Activity 3-3 Space for Species (continued)

the curve levels off, and how quickly it levels off can be different for different habitats.

Draw a species-area curve that is less steep and that levels off at a lower number of species than the one you made as a class. (See the example below). Ask the students what the different shape tells us about

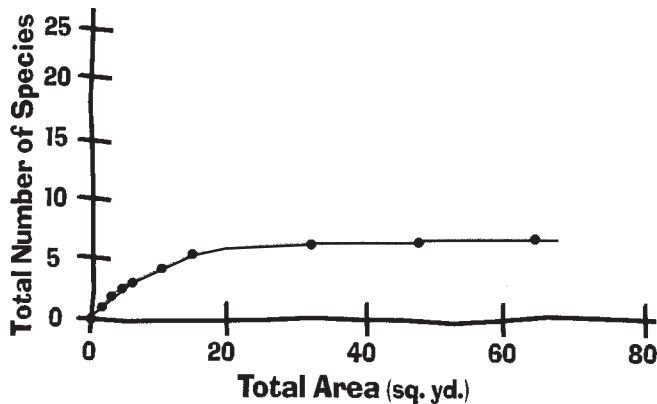

how the species in this habitat compare to ones in the habitat they explored. (There are fewer kinds of species in this habitat than in the one your group explored.) Draw a species-area curve that is very steep and levels off quickly at a high number of species. Ask the students how this compares to their schoolyard or habitat sample. (This habitat is very high in biodiversity, and the species seem to be tightly packed. A very small plot would show almost every species in the habitat. In the students' study

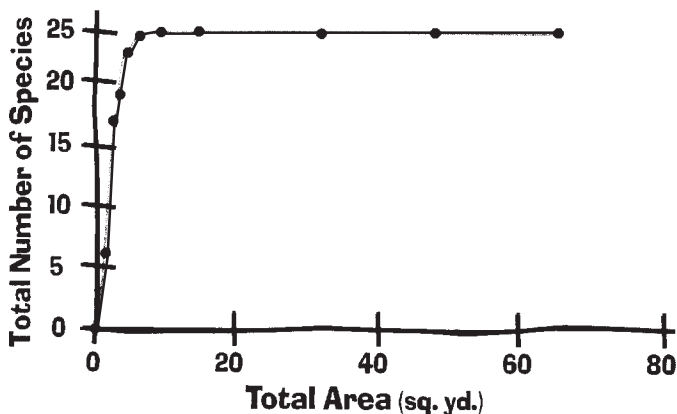

area, species are most likely more spread out, and there are probably fewer species.)

Species-area curves can also be used to look at one habitat over a long period of time to see how it changes. The students could look at their schoolyard at different times of year or after major disturbances such as big storms, insect population explosions or pesticide applications to see if these events changed the species-area connection.

- Discuss the species-area curve and conservation.** What does the species-area curve tell us about the problem of fragmentation? Since many curves level off at relatively small plot areas, does it mean that small habitat fragments will still contain most of the species that were in the larger habitat? Unfortunately not. Ask students if they can think of any reasons this isn't true. (Remind students that they looked at plots that were part of a larger habitat. They weren't looking at habitat fragments. If they've played "Island Hopping," they should remember that, in fragments, the edge effect will affect the number of species. It can change the habitat drastically and can cause a loss of more of the original species from the larger habitat. Also, have them think about the species that are lost at the large habitat sizes. In species-area curves, a few new species usually appear once the curve has leveled off. If we cut a habitat's size to a point where only a few of these species are lost, we may be losing some important species. We would probably lose species that require large areas, such as top predators, and these kinds of species often play important roles in habitats. Without them the habitat and species in it could change. Encourage the students to come up with other reasons there might be fewer species in a habitat fragment than the species-area curve shows there would be in a plot of the same size within a larger habitat.)

Adapted from "Quantifying Biodiversity" in *Global Environmental Change: Biodiversity* (National Science Teachers' Association, 1997).



## Activity 3-3 Space for Species (continued)

### WRAPPING IT UP

#### Assessment

1. Distribute a sheet of graph paper (with one-half inch to one-inch squares) to each student. The students are to be “developers” in charge of developing the land represented by the graph paper. One-fourth of the space will be used for housing, one-eighth of the space will be used for roads/parking, one-eighth of the space will be used for commercial development and one-fourth of the space will be used for industrial development. The remaining space (one-fourth of the total area) will be natural or landscaped area. Have the students design their development. They should label or color-code the design and, on the edges, explain why they used the land in the way they did.
  2. Have the students write an interview between a journalist for *BioTimes* magazine and an animal or plant whose habitat has gotten smaller because of development. The interview could include questions such as these: “Why are you leaving home?,” “Where do you think your travels will take you?,” “What are your special habitat needs?” and “How could people have reduced the damage this development has caused?” You might want to have the students do some research using the *Biodiversity of Illinois* CD-ROMs in advance to find out about the specific needs of their species. Afterward, students can share their interviews by taking turns playing the roles of journalists and species being interviewed.
- conomic benefits of the proposed project, and those opposed should cite some of the project’s potential environmental consequences, especially its potential effect on biodiversity. Can the two sides agree on a compromise?
2. Look for fragments of the same type of habitat in your community. You might find fragments of wetlands, prairies, beach-dune systems or woodlands. Then take your students on a field trip to investigate some different-sized fragments. Have them think of ways they could investigate the level of biodiversity in the fragments and then compare the fragments. You might ask a local park ranger, a naturalist or some other expert to help you organize the trip.

#### Portfolio

Part I has no portfolio documentation. For Part II, use the tables and graphs in the portfolio.

#### Extensions

1. Stage an in-class debate about a current development issue in your area. Have half the students in favor of developing the land and the other half against it. Those in favor of development should be able to cite some of the potential social and eco-

### Resources

- Jeffords, Michael R. 1992. *Biodiversity in Illinois: activities for young people*. Special Publication 13. Illinois Department of Natural Resources, Springfield, Illinois.
- MacArthur, Robert H. and Edward O. Wilson. 1967. *The theory of island biogeography*. Princeton University Press, Princeton, New Jersey. 203 pp.
- National Science Teachers Association. 1997. *Global environmental change: biodiversity*. National Science Teachers Association, Arlington, Virginia. 64 pp.
- National Wildlife Federation. 2001. Backyard Wildlife Habitat Program Internet site. [www.nwf.org/nwf/habitats](http://www.nwf.org/nwf/habitats).
- Quammen, David. 1996. *The song of the dodo: island biogeography in an age of extinctions*. Simon and Schuster, New York, 702 pp.
- United States Geological Survey. 2001. Northern Prairie Wildlife Research Center Internet site. [www.npwrc.usgs.gov/resources/](http://www.npwrc.usgs.gov/resources/)



One way to tell plants apart is by looking at their leaves.

general shape

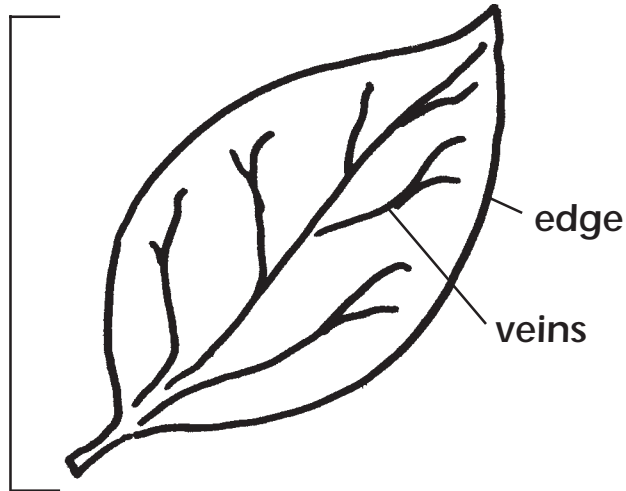

### Shapes



oblong



oval  
(elliptic)



lance-like  
(lanceolate)



egg-  
shaped  
(ovate)



inverted  
egg-shaped  
(obovate)



narrow  
(linear)



needle-  
shaped  
(acicular)

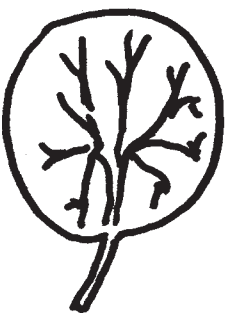

round  
(orbicular)

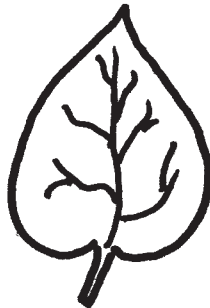

heart-shaped  
(cordate)

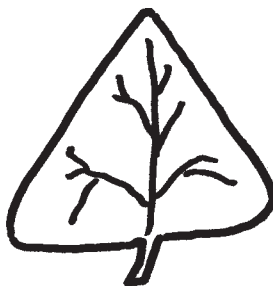

triangular  
(deltoid)

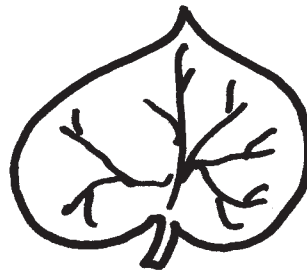

kidney-shaped  
(reniform)

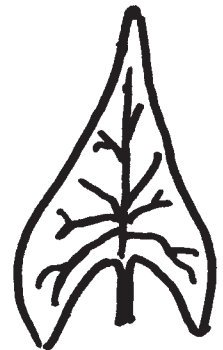

arrowhead-like  
(sagittate)



## Edges

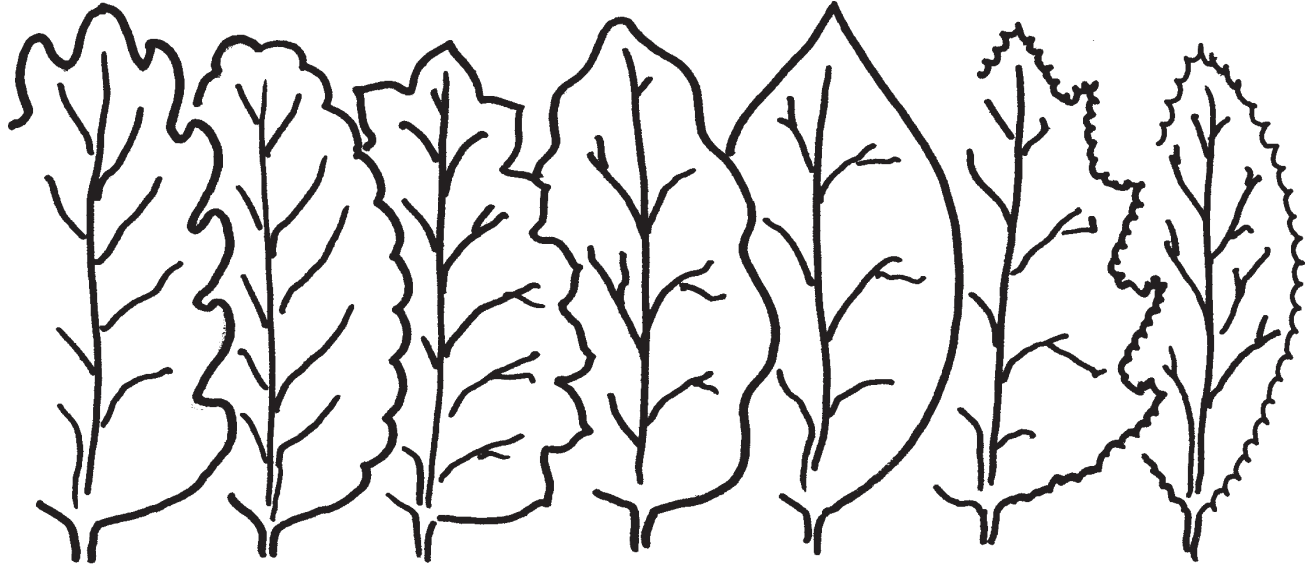

lobed

rounded  
(crenate)

tooth-like  
(dentate)

wavy  
(undulate)

smooth  
(entire)

double saw-like  
(double serrate)

saw-like  
(serrate)

## Veins (There are three main ways that veins are arranged on leaves.)

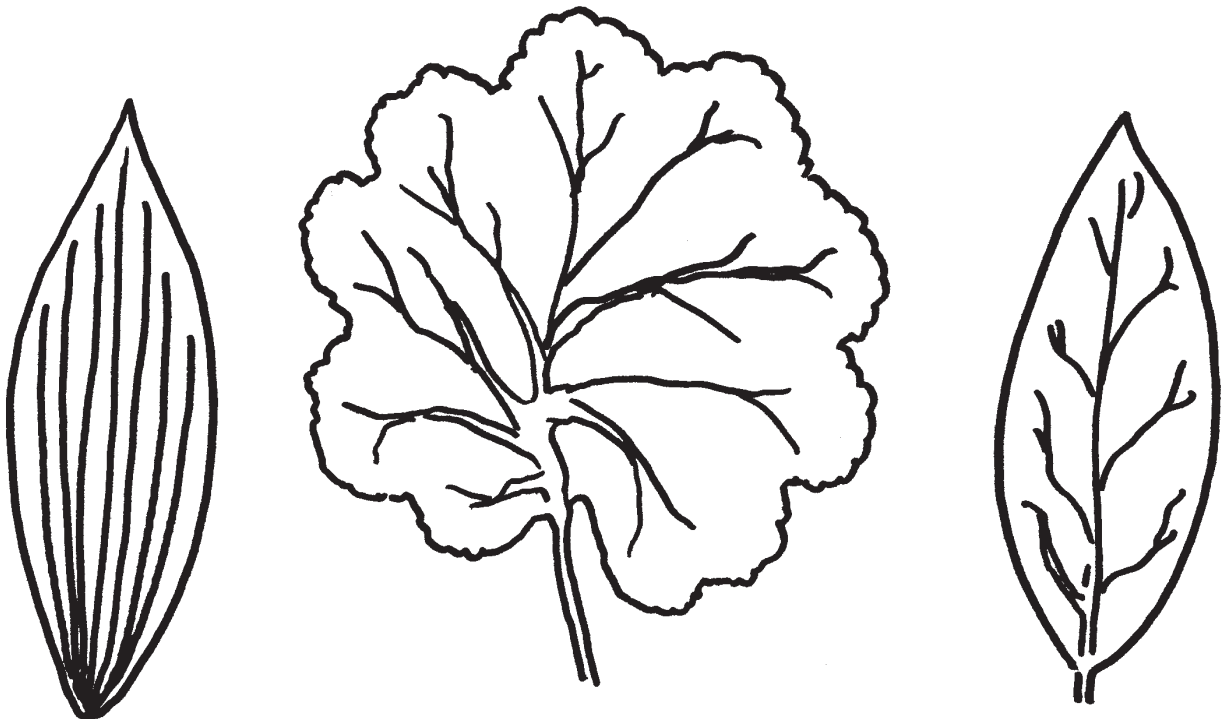

parallel

palmate

pinnate







## Student Page (optional) Space for Species

# Ovenbirds in Illinois Woodlands

Illinois contains some of the rarest forest habitat types on earth. Oak-hickory forests and beech-maple forests are only two of the many types which historically were found in Illinois. Originally, nearly 14 million acres of Illinois (38 percent) were forested. Today about 4.9 million acres of forest remain (14 percent). Illinois has lost two-thirds of its original presettlement woodlands. This decline was related to the dramatic increase in the human population combined with technological innovation and industrialization. In 1850 there were 850,000 people in the state. By 1950, the human population had increased to 8,700,000, and most of the original forests had been converted to residential, agricultural or commercial use. Illinois' remaining forested land has been fragmented, with large areas of forest relatively rare. The woodland areas which remain are like islands because cities, farms and residential and commercial areas surround them.

The ovenbird is a native warbler of the Illinois woodlands. The bird's nest is built on the ground, usually in an area among leaves. This bird requires large areas of cover for nesting. Ovenbird populations have declined as a result of increased nest predation and nest parasitism, particularly from the brown-headed cowbird. The

Forests in Illinois in 1820 and 1980

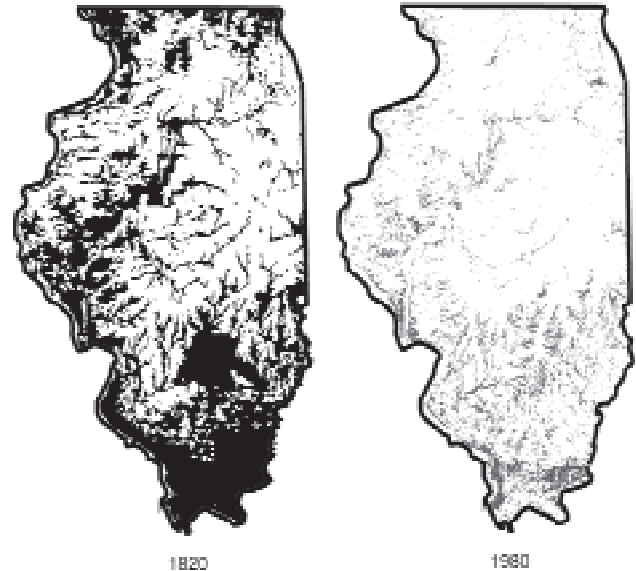

cowbird lays its eggs in the nests of other species, leaving its young for the other birds to feed and raise. In most cases, the cowbird eggs hatch faster than those of the host bird, and the cowbird chicks are larger and more aggressive than the host bird's chicks. Nest predation and nest parasitism increases are both a result of the fragmentation of Illinois woodlands. Since ovenbirds need a large woodland area for cover and protection of nests, they are in danger of becoming threatened or endangered when their habitat becomes fragmented. Studies of the ovenbird have helped to identify how much space they need. The graph on the next page is one of the graphs made to help organize the data collected. Look at the graph and then use it to answer the questions.

**“Endangered species are sensitive indicators of how we are treating the planet, and we should be listening carefully to their message.”**

*—Donald Falk, restoration ecologist*



## Ovenbirds in Illinois Woodlands

1. What is the title of the x-axis?
2. What is the title of the y-axis?
3. What is the chance of encountering an ovenbird in a 10-acre forest? In a 100-acre forest? In a 1,000-acre forest?

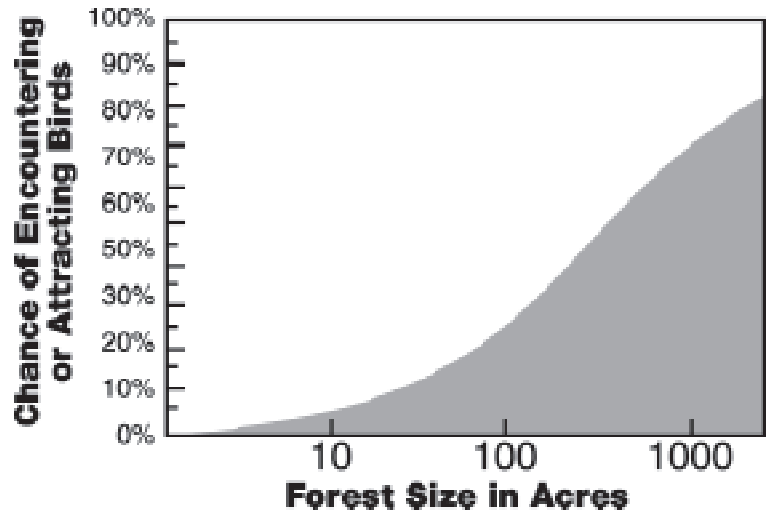

4. In general, did the researchers see more birds on large areas of land or small areas of land?
5. Based on this graph and additional research, the scientists concluded that large areas of land are needed for ovenbirds to survive. Why might small areas of land not be enough for ovenbirds to survive?
6. What title would you give the graph? \_\_\_\_\_

Graph obtained from United States Geological Survey Internet Site.  
<http://www.npwrc.usgs.gov/resource/othrdata/manbook/areareq.htm>



## Activity 4-1 Future Worlds

### AT A GLANCE

Build a pyramid to reflect personal priorities for the future. Investigate the way humans affect the natural world and discover how people are working to protect the environment and improve the quality of life in Illinois and on earth.

### OBJECTIVES

Express personal values by creating a personal vision for the future, especially as it relates to biodiversity. Reach group consensus using negotiation and conflict resolution skills. Discuss ways to arrive at the envisioned future. Analyze various approaches people in Illinois and around the world are taking to arrive at those futures.

### SUBJECTS

English language arts, social science, physical development and health

### SKILLS

gathering (brainstorming), organizing (prioritizing), analyzing (comparing and contrasting, discussing), interpreting (relating), presenting (articulating), citizenship (debating, evaluating the result of citizen action, planning citizen action, seeking consensus, working in a group)

### LINKS TO ILLINOIS BIODIVERSITY BASICS

#### CONCEPTUAL FRAMEWORK

values and beliefs; human values

#### VOCABULARY

conflict management, consensus, cultural diversity, global warming, invasive species, legislation, lichens, pollinating, racial justice, recycling, smart growth, stewardship, sustainable

#### TIME

two class periods

#### MATERIALS

copies of "Future Blocks," "Priority Pyramid" and "Making It Happen" for each student and for each group; scissors; glue or tape

#### CORRELATION TO ILLINOIS LEARNING STANDARDS

English language arts 4.B.2a, 4.B.2d, 4.B.3d, 5.A.2a, 5.A.2b, 5.A.3a, 5.A.3b, 5.C.2b  
social science 16.E.2c, 16.E.3b, 16.E.3c, 17.C.2c  
physical development and health 22.C.2, 22.C.3a, 22.C.3b

Some people look into our future and see a gloomy, inhospitable picture: a world that is less healthy, less safe, less diverse, more crowded and more polluted. While such portraits of doom may scare some people into action, they often have the opposite effect. Negative forecasts can become self-fulfilling prophecies, making people—especially young people—resigned and hopeless. This activity doesn't take a doom and gloom approach. Instead, it is designed to get your students to begin envisioning the future they want to inhabit and to learn about some real-life examples of how people in Illinois and around the world are working to make the future brighter.

### CHICAGO PLANS FOR THE FUTURE

In 1909, the Commercial Club of Chicago released "Burnham's Chicago Plan of 1909," one of the most influential and famous city plans in world history. Among its many provisions, that plan envisioned that the shore of Lake Michigan and a regional network of natural landscapes be protected as public parklands. Because of this foresight the Chicago region is ecologically healthier and more beautiful than it might have been. The air is cleaner, the water purer, there are more lakeside, parkland and forest preserves than if previous generations had not thought of the future. Therefore, what we do today helps determine what will happen in the future. Today the Northeastern Illinois Planning Commission, the City of Chicago and the Metropolis 2020 Project are working on projects to promote sustainable long-range planning for Chicago.

### BEFORE YOU BEGIN

#### Option #1

Make a copy of "Future Blocks," "Priority Pyramid" and "Making It Happen" for each student and for each group. Also provide scissors and glue or tape.

#### Option #2

Make a copy of the "Priority Pyramid" and "Making It Happen" for each student and for each group. Also provide scissors and glue or tape.



## Activity 4-1 Future Worlds (continued)

### WHAT TO DO

#### Option #1

##### 1. Make personal pyramids.

Give each student a pair of scissors and a copy of both the “Future Blocks” and the “Priority Pyramid.” Explain to the students that the blocks list 15 different possible conditions or components of their future world. Have the students read through all the conditions. Make sure they understand all the words in the blocks. Then ask them to think about which of these conditions they most want to have as part of their world when they’re 50 years old. Clean air? Cures for illnesses? Less crime?

Have the students rank all the components from the most important to the least important. Tell them to cut out the squares and arrange them in the pyramid. The most important component should be placed in the top box of the pyramid, the next two components on the next tier and so on. Once the students have arranged all the blocks, have them mark each block with the number that reflects the priority rating they gave it. (The priority rating numbers are one through five and correspond to the levels of the pyramid.)

##### 2. Create group pyramids.

Arrange the group into teams of four or five students. Have the students work together to come up with a single pyramid that represents the team’s priorities for the future. Everyone on the team should record the priority ratings each member of the group gave each block and compare them with his or her own personal pyramid.

##### 3. Suggest methods of reaching consensus.

It might not be easy for teams to reach consensus regarding their group pyramid. The students may discuss their reasons for various choices, prioritize options or try other methods of reaching a group decision. But if they get stuck or seem to be struggling to achieve a fair process, you may want to interrupt and share the following negotiation suggestions:



- a. Make a list of all the possibilities for the top spot. Are there more than three? If not, would everyone accept having his or her first choice listed among the top three? If that’s the case, students may have an easier time resolving the question of order.
- b. Give everyone a chance to present his or her choice for the top square of the pyramid and explain why it was chosen. The other students should listen closely to these explanations. A student who lists bees as a top priority, for example, may explain that she’s concerned with how bee pollination is critical for food production. Then other students who have pushed to place “enough food for all people” in the top spot may realize that they share the same concern as the “bees” proponent. This strategy may help narrow choices or change the nature of the discussion.
- c. If the students are still struggling to reach a resolution, have them take a time-out to reflect on the process. Are certain views being overlooked because some students are quieter or less stubborn than others? Is the group uncomfortable with anyone’s way of working out the problem? By reflecting on the dynamics of their discussion, the students may be able to isolate the obstacles to group consensus.



## Activity 4-1 Future Worlds (continued)

- d. Encourage each student to offer a solution that involves concessions on all sides. Afterward, the students should vote on which compromise package they prefer. If there are ties, hold a tie-breaking vote.
- e. Another consensus-building technique that could be used by the students is the “Nominal Group Technique” (see “Resources” for World Wide Web site).

### 4. Discuss the consensus process.

Bring the class back together and ask a representative from each team to present the team’s top three priorities to the class. Students can also summarize some of the conflicts the group experienced, as well as how the conflicts were resolved.

After each team has made a presentation, ask your students to reflect on the process of reaching consensus. Were they surprised by the disagreement among the members of the group about future visions? Did any of the students change their own views by talking with other group members? How do they think their team’s decision-making process might reflect some of the challenges that communities and societies face in working toward a positive future? (Make sure the students think about how hard it is to make positive changes for their community or the world, especially if people have different ideas about what they want and what they feel is important or right.) How much harder would it have been if the students had only enough time or money to ensure that their top two or three priorities would be achieved? (Again, you might want to point out the difficulties encountered by governments and organizations that are struggling to improve Illinois or the world when their resources are limited.)

### 5. Discuss solutions.

Ask the students if they have ever thought much about how they want the world to look in 50 years. Is simply thinking about dreams for the future enough to make them come true? If not, is it valu-

able? Why or why not? Ask students to look over the blocks in their pyramids. Can they think of anything they or other people are doing to ensure that these things will happen in the future? Are there other things they would add to the pyramid?

### 6. Hand out “Making It Happen” sheets.

Tell the students that they now have a two-part assignment. First, they should compare their personal pyramid to the pyramid their group created. How do they explain the similarities and differences? How do they feel about the process they went through? How do they feel about the result?

Next, hand out copies of “Making It Happen.” Ask the students to read about each of the projects and choose three approaches that they think best achieved the top three priorities set by their team’s pyramid. (See “Making It Happen Answer Sheet.”) They should write one or two sentences explaining how each of the projects they picked is working to achieve the specified objectives and what they think each project’s strongest and weakest aspects are.

### 7. Have a wrap-up discussion.

After students have completed the assignment, make a list on the board of every priority square that made it onto a group’s top-three list. Then ask the students to describe the projects they matched to those squares. Did people pick different projects to achieve the same goal? Why? Do they think any of the actions address more than one objective?

Discuss possible strengths and weaknesses of the approaches listed. Do students think local projects are more effective than passing national legislation? Do they prefer preventive approaches (like education) or fix-ups (like pollution-cleaning technology)? Point out that there are a lot of ways to bring change to the world—such as educating people, passing legislation and developing innovative technologies or strategies.



## Activity 4-1 Future Worlds (continued)

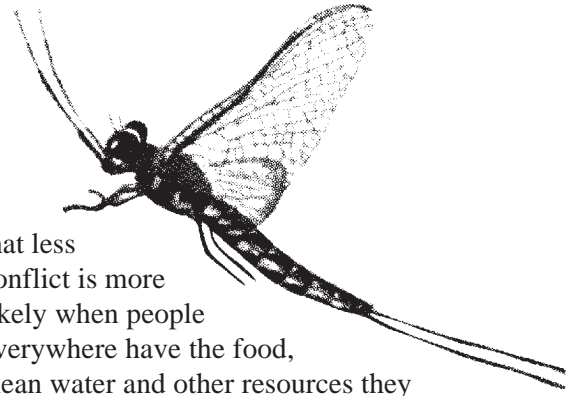

### Option #2

#### 1. **Brainstorm about conditions for the future.**

Ask the students to think about what they want the future to be like in Illinois. What things or conditions do they want when they're adults or when their own children are grown up? List their ideas on the chalkboard.

#### 2. **Make personal pyramids.**

Give each student a copy of the "Priority Pyramid." Explain to the students that they need to fill in the pyramid with the conditions they want to see in Illinois in the future, ranking the conditions from the most to the least important. The most important condition should be placed in the top box of their pyramid, the next two conditions on the next tier, and so on. The students can use the ideas the group generated and add their own ideas.

#### 3. **Share personal pyramids and create group pyramids.**

Arrange the class into groups of four or five students. Have the students share their pyramids with their team. Then have them work together to come up with a single pyramid that represents the team's priorities for the future. Everyone on the team should record the arrangement the group comes up with.

#### 4. **Suggest methods of reaching consensus.**

See step three in Option #1.

#### 5. **Discuss the class process.**

Bring the group back together and ask a representative of each team to present the team's top three priorities to the class. Students can also summarize some of their group's conflicts and how the conflicts were resolved.

As the groups present their pyramids, discuss with them the implications of each of their top three priorities. What kinds of things are entailed in each of their conditions? For example, if they chose less conflict as a condition of the future, they should see

that less conflict is more likely when people everywhere have the food, clean water and other resources they need for a satisfying and productive life. As the students discuss each condition, they should come to realize that everything they selected can be traced, at least in part, to a healthy environment.

When all the teams have presented their results, ask your students to reflect on the process of reaching consensus. See step 4 in Option #1.

#### 6. **Discuss solutions, hand out "Making It Happen" sheets and have a wrap-up discussion.**

See steps five through seven in Option #1. Adapt the discussion to fit the different groups' pyramids.

### MAKING IT HAPPEN—Answer Sheet

Each of the pyramid "blocks" can be matched with at least one of the "Making It Happen" examples. Here is a quick reference sheet for your use, but your students might make other connections that also work.

**Bee Good to Your Lips:** bees

**Now, That's More Lichen It!:** clean air

**Beautifying Neighborhoods:** less crime

**A New Way of Doing Business:** less trash

**City Sewer Savvy:** clean water

**Ending the Conflict:** less conflict

**Restoring the Tallgrass Prairies:** natural lands/open spaces

**Concerned Citizens Unite:** racial justice and diversity

**The Power of Plants:** cures for illnesses

**Songbirds on the Net:** environmental education

**Planes, Trains & Automobiles:** smart growth



## Activity 4-1 Future Worlds (continued)

- Poached Eggs:** healthy fish populations  
**A New Crop of Farmers:** enough food for all people  
**Stewardship Volunteers Hard at Work:** fewer invasive species  
**Populations at Risk:** otters, bobcats and eagles

### WRAPPING IT UP

#### Assessment

1. Use both “Priority Pyramid” worksheets and observed student interaction for the assessment. Inform the students that they will be evaluated on these assignments.
2. Before constructing pyramids, ask your students to write about their top priority for the future and the reasons it is most important to them. Use the following journal starter: “When I imagine a sustainable future, I think of . . .”
3. Have each student write a newspaper article on an imaginary, but realistic, event that addresses the number one concern from his or her personal pyramid.

#### Portfolio

The personal “Priority Pyramid” can be used in the portfolio.

#### Extension

##### 1. Future logs

Have the students keep a “future log” for a day. Explain that the point of the log is to focus on how their activities, behaviors and even their thoughts can affect the future. In the log they should simply write down what they do, think, say and so forth—just as they would in a diary. In the log, however, they should use “bullet style” instead of paragraphs. At the end of the day, they should think about and write down how each “bullet” affects the world around them, either positively or negatively, and what the ramifications could be for the future. For example, if a bullet reads, “Had a PBJ sandwich for lunch, with a bag of chips and ginger ale,” the student might write down the fact that he or she recycled the soda can—a positive action for the future that saves natural resources and landfill space. But the student might also mention throwing away his or her lunch bag instead of using it again, or instead of bringing lunch to school in a heavy-duty container that can be used over and over. Have the students add ways that they can do more to create a positive future by changing their daily actions.

##### 2. Class action project

Determine the block that holds the highest priority for the class. Have students brainstorm a range of activities that might be appropriate related to this block. Do the consensus building activity/nominal group technique as a whole class to prioritize a class action that they would carry out. Then have students implement the goal by creating the “I Make a Difference Club.”





## Activity 4-1 Future Worlds (continued)

### Resources

Chicago Environmental Network. 2001. Internet site.

<http://www.cen.nidus.net>

Chicago Wilderness. 2001. *Atlas for Biodiversity and Biodiversity Recovery Plan*. Internet site.

<http://www.chiwild.org>

Ford Motor Company. 2001. Internet site.

<http://www.ford.com>

Illinois Department of Natural Resources. 2001.

Internet site. <http://dnr.state.il.us>

Illinois Department of Natural Resources. 2001.

Division of Education Internet site.

<http://dnr.state.il.us/lands/education>

Illinois Department of Natural Resources. 2001.

Illinois Natural History Survey Internet site.

<http://www.inhs.uiuc.edu>

Illinois Department of Natural Resources. 2001.

Illinois State Geological Survey Internet site.

<http://www.isgs.uiuc.edu>

Illinois Department of Natural Resources. 2001.

Illinois State Water Survey Internet site.

<http://www.sws.uiuc.edu>

Illinois State Board of Education. 2001. Illinois' Green

Door Internet site. [http://www.isbe.state.il.us/](http://www.isbe.state.il.us/ilgreendoor)

[ilgreendoor](http://www.isbe.state.il.us/ilgreendoor)

Kellert, Stephen. 1996. *The value of life: biological*

*diversity and human society*. Island Press,

Washington, D.C. 263 pp.

Metropolis 2020. 2001. Internet site.

<http://www.chicagometropolis2020.org>

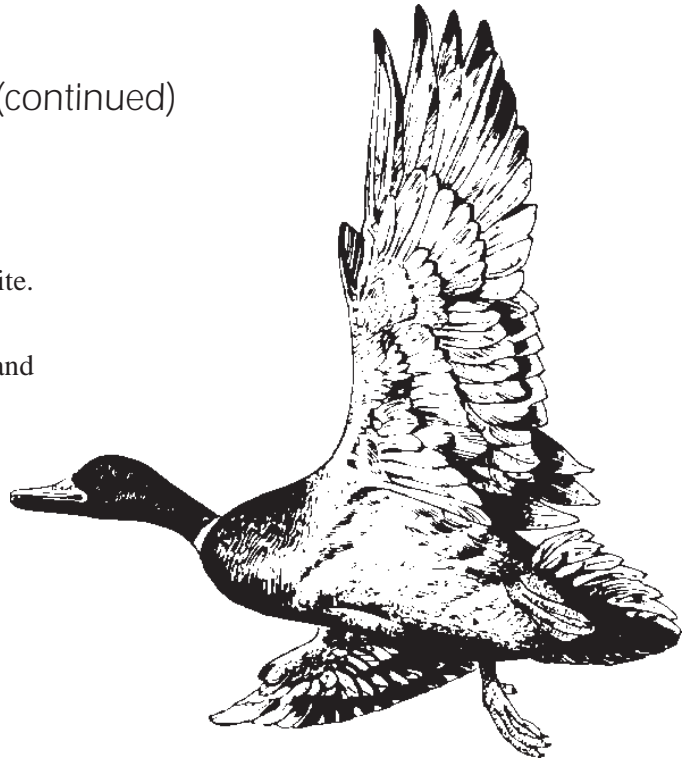

Migration Information School Tracking Network. 2001.

Internet site. <http://www.gsenet.org/library/23wld/mist-net.txt>

National Recycling Coalition. 2001. Internet site.

<http://www.nrc-recycle.org>

Nominal Group Technique. 2001. Internet site.

<http://www.institute.virginia.edu/services/csa/nominal.htm>

Northeastern Illinois Planning Commission. 2001.

Internet site. <http://www.nipc.cog.il.us>

Owen, Oliver. 1993. *Eco-solutions: it's in your hands*.

Abdo and Daughters, Edina, Minnesota. 64 pp.

Solid Waste Agency of Lake County, Illinois. 2001.

Internet site. <http://www.swalco.org>

Wilson, Edward O. 1992. *The diversity of life*. Belknap

Press, Cambridge, Massachusetts. 424 pp.



## MAKING IT HAPPEN

### Bee Good to Your Lips

A company called Burt's Bees purchases beeswax for the production and sale of lip balm. That's good news for beekeepers across the United States who use the income from beeswax sales to better manage their honey bees.

Most people don't know it, but honey bee populations have declined in the last few years. If the trend continues, the cost to farmers could be billions of dollars a year. The reason? Bees are very important for pollinating crops. Saving bees will require changes on many fronts—from reducing pesticide use to saving bee habitats.



### Now, That's More Lichen It!

Forest scientists need lots of high tech instruments to measure air quality, right? Well, traditionally, they have had to spend thousands of dollars a year to buy and operate electronic air-monitoring instruments. But now they have a new, more cost-effective instrument: lichens! Lichens are actually two organisms in one: a fungus and either an alga or a bacterium. Together these "partners," which grow on rocks and other surfaces, can live in some of the harshest environments on earth—including the frigid reaches of Antarctica. Tough as they are, though, lichens are very sensitive to air pollution. A botanist discovered how certain lichens

respond to three different air pollutants—ozone, sulfur dioxide and nitrogen oxide. By monitoring where lichens are growing and how healthy they are, scientists can draw conclusions about the presence of these pollutants in an area. And many forest scientists are doing just that!

### Beautifying Neighborhoods

Want to help be a crime buster in your community? Follow the "Clean and Green" program example, a very successful Chicago program of community cooperation. The Chicago Alternative Policing Strategy or as it is better known the "CAPS program" co-sponsors "Clean and Green" a citywide cooperative effort to clean up Chicago neighborhoods. The Chicago Police Department, the Streets and Sanitation Department and area communities work together to spruce up neighborhoods from April to October, by clearing debris, planting flowers and implementing creative strategies to beautify inner city neighborhoods. The City provides tools, materials and pick up of trash and debris while the neighborhoods supply the volunteers. All 25 policing districts in Chicago have encouraged adoption of the "Clean and Green" program because it helps communities work on cooperative projects which in turn helps cut down on crime. It brings area residents and city workers together to improve neighborhood conditions in many ways. By getting people to work together in programs like "Clean and Green," they learn to work for positive improvements and take pride in their neighborhoods.



## MAKING IT HAPPEN

### A New Way of Doing Business

Taking recycling to a new level is Ford Motor Company's goal for the next millennium. The company began recycling efforts in 1991, and the National Recycling Coalition has since awarded Ford the "Recycling Leadership Award" for efforts to recycle the company's own waste and for using recycled materials in auto production. During the 1990s, they used more than four billion pounds of recycled materials worldwide. Ford Motor Company uses plastic soda bottles and computer casings in automobile grills, reprocessed carpet in fan shrouds, auto battery casings in new splash shields and used tires in brake pedals and floor mats. Active recycling programs are in place in their facilities, like their paper recycling and reduction effort. North American plants alone are recycling 450 million pounds of waste each year, which has saved more than \$8 million annually for the company.



### City Sewer Savvy

Kids around the country are spray painting messages on city streets. Are they breaking the law? No way! Working with local governments, they're helping to save their local rivers, streams and bays. By painting "DON'T DUMP: DRAINS TO LAKE OR STREAM" (or other waterway, depending on where they live) on city storm

drains, they're reminding residents that pollutants dumped down these drains flow into local waterways. And those waterways are important habitats for wildlife—not to mention critical fishing spots and valued places for recreation.

### Ending the Conflict

Throughout history, many wars have been fought over natural resources such as land, forests and water. While problems regarding resources still exist, a number of groups are trying a new approach, called conflict management, to end conflicts before they escalate into fighting. In conflict management, disagreeing groups get together with an impartial party to discuss their concerns. Each side is asked to listen closely to the other side. The impartial party helps to clarify what each side is asking for. In many cases, once groups get beyond their anger and frustration, they find that their needs can be met. One way conflict management has been used is to find workable solutions for the issue of recreational water use. Jet ski and speed-boat users often are in direct conflict with canoeists and fishermen. Zoning for use of time and space on water bodies is often an effective compromise.





## MAKING IT HAPPEN

### Restoring the Tallgrass Prairies

The Midewin lands (southwest of Chicago) are a piece of the 36 million acres of prairie that once existed in Illinois. Beginning in the 1830s, the rich prairie soils were plowed by settlers, who wanted to farm the land. Later, with World War II looming, the U. S. Army commandeered many thousands of acres in Midewin for use as an ammunition plant. That use continued for more than 50 years, until the Army abandoned the land and environmentalists succeeded in winning approval for an ambitious plan to restore Midewin. Much planning, cooperation and hard work have gone into restoring this prairie. As part of the plan, the U. S. Forest Service is growing acres of native plants on parts of the site. The seeds of those plants are harvested and planted to create this new "prairie forest."

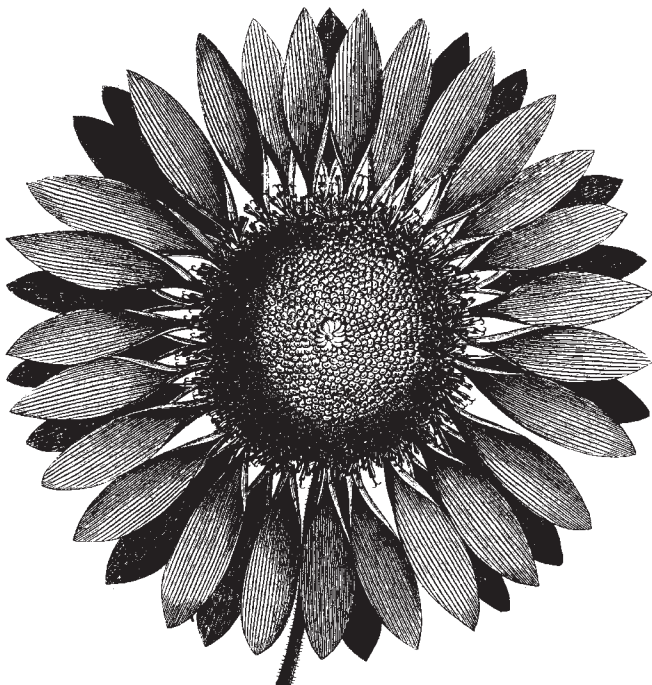

### Concerned Citizens Unite

Altgeld Gardens is a Chicago Housing Authority community of about 10,000 people on the southeast side of Chicago. It is located in the center of a toxic doughnut of heavy industry and waste dumps. A mammoth water treatment plant that contains acres of waste-drying areas is present as are more than 100 industrial plants and 50 active or closed waste dumps. The area contains 90 percent of Chicago's landfills. Altgeld Gardens, whose residents are virtually all African-American, was built on the edge of an old industrial dump. Today airborne pollutants from this industrial area cause a host of ailments: watery and burning eyes; skin rashes; conjunctivitis; asthma; and other respiratory illness. Residents suffer from high rates of bladder and lung cancer. A citizens group, People for Community Recovery, working with other environmental groups, like the Southeast Environmental Task Force, decided to fight the area's powerful industrial companies. They have won some key battles. In 1998, an incinerator was shut down, and plans to build another landfill were blocked.

### The Power of Plants

How did people treat illness and disease before there were grocery stores and pharmacies? They looked to nature to treat their symptoms. Many native plants in Illinois were used for food and for their healing properties. Bloodroot, a spring woodland wildflower, can be used to treat respiratory illnesses, including bronchitis, asthma and laryngitis. The compound salicin, closely



## MAKING IT HAPPEN

related to aspirin, was discovered in the bark, leaves and buds of willow trees. Native medicinal plants, and the knowledge handed down by native cultures, is very valuable today, as we continue to find ways they can help control diseases.

### **Songbirds on the Net**

A student in Illinois logs onto the Internet and enters her observation: yellow warbler spotted today! She's one of many students participating in an environmental education program called MISTNET (Migration Information Songbird Tracking NETwork). Participants track the migration of several songbird species between their winter habitats in the tropics and their summer habitats in the United States and Canada. The students are helping scientists monitor songbird populations, which are decreasing because of habitat loss. The students are learning a lot about birds and migration, and they're participating in a project that gives a whole new meaning to the phrase "web of life."

### **Planes, Trains and Automobiles**

Smart growth is a new name for an old idea in Chicago. Before the automobile was available, people had to live near their work, shopping centers and schools. This large city was once a small trading town on the only water connection between Lake Michigan and the Mississippi River. When railroads came through the Midwest, the city began to grow. City planners like

Daniel H. Burnham and Frederick Law Olmstead developed ways to preserve the beauty of Chicago while planning for its transportation and business growth. For example, the Burnham Plan of 1909 addressed planning for roads and buildings in Chicago as well as parks and beaches along Lake Michigan. Today, balancing the population growth of Chicago with the expansion of buildings, roads, airports, sewers and utilities, has impacted our natural resources, resulting in air and water pollution, global warming and losing natural areas to development. A new movement called "Smart Growth" promotes ways of building and rebuilding neighborhoods and incorporates long-term planning practices to protect the area's natural resources.

### **Poached Eggs**

Fossil records show that paddlefish have been swimming in Illinois waters since before dinosaurs ruled. Recent declines in the number and range of paddlefish have been caused by over-harvesting, water pollution, sedimentation of gravel areas needed for spawning and the construction of dams, altering natural water flow, water levels and water temperature and blocking migration and access to spawning grounds. Poaching (illegal killing) of paddlefish for their eggs creates other problems. The eggs can be used for caviar, although they may contain chemical contaminants, making them unsafe to eat. All these factors have made survival very difficult for these ancient creatures.



## MAKING IT HAPPEN (continued)

Today, people throughout the Midwest are working hard to save the paddlefish. Since the fish travels great distances, fishermen and federal, state and tribal management agencies are cooperating to protect it. Commercial harvest and snag fishing of paddlefish is banned in most Illinois waters. Conservation police officers are working to catch poachers. Other projects that are helping paddlefish populations include stocking young paddlefish into water bodies, using radio transmitters to track the movement and habitat use of individual paddlefish and removal of some dams.

### A New Crop of Farmers

Throughout Illinois farmers are working to protect and improve the quality of their land. Some have begun to practice "sustainable agriculture." Sustainable agriculture considers weather patterns, soil type, ecoregions and crop requirements when making decisions. This type of farming can reduce the need for pesticides and large farm machinery, while lowering fuel costs and conserving fuel. A variety of food types may still be grown. The practice also benefits wildlife and water quality. The U. S. Department of Agriculture's Sustainable Agriculture Research and Education program and the Illinois Department of Agriculture also support and promote sustainable agriculture.

### Stewardship Volunteers Hard at Work

Illinois has many plant and animal species that have been brought here from all over the world,

escaped from cultivation or captivity and now grow freely in the wild. These new residents are known as nonnative or exotic species. These organisms often grow and/or reproduce faster than native species and have few or no natural control methods, like predators. In many cases these organisms replace native species. Volunteers throughout the state are working to eliminate some nonnative species. They help restore natural areas that have been overburdened with nonnative species, such as kudzu and purple loosestrife.

### Populations at Risk

When you think of a lifesaver, chances are good that you don't think about a law. But the Endangered Species Act, passed in 1973, is a law developed to protect all species in the United States from extinction. Each state has also adopted its own endangered species law to protect species that may be in trouble in the state but not throughout the nation. Using scientific information, federal and state agencies determine which species are threatened or endangered. Then they develop plans to help the species recover. According to the U. S. Fish and Wildlife Service, populations of more than half of the 1,177 plants and animals the Act protects in the United States are stable or growing. The most heralded success of the Act is the recovery of the bald eagle population with a tenfold increase in just 25 years. It also has aided the survival of the white fringed orchid, the peregrine falcon and the Illinois chorus frog.



Student Page  
Future Worlds (continued)

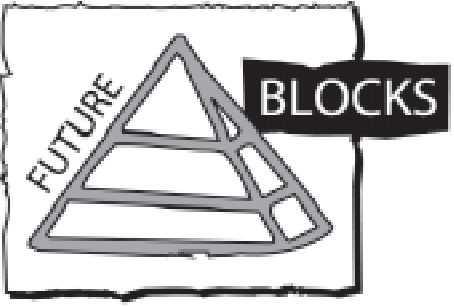

environmental education



clean water



natural lands/  
open space



less conflict



clean air



racial justice  
and diversity



less crime



cures  
for  
illnesses



less trash



enough  
food  
for all  
people



healthy fish  
population



bees



fewer invasive species



smart growth



otters,  
bobcats  
and  
eagles



Student Page  
Future Worlds (continued)

A grid of 20 rectangular boxes with torn edges, arranged in four columns and five rows. The boxes are intended for students to write their future world scenarios.







## Activity 4-2 Career Moves

### AT A GLANCE

Read profiles of people who work in biodiversity-related professions in Illinois. Conduct interviews of people in your community with similar occupations.

### OBJECTIVES

Describe various careers related to biodiversity. Identify, analyze, and discuss biodiversity-related careers held by members of the community and people who have made significant contributions to the fields of science, technology and the environment. Conduct a successful interview.

### SUBJECTS

English language arts, science, social science

### SKILLS

gathering (reading comprehension, interviewing), analyzing (questioning), interpreting (summarizing), presenting (public speaking)

### LINKS TO ILLINOIS BIODIVERSITY BASICS CONCEPTUAL FRAMEWORK

investigators in different fields; all sectors of society

### VOCABULARY

See individual career profiles for possible unfamiliar words.

### TIME

two to three class periods

### MATERIALS

copies of "Tips and Tricks of Interviewing," "Sample Interview Questions" and "Career Profiles" for each team of students

### CORRELATION TO ILLINOIS LEARNING STANDARDS

English language arts 5.B.3a, 5.C.3c  
science 13.B.2c, 13.B.3b, 13.B.3c  
social science 17.C.2c

Protecting biodiversity can take many different forms. Some people, for example, focus on minimizing their own impact on the environment by shopping carefully, recycling as much as possible, avoiding the use of harsh chemicals on their gardens and in their homes, installing low-flow shower heads and other actions. Other people take more of a community-action approach, getting involved in local projects designed to protect or enhance the environment. And some people devote much of their lives to biodiversity and its protection through their choice of career.

Here's a way to introduce your students to people with careers linked to biodiversity issues. Your students will find out what people are doing in Illinois, who in the local community works in a biodiversity-related field, and what kind of education is needed for particular careers. They might also discover some ways they can use their own interests and skills to get involved with biodiversity issues.

## BEFORE YOU BEGIN

Make one copy of the "Career Profiles" and cut out each profile. Make one copy of "Tips and Tricks of Interviewing" for each student. (You may also make copies of the "Sample Interview Questions" for each team.)

## WHAT TO DO

### 1. Divide the group into pairs and introduce the activity.

Discuss with your students ways people make contributions to issues they care about (volunteering, trying to live in a way that's consistent with their values, helping others to become involved and so on). Point out that one way people contribute is by choosing a career related to an issue that's important to them. Explain that they'll be conducting interviews to learn about people whose careers are related to environmental issues, including biodiversity.



## Activity 4-2 Career Moves (continued)

### 2. Hand out the “Career Profiles” (one profile per pair) and explain the project.

Give the students time to read the profile. Then tell them that each pair of students will be working together to locate and interview someone in the community who has an occupation similar to the one in the profile they read.<sup>1</sup> The work that the community member does may differ from the work of the person profiled, but the occupation should be the same or similar. For example, the journalist in the “Journalist with a Passion” profile focuses on television journalism. But the students may find an environmental journalist who writes for a local newspaper. (If the students are unable to find someone with an occupation similar to the one in their profile, they can choose another occupation from the “Career Corner” list.)

Explain that the students can conduct their interviews either over the phone, by e-mail or in person. (Be sure to allow time for coordinating the students’ use of a phone.) Afterward, the students will be using the information they’ve gathered to develop a creative presentation.

### 3. Discuss ways to locate people to interview.

Your students may know people in the community whom they can interview, or they might have ideas about where to start looking. Write their ideas where everyone can see them, then add the following suggestions:

#### **federal, state, regional, county and municipal levels of government**

- local offices of federal agencies and departments (such as the U. S. Environmental Protection Agency, the U. S. Forest Service, the U. S. Fish and Wildlife Service and the Natural Resource Conservation Service)
- state agencies (such as the Illinois Department of Natural Resources, Illinois Environmental Protection Agency, Illinois Department of

Agriculture, Illinois Department of Commerce and Community Affairs, Illinois Pollution Control Board, Illinois Department of Public Health)

- regional forms of government (such as the Northeastern Illinois Planning Commission)
- county government and agencies (such as forest preserve districts, park districts, Association of Illinois Soil and Water Conservation District offices)
- municipal (such as park and recreation departments, public works offices and recycling centers)

#### **private business, not-for-profit foundations, volunteer groups and professional organizations**

- local zoos, aquariums or natural history museums
- nature centers
- local or regional environmental organizations
- professional development organizations related to a particular career
- universities and colleges
- community newspapers
- businesses with a strong environmental focus
- companies or stores that provide alternatives to environmentally harmful products (such as supermarkets that specialize in environmentally-sensitive products)
- organizations that have successfully integrated environmentally-sound programs into their operations (such as office-wide recycling or natural area restoration work)

Have each team write down a list of the people or organizations they’ll contact. Tell them to rank the list so that they contact their most likely resources first. (You may want to check their lists to make sure they’re on the right track and that several groups aren’t planning to contact the same organization.)

<sup>1</sup> An alternative to having pairs of students setting up and conducting the interviews is to invite a professional, or a panel of professionals, to the class. The class as a whole could come up with interview questions in advance, and students could take turns asking the questions.



## Activity 4-2 Career Moves (continued)

### 4. Review how to set up interviews.

Ask your students to describe or act out what they would say on the telephone if they called an organization to get the name of someone to interview. The following is an example of one approach they might take:

"Hello, my name is \_\_\_\_\_. I'm a student at \_\_\_\_\_, and I'm doing a class project that involves interviewing people about their careers. I'd like to interview a(n) \_\_\_\_\_. Do you know of somebody I might be able to interview? If not, is there anyone else available who might be able to suggest someone? What is your name, please? Thank you very much."

Next ask your students to describe or act out how they would ask a particular individual for an interview. Here's one approach:

"Hello, my name is \_\_\_\_\_. I got your name from \_\_\_\_\_. I'm a student at \_\_\_\_\_, and I'm doing a class project that involves interviewing people about careers related to biodiversity and the environment. Would you be willing to be interviewed? When would be a good time? Thanks very much for agreeing to talk with me."

Remind the students that they'll need to discuss a suitable time and place if the person agrees to be interviewed. They should also ask whether he or she would like to have a copy of the questions in advance. If the person does not wish to be interviewed, remind your students to thank him or her for speaking with them.

### 5. Develop interview questions and review "Tips and Tricks of Interviewing" (page 160).

Write on the board or hand out the "Sample Interview Questions." Have your students brainstorm a list of general questions they think would be appropriate to ask during their interviews. Write their ideas on the board, then help the class organize and edit the list. Encourage the students to come up with open-ended questions rather than "yes or no" questions. The students can use the basic list as a guide when conducting the interviews. Each pair should also come up with additional questions that are specifically related to the career of the person they're interviewing.

Next hand out copies of "Tips and Tricks of Interviewing." Carefully explain each tip while the students follow along.

If you'd like to give your students practice conducting interviews, form groups of four by bringing two pairs together. Then have each pair develop five questions to ask the other pair. You might want to have one person in each pair ask the questions while the other takes notes, or you might have the two alternate so each student can practice asking questions and taking notes. You might also encourage your students to practice by interviewing their parents or neighbors.

### 6. Conduct the interviews.

Help your students determine the best way to conduct the interviews. In some cases, the interviewees might be able to come to the school. In other cases, they might be able to meet with the students after school at their place of work or another convenient location. And in some (perhaps most) cases, interviews might take place over the telephone or by e-mail.

### 7. Briefly discuss interviews and career options.

After the students have completed the interviews, give them time to discuss the process and share their experience with the group. Was the process easier or



## Activity 4-2 Career Moves (continued)

harder than they expected? Why? Which careers didn't they know about before? Which careers sounded the most interesting, and why? What did they learn that surprised them?

Some students might have been surprised to find out that a person doesn't need to have a career directly related to the environment to be able to make a difference. Point out that more and more careers include aspects of environmental protection. And many corporations are hiring people with environmental backgrounds. For example, 20 years ago it would have been hard to find an ecologist working for an electric power company, but today many ecologists are helping such companies make sure they aren't harming the environment.

### 8. Develop and give presentations.

Have each pair put together a brief presentation focusing on the career of the person they interviewed. Encourage the students to create posters, visual aids or use other multi-media techniques to explain and illustrate how the career they're highlighting relates to biodiversity. Make sure that both students in each pair are involved in the presentation. (You might also want the students to write their interview as an article.) Once the presentations are finished, ask students for their reactions to the careers they learned about.

## WRAPPING IT UP

### Assessment

1. Collect the students' interview notes. Compare the information gathered in the interview with the information included in the presentation.
2. Have the students write up their notes as an interview-style article.
3. Let the students use the following as a journal starter: "The jobs I found most interesting are . . . because . . ."

### Portfolio

Interview notes can be used in the portfolio.

### Extensions

1. Have the students research other careers that are related to biodiversity conservation or environmental protection. (See the list entitled "Career Corner" for ideas.) They can use their research as a launching pad to write career profiles of people in the community, conduct more interviews, create displays or write reports.
2. Have students investigate the life and career of someone who was instrumental in influencing the fields of science, the environment or technology. Identify how his/her contributions influenced the lives and careers of people today.

---

*"One of the greatest challenges of conservation is preserving the incredible diversity of life while ensuring that people's needs are respected and protected."*

*—Henri Nsanjama, Vice President  
WWF's Africa and Madagascar Program*



## Activity 4-2 Career Moves (continued)

### Resources

- Carwell, Hattie. 1977. *Blacks in science: astrophysicist to zoologist*. Exposition Press, Hicksville, New York. 95 pp.
- Chicago Environmental Network. 2001. Internet site. <http://www.cen.nidus.net>
- Chicago Wilderness. 2001. *An atlas of biodiversity* Internet site. <http://www.chicagowilderness.org>
- Hamilton, John and Stuart Kallen. 1993. *Eco-careers: a guide to jobs in the environmental field*. Abdo and Daughters, Edina, Minnesota. 32 pp.
- Illinois Department of Natural Resources. 1999. *Biodiversity of Illinois, volume I: aquatic habitats*. Illinois Department of Natural Resources, Springfield, Illinois. CD-ROM.
- Illinois Department of Natural Resources. 1999. *Natural resources careers*. Illinois Department of Natural Resources, Springfield, Illinois. Poster.
- Illinois Department of Natural Resources. 2000. *Biodiversity of Illinois, volume II: woodland habitats*. Illinois Department of Natural Resources, Springfield, Illinois. CD-ROM.
- Illinois Department of Natural Resources. 2001. *Biodiversity of Illinois, volume III: prairie and edge habitats*. Illinois Department of Natural Resources, Springfield, Illinois. CD-ROM.
- Illinois Department of Natural Resources. 2001. Division of Education Internet site. <http://www.dnr.state.il.us/lands/education/classrm/classrm.htm>
- Illinois Department of Natural Resources. 2001. Internet site. <http://dnr.state.il.us>
- Illinois Department of Natural Resources. 2001. Illinois Natural History Survey Internet site. <http://www.inhs.uiuc.edu>
- Illinois Department of Natural Resources. 2001. Illinois State Water Survey Internet site. <http://www.sws.uiuc.edu>
- Koebner, Linda, Sokolow, Jane E. S., Grifo, Francesca T. and Sharon Simpson, editors. 1998. *Scientists on biodiversity*. American Museum of Natural History, New York. 156 pp.
- Matyas, Marsha Lakes. 1997. *Women life scientists: past, present and future*. The American Physiological Society, Bethesda, Maryland. 338 pp.
- Northeastern Illinois Planning Commission. 2001. Internet site. <http://www.nipc.cog.il.us>
- Solid Waste Agency of Lake County, Illinois. 2001. Internet site. <http://www.swalco.org>
- Triana, Estrella M., Abbruzzese, Anne and Marsha Lakes Matyas. 1992. *Stepping into the future: Hispanics in science and engineering*. American Association for the Advancement of Science, Washington, D. C. 40 pp.
- World Wildlife Fund. 1994. *WOW!— a biodiversity primer*. Quad/Graphics, Pewaukee, Wisconsin. 67 pp.

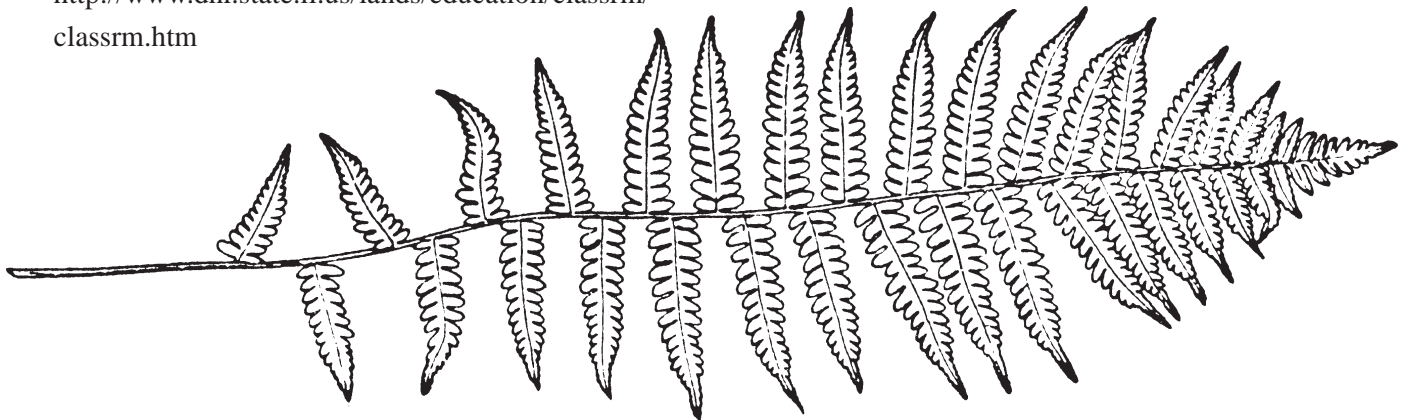



## CAREER CORNER

Botanist  
Chemist  
Community Activist  
Conservation Biologist  
Conservation Police Officer  
Ecologist  
Ecotourism Trip Leader  
Environmental Educator  
Environmental Journalist  
Environmental Lawyer  
Entomologist  
Environmental Specialist at a Foundation  
Fisheries Biologist  
Forester  
Hydrologist  
Integrated Pest Management Specialist  
Land-Use Planner  
Limnologist  
Natural History Museum Curator  
Naturalist/Interpreter in a Park or a  
Wildlife Sanctuary  
Nature Photographer  
Natural Resource Economist  
Organic Farmer  
Population Expert  
Park/Preserve/Refuge Manager  
Recycling Coordinator  
Research Biologist/Scientist  
Soil Conservation Specialist  
Solid Waste Manager  
Stewardship Volunteer  
Toxicologist  
Zookeeper  
Zoologist

## SAMPLE INTERVIEW QUESTIONS



Here are examples of some of the kinds of questions you might want to ask during your interview.

- ✓ Whats a typical day on the job like for you?
- ✓ Whats your educational background?
- ✓ What skills are especially useful in your profession?
- ✓ What types of scientific skills or technology do you need to do your job?
- ✓ Does your job involve protecting biodiversity? If so, how?
- ✓ Whats the most challenging aspect of your job?
- ✓ Whats the most rewarding aspect of your job?
- ✓ How did you become interested in your field?
- ✓ Did you always want to be involved in a career like the one you're in?
- ✓ Who inspired you to enter this field?
- ✓ Do you have any advice for students who may be considering a career like yours?
- ✓ How does your job influence or contribute to other people's lives?
- ✓ Are there people in other countries that do work similar to your work?



## Student Page Career Profiles

### Cyndi Duda

#### **Educating for the Future**

What does teaching have to do with the environment? Plenty when you're Cyndi Duda, an environmental education specialist for the U. S. Fish and Wildlife Service. She helps her agency protect, preserve and restore habitats in the six-county Chicago region by raising the awareness and appreciation of groups and individuals for the values of natural resources. Through teacher workshops, special events and presentations, she educates students and adults about the value of habitats and encourages them to become involved in actions to help the environment.

Cyndi came to education after previously working for the U. S. Army Corps of Engineers, regulating wetland use. She realized that implementing regulations would be more effective if she was working with people who understood the values of wetlands and the impacts developments would have on them. She returned to college to earn a teaching degree, which armed her with skills that have paved the way for her success. She notes that her most important asset is a solid science background that enables her to understand the issues and present good information to the public.

Cyndi works with people from a wide variety of backgrounds and ages. Her greatest reward is seeing people she has worked with doing something to make a difference, such as planting a wetland with native plants, working to clean up a watershed or developing a class unit. Cyndi's advice to people entering the field is to gain a broad general background as well as science skills so you can understand the biological, social and economic forces at play in environmental issues.

### Mark Pfister

#### **Variety is the Spice of Life**

Variety attracted Mark Pfister, aquatic biologist for the Lakes Management Unit at the Lake County Health Department, to the field of limnology—the study of fresh water, specifically lakes and ponds. The variety of lake types and ecosystems, daily jobs and people he comes in contact with is what Mark likes. Mark says, "The terrestrial habitats are pretty cut and dry (no pun intended), but the aquatic ecosystems are very dynamic. Everything is interrelated. Many different physical and biological factors both in the lake and on the land surrounding the lake must be considered before you can make management recommendations." He goes on to say, "I was very lucky while I was growing up, my grandfather had a farm and my father, brothers and I would spend every spare minute outdoors."

Before Mark entered the Peace Corps as a biology and genetics teacher, he wasn't sure if he was going to be an oceanographer or a limnologist. But while in Africa, Lake Nyos exploded killing thousands of people, cattle and wildlife. The internal lake processes that caused the explosion were so fascinating to him that it swayed him toward limnology. Upon returning from Africa he began working on an advanced degree in limnology



## Student Page Career Profiles (continued)

and hydrology at Indiana State University. While there, Mark was the coordinator of the Indiana Volunteer Lake Monitoring Program and analyzed the water quality and phytoplankton populations of over 200 Indiana lakes.

In Illinois, many of our lakes and ponds are privately owned. Therefore, much of what Mark does is give technical assistance to park districts, associations and homeowners. He works with them on water quality issues, plant types and shoreline erosion. Since a lake is a reflection of its watershed, he also focuses attention on watershed issues, such as nonpoint source pollution. On any given day Mark can be found either on the phone, writing reports or doing field work. "It's a great field to get into!" he says.

---

## Carol Lerner

### Tallgrasses Make for Tall Tales

Carol Lerner has been a writer and illustrator of children's nonfiction for 20 years. On a typical day, Carol can be found studying nature in a prairie, forest, garden or even a library. Then again, she may be polishing her prose or finishing a book with illustrations of plants and animals.

Carol's background in history has helped her become a good researcher but "there is a trick to writing difficult concepts simply for children," she says. Her interest in the natural world developed from curiosity. Over time she gained an appreciation for the complex strategies that enable plants and animals to survive. Carol, who has written books such as *Seasons of the Tallgrass Prairie*, says her biggest reward is seeing something that began as an idea turn into an attractive and interesting book. She says being a writer is not the best-paying career, and her advice for those who want to make it a career is "do it because you love it." Lerner holds the Chicago Public Library's Carl Sandburg Award, the annual award of the Children's Reading Round Table and three of her titles were named Notable Children's Books by the American Library Association.

---

## Kruti Patel

### Waste Not Want Not

Kruti Patel has been working in the environmental field for more than 12 years as a chemist, scientist, engineer and educator. Now the director of the Educycle Center, a Waste Management Recycling Facility, a typical day for Kruti includes learning about recycled markets, conducting tours of the recycling facility, interacting with teachers and students of all ages and designing displays for the center.

Kruti's academic background has led her to a variety of jobs during her career. It is her passion for protecting the environment that has enabled her to effectively teach all age groups about the "Three Rs" of reducing, reusing and recycling. "Protecting the environment," she says "is not a one person job. We all need to work together and teach each other about ways to make the world a cleaner and less wasteful place for our children."





## Student Page Career Profiles (continued)

### Bill Kurtis

#### Journalist with a Passion

Known for his sense of humor and exciting productions, Bill Kurtis, the Emmy award-winning television journalist, has been reporting about world-altering events for more than thirty years. He was among the first Chicago correspondents to travel to world hot spots like Vietnam and Northern Ireland. He has covered numerous special stories about animals, like the endangered black rhino in Africa. Bill Kurtis is also creator and producer of the Peabody Award-winning science-adventure series, *The New Explorers*.

Bill was born in Kansas and has a background in journalism and law. He has cultivated his professional skills with his personal concerns. Bill demonstrates a responsibility for the environment by participating on the Board of Directors of the National Park Foundation and The Nature Conservancy. He has educated many people with his television productions that often focus on nature and how to protect biodiversity all over the world.

### Michael Jeffords

#### Going Buggy over Bugs

Like many youngsters, Michael Jeffords had a passion for insects at an early age. However, he never knew his calling in life would be to become a scientist in entomology at the University of Illinois in Urbana-Champaign. Michael teaches college students about biodiversity and its preservation. In addition, he is the co-author and photographer of a book on Illinois habitats, called *Illinois Wilds*, is one of the creators of the habitat monitoring program for Illinois EcoWatch, and is currently helping to develop educational materials on biodiversity.

Michael's educational background is varied, from community college to medical school, to his doctoral degree in entomology. He feels that his specialized knowledge in his field of science and his capacity for integrated thinking has helped him to creatively apply his knowledge to looking at larger problems. His personal efforts have brought him more opportunities than the skills he has gained through academics. He says, "Everything you learn will be helpful to you at some point, so don't limit yourself in whatever you can try or gain knowledge about."



## Student Page Career Profiles (continued)

### Dennis Dreher

#### Planning for the Future

Playing in creeks and seeing how water flowed fascinated Dennis Dreher when he was a child. Today, he works with local governments to promote more sustainable communities through improved environmental management. Currently employed at the Northeastern Illinois Planning Commission on a fellowship from Chicago Wilderness, his job requires making presentations, writing proposals and publications, and most importantly, trying to find a common ground between different interest groups for improved ecological practices.

Dennis' college education was in water resources engineering. He finds water issues to be a major part of educating decision-makers about creating more ecologically friendly communities. "The best part of my job is working with committed and passionate people," he says, "especially when I see positive changes in attitudes and practices." His advice to students is to "get a solid but broad analytical background; don't just follow the money ... follow your passion. Do something that will make a difference; and don't be afraid to make changes along the way if you're not happy."

### Dave Brandt

#### The Dirt on Soil

To most homeowners and farmers, soil is a seedbed for plants. To engineers, soil is a construction material. To a parent, soil is something to get out of clothes. For all of us, soil is a natural resource. As a District Conservationist for the Natural Resources Conservation Service (NRCS), Dave Brandt works with individuals, groups and students to promote wise use of soil and all natural resources. "My goal is to make people aware of soil and to teach them why conservation is important."

Dave received his Bachelor of Science degree in Outdoor Recreation and Natural Resources Management from Southern Illinois University (SIU). He found soils so interesting that he took every soils class SIU offered. Dave worked at NRCS offices in Saline, Gallatin and Jasper counties. Now employed in McHenry County, he tackles a mix of urban and agricultural issues. He has found that there are similar natural resource issues throughout the state. "All of the land has been impacted in some way. What is left in the place of native plants are a handful of European invaders, such as buckthorn and reed canary grass."

Dave feels that people who are interested in protecting natural areas need to make a life-long commitment in order to help find solutions. He recommends that students interested in the natural resources fields take a broad spectrum of classes such as biology, botany, geology and water quality rather than focusing on a specific area, so that they will be able to understand the connections among resources.



## Student Page Career Profiles (continued)

### June Keibler

#### **Sharing the Thrill of Discovery**

June Keibler is on a mission. The mission began 17 years ago when she helped form the Kane County Natural Areas Volunteers. Today the group is 200 strong, working to protect and restore biodiversity in the natural areas of Kane County. Because of her efforts with the Natural Areas Volunteers, June was a logical choice when The Nature Conservancy asked for assistance in coordinating the recovery of the endangered white fringed orchid in Illinois. Through this effort, June helps to coordinate work to recover and expand the population of this flower. When asked why she feels her work is important, June's thoughts turn to the future. "The orchid is an indicator for how we are treating our landscape. With more than 95 percent of the wetlands in Illinois destroyed, orchids are increasingly rare. Every time we lose another species, we are denying future generations the surprise of finding it. We are taking away the thrill of discovery. We also do not know what may disappear with it."

June recommends spending time outdoors and volunteering to help groups that are working to protect and restore local biodiversity. "If there is something interesting to you, pursue it. The opportunities for involvement will be there, or you will help to create them." June practices what she teaches. Along with two colleagues she started a business, Witness Tree Native Landscapes. The business acts as both consultant and designer for the restoration of natural areas and the elimination of exotic species on public and private lands.

### The Maierhofers

#### **All in the Family**

For the Maierhofers, conservation practices have become a part of the family farming business. The family grows corn and soybeans on their 500-acre farm in Seneca. The farm has been in the family since 1878. The last glacial period left the land in this area with a hilly landscape, so soil conservation on the farm is crucial. As a result, the family has applied a number of soil conservation practices. Ridges of soil, called terraces, break up the slope of the land and control the movement of soil by water. Lines of trees, called windbreaks, are used to stop the movement of soil by wind. Six acres of land has been taken out of crop production and set aside to increase the diversity of the area, enhance the natural beauty of the landscape and provide food and shelter for wildlife. The Maierhofers practice conservation tillage, using a minimum tillage system on their corn fields and no-tillage where soybeans are raised.

The Maierhofers daughter and two sons help out on the family farm on weekends. For one of the sons, Les, growing up on the family farm has helped him gain a perspective valuable for his career. After studying agricultural economics at the University of Illinois, he began working for the Farm Services Agency (FSA). Les is now county executive director for the FSA in Kendall, Kane and DuPage counties. As county executive director, Les oversees federal farm programs at the local level. One of these programs offers monetary incentives to farmers who are interested in applying conservation practices. Working on the family farm helped him gain an understanding of these practices as well as issues that farmers face. Les believes that "conservation practices are necessary to protect land and water quality. The topsoil that farmers grow their crops in takes thousands of years to form. It is rewarding to see that these practices really do work. Terraces and conservation tillage help control the movement of water which helps reduce the erosion of soil. Ponds and native landscaping are not only aesthetically pleasing but help to attract deer and other wildlife."



## Student Page Career Profiles (continued)

### Shelly Fuller

#### **All Wet and Loving It!**

Shelly Fuller first read about Illinois RiverWatch in a newspaper, and her feet have been wet ever since. Originally hired to recruit and train volunteers to conduct stream monitoring, she now finds herself as the Education and Training Coordinator, in charge of all training aspects of this statewide program. There are myriad responsibilities accompanying her position, one of the most important being designing and implementing the training and certification program for EcoWatch trainers. She teaches her field staff the concepts of biological stream monitoring, how to conduct the scientific procedures and identification required by the program, and how to teach the information to Illinois' citizens. RiverWatch has more than 1,500 volunteers collecting data on hundreds of sites each year. One of her favorite things about working for EcoWatch is that it offers conservation-minded citizens across the state the opportunity to contribute to meaningful scientific research.

Shelly's degree is in biological sciences, and she is continuing her education by attending workshops and classes and through self-study under the direction of local naturalists.

### Barrie McVey

#### **Planting Forests for the Future**

When she was growing up, Barrie McVeys adventures with her family while on vacation throughout the United States led her to develop an appreciation of nature and the interaction of all things within it. She pursued her interest and now works as a District Forester for the Illinois Department of Natural Resources.

Each year foresters plant trees on many acres of land that were once forested but have since been cleared. The tree plantings help to reduce soil erosion, improve water quality, provide homes for wildlife and create future forest products. Foresters also assist private landowners with proper woodland management to improve the quality of their forests. Working on public lands is also part of a foresters job, to ensure that the citizens of Illinois can enjoy healthy forests.

Barrie enjoys being able to work outside in all the different season of the year. She says that the woods can be a completely different place between the summer and the winter. She enjoys going back to a tree planting on old farm ground after a few years and seeing a productive young forest. "Its great to see the trees growing and to see all of the wildlife that moves back in! And its very satisfying to teach people, both young and old, about the importance of trees."



---

## Student Page Career Profiles (continued)

### Wayne Frankie

#### **Rock Detective**

As a geologist with the Illinois Natural History Survey, Wayne Frankie has the opportunity to work outdoors, travel and learn about the variety of geology within our state. Wayne says that a geologist is really a scientific detective. One of the most rewarding aspects of his job is working with and meeting people and sharing information with them.

Wayne's job includes many responsibilities. He leads public geological science field trips, plans and participates in a variety of teacher workshops and exhibits and responds to questions from teachers, students and the general public. Wayne offers the following advice to students who may be interested in becoming a geologist: "Do your very best in all of your school subjects. Look at the world around you and ask questions." You never know what you may discover!

---



## Student Page Tips and Tricks of Interviewing

### Before the Interview

- ✓ When you call to set up an interview, introduce yourself on the phone. State your name, school, grade level, and the purpose of the interview.
- ✓ Set up an appointment far enough in advance to give you and the interviewee time to prepare.
- ✓ Carefully prepare your questions in advance. Limit the number of questions to about 10 or so. (Most people don't have time for long interviews, and too many questions will make it difficult for you to process all the information.)
- ✓ Find out if the interviewee would like a list of your questions in advance. If so, send them out as soon as you can.
- ✓ If you want to use a tape recorder, ask permission first. And make sure that it works and you know how to use it before your interview.
- ✓ If you are working in pairs, decide who will be asking the questions and who will be taking notes. (If the person taking notes thinks of additional questions during the interview, he or she can ask them. Try to make sure any new questions are brief and appropriate to the subject.)



### During the Interview

- ✓ Be polite and considerate.
- ✓ Before you begin asking questions, explain how you will use the information.
- ✓ Ask your questions clearly and give the interviewee time to think and respond.
- ✓ Before you end the interview, thank the interviewee for taking the time to help you with your project.
- ✓ If you will be writing up the interview as an article, ask the interviewee if he or she would like a copy of it. If so, get the interviewee's address, and then be sure to follow through on getting the article to him or her as soon as you can.
- ✓ Ask for the interviewee's mailing address so that you can send a thank-you note or any other material after the interview.

### After the Interview

- ✓ Send a thank-you note a few days after the interview.
- ✓ If you are working in pairs, meet with your interviewing partner soon after the interview to compare notes, impressions and information.



## Appendices Vocabulary

Each definition is immediately followed by the number of the activity or activities in which it is introduced or to which its meaning is most relevant. For example, (1-2) indicates the second activity in the first section. Vocabulary words may be found in other activities besides those listed below.

*abdomen*: in arthropods (animals like spiders and insects), the posterior section of the body (1-2)

*antenna* (singular); *antennae* (plural): paired, flexible, jointed sensory appendage on the head of some arthropods (1-2)

*appendage*: a part or organ that is joined to the main body of an object or organism; examples include legs and antennae (1-2)

*arthropod*: organism such as a scorpion, spider, tick, millipede, centipede, insect or crustacean; the body has an external, segmented covering and jointed appendages (1-2)

*atmosphere*: the gaseous mass surrounding the earth which is held in place by gravity (2-3)

*bacterium* (singular); *bacteria* (plural): one-celled organism without a true nucleus; some are free-living, and some are parasites (1-2)

*biodiversity*: the variety of life on earth, reflected in the variety of ecosystems and species, their processes and interactions and the genetic variation within and among species (1-1)

*biogeography*: the study of living systems and their distribution (3-3)

*biosphere*: the part of the earth and its atmosphere where living things exist (1-2)

*cephalothorax*: the joined head and thorax of arachnids (spiders, scorpions, ticks and others) and many crustaceans (1-2)

*chromosome*: structure that contains DNA in the cell and that is responsible for the determination and transfer of hereditary traits (1-4)

*class*: a taxonomic category that ranks below phylum and above order (1-2)

*classification*: grouping organisms into categories based on shared characteristics or traits (1-2)

*conflict management*: a practice in which disagreeing groups meet with an impartial person to discuss their concerns; each side listens closely to the other side; the impartial person helps clarify what each side is asking for; in many cases, both groups find that their needs can be met without further conflict (4-1)

*consensus*: collective opinion; general agreement or accord (4-1)

*cultural diversity*: differences in socially transmitted behavior patterns, arts, beliefs, institutions and other products of human work and thought characteristic of a community or population (4-1)

*ecological processes*: relationships between organisms and their environments (2-2)

*economics*: science that deals with the production, distribution and consumption of goods (2-2)

*ecoregion*: a relatively large unit of land that is characterized by a distinctive climate, ecological features and plant and animal communities (1-3)



## Appendices

### Vocabulary (continued)

*ecosystem*: a community of organisms that are linked by energy and nutrient flows and that interact with each other and with the physical environment (1-1)

*edge effect*: when a habitat is divided into small sections, more boundaries are created between the habitat and its surroundings; these boundaries, or edges, are very different than the conditions in the habitat's interior; edge is often lighter and drier than the interior of the habitat and can change the types of organisms living in the area; in small fragments, edge conditions may compose most of the habitat (3-3)

*endangered species*: a species threatened with extinction (3-1, 3-2)

*Endangered Species Act*: legislation enacted to ensure the survival of endangered plant and animal species; habitats critical to their survival may be protected, too (3-1)

*evaporation*: changing from a liquid state to a gaseous state (2-3)

*evolution*: the process of change in the traits of organisms or populations over time (1-2, 1-4)

*extinct*: a species that no longer exists (2-2)

*family*: a taxonomic category that ranks below order and above genus (1-2)

*fragmentation*: the breaking up of large habitats into smaller, isolated chunks (3-3)

*fungi*: organisms that use living or dead organisms as food by breaking them down and then absorbing the substances into their cells (1-2)

*gall*: an abnormal swelling of plant tissue caused by insects, microorganisms or injury (1-3)

*gene*: a segment of DNA that includes the coded information in an organism's cells that makes each species and individual unique (1-1, 1-4)

*genetic diversity*: the genetic variation present in a population or species (1-4)

*genus*: a taxonomic category that ranks below family and above species (1-2)

*global warming*: the hypothesis that the earth's atmosphere is warming because of the release of "greenhouse gases" such as carbon dioxide (4-1)

*ground-truthing*: the process of going to an area to verify information; gives scientists a firsthand look at areas they're interested in and can help guide further studies (1-3)

*habitat*: the area where an organism lives and finds the nutrients, water, sunlight, shelter, living space and other essentials that it needs to survive (3-1, 3-3)

*habitat loss*: the destruction, degradation and fragmentation of habitats; primary cause of biodiversity loss (3-2)

*heavy metals*: natural metallic elements including cadmium, copper, lead and zinc; can be toxic to some organisms (2-3)

*immigration*: to move into an area (3-3)

*impurity*: a contaminant or pollutant (2-3)

*inherit*: to receive genetically from an ancestor (1-4)

*introduced species*: an organism that has been brought into an area where it does not occur naturally (3-1, 3-2)





## Appendices

### Vocabulary (continued)

*invasive species*: an organism that has been brought into or spread into an area where it does not occur naturally (4-1)

*kingdom*: one of the main taxonomic divisions into which natural organisms and objects are classified (1-2)

*legislation*: the act of making laws; a proposed or enacted law or group of laws (4-1)

*lichen*: a fungus and an alga or blue-green bacteria growing together in a mutually beneficial relationship often seen as crustlike scaly or branched growths on soil, rocks or tree bark (4-1)

*migration*: the movement of animals in response to seasonal changes or changes in the food supply (1-1, 1-3)

*mineral*: a natural inorganic substance with a definite, uniform chemical composition and characteristic crystalline structure, color and hardness (2-3)

*native species*: a species that occurs naturally in an area or habitat (1-3)

*noxious*: harmful to health (1-3)

*nucleus*: complex structure in some cells that contains the cell's hereditary material and that controls metabolism, growth and reproduction (1-4)

*order*: a taxonomic category that ranks below class and above family (1-2)

*organism*: a living thing (1-2)

*over-consumption*: the use of resources at a rate that exceeds the ability of natural processes to replace them (3-2)

*pesticide*: chemical that inhibits or kills the growth of organisms that people consider undesirable (2-3)

*photosynthesis*: the process by which green plants, algae and other organisms that contain chlorophyll use sunlight to produce carbohydrates (food) (2-3)

*phylum*: a taxonomic category that ranks below kingdom and above class (1-2)

*pollination*: the process by which pollen is transferred from the male part of a flower to the female part of the same or a different flower (2-2, 4-1)

*population*: all the individuals of one species in one place at one time (1-4)

*precipitation*: water droplets or ice particles condensed from the atmosphere and heavy enough to fall to earth's surface, such as rain or snow (1-3)

*racial justice*: equality among ethnic groups (4-1)

*range map*: graphic representation of the area in which a species lives (3-1)

*rapid assessment*: a quick scientific survey or count that helps measure local biodiversity (1-3)

*recycling*: to extract useful materials from; to extract and reuse; to use again or reprocess to use again (4-1)

*sampling*: studying a small portion of the total then using mathematics to extrapolate the findings to the larger whole (1-3)

*sediment*: material that settles to the bottom of a liquid (2-3)



## Appendices Vocabulary (continued)

*smart growth*: using new methods of building and rebuilding neighborhoods and incorporating long-term planning practices to protect the area's natural resources (4-1)

*species*: a group of organisms that have a unique set of characteristics that distinguishes them from other organisms; the basic unit of biological classification (1-1, 1-2, 1-4)

*stewardship*: the management of natural resources (4-1)

*sustainable*: capable of existing or being maintained (4-1)

*taxonomy*: the process and study of classifying organisms (1-2)

*toxic substance*: one that is harmful, destructive or deadly (2-3)

*trait*: a genetic feature or characteristic, such as hair color or blood type, that may be passed on from one generation to the next (1-4)

*transpiration*: the process of giving off water vapor and other products through the stomata of plants (2-3)

*wetland*: area that, at least periodically, has waterlogged soils or is covered with a relatively shallow layer of water (2-3)

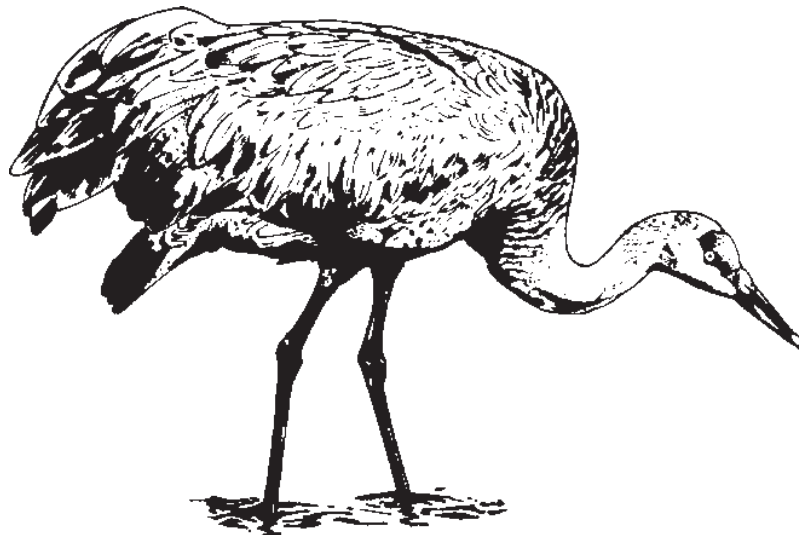



## Appendices

### Scientific Names

The scientific name is the official name for each organism. A scientific name is assigned after careful research. It is made up of two parts, the genus name (written first) followed by the species name. Your scientific name is *Homo sapiens*. Sometimes a third part, the subspecies name, is also used. The name is always in Latin because when this naming process started, most people everywhere knew Latin. The scientific name is underlined or in italics when written. Often a scientific name tells you something about the species or someone who studied it. Scientific names help scientists to study organisms, especially when working with other scientists.

The common and scientific names for most species discussed in this guide (except the list of endangered and threatened species included with Activity 3-1) are listed below. Those species referred to in general terms will not be found in this list.

almond <i>Prunus triloba</i>	cow <i>Bos taurus</i>
American woodcock <i>Scolopax minor</i>	coyote <i>Canis latrans</i>
antlion <i>Myrmeleon spp.</i>	cranberry <i>Vaccinium macrocarpon</i>
apple <i>Malus pumila</i>	cucumber <i>Cucumis sativus</i>
avocado <i>Persea spp.</i>	dog <i>Canis familiaris</i>
bald eagle <i>Haliaeetus leucocephalus</i>	downy serviceberry <i>Amelanchier arborea</i>
bald cypress <i>Taxodium distichum</i>	eastern sand darter <i>Ammocrypta pellucidum</i>
bison <i>Bos bison</i>	elk <i>Cervus elaphus</i>
black bear <i>Ursus americanus</i>	firefly <i>Photinus pyralis</i>
blackpoll warbler <i>Dendroica striata</i>	geranium <i>Geranium spp.</i>
bloodroot <i>Sanguinaria canadensis</i>	giant panda <i>Ailuropoda melanoleuca</i>
blue cheese fungus <i>Penicillium roqufortii.</i>	ginseng <i>Panax quinquefolius</i>
blueberry <i>Vaccinium spp.</i>	gray fox <i>Urocyon cinereoargenteus</i>
bobcat <i>Lynx rufus</i>	gray wolf <i>Canis lupus</i>
brown-headed cowbird <i>Molothrus ater</i>	gray squirrel <i>Sciurus carolinensis</i>
California kingsnake <i>Lampropeltis getulus californiae</i>	great plains rat snake <i>Elaphe guttata emoryi</i>
cantaloupe <i>Cucumis melo</i>	greater prairie-chicken <i>Tympanuchus cupido</i>
carrot <i>Daucus spp.</i>	hoary elfin butterfly <i>Incisalia polios</i>
cat <i>Felis catus</i>	honey bee <i>Apis mellifera</i>
celery <i>Abelmoschus esculentus</i>	horse <i>Equus caballus</i>
cheetah <i>Acinonyx jubatus</i>	house sparrow <i>Passer domesticus</i>
cherry <i>Prunus spp.</i>	human <i>Homo sapiens</i>
corn snake <i>Elaphe guttata</i>	Illinois (yellow) mud turtle <i>Kinosternon flavescens spooneri</i>
corn <i>Zea mays</i>	



## Appendices

### Scientific Names (continued)

- jackal *Canis aureus*  
lion *Panthera leo*  
little brown bat *Myotis lucifugus*  
lynx *Lynx canadensis*  
masked shrew *Sorex cinereus*  
mayapple *Podophyllum peltatum*  
mite *Demodex folliculorum*  
mite *Demodex brevis*  
mountain lion (puma) *Felis concolor*  
mud snake (hoop snake) *Farancia abacura*  
multiflora rose *Rosa multiflora*  
osprey *Pandion haliaetus*  
ovenbird *Seiurus aurocapillus*  
paddlefish *Polyodon spathula*  
passenger pigeon *Ectopistes migratorius*  
pear *Pyrus communis*  
peregrine falcon *Falco peregrinus*  
pimpleback *Quadrula pustulosa*  
plum *Prunus spp.*  
potato *Solanum tuberosum*  
purple coneflower *Echinacea purpurea*  
raccoon *Procyon lotor*  
red panda *Ailurus fulgens*  
red fox *Vulpes vulpes*  
red-tailed hawk *Buteo jamaicensis*  
ring-necked pheasant *Phasianus colchicus*  
river otter *Lontra canadensis*  
ruby-throated hummingbird  
*Archilochus colubris*  
sea lamprey *Petromyzon marinus*  
short-tailed shrew, northern  
*Blarina brevicauda*  
soybean *Glycine max*  
spiny water flea *Bythotrephes cederstroemi*  
tiger *Panthera tigris*  
tomato hornworm *Manduca quinquemaculata*  
vampire bat *Desmodus rotundus*  
wart hog *Phacochoerus aethiopicus*  
watermelon *Citrullus lanatus*  
waterweed *Anacharis spp.* (also known as  
*Elodea spp.*)  
weasel *Mustela spp.*  
white fringed orchid  
*Platanthera leucophaea*  
white pine *Pinus strobus*  
white oak *Quercus alba*  
white-tailed deer *Odocoileus virginianus*  
wild turkey *Meleagris gallopavo*  
willow *Salix spp.*  
woodchuck *Marmota monax*  
yellow warbler *Dendroica petechia*  
zebra mussel *Dreissena polymorpha*

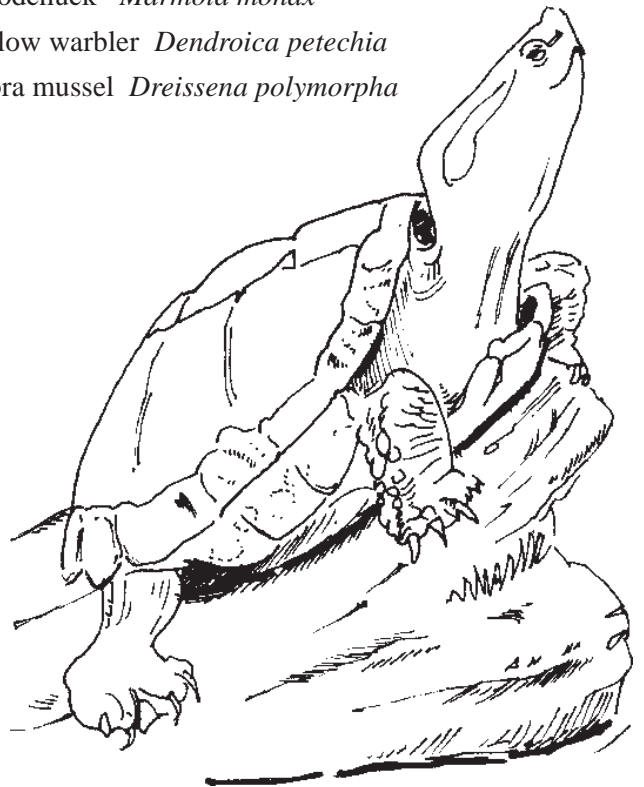



## Appendices

# Conceptual Framework and Correlation to *Illinois Biodiversity Basics*

Because the issues surrounding biodiversity can be complex, the topic can be challenging to understand and to teach. The following Conceptual Framework is based on World Wildlife Fund's "A Biodiversity Education Framework" section in the *Windows on the Wild: Biodiversity Basics* educator's guide. The framework in *Windows on the Wild: Biodiversity Basics* is much more extensive than the one shown here and is a general framework for biodiversity education. You may want to reference "A Biodiversity Education Framework" to assist you in teaching about biodiversity.

In this Conceptual Framework you will find the biodiversity topic broken down into small components to help you see, and communicate the relationships among, the different levels of biodiversity, the ecological principles behind it and how we relate to it. We've also linked the concepts to the *Illinois Biodiversity Basics* activities that are designed to teach them. While no single activity can teach the concepts completely, each can contribute to your students' growing understanding. In each activity you will find a section titled "Links to *Illinois Biodiversity Basics* Conceptual Framework." The related conceptual framework topic(s) will be listed there. This section of the guide will explain the framework link in more detail. The concepts are organized under four themes, and the themes are arranged to build on one another, starting with the basic ecological foundation and expanding to include societal issues.

### What is Biodiversity?

The concepts within this theme provide students with a fundamental knowledge and appreciation of biodiversity. These concepts also help students understand the characteristics of living systems and the fact that the environment is made up of systems within larger systems.

**Biological diversity**, also called biodiversity, encompasses the variety of all life on earth, including life on land, in the oceans and in freshwater ecosystems, such

as rivers and lakes. People often analyze biodiversity at many levels, ranging from large to small. The three most common levels of analysis focus on ecological diversity, species diversity and genetic diversity. (Activity 1-1)

**Species diversity** describes the number and variety of species that live on earth. Species diversity can refer to the diversity within specific groups of organisms as well as the total diversity of organisms on earth and the relationships among them. (Activities 1-2, 1-3)

**Genetic diversity** refers to the variety of genetic information contained in the genes of individuals, species, populations within a species or evolutionary lineages. (Activity 1-4)

A group of organisms that is evolving separately from other groups is called a **species**. For organisms that reproduce sexually, a species can also be defined as organisms that interbreed only among themselves. (Activity 1-2)

Scientists use the terms **endangered, threatened and extinct** to describe the status of species. Endangered species are those species that are in immediate danger of becoming extinct. Threatened species are those whose numbers are low or declining and whose gene pool is becoming too small to ensure variation in offspring. A threatened species is not in immediate danger of extinction but is likely to become endangered if it isn't protected. Extinct species are no longer living. (Activities 3-1, 3-2)

### Why is Biodiversity Important?

Concepts in this section can help students investigate how biodiversity affects their lives and supports life on earth. Recognizing the importance of biodiversity increases students' awareness of why and how people's actions affect biodiversity, and why it's important to maintain and restore biodiversity.



## Appendices

# Conceptual Framework and Correlation to *Illinois Biodiversity Basics* (continued)

Each level of biodiversity is essential to fundamental life processes (life support systems):

**Genetic diversity** within species allows species to adapt to changes in the environment over time.

**Species diversity** provides a variety of interactions that contribute to energy flow and nutrient cycling in ecosystems.

**Ecological diversity** provides habitat for different species, as well as essential services that maintain the biosphere, including water and air purification, microclimate control and soil formation and stability. (Activity 2-3)

The decision to protect biodiversity (or not to protect it) is the result of choices people make as families, community members, voters, consumers, employees, politicians and neighbors. These choices can reflect **values and beliefs**, knowledge of the issues and the consequence of a choice, a need to satisfy basic human needs or other factors. An understanding of biodiversity issues can help us predict future trends and determine the positive and negative effects of our choices and the values they reflect. (Activities 2-2, 4-1)

The ways different **cultures** around the world feel about and use the natural world are expressed through art, architecture, urban planning, music, language, literature, theater, dance, sports, religion and other aspects of their lives. (Activity 2-1)

**Human values** can be affected by a variety of factors, including wealth, health, religion, ecology and culture. These factors influence the development of lifestyles that may or may not be supportive of maintaining biodiversity. (Activity 4-1)

### What's the Status of Biodiversity?

Concepts in this theme can help students understand the status of biodiversity and why it is declining. By learning about causes and consequences of biodiversity loss, students will be able to participate in actions to maintain biodiversity in the future.

The **five major causes of biodiversity decline** are human population growth; loss, degradation and fragmentation of habitat; introduced species; over-consumption of natural resources; and pollution. (Activity 3-2)

The **loss, degradation and fragmentation of habitats**, such as forests and wetlands, is the single most important factor behind species extinction. This large-scale loss is the result of human population growth, pollution and unsustainable consumption patterns. (Activity 3-3)

### How Can We Protect Biodiversity?

Concepts in this section help students identify ways to ensure that adequate biodiversity will be maintained for future generations. For students to willingly and effectively take action to protect biodiversity, they must have a thorough understanding and appreciation of what biodiversity is, why it's important, why we're losing it and what people can do to help maintain and conserve it. Students also begin to understand that ecological integrity, social equity and economic prosperity are connected and are important components of a sustainable society.

Because issues related to biodiversity are complex and require the synthesis of information gathered by **investigators in different fields**, biodiversity research involves professionals with backgrounds in science, sociology, demographics, technology, planning, history, anthropology, mathematics, geography and other disciplines. (Activity 4-2)

**All sectors of society** influence biodiversity to some extent and can work to protect biodiversity through policy initiatives, media campaigns, corporate mission statements and other public activities. (Activity 4-2)



## Appendices

# Cross-Reference and Planning Chart

**Goal:** To introduce students in grades five through eight to local biodiversity concepts, issues and conservation.  
**Objectives:** As a result of participating in the unit activities, students will: 1) possess a basic understanding of biological, species and genetic diversity; 2) be able to explain the role biodiversity plays in ecosystem stability and health; 3) be able to report on its current status; and 4) know strategies to employ for its conservation and preservation.

### Section 1: What is Biodiversity?

Activity	At a Glance	Conceptual Framework Links	Illinois Learning Standards Links
Activity 1-1: What's Your Biodiversity IQ?	Take a "gee-whiz quiz" to find out how much you know about biodiversity, especially in Illinois.	biological diversity	English language arts: 1.C.2a, 1.C.3a science: 12.B.2a, 12.B.2b, 12.B.3a, 12.B.3b
Activity 1-2: Sizing Up Species	Classify organisms using a classification flow chart, play a team game to find out how many species may exist within different groups of organisms, and make a graph to illustrate the relative abundance of living things.	species diversity, defining "species"	mathematics: 6.C.2a, 6.C.3a, 6.D.2, 6.D.3, 10.A.2a, 10.A.3a
Activity 1-3: Backyard BioBlitz	Answer an ecoregional survey, then take a first-hand look at biodiversity in your community.	species diversity	English language arts: 3.C.2a, 3.C.2b, 3.C.3b, 4.B.2a, 4.B.2b, 4.B.3a, 5.A.2a, 5.A.3b, 5.B.3a, 5.C.2a, 5.C.2b, 5.C.3b science: 13.B.2e, 13.B.2f social science: 16.E.3c
Activity 1-4: The Gene Scene	Play several different games that introduce genetic diversity and highlight why it's important within populations.	genetic diversity	English language arts: 3.C.2a, 3.C.3b, 5.C.2a science: 12.A.2a, 12.B.2b, 12.B.3b social science: 17.C.3a



## Appendices

### Cross-Reference and Planning Chart (continued)

## Section 2: Why is Biodiversity Important?

Activity	At a Glance	Conceptual Framework Links	Illinois Learning Standards Links
Activity 2-1: The Nature of Poetry	Read and discuss several poems related to biodiversity then write original biodiversity poetry.	culture and nature	English language arts: 1.A.3b, 1.C.2e, 1.C.3e, 2.A.2c, 2.A.3a, 2.A.3c, 2.A.3d, 2.B.2a, 2.B.2c, 2.B.3a, 3.B.2b, 3.B.3a
Activity 2-2: The Spice of Life	Explore beliefs and values about why biodiversity is important and why it should be protected.	conflicts in values lead to obstacles when solving problems	English language arts: 4.B.2a, 4.B.2b science: 13.B.2f, 13.B.3d social science: 17.C.2c
Activity 2-3: Secret Services	Perform simulations that demonstrate some of the important ecosystem services that biodiversity provides.	genetic/species/ecological diversity are essential to life processes	English language arts: 4.B.2a, 4.B.2b, 4.B.3a science: 11.A.2e, 12.E.2a, 12.E.2b, 12.E.3b social science: 17.B.2a, 17.B.2b, 17.B.3a





## Appendices

### Cross-Reference and Planning Chart (continued)

#### Section 3: Whats the Status of Biodiversity?

Activity	At a Glance	Conceptual Framework Links	Illinois Learning Standards Links
Activity 3-1: Endangered Species Gallery Walk	Conduct research to create a poster about an endangered species in the state of Illinois and then take a walk through a poster “gallery” to find out more about threatened/endangered species around the state.	defining endangered, threatened and extinct	English language arts: 3.A.3, 4.B.2b, 5.A.3a science: 13.B.3d social science: 17.B.3b, 17.C.2c
Activity 3-2: The Case of the Greater Prairie-Chicken	Work in small groups to discover how the greater prairie-chicken’s decline is tied to the major causes of biodiversity loss in Illinois and discuss what people are doing to help protect the greater prairie-chicken.	the five major causes of biodiversity loss: 1) degradation and fragmentation of habitat lead to species extinction; 2) some technologies result in the loss of biodiversity; 3) nonnative species reduce biodiversity; 4) pollution affects biodiversity; and 5) we are still learning about biodiversity thus some interpretations differ	English language arts: 3.A.3, 3.B.3b, 4.A.2b, 4.B.3b, 5.A.2a, 5.A.2b, 5.A.3a, 5.A.3b, 5.C.2a, 5.C.3a science: 13.B.2e, 13.B.2f, 13.B.3d, 13.B.3e social science: 16.E.3c, 17.B.2a, 17.B.3b, 17.C.2c
Activity 3-3: Space for Species	Play an outdoor game, conduct a survey of plant diversity and analyze current research to explore the relationship between habitat size and biodiversity.	degradation and fragmentation of habitat lead to species extinction	English language arts: 3.A.3, 3.B.2b, 3.C.3b, 4.A.2b, 4.B.2b, 4.B.2d mathematics: 6.B.3a, 6.C.3a, 10.A.2a, 10.A.2c, 10.A.3a, 10.C.3a science: 11.A.2c, 11.A.2d, 11.A.2e, 11.A.3a, 11.A.3g, 13.A.3c, 13.B.2f, 13.B.3b, 13.B.3e



## Appendices

### Cross-Reference and Planning Chart (continued)

#### Section 4: How Can We Protect Biodiversity?

Activity	At a Glance	Conceptual Framework Links	Illinois Learning Standards Links
<p>Activity 4-1: Future Worlds</p>	<p>Build a pyramid to reflect personal priorities for the future. Investigate the way humans affect the natural world and discover how people are working to protect the environment and improve the quality of life in Illinois and on earth.</p>	<p>human values influence biodiversity; knowledge of biodiversity can help predict trends and determine effects of our choices</p>	<p>English language arts: 4.B.2a, 4.B.2d, 4.B.3d, 5.A.2a, 5.A.2b, 5.A.3a, 5.A.3b, 5.C.2b social science: 16.E.2c, 16.E.3b, 16.E.3c, 17.C.2c physical development and health: 22.C.2, 22.C.3a, 22.C.3b</p>
<p>Activity 4-2: Career Moves</p>	<p>Read profiles of people who work in biodiversity-related professions in Illinois. Conduct interviews of people in your community with similar occupations.</p>	<p>study of biodiversity is interdisciplinary; all sectors of society influence biodiversity</p>	<p>English language arts: 5.B.3a, 5.C.3c science: 13.B.2c, 13.B.3b, 13.B.3c social science: 17.c.2c</p>



## Appendices

# Correlation to Illinois Learning Standards and Benchmarks

For each subject area, the benchmark is followed by the activity which could help students to achieve it.

### English language arts

1.A.3b (2-1)  
1.C.2a (1-1)  
1.C.3a (1-1)  
1.C.2e (2-1)  
1.C.3e (2-1)  
2.A.2c (2-1)  
2.A.3a (2-1)  
2.A.3c (2-1)  
2.A.3d (2-1)  
2.B.2a (2-1)  
2.B.2c (2-1)  
2.B.3a (2-1)  
3.A.3 (3-1, 3-2, 3-3)  
3.B.2b (2-1, 3-3)  
3.B.3a (2-1)  
3.B.3b (3-2)  
3.C.2a (1-3, 1-4)  
3.C.2b (1-3)  
3.C.3b (1-3, 1-4, 3-3)  
4.A.2b (3-2, 3-3)  
4.B.2a (1-3, 2-2, 2-3, 4-1)  
4.B.2b (1-3, 2-2, 2-3, 3-1, 3-3)  
4.B.2d (3-3, 4-1)  
4.B.3a (1-3, 2-3)  
4.B.3b (3-2)  
4.B.3d (4-1)  
5.A.2a (1-3, 3-2, 4-1)  
5.A.2b (3-2, 4-1)  
5.A.3a (3-1, 3-2, 4-1)  
5.A.3b (1-3, 3-2, 4-1)  
5.B.3a (1-3, 4-2)  
5.C.2a (1-3, 1-4, 3-2)  
5C.2b (1-3, 4-1)  
5.C.3a (3-2)  
5.C.3b (1-3)  
5.C.3c (4-2)

### mathematics

6.B.3a (3-3)  
6.C.2a (1-2)  
6.C.3a (1-2, 3-3)  
6.D.2 (1-2)  
6.D.3 (1-2)  
10.A.2a (1-2, 3-3)

10.A.2c (3-3)  
10.A.3a (1-2, 3-3)  
10.C.3a (3-3)

### science

11.A.2c (3-3)  
11.A.2d (3-3)  
11.A.2e (2-3, 3-3)  
11.A.3a (3-3)  
11.A.3g (3-3)  
12.A.2a (1-4)  
12.B.2a (1-1)  
12.B.2b (1-1, 1-4)  
12.B.3a (1-1)  
12.B.3b (1-1, 1-4)  
12.E.2a (2-3)  
12.E.2b (2-3)  
12.E.3b (2-3)  
13.A.3c (3-3)  
13.B.3b (4-2)  
13.B.3c (4-2)  
13.B.2e (1-3, 3-2)  
13.B.2f (1-3, 2-2, 3-2, 3-3)  
13.B.3b (3-3)  
13.B.3d (2-2, 3-1, 3-2)  
13.B.3e (3-2, 3-3)

### social science

16.E.2c (4-1)  
16.E.3b (4-1)  
16.E.3c (1-3, 3-2, 4-1)  
17.B.2a (2-3, 3-2)  
17.B.2b (2-3)  
17.B.3a (2-3)  
17.B.3b (3-1, 3-2)  
17.C.2c (2-2, 3-1, 3-2, 4-1, 4-2)  
17.C.3a (3-3)

### physical development and health

22.C.2 (4-1)  
22.C.3a (4-1)  
22.C.3b (4-1)



## Appendices

### Correlation to Subject Areas

	English language arts	mathematics	science	social science	physical development and health
Whats Your Biodiversity IQ? (Activity 1-1)	x		x		
Sizing Up Species (Activity 1-2)		x			
Backyard BioBlitz (Activity 1-3)	x		x	x	
The Gene Scene (Activity 1-4)	x		x		
The Nature of Poetry (Activity 2-1)	x				
The Spice of Life (Activity 2-2)	x		x	x	
Secret Services (Activity 2-3)	x		x	x	
Endangered Species Gallery Walk (Activity 3-1)	x		x	x	
The Case of the Greater Prairie-Chicken (Activity 3-2)	x		x	x	
Space for Species (Activity 3-3)	x	x	x	x	
Future Worlds (Activity 4-1)	x			x	x
Career Moves (Activity 4-2)	x		x	x	



## Appendices Correlation to Skills

	gather	organize	analyze	interpret	apply	evaluate	present	develop citizenship skills
Whats Your Biodiversity IQ? (Activity 1-1)			x	x	x			
Sizing Up Species (Activity 1-2)		x	x	x				
Backyard BioBlitz (Activity 1-3)	x	x	x	x	x	x		
The Gene Scene (Activity 1-4)	x		x	x				
The Nature of Poetry (Activity 2-1)	x		x				x	
The Spice of Life (Activity 2-2)		x	x				x	x
Secret Services (Activity 2-3)		x		x			x	x
Endangered Species Gallery Walk (Activity 3-1)	x		x	x	x		x	
The Case of the Greater Prairie-Chicken (Activity 3-2)	x		x		x			
Space for Species (Activity 3-3)	x	x	x	x	x			x
Future Worlds (Activity 4-1)	x	x	x	x			x	x
Career Moves (Activity 4-2)	x		x	x			x	



## Appendices

### Correlation to Time Required

	one class period	two class periods	three or more class periods
Whats Your Biodiversity IQ? (Activity 1-1)	<b>x</b>		
Sizing Up Species (Activity 1-2)		<b>x</b>	
Backyard BioBlitz (Activity 1-3)		<b>x</b> (Part II)	<b>x</b> (Part I)
The Gene Scene (Activity 1-4)			<b>x</b>
The Nature of Poetry (Activity 2-1)		<b>x</b>	
The Spice of Life (Activity 2-2)	<b>x</b>		
Secret Services (Activity 2-3)		<b>x</b>	
Endangered Species Gallery Walk (Activity 3-1)			<b>x</b>
The Case of the Greater Prairie-Chicken (Activity 3-2)		<b>x</b>	
Space for Species (Activity 3-3)	<b>x</b> (Part I)	<b>x</b> (Part II)	
Future Worlds (Activity 4-1)		<b>x</b>	
Career Moves (Activity 4-2)		<b>x</b>	



## Appendices Resources

The following organizations worked in partnership to produce *Illinois Biodiversity Basics*. Although these groups are not the only sources for biodiversity materials, they can provide you with basic information and educational tools to assist you in implementing this activity guide.

### Chicago Wilderness

Education and Communication Team  
(312) 665-7444  
<http://www.chicagowilderness.org>

Chicago Wilderness is a regional nature reserve of globally significant rare natural communities in an area encompassing southeastern Wisconsin, the six-county Chicago region and northwestern Indiana. Chicago Wilderness is also a partnership of more than 150 public and private organizations whose goals are to protect, restore and manage these lands. The Education and Communication Team of Chicago Wilderness works to increase and diversify public participation in and the understanding of the region's biodiversity by developing collaborative education programs, events and professional development opportunities. They disseminate existing and newly developed educational materials/programs/information through training and appropriate channels. Educators may access many biodiversity teaching tools through Chicago Wilderness.

### Illinois Department of Natural Resources

Division of Education  
One Natural Resources Way  
Springfield, IL 62702-1271  
217/524-4126  
<http://dnr.state.il.us>  
[teachkids@dnrmail.state.il.us](mailto:teachkids@dnrmail.state.il.us)

The Illinois Department of Natural Resources' Division of Education is responsible for the development, training and dissemination of educational programs and events; and for providing hands-on outdoor education and recreational programming for park visitors. The Division works closely

with educators, state agencies and other groups to ensure that environmental education goals are being met. The Division of Education develops and distributes a variety of biodiversity and other environmental education materials. All materials are correlated to the Illinois Learning Standards. For monthly updates on new materials and scheduled workshops visit <http://dnr.state.il.us/lands/education/monthly.htm>.

### World Wildlife Fund

1250 24th Street, NW  
Washington, DC 20037  
<http://www.worldwildlife.org>

Working with partners around the world, World Wildlife Fund (WWF) developed a Biodiversity Education Framework to help guide people in life-long learning about biodiversity, sustainability and conservation. The core of their *Windows on the Wild (WOW)* program is a series of middle school modules on key topics related to biodiversity, including *Biodiversity Basics*, *Wildlife for Sale*, *Marine Biodiversity* and *Building Better Communities*. Each module contains background information, resource ideas and unit plans for the educator, as well as creative and challenging interdisciplinary activities for students. *WOW* curriculum materials are designed to help students explore the social, political, scientific, economic and ethical issues surrounding biodiversity and to give them the knowledge and skills they need to build a more sustainable future. If you are interested in more biodiversity information, you may want to obtain a copy of the educator and student guides for *Windows on the Wild: Biodiversity Basics* and/or other materials from WWF. *Windows on the Wild: Biodiversity Basics* is available for purchase from Acorn Naturalists (800/422-8886).



## Appendices Action Projects

Many organized action projects to help monitor, maintain and preserve biodiversity are available for you to join. Listed below are a few examples.

### **Illinois EcoWatch Network**

Illinois Department of Natural Resources  
One Natural Resources Way  
Springfield, IL 62702-1271  
217/785-5409  
<http://dnr.state.il.us/orep/inrin/ecowatch/forest/>

Help keep an eye on the environment by becoming a Citizen Scientist with the Illinois EcoWatch Network. Through programs such as RiverWatch, ForestWatch, PrairieWatch, WetlandWatch and UrbanWatch, adult volunteers, high school science teachers and students monitor rivers, forests, prairies and more. Coordinated through the Illinois Department of Natural Resources, the volunteers collect quality data, increase public awareness and promote environmental stewardship. Biological monitoring allows scientists to identify long term changes in the health of ecosystems.

### **Illinois Environmental Protection Agency Lake Education Assistance Program**

Division of Water Pollution Control  
P.O. Box 19276  
Springfield, IL 62794-9276  
217/782-3362  
<http://www.epa.state.il.us/org/bow/>

The Lake Education Assistance Program is part of the education initiative within the Illinois Lake Management Program Act. Funding is provided through Conservation 2000, an environmental protection program signed into law by Governor Jim Edgar in 1995. The program provides up to \$500 for schools or not-for-profit organizations to participate in lake- or watershed-related educational field trips and activities. Projects selected for funding will enhance inland lake or lake watershed education of teachers, students, organizations

and/or the community. Recipients are reimbursed for activities and supplies. Application deadlines are September 30 and January 31 annually.

### **Illinois Middle School Groundwater Project**

SIUE  
P.O. Box 2222  
Edwardsville, IL 62026-2222  
309/672-6906 or 618/692-2446  
[rivers@siue.edu](mailto:rivers@siue.edu)

This cooperative project between many state agencies, local organizations and schools provides opportunities for middle school students to study groundwater through hands-on experiences.

### **Illinois Resource Watch Program**

Illinois Department of Natural Resources  
Office of Law Enforcement  
One Natural Resources Way  
Springfield, IL 62702-1271  
217/782-6431

The Illinois Resource Watch program is a joint effort of the Illinois Department of Natural Resources and the Conservation Police Lodge of the Fraternal Order of Police. It is a multi-faceted program which has a single goal of promoting a sense of stewardship toward the natural resources of our state. Resource Watch is targeted on the local needs and problems of an area's natural resources. Local units have a Conservation Police Officer assigned to them to serve as facilitator. Although each unit might have a different goal or current focus, one aspect of the Resource Watch program is the same throughout Illinois: each participant "adopts" an area for the purpose of environmental protection. As a Resource Watch participant, you are asked to monitor an area for environmental threats such





## Appendices

### Action Projects (continued)

as timber cutting, stream alteration, wetlands alterations or poaching; and for positive environmental signs such as sightings of endangered or threatened species of wildlife. There is a role for everyone in the Resource Watch program. Resource Watch members also have the opportunity to participate in “hands-on” resource management programs. In this manner, you make a positive contribution to our resources and directly observe the results.

#### **Illinois Schoolyard Habitat Action Grant Program**

Illinois Department of Natural Resources  
Division of Education  
One Natural Resources Way  
Springfield, IL 62702-1271  
217/524-4126  
teachkids@dnrmail.state.il.us

Project WILD, Project WILD Aquatic, Project Learning Tree and Project WET are national, supplemental, environmental education programs. Students learn by doing and become actively involved in the world around them. Supported by a gift from the Jadel Foundation, the grant program is based on the idea that youths and teachers who have had contact with these supplemental projects need opportunities to take environmental action. Children, their educators and the community are encouraged to conduct a habitat improvement project on school property. Recipients are granted up to \$600 and the opportunity to receive free seedling stock and technical assistance from the Illinois Department of Natural Resources. Applications are due October 15 each year, and successful applicants are notified by December 1.

#### **Kankakee River Project**

Northern Illinois Anglers' Association  
P.O. Box 188  
Bourbonnais, IL 60914

Since 1983, the Northern Illinois Anglers' Association has sponsored the Annual Kankakee River and Streams Clean Sweep Outing. One of the most extensive pro-

grams of its kind in the nation, the outing involves volunteers from scouting and community groups, sportsmen's clubs and school organizations. Volunteers are assigned sections along a 60-mile stretch of the river. An emphasis is placed on collecting cans, bottles, paper litter and other easily removed trash. Special crews are formed to deal with larger items of debris.

#### **Ohio River Sweep and RiverWatchers**

ORSANCO  
534 Kellogg Avenue  
Cincinnati, OH 45228  
1/800/359-3977

The Ohio River Sweep cleanup is held the third Saturday of June each year along the Ohio River and its tributaries. More than 2,100 volunteers from six states bordering the river band together to pick up more than 9,000 tons of debris. The Sweep is organized by the Ohio River Valley Water Sanitation Commission (ORSANCO). RiverWatchers, a citizen volunteer monitoring program was initiated in 1992 and involves students from grades K-12 in the collection of water samples.

#### **Rivers Project**

SIUE  
P.O. Box 2222  
Edwardsville, IL 62026-2222  
618/692-2446  
rivers@siue.edu

The Rivers Project is an integrated, multi-dimensional science, social science, mathematics and language arts project developed to introduce water quality dimensions into the nation's high schools. Educators attend a week-long summer session to learn sampling techniques. Teachers and their students conduct water quality tests, learn about the cultural and historic impact of the river, assess data and write about rivers.



## Appendices

# Distribution Information for *Illinois Biodiversity Basics*

Copies of *Illinois Biodiversity Basics* may be obtained free of charge from the Illinois Department of Natural Resources and Chicago Wilderness. *Illinois Biodiversity Basics* is available to educators upon request or through training sessions. Contact either of the following addresses for more information or a copy of this activity guide.

### **Chicago Wilderness**

Education and Communication Team

312/665-7444

<http://www.chicagowilderness.org/educators.html>

### **Illinois Department of Natural Resources**

Division of Education

One Natural Resources Way

Springfield, IL 62702-1271

217/524-4126

[teachkids@dnrmail.state.il.us](mailto:teachkids@dnrmail.state.il.us)

*Illinois Biodiversity Basics* is also accessible at the following Internet address:

<http://dnr.state.il.us/lands/educationILBiodiversityBasics/index.htm>



## Appendices Credits

The following people were instrumental in adapting *Illinois Biodiversity Basics* from World Wildlife Fund's *Windows on the Wild: Biodiversity Basics*. Their dedication has made this publication possible.

Lisa Berg, Morton Arboretum, Lisle, Illinois  
Nan Buckardt, Lake County Forest Preserves, Deerfield, Illinois  
Peter Clay, Lincoln Park Zoo, Chicago, Illinois  
Carol Fialkowski, The Field Museum, Chicago, Illinois  
Judy Fitchett, The Conservation Foundation, Naperville, Illinois  
Nanette Flynn, Chicago Park District, Chicago, Illinois  
Warren Gartner, Indiana Project WILD, Indianapolis, Indiana  
Terry Gillespie, Village of Lincolnshire, Lincolnshire, Illinois  
Elizabeth Hagen, Kane-DuPage Counties Soil and Water Conservation District, St. Charles, Illinois  
Meg Helmes, Seneca Park Zoo Society, Rochester, New York  
Lynn Hepler, Lake County Forest Preserves, Deerfield, Illinois  
Rebecca Holmquist, The Children's Museum of Indianapolis, Indianapolis, Indiana  
Barbara Hosler, U. S. Fish and Wildlife Service, Bloomington, Indiana  
Michelle Johnson, Shedd Aquarium, Chicago, Illinois  
Valerie Keener, Illinois Department of Natural Resources, Springfield, Illinois  
Christine Kirk, Indiana Dunes Environmental Learning Center, Chesterton, Indiana  
Rana Kreterfield, Chicago Academy of Sciences, Chicago, Illinois  
Priscilla Meldrim, Fermi National Accelerator Laboratory, Batavia, Illinois  
Mary Mickus, Jurica Nature Museum, Benedictine University, Lisle, Illinois  
Stacy Miller, Illinois Department of Natural Resources, Ingleside, Illinois  
Chris Molzahn, The Field Museum, Chicago, Illinois  
Betty Olivolo, World Wildlife Fund, Washington, D. C.  
Lanis Petrik, Brookfield Zoo, Brookfield, Illinois  
Betsy Quail, The Field Museum, Chicago, Illinois  
Janice Schnobrich, Consultant, Lake Bluff, Illinois  
Sean Shaffer, Chicago Park District, Chicago, Illinois  
Tori Trauscht, Liberty Prairie Conservancy, Grayslake, Illinois  
Jan Ward, Lake County Forest Preserves, Deerfield, Illinois  
Dan Werner, Pringle Nature Center, Bristol, Wisconsin  
Ingrid West, Lake County Soil and Water Conservation District, Grayslake, Illinois  
Tara Wisnewski, The Environmental Learning Center, Mokena, Illinois



## Appendices

### Illustration List By Common Name and By Page Number

amphipod .....	28	pin oak .....	37, 99	28 .....	tick
bald eagle .....	71	pitcher plant .....	40	28 .....	spider
barnacles .....	28	praying mantis .....	19	28 .....	scorpion
beaver .....	74	rabbit .....	17	30 .....	channel catfish
bee .....	14, 18, 20, 140	river otter .....	88	33 .....	hooded merganser
beetle .....	28	robin, American .....	8	34 .....	ladybird beetle
blackpoll warbler .....	16, 22	ruby-throated hummingbird .....	23	35 .....	morels
broadleaf arrowhead .....	122	sandhill crane .....	165	37, 99 .....	pin oak
bullfrog .....	39	scorpion .....	28	38 .....	coyote (tracks)
butterfly .....	4, 13	snapping turtle .....	167	39 .....	bullfrog
centipede .....	28	sphinx moth .....	94	40 .....	pitcher plant
channel catfish .....	30	spider .....	28	40 .....	monarch butterfly
cicada .....	67	squirrel .....	21	48, 49, 52 .....	white-tailed deer
coyote (tracks) .....	38	sunflower .....	142	64 .....	mink
crayfish .....	28	tick .....	28	67 .....	cicada
dogwood .....	95	white-tailed deer .....	48, 49, 52	71 .....	bald eagle
dragonfly .....	28, 73			74 .....	beaver
elk .....	100	3 .....	great horned owl	88 .....	river otter
fern .....	151	4, 13 .....	butterfly	92 .....	mussel
fox .....	111	8 .....	robin, American	93 .....	mouse
grasshopper .....	17, 42	14, 18, 20, 140 .....	bee	93 .....	long-eared owl
great horned owl .....	3	16, 22 .....	blackpoll warbler	94 .....	sphinx moth
greater prairie-chicken .....	102, 106	17 .....	rabbit	95 .....	dogwood
hooded merganser .....	33	17, 42 .....	grasshopper	97 .....	Joe-Pye-weed
horseshoe crab .....	28	19 .....	praying mantis	100 .....	elk
Joe-Pye-weed .....	97	21 .....	squirrel	102, 106 .....	greater prairie-chicken
ladybird beetle .....	34	23 .....	ruby-throated hummingbird	111 .....	fox
long-eared owl .....	93	25 .....	northern water snake	122 .....	broadleaf arrowhead
mallard .....	139	28 .....	beetle	137 .....	mayfly
mayfly .....	137	28 .....	crayfish	139 .....	mallard
mink .....	64	28 .....	centipede	142 .....	sunflower
monarch butterfly .....	40	28 .....	barnacles	151 .....	fern
morels .....	35	28 .....	amphipod	165 .....	sandhill crane
mouse .....	93	28, 73 .....	dragonfly	167 .....	snapping turtle
mussel .....	92	28 .....	horseshoe crab		
northern water snake .....	25				



## Appendices

### Activities (alphabetical order)

Backyard BioBlitz .....	31	Nature of Poetry, The .....	62
Career Moves .....	147	Secret Services .....	72
Case of the Greater Prairie-Chicken, The .....	101	Sizing Up Species .....	19
Endangered Species Gallery Walk .....	88	Space for Species .....	111
Future Worlds .....	134	Spice of Life, The .....	67
Gene Scene, The .....	43	What's Your Biodiversity IQ? .....	8