

Navistar, Inc.

**South Slip Sediment
Cap Design Report**

Former Wisconsin Steel Works Site
Chicago, Illinois

June 2012



Mark Graveling, PE
Engineer of Record

Eric Hritsuk, PE
Project Engineer

Gregory A. Vanderlaan
Project Manager

**South Slip Sediment
Cap Design Report**

Former Wisconsin Steel Works
Site, Chicago, Illinois

Prepared for:
Navistar, Inc.

Prepared by:
ARCADIS US, Inc.
10 S. Riverside Plaza
Suite 1900
Chicago, Illinois 60606
Tel 312.575.3700
Fax 312.775.9322

Our Ref.:
CI000664.0037.0001

Date:
June 2012

This document is intended only for the use of the individual or entity for which it was prepared and may contain information that is privileged, confidential and exempt from disclosure under applicable law. Any dissemination, distribution or copying of this document is strictly prohibited.

1. Introduction	1
1.1 Purpose	1
1.2 Report Organization	1
1.3 Site Description	2
1.4 Regulatory History	3
1.5 Current Land Use	3
1.6 Remedial Action Plan	4
1.7 Remedial Objective and Description of Capping Remedy	4
2. Pre-Design Investigation Activities	6
2.1 Previous Investigations	6
2.2 Summary of Risk	6
2.2.1 Phase I Risk Assessment	6
2.2.2 Phase II Risk Assessment	7
2.3 Pre-Design Investigation	7
2.3.1 Bathymetric Survey	7
2.3.2 Side Scan Sonar Survey	7
2.3.3 Sediment Probing Investigation	8
2.3.4 Velocity Measurements	8
2.3.5 Shoreline Support Stability	8
2.3.6 Surface and Subsurface Geotechnical Samples	9
3. Basis of Design	11
3.1 Cleanup Objective	11
3.2 Sediment Cap Design	12
3.3 Geotechnical Analysis	14
4. Pre-Remediation Activities	16
4.1 Permits	16
4.2 Procurement of a Remediation Contractor	18

4.3	Pre-Mobilization Submittals	19
4.4	ARCADIS Supporting Documentation	21
4.4.1	Health and Safety Plan	21
4.4.2	Construction Quality Assurance Plan	21
5.	Remediation Activities	22
5.1	Mobilization and Site Preparation	22
5.1.1	Utility Clearance	22
5.1.2	Traffic Control	23
5.1.3	Temporary Support Facilities/Services and Material Handling Area	23
5.1.4	Site Control and Safety Measures	24
5.1.5	Stormwater and Erosion Control Protection	24
5.1.6	Turbidity Control Measures and Monitoring	24
5.1.7	Site Clearing	25
5.1.8	Survey Control	25
5.2	Cap Installation	25
5.2.1	Erosion Control Systems Inspections	25
5.2.2	Sub-Aqueous Debris Removal	26
5.2.3	Sediment Capping	26
5.2.4	Water Column Monitoring	27
5.2.5	Turbidity Control Systems Inspections	29
5.2.6	Cap Placement and Quality Assurance	29
5.3	Demobilization and Site Restoration	30
6.	Post-Remediation Activities	31
6.1	Remedial Action Completion Report	31
6.2	Institutional Controls	32
7.	Schedule	34
8.	References	35

Tables

Table 1. DR Organization	1
Table 2. Results of Probing Investigation	
Table 3. Velocity Measurements	
Table 4. Geotechnical Boring Locations and Depths	10
Table 5. Summary of PAH Data	11
Table 6. Summary of Applicable Permits	17

Figures

1	Site Location Map
2	Site Aerial
3	Bathymetric Survey Data Elevation Contours
4	Side Scan Sonar Mosaic
5	Sediment Probing Locations
6	Velocity Monitoring Locations
7	Geotechnical Sampling Locations

Appendices

A	Site Photos
B	Design Drawings
1	General Notes and Abbreviations
2	General Site Plan
3	Site Preparation and Environmental Controls Plan
4	Debris Removal Plan
5	Sediment Cap Installation Plan
6	South Slope Typical Sections
7	Miscellaneous Details

C	Cap Material Design and Assessment
D	Sediment Consolidation, Slope Stability, and Sediment Bearing Capacity Evaluations
E	Development of Background Threshold Values
F	Construction Quality Assurance Plan

1. Introduction

1.1 Purpose

ARCADIS has prepared this South Slip Sediment Cap Design Report (DR), on behalf of Navistar, for sediment capping activities to be performed at the former Wisconsin Steel Works (WSW) site (Site). This document presents the cap design for sediments located in the South Slip of the Site.

This DR has been prepared in accordance with: the Illinois Environmental Protection Agency (EPA) Site Remediation Program (SRP), the Remedial Action Plan (RAP; ARCADIS 2011), as submitted to the Illinois EPA in September 2011, and applicable United States Environmental Protection Agency (USEPA) guidance for contaminated sediment remediation (USEPA 2005; Palermo *et al.* 1998).

1.2 Report Organization

A summary of the organization of this DR is presented in Table 1 below.

Table 1. DR Organization

Section	Description
Section 1 – Introduction	Presents site background information and an overview of the activities to be performed to achieve the DR objectives.
Section 2 – Pre-Design Investigation Activities	Summarizes the results of the pre-design investigation that was performed to support the development of this DR.
Section 3 – Basis of Design	Summarizes the basis of design for the cap including transport modeling, erosion protection design, and geotechnical considerations based on the results of the pre-design investigation.
Section 4 – Pre-Remediation Activities	Identifies the activities anticipated to be performed prior to the initiation of remedial construction.
Section 5 – Remediation Activities	Summarizes the remedial construction activities to be performed.
Section 6 – Post-Remediation Activities	Identifies the activities to be performed following the completion of remedial construction.
Section 7 – Schedule	Presents the anticipated schedule for implementation.
Section 8 – References	Provides a list of references used in preparation of this DR.

1.3 Site Description

The Site is located in an industrialized area of Chicago adjacent to the Calumet River (Figure 1) and contains two barge slips (the North¹ and South Slips [the slips]) that were historically used for shipping raw materials to the Site for use in steel production and shipping finished steel products from the Site. The Site produced steel from 1875 to 1980 (USFWS 1994). Operations were expanded during the 1930s to become a fully integrated steel manufacturing facility, and by 1966, over one million tons of steel were produced per year at the Site. All operations ceased in 1982, and the site buildings were demolished in anticipation of developing the property for alternative commercial uses (ARCADIS 2006).

The South Slip is oriented east to west lengthwise and is approximately 900 feet long and 175 feet wide with water depths up to 25 feet. The north side of the South Slip consists of a timber-supported concrete dock; the west side of the South Slip consists of a sheet pile wall; the south side of the South Slip consists of an earthen slope; and the east side of the South Slip is open to the Calumet River (Figure 2). Site photographs are included in Appendix A.

The South Slip and the section of the Calumet River adjacent to the Site represent highly disturbed aquatic environments that have been used extensively for bulk cargo transport, effluent discharge, and other industrial activities. The South Slip is surrounded by industrial property, and is not located in an area such that recreational exposure to sediments, water, or resident biota in the South Slip would occur.

Although the South Slip is connected to the Calumet River based on visual observations and/or flow measurements during the United States Fish and Wildlife Service (USFWS) July 1993 site activities (USFWS 1994), ARCADIS November 2008 sampling conducted for the Phase I Risk Assessment (RA; ARCADIS 2009), and March 2011 sampling events (Section 2.3), no flow has been observed.

Calumet Harbor and the Calumet River are maintained by the United States Army Corps of Engineers (USACE) – Chicago District. The Calumet River consists of a 27-foot deep navigation channel that runs about 7 miles inland from Lake Michigan to

¹ The North Slip received an Illinois EPA No Further Remediation (NFR) Letter in 2011 and is no longer owned by Navistar and will not be addressed as a part of this DR.

Lake Calumet. The South Slip is adjacent to this channel approximately 3 miles downstream from Lake Michigan. Principal commodities transported on the Calumet River include taconite, limestone, cement, chemical fertilizers, petroleum products, grains, steel, salt, and miscellaneous freight.

Navigation depths for the Calumet River are referenced to Low Water Datum 1985. The actual navigation depths may vary due to fluctuations in the level of Lake Michigan and the occurrence of shoaling within the navigation channel. Complete navigational dredging within the Calumet River was last performed in 2003 with segments dredged in 2011 (USACE 2011).

1.4 Regulatory History

The former WSW facility has been non-operational since 1982, and all of the on-site above-grade structures have been demolished and removed from the Site. Initial mill demolition, removal, and environmental investigation activities were managed and directed by the United States Department of Commerce Economic Development Administration (EDA) and the USACE. EDA and Navistar became beneficiaries of the Wisconsin Steel Trust, which was created in 1981 when the then-owner of the Site, Envirodyne, Inc., filed for bankruptcy.

In September 1994, Navistar entered into the 1994 Settlement Agreement with EDA in which Navistar, among other things, assumed responsibility for addressing all site environmental cleanup needs. The agreement required Navistar to enter into a state court enforceable consent order and enroll the Site in the Illinois SRP. Accordingly, Navistar entered into a Consent Order with the State of Illinois in December 1996, which defined Navistar's participation in the Illinois SRP regarding the Site and provides a framework for the relationship between the Illinois EPA and Navistar in the program.

1.5 Current Land Use

Steel production activities at the WSW facility ceased in 1982. All storm drains and outfalls from the former WSW facility to the South Slip have been sealed (ARCADIS 2006). The South Slip is currently being used by Kindra Lake Towing for temporary mooring of barges. Tugs are used to move these barges. The number of barges in the South Slip varies daily. Loading and unloading activities are not currently occurring. It is anticipated that the South Slip will be used for similar activities in the future, although

unlike the current situation, in the future, material may be loaded and unloaded from barges.

1.6 Remedial Action Plan

The South Slip RAP (ARCADIS 2011) was prepared in accordance with the SRP rules consistent with Title 35 Illinois Administrative Code (IAC) Section 740.450. The South Slip RAP presented the remedial technology evaluation and selection process. Diffusive transport, bioturbation, channel flow velocities, wind waves, vessel wake, water depths for navigation, slope stability, consolidation, presence and types of debris, maintenance dredging for navigation, and permitting requirements were preliminarily assessed to confirm that a sediment cap was a feasible remedial technology. The RAP conceptually recommended a 2-foot-thick layer of sand to achieve the remedial objective of eliminating exposure pathways by isolating and separating the impacted sediment from surficial ecological receptors. By reducing the availability of impacted sediment to the benthic community, it is projected that fish tissue polycyclic aromatic hydrocarbon (PAH) concentrations will decrease and reduce the potential human health risk from consuming fish. Therefore, capping addresses both the ecological and human health risk identified in the Phase II RA (ARCADIS 2010). However, it was noted in the RAP that further evaluation would be warranted to finalize and optimize the cap design; that evaluation is presented in this DR.

1.7 Remedial Objective and Description of Capping Remedy

Specific cleanup targets for sediment, porewater, surface water, or fish tissue have not been established for the South Slip. The Phase II RA (ARCADIS 2010) established PAHs as the primary risk-driving constituents of concern (COCs) for ecological receptors and sediment and porewater as the primary risk-driving media. The Phase II RA (ARCADIS 2010) also identified potential human health risk from consuming fish tissue based on conservative assumptions.

The objective of the remedial action is to eliminate exposure pathways by isolating and separating the impacted sediment from potential surficial ecological receptors. It is expected that this remedial action will also reduce exposure to anglers that may consume fish from the South Slip. The remedial action will include a sediment cap to retard the transportation of dissolved-phase constituents through the cap. The remedy is designed to maintain PAH concentrations at the top of the isolation layer of the cap (i.e., 12 inches above the native sediment surface) at levels consistent with or below

background concentrations (see Section 2.2 for additional information) for the designated project lifespan as defined in Section 3.

The selected remedy includes:

- Placement of a minimum 1-foot-thick sand cap layer with a minimum of 2% total organic carbon (TOC; i.e., the isolation layer) to separate the benthic community from the impacted sediments and retard the transport of dissolved-phase contaminants through the cap, and installation of a minimum 6-inch armoring layer of stone to protect the isolation layer against potential erosion (for a minimum total cap thickness of 1.5 feet).
- Establishment of a quality assurance (QA) program to confirm that the designated cap thickness is placed with minimal impact and subsequently maintained.
- Institutional controls designed to maintain the integrity of the cap.

Appendices are included to supplement the contents of this DR. These appendices provide additional information related to the design and implementation of the remedial action and include the following:

- Site Photos (Appendix A)
- Design Drawings (Appendix B)
- Cap Material Design and Assessment (Appendix C)
- Sediment Consolidation, Slope Stability, and Sediment Bearing Capacity Evaluations (Appendix D)
- Development of Background Threshold Values (Appendix E)
- Construction Quality Assurance Plan (Appendix F)

Technical specifications for construction of the cap are included on the Design Drawings in Appendix B.

2. Pre-Design Investigation Activities

This section identifies the previous investigations performed at the South Slip. The applicable results of these chemical, physical/geotechnical, and other pre-design investigations (PDIs) are summarized below.

2.1 Previous Investigations

The South Slip has been the subject of a series of investigations since 1994. The results of these investigations were used in the RAP to determine the feasibility of sediment capping in the South Slip and are summarized in Sections 1.3, 2.1, and 2.2 of the RAP (ARCADIS 2011). Pre-design investigation data were collected for use in designing the cap and are detailed in Section 2.3.

2.2 Summary of Risk

This section summarizes the results of the Phase I and Phase II RAs conducted for the South Slip. A detailed description of the Phase I and Phase II RAs is included in Sections 2.1 and 2.2 of the RAP (ARCAIDS 2011).

2.2.1 Phase I Risk Assessment

The Phase I RA was conducted following appropriate USEPA guidance by ARCADIS in June 2009 (ARCADIS 2009) to evaluate potential adverse risk to human health and fish exposed to COCs in sediment from the North Slip and the South Slip. Only bioaccumulative and persistent chemicals were considered constituents of potential ecological concern (COPECs). Although bioaccumulative chemicals such as pesticides, mercury, and polychlorinated biphenyls (PCBs) were detected in sediment samples from the South Slip, only PCBs were evaluated in the RA as the other compounds were found in lower concentrations than background concentrations. This RA quantitatively evaluated cancer risks and non-cancer hazards associated with potential human exposure to PCBs in fish tissue as well as potential risk to fish communities in the slips.

The Phase I RA, for both North and South Slips, did not identify risk to fish or human receptors. Illinois EPA reviewed the Phase I RA and directed ARCADIS to prepare a supplemental RA that focused only on the South Slip and expanded upon the analysis performed in the Phase I RA.

2.2.2 Phase II Risk Assessment

The Phase II RA was conducted by ARCADIS in September 2010 (ARCADIS 2010) to evaluate any potential adverse risk to human health and ecological receptors exposed to COPECs in site media from the South Slip. This RA was based on information from the Phase I RA (ARCADIS 2009) and expanded to incorporate more site-specific data and address agency comments. The Phase II RA was performed only on the South Slip. Surface sediment, porewater, and forage fish tissue samples collected from the South Slip and from background as a part of the Phase I RA (ARCADIS 2009) were used as the data set for the Phase II RA. The COPECs identified in sediment and evaluated included PAHs and PCBs including Aroclor 1248, Aroclor 1254, and Aroclor 1260.

Potential risk to benthic invertebrates, fish, and aquatic wildlife was identified based on PAH concentrations in the sediment and porewater. Under the most conservative assumptions, potential risk to the benthic and fish communities presented a human health risk for anglers consuming fish from the South Slip. Navistar and the Illinois EPA agreed that the remedial action performed on the South Slip would address both human and ecological receptors.

2.3 Pre-Design Investigation

A PDI was completed between March 28 and 31, 2011. The PDI included a bathymetric survey, side scan sonar survey, sediment probing, velocity measurements, visual observation of the surrounding support structures, and collection of geotechnical samples (surface and subsurface sediment).

2.3.1 Bathymetric Survey

Ocean Surveys Inc. (OSI) performed a multibeam bathymetric survey to map the sediment elevation on the floor of the South Slip on March 28 and 29, 2011 (Figure 3). The sediment surface slopes from less than 5 feet below the water surface in the western end of the South Slip to approximately 25 feet in the eastern end of the South Slip.

2.3.2 Side Scan Sonar Survey

OSI performed a side scan sonar survey of the South Slip on March 28 and 29, 2011 (Figure 4). The side scan sonar survey was performed to identify debris or other

potential obstructions on the sediment surface. Although debris was observed in the area, there were no utility lines or outfalls detected within the South Slip. Prior to implementing the remedial action at the Site, additional lines of evidence will be pursued to confirm this observation. Debris targets that have been identified for removal prior to cap placement are shown on Design Drawing 4 (Appendix B), and generally include any debris that protrudes above the sediment surface more than 1 foot.

2.3.3 Sediment Probing Investigation

ARCADIS collected sediment thickness measurements from 15 locations in the South Slip on March 28, 2011 (Figure 5). Measurements were collected along five parallel north-south transects spaced approximately 200 feet apart consisting of three probing locations per transect. A metal probing rod was pushed by hand to refusal. Sediment thickness ranged from 0.2 to 20.4 feet. The sediment was generally at least 10 feet thick, consisted of soft, elastic silt, and was underlain by hard clay. See Table 2 for additional information.

2.3.4 Velocity Measurements

ARCADIS collected water velocity measurements from seven locations in and around the South Slip on March 28, 2011 (Figure 6). Measurements were collected along two transects – an east-west transect along the center line of the South Slip and a north-south transect at the mouth of the South Slip. Velocity measurements were collected using a handheld velocity flowmeter. Velocity measurements were collected from 0.2, 0.5, and 0.8 times the total water column depth. Velocity measurements ranged from 0.01 feet per second (ft/s) to 0.13 ft/s. See Table 3 for additional information.

2.3.5 Shoreline Support Stability

Visual observation of shoreline support structures was performed on March 31, 2011. The north side of the South Slip consists of a timber-supported concrete dock; the west side of the South Slip consists primarily of a sheet pile wall; the south side of the South Slip consists of an earthen slope; and the east side of the South Slip is open to the Calumet River. The timber piers on the north side of the South Slip were installed vertically and have horizontal timber planks attached both on the inside and outside of the piers. Due to the horizontal wooden planks, ARCADIS was not able to probe behind or under the piers to investigate the slope and sediment behind the vertical timber piles. At the time of the investigation, the water level in the South Slip was

approximately 6 inches lower than the concrete dock, which made observation of the support structures difficult. The south side of the South Slip is constructed of intermittent sheet piling, timber piling, vegetation, cobble-sized rock, and wooden piers with concrete. These structures are all located underneath the earthen slope and are only visible near the surface of the water. The earthen slope is generally a 45-degree slope with intermittent locations eroded at the water interface (approximately 90 degrees).

2.3.6 Surface and Subsurface Geotechnical Samples

In-water geotechnical borings were completed and sampled between March 29 and March 31, 2011 by RD-n-P Drilling, Inc., of Wheatfield, Indiana, and ARCADIS for geotechnical characterization of the soft sediment to support evaluation of remedial alternatives within the South Slip. A total of eight in-water geotechnical borings were completed as shown on Figure 7.

In-water geotechnical borings were completed with a barge-mounted Mobile B 4300 Truck Rig. Geotechnical borings were completed using a combination of 4-inch hollow stem auger casing, standard penetration test, and relatively undisturbed Shelby tube and Osterberg samplers. CL-01 through CL-08 were installed at the coordinates and to the depths listed in Table 4. Borings CL-06, CL-7, and CL-08 were advanced to depths greater than 10 feet to provide geotechnical data for deeper sediment near the mouth of the South Slip. Geotechnical sampling results are included in Appendix D.

Table 4. Geotechnical Boring Locations and Depths

Boring	Northing	Easting	Depth to Sediment (ft)	Depth of Boring (ft bss)
CL-01	1832118.3	1196495.4	11	10
CL-02	1832126.7	1196879.7	16	10
CL-03	1832051.9	1196354.0	6	10
CL-04	1831985.5	1196493.3	9	10
CL-05	1832041.8	1196645.4	16	10
CL-06	1831980.2	1197083.1	13	16
CL-07	1831988.0	1197332.8	13	16
CL-08	1832120.7	1197315.1	18	14

Notes:

bss = below sediment surface

ft = feet

Coordinates are based on the North American Datum of 1983, Illinois East Zone, U.S. Survey Foot.

Elevations are based on the North American Vertical Datum of 1988.

Geotechnical samples indicate that the sediments encountered at the South Slip are typically at least 10 feet thick, soft, elastic silt, with dry density typically ranging from approximately 40 to 62 pounds per cubic foot. These soft sediments are underlain by very stiff to hard silt and clay.

3. Basis of Design

3.1 Cleanup Objective

The chemical data used in this DR were collected by ARCADIS in October and November 2008 as a part of the Phase I RA (ARCADIS 2009). Samples collected from the South Slip during the 2008 sampling event were used in the Phase II RA (ARCADIS 2010) to determine that a remedial action is required in the South Slip. The background data are used to define the cleanup objective.

Ten sediment samples were collected from the South Slip and nine² background samples were collected from Turning Basin 1 of the Calumet River. Samples were collected from 0 to 6 inches to characterize the biologically active zone. Several analytical suites were analyzed including metals, PAHs, PCBs, geotechnical parameters, and sediment toxicity testing. According to the Phase II RA (ARCADIS 2010), PAHs are the primary COC and therefore were used to define the cleanup objective. Table 5 summarizes the South Slip and background total PAH data.

Table 5. Summary of PAH Data

Location	South Slip	Background
Maximum Concentration (mg/kg)	2,800	75
Minimum Concentration (mg/kg)	290	35
Median Concentration (mg/kg)	540	38
Mean Concentration (mg/kg)	806	43

Notes:

mg/kg = milligrams per kilogram

² Ten background samples were proposed; however, hard-packed sediment present at proposed sample location BK-06 prevented sample collection.

The cap has been designed to maintain PAH concentrations at the top of the isolation layer (i.e., 12 inches above the native sediment surface) at levels consistent with or below target background concentrations for the designated project lifespan.

A PAH Background Threshold Value (BTV) for the nine background samples was calculated and selected based on an objective decision process. This approach involved goodness-of-fit evaluations and probability plots used to: a) determine the overall distribution of each data set; and b) identify potential outliers that could elevate the BTV. Potential outliers were tested statistically and a 95/95 Upper Tolerance Limit was calculated with and without statistical outliers when applicable. The BTV for total PAHs is 400 mg/kg. The methodology for generating the BTV is included in Appendix E. The project lifespan and cap design process are further described Section 3.2.

3.2 Sediment Cap Design

As discussed, the sediment cap to be placed as a part of the remedial action will be comprised of two specific layers of clean material: a minimum 1-foot layer of sand with 2% TOC, and an overlying 6-inch layer of armoring stone.

The proposed cap has been designed to provide physical isolation of the native material, and retardation of the potential transport of dissolved-phase constituents from the native material to the overlying surface water column. In addition, the proposed cap includes an armor layer to withstand scour forces anticipated in the South Slip, post-construction. In designing the sediment cap, particular consideration was given to the anticipated post-remediation use of the South Slip and the site-specific risk assessment, as discussed in Section 2.2.

Breakthrough modeling was performed to assess the potential for dissolved-phase constituents from the underlying sediment to migrate into and through the cap. A number of conservative assumptions were incorporated into the model, including, but not limited to:

- Chemical characteristics of the underlying sediments are represented by the highest PAH concentration observed in the available analytical data collected for the Site.
- Any available PAH mass in the sediment is assumed to behave similar to naphthalene – an individual PAH compound that is the most hydrophilic and therefore most mobile of the individual PAHs.

- Partitioning to dissolved organic carbon fractions was limited.

Performance of the cap was assessed based on the number of years before constituent concentrations at the top of the isolation layer (i.e., 12 inches above the native sediment surface) approached the BTV, as discussed in Section 3.1. The numeric model allows for the assessment of performance of the cap given varying cap thicknesses assuming a specific TOC content associated with the cap material. The model predicts that a 1-foot layer of material containing 2% TOC would prevent PAH concentrations at the top of the 1-foot isolation layer from approaching the BTV for more than 100 years. A complete discussion of the cap breakthrough modeling assessment is provided in Appendix C.

Scour protection modeling was performed to assess the effect of tug traffic associated with barge movement in the slip on the sediment cap. Information was gathered related to the anticipated post-remediation use of the South Slip. As part of the scour protection modeling, conservative assumptions were made with regard to potential boat size/horse power, throttle duration, and water depth to estimate resulting propeller wash. The results of the propeller wash modeling indicate that an armor layer consisting of a stone with a median size (i.e., D_{50}) of 2 inches would limit propeller wash scour to 3 inches or less, depending on the specific vessel operating and/or the duration of operation in a single location, in the portion of the South Slip in which vessel traffic will be allowed post-remediation (i.e., conservatively estimated to be the portion of the South Slip with 11 feet or greater of water depth post-construction; see Section 6). A complete discussion of the propeller wash and scour protection assessment is provided in Appendix C.

In addition, in the event that scour does occur, it is anticipated that the armor layer will generally be self healing in nature. Although up to 3 inches of scour may occur in isolated locations within the protective stone layer, the scoured material will likely remain within the remedial footprint either temporarily suspended in the water column or temporarily relocated to an adjacent area of the floor of the South Slip. In time, the suspended or relocated armor material is expected to settle back into any low-lying (i.e., scoured) areas, thus self-healing the protective layer of the sediment cap. In addition, any natural deposition that may occur in the slip will also contribute to the self-healing nature of the sediment cap, and will result in the stone material silting in over time.

3.3 Geotechnical Analysis

The material parameters used in the geotechnical analysis were derived from samples collected by ARCADIS during pre-design activities in March 2011 (see Section 2.3.6). The laboratory testing was performed on the relatively undisturbed and disturbed sediment samples to determine the relevant material parameters.

Thirty-three sediment samples were collected from three sediment borings within the South Slip and evaluated by a geotechnical laboratory. Samples were collected from 0 to 16 feet below the sediment surface. The collected material and data were used to determine the samples' classification, density, consistency, unit weight, plasticity, consolidation parameters, shear strength, and organic content. The results of the field observations and laboratory testing were used to create the subsurface profiles evaluated in the geotechnical analyses (Appendix D). Project bathymetric data were used to determine the existing slope geometries. The final graded slopes and weight of the cap have been designed to maintain geometric stability and cap integrity both during construction and for the intended design-life of the cap.

Bearing capacity and slope stability were examined for both the intermediate (during construction), and completed (post-construction) phases. Consolidation was examined for the completed phase only. The results of these analyses indicate that the designed slope angles, bearing capacity, and anticipated consolidation within the soft sediments should neither damage the cap nor cause it to significantly "slough" in any location of the South Slip.

The bearing capacity of the soft sediments was evaluated for both the short-term (undrained) and long-term (drained) porewater pressure conditions. The bearing capacity of the sand cap was evaluated to verify that the sand cap would have adequate bearing capacity during placement of the scour-protective layer. Local and global failure states were considered in each analysis. The resulting factor of safety against bearing failure was determined to be 4.4 for the maximum cap/fill thickness to be used during construction.

Consolidation of the soft sediments was evaluated using one-dimensional consolidation theory along five cross-sections of cap that were determined to be most critical. The soft sediments will experience one-way drainage because the underlying consolidated sediments will not allow downward migration of water. To determine the possible magnitude of consolidation, however, two-way drainage was used in the analysis. The results of the consolidation evaluation indicate that approximately 1 to 2

inches of settlement is expected in the sediment, with a maximum differential settlement of approximately 0.7 inches. The results of the consolidation evaluation indicate expected consolidation is within allowable cap tolerances to prevent cap failure.

Slope stability was evaluated for the existing, intermediate (during construction), and completed phases. The sediments were modeled using drained and undrained soil parameters to represent the short- and long-term behavior of the slopes. Preliminary stability evaluations suggested that a cap constructed on the steepest section of the southern slopes would not be stable. Granular fill was added to the stability model (and design) to flatten the slope to 2 horizontal (H):1 vertical (V) and improve the performance of the constructed cap. The revised slope design resulted in better slope performance. Results of the slope stability evaluation resulted in a minimum factor of safety of 1.25 for the critical conditions for shallow sloughing of the cap, and factors of safety above 1.4 for deeper slope failures indicative of cap failure. The performance of the 6-inch gravel layer is expected to improve the performance of the cap against shallow surface sloughing.

Based on the calculated factors of safety, periodic maintenance may become necessary depending on influence of barge traffic and other uses of the slip, effects of storm events, and other factors that involve influences that fall outside the assumptions of these analyses. However, it should be noted that institutional and engineering controls (e.g., use restrictions as well as restrictions on anchoring, dredging, development, and other activities that have the potential to disturb the sediment cap) will be implemented to provide long-term mechanisms to protect the constructed sediment cap from the influence of barge traffic and other uses of the slip or other factors that involve influences that fall outside the assumptions of the cap stability analysis, as discussed in Section 6.2, and it is therefore unlikely that maintenance will be necessary.

At the east end of the slip, the cap will taper beyond the limits of the 1.5-foot cap into the existing grade at a 2H:1V slope, and will intersect the existing grade a minimum of 50 feet prior to the steep slope at the mouth of the channel, and therefore will not affect the current stability of this area (Design Drawing 2, Appendix B). Therefore, a stability evaluation was not performed at the mouth of the channel. The tapered area will also incorporate the protective stone layer, which will further improve the stability of this tapered portion on the east end of the slip.

4. Pre-Remediation Activities

This section identifies the activities and procedures to be implemented by Navistar, ARCADIS (i.e., the Engineer), and/or the Contractor prior to the initiation of remediation activities. Such activities include, but are not limited to, the following:

- Obtaining appropriate permits
- Procurement of a Contractor
- Preparation of pre-mobilization submittals

Navistar and ARCADIS will coordinate procurement of a Contractor. Once selected, the Contractor shall be responsible for preparing the pre-mobilization submittals. As discussed below, both ARCADIS (on behalf of Navistar) and the Contractor are responsible for obtaining appropriate permits for implementation of the remedial activities. Additional information regarding each of these pre-remediation activities is provided below.

4.1 Permits

Currently anticipated federal, state, and local permitting requirements for the implementation of the remedial action (based on a review of pertinent regulations) are summarized in Table 6 below. The Contractor must meet the requirements of applicable environmental permits and/or regulations, and all other permits that may be required under local jurisdictions. These permits may include, but are not necessarily limited to, those related to work within the public waterways, public roadways, zoning regulations, and building permits. All appropriate permits must be maintained and copies must be retained at the Site throughout the duration of the project. ARCADIS will obtain the necessary permits associated with local, state, and federal environmental requirements and regulations described below. The Contractor will be responsible for obtaining any other pertinent and applicable local and state permits associated with the performance of the remedial construction activities.

Table 6. Summary of Applicable Permits

Permit	Issuing Agency
Regional Permit 13	USACE
Section 401 Water Quality Certification	Illinois EPA
Individual Permit	Illinois Department of Natural Resources, Office of Water Resources
Harbor Permit	City of Chicago Department of Transportation, Division of Engineering

- Regional Permit (RP) #13, USACE, Chicago District

RP #13 authorizes specific activities required to effect the containment, stabilization, and removal of toxic and hazardous materials and petroleum products that are performed, ordered, or sponsored by a government agency or through court-ordered remedial action plans or related settlements. Compensatory mitigation is required for any cleanup that adversely impacts more than 0.10 acre of waters of the U.S.

- Illinois EPA, Section 401 Water Quality Certification (WQC)

The Section 401 WQC will be applied for jointly with the RP #13. Notification to Illinois EPA Bureau of Water is required.

- Individual Permit, Illinois Department of Natural Resources, Office of Water Resources

Under the Regulation of Public Waters rules, Illinois Administrative Code, Part 3704, an individual permit is required for any filling in any lakes, rivers, streams, and waterways which are or were navigable and are open or dedicated to public use, including all bayous, sloughs, backwaters, and submerged lands connected by water to the main channel or body of water during normal flows or stages. The Calumet River is defined as a public waterway.

- Harbor Permit, City of Chicago Department of Transportation, Division of Engineering

A Harbor Permit is required for any work in and within 40 feet of the Base Flood Elevation of any City of Chicago waterway. Professional Engineer-stamped plans are required with the application.

As part of the City's review process, the Department of Transportation, Division of Engineering will forward the application to the City Department of Environment for review under the City's Flood Control Ordinance. Under the Flood Control Ordinance, a permit is required for an activity in the Special Flood Hazard Area that might change the direction, height, or velocity of flood or surface waters, including filling of waters below the base flood elevation. Per the direction of the Division of Engineering, a separate Flood Control Permit is not anticipated.

4.2 Procurement of a Remediation Contractor

ARCADIS will initiate the Contractor procurement process and solicit bids for the performance of the remediation construction activities. This process will initially involve the preparation and distribution of a Request for Proposal (RFP) to prospective Contractors. The contents of the RFP are anticipated to include a cover letter with instructions to bidders and detailed Measurement and Payment items (including a bid breakdown sheet), ARCADIS' contractual terms and conditions for the contents of the proposal and performance of the work, the anticipated requirements of the permits, the DR, and any supplemental information (e.g., health and safety requirements, historical figures, etc.) that may assist prospective Contractors in the development of their proposals. Additionally, once received, the Contractor will be provided with applicable permits.

Following the distribution of the RFP, a pre-bid meeting and site walk will be conducted with the prospective Contractors, Navistar, and ARCADIS. The pre-bid meeting and site walk will provide prospective Contractors an opportunity to visually examine/verify existing site conditions and thoroughly acquaint themselves with the work required and potential challenges associated with the project to facilitate the preparation of an accurate proposal and work schedule. Following the pre-bid meeting and site walk, prospective Contractors will finalize and submit their proposals to ARCADIS for review, and ARCADIS and Navistar will subsequently select a Contractor and initiate the contracting process.

4.3 Pre-Mobilization Submittals

Once selected, the Contractor will be required to prepare certain pre-mobilization submittals for review by ARCADIS. The purpose of these submittals is to gauge the Contractor's understanding of the DR and its construction, objectives, procedures, and outcomes, and to identify potential misunderstandings and provide clarifications prior to the start of remediation construction activities. The Contractor will not be allowed to mobilize to the Site prior to submittal of all required pre-mobilization submittals to ARCADIS. These pre-mobilization submittals will include the following:

- Operations Plan – The Operations Plan will present the Contractor's detailed approach for implementing the pertinent work activities including, as necessary: materials specifications, site maps, design details, list/schedule of equipment to be used on site, flow diagrams, charts, and schedules. At a minimum, the Operations Plan will include:
 - An Erosion and Sediment Control Plan
 - A description of stormwater (including run-on and run-off), sediment/soil erosion, noise, and dust control measures
 - Specific details related to material handling and staging approach
 - Description of the approach to the installation, operation, and maintenance of turbidity controls, and specific responses to turbidity exceedances
 - Discussion of design details and specifications for the proposed system for placement of the sediment cap and verification of individual lift thicknesses and extents
 - Proposed methods for achieving and maintaining access for boats, barges, and other watercraft (as necessary based on placement method proposed)
 - A description of project progress tracking including an example of daily progress reports summarizing the work activities of the day as well as the performance/results of routine inspections and monitoring
 - A Work Schedule in Gantt chart format

- Contingency Plan – The Contractor will prepare and submit a Contingency Plan as part of the Operations Plan that includes at a minimum the following items:
 - A spill prevention and control and countermeasures plan for all materials brought to the work site
 - Illustration of emergency vehicular access/egress, including routes to hospital(s)
 - Evacuation procedures of personnel from the work site
 - A flood contingency plan to identify measures to protect the work site and adjacent waterway from impacts in the event of high water and/or flood conditions
 - A list of all contact personnel with phone numbers and procedures for notifying each, including ARCADIS, the Contractor, local fire official(s), ambulance service, local/county/state police, and local hospitals.
- Traffic Control Plan (TCP) – The Contractor will be required to prepare and submit a project-/site-specific TCP as part of the Operations Plan to provide details on the Contractor’s approach to the direction and control of construction and local traffic, and a discussion of the potential impacts to local vehicle and pedestrian traffic and any associated mitigation approaches.

At a minimum, the TCP will describe protocols to direct construction traffic to travel to and from the project area along established truck routes. These routes should be selected to provide efficient travel routes for construction vehicles while minimizing the impact on local traffic.

- Health and Safety Plan (HASP) – The Contractor will be required to prepare and submit a project-/site-specific HASP (for use by the Contractor’s on-site personnel during the remediation construction activities) to provide a mechanism for establishing safe working conditions at the Site. The HASP should specifically address the health and safety risks associated with on- and in-water activities, where applicable. The HASP will be prepared in accordance with all applicable rules and regulations, including Parts 1910 and 1926 of Title 29 of the Code of Federal Regulations (29 CFR 1910 and 29 CFR 1926), and will be certified by a Certified Industrial Hygienist. The Contractor is required to take all necessary

precautions for the health and safety of all on-site Contractor employees in compliance with all applicable provisions of federal, state, and local health/safety laws and the provisions associated with the HASP. The Contractor will assume sole responsibility for the accuracy and content of its HASP.

The Contractor must submit a copy of each submittal to ARCADIS within 30 days of the contract award and prior to the commencement of construction activities. Additional information regarding the required contents of these submittals and overall submittal process is presented in Appendix F.

4.4 ARCADIS Supporting Documentation

4.4.1 Health and Safety Plan

ARCADIS will prepare an addendum to the 2008 Environmental Health and Safety Plan (ARCADIS 2008) – which describes the health and safety risk analysis for the proposed activities, a description of required environmental monitoring and personal protective equipment, required medical monitoring, work area controls, and contingency and emergency planning – to include a new project task (South Slip cap construction activities) at the Site, and will provide the 2008 document and the associated addendum to the potential Contractors during the procurement process. The Contractor's HASP shall, at a minimum, meet the requirements set forth within these ARCADIS Health and Safety documents, but should also address requirements specific to the construction-related tasks that the Contractor will perform.

4.4.2 Construction Quality Assurance Plan

A Construction Quality Assurance Plan (CQAP) has been prepared to outline procedures that will ensure that components of the remedial action are conducted and documented with an appropriate level of QA and quality control (QC). The CQAP is included in Appendix F.

5. Remediation Activities

This section summarizes the remedial construction activities to be completed by the Contractor as part of this DR. These activities have been organized into the following remediation tasks:

- Mobilization and Site Preparation
- Cap Installation
- Demobilization and Site Restoration

A description of each task, including references to supporting information provided elsewhere in this DR, is presented below.

5.1 Mobilization and Site Preparation

Following receipt/review of all required pre-mobilization submittals (discussed in Section 4.3) a pre-construction meeting will be held with the selected Contractor. The Contractor will mobilize manpower, equipment, services, and materials to the Site, as necessary to complete the remedial construction activities. Equipment that arrives at the Site will be subject to a visual inspection by ARCADIS. Equipment that arrives at the Site in unsatisfactory condition (e.g., soiled, poor operating condition), in the opinion of ARCADIS or Navistar, will be removed from the Site and replaced by the Contractor. The remainder of this section provides additional tasks and remediation design details related to mobilization and site preparation activities.

5.1.1 Utility Clearance

As part of mobilization, the Contractor will be required to coordinate with an appropriate utility-locating agency to locate, identify, and mark-out all above-ground and underground utilities in and around the Site. As discussed in Section 2.3.2, although no utility lines or outfalls were identified during the pre-design bathymetric survey, additional lines of evidence will be required of the Contractor prior to initiating any work activities. During remedial activities, the Contractor will be responsible for maintaining appropriate clearances from utilities (e.g., active overhead electric lines, underground conduit/piping) and protecting existing site utilities, if any, from damage. If the Contractor damages existing site utilities, the Contractor will be responsible for notifying the appropriate utility company/municipality and fully repairing all damages.

Repairs (if necessary) will be completed in accordance with all requirements of the utility company/municipality and to the satisfaction of the Engineer.

5.1.2 Traffic Control

As discussed in Section 4.3, a TCP will be prepared by the Contractor to provide details related to minimizing potential impacts to the environment and surrounding community, and minimum requirements for the maintenance and protection of highway and pedestrian traffic. It is anticipated that truck traffic associated with the implementation of the remedial action will include construction equipment (e.g., dump trucks and/or tractor trailers), construction worker vehicles, delivery vehicles, and visitor vehicles. The Contractor will establish controls to minimize the impact of remedial action activities on vehicular and pedestrian traffic and preserve the safety of motorists, workers, and pedestrians during remedial construction activities in accordance with the TCP.

5.1.3 Temporary Support Facilities/Services and Material Handling Area

The Contractor will provide/establish and maintain temporary support facilities and services at the Site for use by the Contractor, ARCADIS, site visitors, and an on-site representative for the Illinois EPA, if any, during implementation of the remedial construction activities. Such facilities/services will include field office trailers, portable sanitary facilities (hand wash stations and toilets), potable sources of water, and electrical, telephone, and internet service.

The Contractor will construct a temporary support zone for the staging of equipment and materials during remedial construction activities, as well as temporary access roads to facilitate site access/egress, as necessary. Design Drawing 3 (Appendix B) depicts the existing roadways and site conditions, and provides a conceptual layout for a potential temporary support zone that the Contractor may select for construction. As illustrated on Design Drawing 3, space is available both north and west of the South Slip; however, it should be noted that an engineered soil cover system exists on the north side of the South Slip. As such, if the Contractor chooses to utilize the space on the north side of the South Slip, the Contractor will be required to provide details related to extra precautions (e.g., liners, tundra mats) that will be implemented to minimize the potential for damage to the soil cover system and to restore the engineered soil cover system to pre-existing conditions. Design Drawing 7 (Appendix B) includes typical details related to the construction of temporary support zones and/or typical temporary access roads.

5.1.4 Site Control and Safety Measures

In association with the establishment of temporary support zones, and delineation of the work area, the Contractor will install and maintain site control and safety measures for the duration of remedial construction activities to prevent access to the work area by unauthorized personnel or vehicles. Such measures include temporary site security fencing/gates and project/warning signs, selected and installed in accordance with the Contractor's HASP. Details related to the selection and deployment of appropriate site control measures will be included in the Contractor's Operations Plan.

5.1.5 Stormwater and Erosion Control Protection

The Contractor will install, inspect, and maintain (throughout the remedial construction activities) temporary erosion, sediment, and re-suspension control measures prior to initiating intrusive activities. Such measures will include silt fencing on land and turbidity curtains in water. The temporary erosion, sediment, and re-suspension control measures will be installed (prior to initiating remediation activities), inspected, and maintained in accordance with Design Drawing 3 (Appendix B). The Contractor will prepare and submit an Erosion and Sediment Control Plan as part of the Operations Plan required as a pre-mobilization submittal.

5.1.6 Turbidity Control Measures and Monitoring

Prior to the initiation of construction-related activities, turbidity control measures will be installed at or in the vicinity of the mouth of the South Slip. Such measures will be installed to minimize the potential for transport of solids suspended in the water column from the South Slip to the Calumet River. In this instance, a full-depth silt curtain will be deployed across the entire mouth of the South Slip, as illustrated on Design Drawing 3 (Appendix B). A typical turbidity curtain detail is provided on Design Drawing 7 (Appendix B). Installed silt curtains will be visually inspected on a daily basis by the Contractor and maintained throughout the construction period to maximize their effectiveness. Additional construction details and specifications related to this system, including details related to installation and anchoring will be provided in the Contractor's Operations Plan.

As discussed in Section 5.2.4, water column monitoring will be performed by ARCADIS throughout the duration of construction activities.

5.1.7 Site Clearing

Following the installation of erosion and sediment control measures, and before remedial construction activities begin, the Contractor will clear brush/trees (as necessary and in consultation with Navistar and ARCADIS) to provide access to the work areas and facilitate remedial construction activities. Any such cleared vegetation will be cut to size, chipped, and made available for reuse on site in the construction of temporary support zones, temporary access roads, or during site restoration activities.

Any debris, trash, or other deleterious items encountered within the work zone (i.e., temporary support zone, temporary access roads, and remedial footprint) shall be maintained by the Contractor within the secure work zone and disposed of with other work-related trash generated during the performance of construction activities.

5.1.8 Survey Control

The results of the most recent bathymetric survey are included on Design Drawing 2 (Appendix B), and will be provided to the selected Contractor prior to initiation of capping activities. With this information as a baseline, the Contractor will establish an accurate method of horizontal and vertical control, and will define and stake-out the work areas/limits of the cap area as shown on the Design Drawings (Appendix B).

For all site-related survey activities, the Contractor shall retain an appropriately licensed surveyor. The survey information collected by the Contractor (i.e., topographic, bathymetric data) will be used to document the post-construction conditions of the South Slip. The Contractor shall supply the survey information to ARCADIS for inclusion in the Remedial Action Completion Report (RACR) to be prepared by ARCADIS upon completion of the remedial activities.

5.2 Cap Installation

5.2.1 Erosion Control Systems Inspections

The Contractor will inspect the erosion control system each day for the duration of construction activities. Such daily inspections will consist of a visual assessment of the condition of the erosion control measures, and any evidence of newly formed ruts or gullies adjacent to the work area. If warranted, additional inspections may be conducted following higher-rain periods. All inspections will be documented.

5.2.2 Sub-Aqueous Debris Removal

As discussed in Section 2.3.2, a side scan sonar survey was performed on the South Slip in March 2011, and debris was observed within the area to be capped. Generally, debris within the footprint of the sediment cap to be installed in the South Slip that appears to protrude more than 1 foot above the sediment surface, as identified by the side scan sonar survey, has been targeted for removal. Design Drawing 4 illustrates the location of such targets and presents a table summarizing the approximate size of each target (Appendix B). In addition, any debris of significance that is identified during construction activities will be removed and prepared for disposal.

It is anticipated that a barge-mounted crane/excavator, equipped with a grapple, will be used to remove debris from the majority of the locations identified for removal. The available removal equipment types and environmental controls will be evaluated with regard to minimizing the potential for sediment re-suspension and/or transport during debris removal in consultation with the selected Contractor.

Excess water associated with debris removal will initially be allowed to drain to the water column within the area enclosed by the turbidity and sedimentation controls (i.e., from the crane/excavator grapple suspended over the water) prior to being transported to shore. It is anticipated that removed and dewatered debris will be placed directly into sealed vehicles for transport to an appropriate disposal facility. Alternatively, the Contractor may provide details for on-shore debris handling activities including water management in its Operations Plan.

5.2.3 Sediment Capping

The minimum 1.5-foot granular cap (minimum 1-foot-thick layer of sand with 2% TOC and minimum 6-inch armoring layer of stone) will be installed across the full width of the South Slip from the terminal wall on the western edge of the South Slip to a distance of approximately 900 feet toward the Calumet River, as shown on Design Drawing 5 (Appendix B). In addition, additional clean fill material will be placed at certain locations along the southern extent of the South Slip to maintain a minimum 2H:1V final cap surface slope, as illustrated on Design Drawing 5 (Appendix B), and as necessary at certain locations on the eastern end of the slip to maintain a 2H:1V slope to adequately transition from the full cap thickness to intersect existing grade.

Approximately 10,300 cubic yards (cy) of cap material will be required to install the minimum 1.5-foot-thick cap over the remedial footprint within the South Slip, including

any additional clean fill required to stabilize the slope prior to installation of the sediment cap and to transition the east end of the sediment cap to meet the existing sediment surface. A tolerance of +20% of the total volume required is assumed to account for possible over-placement by the Contractor, and as such, up to 12,000 cy of material may be placed in the South Slip.

It is anticipated that the clean fill material will be mechanically placed by conventional equipment (e.g., excavator with clamshell bucket), and the clean fill material shall be released from a distance no greater than 2 feet above the sediment surface, and shall not be placed through the water column from the water surface. Placement of fill material shall be performed in a series of lifts no more than 6 inches thick, and shall be placed from the toe of slope to the top of slope (i.e., shall be placed starting at the lowest elevations).

It is anticipated that the granular cap material will be mechanically or hydraulically placed by conventional equipment (e.g., excavator with clamshell bucket, tele-belt conveyor, hopper barge, slurried placement with a spreader barge, etc.). The operator will slowly release the cap material through the water column in such a manner as to limit the potential for re-suspension of the existing sediments. Placement of granular cap materials will be performed in a series of lifts no more than 6 inches thick, and each lift will be placed to the required thickness across the entire area to be capped prior to the placement of subsequent lifts. If the Contractor proposes in their Operations Plan to place dry cap material by mechanical methods, the cap material should be placed from no greater than 2 feet above the sediment/fill surface.

As necessary, and based on field conditions and the observed sediment response to capping, the cap placement method and/or placement rate may be modified, as discussed below in Section 5.2.6. Evaluations of the sediment consolidation and the sediment side-slope stability with respect to the proposed cap design are provided in Appendix D.

5.2.4 Water Column Monitoring

During the performance of capping activities, environmental conditions in the adjacent Calumet River will be monitored twice per day by ARCADIS to verify that there are no adverse impacts to the river associated with cap placement. Specifically, turbidity levels will be monitored outside of the work area turbidity controls at two locations in the Calumet River: upstream and downstream of the confluence with the South Slip,

allowing for a direct assessment of the potential contribution of the capping in the South Slip to the environmental conditions in the river, as shown on Figure 2.

It is anticipated that handheld, manually operated field turbidity meters will be used to monitor turbidity in the water column. It is anticipated that turbidity measurements will be made from a boat during active capping operations, with readings collected at the approximate mid-depth elevation. These units will be calibrated, operated, and maintained according to the manufacturer's instructions and will be capable of collecting point turbidity readings from water as deep as 15 feet. The meters will be able to measure turbidity at a resolution of +/- 1 nephelometric turbidity unit (NTU).

Evaluation of potential water column impacts during the ongoing removal activities will be based on the recorded instantaneous turbidity results. The proposed action levels for turbidity results are as follows:

$$\text{Turbidity}_{\text{Downstream}} > \text{Turbidity}_{\text{Upstream}} + 50 \text{ NTUs}$$

In the event that a turbidity measurement recorded downstream of the South Slip exceeds the upstream measurement by 50 NTUs, a number of site assessment activities will be initiated, including, but not limited to, the following:

- Review of the ongoing activities and modification of the condition or performance of the existing erosion and sedimentation control measures.
- Continued monitoring at the downstream location to determine if the prior result was an anomaly or if the elevated reading was possibly a short duration event.
- Collection of additional readings from various locations within or adjacent to the capping area to identify the potential source(s) of the elevated reading.

If these assessment activities indicate that the elevated downstream turbidity reading reflects a water quality impact that could persist or recur and that it is related to specific remedial activities or site controls, the pertinent activities will be modified to the extent feasible, or additional controls will be implemented.

After the completion of sediment capping activities, the turbidity curtain will not be removed until the turbidity within the South Slip area is less than 50 NTU above the upstream turbidity.

5.2.5 Turbidity Control Systems Inspections

The Contractor will inspect the turbidity control system each day prior to commencing capping activities. Such daily inspections will consist of a surface assessment of the condition, location, and anchoring of turbidity curtains. If warranted, additional inspections may be conducted following higher-flow periods, noticeable turbidity increases outside the system, unexpected system position/behavior, contact with the system by equipment or debris, or other abnormal events. In addition, during these inspections, observations of weather, sewer discharges, or any other environmental conditions that would aid in evaluating water quality observations and measurements will be noted. All inspections will be documented in daily progress reports.

5.2.6 Cap Placement and Quality Assurance

A QA program will be established as part of the cap construction to confirm that the remedial activities have been completed consistent with the project design requirements. Details of the QA program are provided in the CQAP (Appendix F), and the general elements of the program are outlined below:

- During placement of the granular cap material, the Contractor will, at a minimum, utilize a series of collection pans as a line of evidence to assess the thickness of each lift of cap material that is placed in the South Slip. (The Contractor will propose additional lines of evidence in their Operations Plan, and may propose alternate methods therein as well.)
- Following placement of the first two lifts of granular cap material, interim monitoring will be performed by ARCADIS through probing to confirm the required minimum 1-foot thickness has been achieved for the 2% TOC sand layer.
- Immediately following placement of the armor stone layer, ARCADIS will perform core collection to verify that the horizontal and vertical limits of the required final extent and thickness have been achieved.

Additionally, the Contractor will be required to conduct a post-remediation bathymetric survey to document post-placement conditions in the South Slip.

5.3 Demobilization and Site Restoration

Following completion of the construction activities, and after confirmation that the requirements of the remedial design (as set forth in this document) have been met, the Contractor shall conduct necessary demobilization activities such as 1) dismantling the work area(s) and staging area(s), 2) cleaning/decontaminating equipment and construction-related materials, if necessary, prior to removal from the Site, and 3) removing from the Site all material equipment and support structures.

During demobilization, the Contractor will restore all upland and bank surface features disturbed, damaged, or destroyed during the remedial construction activities to pre-construction condition. Such features include, but are not limited to, engineered soil cover on the north side of the South Slip, pavement and curbs, vegetated surfaces, and bulkheads. As appropriate, damaged roadways and curbs will be replaced in kind and/or in consultation with Navistar. Previously vegetated surfaces will be restored in consultation with Navistar.

The results of the most recent survey of the soil cover area on the north side of the South Slip, as well as the bulkheads on the north and south side of the South Slip, are included on Design Drawing 2 (Appendix B), and will be provided to the selected Contractor prior to initiation of on-site construction activities such that the Contractor has an accurate representation of the pre-construction conditions to which the Site must be restored. The pre-construction condition of other site features (e.g., curbs, vegetative surfaces) will be reviewed and documented by ARCADIS and the Contractor during the first on-site pre-construction meeting.

6. Post-Remediation Activities

This section presents the activities to be conducted following the completion of the remedial activities at the Site.

6.1 Remedial Action Completion Report

Consistent with 35 IAC 740.450, a RACR will be prepared by ARCADIS and submitted to the Illinois EPA for review and approval following the completion of the remediation activities. The purpose of the RACR will be to document remediation activities and note any deviations from the activities described herein. The RACR will be prepared under the direction of a certified Professional Engineer licensed in the State of Illinois who is familiar with the remediation design and implementation. At a minimum, the RACR will include:

- A description of the construction activities performed, including deviations (if any) from the Illinois EPA-approved DR;
- Record drawings documenting the implementation of the remediation design presented in the DR and illustrating any field modifications;
- Copies of permits, regulatory documents, and relevant project correspondences, as appropriate;
- A summary of field observations and tests performed, laboratory samples collected, and test results reported;
- A summary of problems and deficiencies encountered during construction, including recurring problems and/or deficiencies discovered;
- Representative project photographs taken during implementation of the remedial activities; and
- Documentation indicating that acceptance criteria were met, including a comparison of documented procedure data with the remedial design (i.e., ARCADIS' certification statement).

6.2 Institutional Controls

Institutional controls will be implemented to provide long-term mechanisms to protect the constructed sediment cap. These institutional controls will include use restrictions regarding submerged structure postings, as well as restrictions on anchoring, dredging, development, and other activities that have the potential to disturb the sediment cap.

For the South Slip, the following approach is recommended, based generally on the Illinois EPA NFR review and inspection program, which is currently implemented on a 5-year cycle.

Current or subsequent owners of the South Slip will be required to maintain the established controls and monitoring program. Recommended controls are presented below.

Institutional Controls

- An anchor restriction to prevent anchors from physically impacting the cap surface.
- Any modification or repair to the seawall or a dock will have the provision that the cap must be maintained or replaced after construction.
- Larger vessels may be precluded from entering the South Slip as a method of controlling motor power or speed, which may damage the cap.
- Speed restrictions designating the area as a “no wake zone” will limit vessel speed and engine power.

Engineering Control

- The shallow western area of the slip (i.e., where water depths are less than 11 feet) will be physically isolated using a steel cable or chain and appropriate marine and land-based signage and markers to prevent vessel access.

Inspection, Monitoring, and Maintenance

- The South Slip will be subject to the Illinois EPA inspection every 5 years. The owner will be responsible for performing a bathymetric survey to document the cap elevation and compare it to post-remediation cap elevations at a minimum

frequency of once per 5 years. An assessment of changes in cap elevation beyond a design threshold may trigger one or more of the following supplemental measures:

- inspection by a diver
- underwater video inspections
- physical inspection of cap thickness

If the above monitoring activities indicate additional remedial action is warranted, maintenance could include re-grading of the cap surface or installation of new cap material.

7. Schedule

There are no regulatory schedule requirements for completion of the South Slip remedial action. The schedule outlined below will be implemented by ARCADIS at the request of Navistar.

- June 2012 – Submit permit applications
- June 2012 – Finalize DR
- June 2012 – Develop and distribute RFP
- July 2012 – Receive permits and perform contractor site walk
- August 2012 – Select contractor
- September 2012 – Begin construction
- November 2012 – Complete all site work, including site restoration

Note that the preliminary schedule provided above is dependent on the receipt of applicable construction and environmental permits. If receipt of these permits is delayed, subsequent activities will also be delayed.

8. References

- ARCADIS. 2006. Phase I Environmental Site Assessment, North and South Slips. Former Wisconsin Steel Works, Chicago, Illinois. October.
- ARCADIS. 2008. Environmental Health and Safety Plan (E-HASP). Former Wisconsin Steel Works, Chicago, Illinois. August.
- ARCADIS. 2009. Phase I Risk Assessment, North and South Slips. Former Wisconsin Steel Works, Chicago, Illinois.
- ARCADIS. 2010. Phase II Risk Assessment, South Slip. Former Wisconsin Steel Works, Chicago, Illinois. September.
- ARCADIS. 2011. Wisconsin Steel Works South Slip Remedial Action Plan. September.
- Consent Order. Entered December 30, 1996. In the matter of The People of the State of Illinois vs. Navistar International Transportation Corp.
- Palermo, M., Maynard, S., Miller, J., and Reible, D. 1998. "Guidance for In-Situ Subaqueous Capping of Contaminated Sediments," EPA 905-B96-004, Great Lakes National Program Office, Chicago, IL.
- USACE. 2011. <http://www.lrc.usace.army.mil/co-o/calumet.pdf>.
- United States Environmental Protection Agency (USEPA). 2005. Contaminated Sediment Remediation Guidance for Hazardous Waste Sites. USEPA Office of Solid Waste and Emergency Response. EPA-540-R-05-012, OSWER 9355.0-85, December 2005.
- United States Fish and Wildlife Service (USFWS). 1994. Ecological Study and Impact Assessment at the Wisconsin Steel Works Site, Chicago, Illinois.
- Wisconsin Steel Works. 1994. Settlement Agreement.

Tables

Table 2
Results of Probing Investigation
Former Wisconsin Steel Works, Chicago, IL
South Slip Sediment Cap Design Report

Date:	3/28/2011
Water Level Elevation (ft):	577.99

Location	Water Depth (ft)	Sediment Thickness (ft)	Description
PDI-PR-01	5.4	6.5	gravel/silt and clay
PDI-PR-02	12.4	16.6	loose soft silt/hard bottom
PDI-PR-03	13.2	13.5	gravel/loose silt/hard bottom
PDI-PR-04	14.1	13.5	gravel/loose silt/hard bottom
PDI-PR-05	15.5	12.2	gravel/loose silt/hard bottom
PDI-PR-06	5.2	16.8	loose sand and silt/hard bottom
PDI-PR-07	12.7	18.3	loose silt/hard bottom
PDI-PR-08	15.5	16.5	loose silt/hard bottom
PDI-PR-09	16.1	16.0	loose silt/hard bottom
PDI-PR-10	17.5	16.0	loose silt/hard bottom
PDI-PR-11	1.3	0.2	loose silt/hard bottom
PDI-PR-12	8.9	20.4	gravel loose sand and silt/hard bottom
PDI-PR-13	9.8	20.0	gravel loose sand and silt/hard bottom
PDI-PR-14	9.3	13.7	loose sand and gravel/hard bottom
PDI-PR-15	10.3	7.7	gravel and sand/hard bottom

Notes:

ft = feet

Water depth collected using lead line measuring tape.

Sediment thickness measurements obtained by pushing steel rod to refusal.

Table 3
Velocity Measurements
Former Wisconsin Steel Works, Chicago, IL
South Slip Sediment Cap Design Report

Date:		3/28/2011						
Water Level Elevation (ft):		577.99						
Location	Water Depth (ft)	Velocity						Flow¹
		Bottom 20% of Water		Mid-Point of Water		Top 20% of Water		
		Distance from Bottom (ft)	Velocity (ft/s)	Distance from Bottom (ft)	Velocity (ft/s)	Distance from Bottom (ft)	Velocity (ft/s)	
PDI-Vel-01	4.6	0.92	0.01	2.3	0.02	3.68	0.01	West
PDI-Vel-02	16.0	3.2	0.01	8.0	0.01	12.8	0.02	West
PDI-Vel-03	25.5	5.1	0.10	12.75	0.13	20.4	0.10	North
PDI-Vel-04	30.8	6.16	0.01	15.4	0.01	24.64	0.02	North
PDI-Vel-05	29.0	5.8	0.02	14.5	0.02	23.2	0.04	North
PDI-Vel-06	23.2	4.64	0.02	11.6	0.02	18.56	0.01	North
PDI-Vel-07	20.0	4.0	0.03	10.0	0.02	16.0	0.02	North

Notes:

ft = feet

ft/s = feet per second

1. Flow direction based on visual, surficial observations and can be influenced by conditions at the time of inspection - wind, vessel traffic, etc. The Calumet River generally flows south.

Water depth collected using lead line measuring tape.

Velocity measurements collected using handheld velocity flow meter.

Figures

CITY: SYRACUSE, NY DIV/GROUP: ENVCAD DB: KLS SJB LD: GMS PIC: (Ort) P: (M) (Reqd) T: (M) (Ort) LY: (Or) (N) = OFF = REF = FRZ = OLD
 G: ENVCAD/STRACUSE/ACT/CID0066400370000/IDW/FIG00664001.dwg LAYOUT: 1 SAVED: 6/8/2012 12:43 PM ACADVER: 18.1S (LIMS TECH) PAGES: 10 PAGES SETUP: ADOBE PDF PLOTSTYLETABLE: PLT\FULL.CTB PLOTTED: 6/8/2012 12:45 PM BY: SMITHGALL, NANCY
 XREFS: IMAGES: 00664X03.tif PROJECTNAME: --

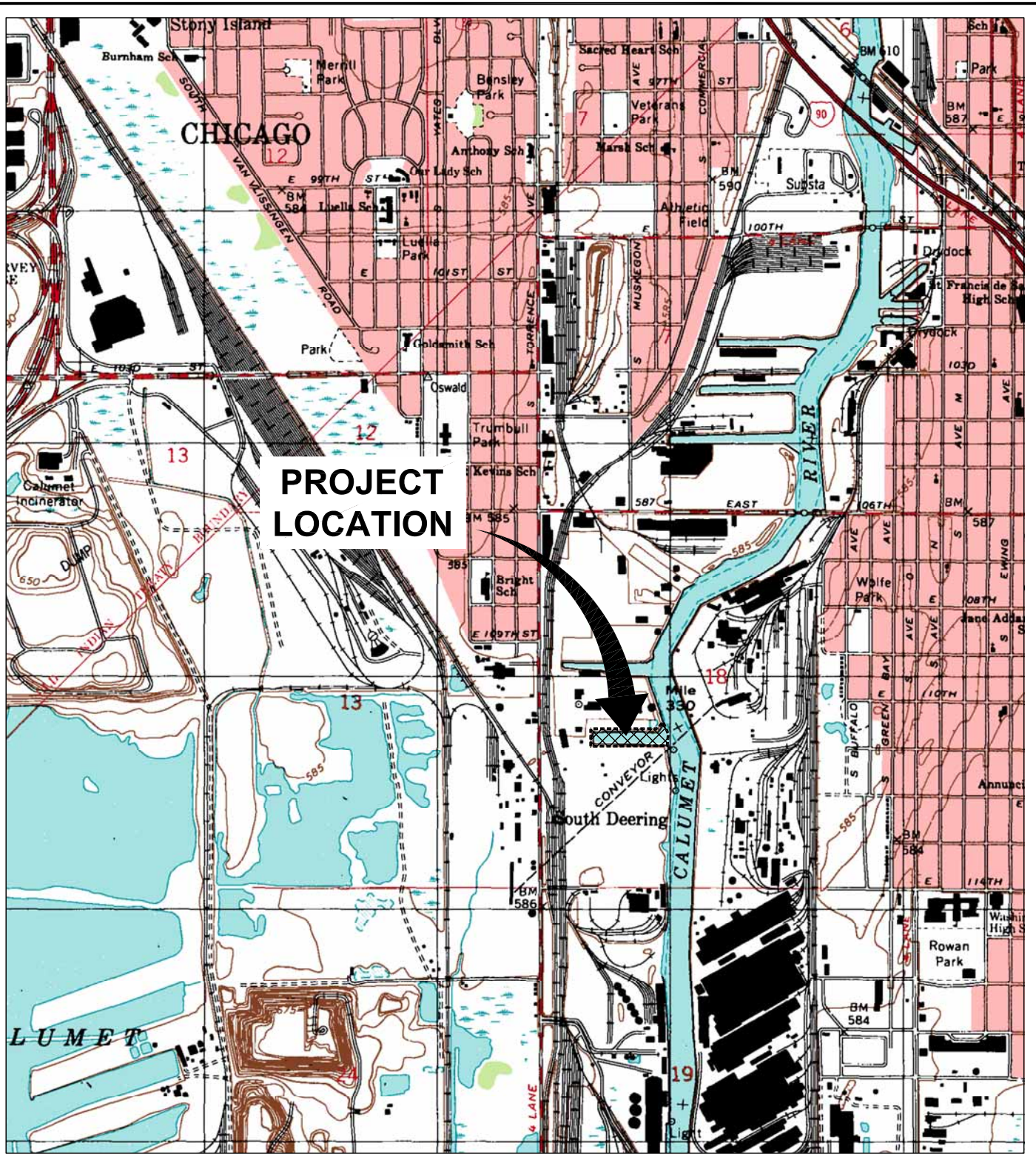

**PROJECT
LOCATION**

REFERENCE: BASE MAP USGS 7.5. MIN. TOPO. QUAD., LAKE CALUMET, IL-IN., 1997.

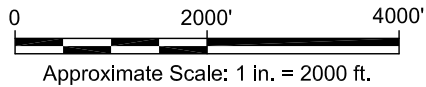

<p>FORMER WISCONSIN STEEL WORKS CHICAGO, ILLINOIS SOUTH SLIP SEDIMENT CAP DESIGN REPORT</p>	
<p>SITE LOCATION MAP</p>	
	<p>FIGURE 1</p>

CITY: SYR DIV/GROUP: SWG DB: JRAPPP
Wisconsin Steel Works (C1000666_0037_00001)
C:\WisconsinSteelWorks\Chicago\SouthSlip\Sub\AqueousCap\mxd\AerialSite_v2.mxd - 6/8/2012 @ 3:17:55 PM

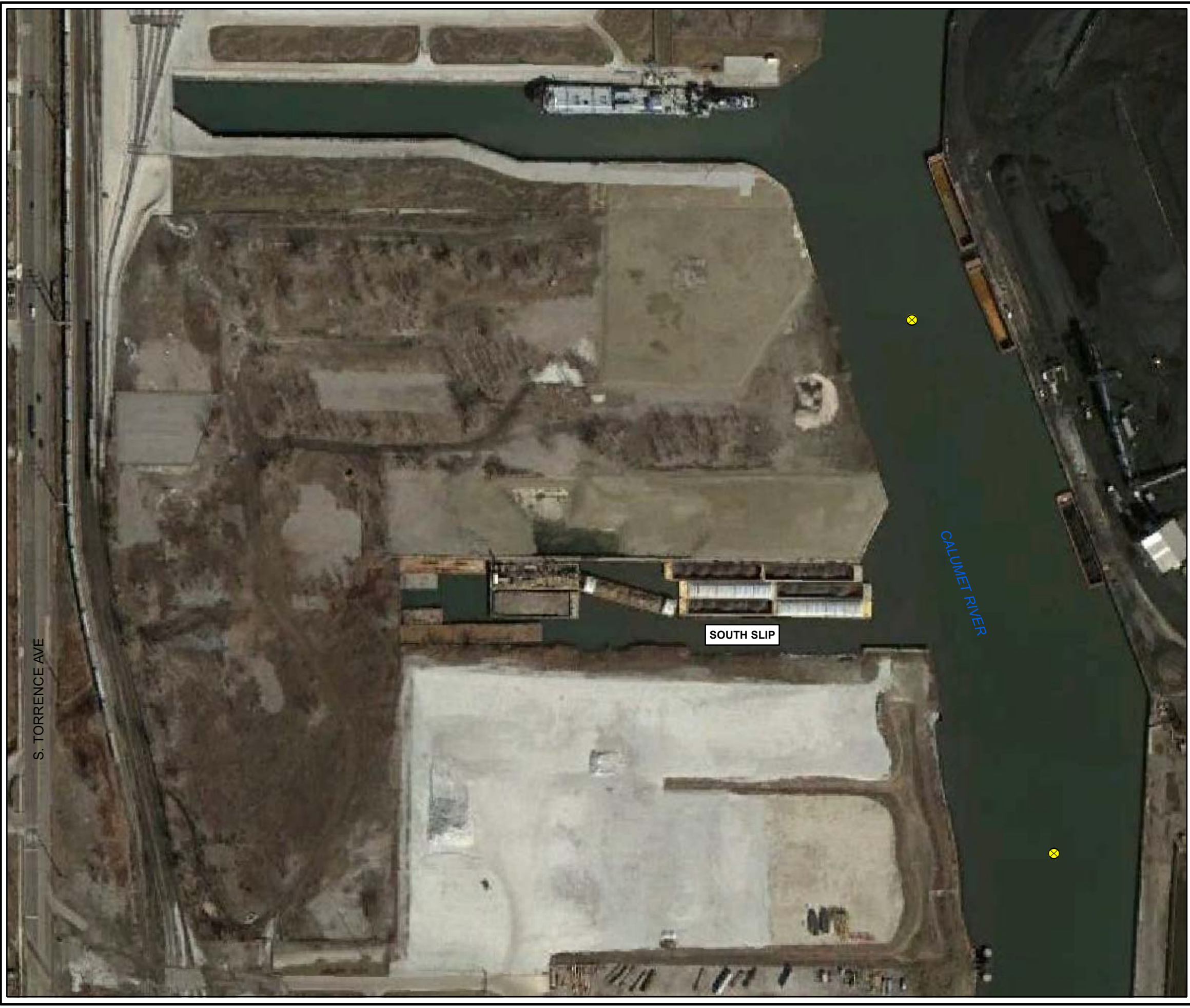

S. TORRENCE AVE

SOUTH SLIP

CALUMET RIVER

LEGEND:

- ⊗ APPROXIMATE WATER COLUMN MONITORING LOCATION

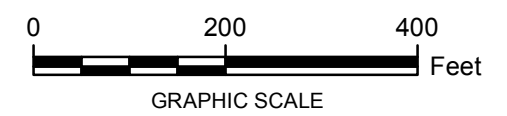

NOTE:
1. MARCH 12, 2012 IMAGERY ACQUIRED THROUGH GOOGLE EARTH PRO LICENSE.

FORMER WISCONSIN STEEL WORKS CHICAGO, IL	
SOUTH SLIP SEDIMENT CAP DESIGN REPORT	
SITE AERIAL	
	FIGURE 2

CITY: SYRACUSE, NY; DM/GROUP: ENVICAD; DB: S.BELL, K. DAVIS, S.BELL; LD: S.BELL; PIC: G. VANDERLAAN; TM: G. VANDERLAAN; LYR: ON; OFF: REF; PLOTTED: 6/8/2012 12:47 PM; BY: SMITHGALL, NANCY

PROJECT NAME: ---
 IMAGES: 00664x01.jpg
 00664x02.jpg
 00664x03.png

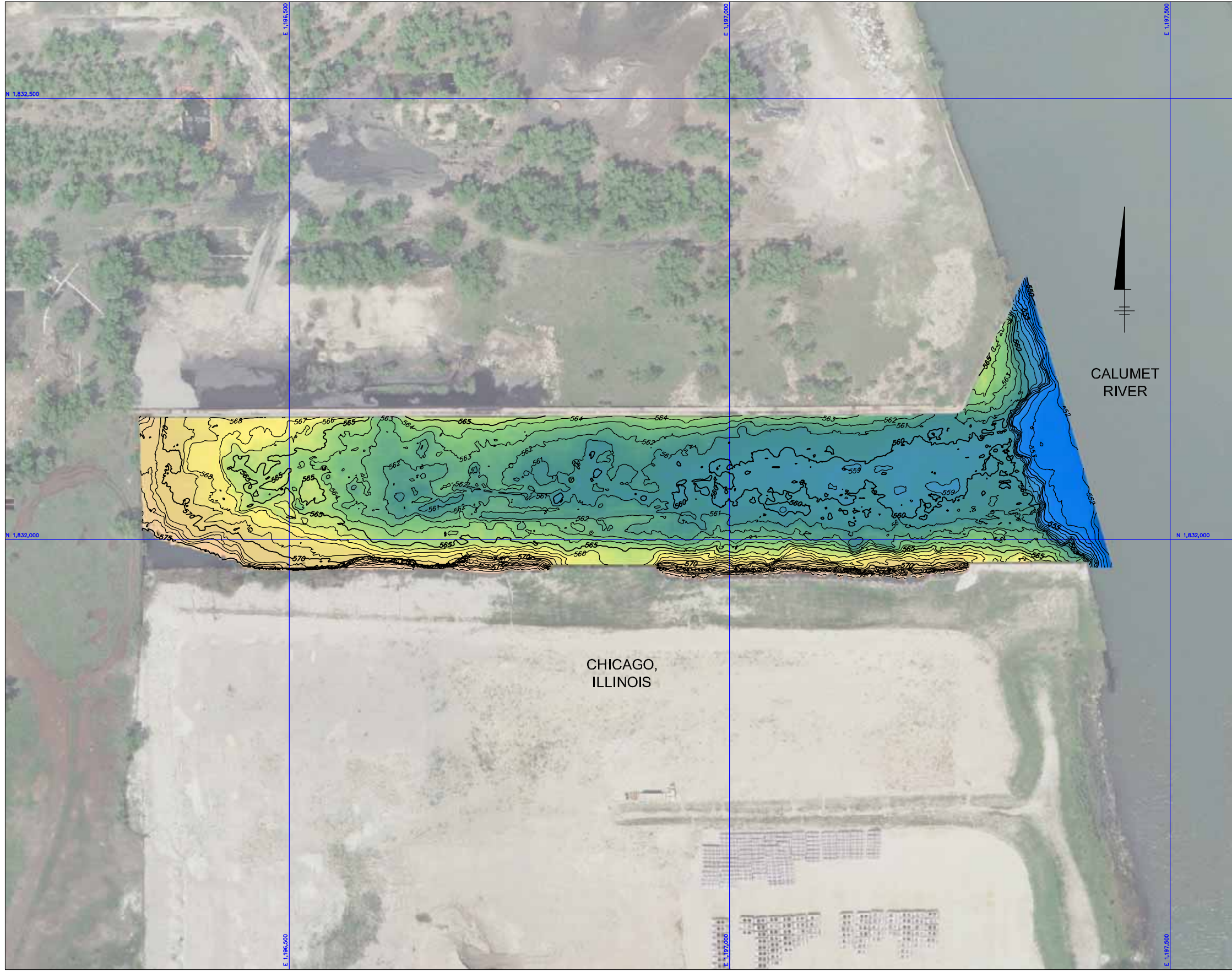

LEGEND:
 —565— MAJOR CONTOUR
 —563— MINOR CONTOUR

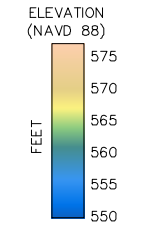

- NOTES:
1. GRID SYSTEM IS IN FEET AND IS THE ILLINOIS EAST STATE PLANE COORDINATE SYSTEM.
 2. ELEVATIONS ARE IN FEET AND ARE REFERENCED TO NORTH AMERICAN VERTICAL DATUM 1988 (NAVD 88) BASED ON BENCHMARK "BL-MS-02" WHICH HAS AN ELEVATION OF 590.09 FEET NAVD 88 AS PROVIDED BY ARCADIS U.S., INC. ELEVATIONS WERE DEVELOPED FROM ONE FOOT BY ONE FOOT BINNED DATA WITH THE AVERAGE ELEVATION WITHIN EACH BIN POSTED IN THE CENTER OF THE BIN.
 3. CONTOURS ARE IN FEET AND WERE GENERATED USING "QUICKSURF" VERSION 5.1 (SCHREIBER INSTRUMENTS, INC.) OPERATING WITHIN AUTODESK "AUTOCAD" VERSION 2004.
 4. SHORELINE AND ONSHORE FEATURES ARE APPROXIMATE AND ARE BASED ON DIGITAL ORTHOPHO TO QUADRANGLES FLOWN IN 2008 AND OBTAINED FROM THE USGS SEAMLESS DATA WAREHOUSE.

SURVEY VESSEL: R/V ECHO	ECHOSOUNDER: RESON 8125
NAVIGATION SYSTEMS: APPLANIX POS MV IN REAL TIME KINEMATIC MODE	
SURVEY ACQUISITION SOFTWARE: HYPACK VERSION 2010	
SURVEY PROCESSING SOFTWARE: HYPACK MULTIBEAM EDITOR VERSION 2010	

FORMER WISCONSIN STEEL WORKS
 CHICAGO, ILLINOIS
**SOUTH SLIP SEDIMENT CAP
 DESIGN REPORT**

**BATHYMETRIC SURVEY DATA
 ELEVATION CONTOURS**

CITY: SYRACUSE, NY DIV/GROUP: ENV/CAD DB: S, BELL, K, DAVIS, S, BELL, LD: S, BELL, PIC: G, VANDERLAAN PIN: G, VANDERLAAN TIM: G, MOTT LYR: ON/OFF REF: GA: ENV/CAD/SYRACUSE/ACT/C0000664/00037000001/IMG/H000664G04.png LAYOUT: 4 SAVED: 6/8/2012 2:59 PM ACADVER: 18.1'S (LMS TECH) PLOTSETUP: PLOTSTYLETABLE: PLTFULL.CTB PLOTTED: 6/8/2012 3:00 PM BY: SMITHGALL, NANCY

XREFS: 00664x00 11res014-celribar.png 00664x01 12ES034-MS-SM.jpg 00664x05 12ES034-SS-MS-ac.jpg bcrmap.png

IMAGES: PROJECTNAME: ---



LEGEND:
 DEBRIS TARGETS

- NOTES:
1. GRID SYSTEM IS IN FEET AND IS THE ILLINOIS EAST STATE PLANE COORDINATE SYSTEM.
 2. SHORELINE AND ONSHORE FEATURES ARE APPROXIMATE AND ARE BASED ON DIGITAL ORTHOPHO QUADRANGLES FLOWN IN 2008 AND OBTAINED FROM THE USGS SEAMLESS DATA WAREHOUSE.

SURVEY VESSEL: R/V ECHO	SIDE SCAN SONAR: KLEIN 3000
NAVIGATION SYSTEMS: APPLANIX POS MV IN REAL TIME KINEMATIC MODE	
SURVEY ACQUISITION SOFTWARE: HYPACK VERSION 2010	
SURVEY PROCESSING SOFTWARE: SONARWIZ	

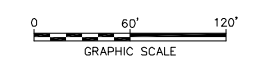

FORMER WISCONSIN STEEL WORKS
 CHICAGO, ILLINOIS
**SOUTH SLIP SEDIMENT CAP
 DESIGN REPORT**

SIDE SCAN SONAR MOSAIC

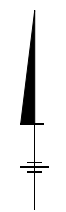
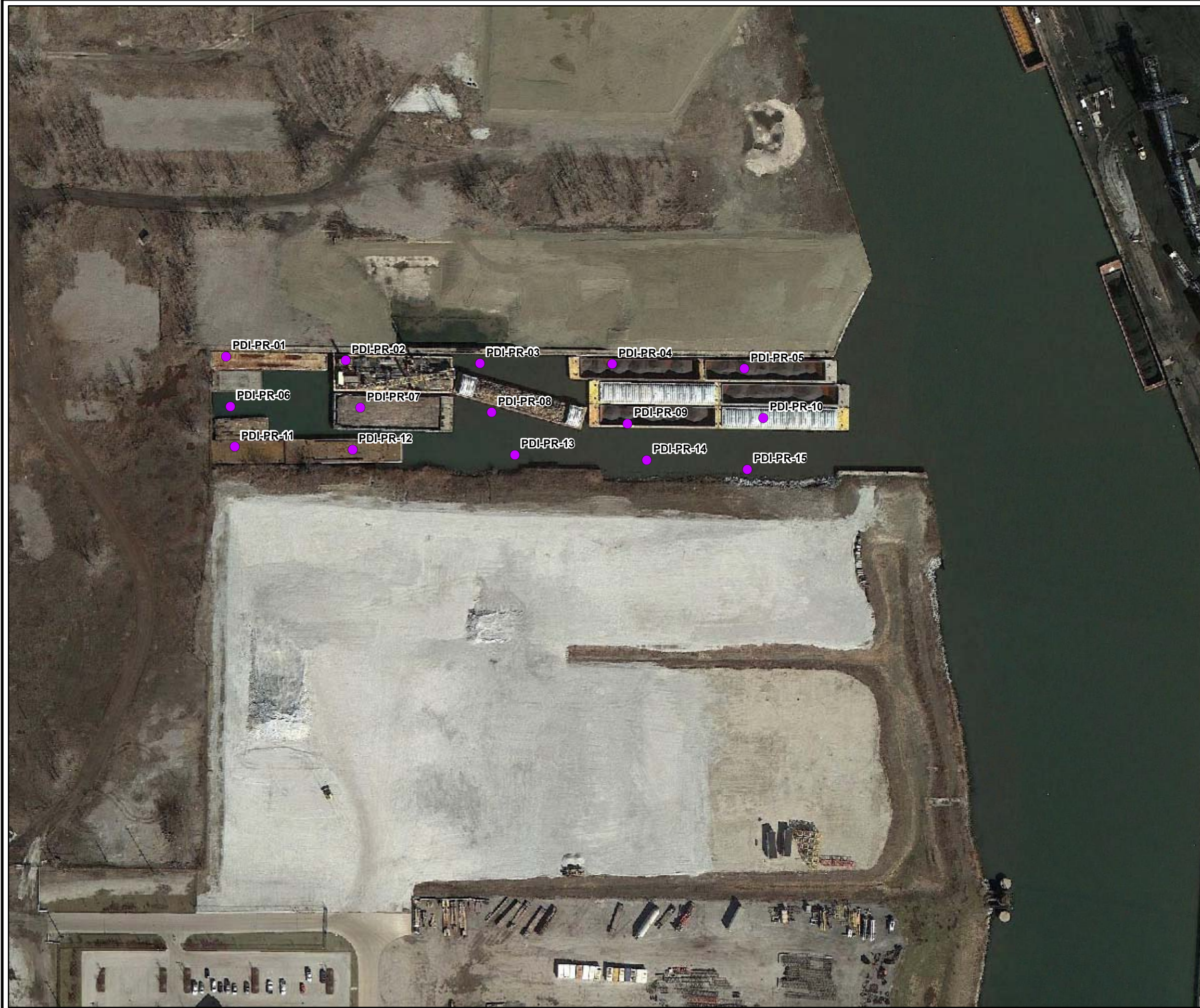

LEGEND:
● SEDIMENT PROBING LOCATION

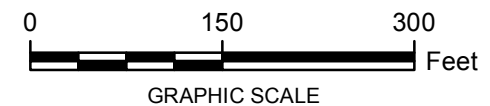

NOTE:
1. MARCH 12, 2012 IMAGERY ACQUIRED THROUGH GOOGLE EARTH PRO LICENSE.

FORMER WISCONSIN STEEL WORKS
CHICAGO, IL
SOUTH SLIP SEDIMENT CAP DESIGN REPORT
SEDIMENT PROBING LOCATIONS



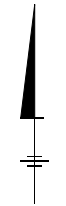

LEGEND:
X VELOCITY MONITORING LOCATION

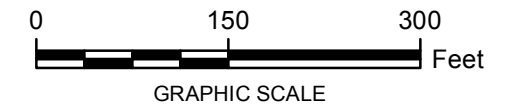

NOTE:
1. MARCH 12, 2012 IMAGERY ACQUIRED THROUGH GOOGLE EARTH PRO LICENSE.

FORMER WISCONSIN STEEL WORKS
CHICAGO, IL
SOUTH SLIP SEDIMENT CAP DESIGN REPORT
VELOCITY MONITORING LOCATIONS



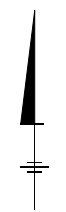
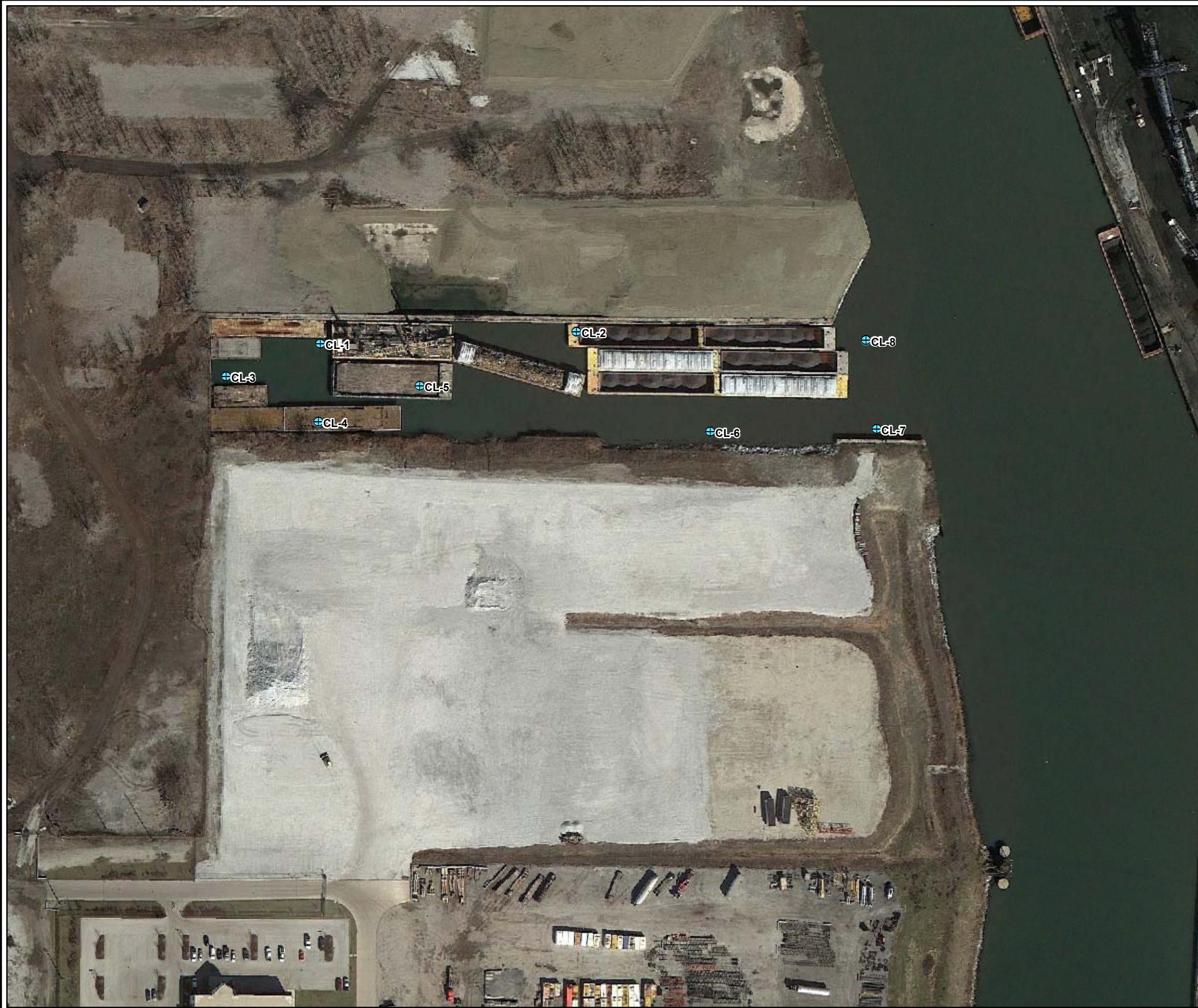

LEGEND:

⊕ BORE HOLE LOCATION

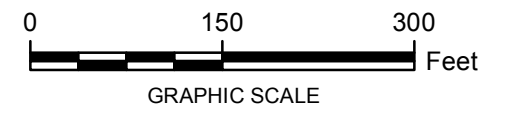

NOTE:

1. MARCH 12, 2012 IMAGERY ACQUIRED THROUGH GOOGLE EARTH PRO LICENSE.

FORMER WISCONSIN STEEL WORKS
CHICAGO, IL
SOUTH SLIP SEDIMENT CAP DESIGN REPORT
GEOTECHNICAL SAMPLING LOCATIONS





Appendix A

Site Photos

CITY: SYRACUSE, NY DIV: GROUP: ENVCAD DR: SBELL, LD: SBELL PIC: 0 PMG: VANDERLAAN TMG: VANDERLAAN LVR: OPTION: OFF=REF
 GA: ENVCAD: SYRACUSE: ACT: C:\000664\0037\00001\DWG\FIG\00664G06.dwg LAYOUT: C-1 SAVED: 4/17/2012 4:19 PM ACADVER: 18.1S (LMS TECH) PAGESETUP: --- PLOTSTYLETABLE: PLTFULL.CTB PLOTTED: 4/17/2012 4:20 PM BY: SMITHGALL, NANCY
 XREFS: 00664X01 00664X01.jpg 00664X02.jpg
 IMAGES: 00664X01 00664X01.jpg 00664X02.jpg
 PROJECTNAME: ---

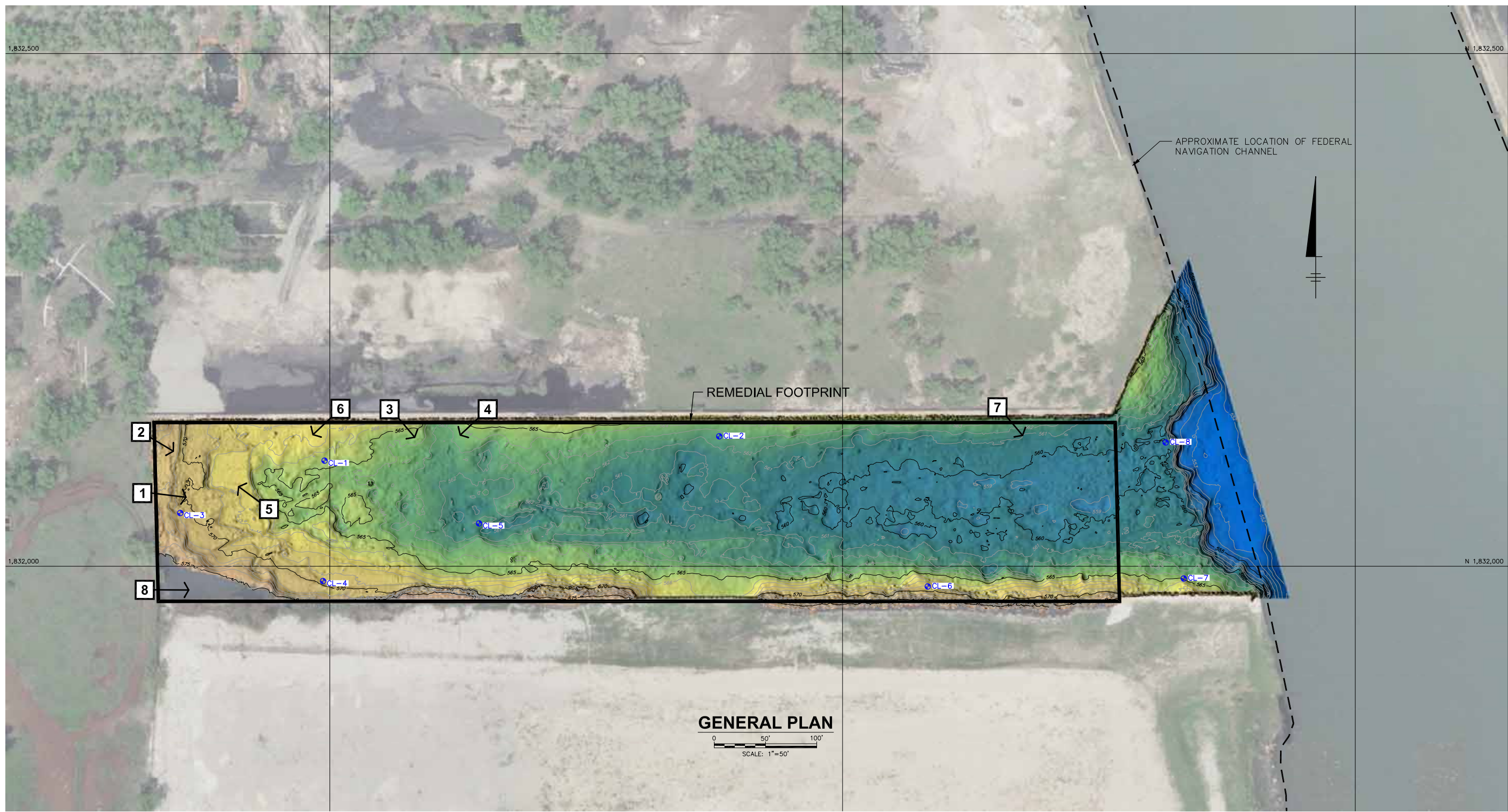

- LEGEND:**
- CL-# BORE HOLE LOCATION
 - REMEDIAL FOOTPRINT
 - - - - - APPROXIMATE LOCATION OF FEDERAL NAVIGATION CHANNEL
 - 1 ← PHOTO LOCATION AND DIRECTION

NOTE:
 1. BORE HOLES COMPLETED IN MARCH 2011 USING MOBILE B4300 TRUCK RIG.

FORMER WISCONSIN STEEL WORKS CHICAGO, IL	
SITE PHOTO LOCATIONS	
	Figure A-1



Photo 1. South Slip looking east from western edge of slip with stored barges present. February 15, 2011.



Photo 2. South Slip looking east from western shore of slip during empty slip conditions. The east side of the slip is open to the Calumet River. March 3, 2011.



Photo 3. South Slip looking southeast from a barge within the slip towards the earthen slope.
March 30, 2011.



Photo 4. South Slip looking southwest towards sheet pile wall and earthen slope. February 15, 2011.



Photo 5. South Slip looking northeast from a barge within the slip towards the timber-supported concrete dock. March 30, 2011.



Photo 6. South Slip looking south-southwest from the north side of the slip. April 4, 2012.



Photo 7. South slip looking east-southeast from the WSW Eastern Coal Storage Area. April 4, 2012.



Photo 8. South slip looking east from the southwest corner of the slip. April 4, 2012.



Appendix B

Design Drawings

DESIGN DRAWINGS

**SOUTH SLIP SEDIMENT CAP
DESIGN REPORT
FORMER WISCONSIN
STEEL WORKS SITE**

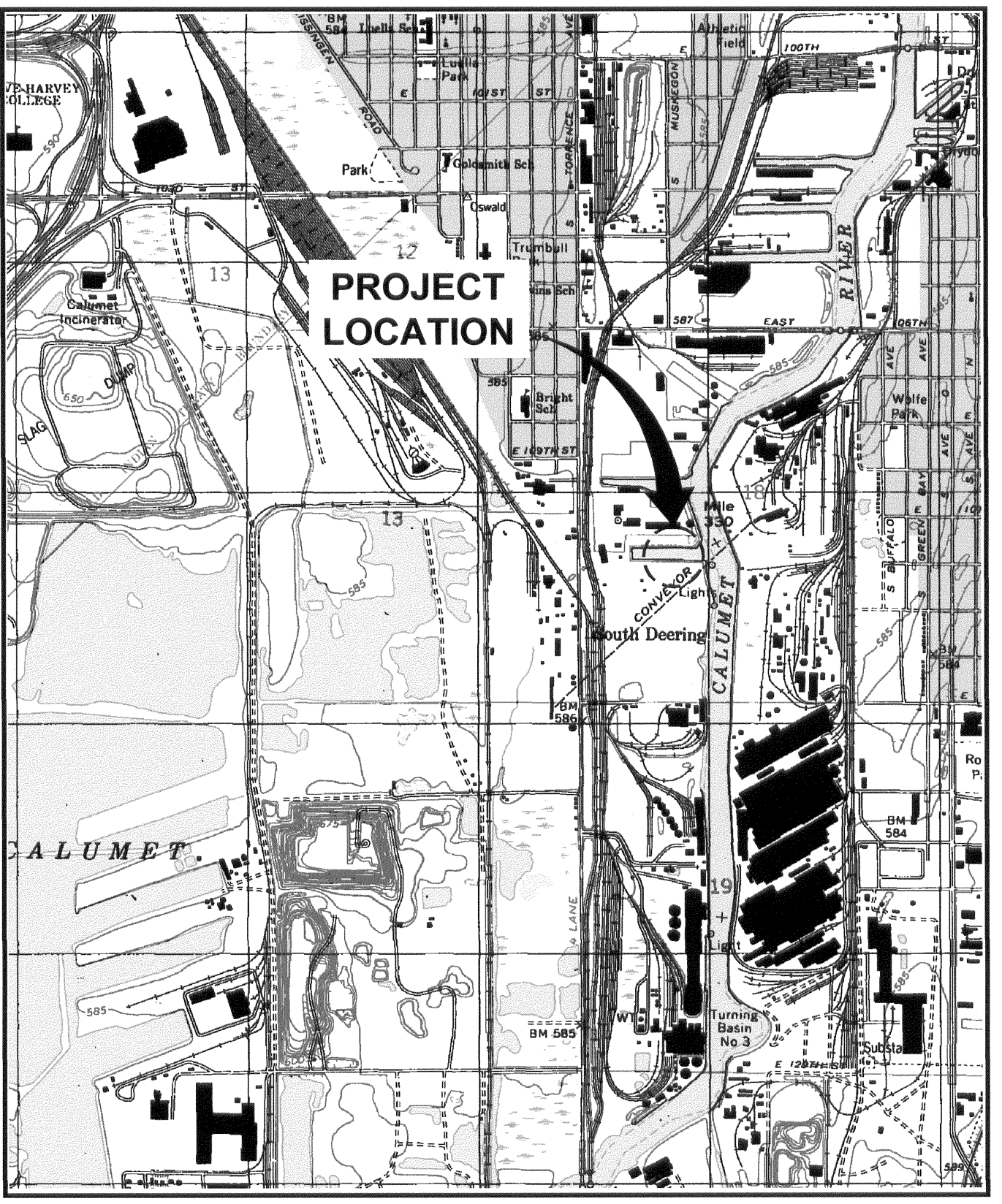

REFERENCE: BASE MAP USGS 7.5 MINUTE QUADRANGLE, LAKE CALUMET, IL-IN., 1997.

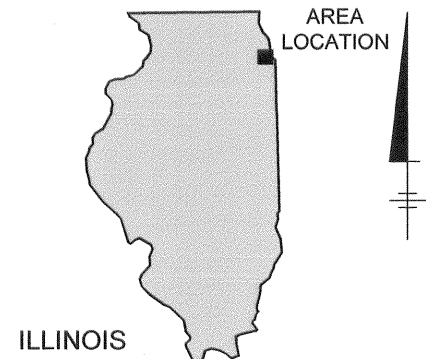
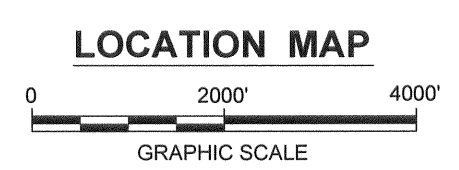

JUNE 2012

**NAVISTAR, INC.
CHICAGO, ILLINOIS**

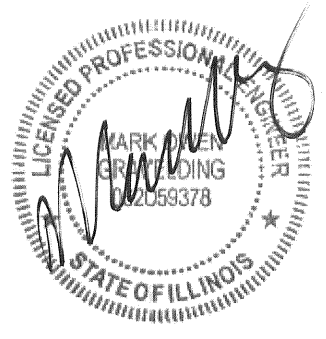

INDEX TO DRAWINGS

- 1 GENERAL NOTES AND ABBREVIATIONS
- 2 GENERAL SITE PLAN
- 3 SITE PREPARATION AND ENVIRONMENTAL CONTROLS PLAN
- 4 DEBRIS REMOVAL PLAN
- 5 SEDIMENT CAP INSTALLATION PLAN
- 6 SOUTH SLOPE TYPICAL SECTIONS
- 7 MISCELLANEOUS DETAILS

CITY: SYRACUSE, NY DIV/GROUP: ENVCAD DB: K DAVIS ID: PIC: PM: TM: L PUTNAM LXR: ONF-OFF-REF* G:\ENVCAD\SYRACUSE\ACTION\0000000000\DWG\CONTRACT\00664001.dwg LAYOUT: C-COVER SAVED: 6/6/2012 1:42 PM ACADVER: 18.15 (LMS TECH) PAGES: 18 PLOTSTYLETABLE: PLTCONT.CTB PLOTSETUP: --- PLOTSTYLETABLE: PLTCONT.CTB PLOTTED: 6/11/2012 10:31 AM BY: SMITHGALL, NANCY

CITY: SYRACUSE, NY; DIV: GROUP: ENVICAD; DB: K DAVIS; LD: PIC; M: GRAVELDING; PM: G VANDERLAAN; TM: L PUTNAM; LYN: ON; OFF: "REF";
 C:\ENVICAD\SYRACUSE\PROJECT\00000000\1\DWG\CONTRACT\06694502.dwg; LAYOUT: 2; SAVER: 6/8/2012 1:59 PM; ACADVER: 18.1S (LMS TECH); PAGES: 1; PLOT: 6/11/2012 10:33 AM; BY: SMITHGALL, NANCY
 PROJECT NAME: ---
 XREFS: 00664x00; 00664x03
 IMAGES: MOG-I-LL-IF

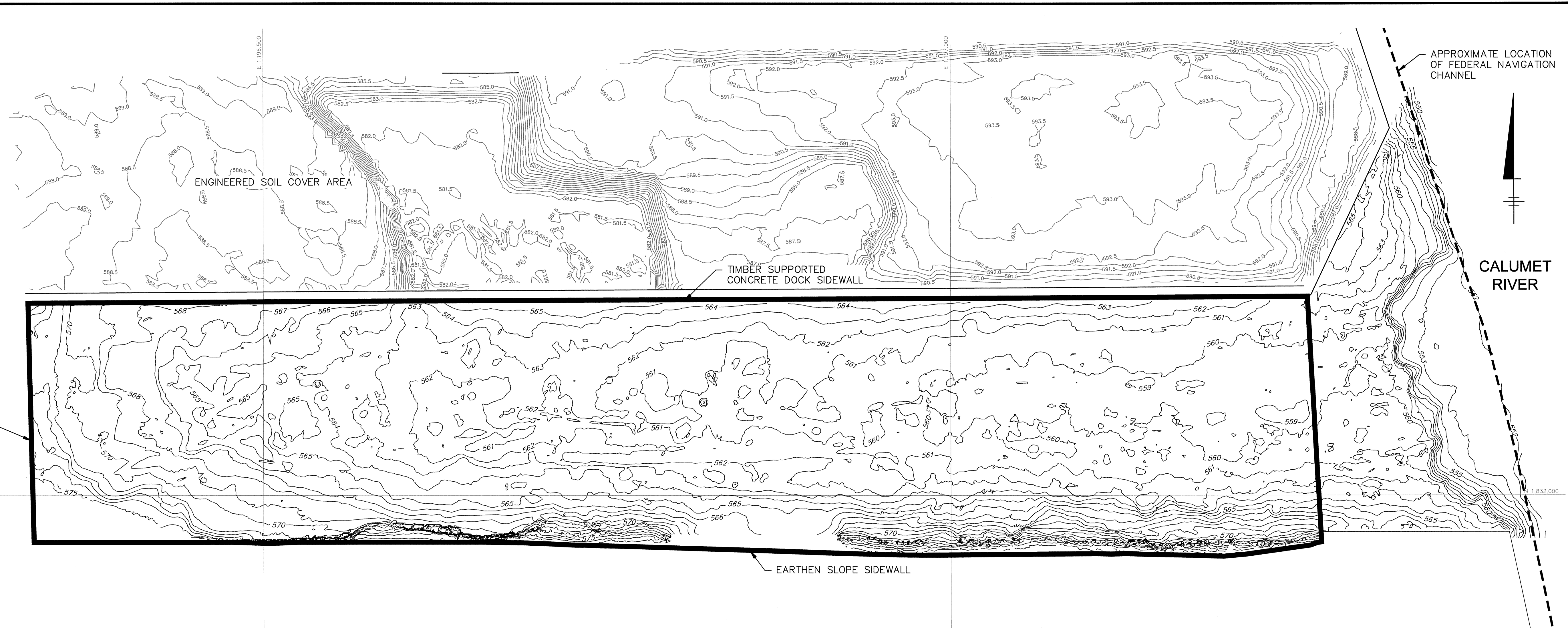

LEGEND:
 ---590.5--- TOPOGRAPHIC CONTOUR
 ---565--- BATHYMETRIC CONTOUR
 ————— REMEDIAL FOOTPRINT

NOTES:
 1. GRID SYSTEM IS IN THE ILLINOIS EAST STATE PLANE COORDINATE SYSTEM.
 2. TOPOGRAPHIC CONTOURS ARE IN FEET AND ARE REFERENCED TO NORTH AMERICAN VERTICAL DATUM 1988 (NAVD 88).
 3. MULTIBEAM BATHYMETRIC SURVEY WAS PERFORMED BY OCEAN SURVEYS, INC. MARCH 28-29, 2011. BATHYMETRIC CONTOURS ARE IN FEET AND WERE GENERATED USING "QUICKSURF" VERSION 5.1 (SCHREIBER INSTRUMENTS, INC.) OPERATING WITHIN AUTODESK "AUTOCAD" VERSION 2004.
 4. SHORELINE AND ONSHORE FEATURES ARE APPROXIMATE AND ARE BASED ON DIGITAL ORTHOPHOTO QUADRANGLES FLOWN IN 2008 AND OBTAINED FROM THE USGS SEAMLESS DATA WAREHOUSE.
 5. THE POOL ELEVATION AT THE SOUTH SLIP IS DETERMINED TO BE ELEVATION 577.9 FEET ABOVE SEA LEVEL (ASL) (MARCH 2011). THE ORDINARY HIGH WATER (OHW) AND ORDINARY LOW WATER (OLW) ELEVATIONS HAVE NOT BEEN DETERMINED. PER THE US ARMY CORPS OF ENGINEERS, THE MAXIMUM POOL ELEVATION FLUCTUATION IS DETERMINED TO BE BETWEEN ELEVATION 577 AND 579 FEET ASL (APPROXIMATELY 1.0' ABOVE AND BELOW ITS USUAL ELEVATION) (USACE 2012).

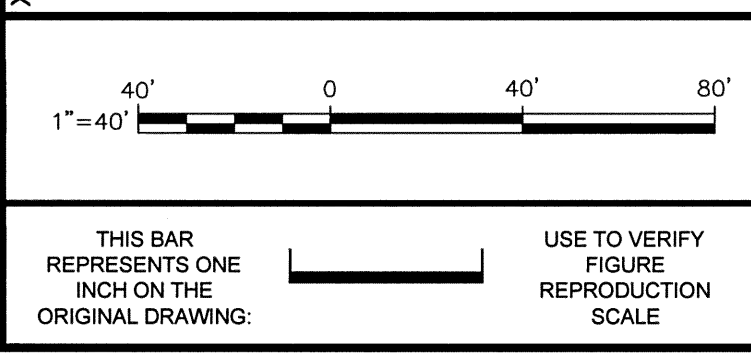

No.	Date	Revisions	By	Ckd

Professional Engineer's Name
MARK O. GRAVELDING
 Professional Engineer's No.
 062059378
 State
 ILLINOIS
 Date Signed
 6/11/12
 Project Mgr.
 MOG
 Designed by
 LP, AC
 Drawn by
 NES
 Checked by
 MOG

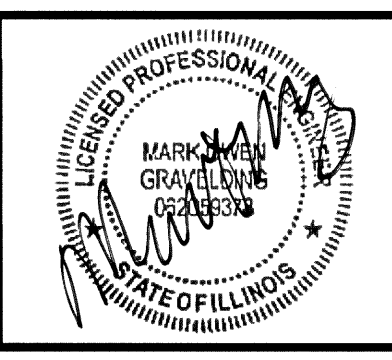

NAVISTAR, INC. • CHICAGO, ILLINOIS
 SOUTH SLIP SEDIMENT CAP DESIGN REPORT
GENERAL SITE PLAN

ARCADIS Project No.
 C1000664.0031.00008
 Date
 JUNE 2012
 ARCADIS
 6723 TOWNPATH ROAD
 PO BOX 66
 SYRACUSE, NEW YORK 13214
 TEL. 315.446.9120

CITY, SYRACUSE, NY, DIV/GROUP: ENV/CAD, DB: K DAVIS, LD: PIC, M GRAVELDING, PM: G VANDERLAAN, TM: L PUTNAM, LVR: ONE+OFF=REF, PLOT: 6/11/2012 10:33 AM, BY: SMITHGALL, NANCY
 C:\ENVCAD\SYRACUSE\ACT\C1000684003700001\DWG\CONTRACT\00684033.dwg, LAYOUT: 3, SAVED: 6/9/2012 2:00 PM, ACADVER: 18, IS (LIMS TECH) PAGES: 18, PLOTSETUP: ---, PLOTSTYLETABLE: PLTCONT.CTB, PLOT: 6/11/2012 10:33 AM, BY: SMITHGALL, NANCY
 PROJECTNAME: ---
 XREFS: 00864x00, 00864x03
 IMAGES: MOG-ILL.lif

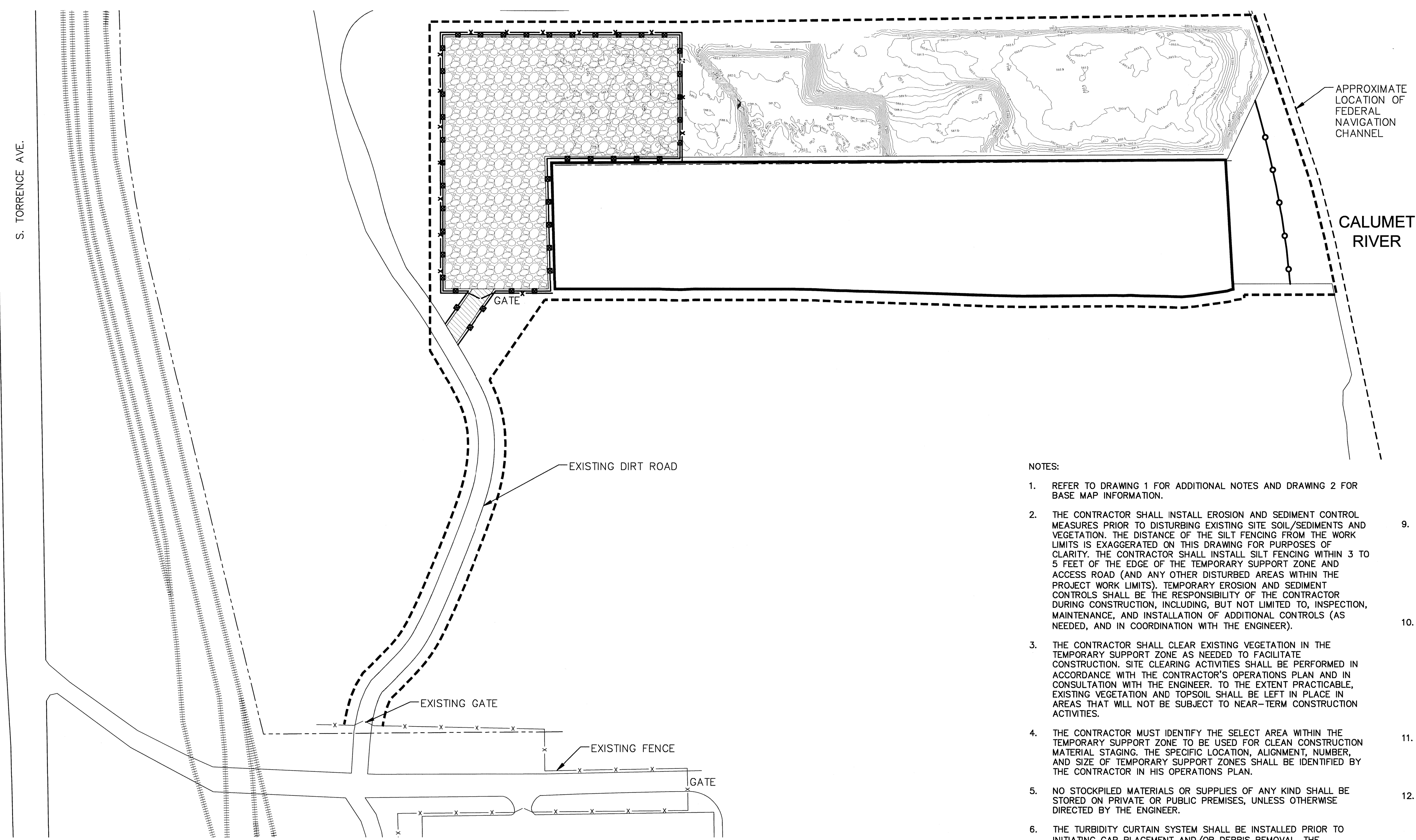

LEGEND:

- TOPOGRAPHIC CONTOUR
- REMEDIAL FOOTPRINT
- PROJECT WORK LIMITS
- PROPERTY LINE
- SILT FENCE (1/7)
- TURBIDITY CURTAIN (4/7)
- TEMPORARY SITE SECURITY FENCE
- TEMPORARY SITE SECURITY GATE
- AREA AVAILABLE FOR TEMPORARY SUPPORT ZONE (3/7)
- TEMPORARY ACCESS ROAD (2/7)
- RAILROAD TRACKS
- ROAD

NOTES:

1. REFER TO DRAWING 1 FOR ADDITIONAL NOTES AND DRAWING 2 FOR BASE MAP INFORMATION.
2. THE CONTRACTOR SHALL INSTALL EROSION AND SEDIMENT CONTROL MEASURES PRIOR TO DISTURBING EXISTING SITE SOIL/SEDIMENTS AND VEGETATION. THE DISTANCE OF THE SILT FENCING FROM THE WORK LIMITS IS EXAGGERATED ON THIS DRAWING FOR PURPOSES OF CLARITY. THE CONTRACTOR SHALL INSTALL SILT FENCING WITHIN 3 TO 5 FEET OF THE EDGE OF THE TEMPORARY SUPPORT ZONE AND ACCESS ROAD (AND ANY OTHER DISTURBED AREAS WITHIN THE PROJECT WORK LIMITS). TEMPORARY EROSION AND SEDIMENT CONTROLS SHALL BE THE RESPONSIBILITY OF THE CONTRACTOR DURING CONSTRUCTION, INCLUDING, BUT NOT LIMITED TO, INSPECTION, MAINTENANCE, AND INSTALLATION OF ADDITIONAL CONTROLS (AS NEEDED, AND IN COORDINATION WITH THE ENGINEER).
3. THE CONTRACTOR SHALL CLEAR EXISTING VEGETATION IN THE TEMPORARY SUPPORT ZONE AS NEEDED TO FACILITATE CONSTRUCTION. SITE CLEARING ACTIVITIES SHALL BE PERFORMED IN ACCORDANCE WITH THE CONTRACTOR'S OPERATIONS PLAN AND IN CONSULTATION WITH THE ENGINEER. TO THE EXTENT PRACTICABLE, EXISTING VEGETATION AND TOPSOIL SHALL BE LEFT IN PLACE IN AREAS THAT WILL NOT BE SUBJECT TO NEAR-TERM CONSTRUCTION ACTIVITIES.
4. THE CONTRACTOR MUST IDENTIFY THE SELECT AREA WITHIN THE TEMPORARY SUPPORT ZONE TO BE USED FOR CLEAN CONSTRUCTION MATERIAL STAGING. THE SPECIFIC LOCATION, ALIGNMENT, NUMBER, AND SIZE OF TEMPORARY SUPPORT ZONES SHALL BE IDENTIFIED BY THE CONTRACTOR IN HIS OPERATIONS PLAN.
5. NO STOCKPILED MATERIALS OR SUPPLIES OF ANY KIND SHALL BE STORED ON PRIVATE OR PUBLIC PREMISES, UNLESS OTHERWISE DIRECTED BY THE ENGINEER.
6. THE TURBIDITY CURTAIN SYSTEM SHALL BE INSTALLED PRIOR TO INITIATING CAP PLACEMENT AND/OR DEBRIS REMOVAL. THE CONTRACTOR SHALL INCLUDE TURBIDITY CURTAIN MATERIAL SPECIFICATIONS AND INSTALLATION DETAILS IN THEIR OPERATIONS PLAN.
7. THE TURBIDITY CURTAIN SYSTEM WILL BE VISUALLY INSPECTED DAILY BY THE CONTRACTOR DURING INSTALLATION, DEBRIS REMOVAL, AND CAPPING ACTIVITIES. ADDITIONAL INSPECTIONS WILL BE CONDUCTED AT THE CONTRACTOR'S DISCRETION AND/OR AT THE REQUEST OF THE ENGINEER FOLLOWING; HIGH-WAVE/FLOW PERIODS, NOTICEABLE TURBIDITY INCREASES OUTSIDE THE SYSTEM, UNEXPECTED CURTAIN POSITION/BEHAVIOR, CONTACT OF THE CURTAIN BY EQUIPMENT OR DEBRIS, OR OTHER ABNORMAL EVENTS.
8. TURBIDITY CURTAINS WILL BE MAINTAINED IN PROPER WORKING ORDER DURING DEBRIS REMOVAL AND CAPPING ACTIVITIES. ANY TORN, DAMAGED, OR OTHERWISE INEFFECTIVELY FUNCTIONING SECTIONS OF THE TURBIDITY CURTAIN IDENTIFIED DURING ROUTINE INSPECTIONS WILL BE PROMPTLY REPAIRED OR REPLACED BY THE CONTRACTOR, AS NECESSARY, TO MAINTAIN THE PERFORMANCE OBJECTIVES. THE TURBIDITY CURTAIN SHALL NOT BE REMOVED UNTIL THE TURBIDITY WITHIN THE SOUTH SLIP AREA IS LESS THAN 50 NEPHELOMETRIC TURBIDITY UNITS ABOVE THE UPSTREAM TURBIDITY LEVEL.
9. TEMPORARY SITE SECURITY FENCE, IF ANY, SHALL BE A MINIMUM OF SIX FEET TALL AND SELF SUPPORTED (I.E., POLES SHALL NOT BE DRIVEN, OR SET INTO GROUND). CONTRACTOR SHALL SUBMIT PROPOSED TEMPORARY SITE SECURITY FENCE DETAILS TO THE ENGINEER FOR REVIEW. TEMPORARY SITE SECURITY FENCE SHALL BE REMOVED FROM THE SITE FOLLOWING COMPLETION OF THE PROJECT. ADJUSTMENT OF THE TEMPORARY SITE SECURITY FENCE LOCATIONS SHOWN ON THIS DRAWING MAY BE REQUIRED TO FACILITATE CONSTRUCTION ACTIVITIES AS DETERMINED BY THE CONTRACTOR.
10. THE CONTRACTOR SHALL RESTORE ALL UPLAND AND BANK SURFACE FEATURES DISTURBED, DAMAGED, OR DESTROYED DURING THE REMEDIAL CONSTRUCTION ACTIVITIES TO PRE-CONSTRUCTION CONDITIONS AS SHOWN HEREIN OR AS DOCUMENTED DURING THE PRE-CONSTRUCTION MEETING ON-SITE. SUCH FEATURES INCLUDE, BUT ARE NOT LIMITED TO, THE ENGINEERED SOIL COVER, PAVEMENT AND CURBS, ROADS, VEGETATED SURFACES, AND ANY OF THE SIDEWALL STRUCTURES THAT BORDER THE SOUTH SLIP. TREES, SHRUBS, AND LANDSCAPE ITEMS DAMAGED OR DESTROYED AS A RESULT OF THE CONSTRUCTION OPERATIONS SHALL BE REPLACED IN LIKE SPECIES AND BASED ON DISCUSSIONS WITH THE OWNER.
11. THE CONTRACTOR SHALL GRADE THE ENGINEERED SOIL COVER AREA TO MATCH PRE-CONSTRUCTION ELEVATIONS, AND SHALL PERFORM A POST-RESTORATION TOPOGRAPHIC SURVEY TO ENSURE THAT THE RESTORED ELEVATION IS AT A MINIMUM AT THE PRE-CONSTRUCTION ELEVATIONS SHOWN HEREIN.
12. FOR ANY VEGETATED SURFACES DISTURBED DURING CONSTRUCTION FOR WHICH TOPSOIL WAS REMOVED, THE CONTRACTOR SHALL GRADE THE AREA TO WITHIN 6 INCHES OF FINAL GRADE, SHALL PLACE SIX INCHES OF TOPSOIL TO THE FINAL GRADE ELEVATIONS, AND SHALL SEED THE AREA. FOR VEGETATED SURFACES FOR WHICH TOPSOIL WAS NOT REMOVED, THE CONTRACTOR SHALL LOOSEN THE EXISTING TOPSOIL TO A DEPTH OF 2 TO 4 INCHES PRIOR TO SEEDING.
13. THE CONTRACTOR SHALL UNIFORMLY APPLY SEEDING AT A RATE OF NOT LESS THAN 1 POUND PER 1,000 SQUARE FEET. THE CONTRACTOR SHALL MAINTAIN NEWLY SEEDED AREAS IN GOOD CONDITION UNTIL SEEDED AREAS HAVE ESTABLISHED A MINIMUM UNIFORM 80-PERCENT DENSITY OF NATIVE PERENNIAL VEGETATION AND UNTIL ACCEPTABLE BY THE ENGINEER. THE CONTRACTOR SHALL BE REQUIRED TO REPAIR ANY AREAS OR EROSION AND RESEED AS NECESSARY UNTIL COMPLETE COVERAGE AND SATISFACTORY SOD GROWTH IS ACHIEVED.

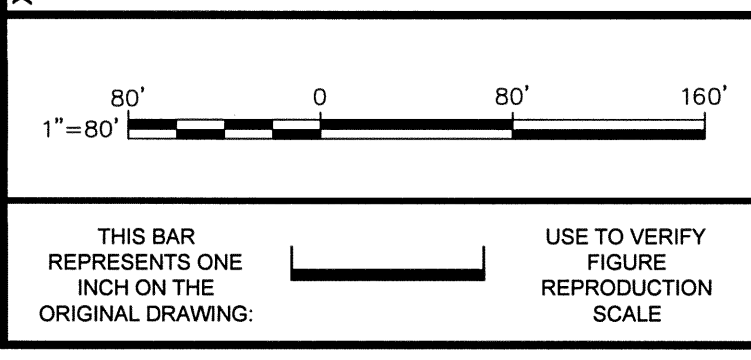

No.	Date	Revisions	By	Ckd

Professional Engineer's Name
MARK O. GRAVELDING
 Professional Engineer's No.
 062059378
 State
 ILLINOIS
 Date Signed
 6/11/12
 Project Mgr.
 MOG
 Designed by
 LP, AC
 Drawn by
 NES
 Checked by
 MOG



NAVISTAR, INC. • CHICAGO, ILLINOIS
 SOUTH SLIP SEDIMENT CAP DESIGN REPORT
SITE PREPARATION AND ENVIRONMENTAL CONTROLS PLAN

ARCADIS Project No. C1000684.0031.00008	3
Date JUNE 2012	
ARCADIS 6723 TONYPATH ROAD PO BOX 66 SYRACUSE, NEW YORK 13214 TEL. 315.446.9120	

CITY: SYRACUSE, NY; DIV: GROUP; ENV: CAD; DB: K. DAVIS; LD: PIC: M. GRAVELDING; P: M. G. VANDERLAAN; TM: L. PUTNAM; LXR: ON; OFF: REF; PLOT: 8/11/2012 10:35 AM; BY: SMITHGALL, NANCY
 G:\ENV\CAD\SYRACUSE\BEGACT\000664003\000001\DWG\CONTRACTOR\00664003.dwg; LAYOUT: 5; SAVED: 6/6/2012 2:27 PM; ACADVER: 18.15; LIMS TECH; PAGES: 5; PAGES SETUP: 5; PLOT: 8/11/2012 10:35 AM; BY: SMITHGALL, NANCY
 PROJECT NAME: MOC-ILL.tif
 XREFS: 00664000; 00664003

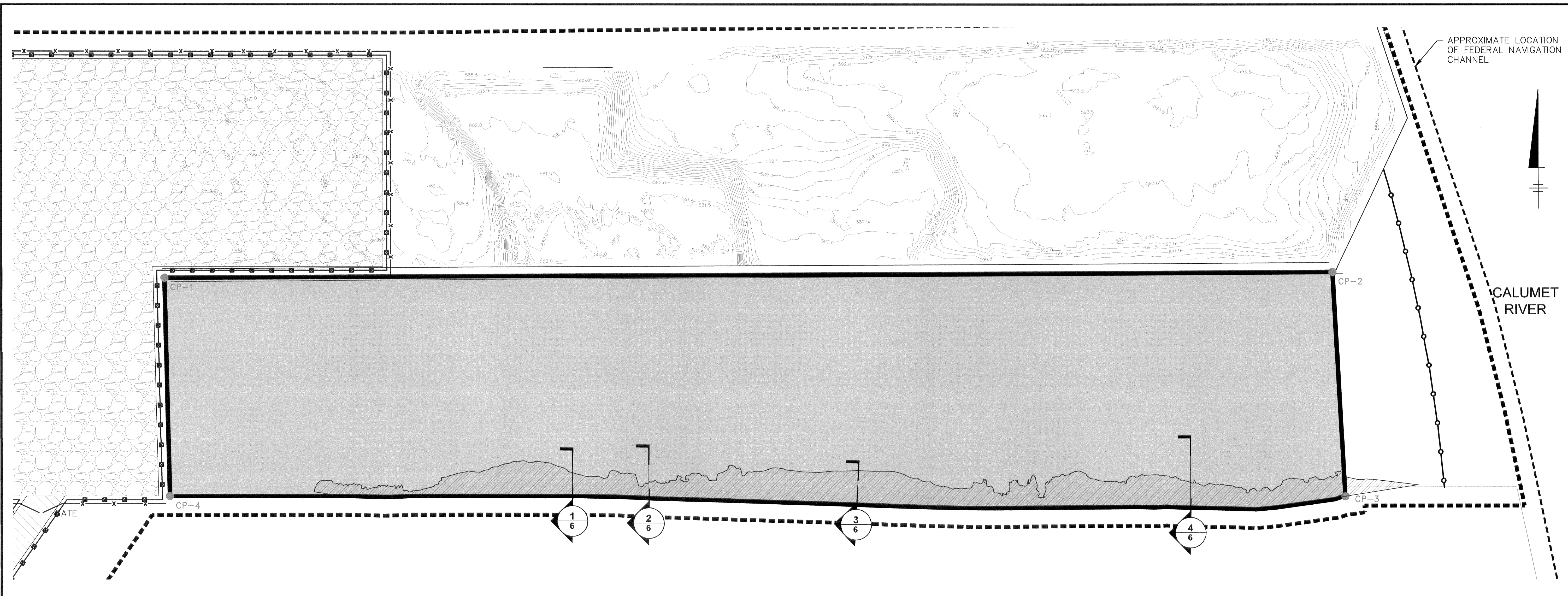

- LEGEND:**
- REMEDIAL FOOTPRINT
 - PROJECT WORK LIMITS
 - TOPOGRAPHIC CONTOUR
 - APPROXIMATE EXTENT OF SEDIMENT CAP
 - AREA TO RECEIVE CLEAN FILL FOR MAXIMUM 2H:1V SLOPE (SEE NOTE 2)
 - SILT FENCE
 - TEMPORARY SITE SECURITY FENCE
 - TURBIDITY CURTAIN
 - AREA AVAILABLE FOR TEMPORARY SUPPORT ZONE
 - CP-2 CONTROL POINT

- NOTE:**
1. REFER TO DRAWING 1 FOR ADDITIONAL NOTES, AND DRAWING 2 FOR BASE MAP INFORMATION.
 2. THE CONTRACTOR SHALL DOCUMENT THE PROPOSED SOURCE OF THE SAND/STONE/FILL MATERIALS TO BE USED ON-SITE, AND SHALL SUBMIT ALL ANALYTICAL DATA FROM TESTING OF THE SAND/FILL MATERIALS TO BE USED TO THE ENGINEER FOR REVIEW AND APPROVAL A MINIMUM OF TWO WEEKS PRIOR TO INSTALLATION. ANALYTICAL TESTING OF THE PROPOSED SAND/FILL MATERIAL SHALL BE FOR PESTICIDES, POLYCHLORINATED BIPHENYLS, TOTAL PETROLEUM HYDROCARBON, VOLATILE ORGANIC COMPOUNDS, POLYCYCLIC AROMATIC HYDROCARBONS, TOTAL METALS, MERCURY, TOTAL CYANIDE, AND PH. AT A MINIMUM, CONCENTRATIONS MUST BE LESS THAN TIERED APPROACH TO CORRECTIVE ACTION OBJECTIVES (TACO) 35 IAC 742 TIER 1 RESIDENTIAL CRITERIA TO BE APPROVED FOR USE ON-SITE. IN ADDITION, THE CONTRACTOR SHALL SUBMIT GEOTECHNICAL DATA FROM GRAIN SIZE ANALYSIS OF THE PROPOSED SAND/STONE/FILL MATERIALS.
 3. THE CONTRACTOR SHALL FILL AS NECESSARY WITH CLEAN MATERIAL TO MAINTAIN A MAXIMUM 2H:1V FINAL CAP SURFACE SLOPE IN THE AREA INDICATED. THE CONTRACTOR WILL ALSO MAINTAIN A MINIMUM 1-FOOT SAND LAYER WITH 2% TOC AND 6-INCH LAYER OF STONE FOR THE FULL EXTENT OF THE CAP AS SHOWN WITHIN THE REMEDIAL FOOTPRINT. THE CONTRACTOR SHALL PLACE ALL FILL MATERIAL REQUIRED PRIOR TO INITIATING PLACEMENT OF THE SEDIMENT CAP MATERIALS. ONE FULL LIFT OF THE CAP MATERIAL SHALL BE PLACED AT THE REQUIRED THICKNESS ACROSS THE ENTIRE AREA TO BE CAPPED PRIOR TO INITIATION OF THE PLACEMENT OF THE SUBSEQUENT LIFT. CAP MATERIAL PLACEMENT MAY BE SUSPENDED, AT THE DIRECTION OF THE ENGINEER, IF TURBIDITY TARGET LEVELS ARE EXCEEDED, AS DETAILED IN THE DESIGN REPORT.
 4. THE SAND LAYER FOR THE SEDIMENT CAP SHALL CONSIST OF CLEAN FINE TO COARSE SAND MATERIAL (USGS CLASSIFICATION SW) WITH A MINIMUM TOTAL ORGANIC CARBON CONTENT OF 2% WITH NOT GREATER THAN 10% MATERIAL PASSING THE #200 SIEVE.
 5. SAND MATERIAL TO BE USED WHERE EXCESS FILL IS REQUIRED TO ACHIEVE MINIMUM SLOPES, MATERIAL SHALL BE CONSISTENT WITH CAP SAND MATERIAL, HOWEVER WILL NOT BE SUBJECT TO THE TOTAL ORGANIC CARBON REQUIREMENT.
 6. THE STONE LAYER FOR THE SEDIMENT CAP SHALL CONSIST OF CLEAN POORLY GRADED ANGULAR STONE WITH A D_{50} OF 2 INCHES, AND A D_{MAX} AND D_{MIN} OF 3-INCHES AND 1-INCH, RESPECTIVELY.
 7. THE CONTRACTOR SHALL DETERMINE THE APPROPRIATE MEANS AND METHODS BY WHICH TO PLACE MATERIALS AND SPECIFY AS SUCH IN THEIR OPERATIONS PLAN.
 8. OUTSIDE OF THE REMEDIAL FOOTPRINT ON THE EAST END OF THE SOUTH SLIP, THE CONTRACTOR SHALL TAPER EACH LAYER OF THE CAP AT NO MORE THAN A 2H:1V SLOPE FROM THE RESPECTIVE 1-FOOT AND 6-INCH FULL THICKNESSES TO INTERSECT WITH EXISTING GRADE. THE CONTRACTOR SHALL FILL AS NECESSARY WITH CLEAN FILL MATERIAL (PRIOR TO PLACING THE CAP MATERIAL) TO ENSURE THIS MAXIMUM 2H:1V SLOPE, SIMILAR TO AS SHOWN FOR THE AREA ALONG THE SOUTH SHORE (SEE DRAWING 6).
 9. FILL AND CAP MATERIAL SHALL BE PLACED FROM THE TOE OF SLOPE TO THE TOP OF SLOPE (I.E., SHALL BE PLACED STARTING AT THE LOWEST ELEVATIONS) AND SHALL BE PLACED IN LIFTS NO MORE THAN SIX-INCHES IN THICKNESS. THE CONTRACTOR SHALL NOT PLACE FILL MATERIAL (WHERE EXCESS FILL IS REQUIRED FOR SLOPE STABILITY) THROUGH THE WATER COLUMN FROM THE WATER SURFACE, AND SHALL RELEASE FROM BUCKETS A DISTANCE NO GREATER THAN TWO FEET ABOVE THE SEDIMENT SURFACE. IF THE CONTRACTOR PROPOSES TO PLACE DRY CAP MATERIAL BY MECHANICAL METHODS, THE MATERIAL SHOULD BE PLACED FROM NO GREATER THAN TWO FEET ABOVE THE SEDIMENT/FILL SURFACE.
 10. A MINIMUM OF TWO LIFTS OF THE SAND LAYER IS REQUIRED TO MEET THE MINIMUM 1-FOOT DESIGN THICKNESS, AND A MINIMUM OF ONE LIFT OF THE STONE LAYER IS REQUIRED TO MEET THE MINIMUM 6-INCH DESIGN THICKNESS. THE MINIMUM TOLERANCE FOR EACH LAYER OF THE SEDIMENT CAP IS 1-FOOT AND 6-INCHES FOR THE SAND AND STONE LAYERS, RESPECTIVELY. THE MAXIMUM ALLOWABLE LAYER THICKNESS IS 120% OF THE SPECIFIED LAYER THICKNESS AT ANY LOCATION. THE ENGINEER MAY REQUIRE REMOVAL OF EXCESS MATERIAL AT NO ADDITIONAL COST.
 11. FOLLOWING PLACEMENT OF THE SAND LAYER OF THE CAP, INTERIM MONITORING WILL BE PERFORMED BY THE ENGINEER TO CONFIRM THAT THE REQUIRED THICKNESS HAS BEEN ACHIEVED. THE

12. FOLLOWING PLACEMENT OF THE STONE LAYER OF THE CAP, MONITORING WILL BE PERFORMED BY THE ENGINEER TO CONFIRM THAT THE REQUIRED THICKNESS HAS BEEN ACHIEVED. BASED ON THE RESULTS AND REVIEW OF THE INTERIM MONITORING, MODIFICATIONS MAY BE MADE TO THE CAP PLACEMENT METHODS AND/OR ADDITIONAL SAND MAY BE PLACED IN CERTAIN AREAS TO BRING THE THICKNESS OF THE SAND LAYER OF THE CAP UP TO A MINIMUM OF 1-FOOT.
11. THE CONTRACTOR SHALL BE REQUIRED TO SUBMIT A POST-CONSTRUCTION BATHYMETRIC SURVEY TO DOCUMENT FINAL SLOPES.

CONTROL POINTS		
ID	NORTHING	EASTING
CP-1	1832140.08	1196328.54
CP-2	1832144.78	1197259.95
CP-3	1831965.74	1197270.13
CP-4	1831965.75	1196332.80

CONTROL POINTS ARE SHOWN IN FEET IN THE ILLINOIS EAST STATE PLANE COORDINATE SYSTEM.

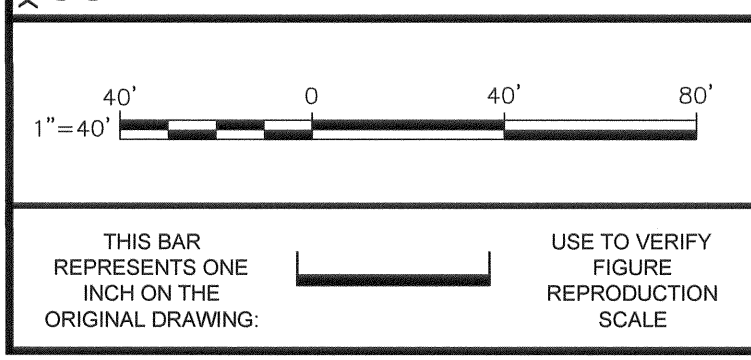

No.	Date	Revisions	By	Ckd

THIS DRAWING IS THE PROPERTY OF THE ARCADIS ENTITY IDENTIFIED IN THE TITLE BLOCK AND MAY NOT BE REUSED OR ALTERED IN WHOLE OR IN PART WITHOUT THE EXPRESS WRITTEN PERMISSION OF SAME.

Professional Engineer's Name
MARK O. GRAVELDING
 Professional Engineer's No.
 062059378
 State
 ILLINOIS
 Date Signed
 6/11/12
 Project Mgr.
 MOG
 Designed by
 LP, AC
 Drawn by
 NES
 Checked by
 MOG

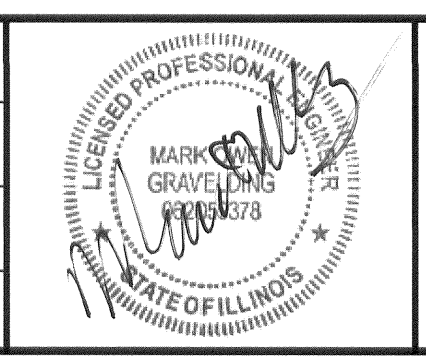

NAVISTAR, INC. • CHICAGO, ILLINOIS
 SOUTH SLIP SEDIMENT CAP DESIGN REPORT

SEDIMENT CAP INSTALLATION PLAN

ARCADIS Project No.
 C1000664.0031.00008
 Date
 JUNE 2012
 ARCADIS
 6723 TOWPATH ROAD
 PO BOX 86
 SYRACUSE, NEW YORK 13214
 TEL. 315.446.9120

CITY, SYRACUSE, NY DIV/GROUP: EN/CAD, DB: K DAVIS, LD: PIC: M GRAVELDING, PM: G VANDERLAAN, TM: L PIUTNAM, LXR: ONE, OFF: REF, PLOT: 6/11/2012 10:36 AM, BY: SMITHGALL, NANCY
 G:\ENVCAD\SYRACUSE\PROJECT\C000664003\700001\DWG\CONTRACT\00664006.dwg, LAYOUT: 6, SAVED: 6/8/2012 2:31 PM, ACADVER: 18, IS (LMS TECH) PAGES: 18, PLOTSETUP: ---, PLOTSTYLETABLE: PLTCONT.CTB, PLOT: 6/11/2012 10:36 AM, BY: SMITHGALL, NANCY
 XREFS: 00664X00, PROJECTNAME: ---, IMAGES: MOG-ILL.tif

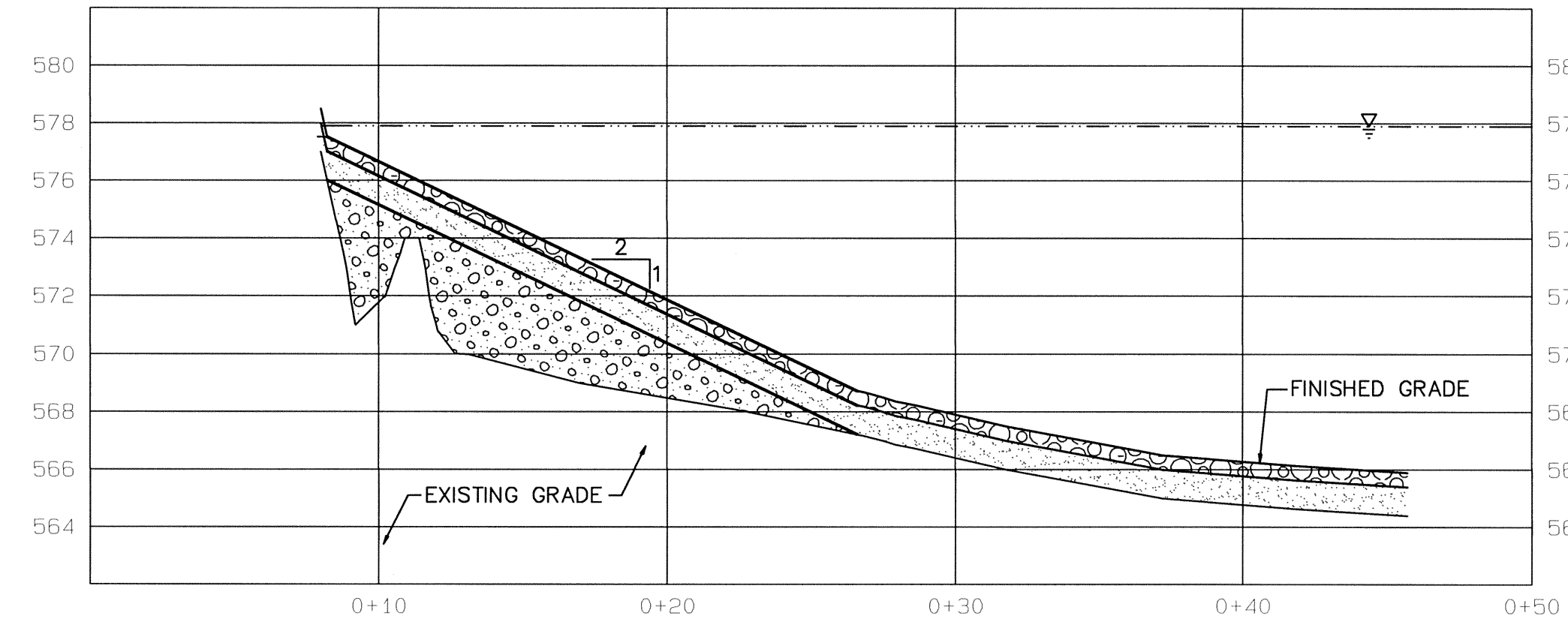

SECTION 1 (TYP.)
 0 5' 10'
 HORIZONTAL AND VERTICAL SCALE

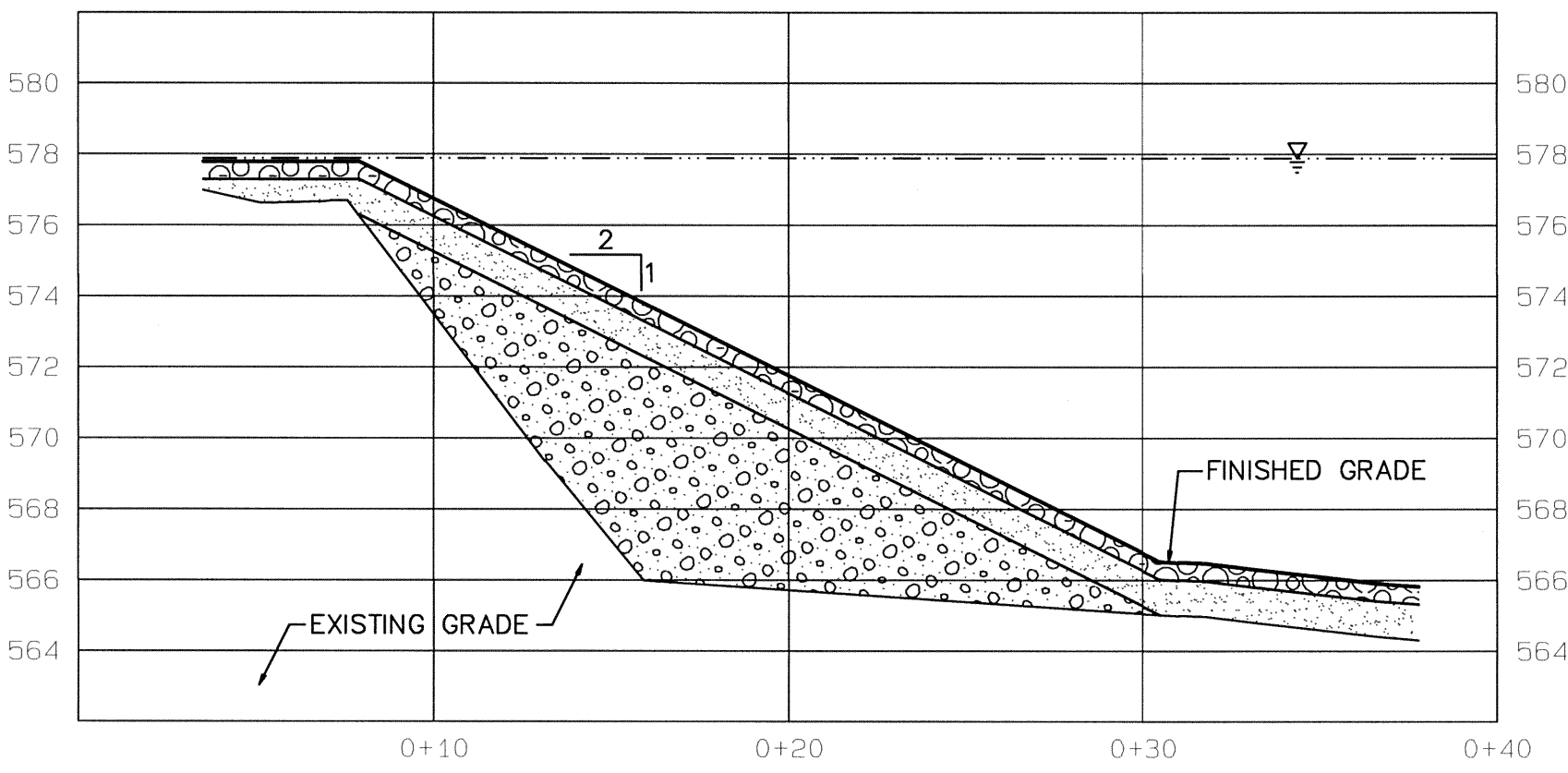

SECTION 3 (TYP.)
 0 5' 10'
 HORIZONTAL AND VERTICAL SCALE

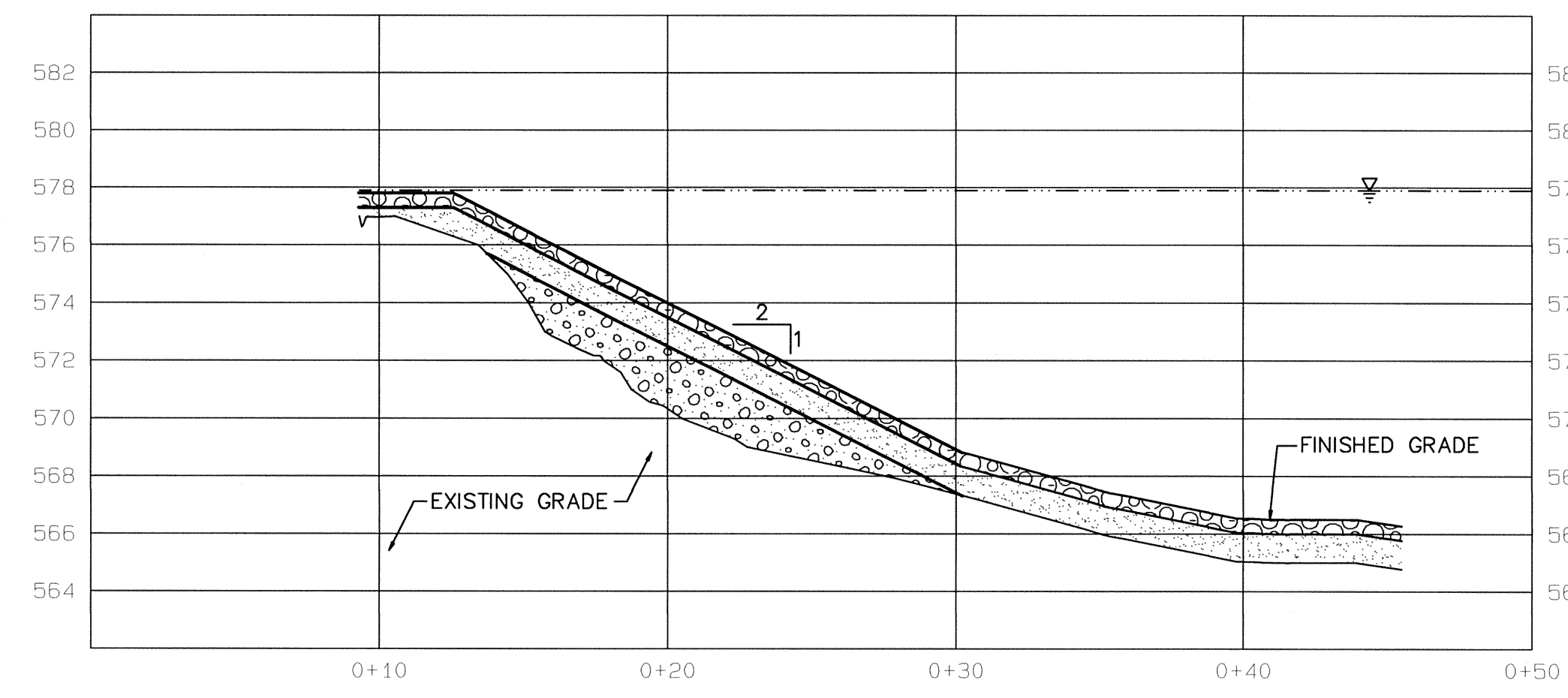

SECTION 2 (TYP.)
 0 5' 10'
 HORIZONTAL AND VERTICAL SCALE

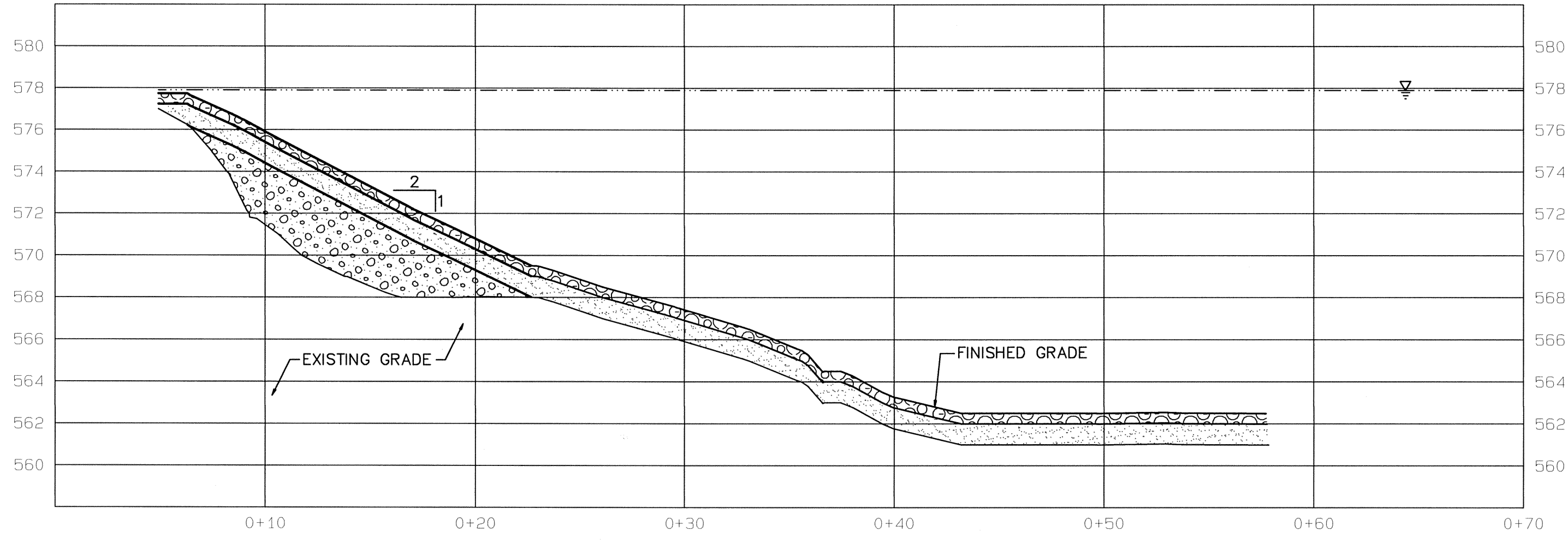

SECTION 4 (TYP.)
 0 5' 10'
 HORIZONTAL AND VERTICAL SCALE

- LEGEND:**
- STONE LAYER (6-INCH MIN.)
 - SAND LAYER WITH 2% TOC (1-FOOT MIN.)
 - CLEAN SAND FILL
 - WATER SURFACE ELEVATION (MARCH 2011)

- NOTES:**
- THE CROSS-SECTIONS DISPLAYED ARE FOR CONCEPTUAL VISUALIZATION PURPOSES ONLY. IT IS ANTICIPATED THAT SOME LOCALIZED GRADING MAY BE REQUIRED TO CREATE A SUITABLE SURFACE FOR CAPPING.
 - THE POOL ELEVATION AT THE SOUTH SLIP IS DETERMINED TO BE ELEVATION 577.9 FEET ABOVE SEA LEVEL (ASL) (MARCH 2011). THE ORDINARY HIGH WATER (OHW) AND ORDINARY LOW WATER (OLW) ELEVATIONS HAVE NOT BEEN DETERMINED. PER US ARMY CORPS OF ENGINEERS, THE MAXIMUM POOL ELEVATION FLUCTUATION IS DETERMINED TO BE BETWEEN ELEVATION 577 AND 579 FEET ASL (APPROXIMATELY 1.0' ABOVE AND BELOW ITS USUAL ELEVATION) (USACE 2012).
 - THE CONTRACTOR SHALL FILL AS NECESSARY WITH CLEAN SAND MATERIAL TO MAINTAIN A MAXIMUM 2H:1V SLOPE AS SHOWN.
 - THE SEDIMENT CAP SHALL BE PLACED SUCH THAT IT IS TERMINATED AT OR BEFORE A MAXIMUM ELEVATION OF 577.8 FEET ABOVE SEA LEVEL (I.E., APPROXIMATELY 0.1 FEET BELOW THE NORMAL POOL ELEVATION OF 577.9 FEET). THE SAND LAYER OF THE CAP SHALL BE PLACED SUCH THAT THE TOP ELEVATION OF THE LAYER DOES NOT EXCEED 577.3 FEET, AND WILL BE TAPERED AS NECESSARY TO COVER THE FULL HORIZONTAL EXTENT OF THE AREA TO BE CAPPED. THE STONE LAYER OF THE CAP SHALL BE PLACED SUCH THAT THE TOP ELEVATION OF THE LAYER DOES NOT EXCEED 577.8 FEET ABOVE SEA LEVEL, AND WILL BE TAPERED AS NECESSARY TO COVER THE FULL HORIZONTAL EXTENT OF THE AREA TO BE CAPPED.

SCALE(S) AS INDICATED					
THIS BAR REPRESENTS ONE INCH ON THE ORIGINAL DRAWING.	USE TO VERIFY FIGURE REPRODUCTION SCALE	No.	Date	Revisions	By
		THIS DRAWING IS THE PROPERTY OF THE ARCADIS ENTITY IDENTIFIED IN THE TITLE BLOCK AND MAY NOT BE REUSED OR ALTERED IN WHOLE OR IN PART WITHOUT THE EXPRESS WRITTEN PERMISSION OF SAME.			

Professional Engineer's Name
MARK O. GRAVELDING
 Professional Engineer's No.
 062059378
 State
 ILLINOIS
 Date Signed
 6/11/12
 Project Mgr.
 MOG
 Designed by
 LP, AC
 Drawn by
 NES
 Checked by
 MOG

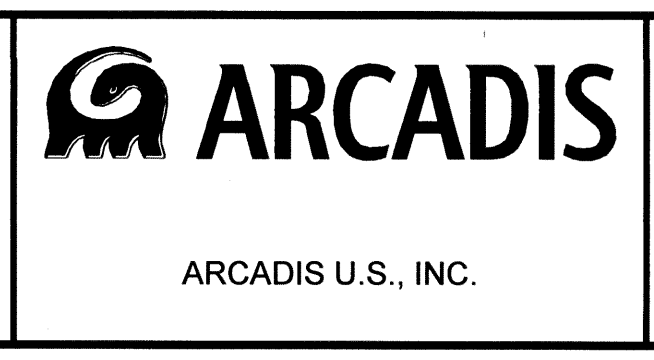
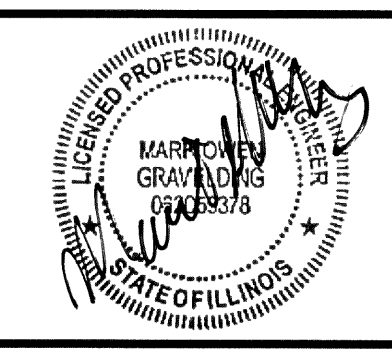

NAVISTAR, INC. • CHICAGO, ILLINOIS
 SOUTH SLIP SEDIMENT CAP DESIGN REPORT
SOUTH SLOPE TYPICAL SECTIONS

ARCADIS Project No.
 C1000664.0031.00008
 Date
 JUNE 2012
 ARCADIS
 6723 TOWPATH ROAD
 PO BOX 66
 SYRACUSE, NEW YORK 13214
 TEL. 315.446.9120

CITY: SYRACUSE, NY DIV/GROUP: ENV/CAD DB: K.DAVIS LD: P.C. M.GRAVELDING PM: G.VANDERLAAN TM: L.PUTNAM LYN: ON*OFF=REF-
 G:ENV/CAD/SYRACUSE/BEACACT/C00006640037000011/DWG/CONTRACT/00664G07.dwg LAYOUT: 7 SAVED: 6/6/2012 2:33 PM ACADVER: 18.1S (LMS TECH) PAGESETUP: --- PLOTSTYLETABLE: PLTCONT.CTB PLOTTED: 6/11/2012 10:37 AM BY: SMITHGALL, NANCY
 XREFS: IMAGES: MOG-ILL.tif PROJECTNAME: ---
 00664X00

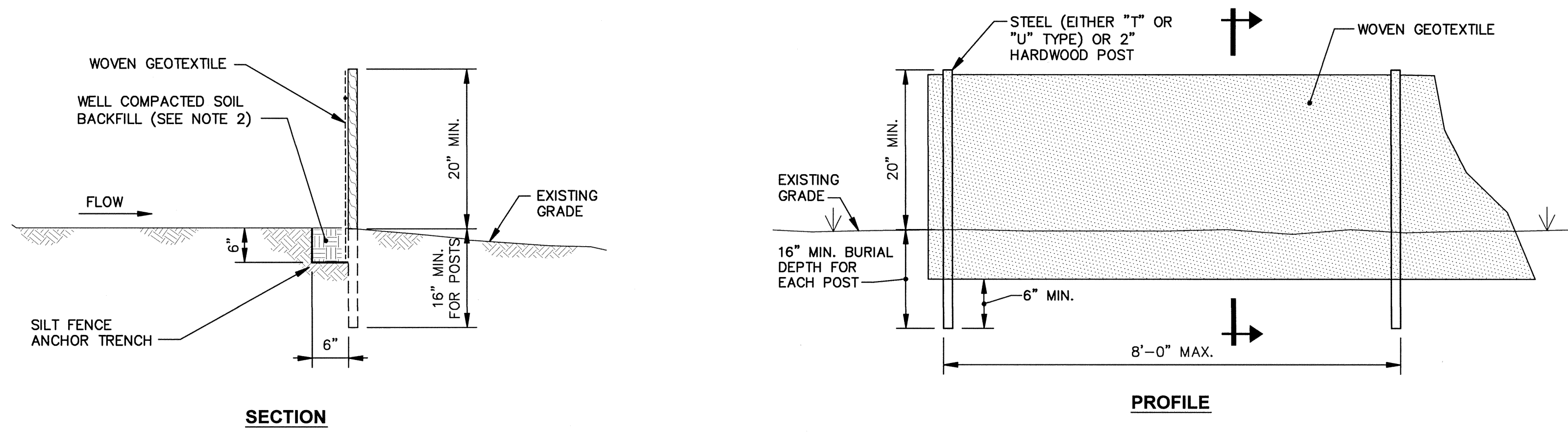

SECTION

PROFILE

- NOTES:**
1. ANY MATERIAL DEPOSITS SHALL BE REMOVED AS ACCUMULATED OR AS DIRECTED BY THE OWNER, AND STOCKPILED FOR USE DURING RESTORATION OR FOR DISPOSAL BY THE CONTRACTOR DURING DEMOBILIZATION.
 2. THE SILT FENCE SHALL BE FOLDED INTO A TRENCH AND BACKFILLED WITH NATIVE SOIL.

SILT FENCE 1
NOT TO SCALE

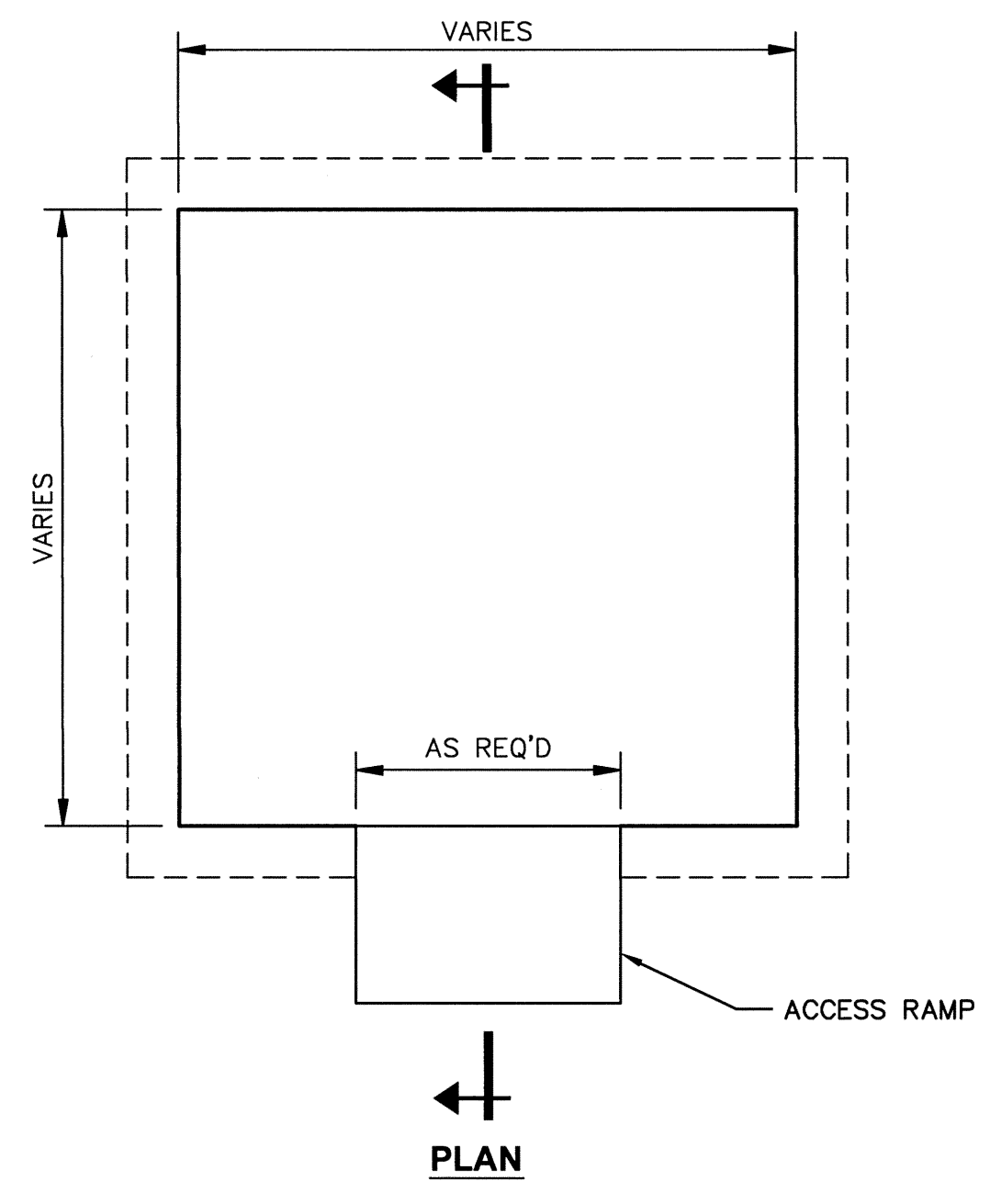

PLAN

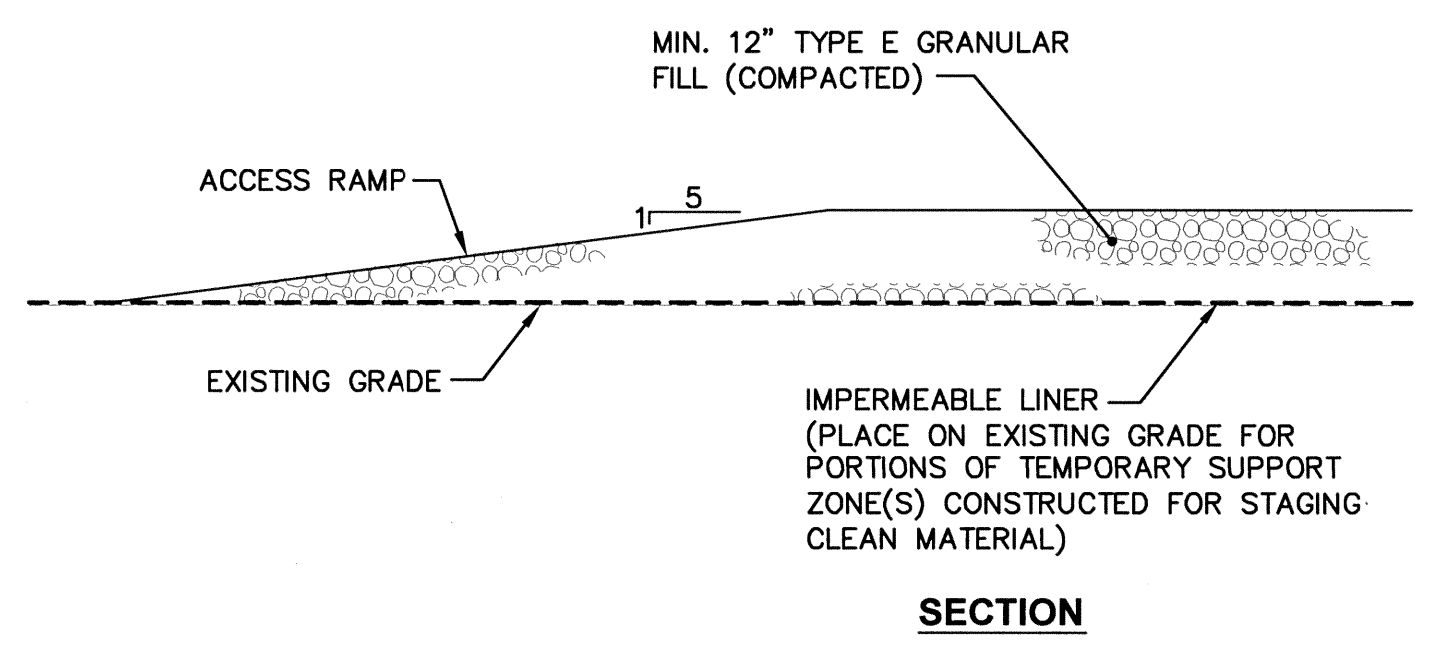

SECTION

- NOTES:**
1. MATERIALS WITHIN TEMPORARY SUPPORT ZONE TO BE COVERED WITH 10 MIL PLASTIC SHEETING OVERNIGHT AND/OR DURING EXTREME WEATHER EVENTS.
 2. UPON COMPLETION OF CONSTRUCTION ACTIVITIES, THE TEMPORARY SUPPORT ZONE, INCLUDING GEOSYNTHETICS, SHALL BE REMOVED BY THE CONTRACTOR FOR OFFSITE DISPOSAL AT AN OWNER APPROVED FACILITY.
 3. COMPACTION OF GRANULAR FILL MATERIAL SHALL BE OF SUFFICIENT DENSITY TO PROVIDE A FIRM AND UNIFORM SURFACE.
 4. ALL CLEAN STOCKPILED MATERIAL SHALL BE PLACED IN A LINED PORTION OF THE TEMPORARY SUPPORT ZONE(S) WITH A MINIMUM 12" OF STONE.

TYPICAL TEMPORARY SUPPORT ZONE 3
NOT TO SCALE

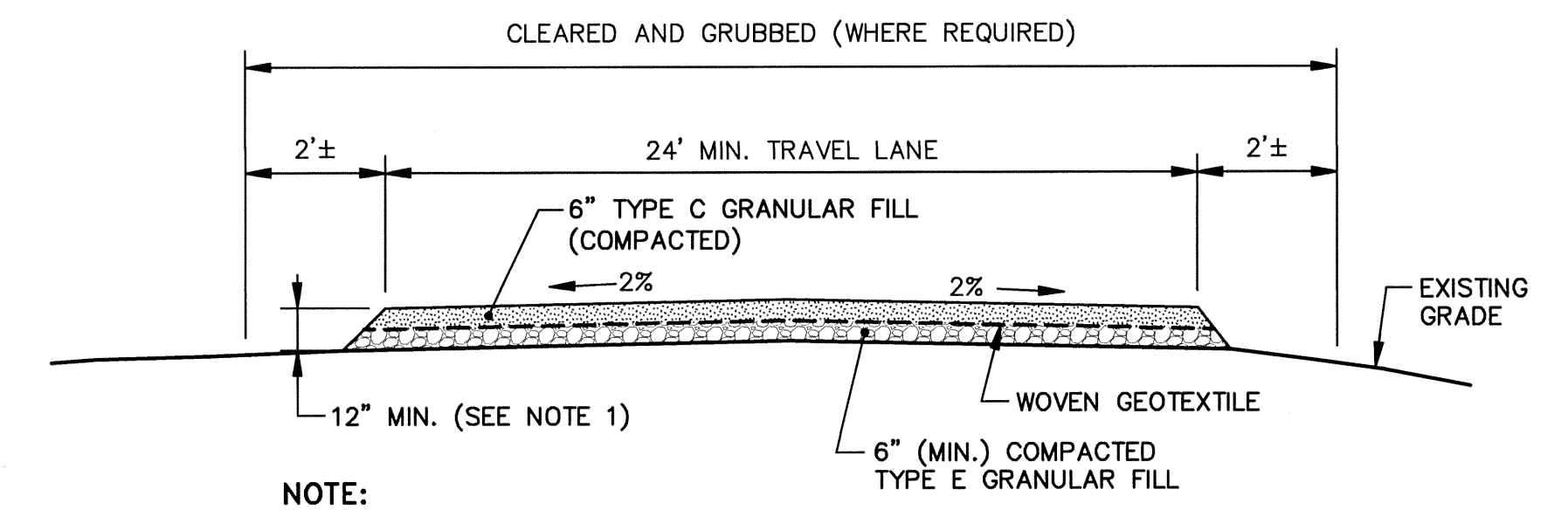

- NOTE:**
1. ACTUAL THICKNESS OF GRAVEL TO BE DETERMINED IN THE FIELD BASED UPON SITE CONDITIONS ENCOUNTERED AT TIME OF CONSTRUCTION.

TYPICAL TEMPORARY ACCESS ROAD/PAD 2
NOT TO SCALE

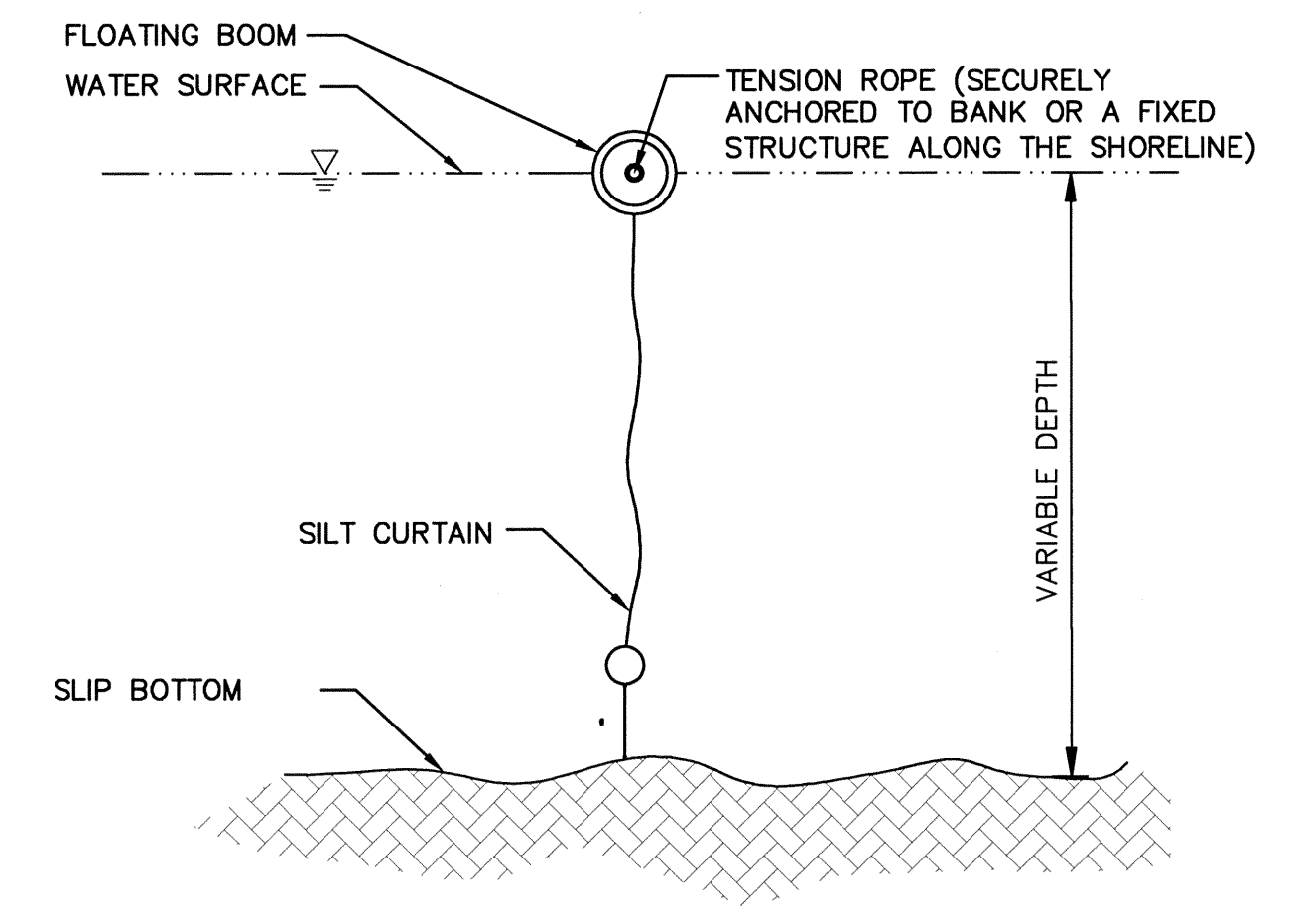

- NOTES:**
1. THE CURTAIN SHALL BE INSTALLED PRIOR TO COMMENCING REMEDIATION ACTIVITIES, AND MAINTAINED BY THE CONTRACTOR UNTIL THE OWNER APPROVES REMOVAL.
 2. THE SILT CURTAIN SHALL BE ANCHORED TO THE NORTH AND SOUTH SIDES OF THE ENTRANCE TO THE SOUTH SLIP APPROXIMATELY 50 FEET EAST OF THE EASTERN EDGE OF THE REMEDIATION FOOTPRINT, AND IN A LOCATION SUCH THAT THE CURTAIN SHALL NOT ENTER IN TO THE CALUMET RIVER FEDERAL NAVIGATION CHANNEL AT ANY TIME.
 3. THE CONTRACTOR SHALL USE ADDITIONAL ANCHORING (E.G., 'DEADMAN' CONCRETE BLOCKS, MUSHROOM-TYPE ANCHORS) IF FLOW CONDITIONS DICTATE ADDITIONAL ANCHORING IS NECESSARY AND/OR AS REQUESTED BY THE OWNER.
 4. THE CURTAIN SHALL HAVE SURFICIAL FLOATATION DEVICES AND CHAIN BALLAST ENCLOSED IN FABRIC POCKETS AT THE BOTTOM EDGE OF THE CURTAIN SO THE CURTAIN RESTS ON THE SEDIMENT SURFACE. THE CURTAIN SHOULD BE REEFABLE FOR WATER DEPTH VARIATION ADJUSTMENTS, AS NEEDED.
 5. THE CONTRACTOR SHALL INSPECT THE SILT CURTAIN(S) ON A DAILY BASIS FOR DAMAGE, APPROPRIATE FUNCTION, AND PRESENCE OF DEBRIS.
 6. THE CONTRACTOR SHALL PROVIDE LIGHTING AND SIGNAGE THAT WILL BE IMPLEMENTED TO ADEQUATELY NOTIFY PROJECT AND NON-PROJECT VESSELS OF A WORK AREA AND THE PRESENCE OF AN IN-WATER TURBIDITY CONTROL SYSTEM. AT A MINIMUM, LIGHTED BUOYS MUST BE PLACED EITHER ON THE TURBIDITY CURTAIN OR OUT FROM THE TURBIDITY CURTAIN'S MID-WAY POINT WITHIN THE MOUTH TO THE SOUTH SLIP. SIGNS INDICATING 'WORK AREA - STAY BACK' OR OTHER APPROPRIATE MESSAGES APPROVED BY THE ENGINEER SHALL BE INSTALLED IN APPROPRIATE LOCATIONS SIMILAR TO THOSE SPECIFIED FOR THE LIGHTED BUOYS. ALL LIGHTED ACTIVITIES AND SIGNAGE REQUIREMENTS SHALL BE IN COMPLIANCE WITH ALL APPLICABLE UNITED STATES COAST GUARD STANDARDS AND REQUIREMENTS.

TYPICAL FLOATATION SILT CURTAIN 4
NOT TO SCALE

SCALE(S) AS INDICATED THIS BAR REPRESENTS ONE INCH ON THE ORIGINAL DRAWING.	USE TO VERIFY FIGURE REPRODUCTION SCALE	<table border="1" style="width: 100%; border-collapse: collapse;"> <tr> <th>No.</th> <th>Date</th> <th>Revisions</th> <th>By</th> <th>Ckd</th> </tr> <tr> <td> </td> <td> </td> <td> </td> <td> </td> <td> </td> </tr> </table>	No.	Date	Revisions	By	Ckd						Professional Engineer's Name MARK O. GRAVELDING Professional Engineer's No. 062059378 State ILLINOIS Date Signed 6/11/12 Project Mgr. MOG Drawn by MOG Checked by MOG			NAVISTAR, INC. • CHICAGO, ILLINOIS SOUTH SLIP SEDIMENT CAP DESIGN REPORT MISCELLANEOUS DETAILS	ARCADIS Project No. C1000664.0031.00008 Date JUNE 2012 ARCADIS 6723 TOWPATH ROAD PO BOX 66 SYRACUSE, NEW YORK 13214 TEL. 315.446.9120	7
No.	Date	Revisions	By	Ckd														



Appendix C

Cap Material Design and Assessment

1. Introduction

As detailed in the South Slip Remedial Action Plan (RAP; ARCADIS 2011) and this Design Report, specific cleanup targets for sediment, porewater, surface water, or fish tissue have not been established for the South Slip. The Phase II Risk Assessment (ARCADIS 2010) established polycyclic aromatic hydrocarbons (PAHs) as the primary risk-driving constituent of concern (COC) for ecological receptors and sediment and porewater as the primary risk-driving media. The Phase II Risk Assessment (ARCADIS 2010) also identified potential human health risk from consuming fish tissue based on conservative assumptions.

Installation of a sediment cover/cap is a U.S. Environmental Protection Agency (USEPA)-approved technology for the remediation of impacted subaqueous materials. A sediment cover is a remediation alternative in which a layer of clean material is placed to contain and stabilize impacted sediment and to isolate those sediments from the biologically active zone within the sediment bed and/or from the overlying water column. The cover may be constructed of clean sediment, sand, gravel and/or amended material, or may, if necessary, involve a more complex design using geotextiles, liners, and sorbent materials. A sediment cover is generally designed to reduce risk through:

- Physical isolation of the impacted sediment sufficient to reduce exposure from direct contact and to reduce the ability of burrowing organisms to move contaminants to the surface.
- Chemical isolation of contaminated sediment sufficient to reduce exposure from dissolved contaminants that may be transported into the water column.
- Stabilization of contaminated sediment and erosion protection of sediment and cover sufficient to reduce resuspension and transport of contaminants into the water column (USEPA 2005).

The cap to be placed as part of the remedial action for the South Slip will include an isolation layer to retard the transportation of dissolved-phase constituents into and through the cap (i.e., provide physical and chemical isolation). In so doing, the cap will be designed to maintain PAH concentrations at the top of the isolation layer at levels consistent with or below background concentrations for a calculated lifespan. This remedial action will also reduce exposure to anglers that may consume fish from the South Slip. In addition to the isolation layer, the cap will also include a protective armor layer of stone to provide stability to the isolation layer and underlying native sediment.

1.1 Sediment Constituent Transport and Cap Modeling

Many COCs are partitioned to the solid phase, and remain tightly bound to sediment particles. Certain COCs (including PAHs) also exhibit a dissolved phase and are present in porewater and/or surface water. While a sediment cap will effectively provide a simple barrier between the solid-phase COCs and potential ecological receptors, the movement of dissolved-phase contaminants found in the porewater is possible through a variety of mechanisms. The presence of an isolation layer (as part of an overall capping system) provides long-term retardation of dissolved-phase constituent flux (i.e., migration) from the sediment and/or porewater into and through the cap and ultimately to the water column. In so doing, an isolation layer addresses the following physicochemical processes that contribute to potential migration/transfer of the dissolved-phase COCs:

- (a) Molecular diffusion (in the absence of groundwater flow); and
- (b) Advection/dispersion/retardation (in response to groundwater flow through the sediment).

Diffusive Transport

Diffusion is the process whereby ionic and molecular species in water are transported by random molecular motion from an area associated with high concentrations to an adjacent area associated with low concentrations. Diffusional mass transport assumes that the rate of transport is directly proportional to the concentration gradient. By including a cap, the concentration gradient is significantly reduced by the increased distance through which material must diffuse. From an environmental perspective, diffusion is one of the slowest contaminant transport processes in a porous medium. However, although diffusion is extremely slow, diffusional driven mass transport will always occur if concentration gradients are present. Consequently, diffusion can transport contaminants through a saturated porous media in the absence of advection.

Advective Transport

Advective transport refers to the movement of dissolved-phase site constituents found in porewater. Advection can occur during cap placement as a result of compression or consolidation of the sediment beneath the new/additional overburden associated with the cap. The weight of the cap will "squeeze" the sediments, and as the porewater from the sediments moves upward, it displaces or mixes with porewater in the cap. The result is that contaminants can move part of the way into the cap in a short period of time.

Advection can also occur as an essentially continuous process if there is an upward hydraulic gradient due to groundwater flow. An estimation of the rate of groundwater discharge can either be obtained empirically through the use of piezometers, or calculated through the use of Darcy's law and knowledge of the site hydrogeology.

Transport Summary

Contaminant flux is composed of diffusive and advective transport, though advection, if present, is generally dominant. Over time, contaminants can reach the surface of the cap, or at a minimum the bottom of the bioturbation zone (breakthrough), which can reintroduce potential risk to human and ecological receptors (e.g., benthic organisms that have recolonized the cap surface). The isolation layer in the South Slip cap design addresses these processes by increasing the transport distance necessary to reach the cap-water interface, and by, if considered necessary, increasing the availability of materials for sorption processes to occur, thereby binding dissolved constituent fractions within the isolation layer and retarding the overall transport process.

Chemical Transport Modeling

To predict the performance of an isolation layer after placement, the processes discussed above are generally evaluated through predictive mathematical modeling. Modeling has been developed to evaluate the performance of the proposed cap by estimating the time for cap material at the top of the isolation layer to approach Background Threshold Values (BTVs) for PAHs (see Appendix E). Sediment-related parameters selected for this type of evaluation are based to the extent practicable on site-specific data, although some general model inputs may be estimated or assumed based on general information or similar data from similar sites.

1.2 Cap Scour Protection

Although the cap placed over the sediments in the South Slip will provide a physical barrier to ecological receptors and delay the migration of PAHs, the scour potential associated with water flow and or watercraft operation can resuspend and redistribute the PAHs in the sediments. An assessment of the potential for the scour of cap materials was performed based on the results of the Pre-Design Investigation (PDI) activities. As discussed in the RAP, water velocities within the South Slip are generally negligible, and do not approach the typical range where scour is anticipated. However, a review of the potential water craft and vessels anticipated for use in the South Slip was performed to assess the potential for material scour caused by propeller wash. As propeller-driven watercraft engage their engines, the rotating propeller beneath the vessel imparts thrust against the water, which causes a jet of water and turbulence that may have a scouring effect on the surface of the sediment bed, or in this instance on the surface of the cap. It has been assumed that the future use of the South Slip will include barge mooring and tugboat operations. Based on these assumptions and other conservative inputs, an assessment of the potential for scour associated with future uses of the South Slip was performed to determine the need for and select an appropriately sized armor stone to protect against potential erosional forces in the slip.

1.3 Description of Remedy

The proposed cap will be placed over the sediments in the bottom of the South Slip. The cap consists of a 12-inch isolation layer of clean granular material (e.g., fine sands) with a minimum 2% total organic carbon (TOC) content, covered by a 6-inch armor layer with a 2-inch median stone size.

This appendix includes Attachments C-1 and C-2, which summarize design considerations associated with the design and selection of materials for the cap to be placed over the sediments in the South Slip. Attachment C-1 consists of a memo describing the modeling of the potential for porewater transport associated with the native sediments and cap to be constructed in the South Slip. Also presented is an estimated time for expected concentrations in the top of the isolation layer to approach calculated BTVs related to sediment and porewater conditions in and around the South Slip. Attachment C-2 presents a discussion of the potential for propeller wash in the South Slip associated with current and anticipated future use and vessel traffic. This memo also presents maximum estimated scour and the selection of an appropriately sized armor stone and armor layer thickness.

Note that the design for the South Slip sediment cap considered bioturbation and the potential for the resultant mixing of cap materials with underlying sediment. Industry standards for the estimation of bioturbation suggest that the depths of the bioactive zone are generally limited to no more than the top 10 centimeters (less than 4 inches) of materials in subaqueous settings. As this assumed depth is within the assumed 6-inch thickness described above for the armor layer, the effects of bioturbation are not anticipated to adversely influence the performance of the isolation layer of the sediment cap.

2. References

ARCADIS. 2010. Phase II Risk Assessment: South Slip, Former Wisconsin Steel Works, Chicago, IL. September.

ARCADIS. 2011. Wisconsin Steel Works South Slip Remedial Action Plan. September.

U.S. Environmental Protection Agency (USEPA). 2005. Contaminated Sediment Remediation Guidance for Hazardous Waste Sites. OSWER 9355.0-85. EPA/540/R-05/012. USEPA Office of Solid Waste and Emergency Response. December.



Attachment C-1

Assessment of Potential Porewater
Transport and Cap Design

1. Introduction

This memorandum has been prepared to summarize the design process for the isolation layer portion of the sediment cap constructed in the South Slip of the Wisconsin Steel Works (WSW) property in Chicago, IL.

As discussed in the South Slip Sediment Cap Design Report (Design Report), the proposed sediment cap has been designed to provide physical isolation of the native material and retardation of the potential transport of dissolved-phase constituents from the native material to the overlying surface water column. The proposed sediment cap was designed based on the anticipated post-remediation use of the South Slip, existing sediment analytical data for the Site, as well as a number of conservative assumptions (e.g., estimated porewater velocities), using a widely accepted numeric model developed to assess the potential for dissolved-phase constituents from the underlying sediment to migrate into and through the cap.

The evaluation summarized herein has been performed to estimate the potential chemical transport and present the results of numerical modeling used in selection of the isolation layer materials and cap thickness. As with the design of the armor layer presented in Attachment C-2, the design of the isolation layer and the selection of appropriate materials is an iterative process involving modifying the cap thickness and/or the cap material characteristics until the target acceptable cap life cycle has been attained.

2. Breakthrough Modeling for Cap Design

Performance, or useful life, of the cap was assessed based on the number of years before polycyclic aromatic hydrocarbon (PAH) concentrations at the top of the isolation layer approached the Background Threshold Values (BTVs) as discussed in the Design Report and defined in Appendix E. Automated numeric modeling allows for the assessment of performance of the cap in retarding the porewater flux of PAH, and the associated accumulation of PAH concentrations in the cap given varying cap thicknesses assuming a specific total organic carbon (TOC) content associated with the cap material. An analytical model developed at the University of Texas (Lampert and Reible 2009; Version 3.16) was used to estimate performance of the cap to be placed in the South Slip, with additional supporting direction in the selection of model inputs and assumptions from Guidance for In-Situ Subaqueous Capping of Contaminated Sediments (Palermo et al 1998). A technical reference summarizing the development and application of this model is provided as Exhibit C1-1.

The model used in this conceptual design process has the ability to consider the following processes: advection; diffusion; reactions (including biodegradation); sediment scour and deposition; and sediment mixing due to hydraulic forces and/or bioturbation. Note that for the purpose of this cap design exercise, deposition of new sediment on top of or within the interstitial spaces of the armor layer, which would result in additional transport length was conservatively neglected.

Additional conservative assumptions used in the assessment of porewater transport for the South Slip included:

- the chemical characterization of the sediments are represented by the highest reported PAH concentrations from South Slip sediment samples
- all solid-phase PAH constituents found in the sediment were assumed to be fully available (labile) for partitioning to porewater
- sediments in the South Slip were assumed to have an infinite supply of PAH mass and that there was no decline in the partitioning of PAHs from sediment to porewater and no degradation or decay of available PAH mass
- partitioning of PAHs was controlled by the presence of natural organic carbon and there was no “black carbon” or other geosorbent contributing to adsorption
- dissolved organic carbon concentration of 5 milligrams per liter (mg/l) was assumed based on typically expected values and conservative assumptions regarding characterization
- Groupings of PAH compounds rather than individual compounds were used (i.e., Low Molecular Weight PAH [LPAH], High Molecular Weight PAH [HPAH]), and assumptions regarding representative individual PAHs and associated partitioning coefficients were required

Sediment porewater concentrations used for modeling were based on historical porewater data as well as sediment data and partitioning theory. Given the large volumes of porewater required for PAH analysis, an extensive porewater data set was not generated for these compounds. Rather, the sediment data from recent investigations used to develop South Slip BTVs (see Appendix E) were also used to estimate underlying porewater concentrations using site-specific organic carbon measurements and literature-based partitioning coefficients.

3. Model Results

A 12-inch [30-centimeter (cm)] sand isolation layer underlying a 6-inch (15-cm) bioturbation/scour protection stone armor layer is assumed for the proposed sub-aqueous sediment cap. As such, the target concentrations in the breakthrough analysis are modeled at a point approximately 15 cm below the top of the armor layer (i.e., the top of isolation layer). Based on the iterative process of modifying the characteristics of the cap material and/or the isolation layer thickness and reviewing the resulting estimated chemical transport scenario, a TOC content of 2% by weight was determined to be most appropriate for the isolation layer.

For the South Slip, the point of assessment is the top of the 12-inch isolation layer. If, after migrating through the cap, the porewater concentration at the top of the isolation layer is approaching or exceeds the porewater PAH concentration associated with the BTVs, breakthrough is considered to have occurred. In this application, when breakthrough occurs at the top of the isolation layer, the cap is assumed to have reached its useful life cycle as that is the assumed elevation at which ecological receptors (e.g., bioturbating benthic invertebrates) may be in contact with sediments that exceed the BTV. This is a notably conservative assumption in this instance, as the isolation layer will be overlain by a 6-inch layer of armor stone.

As porewater concentrations, rather than explicit sediment concentrations, are used in the modeling performed for cap design, sediment analytical results were converted to porewater PAH concentrations using standard equilibrium equations as follows:

$$C_{pw\ total} = (C_{sed}/f_{oc})/K_{oc} + (C_{doc} * C_{pw} * K_{doc})$$

Where:

- C_{sed} – Concentration PAH in the sediment
- f_{oc} – Fraction organic carbon in sediment
- K_{oc} – Partitioning coefficient of organic carbon in sediment
- C_{doc} – Concentration dissolved organic carbon
- C_{pw} – Concentration PAH in porewater
- K_{doc} – partitioning coefficient of dissolved organic carbon in porewater

The remainder of this section presents the results of the cap performance modeling for both LPAHs and HPAHs. Note that for illustration purposes, this assessment has been performed assuming both the maximum recorded sediment PAH concentrations within the slip and the average PAH concentration observed associated with available sediment data.

3.1 Low Molecular Weight PAH Grouping

Naphthalene has the lowest organic carbon partitioning coefficient associated with LPAHs, a quality that results in naphthalene being the least likely of the LPAHs to be sorbed to the organic carbon found in sediment or cap material. As a result, naphthalene is considered the most mobile of the LPAHs and is anticipated to be the first to reach the top of the isolation layer in concentrations that may exceed the BTVs. Therefore, it was conservatively assumed that the entire LPAH mass found in the sediment consisted of naphthalene; thus artificially inflating the potential for constituent mobility. Based on published research, a log K_{oc} value of 3.11 and a log K_{doc} of 2.61 were used as reasonably conservative partitioning coefficients to calculate the expected porewater PAH concentration that represents the associated sediment BTV (Mackay et al. 1992).

The target porewater LPAH concentration for the breakthrough analysis was based on the computed equilibrium porewater concentration for LPAH associated with sediment BTVs. The BTV for sediment concentrations of LPAHs was estimated to be 38,700 micrograms per kilogram ($\mu\text{g}/\text{kg}$; $C_{\text{sed}} = 38,700 \mu\text{g}/\text{kg}$), with a TOC of 4.4% ($f_{\text{oc}} = 0.044$), as presented in Appendix E. Based on these inputs, a porewater LPAH concentration of 685 micrograms per liter ($\mu\text{g}/\text{l}$) was computed to represent the associated BTV.

Using the highest reported sediment LPAH concentration in the remedial area ($C_{\text{sed}} = 1,217,500 \mu\text{g}/\text{kg}$) and a corresponding TOC of 15.4% ($f_{\text{oc}} = 0.154$), the upper bound LPAH porewater concentration estimated for the South Slip is 6,150 $\mu\text{g}/\text{l}$. Using the average of the reported LPAH sediment concentrations ($C_{\text{sed}} = 328,000 \mu\text{g}/\text{kg}$) the average LPAH porewater concentration estimated for the South Slip is 1,660 $\mu\text{g}/\text{l}$. The porewater concentration associated with the BTV represents 11% ($685/6,150$) of the upper bound concentration and 41% ($685/1,660$) of the average porewater concentration. These are presented as target thresholds in the breakthrough modeling, and the useful life of the cap is therefore defined as the time period over which the cap will prevent porewater LPAH concentrations at the top of the isolation layer from reaching these threshold levels.

Given the relative high mobility of naphthalene, a Darcy groundwater velocity of 5 cm/year was selected for use in the model to represent expected conditions in the South Slip. Figure C1-1 below illustrates the upward movement of the LPAH contaminated front. For the upper and average concentrations, the target threshold for naphthalene is reached in approximately 112 and 188 years, respectively.

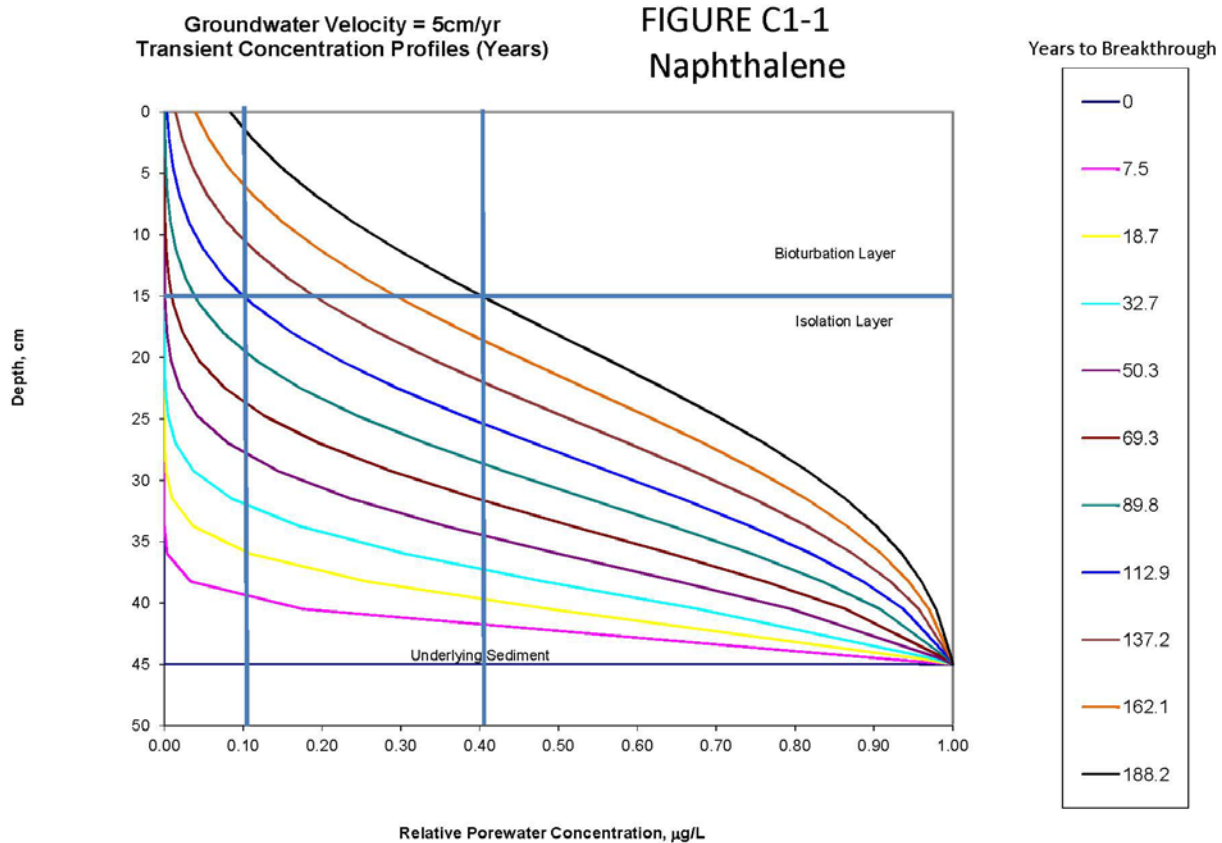

3.2 High Molecular Weight PAH Grouping

Similar to the discussion above, target porewater HPAH concentrations were based on the computed equilibrium porewater concentration for HPAH associated with sediment BTVs. The BTV for HPAHs was estimated to be 25,910 µg/kg with a TOC of 4.4% ($f_{oc} = 0.044$), as discussed in Appendix E. As a conservative measure, similar to the selection of Naphthalene discussed above, it was assumed that all of the HPAH consisted of pyrene, the most mobile member of the HPAH grouping.

A log K_{oc} value of 4.92 was used as a reasonably conservative partitioning coefficient for pyrene. Based on these assumptions, a porewater concentration of 7.36 µg/l was computed as representative of the sediment BTV associated with HPAHs. Using the highest reported HPAH concentration in the remedial area ($C_{sed} = 1,623,000$ µg/kg) and corresponding TOC of 15.4% ($f_{oc} = 0.154$), the estimated upper bound HPAH porewater concentration in the South Slip is 132 µg/l. Using the average of the reported HPAH sediment concentrations ($C_{sed} = 437,900$ µg/kg), the estimated average HPAH porewater concentration in the South Slip is 35.5 µg/l. These concentrations represent 5.6% (7.36/132) of the upper bound concentration and 21%

(7.36/35.5) of the average porewater concentration, and were used as target thresholds for the breakthrough modeling.

Given the lower mobility of pyrene, a Darcy groundwater velocity of 50 cm/year was conservatively selected for use to represent the effectiveness of the cap in controlling the migration of HPAHs. Figure C1-2 below illustrates the upward movement of the HPAH contaminated front. For the upper and average concentrations, the target threshold for pyrene is reached in approximately 920 and >1,000 years, respectively.

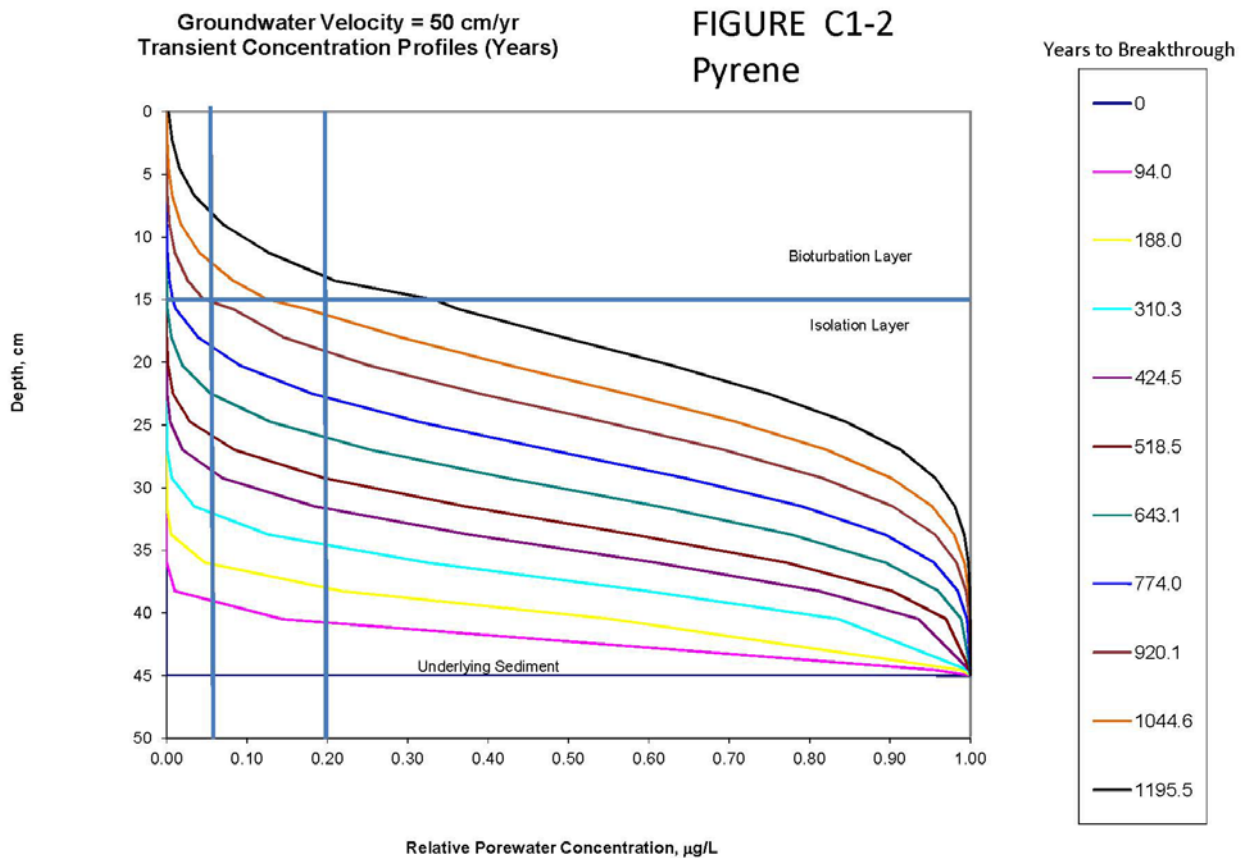

4. Conclusions

As detailed in the Design Report, the isolation layer component of the cap to be constructed in the South Slip will consist of 12 inches of clean sand with a minimum TOC of 2%. Using computational modeling, the performance of the selected isolation layer material in controlling the migration of sediment PAH concentrations has been assessed. As presented in this memorandum, when applying very conservative

assumptions and using relatively worst case inputs related to constituent mobility, the proposed cap prevents sediment PAH concentrations from approaching BTVs for a minimum of 100 years. As a result, the cap design is considered an effective means of achieving site remediation goals and provides protection to potential ecological receptors for a sufficiently long life cycle.

5. References

- Lampert, D. J. and Reible, D. 2009. An Analytical Modeling Approach for Evaluation of Capping of Contaminated Sediments, *Soil and Sediment Contamination: An International Journal*, 18:4,470 – 488.
- Mackay, D., Shiu, W.Y., and Ma, K.C. 1992. *Illustrated Handbook of Physical-Chemical Properties and Environmental Fate for Organic Chemicals - Volume II*. Lewis Publishers.
- Palermo, M.R., S. Maynard, J. Miller, and D. Reible. 1998. *Guidance for in-situ subaqueous capping of contaminated sediments*. Environmental Protection Agency, EPA 905-B96-004, Great Lakes.

TECHNICAL REFERENCE

MODELING FOR THE DESIGN OF ACTIVE LAYERS FOR CONTAMINATED SEDIMENT CAPS

An interactive Excel spreadsheet (TR-843b) was developed by Dr. Danny Reible, University of Texas at Austin, to model active capping of contaminated sediment. The following guide provides information on the use of the model for contaminated sediment cap design.

2870 Forbs Avenue, Hoffman Estates, IL 60192
714.384.0111 | 800.527.9948 | <http://remediation.cetco.com>



IMPORTANT: The information contained herein supersedes all previous printed versions, and is believed to be accurate and reliable. For the most up-to-date information, please visit www.CETCO.com. CETCO accepts no responsibility for the results obtained through application of this product. CETCO reserves the right to update information without notice.

TECHNICAL REFERENCE

MODEL OF 2 LAYER SEDIMENT CAP, DESCRIPTION AND PARAMETERS FOR ACTIVE CAP LAYER MODEL V 3.16

Danny D. Reible, Ph.D.

The University of Texas at Austin

reible@mail.utexas.edu / 512-471-4642

INTRODUCTION

This Excel spreadsheet model contains three worksheets:

- ▶ A two layer (bioturbation and chemical isolation layer) analytical model of steady state cap performance
- ▶ A one layer (chemical isolation layer) analytical model of transient cap performance
- ▶ A sensitivity analysis of the two layer steady state model

The steady state analytical model evaluates the long time behavior of a cap, after both the biologically active layer and the underlying cap layer are influenced by contaminant migration from below. It estimates the maximum concentration or flux that can ever be expected from a cap assuming that the underlying concentration is constant. The model implemented in the spreadsheet is a two layer steady state model which predicts concentrations and fluxes in a chemical isolation layer or in the near surface biologically active zone or bioturbation layer. The model is described in detail in Lampert and Reible¹. The transient model is designed to describe chemical migration in the chemical isolation layer of a cap only. The model is set up to stop calculations at a point in time when the concentration in the bioturbation layer begins to be significant (although the end time of the transient calculation can be overwritten, the user should do so with caution because the transient model does not account for the faster transport and degradation processes in the biologically active zone). The sensitivity analysis worksheet is designed to allow easy adjustment of model parameters to look at a large number of conditions quickly.

The active cap layer model v 3.16 employs information on an active or sorbing cap layer to determine an effective cap thickness which is the sum of the actual cap thickness and an additional thickness which is an equivalent of the sorbing active layer. The equivalent thickness of the sorbing layer is given by:

$$L_{\text{equiv}} = L_{\text{cap}} + L_{\text{active}} \sqrt{R_{\text{active}}/R_{\text{cap}}}$$

Where L_{active} is the actual thickness of the sorbing active layer and $R_{\text{active}}/R_{\text{cap}}$ is the ratio of the migration retardation factor in the sorbing active layer to that in the conventional cap material. This is an approximation which is most valid in diffusion/dispersion dominated systems. It allows the spreadsheet to be used to estimate the behavior of a cap containing an additional sorbing component but the user is cautioned that the results are only approximate. For full simulation of such cases, a numerical model such as CAPSIM 2 should be employed. The latter model is also available from Danny Reible at reible@mail.utexas.edu.

Model parameters and their definitions are shown below. Although the parameters are used to define both the steady state and transient model, note that many are not applicable in the transient model since it describes migration in only a single capping isolation layer (as modified by the effective thickness of an active cap layer). Parameters shown in the spreadsheet in blue are normal model inputs that the user is free to change as needed. Parameters shown in yellow are parameter estimates that employ the user supplied inputs and represent best estimates based upon the author's experience. These parameters can be changed but the reader is cautioned in doing so. Parameters shown in red are integral to the model and these values should not normally be changed.

CONTAMINANT PROPERTIES

- ▶ **Contaminant** – Identification of contaminant for easy reference
- ▶ **Octanol-water Partition Coefficient, $\log K_{ow}$** – Tabulated Kow values are used to estimate contaminant hydrophobicity and to calculate other parameters including organic carbon based partition coefficient and the dissolved organic carbon based partition coefficient.
- ▶ **Water Diffusivity, D_w** – diffusivity of the pure contaminant in water, cm^2/sec

¹ *Lampert, D.J. and Reible, D.D. 2008. "An Analytical Modeling Approach for Evaluation of Capping of Contaminated Sediments," Soil & Sediment Contamination, (under review)."

2870 Forbs Avenue, Hoffman Estates, IL 60192
714.384.0111 | 800.527.9948 | <http://remediation.cetco.com>



IMPORTANT: The information contained herein supersedes all previous printed versions, and is believed to be accurate and reliable. For the most up-to-date information, please visit www.CETCO.com. CETCO accepts no responsibility for the results obtained through application of this product. CETCO reserves the right to update information without notice.

TECHNICAL REFERENCE

- ▶ Cap Decay Rate (porewater basis), λ_1 - contaminant degradation rate in cap interstitial waters, yr^{-1}
- ▶ Bioturbation Layer Decay Rate (porewater basis), λ_2 - contaminant degradation rate in interstitial water of surficial biologically active layer in yr^{-1}

SEDIMENT/BIOTURBATION LAYER PROPERTIES

- ▶ Contaminant Pore Water Concentration, C_o - Interstitial concentration in the near surface layer of the underlying sediment, $\mu\text{g}/\text{L}$
- ▶ Biological Active Zone fraction organic carbon, $(f_{oc})_{bio}$ - Surficial layer organic carbon content (as a fraction of sediment dry weight), assumed to apply to both the underlying sediment before capping and the surficial cap layer at steady state (after deposition of new sediment)
- ▶ Colloidal Organic Carbon Concentration, ρ_{DOC} - dissolved organic carbon in sediment and cap interstitial waters, mg/L .
- ▶ Darcy Velocity, V - volume of upwelling water discharging into overlying water body per unit surface area per time, $\text{cm}^3/(\text{cm}^2 \cdot \text{yr})$. V is forced ≥ 0 , that is, losing bodies of water (downward velocity) are estimated conservatively as diffusion only.
- ▶ Depositional Velocity, V_{dep} - rate of deposition of new sediment in cm/yr . The deposition velocity is used to estimate an effective Darcy velocity using the sorption characteristics of the chemical isolation layer. Note that a large deposition velocity can give rise to an ever increasing cap thickness that will give large negative effective velocities. The calculated effective Darcy velocity is limited to avoid physically unrealistic solutions.
- ▶ Bioturbation Layer Thickness, h_{bio} - thickness, in cm , of the biologically active layer that will develop at the surface of the cap. Figure 1 shows the probability distribution for this parameter in freshwater (median=4.8 cm) and estuarine systems (median=7.9 cm).
- ▶ Pore Water Biodiffusion Coefficient, D_{bio}^{pw} - effective diffusion coefficient in biologically active layer based on interstitial water, cm^2/yr . There is very little guidance for this parameter although measurements have shown 10^{-3} - 10^{-5} cm^2/s as reasonable estimates. Since the parameter also characterizes organism behavior, using a multiple of the particle diffusion coefficient below (e.g. $100 \times D_{bio}^p$) might be a reasonable estimation method. Note that although the numerical value of this parameter may be larger than D_{bio}^p , particle biodiffusion is typically more important due to contaminant sorption on the particles.
- ▶ Particle Biodiffusion Coefficient, D_{bio}^p - effective particle diffusion coefficient in biological active layer, cm^2/yr . Figure 2 shows the probability distribution for this parameter in freshwater (median = 3.3×10^{-8} $\text{cm}^2/\text{sec} = 1.06$ cm^2/yr) and estuarine systems (median= 3×10^{-7} $\text{cm}^2/\text{sec} = 9.4$ cm^2/yr).

Figure 1. Distribution of measurements of h_{bio}
(adapted from Thoms et al., 1995)

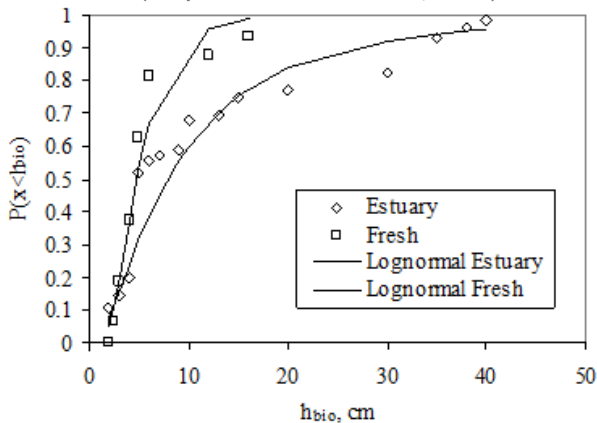
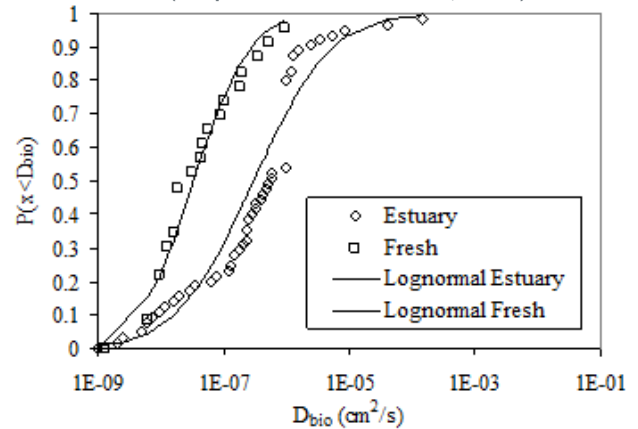

Figure 2. Distribution of measurements of D_{bio}
(adapted from Thoms et al., 1995)



CONVENTIONAL CAP PROPERTIES

- ▶ Depth of Specific Interest below cap-water interface, z - If performance (as indicated by porewater or bulk solid phase concentration) at a particular distance below the cap surface is desired, this depth can be entered here, in cm .
- ▶ Fraction organic carbon at depth of interest, $f_{oc}(z)$ - Fraction organic carbon at the depth of interest which is used to estimate the bulk solid phase concentration from the porewater concentration with the relationship $W = K_{oc} f_{oc} C_{pw}$
- ▶ Conventional Cap placed depth - The depth of placed sand or other conventional cap material, in cm . The effective depth will be less due to bioturbation or consolidation
- ▶ Cap Materials - If the cap is constructed of sand or similar material, a G (granular) should be entered here, whereas if it is constructed of silt or clay, C should be entered for a consolidated material. Two different models of estimating the effective diffusion coefficient are employed for these two types of materials.

TECHNICAL REFERENCE

- ▶ **Cap consolidation depth** - Depth that the cap consolidates (typically small for a sandy cap), in cm. This does not include the consolidation of the underlying sediment.
- ▶ **Underlying sediment consolidation due to cap placement** - Underlying sediment consolidation, in cm. This indicates the total volume of porewater expressed into the cap layer. The migration of a contaminant expressed with this porewater may be considerably less than the total consolidation due to sorption-related retardation in the cap material.
- ▶ **Porosity, ϵ** - Void fraction in conventional cap material
- ▶ **Particle Density, ρ_p** - Conventional cap grain density, in g/cm³
- ▶ **Fraction organic carbon, $(f_{oc})_{eff}$** - Fraction organic carbon in conventional cap material

ACTIVE LAYER PROPERTIES

- ▶ **Effective Active Layer Thickness** - thickness of the active layer (enhanced sorbent) in cm. This can range from 1 cm (a typical active layer in a mat) to a thicker layer placed in bulk.
- ▶ **Steady state ratio of effective diffusion in active layer relative to conventional layer** - Although the primary purpose of most commercially available active layers is to enhance sorption related retardation (a transient phenomena), it is also possible that an active layer may exhibit reduced transport rates under steady conditions. This would normally be a reduction in effective diffusion coefficient relative to the conventional sandy cap layers, for example, diffusivity in clay relative to that in sand. Since many active cap layers are also composed of granular media, this parameter should be assumed equal to one (transport in active layer equal to transport in sandy layer) without specific information to the contrary. This parameter should also normally be set equal to one in advection dominated systems.
- ▶ **Effective Partition Coefficient** - Effective partition coefficient in active layer in (mg/kg sorbed)/(mg/L in porewater).
- ▶ **Active adsorbent loading** - Mass of sorbent in active layer in kg/m² per cm of layer thickness.

CALCULATED LAYER PROPERTIES

- ▶ **Effective Sand Cap thickness, h_{sand}** - Calculated quantity of effective thickness of conventional cap, in cm considering placed thickness, consolidation of cap and underlying sediment
- ▶ **Steady State Equivalent Cap thickness, h_{cap}** - Calculated effective thickness of overall cap for steady state calculations including both sand cap and active cap layer, in cm.
- ▶ **Transient Equivalent cap thickness, h_{equiv}** - Calculated effective thickness of overall cap for transient calculations including both sand cap and active cap layer, in cm.
- ▶ **Effective cap partition coefficient** - Calculated effective cap partition coefficient in L/kg

COMMONLY USED PARAMETER ESTIMATES (CAN BE CHANGED)

- ▶ **Organic carbon based Partition Coefficient, $\log K_{oc}$** - This quantity is calculated from the formula $0.903\log K_{ow} + 0.094$ (Baker²). The K_{oc} is used to estimate the sediment-water partition coefficient through the formula $K_d = K_{oc} f_{oc}$ where f_{oc} is the fraction organic carbon of the layer of interest. Note that inorganic contaminants can be simulated by including an effective $\log K_d$ as the $\log K_{oc}$ entry and choosing $f_{oc} = 1$
- ▶ **Colloidal Organic Carbon Partition Coefficient, $\log K_{doc}$** - dissolved organic matter can increase the mobile fraction of contaminant. For PAHs, Burkard³ has suggested $\log K_{doc} = \log K_{ow} - 0.58$ where K_{ow} is the tabulated octanol-water partition coefficient
- ▶ **Boundary Layer Mass Transfer Coefficient, k_{bl}** - benthic boundary layer mass transfer coefficient, cm/yr. A typical value is 1 cm/hr. A useful model of this parameter is:

$$k_{bl} = \frac{v_w^{1/2} u_*^{1/2}}{Sc^{2/3} y_0^{1/2}}$$

Where v_w is the kinematic viscosity of water (~ 0.01 cm²/sec), u_* is the friction velocity characterizing the shear stress at the sediment-water interface (typically 1-5 cm/sec), y_0 is the hydrodynamic roughness of the sediment-water interface (typically 1-10 cm) and Sc is the Schmidt number, the ratio of kinematic viscosity of water to the molecular diffusion coefficient of the contaminant in water (of the order of 1000 for most contaminants in water).

² Baker, J.R., Mihelcic, J.R., Luehrs, D.C., and Hickey, J.P. 1997. "Evaluation of Estimation Methods for Organic Carbon Normalized Sorption Coefficients," Water Environment Federation, 69(2):136-145.

³ Burkard LP. 2000. Estimating dissolved organic carbon partition coefficients for nonionic organic chemicals. Environ Sci Technol 34:4663-4668.

⁴ Neuman, S.P. 1990. "Universal Scaling in Geologic Media," Water Resources Research, 26(8):1749-1758.

⁵ Millington, R.J., and Quirk, J.M. (1961) "Permeability of Porous Solids," Transactions of the Faraday Society, 57:1200-1207.

⁶ Boudreau, B. (1997) Diagenetic Models and Their Implementation: Modeling Transport Reactions in Aquatic Sediments. Springer-Verlag, New York.

TECHNICAL REFERENCE

- ▶ **Dispersivity, α** - Dispersion is characterized by αU where U is the Darcy velocity. α is the order of the length scale of heterogeneities in the cap. The Neuman⁴ groundwater model of $\alpha=1.69(h_{cap} \text{ (in m)})^{1.53}$ is employed except that α is not allowed to be less than 1 cm.
- ▶ **Diffusion coefficient, D_1** - Diffusivity in cap layer is modeled as per Millington and Quirk⁵ if granular (sand, gravel) or Boudreau⁶ if consolidated sediment.

$$\text{Millington and Quirk} \quad D_{diff} = \varepsilon_1^{4/3} D_w$$

$$\text{Boudreau} \quad D_{diff} = \frac{\varepsilon_1 D_w}{1 - 1n\varepsilon_1^2}$$

OUTPUT-STEADY STATE MODEL (CONTENTS OF THESE CELLS SHOULD NOT BE CHANGED)

- ▶ **Pore Water Concentration at Depth, $C(z)$** - Model calculated steady state porewater concentration in porewater at the specific depth of interest, in $\mu\text{g/L}$
- ▶ **Solid Concentration at Depth of Interest, $W(z)$** - Model calculated steady state bulk solid phase concentration in $\mu\text{g/kg}$
- ▶ **Average Bioturbation Layer Loading, $(W_{bio})_{avg}$** - Model calculated steady state average bulk solid phase concentration in the biologically active zone, in $\mu\text{g/kg}$
- ▶ **Flux to Overlying Water Column, J** - Model calculated steady state flux to overlying water, $\mu\text{g/m}^2\text{yr}$
- ▶ **Cap-Bioturbation Interface Concentration, C_{bio}/C_0** - Steady state porewater concentration at the cap bioturbation layer interface, in % of concentration in underlying sediment
- ▶ **Cap-Water Interface Concentration, C_{l}/C_0** - Steady state porewater concentration at the cap water interface, in % of concentration in underlying sediment
- ▶ **Average Bioturbation Concentration, $(C_{bio})_{avg}/C_0$** - Steady state average porewater concentration in the biologically active zone, in % of concentration in underlying sediment
- ▶ **Time to Containment Breakthrough, $t_{adv/diff}$** - Time before significant concentrations are expected in the biological active zone. Also the time after which the transient analytical model (2nd tab) may begin to overestimate concentrations in the biologically active zone. It indicates the approximate time before the concentration and flux at the top of the chemical isolation layer is 1% of what it is in the sediments.

$$t_{adv/diff} \approx \frac{1}{1/t_{diff} + 1/t_{adv}} \approx \frac{1}{16D_1 / (R_1 h_{eff}^2) + U / (R_1 h_{eff})} \approx \frac{R_1 h_{eff}^2}{16D_1 + U h_{eff}}$$

OUTPUT - TRANSIENT MODEL (TRANSIENT MODEL TAB)

The model inputs summarized above are used to calculate key parameters for the transient model in the chemical isolation layer, i.e. the conventional sand layer as modified by the effective thickness of the active cap layer. These parameters include Peclet number (relating advection to diffusion, Dahmkohler number (relating reaction to diffusion), and a parameter u which is affected by both diffusion and advection. The final parameter needed for the model is the simulation time. The time until significant concentrations are noted in the biologically active zone is $t_{adv/diff}$. This would normally be the simulation time although if the the bioturbation rate in the biologically active zone is small or the concentration in that zone as predicted by the model at $t_{adv/diff}$ is small, the simulation time can be extended to give estimates of concentration in the capping isolation layer over a longer period of time. This may be especially important with an active sorbing layer in that the concentrations in much of the capping isolation layer are very small and essentially uniform for long periods of time after some penetration of contaminants are noted in the biologically active layer. If a longer simulation time it can simply be entered in the identified cell. The output from the simulation is shown on a figure showing both transient curves at various times and the long-time steady state curve for comparison. The results are also shown as concentrations (as the ratio of concentration to underlying sediment concentration) as a function of depth (in cm) and time. Note that the output will provide increased resolution in the sorbing active cap layer as appropriate.

SENSITIVITY MODEL TAB

The final tab in the spreadsheet model is designed to conduct sensitivity analyses on the steady state model. The tab does not include capabilities for conducting sensitivity analyses on the transient model. On this tab, the model parameters can be varied as desired to evaluate the output variables, for example concentration at a specific point of interest or in the biologically active zone. Columns B and C should not be changed. Column B is tied to the parameter values on the steady state conditions tab while column C is tied to column B. Column C can be copied and the values pasted in any number of additional columns and then values of selected parameters changed in those columns to allow parameter values to be changed.



Attachment C-2

Assessment of Potential Scour
Associated with Propeller Wash

1. Introduction

Watercraft ranging from small to large bulk cargo carriers and tugs use the South Slip for navigational and commercial purposes. This attachment describes an assessment of the potential for watercraft within the South Slip to disturb and/or displace cap materials, including an estimation of propeller wash scour for a range of different vessel types that are currently known to use the slip. The result of this assessment is the selection of an appropriate erosion protection layer material and thickness intended to protect the underlying isolation layer from scour or resuspension/material loss.

Note that there are other potential sources of scour associated with dynamic hydraulic settings (e.g., wave action, flow velocities) that were also considered; however, as the South Slip is a relatively quiescent water body with minimal flow and limited potential for wave generation, the conservative measures associated with armoring for propeller wash will be more than protective for other potential forces that may affect the cap.

2. Propeller Wash Analysis

As propeller-driven watercraft engage their engines, the rotating propeller beneath the vessel imparts thrust against the water, which causes a jet of water and turbulence that may generate forces sufficient to move and displace materials on the sediment or cap surface. Critical parameters associated with determination of propeller wash forces include water depth, horse power, and the size of the propeller. The purpose of the propeller wash analysis described herein was to determine the appropriate cap design, with consideration for the variation in available water depth due to cap thickness, for which the propeller wash of various types of vessels using the South Slip would not have a significant erosional effect (i.e., scour) on the sediment cap.

The calculation inputs are based on available information regarding vessel operations. Based on the results of Pre-Design Investigation (PDI) activities, it was found that water velocity within the channel is zero (i.e., there are negligible currents other than those caused by propeller thrust). In addition, a conservative assumption was used in that all vessels are considered to either be accelerating or maneuvering from a stationary position. This yields maximum potential impact on bed scour, as vessels in motion, depending on the speed, impart reduced propeller wash forces when compared to a stationary vessel.

The empirical equations utilized provide a means to present a qualitative and conservative estimate of potential resuspension as a result of propeller wash and are widely accepted methods. The equations enable comparison of the relative impacts of different scenarios regarding boat operations, water depths, and material characteristics (i.e., grain size). As necessary, modifying the cap thickness (and resulting water depth) and/or the cap material characteristics and evaluating the resultant scour depth estimate can be an iterative process until an acceptable maximum scour depth for a reasonable cap design has been attained. Note that for the purposes of this evaluation, equations and input parameters have been maintained in the same units as presented in the original reference, and predicted scour results were later converted to a common set of units.

To determine the maximum depth of scour for each vessel class due to propeller wash, the jet velocity exiting the propeller and the resulting bottom velocity were first calculated. The jet velocity exiting the propeller, U_o (meters per second [m/s]), was determined from Equation 1 (Blaauw and Van de Kaa 1978):

$$U_o = C_2 \left(\frac{P_d}{D_p^2} \right)^{1/3} \quad (1)$$

Where: P_d = applied engine power/propeller in horsepower (HP);

D_p = propeller diameter (m); and

C_2 = 1.06 for ducted propellers; 1.34 for non-ducted propellers (or 7.68 and 9.72, respectively, when using the English equivalent of the equation). Note: the vessels in the South Slip are considered to have non-ducted propellers.

The maximum bottom velocity due to the propeller wash, V_{bp} (m/s), was determined by Equation 2 (Blaauw and Van de Kaa 1978).

$$V_{bp} = C_1 U_o \frac{D_p}{H_p} \quad (2)$$

where: C_1 = 0.30 for ducted propeller; 0.22 for non-ducted propeller; and

H_p = distance from propeller shaft to channel bottom (m).

Given the results of Equations 1 and 2, the maximum depth of scour, ϵ_{max} (millimeter [mm]), was calculated using Equation 3 (Hamill 1988):

$$\epsilon_{max} = 45.04 \Gamma^{-6.98} [\ln(t)]^\Gamma \quad (3)$$

where: Γ = experimental coefficient (no unit); and

t = duration of scour (seconds).

Γ can be determined from the following equation:

$$\Gamma = 4.1135 \left[\frac{C}{D_{50}} \right]^{0.742} \left[\frac{D_p}{D_{50}} \right]^{-0.522} F_o^{-0.682} \quad (4)$$

where: C = tip to bed clearance (mm);

D_{50} = median sediment grain size (mm);

D_p = propeller diameter (mm); and

F_o = Froude number (no unit).

C can be determined from the following equation:

$$C = d_{water} - \left(d_{shaft} + \frac{D_p}{2} \right) \quad (5)$$

where: d_{water} = depth of water (mm); and

d_{shaft} = depth of shaft (mm).

Finally, F_o can be determined from the following equation:

$$F_o = \frac{U_o}{\sqrt{gD_{50}(\gamma_s - \gamma_w)/\gamma_w}} \quad (6)$$

where: U_o = jet velocity (mm/s)

g = acceleration due to gravity (9810 millimeters per square second [mm/s^2]);

γ_s = specific weight of stone (2.65 grams per cubic centimeter [g/cm^3]); and

γ_w = specific weight of water (1 g/cm^3).

It should be noted that although the empirical methods used in this evaluation reflect current state of knowledge regarding navigational impacts on bed sediment within waterways, there is some uncertainty in the results. The equations used to represent the effects of propeller wash have been developed by others based on physical models, and as such the range of ratios between parameters used in developing the empirical relations present in the field can at times lie outside the range used in the physical model. The limitations of the models were considered to the extent practicable in this assessment.

3. Assumptions for the South Slip

3.1 Bathymetry and Water Depth

Bathymetric contours and water depth ranges are shown on Design Drawing 2 (Appendix B). The ordinary high water (OHW) and ordinary low water (OLW) elevations have not been determined for the South Slip; however, per the U.S. Army Corps of Engineers (USACE), the maximum pool elevation fluctuation is determined to be between elevation 577 and 579 above mean sea level (amsl; approximately 1.0-foot above and below its typical elevation of 577.9 feet amsl).

As illustrated on Design Drawing 2 (Appendix B), the typical water depth in the South Slip ranges from approximately 3 feet to 19 feet, with the majority of the South Slip sediment surface at or below 565 feet amsl (i.e., approximately 13 feet water depth), and the central portion of the South Slip is at or below 563 feet amsl (i.e., approximately 15 feet water depth). Taking into account a range of potential cap thicknesses, a typical post-construction water depth was calculated to be used in the modeling. For example, for a proposed cap thickness of 1.5 feet, this results in a typical post-construction water depth of approximately 11.5 and 13.5 feet in the majority of the South Slip and the central portion of the South Slip, respectively. To be conservative in the calculations, and to account for possible over-placement by the Contractor of up to +20% of the total volume required for the sediment cap, a minimum water depth of 11 feet was used in the propeller wash analysis discussed herein.

3.2 Vessels Using the Slip

Information on watercraft using the South Slip was gathered to determine what size vessels would be anticipated to represent future use conditions. Information on size and expected usage of vessels was received from John Kindra of Kindra Towing (<http://www.kindralake.com/index.htm>) and is based on the specifications of the vessels that currently use the South Slip. At present the South Slip is being used for temporary mooring of barges, and vessel traffic within the slip is limited for maneuvering such barges. Note that it has been assumed that this will also be the future use of the slip, as institutional controls will be implemented to provide long-term mechanisms to protect the constructed cap, as discussed in the South Slip Sediment Cap Design Report. These institutional controls will include use restrictions regarding submerged structure postings, as well as restrictions on anchoring, dredging, development, and other activities that have the potential to disturb the sediment cap.

Table C2-1, below, represents a summary of the vessels currently used in the South Slip, as well as the key dimensions and inputs used for the potential propeller wash scour associated with each vessel. Consistent with discussions with Kindra Towing, this assessment has assumed that 25% of the engine capacity typically associated with each vessel would be used while in the South Slip (i.e., 25% applied power). This assumption was used to determine the jet velocity exiting the propeller (Equation 1).

Table C2-1 – Summary of Vessels Currently Used in the South Slip and Key Characteristics

Watercraft	Horsepower/ Propeller (HP)	Applied Horsepower (HP)	Propeller Diameter (feet)	Propeller Shaft Depth (feet)
Old Mission	1,500	375	6.3	5
Tanner	400	100	5.2	4
Morgan	1,200	300	7.0	5

3.3 Duration of Scour

The duration of scour is the measure of how long a vessel remains in one area, exerting thrust upon the same area of sediment. It would be difficult to estimate the maximum duration of scour values for vessels within the South Slip, as the time at which a vessel is not moving depends on the activity it is performing. Based on discussions with John Kindra, it was assumed that the larger working watercraft typically observed in the slip would remain in one location for time duration of between 15 and 90 seconds.

3.4 Grain Size

A primary variable in Equation 3 is the grain size (D_{50}) of the erosion protection layer. In this instance, it was determined a D_{50} of 2 inches was a reasonable stone size for placement in the slip above the isolation layer. This initial selection of armor stone size allows for the estimate of the depth of scour associated with propeller wash, and as discussed earlier, the stone size selection can be modified through an iterative process until an acceptable maximum scour depth for a reasonable stone size has been attained.

4. Results of Propeller Wash Calculations

It was initially assumed that an armor layer material with a D_{50} of 2 inches would be appropriate to protect the isolation layer from scour associated with propeller wash from the vessels currently using the South Slip.

The series of equations outlined above was used to estimate total scour potential based on the following assumptions:

- the typical operating water depth for the majority of the South Slip is at least approximately 11 feet
- boats operating in the slip are not anticipated to be operating for periods longer than 90 seconds
- boats operating in the slip are anticipated to be similar in characterization as the range of vessels described in Table C2-1
- armor stone with a D_{50} of 2 inches

The figure below illustrates the relationship between these inputs and the resulting maximum estimated scour depth, as calculated using the equations above.

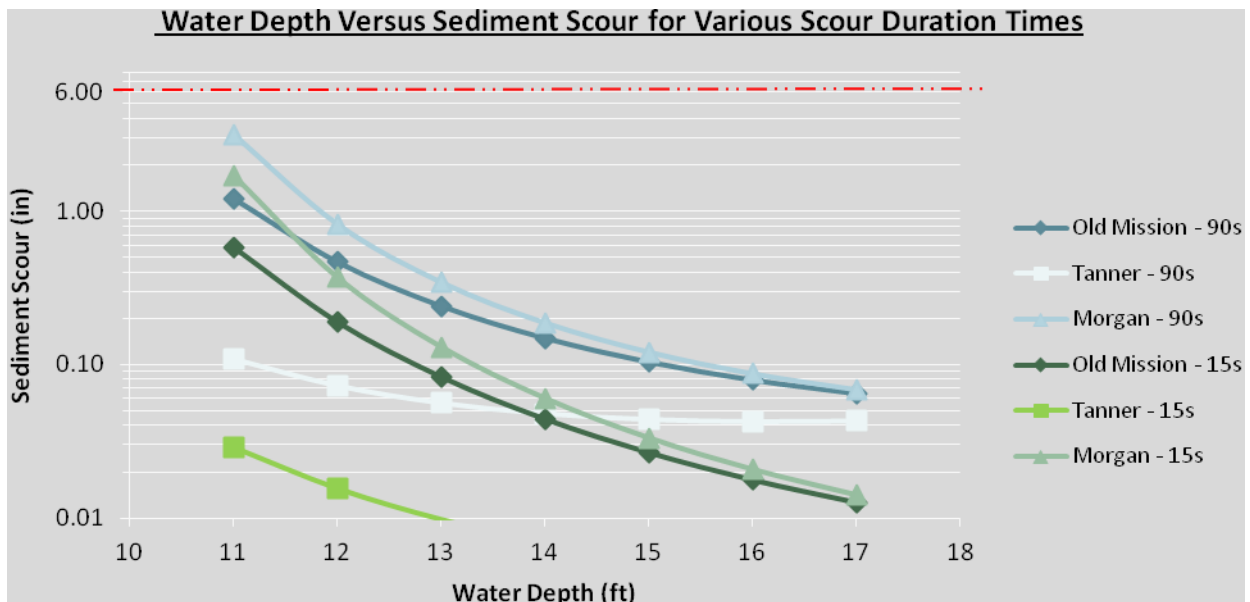

As can be seen, the maximum scour extent for the selected armor stone size of 2 inches D_{50} is approximately 3 inches with operation of the vessel Morgan for 90 seconds in 11 feet of water depth. The Morgan is one of the larger vessels anticipated to operate within the South Slip post-construction, and the scour associated with the other vessels anticipated to operate in the South Slip ranges from 0.1 inches to just under 2 inches for 90 seconds of operation in 11 feet of water depth. As illustrated, for the deeper water depths available in the central portion of the South Slip, the maximum scour extent given the most conservative vessel and operation duration is less than 0.3 inches. Additionally, as discussed in the South Slip Sediment Cap Design Report, the shallow western area of the South Slip (i.e., where water depths are less than 11 feet) will be physically isolated using a steel cable or chain and appropriate marine and land-based signage and markers to prevent vessel access.

There are no anticipated vessels currently operating in the slip that will cause a greater amount of scour under the same conditions. As a result, a 3-inch layer of 2-inch armor stone would be sufficient to protect the underlying isolation layer; however, to provide a conservative factor of safety, and in consideration of constructability considerations, a 6-inch layer of 2-inch armor stone has been selected for the erosion protection layer in the South Slip.

In the event that scour does occur, it is anticipated that the armor layer will generally be self healing in nature. Although up to 3 inches of scour may occur in isolated locations within the protective stone layer, the scoured material will likely remain within the remedial footprint either temporarily suspended in the water column or temporarily relocated to an adjacent area of the floor of the South Slip. In time, the suspended or relocated armor material is expected to settle back into any low-lying (i.e., scoured) areas, thus self-healing the protective layer of the sediment cap. In addition, any natural deposition that may occur in the slip will also contribute to the self-healing nature of the sediment cap, and will result in the stone material silting in over time.

5. References

Blaauw, H. G., and van de Kaa, E. J. 1978. Erosion of Bottom and Banks Caused by the Screw Race of Maneuvering Ships, Publication No. 202, Delft Hydraulics Laboratory, Delft, The Netherlands, presented at the Seventh International Harbor Congress, Antwerp, May 22-26.

Hamill, G.A. 1988. The Scouring action of the propeller jet produced by a slowly maneuvering ship. Bull. No. 62, Permanent International Association of Navigation Congress, 85-110.



Appendix D

Sediment Consolidation, Slope
Stability, and Sediment Bearing
Capacity Evaluations

Calculation Sheet

Client: Navistar, Inc.

Project: CI000664.0037.00001

Prepared by: GRM

Date: 05/10/12

Title: South Slip Sediment Cap Design, Former Wisconsin Steel Works

Reviewed By: APC

Date: 05/11/12

Subject: Consolidation of Sediments within the South Slip

OBJECTIVE: Determine the magnitude of consolidation and differential consolidation at critical sections within the South Slip for the newly proposed cap design.

REFERENCES:

1. Das, Braja M. *Principles of Foundation Engineering: Fifth Edition*. Brooks/Cole. Pacific Grove, CA. 2004.
2. Das, Braja M. *Principles of Geotechnical Engineering: Sixth Edition*. Thompson. Toronto, Canada. 2006.

ASSUMPTIONS:

1. Consolidation is assumed to occur in the soft, unconsolidated sediments only.
2. Consolidation is initiated by placing a 1.0' thick sand and 0.5' 2" D50 aggregate cap on top of the existing sediments within the South Slip. An additional 3.0' of sand was assumed to be placed as fill in some areas.
3. Porewater pressure diffuses through the upper sediment surface. Consolidation parameters determined by geotechnical testing indicate that consolidation will occur slowly over many years. To gain perspective on the maximum consolidation potential of the sediments within the slip, 2-way drainage is assumed.
4. Maximum consolidation and differential consolidation are examined in five sections throughout the slip. Consolidation potential is analyzed at three locations each in Section A-A, Section B-B, Section C-C, and Section 2. Consolidation potential is analyzed at two locations within Section 1. Bathymetric data were used to generate these sections, which can be viewed in the attached Figure D1-1 and section figures. Soft sediment thickness is interpolated between sediment probing and geotechnical boring data gathered during the March 2011 site investigation.
5. All sediments and cap materials in the consolidation analyses are submerged.
6. The soft sediments encountered at the slip are primarily elastic silt (MH). The soil

Calculation Sheet

parameters for the soft sediment were estimated based on the lab testing performed on the geotechnical samples collected.

7. The coefficient of consolidation of the soft sediments is estimated based on Figure 1.23 in Reference 1 (attached).
8. Sediment parameters used in this evaluation are provided in the table below:

Parameter	Symbol	Value / Range	Unit	Comments
Initial void ratio	e_0	2.663	--	From boring CL-2
Saturated unit weight of soft sediment	γ_{sat}	91.2	pcf	Average across site
Compression Index	C_c	0.58	--	From boring CL-2
Recompression Index	C_r	0.04	--	From boring CL-2
Submerged unit weight of sand	γ_{sand}	62	pcf	Typ. clean sand
Submerged unit weight of 2" D50 aggregate	γ_{sand}	72.6	pcf	Coarse aggregate
Percent consolidation considered primary	U	95	%	
Pre-consolidation pressure	σ'_c	1260	psf	From boring CL-2
Coefficient of consolidation	c_v	37.4	ft ² /yr	From Reference 1

CALCULATIONS:

Terzaghi's one-dimensional consolidation equation was used to determine the primary consolidation, secondary compression, and time-rate of consolidation. The equations used in the analysis can be found in Reference 2 and are provided below.

Primary Consolidation:

$$S_c = \Sigma \frac{C_r}{1+e_0} H \log\left(\frac{\sigma'_c}{\sigma'_o}\right) + \frac{C_c}{1+e_0} \log\left(\frac{\sigma'_o + \Delta\sigma'}{\sigma'_c}\right)$$

H = Layer Thickness

σ'_o = Effective overburden pressure

$\Delta\sigma'$ = Change in effective pressure

Calculation Sheet

Secondary Compression:

$$S_s = C_\alpha ' H \log \left(\frac{t_2}{t_1} \right)$$

$t_1, t_2 =$ time

Time-Rate of Consolidation:

$$T_v = \frac{c_v t}{H_{dr}^2}$$

H_{dr} = length of drainage path

t = time at which the time factor (T_v) is calculated

SUMMARY OF RESULTS:

Consolidation analyses were performed for the above-referenced cross-sections, which were selected from Sections A-A through D-D, Section 1, and Section 2 to represent the most critical range of sediment thicknesses (greatest thickness, and greatest variation of thicknesses) encountered in the South Slip. Detailed calculations for time-rate of consolidation and consolidation analyses are attached.

The time required to reach 95% consolidation was calculated for both 1-way and 2-way drainage. Because the period required to reach 95% consolidation for 1-way drainage was between 10 and 20 years, it was determined that 2-way drainage should be used for analysis purposes. Using 2-way drainage provides a “consolidation potential” or anticipated “worst case” degree of consolidation for the slip, though it is less representative of the anticipated rate of consolidation at the site.

The table below provides a summary of the consolidation calculated at each location. The maximum consolidation occurs at Station 0+13 of Section 1, and has a magnitude of approximately 2.05”. The maximum differential consolidation occurs between Stations 0+16 and 0+31 of Section 2, and has a magnitude of approximately 0.66”.

Calculation Sheet

	Station	Thickness of Cap (feet)	Thickness of Organic Silt (feet)	Pressure of Cap (psf)	Primary Consolidation/Rebound (inches)	Total Consolidation at 50 years (inches)	Maximum Differential Settlement
Section A-A'	0+30	1.5	11	98.3	0.37	1.03	0.29
	1+35	1.5	17	98.3	0.44	1.32	
	2+17	1.5	22	98.3	0.49	1.44	
Section B-B'	0+11	1.5	26	98.3	0.52	1.86	0.57
	0+19	3.5	21.5	222.3	0.86	1.79	
	0+30	1.5	20	98.3	0.47	1.22	
Section C-C'	0+06	1.5	25	98.3	0.51	1.8	0.42
	0+14	4.5	18	284.3	0.93	1.86	
	0+23	1.5	19	98.3	0.46	1.44	
Section 1	0+13	5.5	19	346.3	1.07	2.05	0.67
	0+27	1.5	18	98.3	0.45	1.38	
Section 2	0+08	1.5	26	98.3	0.52	1.86	0.66
	0+16	7.5	16.5	470.3	1.18	2.04	
	0+31	1.5	18	98.3	0.45	1.38	

The maximum consolidation and differential consolidation calculated for the South Slip are not anticipated to damage the placed cap or the structures adjacent to the slip. Down drag forces are also not thought to be of concern for consolidation of the calculated magnitude.

For detailed consolidation calculations and data, see attached sheets.

Time Rate of Consolidation

1-Way Drainage (not examined beyond calculating duration... 2-way more conservative)

Section	Station	Degree of Consolidation U (%)	Time Factor T_v	Length of Drainage Path H_{DR} (ft)	Coefficient of Consolidation c_v (ft ² /yr)	Time t (yrs)	Time t (days)
B-B'	0+11	95	1.129	26	37.4	20.4262	7455.6
B-B'	0+19	95	1.129	21.5	37.4	13.9675	5098.1
B-B'	0+30	95	1.129	20	37.4	12.0865	4411.6

2-Way Drainage (provides consolidation potential, or "worst case" for the site)

Section	Station	Degree of Consolidation U (%)	Time Factor T_v	Length of Drainage Path H_{DR} (ft)	Coefficient of Consolidation c_v (ft ² /yr)	Time t (yrs)	Time t (days)
A-A'	0+30	95	1.129	6.5	37.4	1.2766	466.0
A-A'	1+35	95	1.129	8.5	37.4	2.1831	796.8
A-A'	2+17	95	1.129	11	37.4	3.6562	1334.5
B-B'	0+11	95	1.129	13	37.4	5.1065	1863.9
B-B'	0+19	95	1.129	10.75	37.4	3.4919	1274.5
B-B'	0+30	95	1.129	10	37.4	3.0216	1102.9
C-C'	0+06	95	1.129	12.5	37.4	4.7213	1723.3
C-C'	0+14	95	1.129	9	37.4	2.4475	893.3
C-C'	0+23	95	1.129	9.5	37.4	2.7270	995.4
Section 1	0+13	95	1.129	9.5	37.4	2.7270	995.4
Section 1	0+27	95	1.129	9	37.4	2.4475	893.3
Section 2	0+08	95	1.129	13	37.4	5.1065	1863.9
Section 2	0+16	95	1.129	8.25	37.4	2.0566	750.7
Section 2	0+31	95	1.129	9	37.4	2.4475	893.3

Section A-A' at Station 0+30

Cap Load, $q_0 = 98.3$ psf
 Time (yrs) = 50
 Depth to Water Table = 0 ft
 Total Primary Consolidation = 0.37 in
 Total Consolidation @ Time = 1.03 in

New Cap	Thickness (ft)	q_{sat} (pcf)	γ_{subr} (psf)
Sand	1.0	125	62
2" d50 Gravel	0.5	135	72.6
Total weight Cap		98.3 psf	
Pressure removed		0.0 psf	

Depth (ft)	Soil Type	q_s (pcf)	Vertical Effective Stress (psf)	Stress Increase, D_p (psf)	Preconsolidation Stress (psf)	Void Ratio e_0	Compression Index C_c	Recompression Index C_r	Secondary Compression Index C_a	Time Required to 95% Condolidation t_p (years)	Time t (years)	Primary Consolidation (in)	Secondary Compression (in)	Total Primary Consolidation Settlement (in)	Total Secondary Compression (30 years) (in)	Total Settlement @ Time (years)
Dredged Surface																
0.0		91.2	0.0	98.30	0	2.66	0.58	0.04	0.0116	1.277	50	0.000	0.0000	0.0000	0.0000	0.00
1.0		91.2	28.8	98.30	29	2.66	0.58	0.04	0.0116	1.277	50	0.084	0.0605	0.0845	0.0605	0.15
2.0		91.2	57.6	98.30	58	2.66	0.58	0.04	0.0116	1.277	50	0.057	0.0605	0.1412	0.1211	0.26
3.0		91.2	86.4	98.30	86	2.66	0.58	0.04	0.0116	1.277	50	0.043	0.0605	0.1844	0.1816	0.37
4.0		91.2	115.2	98.30	115	2.66	0.58	0.04	0.0116	1.277	50	0.035	0.0605	0.2195	0.2421	0.46
5.0	Elastic Silt	91.2	144.0	98.30	144	2.66	0.58	0.04	0.0116	1.277	50	0.030	0.0605	0.2491	0.3027	0.55
6.0	Elastic Silt	91.2	172.8	98.30	173	2.66	0.58	0.04	0.0116	1.277	50	0.026	0.0605	0.2747	0.3632	0.64
7.0	Elastic Silt	91.2	201.6	98.30	202	2.66	0.58	0.04	0.0116	1.277	50	0.023	0.0605	0.2973	0.4237	0.72
8.0	Elastic Silt	91.2	230.4	98.30	230	2.66	0.58	0.04	0.0116	1.277	50	0.020	0.0605	0.3176	0.4843	0.80
9.0	Elastic Silt	91.2	259.2	98.30	259	2.66	0.58	0.04	0.0116	1.277	50	0.018	0.0605	0.3359	0.5448	0.88
10.0	Elastic Silt	91.2	288.0	98.30	288	2.66	0.58	0.04	0.0116	1.277	50	0.017	0.0605	0.3526	0.6053	0.96
11.0	Elastic Silt	91.2	316.8	98.30	317	2.66	0.58	0.04	0.0116	1.277	50	0.015	0.0605	0.3680	0.6659	1.03

Section A-A' at Station 1+35

Cap Load, $q_0 = 98.3$ psf
 Time (yrs) = 50
 Depth to Water Table = 0 ft
 Total Primary Consolidation = 0.44 in
 Total Consolidation @ Time = 1.32 in

New Cap	Thickness (ft)	g_{net} (pcf)	Y_{subr} (psf)
Sand	1.0	125	62
2" d50 Gravel	0.5	135	72.6
Total weight Cap		98.3 psf	
Pressure removed		0.0 psf	

Depth (ft)	Soil Type	g_s (pcf)	Vertical Effective Stress (psf)	Stress Increase, D_p (psf)	Preconsolidation Stress (psf)	Void Ratio e_0	Compression Index C_c	Recompression Index C_r	Secondary Compression Index C_a	Time Required to 95% Condolidation t_p (years)	Time t (years)	Primary Consolidation (in)	Secondary Compression (in)	Total Primary Consolidation Settlement (in)	Total Secondary Compression (30 years) (in)	Total Settlement @ Time (years)
Dredged Surface																
0.0		91.2	0.0	98.30	0	2.66	0.58	0.04	0.0116	2.183	50	0.000	0.0000	0.0000	0.0000	0.00
1.0		91.2	28.8	98.30	29	2.66	0.58	0.04	0.0116	2.183	50	0.084	0.0517	0.0845	0.0517	0.14
2.0		91.2	57.6	98.30	58	2.66	0.58	0.04	0.0116	2.183	50	0.057	0.0517	0.1412	0.1034	0.24
3.0		91.2	86.4	98.30	86	2.66	0.58	0.04	0.0116	2.183	50	0.043	0.0517	0.1844	0.1550	0.34
4.0		91.2	115.2	98.30	115	2.66	0.58	0.04	0.0116	2.183	50	0.035	0.0517	0.2195	0.2067	0.43
5.0		91.2	144.0	98.30	144	2.66	0.58	0.04	0.0116	2.183	50	0.030	0.0517	0.2491	0.2584	0.51
6.0		91.2	172.8	98.30	173	2.66	0.58	0.04	0.0116	2.183	50	0.026	0.0517	0.2747	0.3101	0.58
7.0		91.2	201.6	98.30	202	2.66	0.58	0.04	0.0116	2.183	50	0.023	0.0517	0.2973	0.3617	0.66
8.0	Elastic Silt	91.2	230.4	98.30	230	2.66	0.58	0.04	0.0116	2.183	50	0.020	0.0517	0.3176	0.4134	0.73
9.0	Elastic Silt	91.2	259.2	98.30	259	2.66	0.58	0.04	0.0116	2.183	50	0.018	0.0517	0.3359	0.4651	0.80
10.0	Elastic Silt	91.2	288.0	98.30	288	2.66	0.58	0.04	0.0116	2.183	50	0.017	0.0517	0.3526	0.5168	0.87
11.0	Elastic Silt	91.2	316.8	98.30	317	2.66	0.58	0.04	0.0116	2.183	50	0.015	0.0517	0.3680	0.5685	0.94
12.0	Elastic Silt	91.2	345.6	98.30	346	2.66	0.58	0.04	0.0116	2.183	50	0.014	0.0517	0.3822	0.6201	1.00
13.0	Elastic Silt	91.2	374.4	98.30	374	2.66	0.58	0.04	0.0116	2.183	50	0.013	0.0517	0.3955	0.6718	1.07
14.0	Elastic Silt	91.2	403.2	98.30	403	2.66	0.58	0.04	0.0116	2.183	50	0.012	0.0517	0.4079	0.7235	1.13
15.0	Elastic Silt	91.2	432.0	98.30	432	2.66	0.58	0.04	0.0116	2.183	50	0.012	0.0517	0.4196	0.7752	1.19
16.0	Elastic Silt	91.2	460.8	98.30	461	2.66	0.58	0.04	0.0116	2.183	50	0.011	0.0517	0.4306	0.8269	1.26
17.0	Elastic Silt	91.2	489.6	98.30	490	2.66	0.58	0.04	0.0116	2.183	50	0.010	0.0517	0.4410	0.8785	1.32

Section A-A' at Station 2+17

Cap Load, $q_0 = 98.3$ psf
 Time (yrs) = 50
 Depth to Water Table = 0 ft
 Total Primary Consolidation = 0.49 in
 Total Consolidation @ Time = 1.44 in

New Cap	Thickness (ft)	g_{net} (pcf)	Y_{subr} (psf)
Sand	1.0	125	62
2" d50 Gravel	0.5	135	72.6
Total weight Cap		98.3 psf	
Pressure removed		0.0 psf	

Depth (ft)	Soil Type	g_s (pcf)	Vertical Effective Stress (psf)	Stress Increase, D_p (psf)	Preconsolidation Stress (psf)	Void Ratio e_o	Compression Index C_c	Recompression Index C_r	Secondary Compression Index C_a	Time Required to 95% Condolidation t_p (years)	Time t (years)	Primary Consolidation (in)	Secondary Compression (in)	Total Primary Consolidation Settlement (in)	Total Secondary Compression (30 years) (in)	Total Settlement @ Time (years)
Dredged Surface																
0.0		91.2	0.0	98.30	0	2.66	0.58	0.04	0.0116	3.656	50	0.000	0.0000	0.0000	0.0000	0.00
1.0		91.2	28.8	98.30	29	2.66	0.58	0.04	0.0116	3.656	50	0.084	0.0432	0.0845	0.0432	0.13
2.0		91.2	57.6	98.30	58	2.66	0.58	0.04	0.0116	3.656	50	0.057	0.0432	0.1412	0.0863	0.23
3.0		91.2	86.4	98.30	86	2.66	0.58	0.04	0.0116	3.656	50	0.043	0.0432	0.1844	0.1295	0.31
4.0		91.2	115.2	98.30	115	2.66	0.58	0.04	0.0116	3.656	50	0.035	0.0432	0.2195	0.1727	0.39
5.0		91.2	144.0	98.30	144	2.66	0.58	0.04	0.0116	3.656	50	0.030	0.0432	0.2491	0.2158	0.46
6.0		91.2	172.8	98.30	173	2.66	0.58	0.04	0.0116	3.656	50	0.026	0.0432	0.2747	0.2590	0.53
7.0		91.2	201.6	98.30	202	2.66	0.58	0.04	0.0116	3.656	50	0.023	0.0432	0.2973	0.3022	0.60
8.0		91.2	230.4	98.30	230	2.66	0.58	0.04	0.0116	3.656	50	0.020	0.0432	0.3176	0.3453	0.66
9.0		91.2	259.2	98.30	259	2.66	0.58	0.04	0.0116	3.656	50	0.018	0.0432	0.3359	0.3885	0.72
10.0		91.2	288.0	98.30	288	2.66	0.58	0.04	0.0116	3.656	50	0.017	0.0432	0.3526	0.4317	0.78
11.0	Elastic Silt	91.2	316.8	98.30	317	2.66	0.58	0.04	0.0116	3.656	50	0.015	0.0432	0.3680	0.4748	0.84
12.0		91.2	345.6	98.30	346	2.66	0.58	0.04	0.0116	3.656	50	0.014	0.0432	0.3822	0.5180	0.90
13.0		91.2	374.4	98.30	374	2.66	0.58	0.04	0.0116	3.656	50	0.013	0.0432	0.3955	0.5612	0.96
14.0		91.2	403.2	98.30	403	2.66	0.58	0.04	0.0116	3.656	50	0.012	0.0432	0.4079	0.6043	1.01
15.0		91.2	432.0	98.30	432	2.66	0.58	0.04	0.0116	3.656	50	0.012	0.0432	0.4196	0.6475	1.07
16.0		91.2	460.8	98.30	461	2.66	0.58	0.04	0.0116	3.656	50	0.011	0.0432	0.4306	0.6907	1.12
17.0		91.2	489.6	98.30	490	2.66	0.58	0.04	0.0116	3.656	50	0.010	0.0432	0.4410	0.7338	1.17
18.0		91.2	518.4	98.30	518	2.66	0.58	0.04	0.0116	3.656	50	0.010	0.0432	0.4509	0.7770	1.23
19.0		91.2	547.2	98.30	547	2.66	0.58	0.04	0.0116	3.656	50	0.009	0.0432	0.4603	0.8202	1.28
20.0		91.2	576.0	98.30	576	2.66	0.58	0.04	0.0116	3.656	50	0.009	0.0432	0.4692	0.8634	1.33
21.0		91.2	604.8	98.30	605	2.66	0.58	0.04	0.0116	3.656	50	0.009	0.0432	0.4778	0.9065	1.38
22.0		91.2	633.6	98.30	634	2.66	0.58	0.04	0.0116	3.656	50	0.008	0.0432	0.4860	0.9497	1.44

Section B-B' at Station 0+11

Cap Load, $q_0 = 98.3$ psf
 Time (yrs) = 50
 Depth to Water Table = 0 ft
 Total Primary Consolidation = 0.52 in
 Total Consolidation @ Time = 1.86 in

New Cap	Thickness (ft)	g_{sat} (pcf)	Y_{subr} (psf)
Sand	1.0	125	62
2" d50 Gravel	0.5	135	72.6
Total weight Cap		98.3 psf	
Pressure removed		0.0 psf	

Depth (ft)	Soil Type	g_s (pcf)	Vertical Effective Stress (psf)	Stress Increase, D_p (psf)	Preconsolidation Stress (psf)	Void Ratio e_0	Compression Index C_c	Recompression Index C_r	Secondary Compression Index C_a	Time Required to 95% Condolidation t_p (years)	Time t (years)	Primary Consolidation (in)	Secondary Compression (in)	Total Primary Consolidation Settlement (in)	Total Secondary Compression (30 years) (in)	Total Settlement @ Time (years)
Dredged Surface																
0.0		91.2	0.0	98.30	0	2.66	0.58	0.04	0.0116	2.183	50	0.000	0.0000	0.0000	0.0000	0.00
1.0		91.2	28.8	98.30	29	2.66	0.58	0.04	0.0116	2.183	50	0.084	0.0517	0.0845	0.0517	0.14
2.0		91.2	57.6	98.30	58	2.66	0.58	0.04	0.0116	2.183	50	0.057	0.0517	0.1412	0.1034	0.24
3.0		91.2	86.4	98.30	86	2.66	0.58	0.04	0.0116	2.183	50	0.043	0.0517	0.1844	0.1550	0.34
4.0		91.2	115.2	98.30	115	2.66	0.58	0.04	0.0116	2.183	50	0.035	0.0517	0.2195	0.2067	0.43
5.0		91.2	144.0	98.30	144	2.66	0.58	0.04	0.0116	2.183	50	0.030	0.0517	0.2491	0.2584	0.51
6.0		91.2	172.8	98.30	173	2.66	0.58	0.04	0.0116	2.183	50	0.026	0.0517	0.2747	0.3101	0.58
7.0		91.2	201.6	98.30	202	2.66	0.58	0.04	0.0116	2.183	50	0.023	0.0517	0.2973	0.3617	0.66
8.0		91.2	230.4	98.30	230	2.66	0.58	0.04	0.0116	2.183	50	0.020	0.0517	0.3176	0.4134	0.73
9.0		91.2	259.2	98.30	259	2.66	0.58	0.04	0.0116	2.183	50	0.018	0.0517	0.3359	0.4651	0.80
10.0		91.2	288.0	98.30	288	2.66	0.58	0.04	0.0116	2.183	50	0.017	0.0517	0.3526	0.5168	0.87
11.0		91.2	316.8	98.30	317	2.66	0.58	0.04	0.0116	2.183	50	0.015	0.0517	0.3680	0.5685	0.94
12.0	Elastic Silt	91.2	345.6	98.30	346	2.66	0.58	0.04	0.0116	2.183	50	0.014	0.0517	0.3822	0.6201	1.00
13.0	Elastic Silt	91.2	374.4	98.30	374	2.66	0.58	0.04	0.0116	2.183	50	0.013	0.0517	0.3955	0.6718	1.07
14.0	Elastic Silt	91.2	403.2	98.30	403	2.66	0.58	0.04	0.0116	2.183	50	0.012	0.0517	0.4079	0.7235	1.13
15.0	Elastic Silt	91.2	432.0	98.30	432	2.66	0.58	0.04	0.0116	2.183	50	0.012	0.0517	0.4196	0.7752	1.19
16.0	Elastic Silt	91.2	460.8	98.30	461	2.66	0.58	0.04	0.0116	2.183	50	0.011	0.0517	0.4306	0.8269	1.26
17.0	Elastic Silt	91.2	489.6	98.30	490	2.66	0.58	0.04	0.0116	2.183	50	0.010	0.0517	0.4410	0.8785	1.32

Section B-B' at Station 0+19

Cap Load, $q_o = 222.3$ psf
 Time (yrs) = 50
 Depth to Water Table = 0 ft
 Total Primary Consolidation = 0.86 in
 Total Consolidation @ Time = 1.79 in

New Cap	Thickness (ft)	g_{sat} (pcf)	Y_{subr} (psf)
Sand	3.0	125	62
2" d50 Gravel	0.5	135	72.6
Total weight Cap		222.3 psf	
Pressure removed		0.0 psf	

Depth (ft)	Soil Type	g_s (pcf)	Vertical Effective Stress (psf)	Stress Increase, D_p (psf)	Preconsolidation Stress (psf)	Void Ratio e_o	Compression Index C_c	Recompression Index C_r	Secondary Compression Index C_a	Time Required to 95% Condolidation t_p (years)	Time t (years)	Primary Consolidation (in)	Secondary Compression (in)	Total Primary Consolidation Settlement (in)	Total Secondary Compression (30 years) (in)	Total Settlement @ Time (years)
Dredged Surface																
0.0		91.2	0.0	222.30	0	2.66	0.58	0.04	0.0116	3.656	50	0.000	0.0000	0.0000	0.0000	0.00
1.0		91.2	28.8	222.30	29	2.66	0.58	0.04	0.0116	3.656	50	0.123	0.0432	0.1232	0.0432	0.17
2.0		91.2	57.6	222.30	58	2.66	0.58	0.04	0.0116	3.656	50	0.090	0.0432	0.2132	0.0863	0.30
3.0		91.2	86.4	222.30	86	2.66	0.58	0.04	0.0116	3.656	50	0.072	0.0432	0.2857	0.1295	0.42
4.0		91.2	115.2	222.30	115	2.66	0.58	0.04	0.0116	3.656	50	0.061	0.0432	0.3468	0.1727	0.52
5.0		91.2	144.0	222.30	144	2.66	0.58	0.04	0.0116	3.656	50	0.053	0.0432	0.4000	0.2158	0.62
6.0		91.2	172.8	222.30	173	2.66	0.58	0.04	0.0116	3.656	50	0.047	0.0432	0.4470	0.2590	0.71
7.0		91.2	201.6	222.30	202	2.66	0.58	0.04	0.0116	3.656	50	0.042	0.0432	0.4893	0.3022	0.79
8.0		91.2	230.4	222.30	230	2.66	0.58	0.04	0.0116	3.656	50	0.038	0.0432	0.5278	0.3453	0.87
9.0		91.2	259.2	222.30	259	2.66	0.58	0.04	0.0116	3.656	50	0.035	0.0432	0.5630	0.3885	0.95
10.0	Elastic Silt	91.2	288.0	222.30	288	2.66	0.58	0.04	0.0116	3.656	50	0.033	0.0432	0.5956	0.4317	1.03
11.0		91.2	316.8	222.30	317	2.66	0.58	0.04	0.0116	3.656	50	0.030	0.0432	0.6258	0.4748	1.10
12.0		91.2	345.6	222.30	346	2.66	0.58	0.04	0.0116	3.656	50	0.028	0.0432	0.6541	0.5180	1.17
13.0		91.2	374.4	222.30	374	2.66	0.58	0.04	0.0116	3.656	50	0.027	0.0432	0.6806	0.5612	1.24
14.0		91.2	403.2	222.30	403	2.66	0.58	0.04	0.0116	3.656	50	0.025	0.0432	0.7056	0.6043	1.31
15.0		91.2	432.0	222.30	432	2.66	0.58	0.04	0.0116	3.656	50	0.024	0.0432	0.7292	0.6475	1.38
16.0		91.2	460.8	222.30	461	2.66	0.58	0.04	0.0116	3.656	50	0.022	0.0432	0.7516	0.6907	1.44
17.0		91.2	489.6	222.30	490	2.66	0.58	0.04	0.0116	3.656	50	0.021	0.0432	0.7729	0.7338	1.51
18.0		91.2	518.4	222.30	518	2.66	0.58	0.04	0.0116	3.656	50	0.020	0.0432	0.7933	0.7770	1.57
19.0		91.2	547.2	222.30	547	2.66	0.58	0.04	0.0116	3.656	50	0.019	0.0432	0.8127	0.8202	1.63
20.0		91.2	576.0	222.30	576	2.66	0.58	0.04	0.0116	3.656	50	0.019	0.0432	0.8312	0.8634	1.69
21.0		91.2	604.8	222.30	605	2.66	0.58	0.04	0.0116	3.656	50	0.018	0.0432	0.8490	0.9065	1.76
21.5	91.2	619.2	222.30	619	2.66	0.58	0.04	0.0116	3.656	50	0.009	0.0216	0.8578	0.9281	1.79	

Section B-B' at Station 0+30

Cap Load, $q_0 = 98.3$ psf
 Time (yrs) = 50
 Depth to Water Table = 0 ft
 Total Primary Consolidation = 0.47 in
 Total Consolidation @ Time = 1.22 in

New Cap	Thickness (ft)	g_{net} (pcf)	Y_{subr} (psf)
Sand	1.0	125	62
2" d50 Gravel	0.5	135	72.6
Total weight Cap		98.3 psf	
Pressure removed		0.0 psf	

Depth (ft)	Soil Type	g_s (pcf)	Vertical Effective Stress (psf)	Stress Increase, D_p (psf)	Preconsolidation Stress (psf)	Void Ratio e_0	Compression Index C_c	Recompression Index C_r	Secondary Compression Index C_a	Time Required to 95% Condolidation t_p (years)	Time t (years)	Primary Consolidation (in)	Secondary Compression (in)	Total Primary Consolidation Settlement (in)	Total Secondary Compression (30 years) (in)	Total Settlement @ Time (years)
Dredged Surface																
0.0		91.2	0.0	98.30	0	2.66	0.58	0.04	0.0116	5.107	50	0.000	0.0000	0.0000	0.0000	0.00
1.0		91.2	28.8	98.30	29	2.66	0.58	0.04	0.0116	5.107	50	0.084	0.0377	0.0845	0.0377	0.12
2.0		91.2	57.6	98.30	58	2.66	0.58	0.04	0.0116	5.107	50	0.057	0.0377	0.1412	0.0753	0.22
3.0		91.2	86.4	98.30	86	2.66	0.58	0.04	0.0116	5.107	50	0.043	0.0377	0.1844	0.1130	0.30
4.0		91.2	115.2	98.30	115	2.66	0.58	0.04	0.0116	5.107	50	0.035	0.0377	0.2195	0.1506	0.37
5.0		91.2	144.0	98.30	144	2.66	0.58	0.04	0.0116	5.107	50	0.030	0.0377	0.2491	0.1883	0.44
6.0		91.2	172.8	98.30	173	2.66	0.58	0.04	0.0116	5.107	50	0.026	0.0377	0.2747	0.2259	0.50
7.0		91.2	201.6	98.30	202	2.66	0.58	0.04	0.0116	5.107	50	0.023	0.0377	0.2973	0.2636	0.56
8.0		91.2	230.4	98.30	230	2.66	0.58	0.04	0.0116	5.107	50	0.020	0.0377	0.3176	0.3012	0.62
9.0	Elastic Silt	91.2	259.2	98.30	259	2.66	0.58	0.04	0.0116	5.107	50	0.018	0.0377	0.3359	0.3389	0.67
10.0	Elastic Silt	91.2	288.0	98.30	288	2.66	0.58	0.04	0.0116	5.107	50	0.017	0.0377	0.3526	0.3765	0.73
11.0	Elastic Silt	91.2	316.8	98.30	317	2.66	0.58	0.04	0.0116	5.107	50	0.015	0.0377	0.3680	0.4142	0.78
12.0	Elastic Silt	91.2	345.6	98.30	346	2.66	0.58	0.04	0.0116	5.107	50	0.014	0.0377	0.3822	0.4518	0.83
13.0	Elastic Silt	91.2	374.4	98.30	374	2.66	0.58	0.04	0.0116	5.107	50	0.013	0.0377	0.3955	0.4895	0.88
14.0	Elastic Silt	91.2	403.2	98.30	403	2.66	0.58	0.04	0.0116	5.107	50	0.012	0.0377	0.4079	0.5272	0.94
15.0	Elastic Silt	91.2	432.0	98.30	432	2.66	0.58	0.04	0.0116	5.107	50	0.012	0.0377	0.4196	0.5648	0.98
16.0	Elastic Silt	91.2	460.8	98.30	461	2.66	0.58	0.04	0.0116	5.107	50	0.011	0.0377	0.4306	0.6025	1.03
17.0	Elastic Silt	91.2	489.6	98.30	490	2.66	0.58	0.04	0.0116	5.107	50	0.010	0.0377	0.4410	0.6401	1.08
18.0	Elastic Silt	91.2	518.4	98.30	518	2.66	0.58	0.04	0.0116	5.107	50	0.010	0.0377	0.4509	0.6778	1.13
19.0	Elastic Silt	91.2	547.2	98.30	547	2.66	0.58	0.04	0.0116	5.107	50	0.009	0.0377	0.4603	0.7154	1.18
20.0	Elastic Silt	91.2	576.0	98.30	576	2.66	0.58	0.04	0.0116	5.107	50	0.009	0.0377	0.4692	0.7531	1.22

Section C-C' at Station 0+06

Cap Load, q_0 =	98.3	psf
Time (yrs) =	50	
Depth to Water Table =	0	ft
Total Primary Consolidation	0.51	in
Total Consolidation @ Time	1.80	in

New Cap	Thickness (ft)	g_{sat} (pcf)	Y_{subr} (psf)
Sand	1.0	125	62
2" d50 Gravel	0.5	135	72.6
Total weight Cap		98.3 psf	
Pressure removed		0.0 psf	

Depth (ft)	Soil Type	g_s (pcf)	Vertical Effective Stress (psf)	Stress Increase, D_p (psf)	Preconsolidation Stress (psf)	Void Ratio e_0	Compression Index C_c	Recompression Index C_r	Secondary Compression Index C_a	Time Required to 95% Condolidation t_p (years)	Time t (years)	Primary Consolidation (in)	Secondary Compression (in)	Total Primary Consolidation Settlement (in)	Total Secondary Compression (30 years) (in)	Total Settlement @ Time (years)
Dredged Surface																
0.0		91.2	0.0	98.30	0	2.66	0.58	0.04	0.0116	2.183	50	0.000	0.0000	0.0000	0.0000	0.00
1.0		91.2	28.8	98.30	29	2.66	0.58	0.04	0.0116	2.183	50	0.084	0.0517	0.0845	0.0517	0.14
2.0		91.2	57.6	98.30	58	2.66	0.58	0.04	0.0116	2.183	50	0.057	0.0517	0.1412	0.1034	0.24
3.0		91.2	86.4	98.30	86	2.66	0.58	0.04	0.0116	2.183	50	0.043	0.0517	0.1844	0.1550	0.34
4.0		91.2	115.2	98.30	115	2.66	0.58	0.04	0.0116	2.183	50	0.035	0.0517	0.2195	0.2067	0.43
5.0		91.2	144.0	98.30	144	2.66	0.58	0.04	0.0116	2.183	50	0.030	0.0517	0.2491	0.2584	0.51
6.0		91.2	172.8	98.30	173	2.66	0.58	0.04	0.0116	2.183	50	0.026	0.0517	0.2747	0.3101	0.58
7.0		91.2	201.6	98.30	202	2.66	0.58	0.04	0.0116	2.183	50	0.023	0.0517	0.2973	0.3617	0.66
8.0		91.2	230.4	98.30	230	2.66	0.58	0.04	0.0116	2.183	50	0.020	0.0517	0.3176	0.4134	0.73
9.0		91.2	259.2	98.30	259	2.66	0.58	0.04	0.0116	2.183	50	0.018	0.0517	0.3359	0.4651	0.80
10.0		91.2	288.0	98.30	288	2.66	0.58	0.04	0.0116	2.183	50	0.017	0.0517	0.3526	0.5168	0.87
11.0		91.2	316.8	98.30	317	2.66	0.58	0.04	0.0116	2.183	50	0.015	0.0517	0.3680	0.5685	0.94
12.0	Elastic Silt	91.2	345.6	98.30	346	2.66	0.58	0.04	0.0116	2.183	50	0.014	0.0517	0.3822	0.6201	1.00
13.0	Elastic Silt	91.2	374.4	98.30	374	2.66	0.58	0.04	0.0116	2.183	50	0.013	0.0517	0.3955	0.6718	1.07
14.0	Elastic Silt	91.2	403.2	98.30	403	2.66	0.58	0.04	0.0116	2.183	50	0.012	0.0517	0.4079	0.7235	1.13
15.0	Elastic Silt	91.2	432.0	98.30	432	2.66	0.58	0.04	0.0116	2.183	50	0.012	0.0517	0.4196	0.7752	1.19
16.0	Elastic Silt	91.2	460.8	98.30	461	2.66	0.58	0.04	0.0116	2.183	50	0.011	0.0517	0.4306	0.8269	1.26
17.0	Elastic Silt	91.2	489.6	98.30	490	2.66	0.58	0.04	0.0116	2.183	50	0.010	0.0517	0.4410	0.8785	1.32

Section C-C' at Station 0+14

Cap Load, $q_0 = 284.3$ psf
 Time (yrs) = 50
 Depth to Water Table = 0 ft
 Total Primary Consolidation = 0.93 in
 Total Consolidation @ Time = 1.86 in

New Cap	Thickness (ft)	g_{sat} (pcf)	Y_{subr} (psf)
Sand	4.0	125	62
2" d50 Gravel	0.5	135	72.6
Total weight Cap		284.3 psf	
Pressure removed		0.0 psf	

Depth (ft)	Soil Type	g_s (pcf)	Vertical Effective Stress (psf)	Stress Increase, D_p (psf)	Preconsolidation Stress (psf)	Void Ratio e_0	Compression Index C_c	Recompression Index C_r	Secondary Compression Index C_a	Time Required to 95% Condolidation t_p (years)	Time t (years)	Primary Consolidation (in)	Secondary Compression (in)	Total Primary Consolidation Settlement (in)	Total Secondary Compression (30 years) (in)	Total Settlement @ Time (years)
Dredged Surface																
0.0		91.2	0.0	284.30	0	2.66	0.58	0.04	0.0116	2.183	50	0.000	0.0000	0.0000	0.0000	0.00
1.0		91.2	28.8	284.30	29	2.66	0.58	0.04	0.0116	2.183	50	0.136	0.0517	0.1358	0.0517	0.19
2.0		91.2	57.6	284.30	58	2.66	0.58	0.04	0.0116	2.183	50	0.101	0.0517	0.2372	0.1034	0.34
3.0		91.2	86.4	284.30	86	2.66	0.58	0.04	0.0116	2.183	50	0.083	0.0517	0.3200	0.1550	0.48
4.0		91.2	115.2	284.30	115	2.66	0.58	0.04	0.0116	2.183	50	0.071	0.0517	0.3908	0.2067	0.60
5.0		91.2	144.0	284.30	144	2.66	0.58	0.04	0.0116	2.183	50	0.062	0.0517	0.4528	0.2584	0.71
6.0		91.2	172.8	284.30	173	2.66	0.58	0.04	0.0116	2.183	50	0.055	0.0517	0.5082	0.3101	0.82
7.0		91.2	201.6	284.30	202	2.66	0.58	0.04	0.0116	2.183	50	0.050	0.0517	0.5583	0.3617	0.92
8.0	Elastic Silt	91.2	230.4	284.30	230	2.66	0.58	0.04	0.0116	2.183	50	0.046	0.0517	0.6040	0.4134	1.02
9.0	Elastic Silt	91.2	259.2	284.30	259	2.66	0.58	0.04	0.0116	2.183	50	0.042	0.0517	0.6461	0.4651	1.11
10.0	Elastic Silt	91.2	288.0	284.30	288	2.66	0.58	0.04	0.0116	2.183	50	0.039	0.0517	0.6852	0.5168	1.20
11.0	Elastic Silt	91.2	316.8	284.30	317	2.66	0.58	0.04	0.0116	2.183	50	0.036	0.0517	0.7217	0.5685	1.29
12.0	Elastic Silt	91.2	345.6	284.30	346	2.66	0.58	0.04	0.0116	2.183	50	0.034	0.0517	0.7558	0.6201	1.38
13.0	Elastic Silt	91.2	374.4	284.30	374	2.66	0.58	0.04	0.0116	2.183	50	0.032	0.0517	0.7880	0.6718	1.46
14.0	Elastic Silt	91.2	403.2	284.30	403	2.66	0.58	0.04	0.0116	2.183	50	0.030	0.0517	0.8184	0.7235	1.54
15.0	Elastic Silt	91.2	432.0	284.30	432	2.66	0.58	0.04	0.0116	2.183	50	0.029	0.0517	0.8471	0.7752	1.62
16.0	Elastic Silt	91.2	460.8	284.30	461	2.66	0.58	0.04	0.0116	2.183	50	0.027	0.0517	0.8745	0.8269	1.70
17.0	Elastic Silt	91.2	489.6	284.30	490	2.66	0.58	0.04	0.0116	2.183	50	0.026	0.0517	0.9005	0.8785	1.78

Section C-C' at Station 0+23

Cap Load, $q_o = 98.3$ psf
 Time (yrs) = 50
 Depth to Water Table = 0 ft
 Total Primary Consolidation = 0.46 in
 Total Consolidation @ Time = 1.44 in

New Cap	Thickness (ft)	g_{sat} (pcf)	Y_{subr} (psf)
Sand	1.0	125	62
2" d50 Gravel	0.5	135	72.6
Total weight Cap		98.3 psf	
Pressure removed		0.0 psf	

Depth (ft)	Soil Type	g_s (pcf)	Vertical Effective Stress (psf)	Stress Increase, D_p (psf)	Preconsolidation Stress (psf)	Void Ratio e_o	Compression Index C_c	Recompression Index C_r	Secondary Compression Index C_a	Time Required to 95% Condolidation t_p (years)	Time t (years)	Primary Consolidation (in)	Secondary Compression (in)	Total Primary Consolidation Settlement (in)	Total Secondary Compression (30 years) (in)	Total Settlement @ Time (years)
Dredged Surface																
0.0		91.2	0.0	98.30	0	2.66	0.58	0.04	0.0116	2.183	50	0.000	0.0000	0.0000	0.0000	0.00
1.0		91.2	28.8	98.30	29	2.66	0.58	0.04	0.0116	2.183	50	0.084	0.0517	0.0845	0.0517	0.14
2.0		91.2	57.6	98.30	58	2.66	0.58	0.04	0.0116	2.183	50	0.057	0.0517	0.1412	0.1034	0.24
3.0		91.2	86.4	98.30	86	2.66	0.58	0.04	0.0116	2.183	50	0.043	0.0517	0.1844	0.1550	0.34
4.0		91.2	115.2	98.30	115	2.66	0.58	0.04	0.0116	2.183	50	0.035	0.0517	0.2195	0.2067	0.43
5.0		91.2	144.0	98.30	144	2.66	0.58	0.04	0.0116	2.183	50	0.030	0.0517	0.2491	0.2584	0.51
6.0		91.2	172.8	98.30	173	2.66	0.58	0.04	0.0116	2.183	50	0.026	0.0517	0.2747	0.3101	0.58
7.0		91.2	201.6	98.30	202	2.66	0.58	0.04	0.0116	2.183	50	0.023	0.0517	0.2973	0.3617	0.66
8.0		91.2	230.4	98.30	230	2.66	0.58	0.04	0.0116	2.183	50	0.020	0.0517	0.3176	0.4134	0.73
9.0	Elastic Silt	91.2	259.2	98.30	259	2.66	0.58	0.04	0.0116	2.183	50	0.018	0.0517	0.3359	0.4651	0.80
10.0		91.2	288.0	98.30	288	2.66	0.58	0.04	0.0116	2.183	50	0.017	0.0517	0.3526	0.5168	0.87
11.0		91.2	316.8	98.30	317	2.66	0.58	0.04	0.0116	2.183	50	0.015	0.0517	0.3680	0.5685	0.94
12.0		91.2	345.6	98.30	346	2.66	0.58	0.04	0.0116	2.183	50	0.014	0.0517	0.3822	0.6201	1.00
13.0		91.2	374.4	98.30	374	2.66	0.58	0.04	0.0116	2.183	50	0.013	0.0517	0.3955	0.6718	1.07
14.0		91.2	403.2	98.30	403	2.66	0.58	0.04	0.0116	2.183	50	0.012	0.0517	0.4079	0.7235	1.13
15.0		91.2	432.0	98.30	432	2.66	0.58	0.04	0.0116	2.183	50	0.012	0.0517	0.4196	0.7752	1.19
16.0		91.2	460.8	98.30	461	2.66	0.58	0.04	0.0116	2.183	50	0.011	0.0517	0.4306	0.8269	1.26
17.0		91.2	489.6	98.30	490	2.66	0.58	0.04	0.0116	2.183	50	0.010	0.0517	0.4410	0.8785	1.32

Section 1 Station 0+13

Cap Load, $q_o = 346.3$ psf
 Time (yrs) = 50
 Depth to Water Table = 0 ft
 Total Primary Consolidation = 1.07 in
 Total Consolidation @ Time = 2.05 in

New Cap	Thickness (ft)	g_{sat} (pcf)	Y_{subr} (psf)
Sand	5.0	125	62
2" d50 Gravel	0.5	135	72.6
Total weight Cap		346.3 psf	
Pressure removed		0.0 psf	

Depth (ft)	Soil Type	g_s (pcf)	Vertical Effective Stress (psf)	Stress Increase, D_p (psf)	Preconsolidation Stress (psf)	Void Ratio e_o	Compression Index C_c	Recompression Index C_r	Secondary Compression Index C_a	Time Required to 95% Condolidation t_p (years)	Time t (years)	Primary Consolidation (in)	Secondary Compression (in)	Total Primary Consolidation Settlement (in)	Total Secondary Compression (30 years) (in)	Total Settlement @ Time (years)
Dredged Surface																
0.0		91.2	0.0	346.30	0	2.66	0.58	0.04	0.0116	2.183	50	0.000	0.0000	0.0000	0.0000	0.00
1.0		91.2	28.8	346.30	29	2.66	0.58	0.04	0.0116	2.183	50	0.146	0.0517	0.1461	0.0517	0.20
2.0		91.2	57.6	346.30	58	2.66	0.58	0.04	0.0116	2.183	50	0.111	0.0517	0.2569	0.1034	0.36
3.0		91.2	86.4	346.30	86	2.66	0.58	0.04	0.0116	2.183	50	0.092	0.0517	0.3486	0.1550	0.50
4.0		91.2	115.2	346.30	115	2.66	0.58	0.04	0.0116	2.183	50	0.079	0.0517	0.4276	0.2067	0.63
5.0		91.2	144.0	346.30	144	2.66	0.58	0.04	0.0116	2.183	50	0.070	0.0517	0.4973	0.2584	0.76
6.0		91.2	172.8	346.30	173	2.66	0.58	0.04	0.0116	2.183	50	0.063	0.0517	0.5599	0.3101	0.87
7.0		91.2	201.6	346.30	202	2.66	0.58	0.04	0.0116	2.183	50	0.057	0.0517	0.6168	0.3617	0.98
8.0		91.2	230.4	346.30	230	2.66	0.58	0.04	0.0116	2.183	50	0.052	0.0517	0.6690	0.4134	1.08
9.0	Elastic Silt	91.2	259.2	346.30	259	2.66	0.58	0.04	0.0116	2.183	50	0.048	0.0517	0.7173	0.4651	1.18
10.0		91.2	288.0	346.30	288	2.66	0.58	0.04	0.0116	2.183	50	0.045	0.0517	0.7622	0.5168	1.28
11.0		91.2	316.8	346.30	317	2.66	0.58	0.04	0.0116	2.183	50	0.042	0.0517	0.8043	0.5685	1.37
12.0		91.2	345.6	346.30	346	2.66	0.58	0.04	0.0116	2.183	50	0.040	0.0517	0.8438	0.6201	1.46
13.0		91.2	374.4	346.30	374	2.66	0.58	0.04	0.0116	2.183	50	0.037	0.0517	0.8811	0.6718	1.55
14.0		91.2	403.2	346.30	403	2.66	0.58	0.04	0.0116	2.183	50	0.035	0.0517	0.9163	0.7235	1.64
15.0		91.2	432.0	346.30	432	2.66	0.58	0.04	0.0116	2.183	50	0.034	0.0517	0.9498	0.7752	1.73
16.0		91.2	460.8	346.30	461	2.66	0.58	0.04	0.0116	2.183	50	0.032	0.0517	0.9817	0.8269	1.81
17.0		91.2	489.6	346.30	490	2.66	0.58	0.04	0.0116	2.183	50	0.030	0.0517	1.0122	0.8785	1.89

Section 1 Station 0+27

Cap Load, $q_0 = 98.3$ psf
 Time (yrs) = 50
 Depth to Water Table = 0 ft
 Total Primary Consolidation = 0.45 in
 Total Consolidation @ Time = 1.38 in

New Cap	Thickness (ft)	g_{sat} (pcf)	Y_{subr} (psf)
Sand	1.0	125	62
2" d50 Gravel	0.5	135	72.6
Total weight Cap		98.3 psf	
Pressure removed		0.0 psf	

Depth (ft)	Soil Type	g_s (pcf)	Vertical Effective Stress (psf)	Stress Increase, D_p (psf)	Preconsolidation Stress (psf)	Void Ratio e_0	Compression Index C_c	Recompression Index C_r	Secondary Compression Index C_a	Time Required to 95% Condolidation t_p (years)	Time t (years)	Primary Consolidation (in)	Secondary Compression (in)	Total Primary Consolidation Settlement (in)	Total Secondary Compression (30 years) (in)	Total Settlement @ Time (years)
Dredged Surface																
0.0		91.2	0.0	98.30	0	2.66	0.58	0.04	0.0116	2.183	50	0.000	0.0000	0.0000	0.0000	0.00
1.0		91.2	28.8	98.30	29	2.66	0.58	0.04	0.0116	2.183	50	0.084	0.0517	0.0845	0.0517	0.14
2.0		91.2	57.6	98.30	58	2.66	0.58	0.04	0.0116	2.183	50	0.057	0.0517	0.1412	0.1034	0.24
3.0		91.2	86.4	98.30	86	2.66	0.58	0.04	0.0116	2.183	50	0.043	0.0517	0.1844	0.1550	0.34
4.0		91.2	115.2	98.30	115	2.66	0.58	0.04	0.0116	2.183	50	0.035	0.0517	0.2195	0.2067	0.43
5.0		91.2	144.0	98.30	144	2.66	0.58	0.04	0.0116	2.183	50	0.030	0.0517	0.2491	0.2584	0.51
6.0		91.2	172.8	98.30	173	2.66	0.58	0.04	0.0116	2.183	50	0.026	0.0517	0.2747	0.3101	0.58
7.0		91.2	201.6	98.30	202	2.66	0.58	0.04	0.0116	2.183	50	0.023	0.0517	0.2973	0.3617	0.66
8.0	Elastic Silt	91.2	230.4	98.30	230	2.66	0.58	0.04	0.0116	2.183	50	0.020	0.0517	0.3176	0.4134	0.73
9.0	Elastic Silt	91.2	259.2	98.30	259	2.66	0.58	0.04	0.0116	2.183	50	0.018	0.0517	0.3359	0.4651	0.80
10.0	Elastic Silt	91.2	288.0	98.30	288	2.66	0.58	0.04	0.0116	2.183	50	0.017	0.0517	0.3526	0.5168	0.87
11.0	Elastic Silt	91.2	316.8	98.30	317	2.66	0.58	0.04	0.0116	2.183	50	0.015	0.0517	0.3680	0.5685	0.94
12.0	Elastic Silt	91.2	345.6	98.30	346	2.66	0.58	0.04	0.0116	2.183	50	0.014	0.0517	0.3822	0.6201	1.00
13.0	Elastic Silt	91.2	374.4	98.30	374	2.66	0.58	0.04	0.0116	2.183	50	0.013	0.0517	0.3955	0.6718	1.07
14.0	Elastic Silt	91.2	403.2	98.30	403	2.66	0.58	0.04	0.0116	2.183	50	0.012	0.0517	0.4079	0.7235	1.13
15.0	Elastic Silt	91.2	432.0	98.30	432	2.66	0.58	0.04	0.0116	2.183	50	0.012	0.0517	0.4196	0.7752	1.19
16.0	Elastic Silt	91.2	460.8	98.30	461	2.66	0.58	0.04	0.0116	2.183	50	0.011	0.0517	0.4306	0.8269	1.26
17.0	Elastic Silt	91.2	489.6	98.30	490	2.66	0.58	0.04	0.0116	2.183	50	0.010	0.0517	0.4410	0.8785	1.32

Section 2 Station 0+08

Cap Load, $q_0 = 98.3$ psf
 Time (yrs) = 50
 Depth to Water Table = 0 ft
 Total Primary Consolidation = 0.52 in
 Total Consolidation @ Time = 1.86 in

New Cap	Thickness (ft)	g_{sat} (pcf)	Y_{subr} (psf)
Sand	1.0	125	62
2" d50 Gravel	0.5	135	72.6
Total weight Cap		98.3 psf	
Pressure removed		0.0 psf	

Depth (ft)	Soil Type	g_s (pcf)	Vertical Effective Stress (psf)	Stress Increase, D_p (psf)	Preconsolidation Stress (psf)	Void Ratio e_0	Compression Index C_c	Recompression Index C_r	Secondary Compression Index C_a	Time Required to 95% Condolidation t_p (years)	Time t (years)	Primary Consolidation (in)	Secondary Compression (in)	Total Primary Consolidation Settlement (in)	Total Secondary Compression (30 years) (in)	Total Settlement @ Time (years)
Dredged Surface																
0.0		91.2	0.0	98.30	0	2.66	0.58	0.04	0.0116	2.183	50	0.000	0.0000	0.0000	0.0000	0.00
1.0		91.2	28.8	98.30	29	2.66	0.58	0.04	0.0116	2.183	50	0.084	0.0517	0.0845	0.0517	0.14
2.0		91.2	57.6	98.30	58	2.66	0.58	0.04	0.0116	2.183	50	0.057	0.0517	0.1412	0.1034	0.24
3.0		91.2	86.4	98.30	86	2.66	0.58	0.04	0.0116	2.183	50	0.043	0.0517	0.1844	0.1550	0.34
4.0		91.2	115.2	98.30	115	2.66	0.58	0.04	0.0116	2.183	50	0.035	0.0517	0.2195	0.2067	0.43
5.0		91.2	144.0	98.30	144	2.66	0.58	0.04	0.0116	2.183	50	0.030	0.0517	0.2491	0.2584	0.51
6.0		91.2	172.8	98.30	173	2.66	0.58	0.04	0.0116	2.183	50	0.026	0.0517	0.2747	0.3101	0.58
7.0		91.2	201.6	98.30	202	2.66	0.58	0.04	0.0116	2.183	50	0.023	0.0517	0.2973	0.3617	0.66
8.0		91.2	230.4	98.30	230	2.66	0.58	0.04	0.0116	2.183	50	0.020	0.0517	0.3176	0.4134	0.73
9.0		91.2	259.2	98.30	259	2.66	0.58	0.04	0.0116	2.183	50	0.018	0.0517	0.3359	0.4651	0.80
10.0		91.2	288.0	98.30	288	2.66	0.58	0.04	0.0116	2.183	50	0.017	0.0517	0.3526	0.5168	0.87
11.0		91.2	316.8	98.30	317	2.66	0.58	0.04	0.0116	2.183	50	0.015	0.0517	0.3680	0.5685	0.94
12.0	Elastic Silt	91.2	345.6	98.30	346	2.66	0.58	0.04	0.0116	2.183	50	0.014	0.0517	0.3822	0.6201	1.00
13.0	Elastic Silt	91.2	374.4	98.30	374	2.66	0.58	0.04	0.0116	2.183	50	0.013	0.0517	0.3955	0.6718	1.07
14.0	Elastic Silt	91.2	403.2	98.30	403	2.66	0.58	0.04	0.0116	2.183	50	0.012	0.0517	0.4079	0.7235	1.13
15.0	Elastic Silt	91.2	432.0	98.30	432	2.66	0.58	0.04	0.0116	2.183	50	0.012	0.0517	0.4196	0.7752	1.19
16.0	Elastic Silt	91.2	460.8	98.30	461	2.66	0.58	0.04	0.0116	2.183	50	0.011	0.0517	0.4306	0.8269	1.26
17.0	Elastic Silt	91.2	489.6	98.30	490	2.66	0.58	0.04	0.0116	2.183	50	0.010	0.0517	0.4410	0.8785	1.32

Section 2 Station 0+16

Cap Load, $q_0 = 470.3$ psf
 Time (yrs) = 50
 Depth to Water Table = 0 ft
 Total Primary Consolidation = 1.18 in
 Total Consolidation @ Time = 2.04 in

New Cap	Thickness (ft)	g_{sat} (pcf)	Y_{subr} (psf)
Sand	7.0	125	62
2" d50 Gravel	0.5	135	72.6
Total weight Cap		470.3 psf	
Pressure removed		0.0 psf	

Depth (ft)	Soil Type	g_s (pcf)	Vertical Effective Stress (psf)	Stress Increase, D_p (psf)	Preconsolidation Stress (psf)	Void Ratio e_0	Compression Index C_c	Recompression Index C_r	Secondary Compression Index C_a	Time Required to 95% Condolidation t_p (years)	Time t (years)	Primary Consolidation (in)	Secondary Compression (in)	Total Primary Consolidation Settlement (in)	Total Secondary Compression (30 years) (in)	Total Settlement @ Time (years)
Dredged Surface																
0.0		91.2	0.0	470.30	0	2.66	0.58	0.04	0.0116	2.183	50	0.000	0.0000	0.0000	0.0000	0.00
1.0		91.2	28.8	470.30	29	2.66	0.58	0.04	0.0116	2.183	50	0.162	0.0517	0.1623	0.0517	0.21
2.0		91.2	57.6	470.30	58	2.66	0.58	0.04	0.0116	2.183	50	0.126	0.0517	0.2884	0.1034	0.39
3.0		91.2	86.4	470.30	86	2.66	0.58	0.04	0.0116	2.183	50	0.106	0.0517	0.3944	0.1550	0.55
4.0		91.2	115.2	470.30	115	2.66	0.58	0.04	0.0116	2.183	50	0.093	0.0517	0.4870	0.2067	0.69
5.0		91.2	144.0	470.30	144	2.66	0.58	0.04	0.0116	2.183	50	0.083	0.0517	0.5695	0.2584	0.83
6.0		91.2	172.8	470.30	173	2.66	0.58	0.04	0.0116	2.183	50	0.075	0.0517	0.6443	0.3101	0.95
7.0		91.2	201.6	470.30	202	2.66	0.58	0.04	0.0116	2.183	50	0.069	0.0517	0.7128	0.3617	1.07
8.0	Elastic Silt	91.2	230.4	470.30	230	2.66	0.58	0.04	0.0116	2.183	50	0.063	0.0517	0.7761	0.4134	1.19
9.0	Elastic Silt	91.2	259.2	470.30	259	2.66	0.58	0.04	0.0116	2.183	50	0.059	0.0517	0.8350	0.4651	1.30
10.0	Elastic Silt	91.2	288.0	470.30	288	2.66	0.58	0.04	0.0116	2.183	50	0.055	0.0517	0.8901	0.5168	1.41
11.0	Elastic Silt	91.2	316.8	470.30	317	2.66	0.58	0.04	0.0116	2.183	50	0.052	0.0517	0.9419	0.5685	1.51
12.0	Elastic Silt	91.2	345.6	470.30	346	2.66	0.58	0.04	0.0116	2.183	50	0.049	0.0517	0.9908	0.6201	1.61
13.0	Elastic Silt	91.2	374.4	470.30	374	2.66	0.58	0.04	0.0116	2.183	50	0.046	0.0517	1.0371	0.6718	1.71
14.0	Elastic Silt	91.2	403.2	470.30	403	2.66	0.58	0.04	0.0116	2.183	50	0.044	0.0517	1.0811	0.7235	1.80
15.0	Elastic Silt	91.2	432.0	470.30	432	2.66	0.58	0.04	0.0116	2.183	50	0.042	0.0517	1.1230	0.7752	1.90
16.0	Elastic Silt	91.2	460.8	470.30	461	2.66	0.58	0.04	0.0116	2.183	50	0.040	0.0517	1.1630	0.8269	1.99
16.5	Elastic Silt	91.2	475.2	470.30	475	2.66	0.58	0.04	0.0116	2.183	50	0.020	0.0258	1.1826	0.8527	2.04

CITY:(SYRACUSE,NY) DIV:(GROUP,ENCAD) DR:(SR,BLL) LD:(SBELL) PIC:() PN:(G,VANDERLAAN) TM:(G,VANDERLAAN) LVR:(ORION#:"OFF=REF") PLOTSETUP:PDF D2B PLOTSTYLETABLE:PLT\FULL.CTB PLOTTED:6/9/2011 2:07 PM BY:BELL,STEVEN

XREFS: 00664X01 00664X00
IMAGES: PROJECTNAME: --

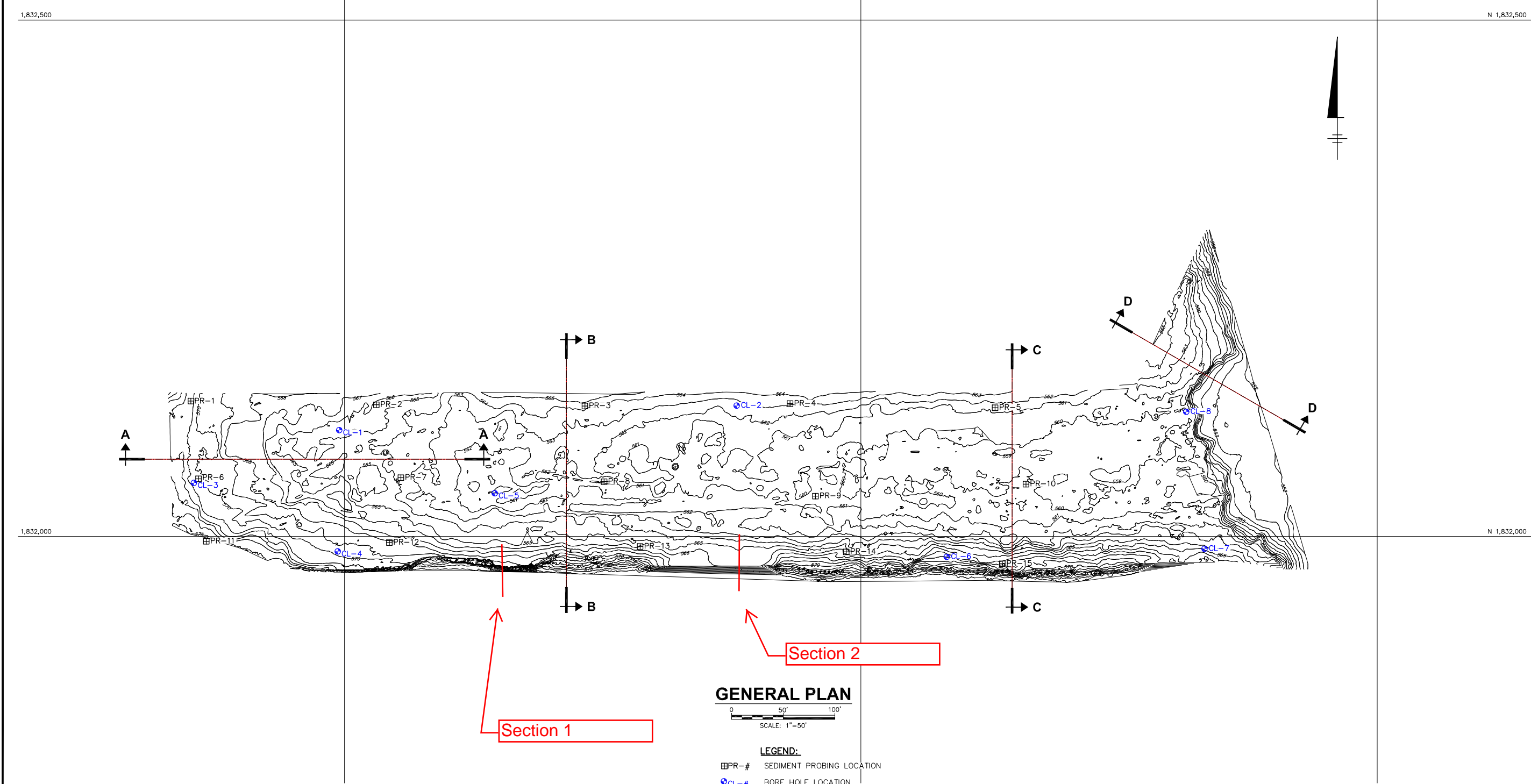

GENERAL PLAN

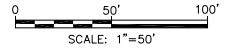

- LEGEND:**
- PR-# SEDIMENT PROBING LOCATION
 - CL-# BORE HOLE LOCATION

FORMER WISONSIN STEEL WORKS
CHICAGO, IL
SOUTH SLIP REMEDIAL ACTION ALTERNATIVES

GENERAL PLAN



FIGURE
D1-1

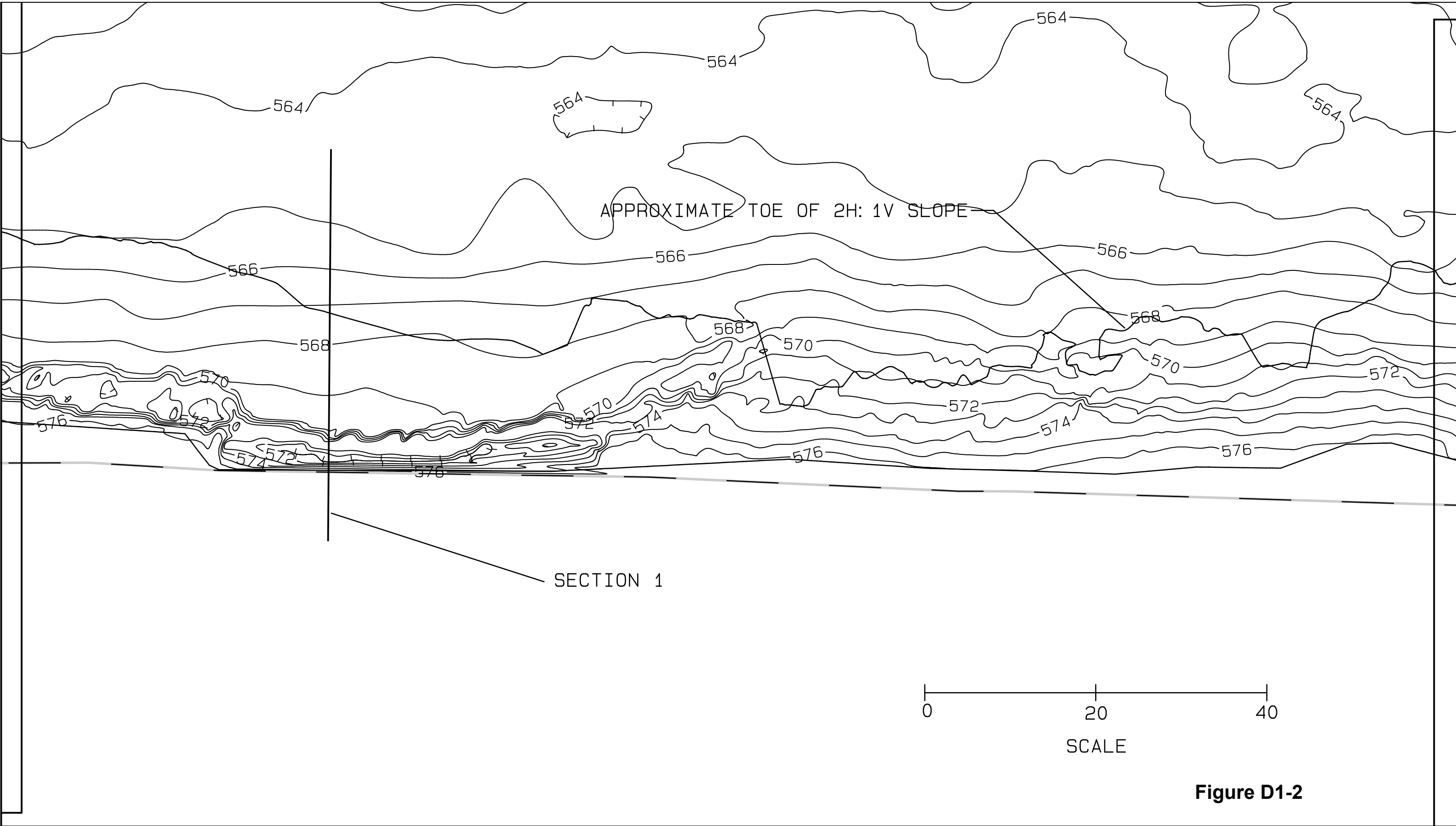
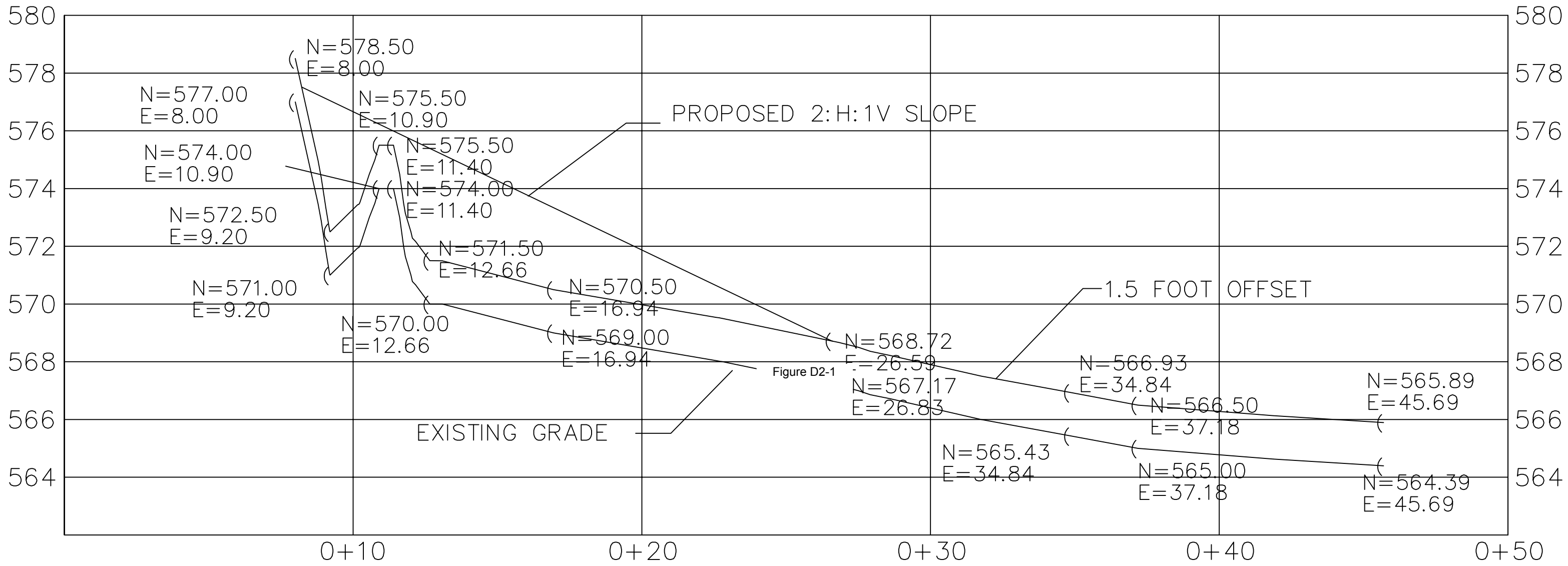

Figure D1-2

South

North



SECTION 1

See Figure D1-1 in this calculation sheet for plan view showing section location.

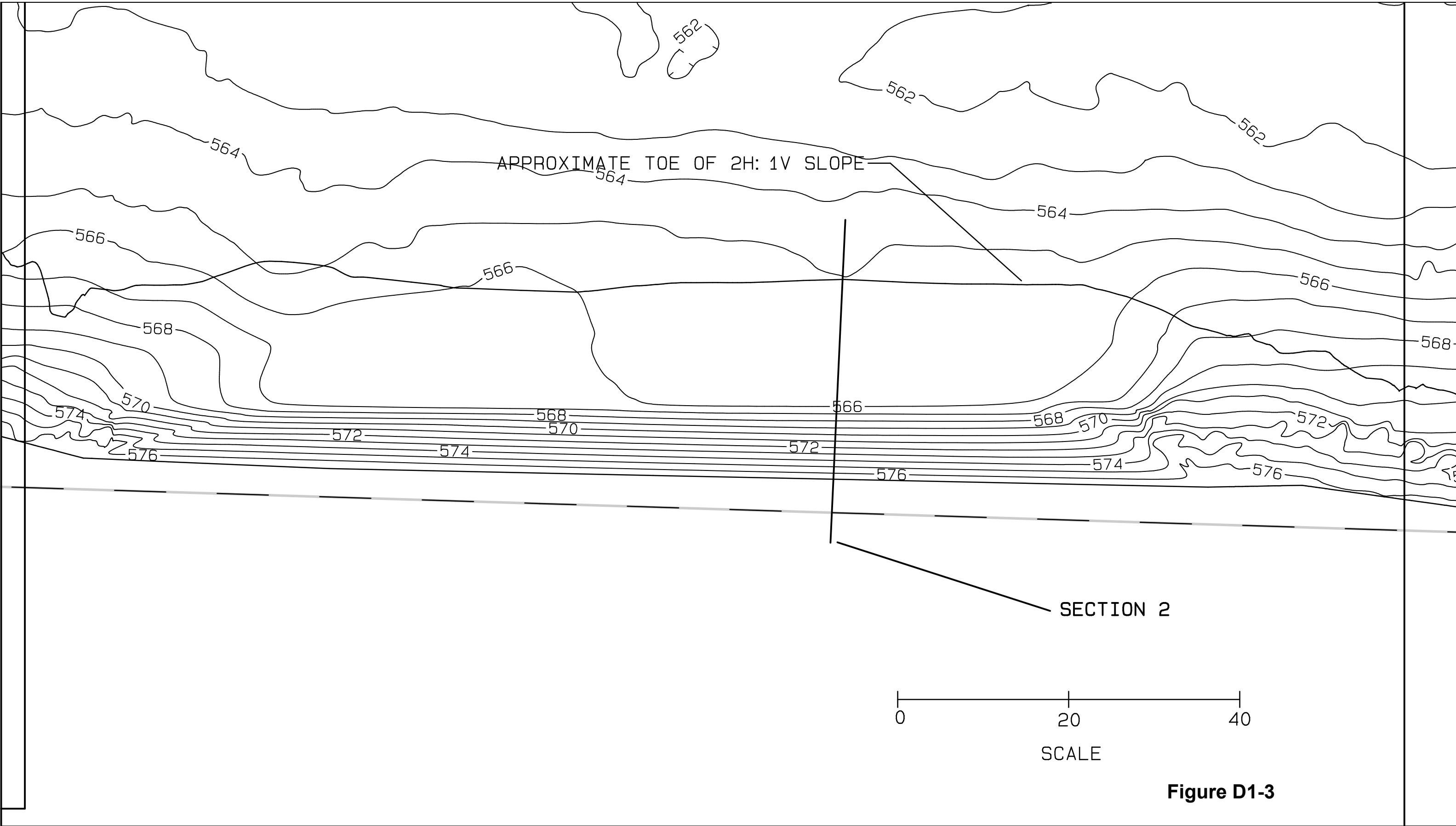
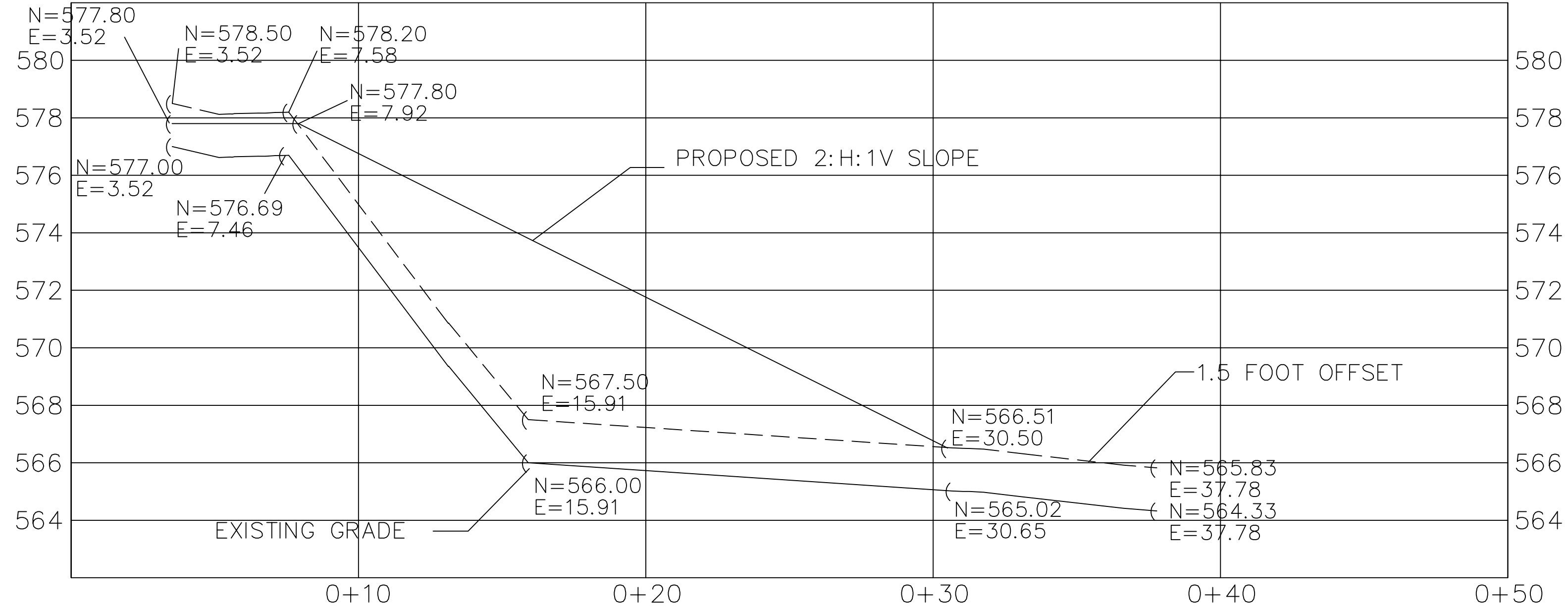

Figure D1-3

South

North



SECTION 2

See Figure D1-1 of this calculation sheet for plan view showing section location.

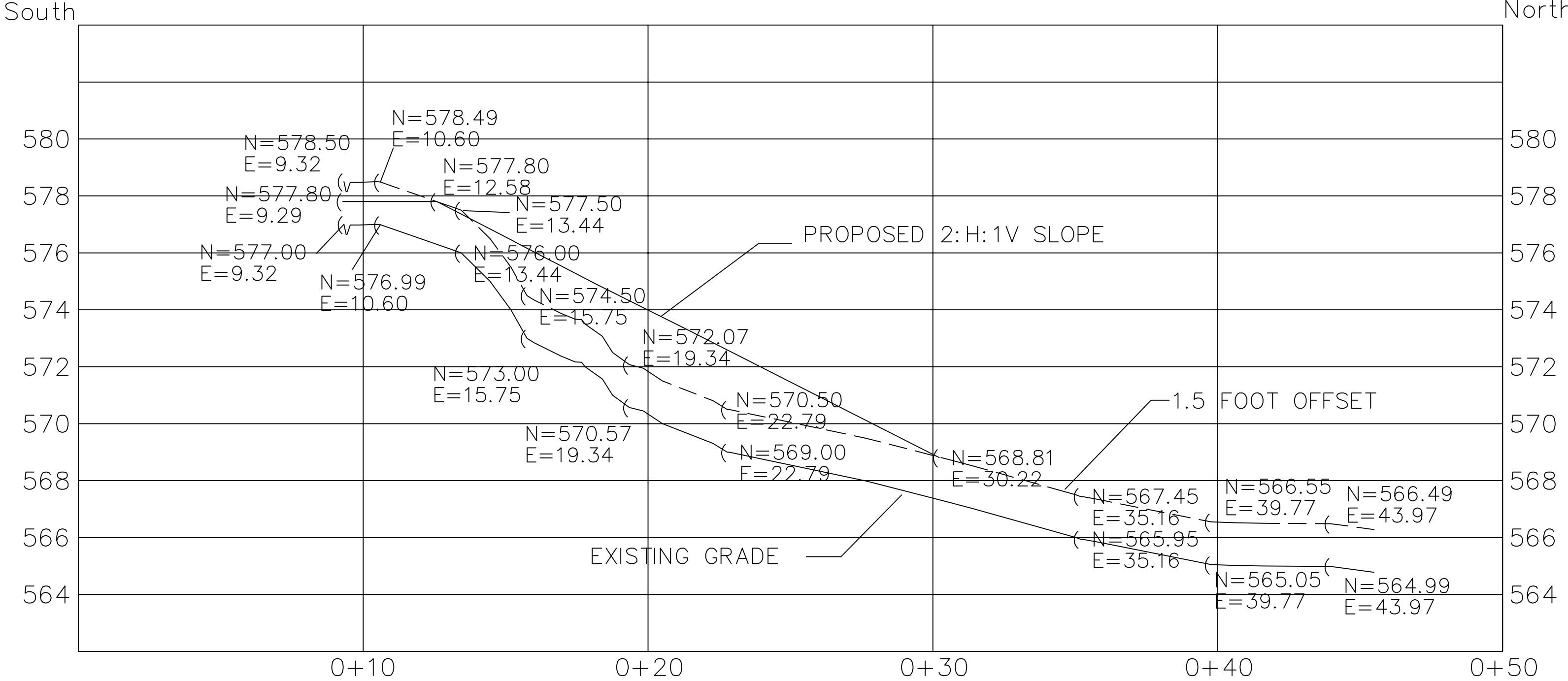

SECTION B-B'

See Figure D1-1 in this calculation sheet for plan view showing section location.

South

North

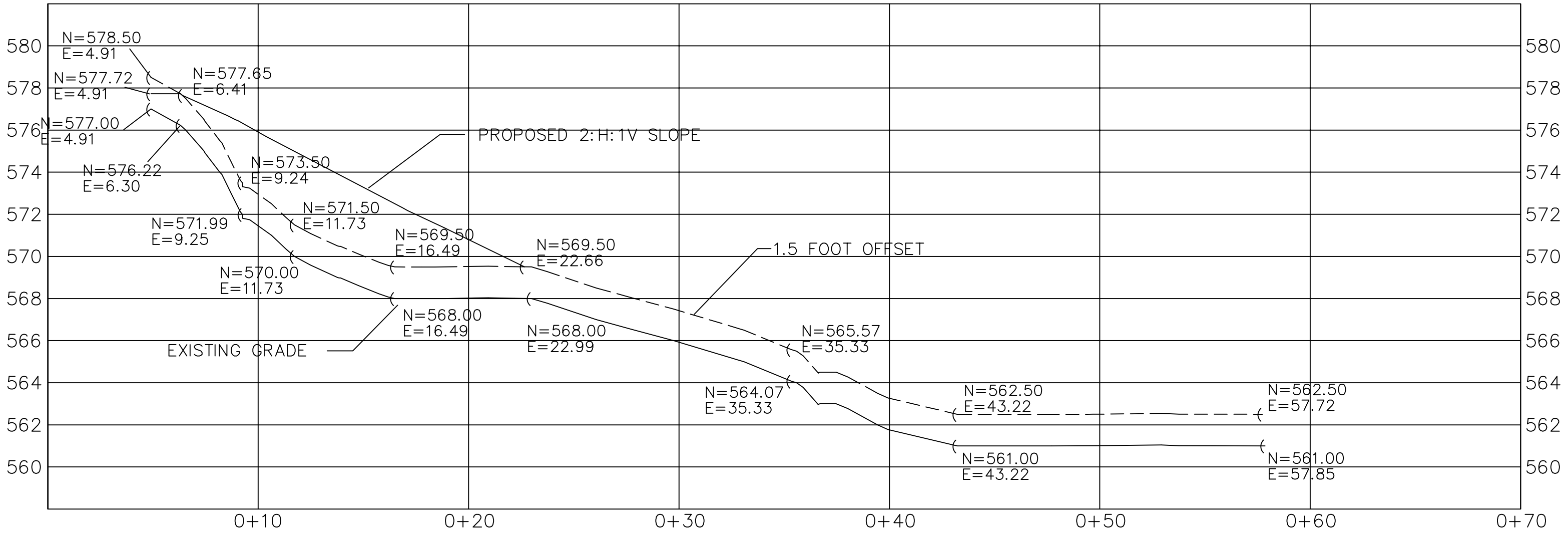

SECTION C-C'

See Figure D1-1 in this calculation sheet for plan view showing section location.

Soil Data from WSW PDI, Spring 2011.

UU Test 1-D Consolidation Test Results

Sample Location	Sample Depth (ft bss)	Gravel Content (%)	Sand Content (%)	Fines Content (%)	Coefficient of Gradation (Cc)	Uniformity Coefficient (Cu)	Water Content (MC - %)	Wet Density (WD - pcf)	Dry Density (DD - pcf)	Liquid Limit (LL)	Plastic Limit (PL)	Plasticity Index (PI)	Organic Content (OC - %)	Undrained Shear Strength (Su = pcf)	Initial Void Ratio (e ₀)	Pre-consolidation Pressure (Pc)	Compression Index (Cc)	Recompression Index (Cr)	Specific Gravity	USCS Classification*	Soil Description**		
CL1	0 - 0.8	1.6	27.2	71.2	1.89	9.20	1.7						11.5						2.35	ML			
	2 - 4	0.0	15.2	84.8	1.66	6.60	78.3	78.5	44.1										2.23	MH	SILT, little sand		
CL2	2 - 4	0.0	6.9	93.1	0.76	4.78	105.9	83.3	40.5				7.6						2.74	MH	SILT, trace sand		
	4 - 6	1.8	12.8	85.4	1.43	4.14	80.8	84.4	46.7					2.663	0.63	0.58	0.04			MH			
	6 - 8									54	37	17									MH (v)		
	8 - 10	0.0	14.9	85.1	1.04	3.82	192.5	92.1	31.5										2.71	MH	SILT, little sand, little clay		
CL3	2 - 4	0.0	32.5	67.5	0.55	6.87	60.9	87.9	54.7										2.22	MH	SILT, some Sand, trace clay		
	4 - 6	0.0	17.2	82.8	1.32	6.22	2.7						18.3								MH	SILT, little sand, little clay	
	6 - 8	0.0	32.0	68.0	0.51	10.35	68.5	86.7	51.4												MH	SILT, some Sand, little clay	
	8 - 10						57.7	86.9	55.1										2.57	MH (v)			
CL4	4 - 6	0.0	35.0	65.0	0.68	21.41	72.1		43.2				18.6								MH		
	8 - 10	0.0	16.1	83.9	1.25	2.85	99.2	80.3	40.3												MH	SILT, some Sand, trace clay	
CL5	2 - 4	0.0	12.1	87.9			38.6	107.0	77.2												ML	CLAY, some Silt, trace sand	
	4 - 6	0.0	18.3	81.6	0.90	3.69	74.3	86.7	49.8										2.82	MH	SILT, little sand, little clay		
CL6	6 - 8						82.4		62.2	42	30	12	6.0						2.93	ML			
	8 - 10																				MH (v)		
	10 - 12						89.6	89.6	44.6	56	37	19	7.8						2.95	MH (v)			
	12 - 14	4.4	14.4	81.2	1.13	4.34	86.1	92.7	49.8	51	38	13	8.3	173.0					2.73	MH			
CL7	2 - 4	0.0	21.3	78.7	0.89	6.40				57	39	18									MH	SILT, some Sand, little clay	
	4 - 6	0.0	6.2	93.8	1.49	3.80	69.2			52	36	16		110.0					3.04	MH			
	6 - 8	0.2	12.9	86.9	1.33	6.99	76.0	100.0	56.8	47	36	11			2.289	0.71	0.54	0.04	2.99	ML			
	10 - 12	1.5	16.5	82.0	0.94	5.60	75.3	99.9	57.0	51	36	15		161.0	2.237	0.81	0.50	0.03	2.96	MH			
	14 - 16	0.9	8.4	90.7																	MH	SILT, some Clay, trace sand, trace gravel	
CL8	2 - 4	0.0	4.8	95.2			72.2		61.3	50	36	14	5.6	122.0	2.080	0.74	0.60	0.05	3.02	MH			
	4 - 6	0.2	14.5	85.3	0.76	7.03															MH		
	8 - 10	0.6	62.2	37.2	0.91	51.90	27.2	112.7	88.6												SM	SAND, some Silt, little clay, trace gravel	
	10 - 12									22	15	7										CL-ML	
	12 - 14																					ML (v)	
PDI-SS-1	0 - 0.8	24.6	38.3	37.1	0.54	59.13															SM	SAND, some Silt, some Gravel, trace clay	
PDI-SS-2	0 - 0.8	0.0	15.7	84.3	2.56	13.61															ML	SILT, little sand, little clay, trace gravel	
PDI-SS-3	0 - 0.8	20.2	39.1	40.7	1.29	17.07	2.5			40	29	11	7.9					2.45			SM	SAND and SILT, some Gravel, trace clay	
PDI-SS-4	0 - 0.8	0.7	13.8	85.5	1.62	9.19															ML		
PDI-SS-5	0 - 0.8	0.0	14.9	85.1	1.57	8.01	2.3						9.2								ML	SILT, little clay, little sand	

Cu - Uniformity Coefficient

Cc - Coefficient of Gradation

*Based on gradation and atterberg limits

**Based on % content by weight

Reporting discrepancy

Questionable value

Calculated value

Below soft sediment

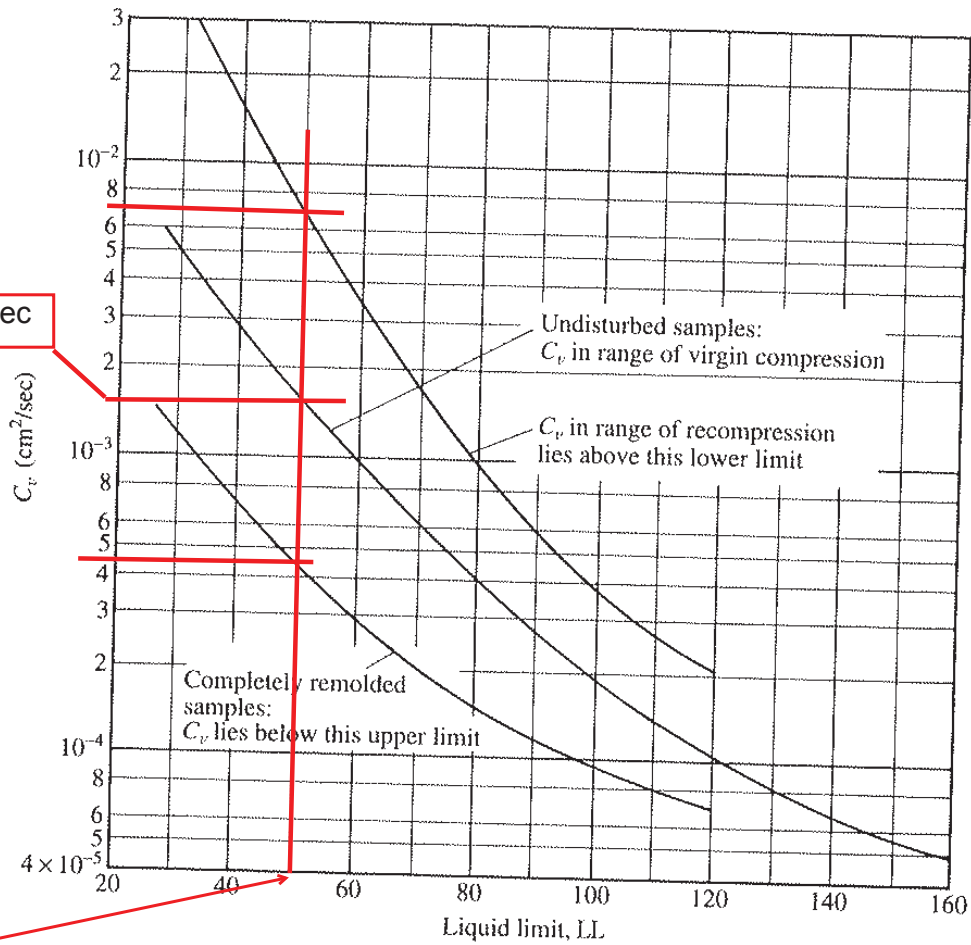

Figure 1.23 Range of C_v (after U.S. Department of the Navy, 1971)

The variation of U with T_v can be calculated from Eq. (1.65) and is plotted in Figure 1.24. Note that Eq. (1.65) and thus Figure 1.24 are also valid when an impermeable layer is located at the bottom of the clay layer (Figure 1.22). In that case, the dissipation of excess pore water pressure can take place in one direction only. The length of the *maximum drainage path* is then equal to $H = H_c$.

The variation of T_v with U shown in Figure 1.24 can also be approximated by

$$T_v = \frac{\pi}{4} \left(\frac{U\%}{100} \right)^2 \quad (\text{for } U = 0-60\%) \quad (1.66)$$

and

$$T_v = 1.781 - 0.933 \log (100 - U\%) \quad (\text{for } U > 60\%) \quad (1.67)$$

Sivaram and Swamee (1977) also developed an empirical relationship between T_v and U that is valid for U varying from 0 to 100%. The equation is of the form

Date Start/Finish: 3/29/11 Drilling Company: RDnP Driller's Name: Don Eger, Don Smith Drilling Method: HSA Casing Size: 4" ID Rig Type: Mobile B 4300 Track Rig Sampling Method: 2" Split Spoon / Osterberg, ASTM D1586/D158	Northing: 1832118.3 Easting: 1196495.4 Borehole Depth: 10' bss. Water Surface Elevation: 577.2' Descriptions By: Ron Kuhn / Pat Dougher	Well/Boring ID: CL-1 Client: Navistar, LLC Location: WSW South Slip, Chicago, IL <h1 style="text-align: center;">DRAFT</h1>
----------------------------------------------------------------------------------------------------------------------------------------------------------------------------------------------------------------------------------------------------------------------------------------------------	---------------------------------------------------------------------------------------------------------------------------------------------------------------------------------------------------	-----------------------------------------------------------------------------------------------------------------------------------------------------------------------

DEPTH	ELEVATION	Sample Run Number	Sample/Int/Type	Recovery (feet)	Blow Counts	N - Value	Geologic Column	Stratigraphic Description	Well/Boring Construction
-------	-----------	-------------------	-----------------	-----------------	-------------	-----------	-----------------	---------------------------	--------------------------

0								Brown SILT, trace fine sand, trace organics (leaves). MC = 1.7, OC = 11.5.	
565		Ponar	0'-0.8'	0.8	NA	NA			
		ST / Ost.	2'-4'	0.0 / 1.0	NA	NA		Brown SILT (rope in bottom of sample). First sample attempt was a shelby tube - no recovery; recovered sample using osterberg on second attempt. Cc = 1.7, Cu = 6.6, MC = 78.3, WD = 78.5, DD = 44.1.	
		Ost.	4'-6'	0.0	NA	NA		No recovery.	
5									
560		Ost.	6'-8'	0.0	NA	NA		No recovery.	
		2" SS	8'-10'	1.8	WOR WOR WOR WOR	0		Brown SILT, trace fine sand, trace intermittent brown NAPL. (Very Soft)	
10								Boring Terminated at 10.0' bss.	

Boring backfilled to sediment surface with 3 bags of bentonite chips.

 <i>Infrastructure · Water · Environment · Buildings</i>	Remarks: Modified Burmister classification system used. SS = split spoon; Ost. = osterberg sampler; bss = below sediment surface; NA = Not Applicable/Available; WOR = weight of rod; SAA = same as above; HSA = hollow stem auger; Cc = coefficient of gradation; Cu = uniformity coefficient; MC = moisture content (%); WD = wet density (pcf); DD = dry density (pcf); OC = organic content (%); LL = liquid limit; PL = plastic limit; PI = plasticity index; Su = undrained shear strength (psf) 140 lb auto hammer used. Water Depth (at time of drilling) = 11.0 ft.
------------------------------------------------------------------------------------------------------------------------------------------------	-------------------------------------------------------------------------------------------------------------------------------------------------------------------------------------------------------------------------------------------------------------------------------------------------------------------------------------------------------------------------------------------------------------------------------------------------------------------------------------------------------------------------------------------------------------------------------------------

Date Start/Finish: 3/30/11 Drilling Company: RDnP Driller's Name: Don Eger, Don Smith Drilling Method: HSA Casing Size: 4" ID Rig Type: Mobile B 4300 Track Rig Sampling Method: 2" Split Spoon / Osterberg, ASTM D1586/D158	Northing: 1832126.7 Easting: 1196879.7 Borehole Depth: 10' bss. Water Surface Elevation: 577.3' Descriptions By: Ron Kuhn / Pat Dougher	Well/Boring ID: CL-2 Client: Navistar, LLC Location: WSW South Slip, Chicago, IL <h1>DRAFT</h1>
----------------------------------------------------------------------------------------------------------------------------------------------------------------------------------------------------------------------------------------------------------------------------------------------------	---------------------------------------------------------------------------------------------------------------------------------------------------------------------------------------------------	-------------------------------------------------------------------------------------------------------------------------------------------

DEPTH	ELEVATION	Sample Run Number	Sample/Int/Type	Recovery (feet)	Blow Counts	N - Value	Geologic Column	Stratigraphic Description	Well/Boring Construction
-------	-----------	-------------------	-----------------	-----------------	-------------	-----------	-----------------	---------------------------	--------------------------

0								Dark brown SILT, trace fine sand, odor.	
5.60		Ponar	0'-0.8'	0.8	NA	NA			
		Ost.	2'-4'	2.0	NA	NA		Dark brown SILT. Cc = 0.8, Cu = 4.5, MC = 105.9, WD = 83.3, DD = 40.5, OC = 7.6	
		Ost.	4'-6'	2.0	NA	NA		SAA. MC = 80.8, WD = 84.4, DD = 46.7.	
5.55		2" SS	6'-8'	2.0	WOR WOR WOR	0		Dark brown SILT, trace fine gravel. (Very Soft) LL = 54, PL = 37, PI = 17.	
		Ost.	8'-10'	1.5	NA	NA		Dark brown SILT, trace medium gravel in bottom. Tube slightly bent on bottom. Cc = 1.2, Cu = 3.5, MC = 192.5, WD = 92.1, DD = 31.5.	
10								Boring terminated at 10.0' bss.	Boring backfilled to sediment surface with 3 bags of bentonite chips.

 <i>Infrastructure · Water · Environment · Buildings</i>	Remarks: Modified Burmister classification system used. SS = split spoon; Ost. = osterberg sampler; bss = below sediment surface; NA = Not Applicable/Available; WOR = weight of rod; SAA = same as above; HSA = hollow stem auger; Cc = coefficient of gradation; Cu = uniformity coefficient; MC = moisture content (%); WD = wet density (pcf); DD = dry density (pcf); OC = organic content (%); LL = liquid limit; PL = plastic limit; PI = plasticity index; Su = undrained shear strength (psf) 140 lb auto hammer used. Water Depth (at time of drilling) = 16.0 ft.
------------------------------------------------------------------------------------------------------------------------------------------------	-------------------------------------------------------------------------------------------------------------------------------------------------------------------------------------------------------------------------------------------------------------------------------------------------------------------------------------------------------------------------------------------------------------------------------------------------------------------------------------------------------------------------------------------------------------------------------------------

Date Start/Finish: 3/30/11 Drilling Company: RDnP Driller's Name: Don Eger, Don Smith Drilling Method: HSA Casing Size: 4" ID Rig Type: Mobile B 4300 Track Rig Sampling Method: 2" Split Spoon / Osterberg, ASTM D1586/D158	Northing: 1832051.9 Easting: 1196354.0 Borehole Depth: 10' bss. Water Surface Elevation: 577.1' Descriptions By: Ron Kuhn / Pat Dougher	Well/Boring ID: CL-3 Client: Navistar, LLC Location: WSW South Slip, Chicago, IL <h1 style="text-align: center;">DRAFT</h1>
----------------------------------------------------------------------------------------------------------------------------------------------------------------------------------------------------------------------------------------------------------------------------------------------------	---------------------------------------------------------------------------------------------------------------------------------------------------------------------------------------------------	-----------------------------------------------------------------------------------------------------------------------------------------------------------------------

DEPTH	ELEVATION	Sample Run Number	Sample/Int/Type	Recovery (feet)	Blow Counts	N - Value	Geologic Column	Stratigraphic Description	Well/Boring Construction
-------	-----------	-------------------	-----------------	-----------------	-------------	-----------	-----------------	---------------------------	--------------------------

0								Dark brown SILT, trace fine sand, trace sheen.	
570		Ponar	0'-0.8'	0.8		NA			
								Dark brown SILT. Cc = 0.5, Cu = 8.7, MC = 60.9, WD = 87.9, DD = 54.7.	
		Ost.	2'-4'	2.0		NA			
								Dark brown SILT, trace clay, odor. (Very Soft) Cc = 1.3, Cu = 6.2, MC = 2.7, OC = 18.3.	
5		2" SS	4'-6'	0.4		WOR WOR WOR WOR	0		
565								Dark brown SILT. Cc = 0.5, Cu = 4.9, MC = 68.5, WD = 86.7, DD = 51.4.	
		Ost.	6'-8'	2.0		NA			
								Dark brown SILT, fine sand on bottom. MC = 57.7, WD = 86.9, DD = 55.1.	
		Ost.	8'-10'	1.8		NA			
10								Boring terminated at 10.0' bss.	

Boring backfilled to sediment surface with 3 bags of bentonite chips.

 <i>Infrastructure · Water · Environment · Buildings</i>	Remarks: Modified Burmister classification system used. SS = split spoon; Ost. = osterberg sampler; bss = below sediment surface; NA = Not Applicable/Available; WOR = weight of rod; SAA = same as above; HSA = hollow stem auger; Cc = coefficient of gradation; Cu = uniformity coefficient; MC = moisture content (%); WD = wet density (pcf); DD = dry density (pcf); OC = organic content (%); LL = liquid limit; PL = plastic limit; PI = plasticity index; Su = undrained shear strength (psf) 140 lb auto hammer used. Water Depth (at time of drilling) = 6.0 ft.
------------------------------------------------------------------------------------------------------------------------------------------------	---------------------------------------------------------------------------------------------------------------------------------------------------------------------------------------------------------------------------------------------------------------------------------------------------------------------------------------------------------------------------------------------------------------------------------------------------------------------------------------------------------------------------------------------------------------------------------------------

Date Start/Finish: 3/30/11 Drilling Company: RDnP Driller's Name: Don Eger, Don Smith Drilling Method: HSA Casing Size: 4" ID Rig Type: Mobile B 4300 Track Rig Sampling Method: 2" Split Spoon / Osterberg, ASTM D1586/D158	Northing: 1831985.5 Easting: 1196493.3 Borehole Depth: 10' bss. Water Surface Elevation: 577.4' Descriptions By: Ron Kuhn / Pat Dougher	Well/Boring ID: CL-4 Client: Navistar, LLC Location: WSW South Slip, Chicago, IL <h1>DRAFT</h1>
----------------------------------------------------------------------------------------------------------------------------------------------------------------------------------------------------------------------------------------------------------------------------------------------------	---------------------------------------------------------------------------------------------------------------------------------------------------------------------------------------------------	-------------------------------------------------------------------------------------------------------------------------------------------

DEPTH	ELEVATION	Sample Run Number	Sample/Int/Type	Recovery (feet)	Blow Counts	N - Value	Geologic Column	Stratigraphic Description	Well/Boring Construction
-------	-----------	-------------------	-----------------	-----------------	-------------	-----------	-----------------	---------------------------	--------------------------

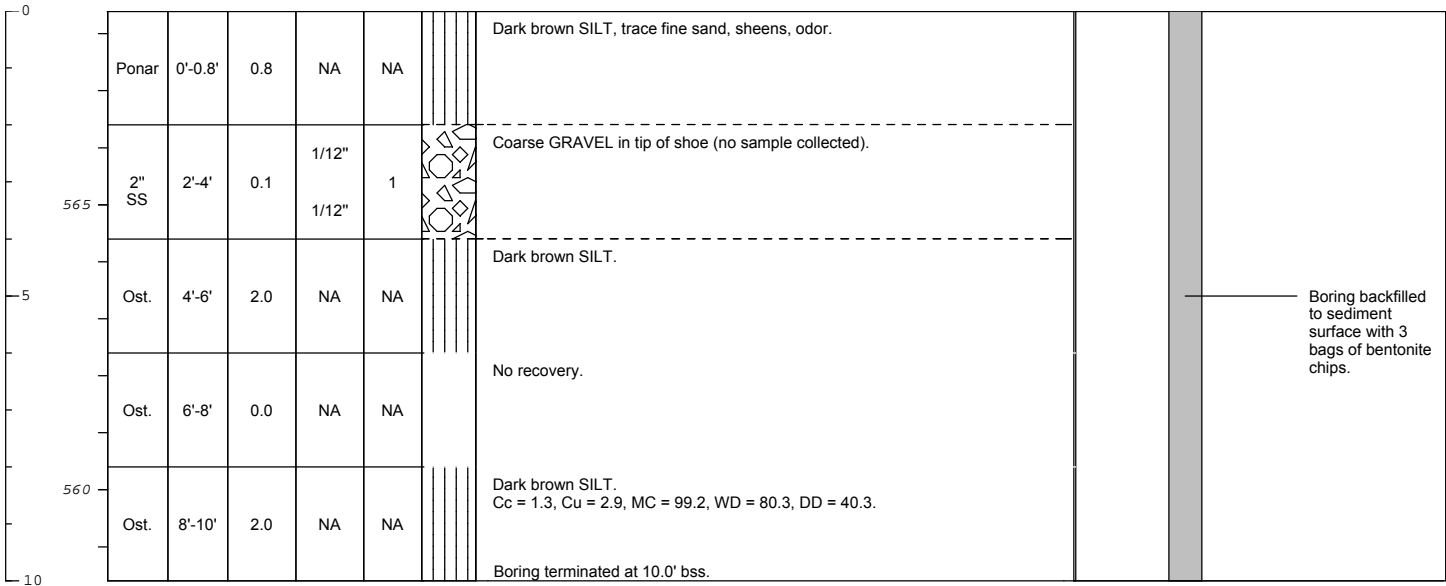

 <i>Infrastructure · Water · Environment · Buildings</i>	Remarks: Modified Burmister classification system used. SS = split spoon; Ost. = osterberg sampler; bss = below sediment surface; NA = Not Applicable/Available; WOR = weight of rod; SAA = same as above; HSA = hollow stem auger; Cc = coefficient of gradation; Cu = uniformity coefficient; MC = moisture content (%); WD = wet density (pcf); DD = dry density (pcf); OC = organic content (%); LL = liquid limit; PL = plastic limit; PI = plasticity index; Su = undrained shear strength (psf) 140 lb auto hammer used. Water Depth (at time of drilling) = 9.0 ft.
------------------------------------------------------------------------------------------------------------------------------------------------	---------------------------------------------------------------------------------------------------------------------------------------------------------------------------------------------------------------------------------------------------------------------------------------------------------------------------------------------------------------------------------------------------------------------------------------------------------------------------------------------------------------------------------------------------------------------------------------------

Date Start/Finish: 3/29/11 Drilling Company: RDnP Driller's Name: Don Eger, Don Smith Drilling Method: HSA Casing Size: 4" ID Rig Type: Mobile B 4300 Track Rig Sampling Method: 2" Split Spoon / Osterberg, ASTM D1586/D158	Northing: 1832041.8 Easting: 1196645.4 Borehole Depth: 10' bss. Water Surface Elevation: 577.5' Descriptions By: Ron Kuhn / Pat Dougher	Well/Boring ID: CL-5 Client: Navistar, LLC Location: WSW South Slip, Chicago, IL <h1 style="text-align: center;">DRAFT</h1>
----------------------------------------------------------------------------------------------------------------------------------------------------------------------------------------------------------------------------------------------------------------------------------------------------	---------------------------------------------------------------------------------------------------------------------------------------------------------------------------------------------------	-----------------------------------------------------------------------------------------------------------------------------------------------------------------------

DEPTH	ELEVATION	Sample Run Number	Sample/Int/Type	Recovery (feet)	Blow Counts	N - Value	Geologic Column	Stratigraphic Description	Well/Boring Construction
-------	-----------	-------------------	-----------------	-----------------	-------------	-----------	-----------------	---------------------------	--------------------------

0								Brown SILT, trace fine sand.	
	560	Ponar	0'-0.8'	0.8	NA	NA			
		Ost.	2'-4'	2.0	NA	NA		Dark brown SILT, trace fine sand. Bentonite in top of sample from bentonite bridging in augers from previous boring. MC = 38.6, WD = 107.0, DD = 77.2.	
	5	Ost.	4'-6'	2.0	NA	NA		Dark brown SILT, sheens. Cc = 0.9, Cu = 3.7, MC = 74.3, WD = 86.7, DD = 49.8.	
	555	Ost.	6'-8'	0.0	NA	NA		Osterberg sample attempted from 6' to 8' bss. - no recovery.	
		2" SS	8'-10'	2.0	WOR WOR WOR WOR	0		Dark brown SILT, sheens. (Very Soft)	
10								Boring terminated at 10.0' bss.	Boring backfilled to sediment surface with 3 bags of bentonite chips.

 <i>Infrastructure · Water · Environment · Buildings</i>	Remarks: Modified Burmister classification system used. SS = split spoon; Ost. = osterberg sampler; bss = below sediment surface; NA = Not Applicable/Available; WOR = weight of rod; SAA = same as above; HSA = hollow stem auger; Cc = coefficient of gradation; Cu = uniformity coefficient; MC = moisture content (%); WD = wet density (pcf); DD = dry density (pcf); OC = organic content (%); LL = liquid limit; PL = plastic limit; PI = plasticity index; Su = undrained shear strength (psf) 140 lb auto hammer used. Water Depth (at time of drilling) = 16.0 ft.
------------------------------------------------------------------------------------------------------------------------------------------------	-------------------------------------------------------------------------------------------------------------------------------------------------------------------------------------------------------------------------------------------------------------------------------------------------------------------------------------------------------------------------------------------------------------------------------------------------------------------------------------------------------------------------------------------------------------------------------------------

Calculation Sheet

Client: Navistar, Inc.

Project: CI000664.0037.00001

Prepared by: GRM

Date: 05/10/12

Title: South Slip Sediment Cap Design, Former Wisconsin Steel Works

Reviewed By: APC

Date: 05/11/12

Subject: Slope Stability of Southern Slope – Cap / Fill Design

OBJECTIVE: Evaluate the slope stability of the southern slope with the cap design in the South Slip.

REFERENCES:

1. Das, Braja M. *Principles of Geotechnical Engineering: Sixth Edition*. Thompson. Toronto, Canada. 2006.
2. U.S. Army Corps of Engineers. *Design of Sheet Pile Walls*, Manual No. 1110-2-2504, March 1994.
3. SLOPE/W Version 7.14, Geo-Slope International Ltd. Calgary, Alberta, Canada.
4. Julien, Pierre. *Erosion and Sedimentation*. Cambridge University Press. Cambridge, United Kingdom. 1998.

ASSUMPTIONS:

1. The critical slope is anticipated to be along the southern edge of the slip. The geometry of this slope is approximated from the bathymetric data presented in the attached Figure D2-1 and Sections B-B' and C-C'.
2. The water surface in the slip is at elevation 577.9 ft. The phreatic surface in the soils adjacent to the slip is also at elevation 577.9 ft.
3. The soft sediments encountered at the slip are primarily elastic silt (MH). The profile of the base of the sediment has been interpolated between boring and probing data obtained during the March 2011 site investigation. The soil parameters for the soft sediment were estimated based on the lab testing performed on the geotechnical samples collected, and from typical drained properties of silt (Reference 1).
4. The underlying consolidated sediment at the slip is comprised of hard silt and clay with significantly smaller fractions of sand. The parameters used for the underlying sediments are based on soil descriptions and N-values obtained during the site investigation performed in March 2011, and typical very stiff to hard silt and clay sediment parameters

Calculation Sheet

(References 1 and 2). Because strength data for the underlying consolidated sediment was not generated during the March 2011 site investigation, an estimated shear strength value of 4,000 psf was used in the stability analyses.

5. The slopes in the southern portion of the slip will be filled and graded such that the maximum slope after construction is 2H:1V. Fill used to achieve these slopes will be clean sand.
6. At the east end of the slip, the cap will be tapered beyond the limit of the cap into existing grade prior to the navigation channel.
7. A 1.5' thick cap is placed over the soft sediments/fill. This cap is comprised of 1.0' clean sand mixed with 2% TOC, and 0.5' of 2" D50 aggregate. The parameters used for the sand and aggregate are estimated based on engineering experience.
8. The friction angles for the soft sediment and consolidated sediment are estimated to represent median values for consolidated, fine grained materials.
9. Soil parameters used in this evaluation are provided in the table below:

Material	γ_{sat} (pcf)	c (psf)	Φ (°)
Soft Sediment (MH)	99	120	30
Sediment	137.5	4000 - 7500	30
Sand Cap	125	0	32
2" D50 Aggregate	135	0	40

CALCULATIONS:

Slope stability analyses were performed using the computer program Slope/W by Geo-Slope. Slope/W uses a limit equilibrium wedge method for analysis to solve for slope stability by balancing both the driving and resisting forces to determine a factor of safety along a potential failure surface. The Spencer method was used by Slope/W to perform this analysis. Circular failure surfaces were examined.

The stability of the South Slope was examined for both drained and undrained conditions in the existing, intermediate (during construction), and completed stages. Based on the above assumptions and analysis methods, the following factors of safety were calculated for slope stability (see attached for Slope/W results):

Calculation Sheet

	Geometry	Analysis	Failure Depth	FOS
Section B-B'	Existing	Drained	Surface	0.47
			Deep	0.71
		Undrained	--	2.13
	Intermediate / During Construction	Drained	Surface	1.21
			Deep	1.32
		Undrained	Surface	1.21
			Deep	1.60
	Completed	Drained	Surface	1.28
			Deep	1.34
		Undrained	Surface	1.28
			Deep	1.47
	Section C-C'	Existing	Drained	Surface
Deep				1.73
Undrained			--	2.34
Intermediate / During Construction		Drained	Surface	1.25
			Deep	1.42
		Undrained	Surface	1.25
			Deep	1.49
Completed		Drained	Surface	1.32
			Deep	1.48
		Undrained	Surface	1.33
			Deep	1.40

FOS = Factor of Safety

These results, and the corresponding output sheets from Slope/W, indicate that slope instability is rooted in the proposed cap materials and soft sediments within the slip, not the underlying consolidated material.

The low factors of safety for the drained case and the existing slope geometry (0.47 – 1.73) suggest that the slope should not be stable (orange cells). These results are thought to represent the existing slopes too conservatively. Cohesion is likely to be acting in the soft sediment; a component of strength which is not represented in the drained case. This hypothesis is supported by the observation that the slopes exist in their current state.

The factors of safety against failure for the intermediate and completed slopes suggest that failure is more likely to occur in the cap materials (blue cells and green cells) than in the

Calculation Sheet

underlying soft sediments. This result is further supported through consideration of the angle of repose for sand. A submerged granular material has an angle of repose between 30 and 42 degrees (Julien 1998). The proposed 2H:1V slope (26.6 degrees from horizontal) is approaching the lower bound of the angle of repose. It is anticipated that the larger particles of the 2" D50 material will have a higher angle of repose than the sand.

To minimize the risk of sloughing in the placed sand fill, it is recommended that a medium to coarse grained, angular sand be used. The interlocking nature of the angular particles will increase the inter-particle friction while the larger grain size will reduce the effects of porewater during placement.

Based on the calculated factors of safety, periodic maintenance may become necessary, due to adjustment of the cap, depending on influence of barge traffic and other uses of the slip, effects of storm events, and other factors that involve influences that fall outside the assumptions of the cap stability analysis. It should be noted that institutional and engineering controls (e.g., use restrictions as well as restrictions on anchoring, dredging, development, and other activities that have the potential to disturb the sediment cap) will be implemented to provide long-term mechanisms to protect the constructed sediment cap from the influence of barge traffic and other uses of the slip or other factors that involve influences that fall outside the assumptions of the cap stability analysis, and it is therefore unlikely that maintenance will be necessary.

At the east end of the slip, the cap will taper beyond the limits of the 1.5-foot cap into the existing grade at a 2H:1V slope, and will intersect the existing grade a minimum of 50 feet prior to the steep slope at the mouth of the channel, and therefore will not affect the current stability of this area (Design Drawing 2, Appendix B). Therefore a stability evaluation was not performed at the mouth of the channel. The tapered area will also incorporate the protective stone layer, which will further improve the stability of this tapered portion on the east end of the slip.

Existing Slope Section B-B'

Drained Soil Parameters

Surface Failure

Name: Soft Sediment (Drained)
Model: Mohr-Coulomb
Unit Weight: 99 pcf
Cohesion: 0 psf
Phi: 30 °

Name: Consolidated Sediment (Drained - Low)
Model: Mohr-Coulomb
Unit Weight: 137.5 pcf
Cohesion: 0 psf
Phi: 30 °

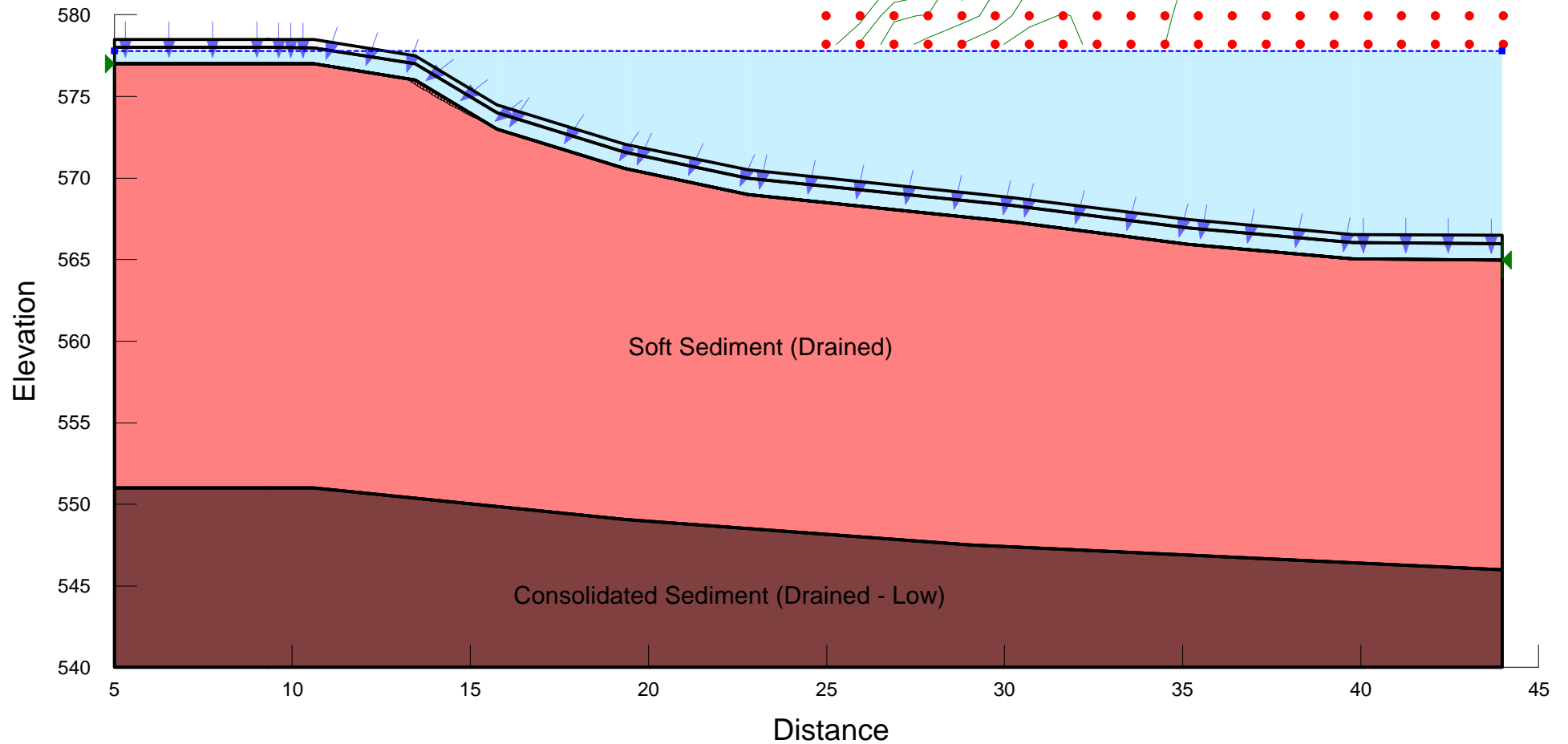

Existing Slope Section B-B'

Drained Soil Parameters

Deep Failure

Name: Soft Sediment (Drained)
Model: Mohr-Coulomb
Unit Weight: 99 pcf
Cohesion: 0 psf
Phi: 30 °

Name: Consolidated Sediment (Drained - Low)
Model: Mohr-Coulomb
Unit Weight: 137.5 pcf
Cohesion: 0 psf
Phi: 30 °

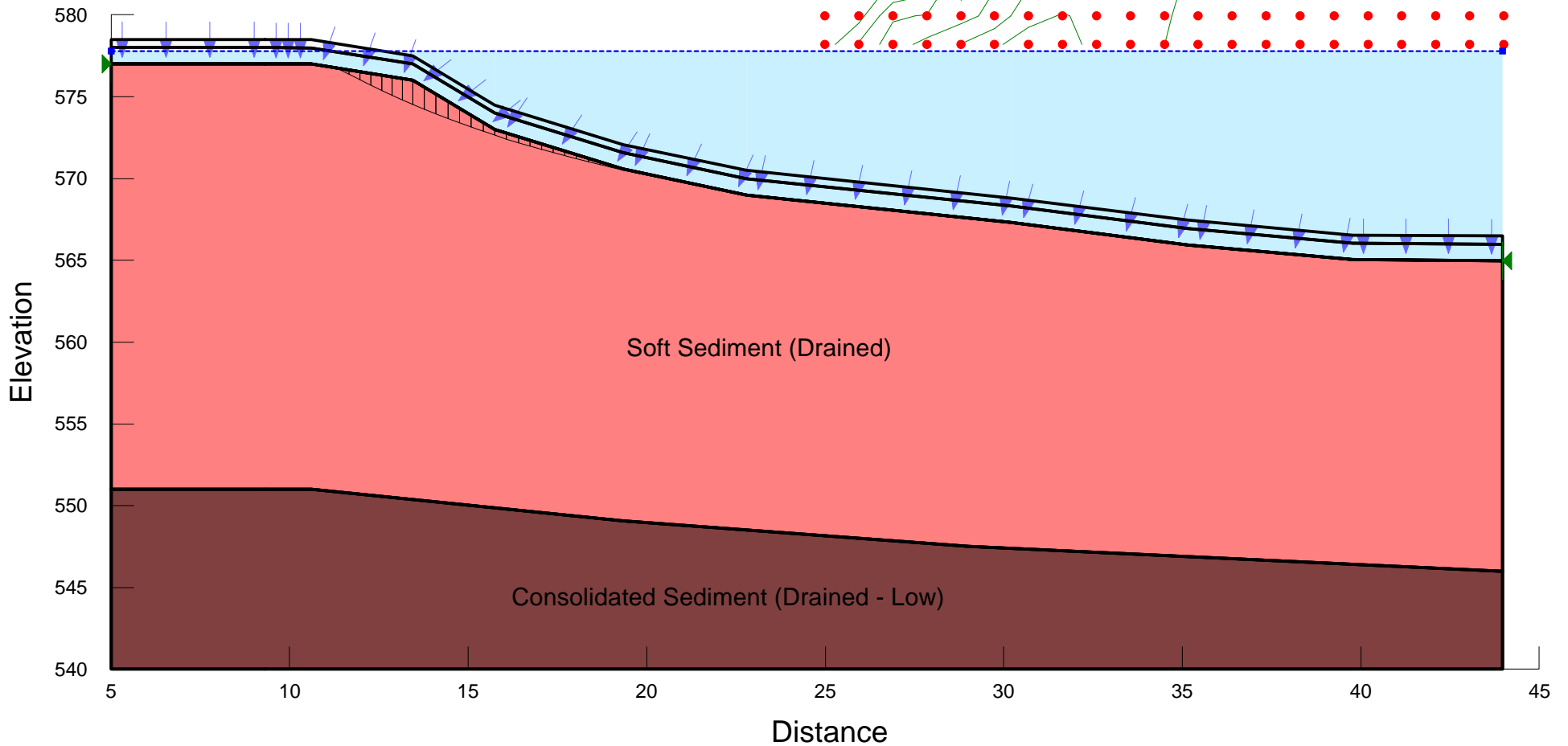

Existing Slope Section B-B'

Undrained Soil Parameters

Name: Soft Sediment (Undrained) Model: Mohr-Coulomb Unit Weight: 99 pcf Cohesion: 120 psf Phi: 0 °
Name: Consolidated Sediment (Undrained - Low) Model: Mohr-Coulomb Unit Weight: 137.5 pcf Cohesion: 4000 psf Phi: 0 °

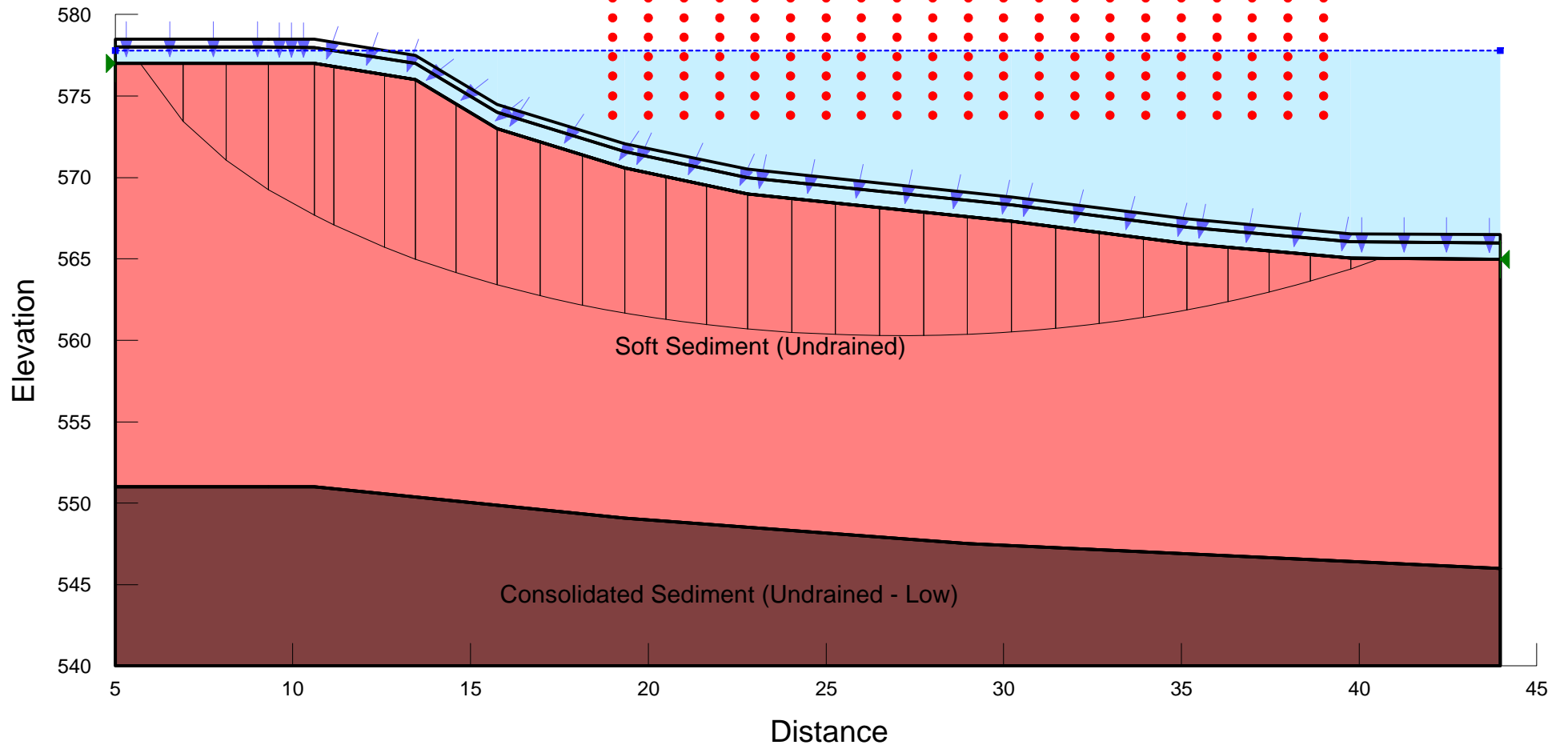
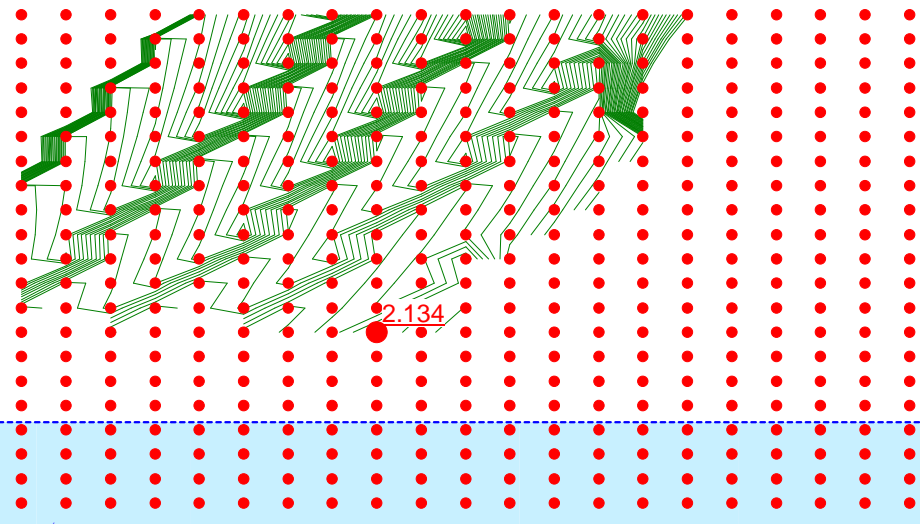

Intermediate Filled Slope Section B-B' Drained Soil Parameters Surface Failure

Name: Soft Sediment (Drained)
Model: Mohr-Coulomb
Unit Weight: 99 pcf
Cohesion: 0 psf
Phi: 30 °

Name: Sand Cap
Model: Mohr-Coulomb
Unit Weight: 125 pcf
Cohesion: 0 psf
Phi: 32 °

Name: Consolidated Sediment (Drained - Low)
Model: Mohr-Coulomb
Unit Weight: 137.5 pcf
Cohesion: 0 psf
Phi: 30 °

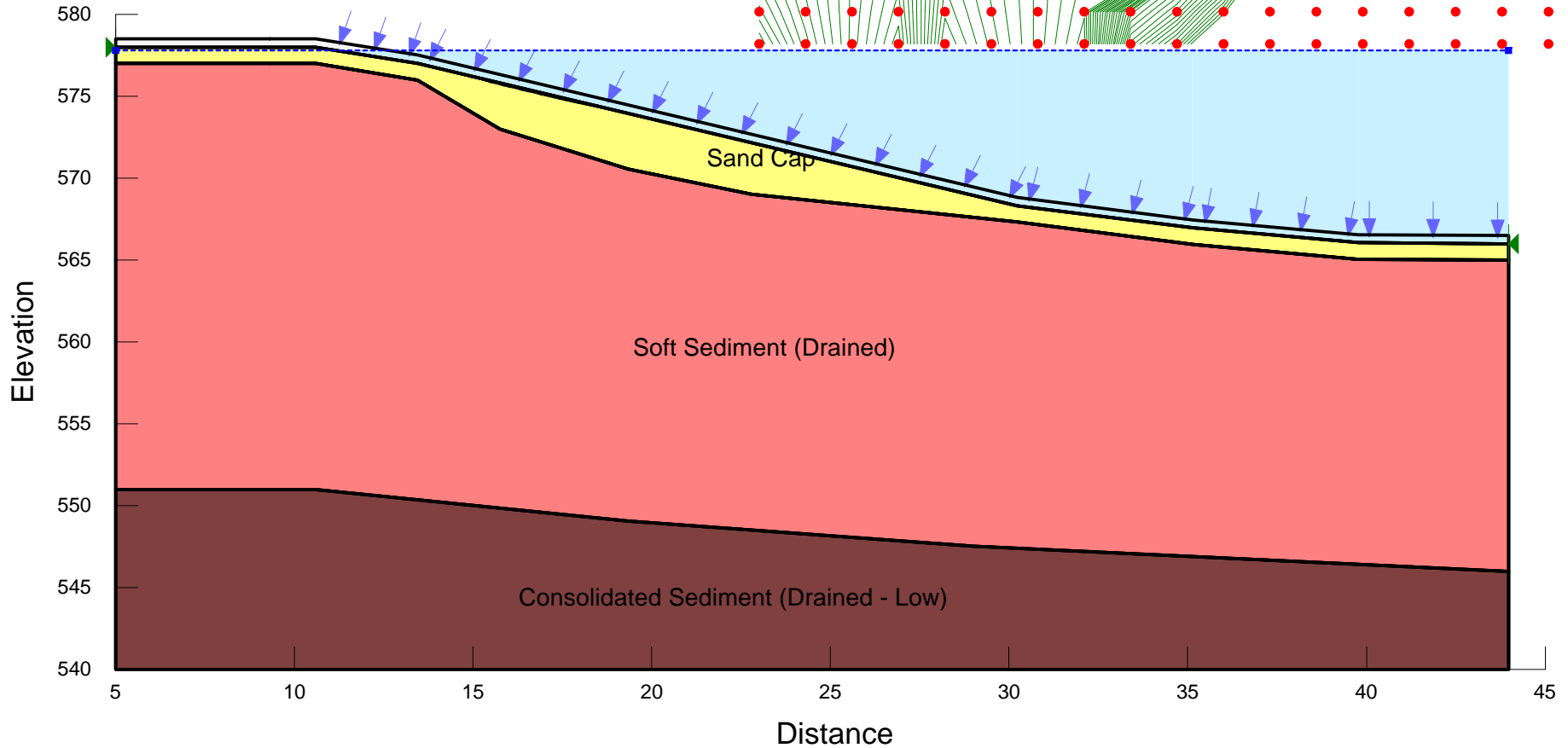

Intermediate Filled Slope Section B-B' Drained Soil Parameters Deep Failure

Name: Soft Sediment (Drained)
Model: Mohr-Coulomb
Unit Weight: 99 pcf
Cohesion: 0 psf
Phi: 30 °

Name: Sand Cap
Model: Mohr-Coulomb
Unit Weight: 125 pcf
Cohesion: 0 psf
Phi: 32 °

Name: Consolidated Sediment (Drained - Low)
Model: Mohr-Coulomb
Unit Weight: 137.5 pcf
Cohesion: 0 psf
Phi: 30 °

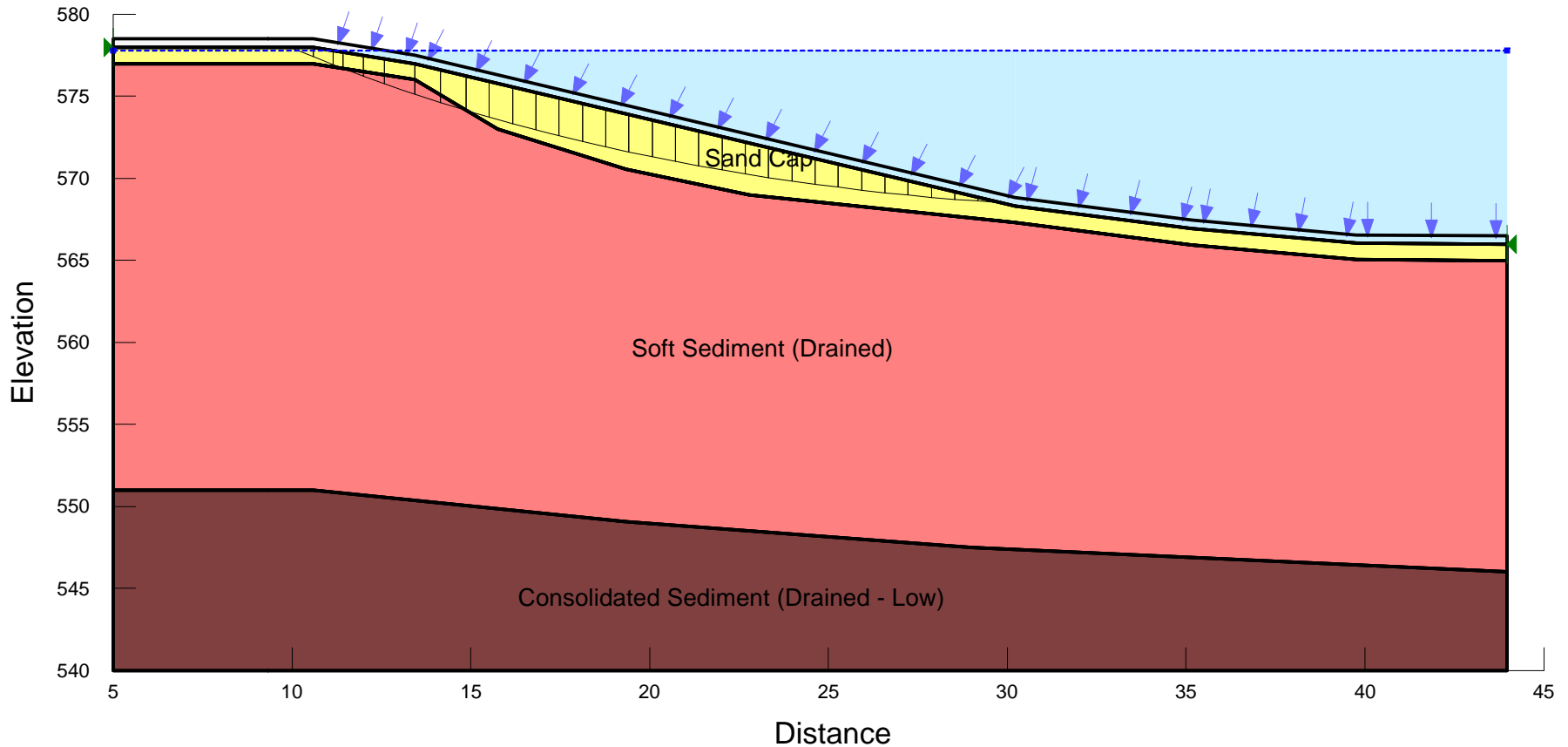
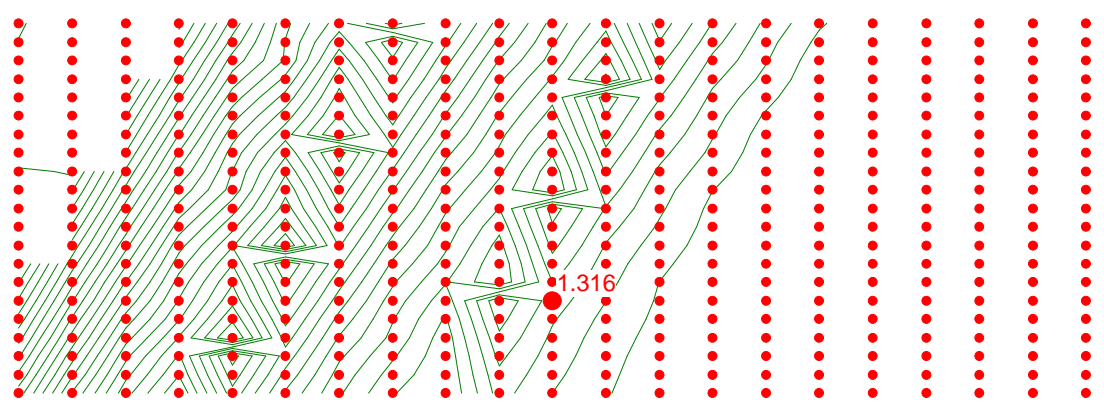

Intermediate Filled Slope Section B-B'

Undrained Soil Parameters

Surface Failure

Name: Soft Sediment (Undrained) Model: Mohr-Coulomb Unit Weight: 99 pcf Cohesion: 120 psf Phi: 0 °
Name: Sand Cap Model: Mohr-Coulomb Unit Weight: 125 pcf Cohesion: 0 psf Phi: 32 °
Name: Consolidated Sediment (Undrained - Low) Model: Mohr-Coulomb Unit Weight: 137.5 pcf Cohesion: 4000 psf Phi: 0 °

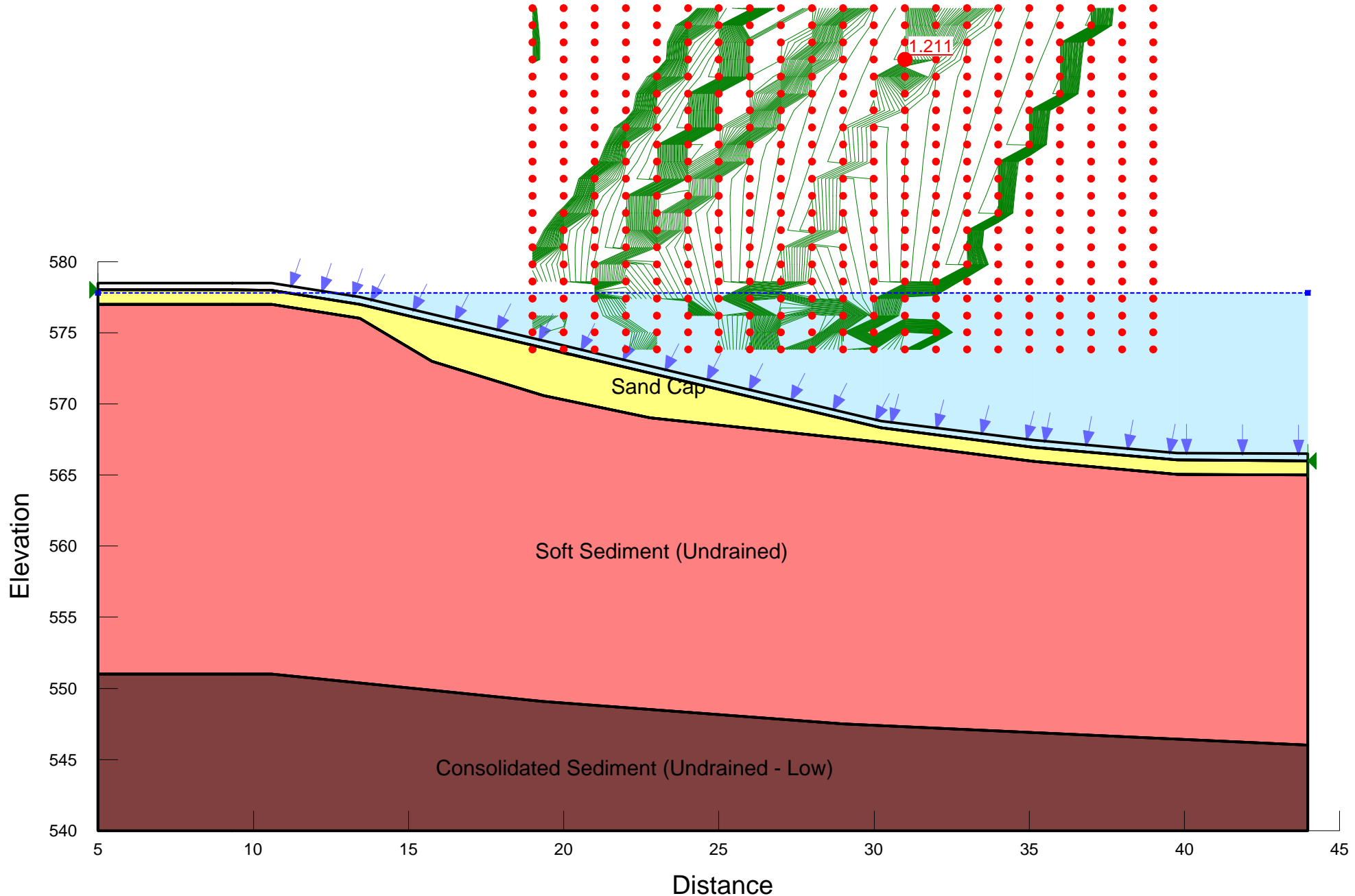

Intermediate Filled Slope Section B-B'

Undrained Soil

Deep Failure

Name: Soft Sediment (Undrained) Model: Mohr-Coulomb Unit Weight: 99 pcf Cohesion: 120 psf Phi: 0 °
Name: Sand Cap Model: Mohr-Coulomb Unit Weight: 125 pcf Cohesion: 0 psf Phi: 32 °
Name: Consolidated Sediment (Undrained - Low) Model: Mohr-Coulomb Unit Weight: 137.5 pcf Cohesion: 4000 psf Phi: 0 °

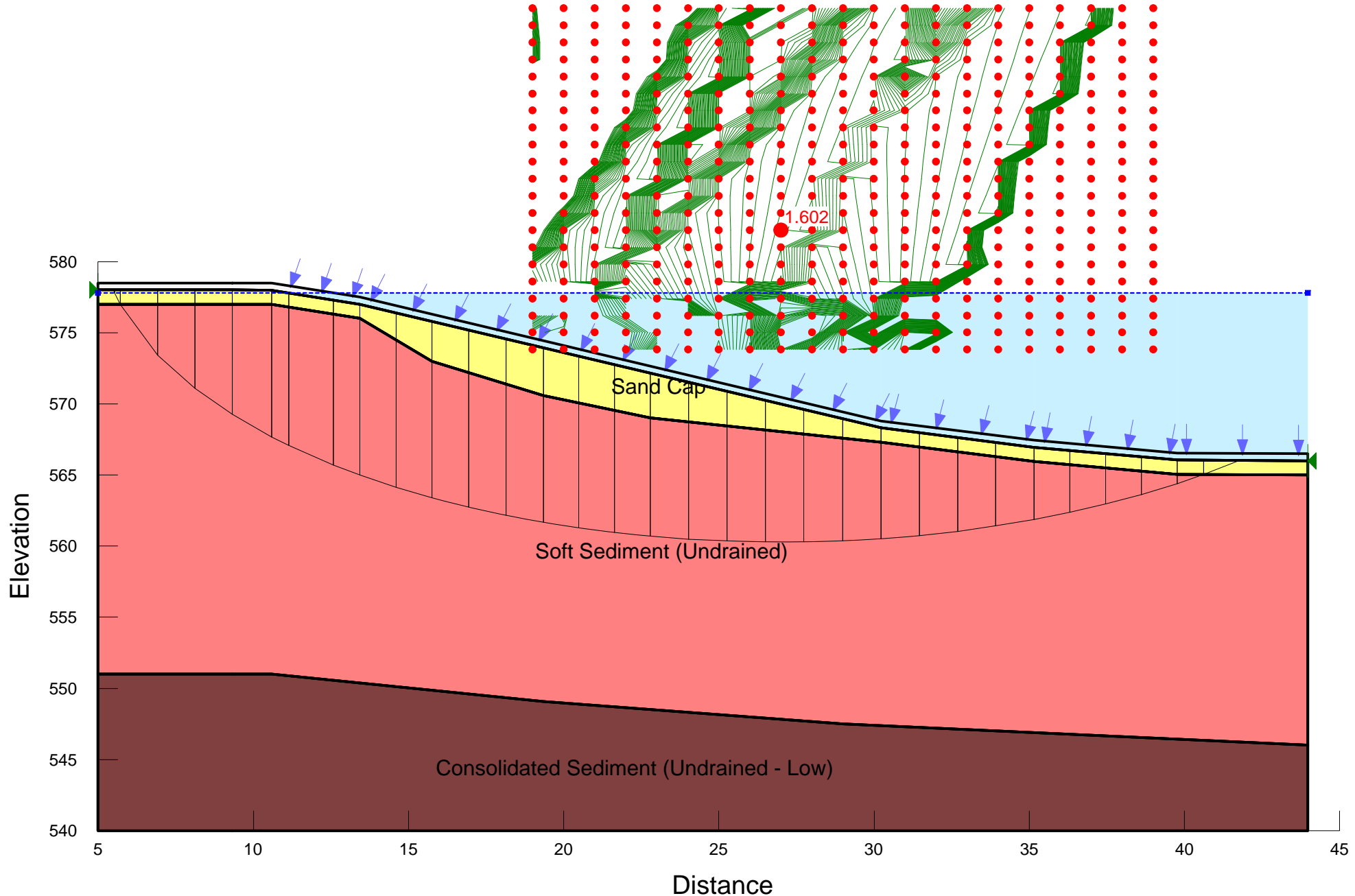

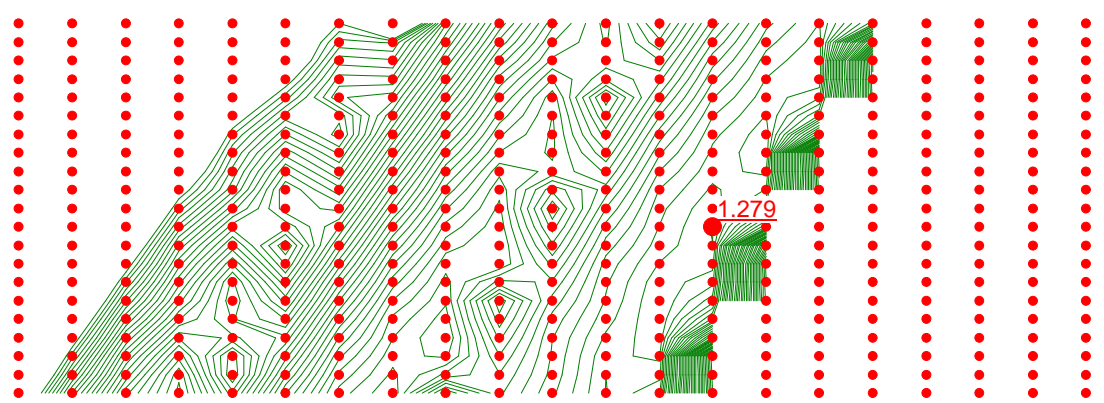

Constructed Slope Section B-B'
Drained Soil Parameters
Surface Failure

Name: Soft Sediment (Drained) Model: Mohr-Coulomb Unit Weight: 99 pcf Cohesion: 0 psf Phi: 30 °
 Name: Gravel Cap Model: Mohr-Coulomb Unit Weight: 135 pcf Cohesion: 0 psf Phi: 40 °
 Name: Sand Cap Model: Mohr-Coulomb Unit Weight: 125 pcf Cohesion: 0 psf Phi: 32 °
 Name: Consolidated Sediment (Drained - Low) Model: Mohr-Coulomb Unit Weight: 137.5 pcf Cohesion: 0 psf Phi: 30 °

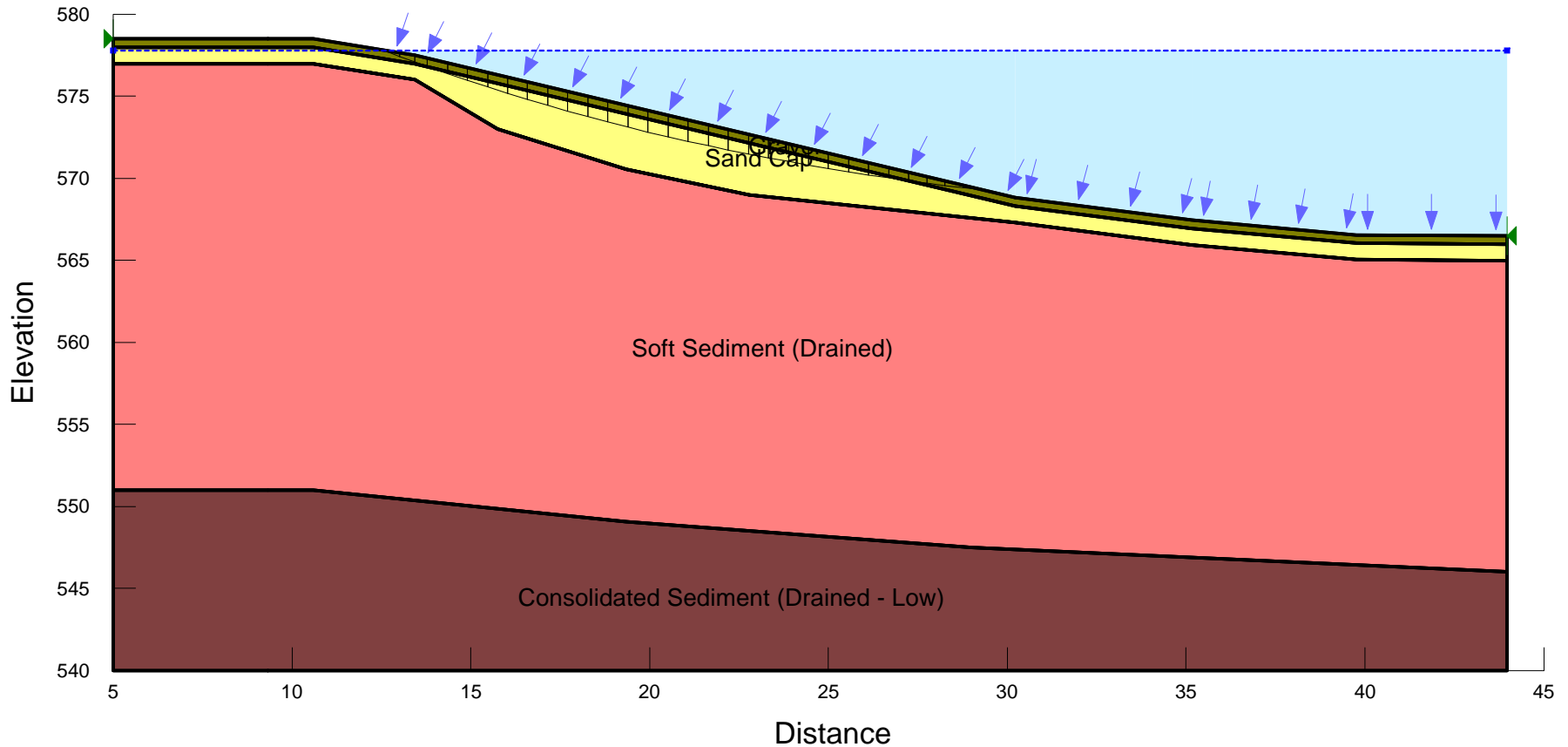

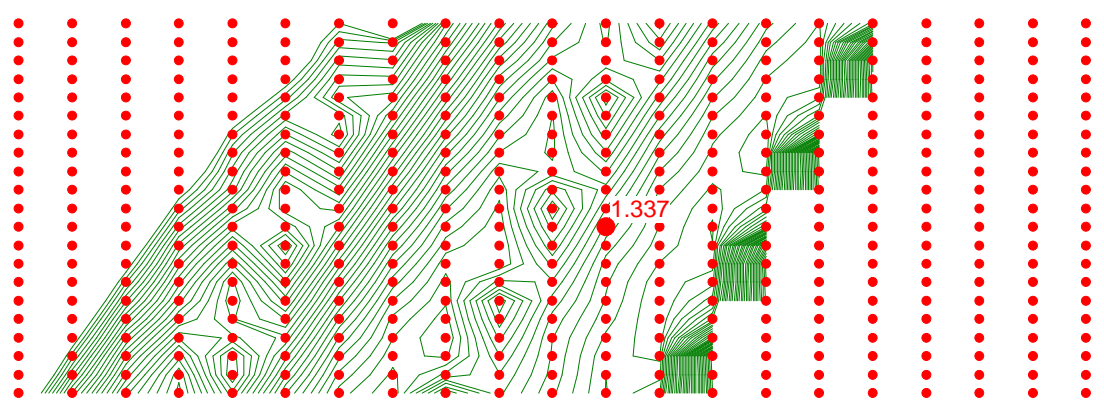

Constructed Slope Section B-B'
Drained Soil Parameters
Deep Failure

Name: Soft Sediment (Drained) Model: Mohr-Coulomb Unit Weight: 99 pcf Cohesion: 0 psf Phi: 30 °
 Name: Gravel Cap Model: Mohr-Coulomb Unit Weight: 135 pcf Cohesion: 0 psf Phi: 40 °
 Name: Sand Cap Model: Mohr-Coulomb Unit Weight: 125 pcf Cohesion: 0 psf Phi: 32 °
 Name: Consolidated Sediment (Drained - Low) Model: Mohr-Coulomb Unit Weight: 137.5 pcf Cohesion: 0 psf Phi: 30 °

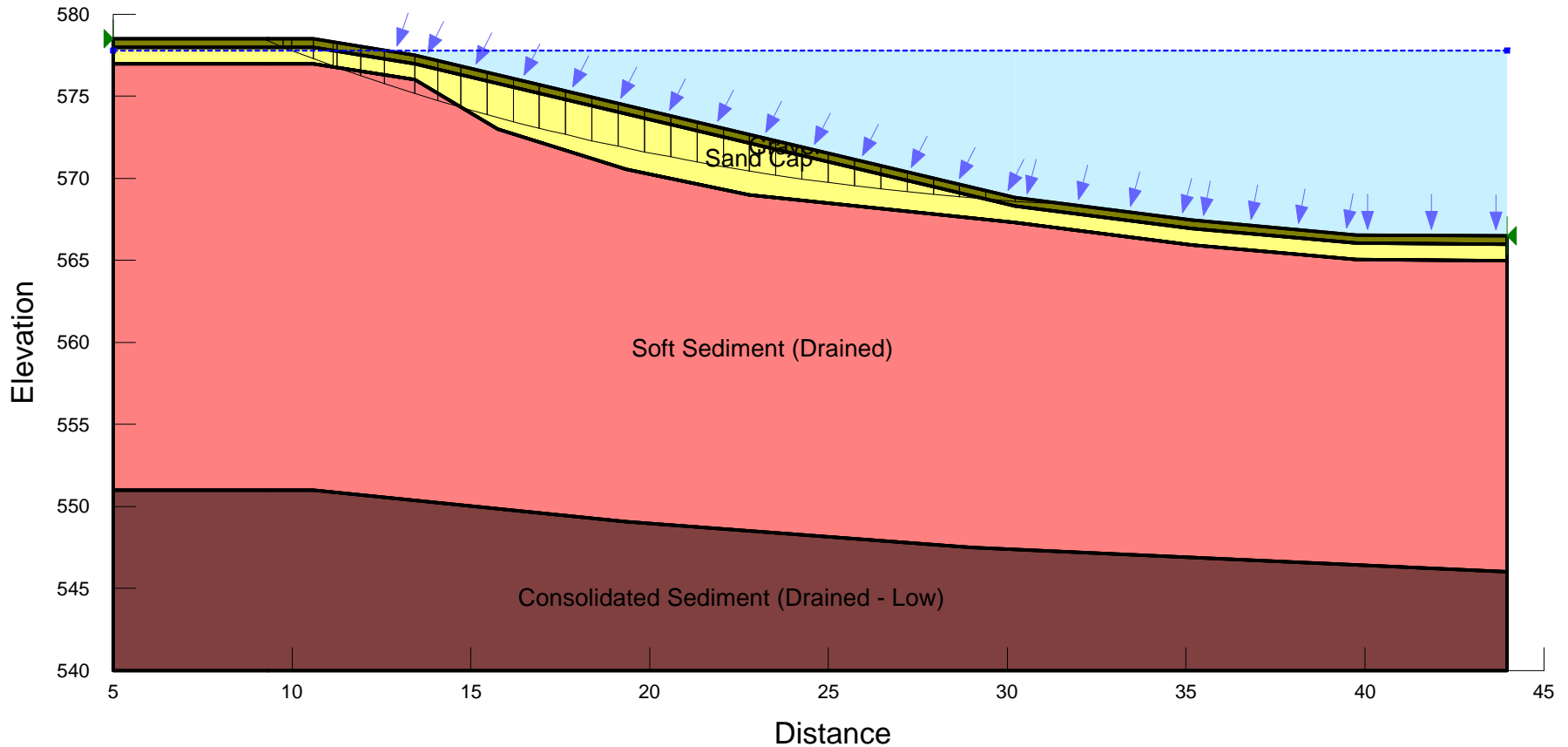

Constructed Slope Section B-B' Undrained Soil Surface Failure

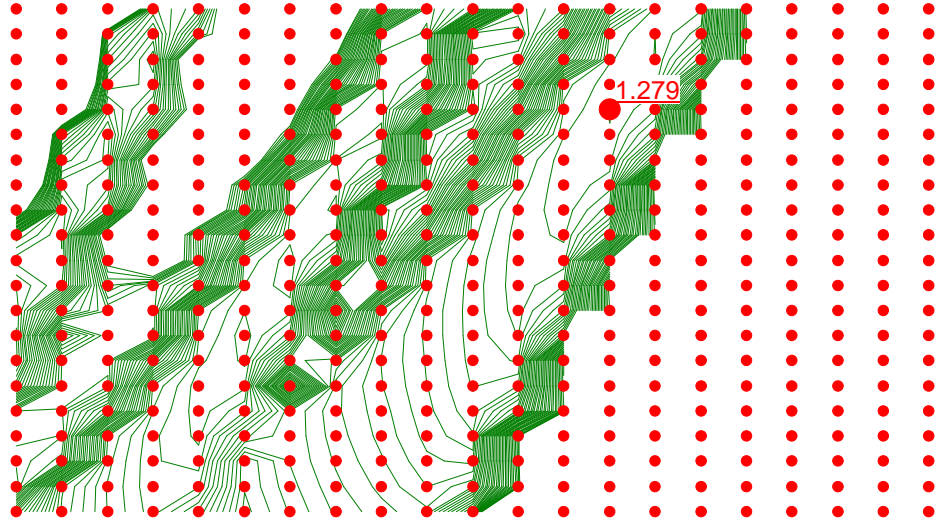

Name: Soft Sediment (Undrained) Model: Mohr-Coulomb Unit Weight: 99 pcf Cohesion: 120 psf Phi: 0 °
 Name: Gravel Cap Model: Mohr-Coulomb Unit Weight: 135 pcf Cohesion: 0 psf Phi: 40 °
 Name: Sand Cap Model: Mohr-Coulomb Unit Weight: 125 pcf Cohesion: 0 psf Phi: 32 °
 Name: Consolidated Sediment (Undrained - Low) Model: Mohr-Coulomb Unit Weight: 137.5 pcf Cohesion: 4000 psf Phi: 0 °

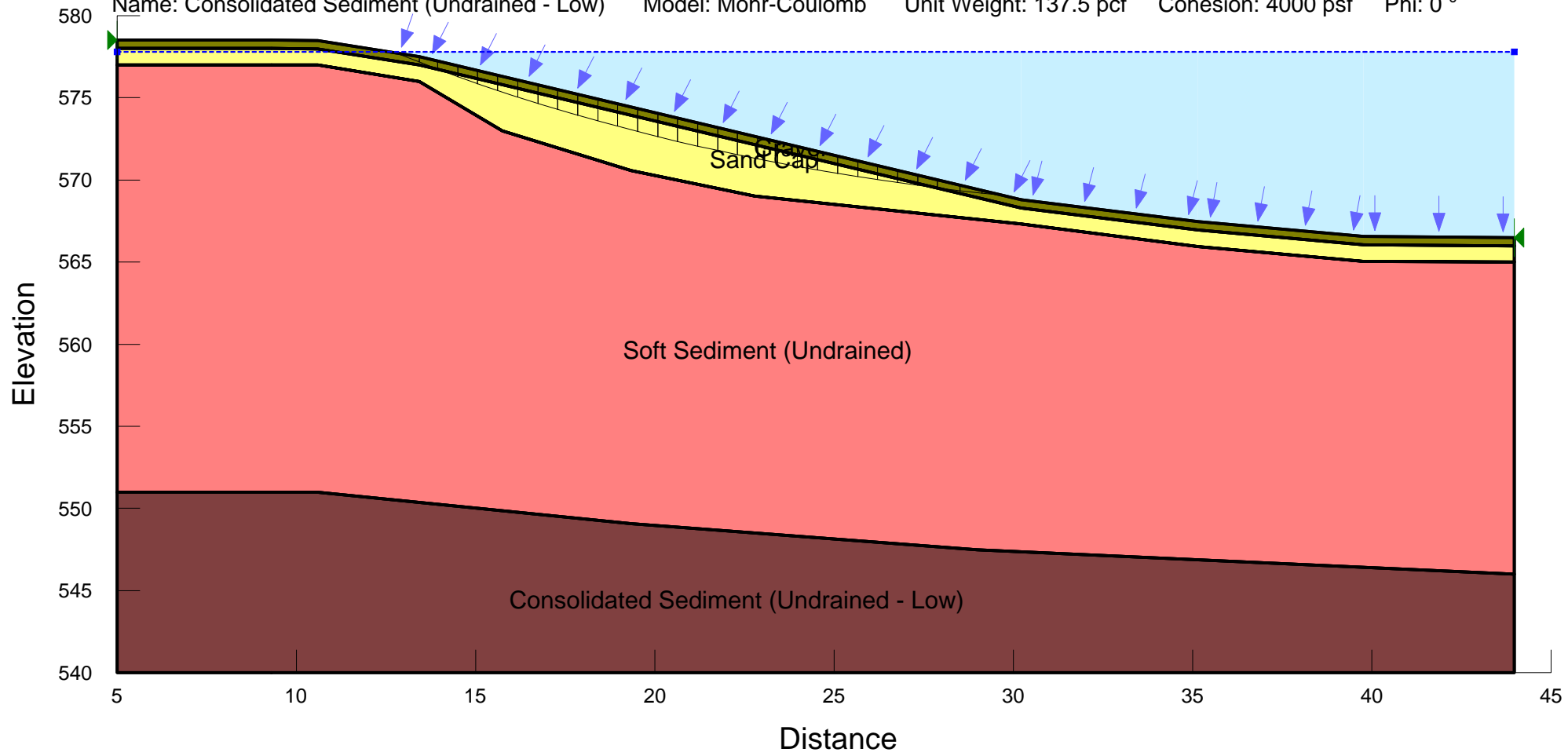

Constructed Slope Section B-B'

Undrained Soil

Deep Failure

Name: Soft Sediment (Undrained) Model: Mohr-Coulomb Unit Weight: 99 pcf Cohesion: 120 psf Phi: 0 °
Name: Gravel Cap Model: Mohr-Coulomb Unit Weight: 135 pcf Cohesion: 0 psf Phi: 40 °
Name: Sand Cap Model: Mohr-Coulomb Unit Weight: 125 pcf Cohesion: 0 psf Phi: 32 °
Name: Consolidated Sediment (Undrained - Low) Model: Mohr-Coulomb Unit Weight: 137.5 pcf Cohesion: 4000 psf Phi: 0 °

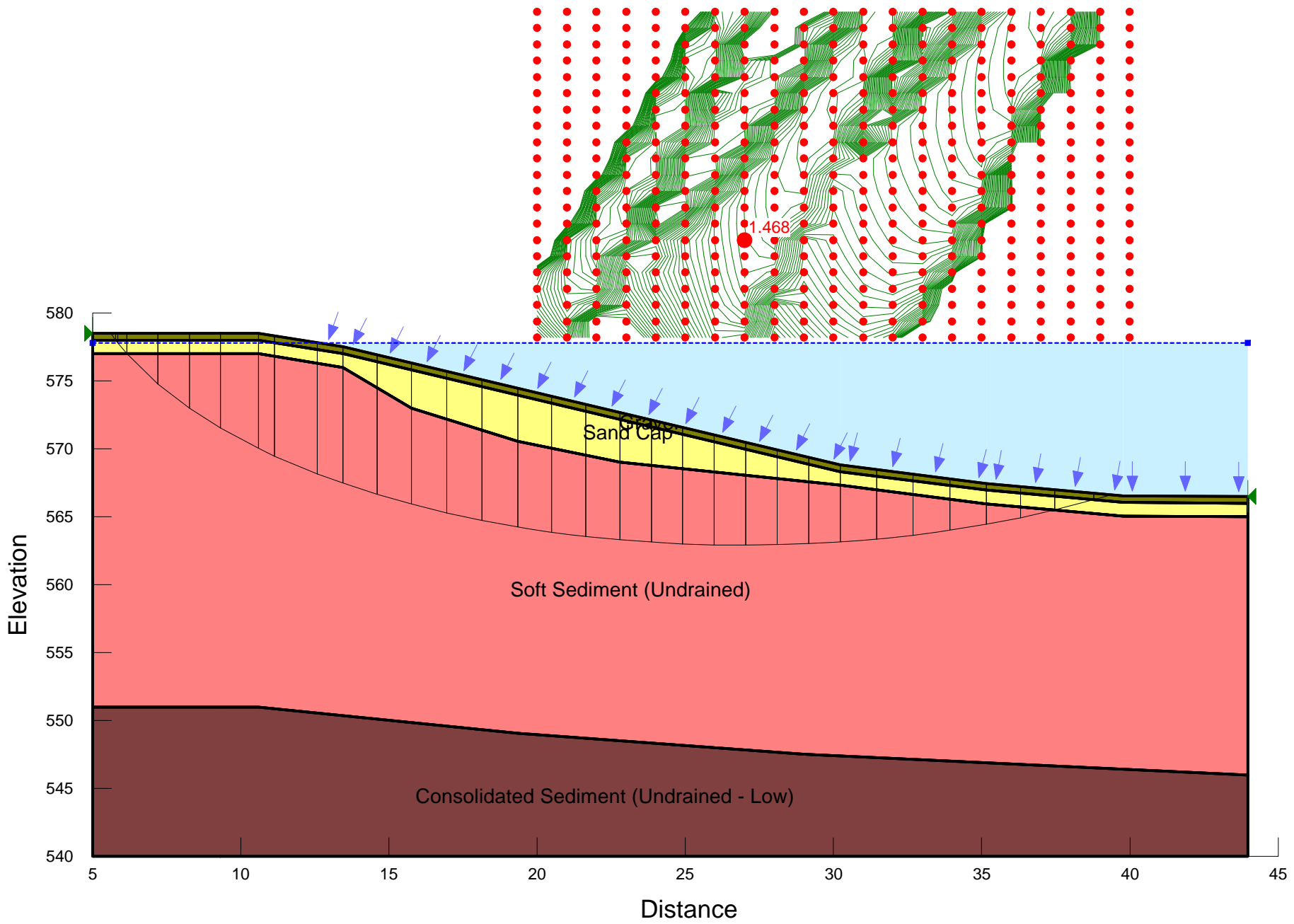

Existing Slope Section C-C'

Drained Soil Parameters

Surface Failure

Name: Soft Sediment (Drained)
Model: Mohr-Coulomb
Unit Weight: 99 pcf
Cohesion: 0 psf
Phi: 30 °

Name: Consolidated Sediment (Drained - Low)
Model: Mohr-Coulomb
Unit Weight: 137.5 pcf
Cohesion: 0 psf
Phi: 30 °

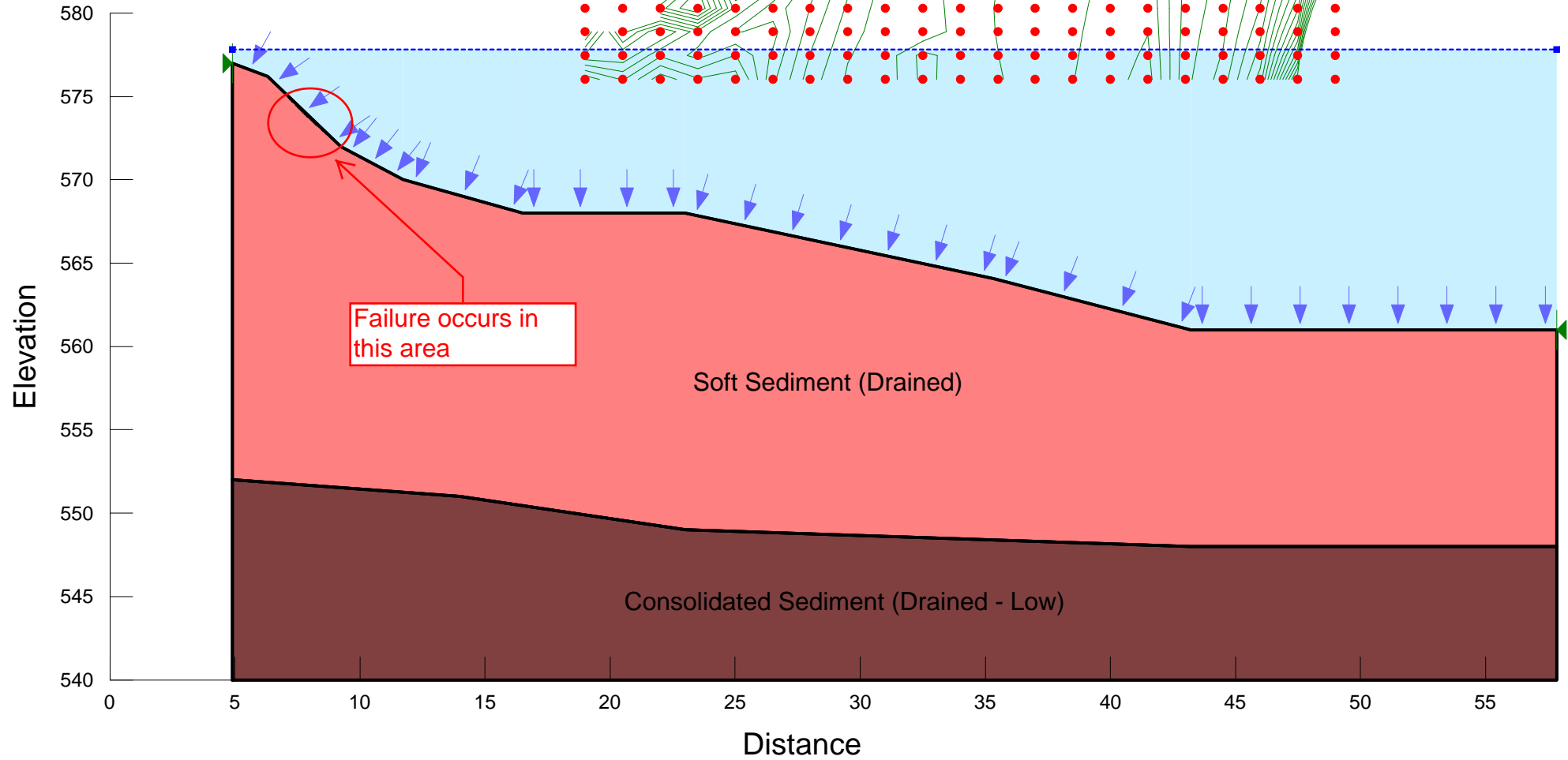

Existing Slope Section C-C'

Drained Soil Parameters

Deep Failure

Name: Soft Sediment (Drained) Model: Mohr-Coulomb Unit Weight: 99 pcf Cohesion: 0 psf Phi: 30 °
Name: Consolidated Sediment (Drained - Low) Model: Mohr-Coulomb Unit Weight: 137.5 pcf Cohesion: 0 psf Phi: 30 °

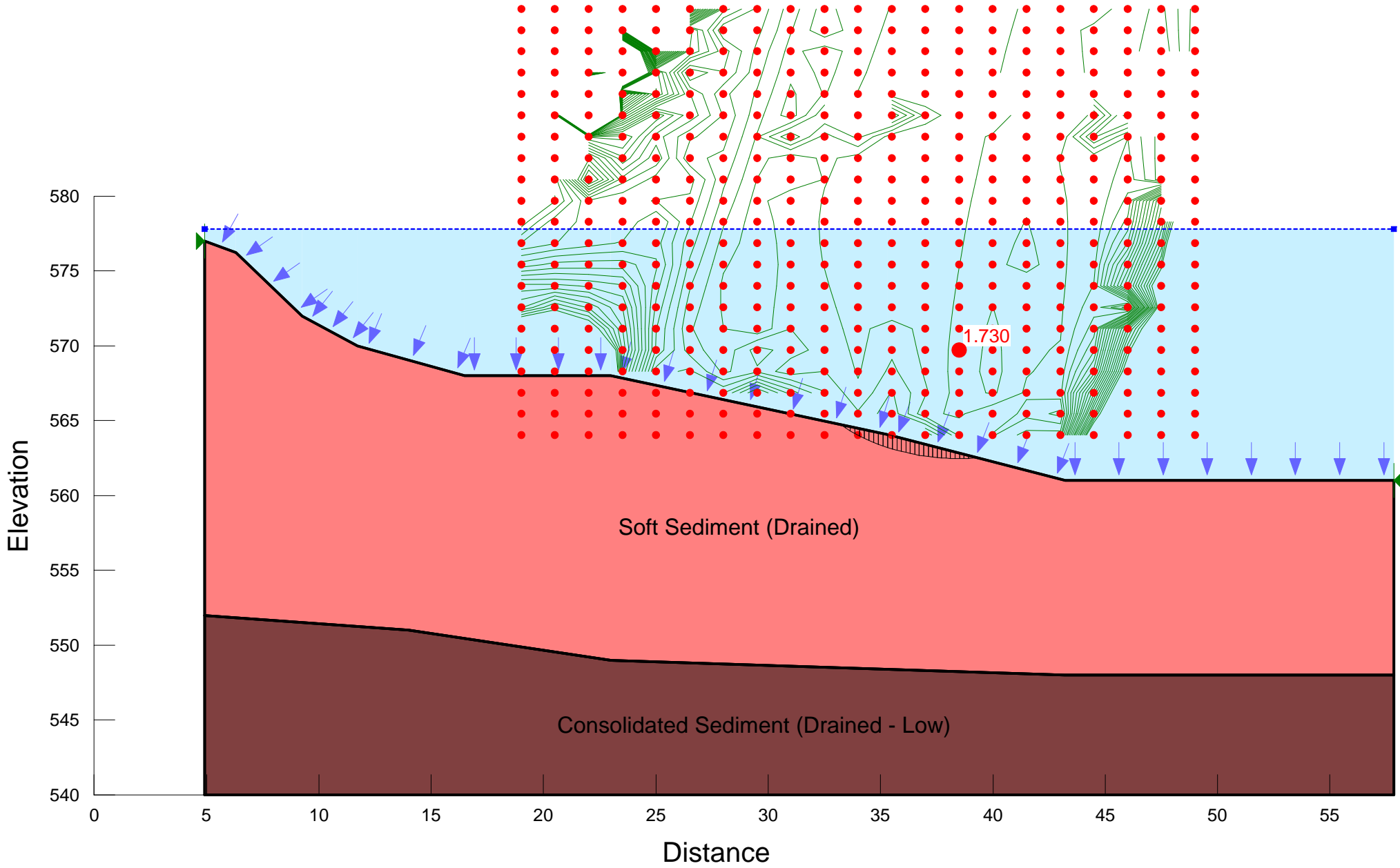

Existing Slope Section C-C': Undrained Soil Parameters

Name: Soft Sediment (Undrained) Model: Mohr-Coulomb Unit Weight: 99 pcf Cohesion: 120 psf Phi: 0 °
Name: Consolidated Sediment (Undrained - Low) Model: Mohr-Coulomb Unit Weight: 137.5 pcf Cohesion: 4000 psf Phi: 0 °

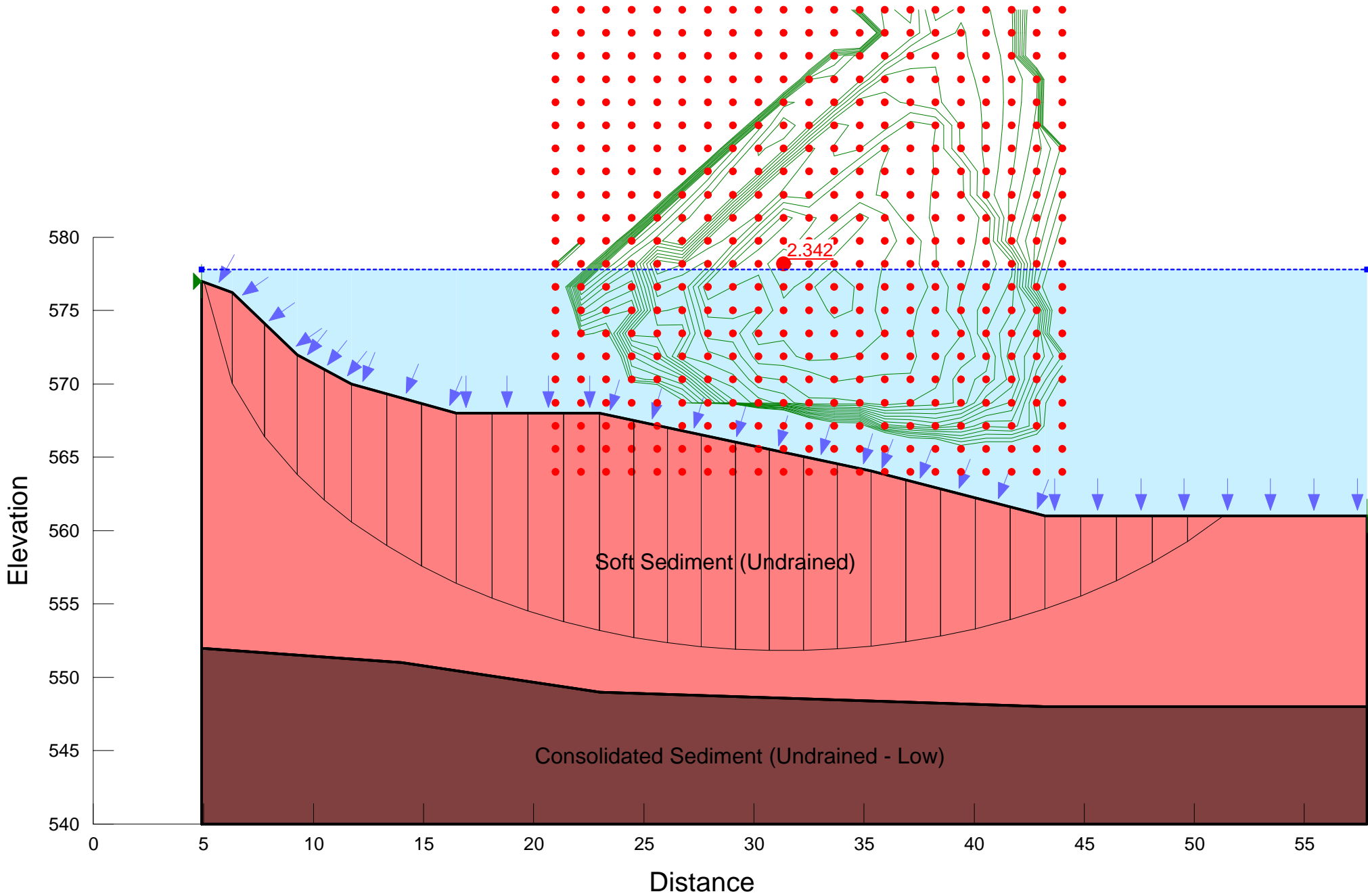

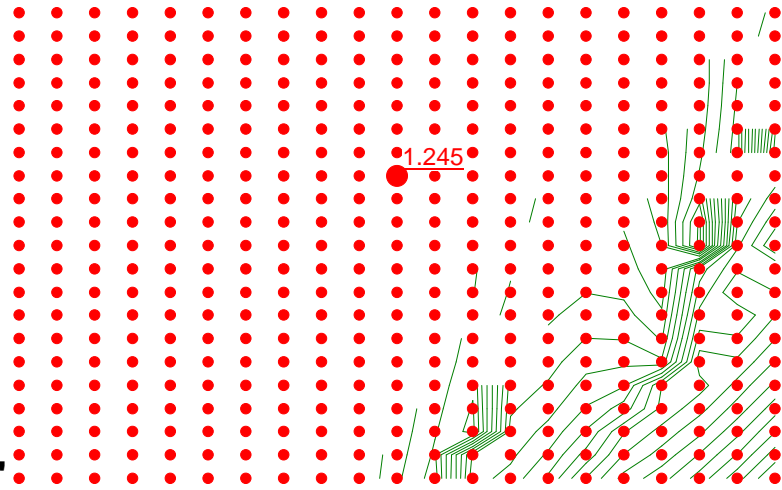

Filled Slope Section C-C'
Drained Soil Parameters
Surface Failure

Name: Sand Cap Model: Mohr-Coulomb Unit Weight: 125 pcf Cohesion: 0 psf Phi: 32 °
 Name: Soft Sediment (Drained) Model: Mohr-Coulomb Unit Weight: 99 pcf Cohesion: 0 psf Phi: 30 °
 Name: Consolidated Sediment (Drained - Low) Model: Mohr-Coulomb Unit Weight: 137.5 pcf Cohesion: 0 psf Phi: 30 °

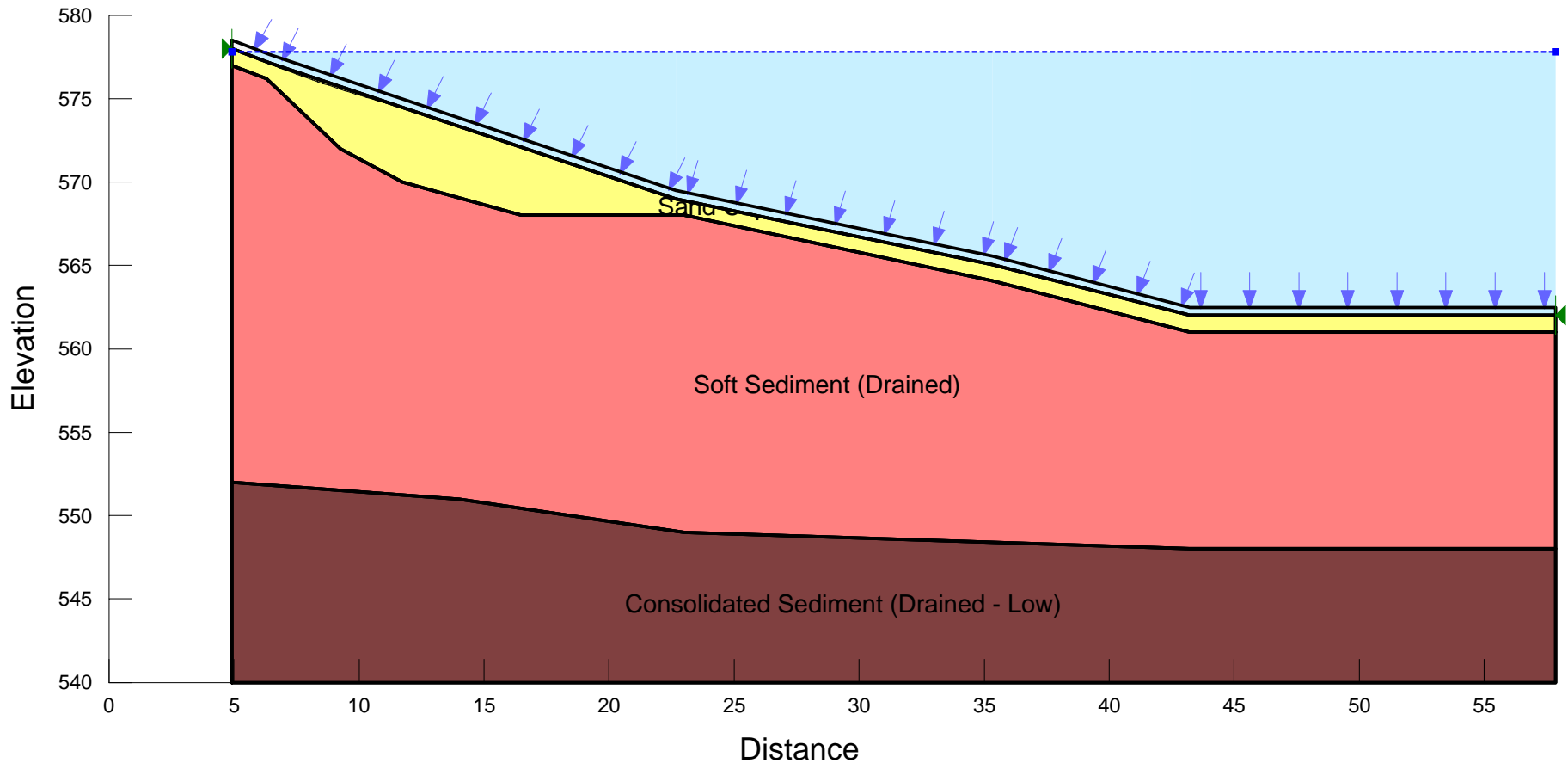

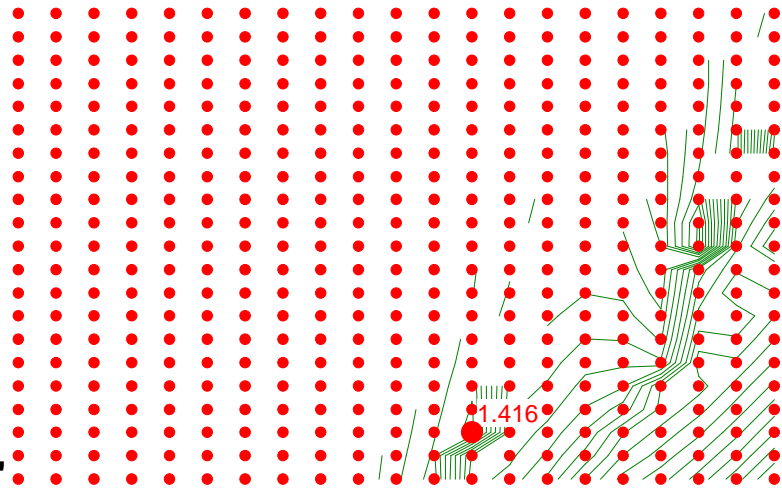

Filled Slope Section C-C'
Drained Soil Parameters
Deep Failure

Name: Sand Cap Model: Mohr-Coulomb Unit Weight: 125 pcf Cohesion: 0 psf Phi: 32 °
 Name: Soft Sediment (Drained) Model: Mohr-Coulomb Unit Weight: 99 pcf Cohesion: 0 psf Phi: 30 °
 Name: Consolidated Sediment (Drained - Low) Model: Mohr-Coulomb Unit Weight: 137.5 pcf Cohesion: 0 psf Phi: 30 °

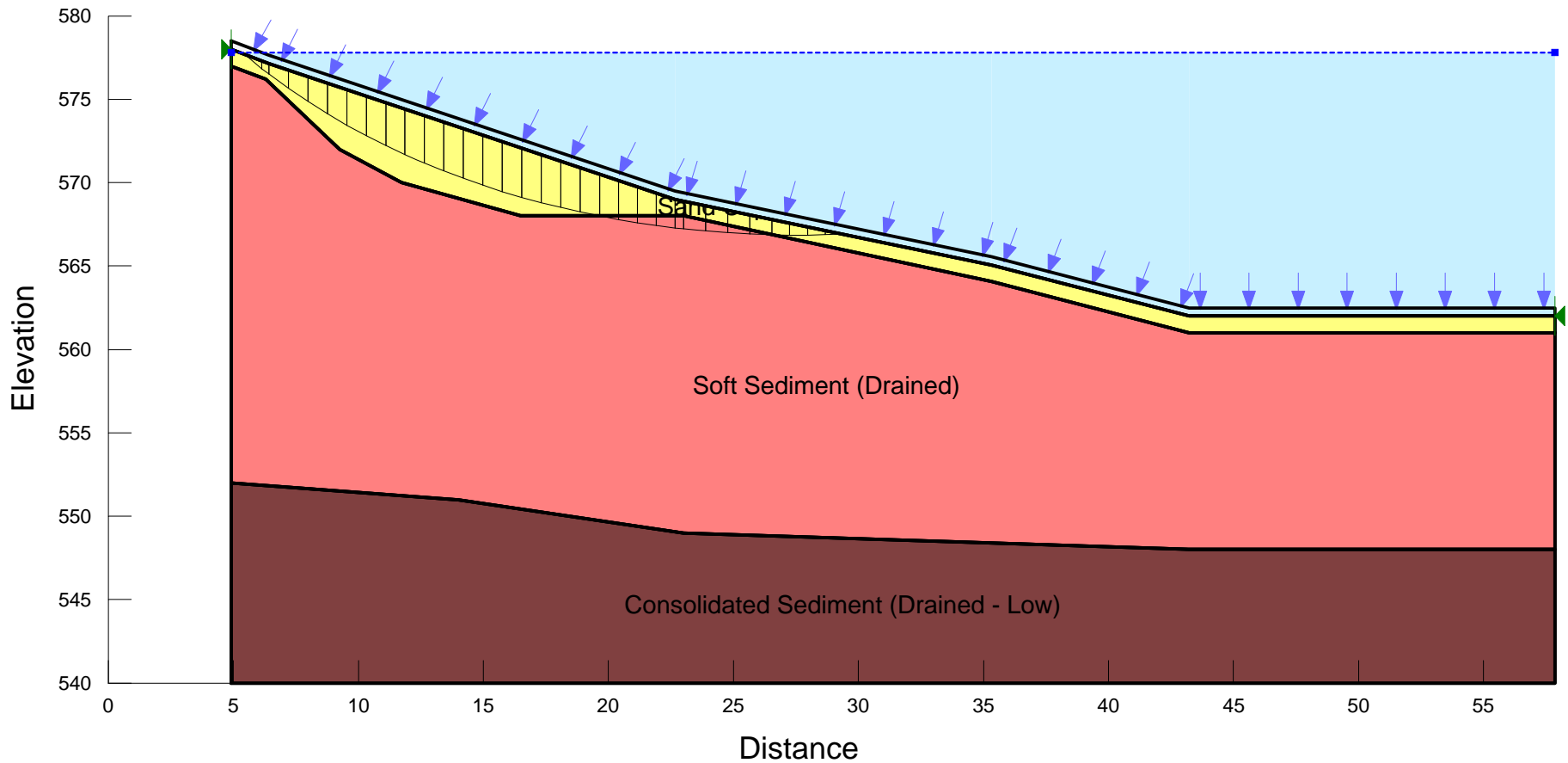

Filled Slope Section C-C'

Undrained Soil Parameters

Surface Failure

Name: Soft Sediment (Undrained) Model: Mohr-Coulomb Unit Weight: 99 pcf Cohesion: 120 psf Phi: 0 °
Name: Sand Cap Model: Mohr-Coulomb Unit Weight: 125 pcf Cohesion: 0 psf Phi: 32 °
Name: Consolidated Sediment (Undrained - Low) Model: Mohr-Coulomb Unit Weight: 137.5 pcf Cohesion: 4000 psf Phi: 0 °

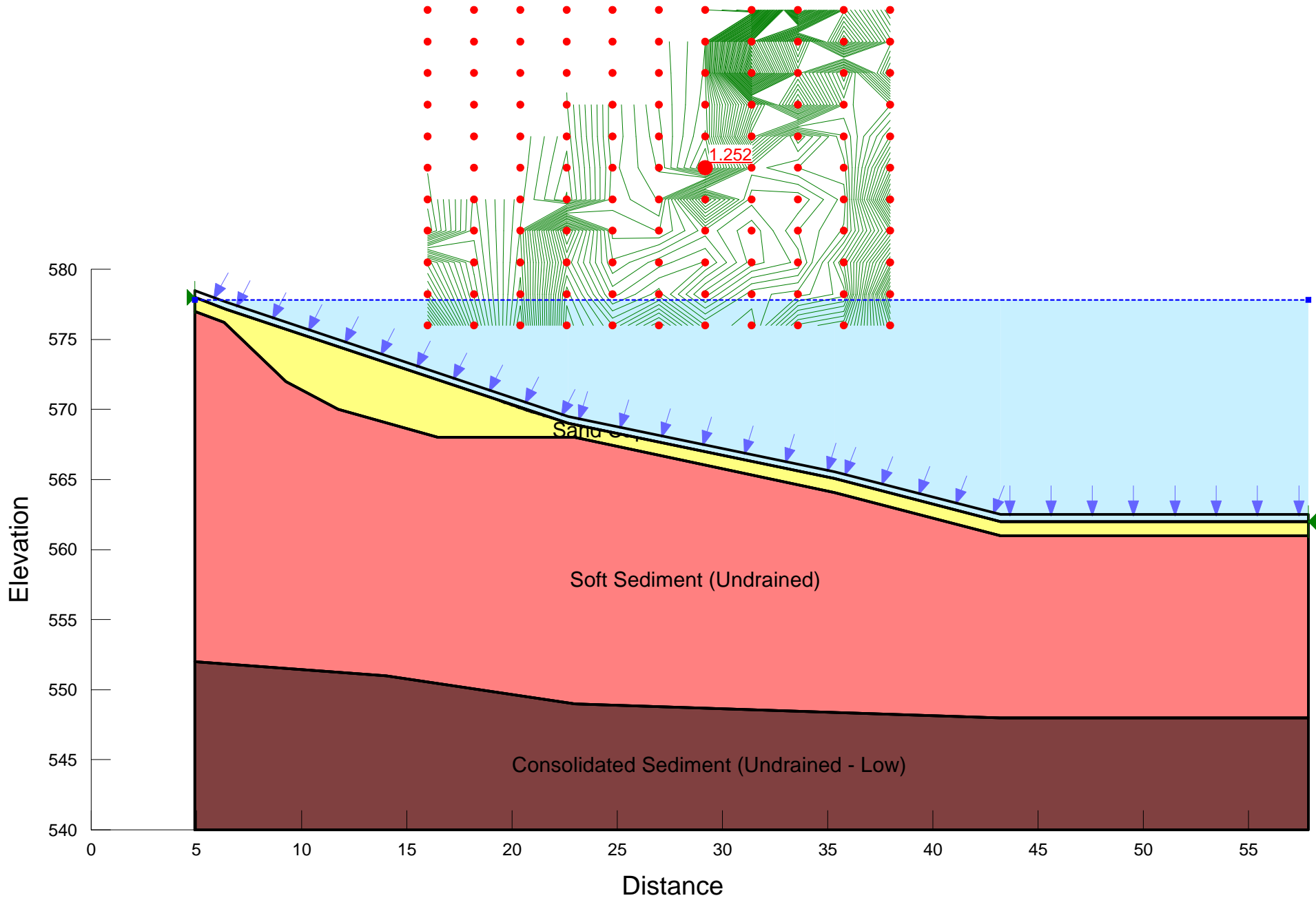

Filled Slope Section C-C'

Undrained Soil Parameters

Deep Failure

Name: Soft Sediment (Undrained) Model: Mohr-Coulomb Unit Weight: 99 pcf Cohesion: 120 psf Phi: 0 °
Name: Sand Cap Model: Mohr-Coulomb Unit Weight: 125 pcf Cohesion: 0 psf Phi: 32 °
Name: Consolidated Sediment (Undrained - Low) Model: Mohr-Coulomb Unit Weight: 137.5 pcf Cohesion: 4000 psf Phi: 0 °

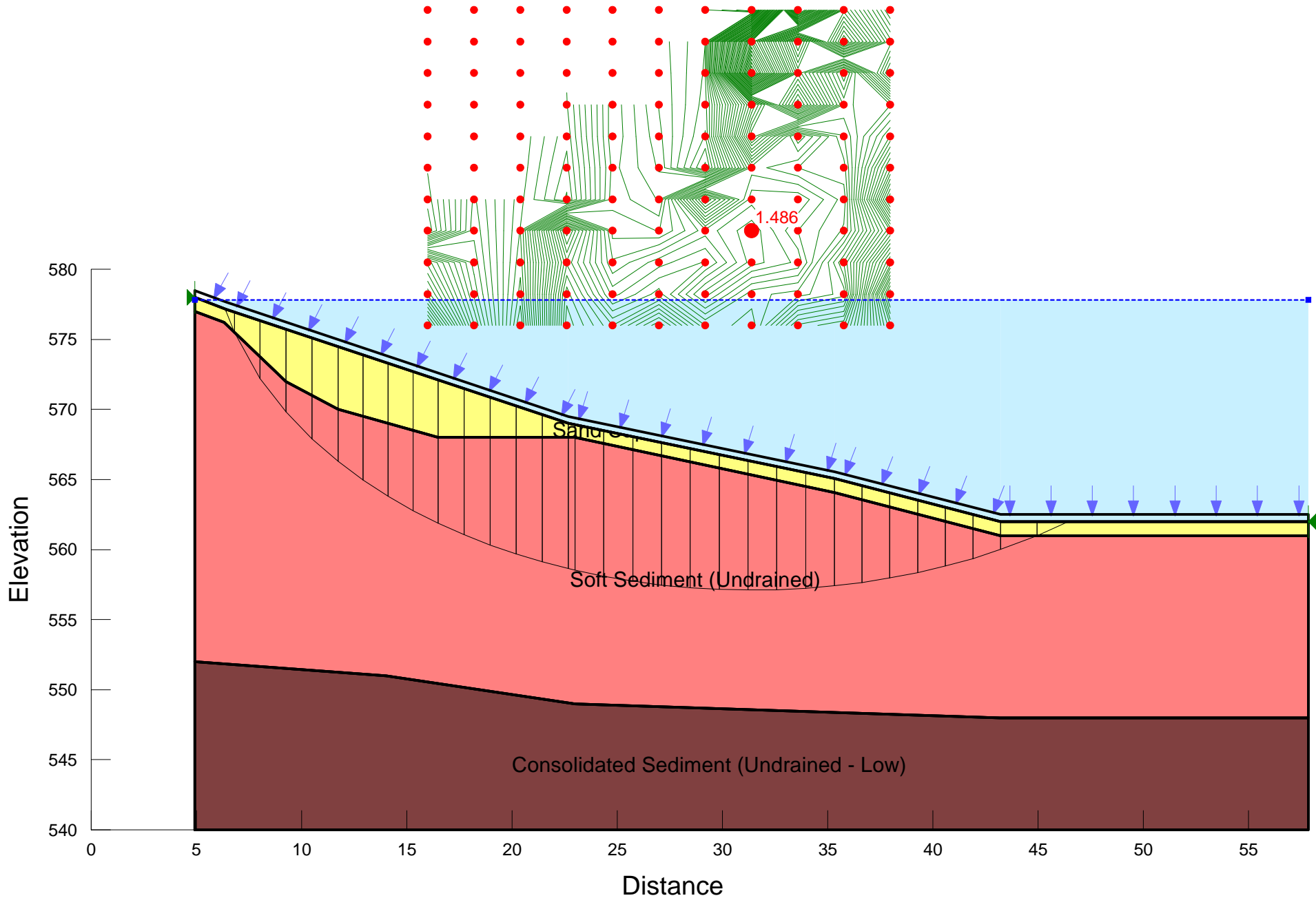

Capped Slope Section C-C'
Sand Cap
0.5-ft 2" D50 Protective Layer
Drained Soil Parameters
Surface Failure

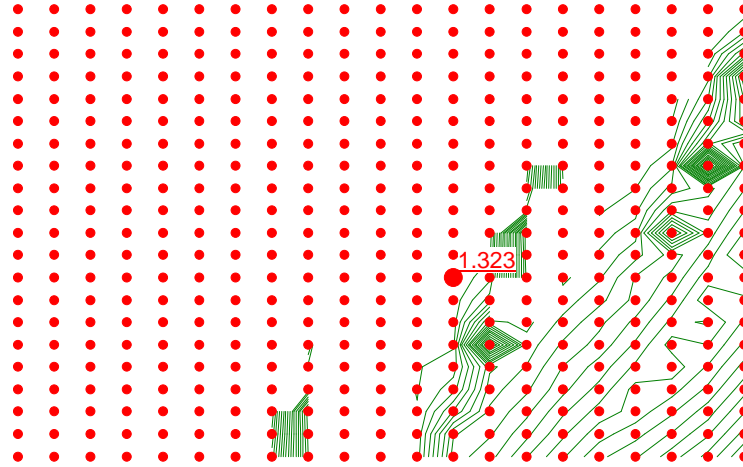

Name: Sand Cap	Model: Mohr-Coulomb	Unit Weight: 125 pcf	Cohesion: 0 psf	Phi: 32 °
Name: Gravel Cap	Model: Mohr-Coulomb	Unit Weight: 135 pcf	Cohesion: 0 psf	Phi: 40 °
Name: Soft Sediment (Drained)	Model: Mohr-Coulomb	Unit Weight: 99 pcf	Cohesion: 0 psf	Phi: 30 °
Name: Consolidated Sediment (Drained - Low)	Model: Mohr-Coulomb	Unit Weight: 137.5 pcf	Cohesion: 0 psf	Phi: 30 °

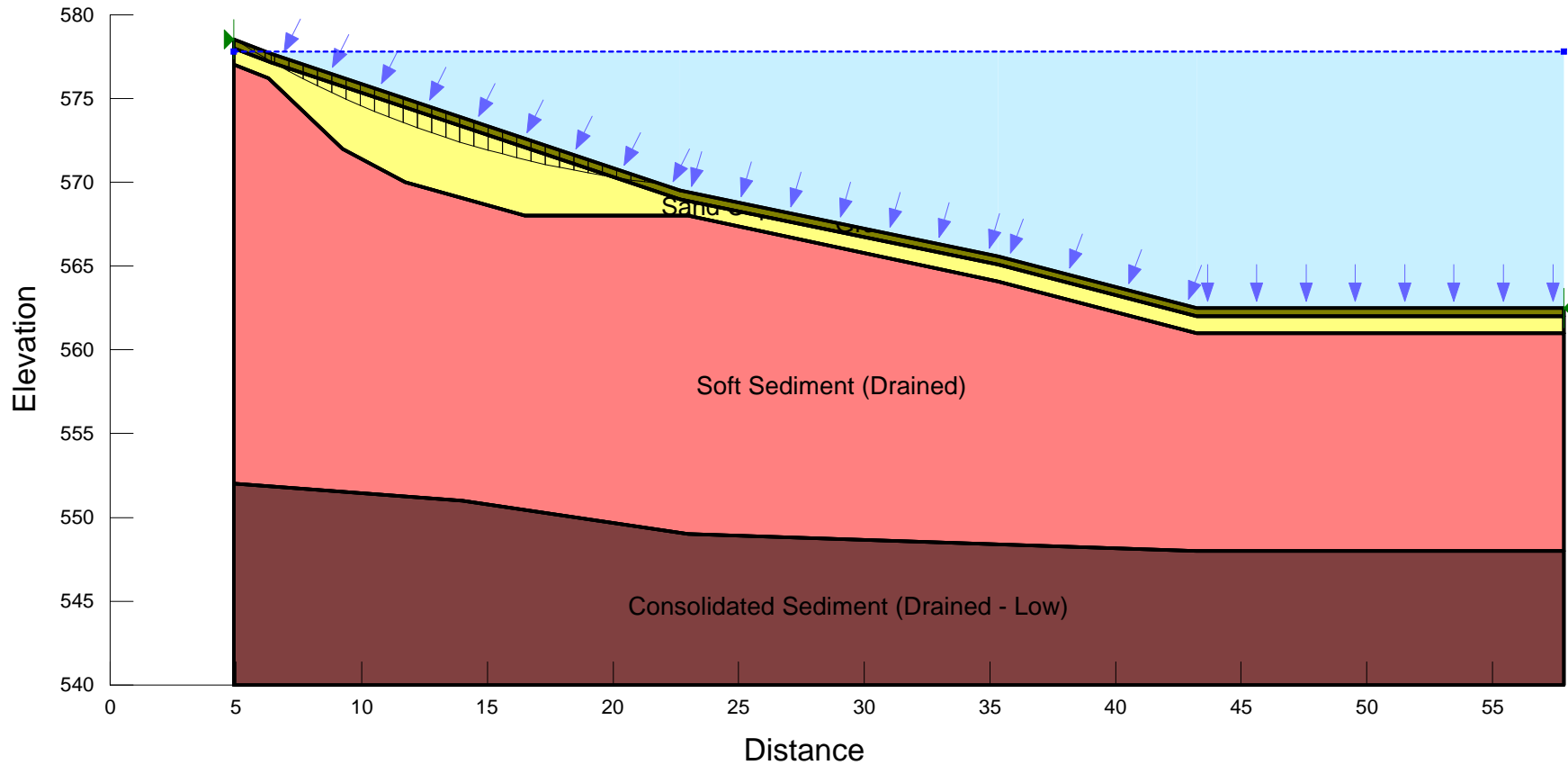

Capped Slope Section C-C'
Sand Cap
0.5-ft 2" D50 Protective Layer
Drained Soil Parameters
Deep Failure

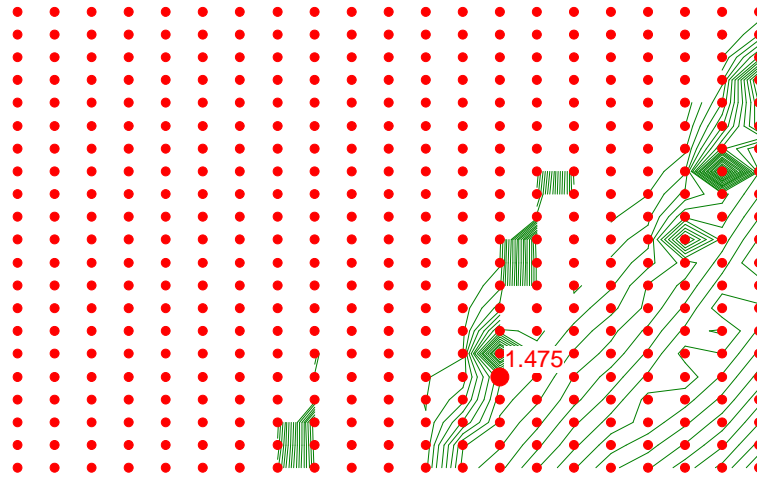

Name: Sand Cap	Model: Mohr-Coulomb	Unit Weight: 125 pcf	Cohesion: 0 psf	Phi: 32 °
Name: Gravel Cap	Model: Mohr-Coulomb	Unit Weight: 135 pcf	Cohesion: 0 psf	Phi: 40 °
Name: Soft Sediment (Drained)	Model: Mohr-Coulomb	Unit Weight: 99 pcf	Cohesion: 0 psf	Phi: 30 °
Name: Consolidated Sediment (Drained - Low)	Model: Mohr-Coulomb	Unit Weight: 137.5 pcf	Cohesion: 0 psf	Phi: 30 °

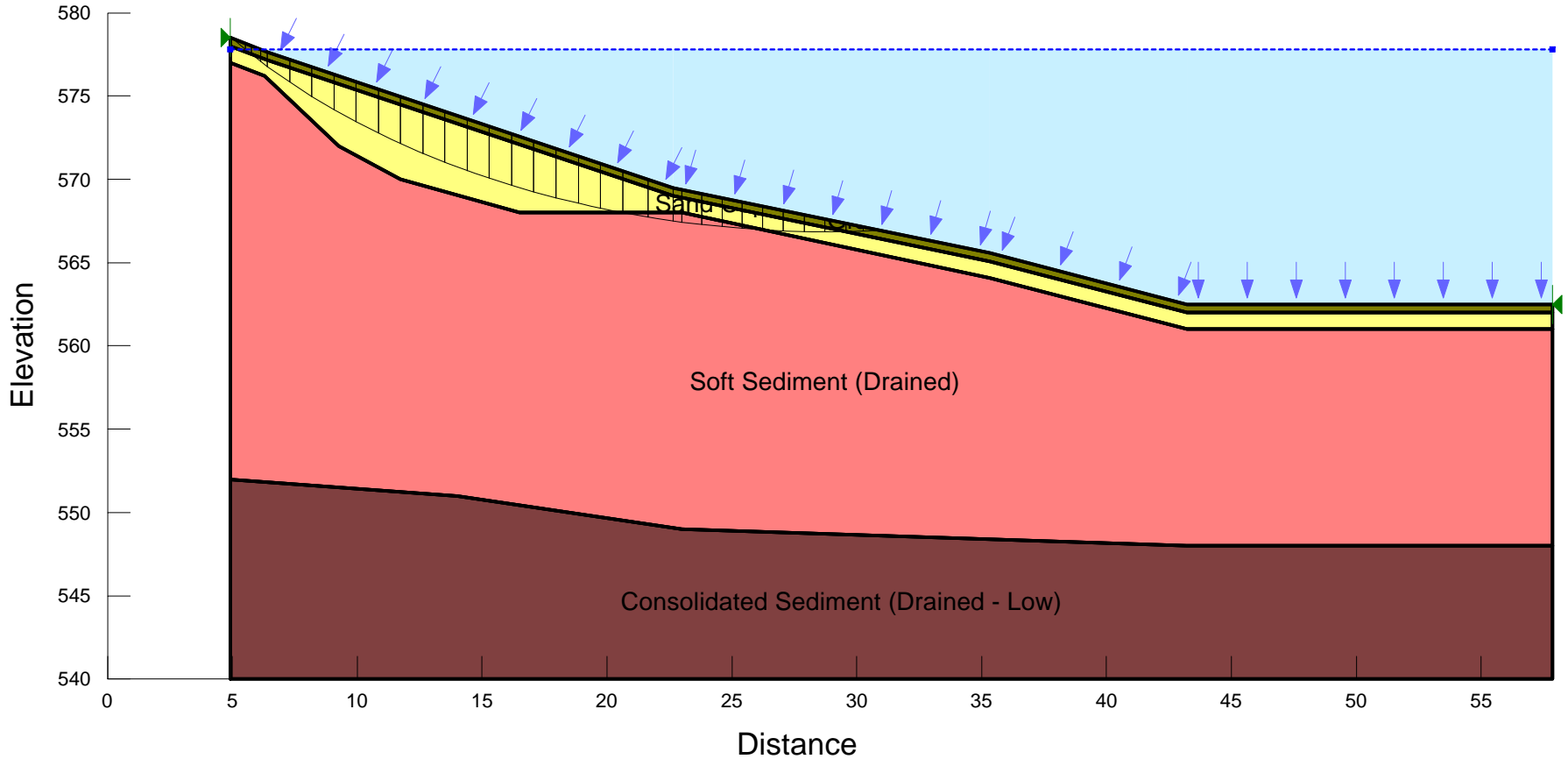

Capped Slope Section C-C'
Sand Cap
0.5-ft 2" D50 Protective Layer
Undrained Soil Parameters
Surface Failure

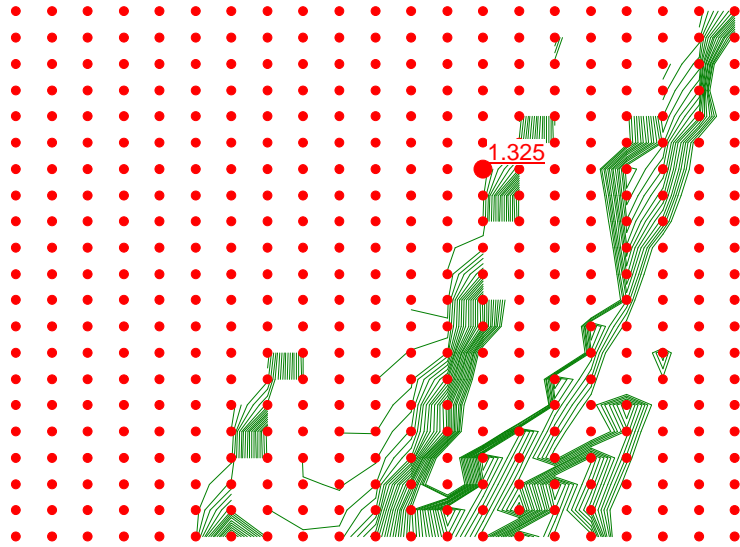

Name: Soft Sediment (Undrained) Model: Mohr-Coulomb Unit Weight: 99 pcf Cohesion: 120 psf Phi: 0 °
 Name: Sand Cap Model: Mohr-Coulomb Unit Weight: 125 pcf Cohesion: 0 psf Phi: 32 °
 Name: Gravel Cap Model: Mohr-Coulomb Unit Weight: 135 pcf Cohesion: 0 psf Phi: 40 °
 Name: Consolidated Sediment (Undrained - Low) Model: Mohr-Coulomb Unit Weight: 137.5 pcf Cohesion: 4000 psf Phi: 0 °

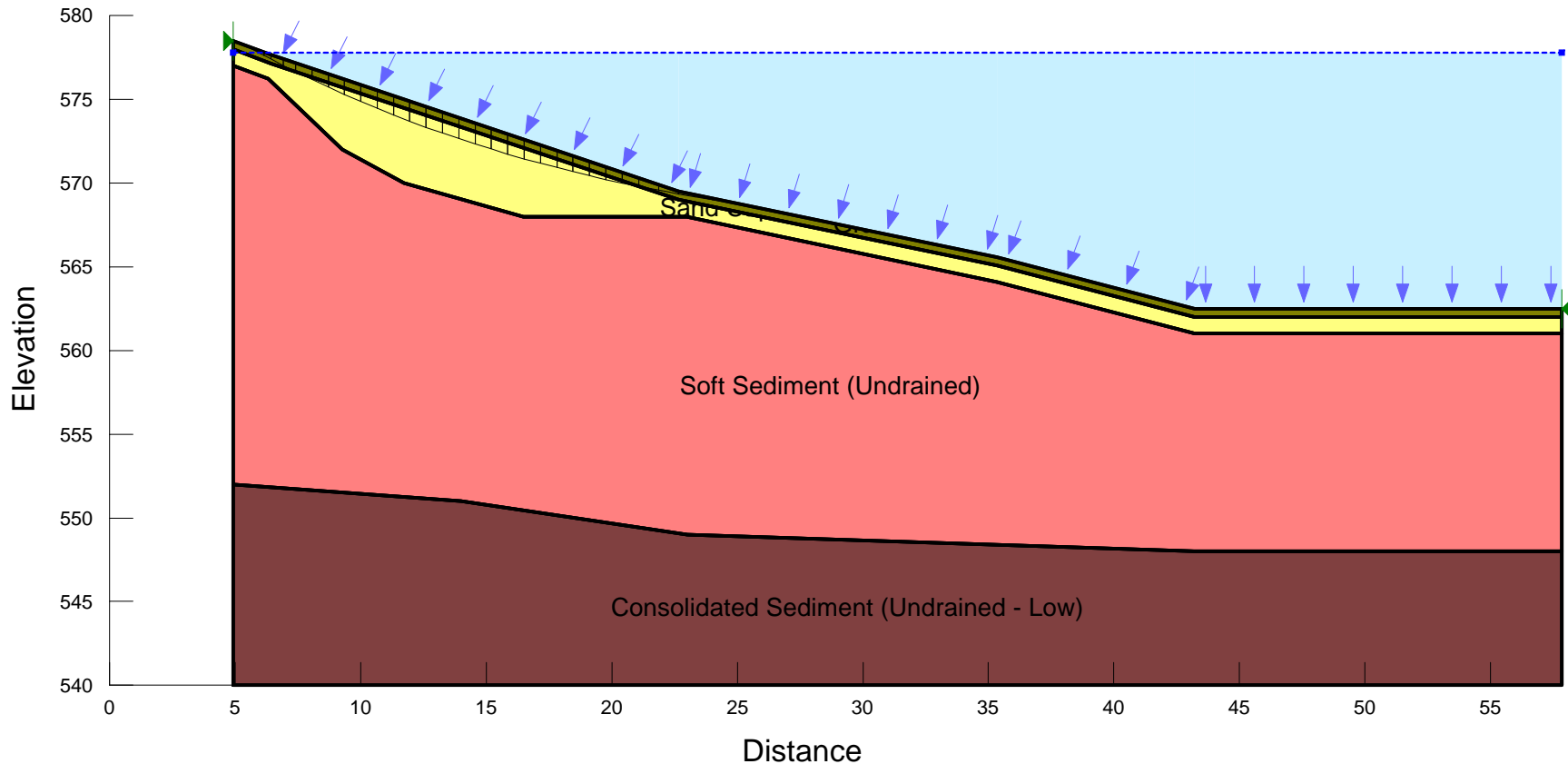

Capped Slope Section C-C'
Sand Cap
0.5-ft 2" D50 Protective Layer
Undrained Soil Parameters
Deep Failure

Name: Soft Sediment (Undrained) Model: Mohr-Coulomb Unit Weight: 99 pcf Cohesion: 120 psf Phi: 0 °

Name: Sand Cap Model: Mohr-Coulomb Unit Weight: 125 pcf Cohesion: 0 psf Phi: 32 °

Name: Gravel Cap Model: Mohr-Coulomb Unit Weight: 135 pcf Cohesion: 0 psf Phi: 40 °

Name: Consolidated Sediment (Undrained - Low) Model: Mohr-Coulomb Unit Weight: 137.5 pcf Cohesion: 4000 psf Phi: 0 °

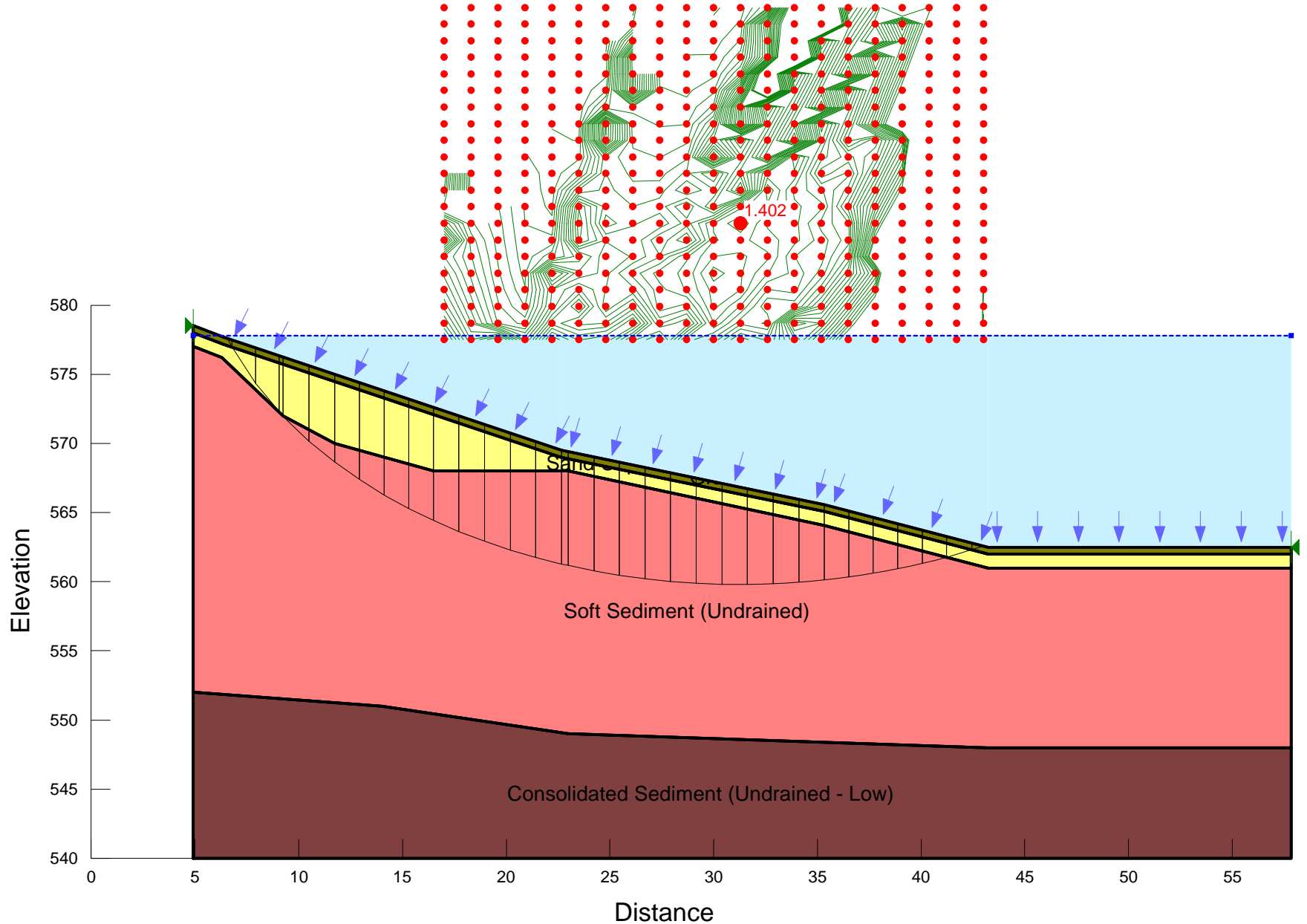

CITY:(SYRACUSE,NY) DIV:(GROUP,ENCAD) DR:(SR,BLL) LD:(SBELL) PIC:() PN:(G,VANDERLAAN) TM:(G,VANDERLAAN) LVR:(ORION#:"OFF=REF") PLOTSETUP:PDF D2B PLOTSTYLETABLE:PLT\FULL.CTB PLOTTED:6/9/2011 2:07 PM BY:BELL,STEVEN
G:\ENVCAD\SYRACUSE\ACT\CI000664\032\00001\DWG\000664g94.dwg LAYOUT: 1_SAVED: 6/9/2011 1:51 PM ACADVER: 18.1S (LMS TECH) PAGESETUP:PDF D2B PLOTSTYLETABLE:PLT\FULL.CTB PLOTTED:6/9/2011 2:07 PM BY:BELL,STEVEN

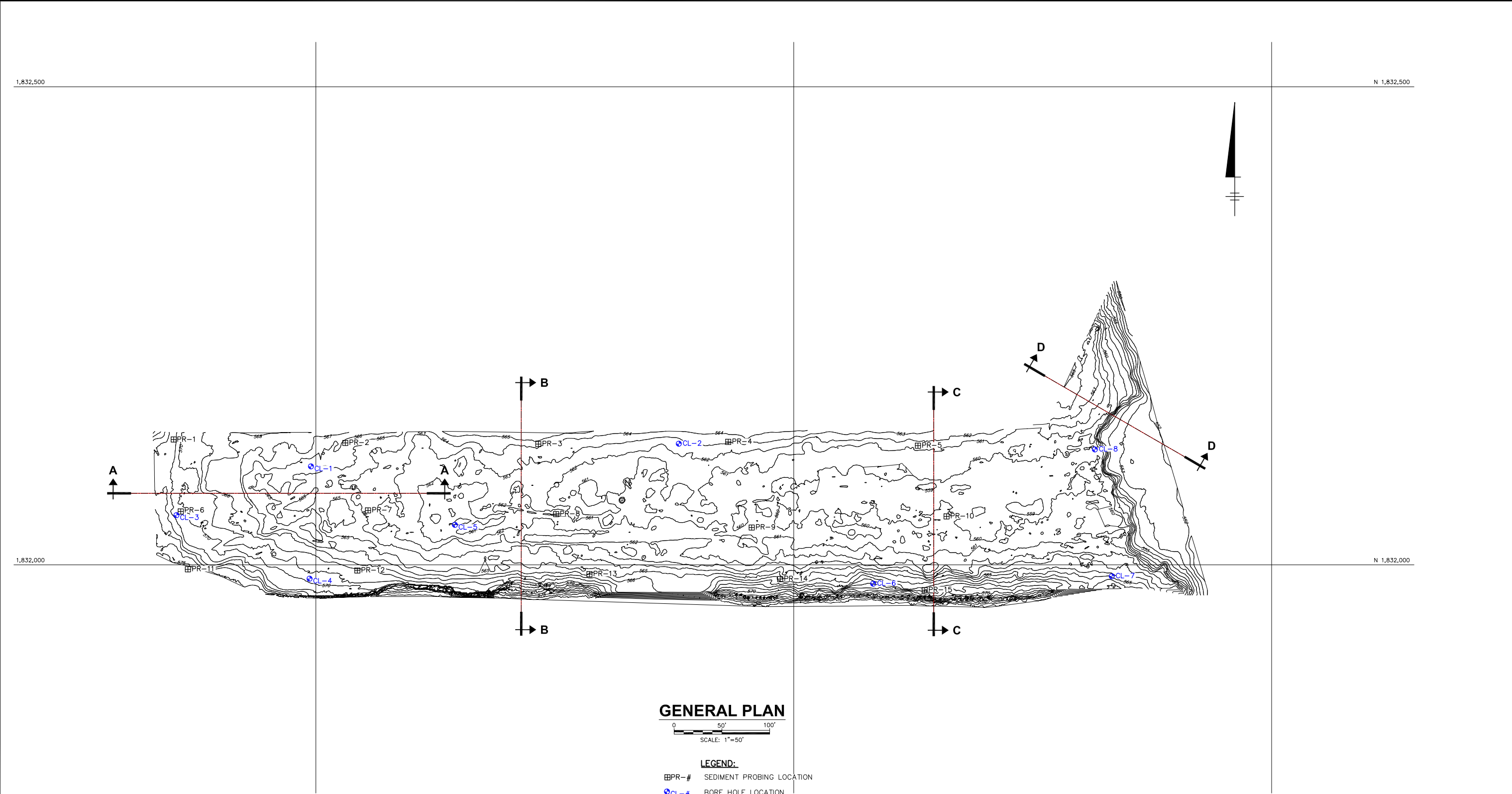

GENERAL PLAN

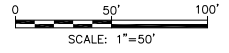

LEGEND:

- ▣PR-# SEDIMENT PROBING LOCATION
- CL-# BORE HOLE LOCATION

FORMER WISONSIN STEEL WORKS
CHICAGO, IL
SOUTH SLIP REMEDIAL ACTION ALTERNATIVES

GENERAL PLAN



FIGURE
D2-1

South

North

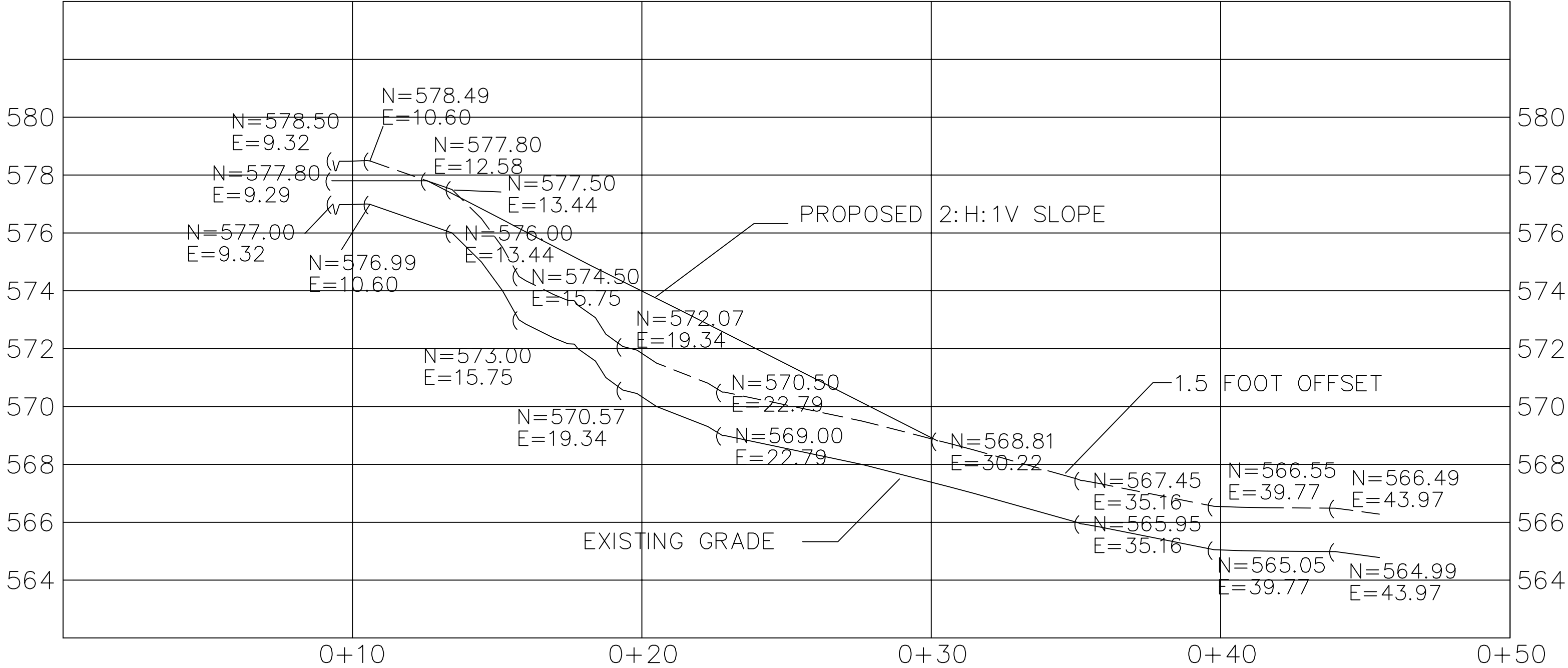

SECTION B-B'

See Figure D2-1 in this calculation sheet for plan view showing section location.

South

North

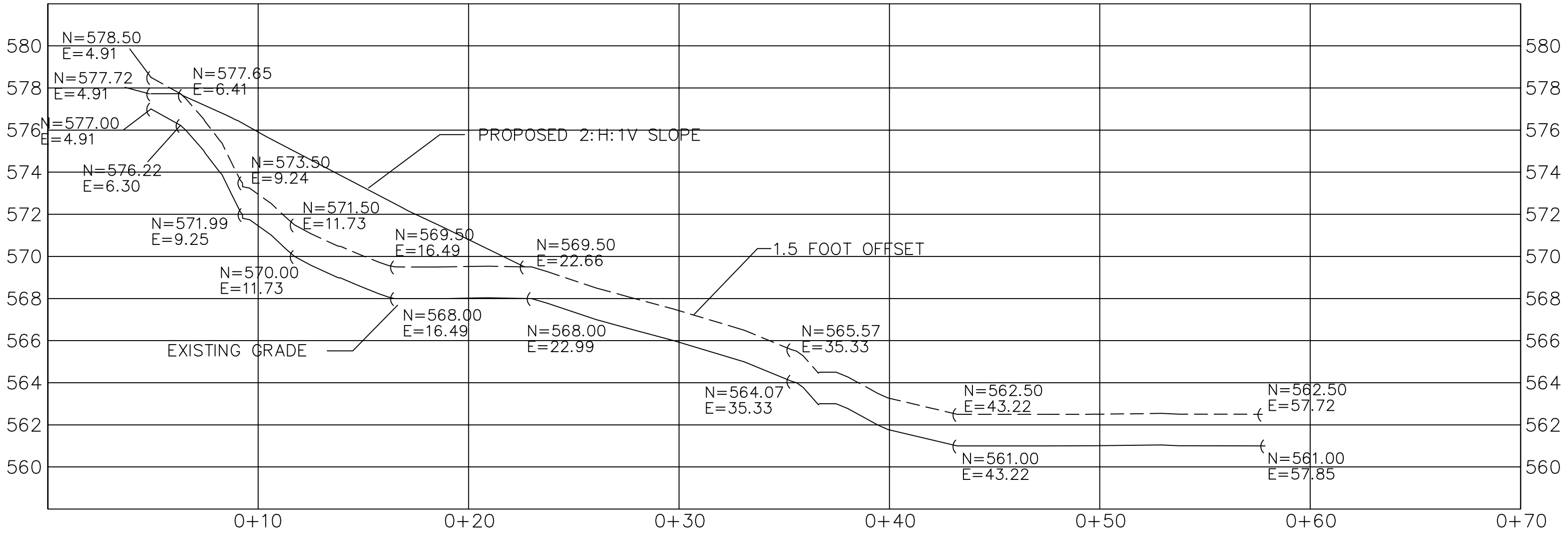

SECTION C-C'

See Figure D2-1 in this calculation sheet for plan view showing section location.

Soil Data from WSW PDI, Spring 2011.

UU Test 1-D Consolidation Test Results

Sample Location	Sample Depth (ft bss)	Gravel Content (%)	Sand Content (%)	Fines Content (%)	Coefficient of Gradation (Cc)	Uniformity Coefficient (Cu)	Water Content (MC - %)	Wet Density (WD - pcf)	Dry Density (DD - pcf)	Liquid Limit (LL)	Plastic Limit (PL)	Plasticity Index (PI)	Organic Content (OC - %)	Undrained Shear Strength (Su = pcf)	Initial Void Ratio (e ₀)	Pre-consolidation Pressure (Pc)	Compression Index (Cc)	Recompression Index (Cr)	Specific Gravity	USCS Classification*	Soil Description**
CL1	0 - 0.8	1.6	27.2	71.2	1.89	9.20	1.7						11.5						2.35	ML	
	2 - 4	0.0	15.2	84.8	1.66	6.60	78.3	78.5	44.1										2.23	MH	SILT, little sand
CL2	2 - 4	0.0	6.9	93.1	0.76	4.78	105.9	83.3	40.5				7.6						2.74	MH	SILT, trace sand
	4 - 6	1.8	12.8	85.4	1.43	4.14	80.8	84.4	46.7					2.663	0.63	0.58	0.04		MH		
	6 - 8									54	37	17								MH (v)	
	8 - 10	0.0	14.9	85.1	1.04	3.82	192.5	92.1	31.5										2.71	MH	SILT, little sand, little clay
CL3	2 - 4	0.0	32.5	67.5	0.55	6.87	60.9	87.9	54.7										2.22	MH	SILT, some Sand, trace clay
	4 - 6	0.0	17.2	82.8	1.32	6.22	2.7						18.3							MH	SILT, little sand, little clay
	6 - 8	0.0	32.0	68.0	0.51	10.35	68.5	86.7	51.4											MH	SILT, some Sand, little clay
	8 - 10						57.7	86.9	55.1										2.57	MH (v)	
CL4	4 - 6	0.0	35.0	65.0	0.68	21.41	72.1		43.2				18.6							MH	
	8 - 10	0.0	16.1	83.9	1.25	2.85	99.2	80.3	40.3											MH	SILT, some Sand, trace clay
CL5	2 - 4	0.0	12.1	87.9			38.6	107.0	77.2											ML	CLAY, some Silt, trace sand
	4 - 6	0.0	18.3	81.6	0.90	3.69	74.3	86.7	49.8										2.82	MH	SILT, little sand, little clay
CL6	6 - 8						82.4		62.2	42	30	12	6.0						2.93	ML	
	8 - 10																			MH (v)	
	10 - 12						89.6	89.6	44.6	56	37	19	7.8						2.95	MH (v)	
	12 - 14	4.4	14.4	81.2	1.13	4.34	86.1	92.7	49.8	51	38	13	8.3	173.0					2.73	MH	
CL7	2 - 4	0.0	21.3	78.7	0.89	6.40				57	39	18								MH	SILT, some Sand, little clay
	4 - 6	0.0	6.2	93.8	1.49	3.80	69.2			52	36	16		110.0					3.04	MH	
	6 - 8	0.2	12.9	86.9	1.33	6.99	76.0	100.0	56.8	47	36	11			2.289	0.71	0.54	0.04	2.99	ML	
	10 - 12	1.5	16.5	82.0	0.94	5.60	75.3	99.9	57.0	51	36	15		161.0	2.237	0.81	0.50	0.03	2.96	MH	
	14 - 16	0.9	8.4	90.7																MH	SILT, some Clay, trace sand, trace gravel
CL8	2 - 4	0.0	4.8	95.2			72.2		61.3	50	36	14	5.6	122.0	2.080	0.74	0.60	0.05	3.02	MH	
	4 - 6	0.2	14.5	85.3	0.76	7.03														MH	
	8 - 10	0.6	62.2	37.2	0.91	51.90	27.2	112.7	88.6											SM	SAND, some Silt, little clay, trace gravel
	10 - 12									22	15	7								CL-ML	
	12 - 14																			ML (v)	
PDI-SS-1	0 - 0.8	24.6	38.3	37.1	0.54	59.13														SM	SAND, some Silt, some Gravel, trace clay
PDI-SS-2	0 - 0.8	0.0	15.7	84.3	2.56	13.61														ML	SILT, little sand, little clay, trace gravel
PDI-SS-3	0 - 0.8	20.2	39.1	40.7	1.29	17.07	2.5			40	29	11	7.9					2.45	SM	SAND and SILT, some Gravel, trace clay	
PDI-SS-4	0 - 0.8	0.7	13.8	85.5	1.62	9.19														ML	
PDI-SS-5	0 - 0.8	0.0	14.9	85.1	1.57	8.01	2.3						9.2							ML	SILT, little clay, little sand

Cu - Uniformity Coefficient

Cc - Coefficient of Gradation

*Based on gradation and atterberg limits

**Based on % content by weight

Reporting discrepancy

Questionable value

Calculated value

Below soft sediment

Date Start/Finish: 3/30/11 Drilling Company: RDnP Driller's Name: Don Eger, Don Smith Drilling Method: HSA Casing Size: 4" ID Rig Type: Mobile B 4300 Track Rig Sampling Method: 2" Split Spoon / Osterberg, ASTM D1586/D158	Northing: 1831980.2 Easting: 1197083.1 Borehole Depth: 16' bss. Water Surface Elevation: 577.4' Descriptions By: Ron Kuhn / Pat Dougher	Well/Boring ID: CL-6 Client: Navistar, LLC Location: WSW South Slip, Chicago, IL <h1 style="text-align: center;">DRAFT</h1>
----------------------------------------------------------------------------------------------------------------------------------------------------------------------------------------------------------------------------------------------------------------------------------------------------	---------------------------------------------------------------------------------------------------------------------------------------------------------------------------------------------------	-----------------------------------------------------------------------------------------------------------------------------------------------------------------------

DEPTH	ELEVATION	Sample Run Number	Sample/Int/Type	Recovery (feet)	Blow Counts	N - Value	Geologic Column	Stratigraphic Description	Well/Boring Construction
-------	-----------	-------------------	-----------------	-----------------	-------------	-----------	-----------------	---------------------------	--------------------------

0		Ponar	0'-0.8'	0.8	NA	NA		Grey brown fine SAND, little coarse Sand, trace fine to coarse gravel.	
								No recovery.	
		2" SS	2'-4'	0.0	1/12"	1			
					WOR			No recovery.	
	56.0	2" SS	4'-6'	0.0	1/12"	1			
5					1/12"				
		Ost.	6'-8'	2.0	NA	NA		Dark brown SILT.	
								Dark brown SILT, trace fine sand, odor. (Very Soft)	
	55.5	2" SS	8'-10'	2.0	1/24"	1			
10								Dark brown SILT. MC = 101.2, WD = 89.6, DD = 44.6, OC = 7.8, LL = 56, PL = 37, PI = 19.	
		Ost.	10'-12'	2.0	NA	NA			
								SAA. MC = 86.1, WD = 92.7, DD = 49.8, OC = 8.3, Su = 173.	
		Ost.	12'-14'	2.0	NA	NA			
	55.0							Grey SILT, trace fine sand, trace fine gravel. (Hard)	
15		2" SS	14'-16'	1.2	8 15 19 23	34			
								Boring terminated at 16.0' bss.	
									Boring backfilled to sediment surface with 3 bags of bentonite chips.

 ARCADIS <i>Infrastructure · Water · Environment · Buildings</i>	Remarks: Modified Burmister classification system used. SS = split spoon; Ost. = osterberg sampler; bss = below sediment surface; NA = Not Applicable/Available; WOR = weight of rod; SAA = same as above; HSA = hollow stem auger; Cc = coefficient of gradation; Cu = uniformity coefficient; MC = moisture content (%); WD = wet density (pcf); DD = dry density (pcf); OC = organic content (%); LL = liquid limit; PL = plastic limit; PI = plasticity index; Su = undrained shear strength (psf) 140 lb auto hammer used. Water Depth (at time of drilling) = 13.0 ft.
------------------------------------------------------------------------------------------------------------------------------------------------------------------	-------------------------------------------------------------------------------------------------------------------------------------------------------------------------------------------------------------------------------------------------------------------------------------------------------------------------------------------------------------------------------------------------------------------------------------------------------------------------------------------------------------------------------------------------------------------------------------------

Date Start/Finish: 3/31/11 Drilling Company: RDnP Driller's Name: Don Eger, Don Smith Drilling Method: HSA Casing Size: 4" ID Rig Type: Mobile B 4300 Track Rig Sampling Method: 2" Split Spoon / Osterberg, ASTM D1586/D158	Northing: 1831988.0 Easting: 1197332.8 Borehole Depth: 16 Water Surface Elevation: 577.2' Descriptions By: Ron Kuhn / Pat Dougher	Well/Boring ID: CL-7 Client: Navistar, LLC Location: WSW South Slip, Chicago, IL <h1 style="text-align: center;">DRAFT</h1>
----------------------------------------------------------------------------------------------------------------------------------------------------------------------------------------------------------------------------------------------------------------------------------------------------	---------------------------------------------------------------------------------------------------------------------------------------------------------------------------------------------	-----------------------------------------------------------------------------------------------------------------------------------------------------------------------

DEPTH	ELEVATION	Sample Run Number	Sample/Int/Type	Recovery (feet)	Blow Counts	N - Value	Geologic Column	Stratigraphic Description	Well/Boring Construction
-------	-----------	-------------------	-----------------	-----------------	-------------	-----------	-----------------	---------------------------	--------------------------

0		Ponar	0'-0.8'	0.8	NA	NA		Dark brown fine to coarse GRAVEL, trace silt, trace metal.	
		2" SS	2'-4'	2.0	WOR WOR WOR	0		Dark brown SILT, trace to little clay, odor. (Very Soft) Cc = 0.9, Cu = 6.4, LL = 57, PL = 39, PI = 18.	
560		Ost.	4'-6'	2.0	NA	NA		Dark brown SILT.	
		Ost.	6'-8'	2.0	NA	NA		SAA. MC = 76.0, WD = 100.0, DD = 56.8.	
		2" SS	8'-10'	2.0	WOR WOR WOR	0		Dark brown SILT, trace intermittent fine sand laminae, trace fine gravel, odor. (Very Soft)	
555		Ost.	10'-12'	2.0	NA	NA		Dark brown SILT.	
		2" SS	12'-14'	1.0	6 11 11 12	22		Grey to brown fine SAND and SILT, trace medium to coarse sand. (Medium Dense) MC = 74.1, WD = 99.9, DD = 57.4.	
		2" SS	14'-16'	1.7	12 14 16 22	30		Grey to brown SILT and CLAY, trace fine sand, trace fine gravel. (Very Stiff)	
15								Boring Terminated at 16.0' bss.	

Boring backfilled to sediment surface with 3 bags of bentonite chips.



Remarks: Modified Burmister classification system used.
 SS = split spoon; Ost. = osterberg sampler; bss = below sediment surface; NA = Not Applicable/Available; WOR = weight of rod; SAA = same as above; HSA = hollow stem auger; Cc = coefficient of gradation; Cu = uniformity coefficient; MC = moisture content (%); WD = wet density (pcf); DD = dry density (pcf); OC = organic content (%); LL = liquid limit; PL = plastic limit; PI = plasticity index; Su = undrained shear strength (psf)
 140 lb auto hammer used.
 Water Depth (at time of drilling) = 13.0 ft.

Date Start/Finish: 3/31/11 Drilling Company: RDnP Driller's Name: Don Eger, Don Smith Drilling Method: HSA Casing Size: 4" ID Rig Type: Mobile B 4300 Track Rig Sampling Method: 2" Split Spoon / Osterberg, ASTM D1586/D158	Northing: 1832120.7 Easting: 1197315.1 Borehole Depth: 14' bss Water Surface Elevation: 577.2' Descriptions By: Ron Kuhn / Pat Dougher	Well/Boring ID: CL-8 Client: Navistar, LLC Location: WSW South Slip, Chicago, IL <h1 style="text-align: center;">DRAFT</h1>
----------------------------------------------------------------------------------------------------------------------------------------------------------------------------------------------------------------------------------------------------------------------------------------------------	--------------------------------------------------------------------------------------------------------------------------------------------------------------------------------------------------	-----------------------------------------------------------------------------------------------------------------------------------------------------------------------

DEPTH	ELEVATION	Sample Run Number	Sample/Int/Type	Recovery (feet)	Blow Counts	N - Value	Geologic Column	Stratigraphic Description	Well/Boring Construction
-------	-----------	-------------------	-----------------	-----------------	-------------	-----------	-----------------	---------------------------	--------------------------

0		Ponar	0'-0.8'	0.8	NA	NA		Dark brown SILT, little shells, trace coarse gravel.		
		Ost.	2'-4'	2.0	NA	NA		Dark brown SILT.		
555		2" SS	4'-6'	2.0	WOR WOR WOR WOR	0		Dark brown SILT, little clay. (Very Soft)		
5		2" SS	6'-8'	2.0	WOR WOR WOR WOR	0		SAA. (Very Soft)		
		Ost.	8'-10'	2.0	NA	NA		Dark brown SILT (on top). SILT and CLAY (on bottom). Cc = 0.9, Cu = 51.9, MC = 27.2, WD = 112.7, DD = 88.6.		
550		2" SS	10'-12'	1.7	3 12 13 19	25		Grey to brown SILT, trace fine sand. (Very Stiff) LL = 22, PL = 15, PI = 7.		
10		2" SS	12'-14'	1.5	16 19 23 24	42		Gray to brown SILT and CLAY, trace fine to coarse sand. (Hard)		
		Boring Terminated at 14.0' bss. Too dense for shelly tube from 14'-16' bss.								Boring backfilled to sediment surface with 5 bags of bentonite chips.



Remarks: Modified Burmister classification system used.
 SS = split spoon; Ost. = osterberg sampler; bss = below sediment surface; NA = Not Applicable/Available; WOR = weight of rod; SAA = same as above; HSA = hollow stem auger; Cc = coefficient of gradation; Cu = uniformity coefficient; MC = moisture content (%); WD = wet density (pcf); DD = dry density (pcf); OC = organic content (%); LL = liquid limit; PL = plastic limit; PI = plasticity index; Su = undrained shear strength (psf)
 140 lb auto hammer used.
 Water Depth (at time of drilling) = 18.0 ft.

Calculation Sheet

Client: Navistar, Inc.

Project: CI000664.0037.00001

Prepared by: GRM

Date: 05/10/12

Title: South Slip Sediment Cap Design, Former Wisconsin Steel Works

Reviewed By: APC

Date: 05/11/12

Subject: Bearing Capacity of Soft Sediments in the South Slip

OBJECTIVE: Determine the bearing capacity of the soft sediments within the South Slip and the factor of safety against bearing failure for the proposed sand cap and fill. The bearing capacity of armor layer is not considered.

REFERENCES:

1. Das, Braja M. *Principles of Geotechnical Engineering: Sixth Edition*. Thompson. Toronto, Canada. 2006.
2. Das, Braja M. *Principles of Foundation Engineering: Fifth Edition*. Brooks/Cole. Pacific Grove, CA. 2004.

ASSUMPTIONS:

1. Bearing capacity will be most critical near the eastern section of the slip and on the slopes along the southern wall of the slip. Protective armoring, 2" D50 aggregate, will be placed throughout the slip to prevent significant scour from propeller wash and river currents. Significant amounts of fill may be placed on the upper regions of the south slopes to create stable slope geometries.
2. Bearing failure may occur through general or local bearing failure surfaces.
3. The parameters used in this analysis are derived from geotechnical tests performed on samples from borings CL-6, CL-7, and CL-8. The location of each boring can be seen on the attached Figure D3-1. Additional information can be found in the attached boring logs and lab results.
4. All sediments and cap materials are submerged.
5. The cap or armoring material is assumed to be placed in 3' wide strips on the surface of the existing sediment. The cap is assumed to be comprised of 1.0' of sand with a submerged unit weight of 62 pcf and 0.5' of aggregate with a D50 of 2". An additional 3.0' of sand was assumed to be placed as fill in some areas.
6. The soft sediments encountered at the slip are primarily elastic silt (MH). The soil

Calculation Sheet

parameters for the soft sediment were estimated based on the lab testing and typical values presented in Reference 1.

7. Parameters used in this evaluation are provided in the table below:

Parameter	Symbol	Value / Range	Unit	Comments
Width of cap material placed in each pass	B	3	ft	Assumed value
Dry unit weight of sediment	γ_d	61.3	pcf	Actual range: 44.6 - 88.6 (CL-6 – CL-8), 40.5 at CL-2
Initial void ratio in sediment	e_0	2.080		Actual range: 2.080 - 2.289 (CL-6 – CL-8), 2.663 at CL-2
Depth of foundation below sediment surface	D_f	0	ft	Design
Undrained friction angle of soft sediments	Φ	26	°	From Reference 1
Range of Φ considered in parametric study	Phi	0 - 30	°	
Sediment cohesion	c	120	psf	Actual range: 110.0 - 173.0
Range of c considered in parametric study	c_{var}	100 - 130	psf	
Submerged unit weight of sand	γ_{sand}	62	pcf	~125 pcf dry density of clean sand
Submerged unit weight of aggregate	γ_{stone}	72.6	pcf	~135 pcf dry density of aggregate
Thickness of cap	t	1.5 – 4.5	ft	Design

CALCULATIONS:

Terzaghi's bearing capacity equation for strip footings was used to calculate the bearing capacity of the South Slip sediments. This method is presented in Reference 2, and also shown in the attached calculation sheets. This equation was used to calculate a "typical" ultimate bearing capacity for the soft sediments at the site. A parametric study was then performed to determine the sensitivity of the anticipated strengths to changes in undrained shear strength and friction angle.

Due to the unconsolidated nature of the sediment at the South Slip, bearing capacity was calculated for both general failure (often used with dense/stiff sediment) and local failure (used with softer sediments).

SUMMARY OF RESULTS:

A set of typical soft sediment parameters ($\Phi = 26^\circ$ and $c = 120$ psf) was used to estimate a factor of safety against bearing failure for the soft sediments in the South Slip. This set of parameters approximately represents the drained case, after the excess pore pressure has

Calculation Sheet

dissipated from beneath the cap. Based on the parameters used, the sediments will perform adequately and will have a factor of safety against bearing failure of approximately 12.75 and 4.41 for the 1.5' and 4.5' caps, respectively (assuming the local failure governs).

A range of variables ($\Phi = 0^\circ - 30^\circ$ and $c_{var} = 100 - 130$ psf) was used to evaluate the sensitivity and impact of variations in friction and cohesion on ultimate bearing capacity. For the undrained case, $\Phi \approx 0^\circ$, the soft sediments demonstrated a factor of safety against bearing failure of approximately 4.6 (1.5' cap) and 1.6 (1.5' cap above 3.0' of sand fill) for the local case. This is representative of the strengths in the sediment immediately after placing the cap.

Based on the parameters and analysis methods used, the soft sediments of the South Slip are anticipated to have adequate strength to resist bearing failure both at the time of cap placement and in the long term.

WSW - Bearing Capacity: 1 ft Sand

Terzaghi's bearing capacity theory

General equation for shallow, continuous, strip foundation:

$$\text{Continuous Foundation: } q_u = c'N_c + qN_q + 1/2\gamma N_\gamma$$

q_u = ultimate bearing capacity

c = soil cohesion

γ = unit weight of soil

D_f = depth of bearing surface below ground/sediment surface

$$q = \gamma D_f$$

N_c, N_q, N_γ = Bearing capacity factors

Cap material placed in strips across the slip. Each strip has width "B"

$$B := 3\text{ft}$$

All sediments in South Slip are submerged, submerged sediment unit weight should be used in bearing capacity calculations.

Submerged unit weight:

$$\gamma_d := 61.3 \frac{\text{lb}}{\text{ft}^3}$$

Dry unit weight of sediment

$$e_0 := 2.080$$

in-situ void ratio of sediment

$$\gamma_w := 62.4 \frac{\text{lb}}{\text{ft}^3}$$

Unit weight of water

$$\gamma_{\text{sub}} := \gamma_d - \frac{1}{(e_0 + 1)} \gamma_w = 41.04 \text{ ft}^{-3} \cdot \text{lb}$$

Submerged unit weight of sediment

Depth of foundation below ground surface:

$$D_f := 0\text{ft}$$

Undrained friction angle of soft sediments:

$$\phi := 26^\circ$$

Assumed value for drained silt (from Das).

Cohesion of sediment:

$$c_w := 120 \frac{\text{lb}}{\text{ft}^2}$$

Surcharge applied to footing.

$$q := D_f \cdot \gamma_{\text{sub}} = 0$$

Passive earth pressure coefficient.

$$K_{p\gamma} := \tan\left(\frac{\pi}{4} + \frac{\phi}{2}\right)^2 = 2.561$$

Terzaghi's bearing capacity factors:

$$N_q := \frac{e^{\left[2 \cdot \left(\frac{3\pi}{4} - \frac{\phi}{2}\right) \cdot \tan(\phi)\right]}}{2 \cos\left(\frac{\pi}{4} + \frac{\phi}{2}\right)^2} = 14.21$$

$$N_\gamma := \frac{1}{2} \left(\frac{K_{p\gamma}}{\cos(\phi)^2} - 1 \right) \tan(\phi) = 0.529$$

$$N_c := \cot(\phi) \cdot (N_q - 1) = 27.085$$

Ultimate bearing capacity of sediment (general failure surface):

$$q_u := c \cdot N_c + q \cdot N_q + \frac{1}{2} \cdot \gamma_{\text{sub}} \cdot B \cdot N_\gamma = 3.283 \times 10^3 \text{ ft}^{-2} \cdot \text{lb}$$

Load from weight of cap material (submerged):

$$\gamma_{\text{sand}} := 62.0 \frac{\text{lb}}{\text{ft}^3} \quad \text{Submerged unit weight of sand}$$

$$\gamma_{\text{stone}} := 72.6 \frac{\text{lb}}{\text{ft}^3} \quad \text{Submerged unit weight of 2" d50 armor stone}$$

$$t_{\text{sand}} := 1 \text{ ft} \quad \text{Thickness of sand layer}$$

$$t_{\text{gravel}} := 0.5 \text{ ft} \quad \text{Thickness of gravel layer}$$

$$w_{\text{cap}} := \gamma_{\text{sand}} \cdot t_{\text{sand}} + \gamma_{\text{stone}} \cdot t_{\text{gravel}} = 98.3 \text{ ft}^{-2} \cdot \text{lb}$$

Factor of safety against bearing failure when placing cap material:

$$\text{FOS} := \frac{q_u}{w_{\text{cap}}} = 33.396$$

Because the sediments in the South Slip are not consolidated, the bearing capacity should be calculated for the local failure assumption as well.

$$q_{u1} := \frac{2}{3} \cdot c \cdot N_{c1} + q \cdot N_{q1} + \frac{1}{2} \cdot \gamma_{\text{sub}} \cdot B \cdot N_{\gamma1}$$

All bearing capacity coefficients are calculated as above using the friction angle defined below:

$$\phi_{u1} := \text{atan}\left(\frac{2}{3} \tan(\phi)\right) = 0.314$$

$$q_{u1} := \frac{2}{3} \cdot c \cdot N_{c1} + q \cdot N_{q1} + \frac{1}{2} \cdot \gamma_{\text{sub}} \cdot B \cdot N_{\gamma1} = 1.253 \times 10^3 \text{ ft}^{-2} \cdot \text{lb}$$

$$\text{FOS}_1 := \frac{q_{u1}}{w_{\text{cap}}} = 12.75$$

Parametric study of bearing capacity with changes in undrained shear strength

$$c_{var} := 100 \frac{\text{lb}}{\text{ft}^2}, 101 \frac{\text{lb}}{\text{ft}^2} .. 130 \frac{\text{lb}}{\text{ft}^2}$$

$$c_{var1} := \frac{2}{3} \cdot 100 \frac{\text{lb}}{\text{ft}^2}, \frac{2}{3} \cdot 101 \frac{\text{lb}}{\text{ft}^2} .. \frac{2}{3} \cdot 130 \frac{\text{lb}}{\text{ft}^2}$$

$$f(c_{var}) := c_{var} \cdot N_c + q \cdot N_q + \frac{1}{2} \cdot \gamma_{sub} \cdot B \cdot N_\gamma$$

$$f_1(c_{var1}) := c_{var1} \cdot N_{c1} + q \cdot N_{q1} + \frac{1}{2} \cdot \gamma_{sub} \cdot B \cdot N_{\gamma1}$$

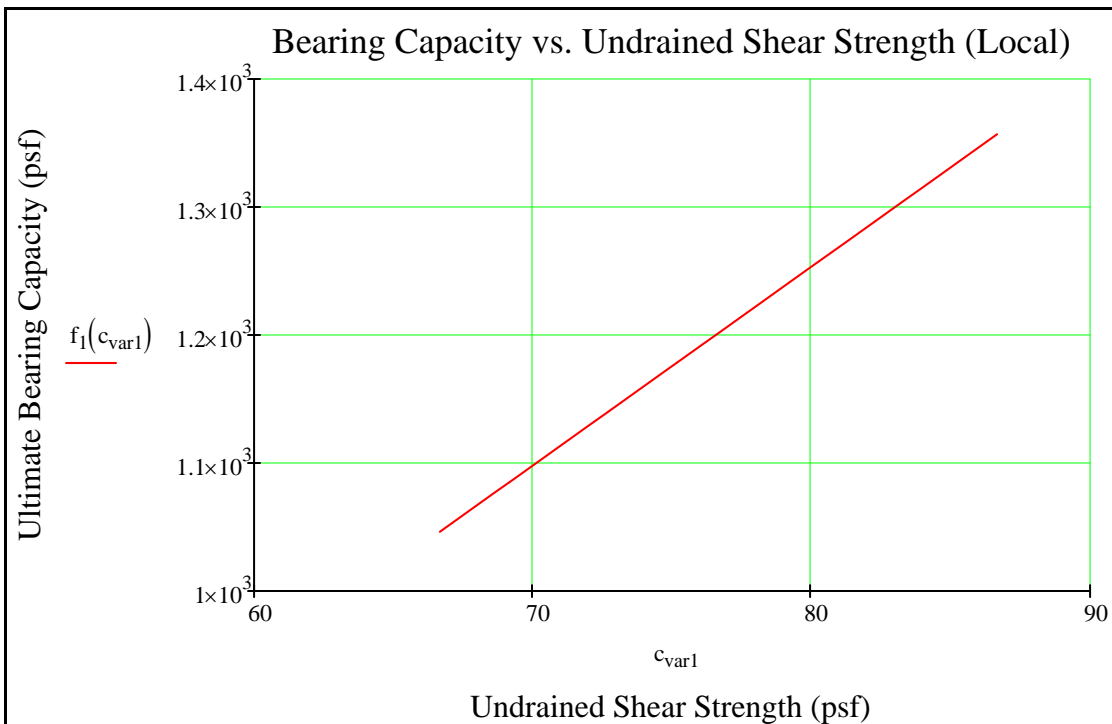
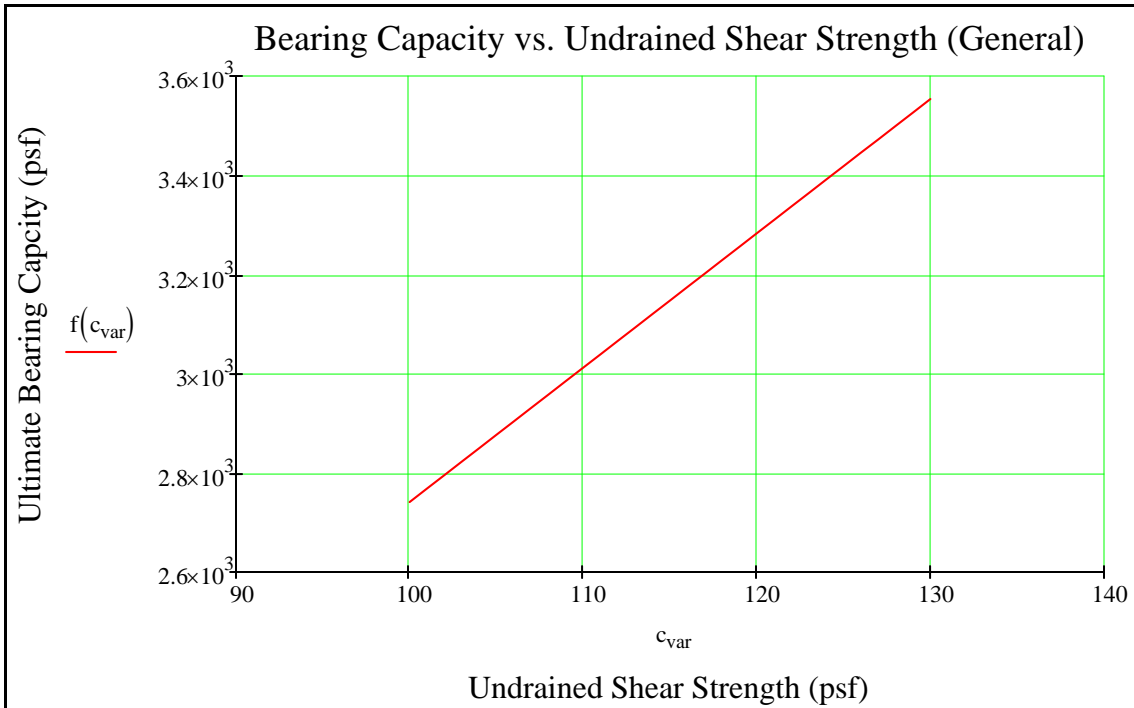

Program for parametric study of bearing capacity with changes in friction angle (local failure surface)

$$c = 120 \text{ ft}^{-2} \cdot \text{lb}$$

$$q = 0$$

$$\gamma_{\text{sub}} = 41.04 \text{ ft}^{-3} \cdot \text{lb}$$

$$\text{Phi}_{\text{low}} := 0.0001 \text{ deg}$$

$$\text{Phi}_{\text{high}} := 36 \text{ deg}$$

$$\text{Phi}_{\text{int}} := 1 \text{ deg}$$

```

qulo(Philow, Phihigh, Phiint, q, c, B, γsub) :=
int ←  $\frac{(\text{Phi}_{\text{high}} - \text{Phi}_{\text{low}})}{\text{Phi}_{\text{int}}}$ 
Phil ← 0
m ← 0
for z ∈ 0 .. int
    Philm ←  $\text{atan}\left(\frac{2}{3} \tan(\text{Phi}_{\text{low}} + z \cdot \text{Phi}_{\text{int}})\right)$ 
    KPhilm ←  $\tan\left(\frac{\pi}{4} + \frac{\text{Phil}_m}{2}\right)^2$ 
    Nqvm ←  $\frac{e^{\left[2 \cdot \left(\frac{3\pi}{4} - \frac{\text{Phil}_m}{2}\right) \cdot \tan(\text{Phil}_m)\right]}}{2 \cos\left(\frac{\pi}{4} + \frac{\text{Phil}_m}{2}\right)^2}$ 
    Nγvm ←  $\frac{1}{2} \left( \frac{K_{\text{Phil}_m}}{\cos(\text{Phil}_m)^2} - 1 \right) \tan(\text{Phil}_m)$ 
    Ncvm ←  $\cot(\text{Phil}_m) \cdot (N_{\text{qv}_m} - 1)$ 
    qulocm ←  $\frac{2}{3} c \cdot N_{\text{c}_v_m} + q \cdot N_{\text{qv}_m} + \frac{1}{2} \gamma_{\text{sub}} \cdot B \cdot N_{\gamma_v_m}$ 
    m ← m + 1
quloc

```

$$q_{u_local} := q_{ulo}(\text{Phi}_{\text{low}}, \text{Phi}_{\text{high}}, \text{Phi}_{\text{int}}, q, c, B, \gamma_{\text{sub}})$$

$$w := 0 \dots 36$$

$$p_w := w$$

Program for parametric study of bearing capacity with changes in friction angle (general failure surface)

$$q_{ug}(\text{Phi}_{low}, \text{Phi}_{high}, \text{Phi}_{int}, q, c, B, \gamma_{sub}) := \left[\begin{array}{l} \text{int} \leftarrow \frac{(\text{Phi}_{high} - \text{Phi}_{low})}{\text{Phi}_{int}} \\ \text{Phil} \leftarrow 0 \\ m \leftarrow 0 \\ \text{for } z \in 0 .. \text{int} \\ \quad \text{Phil}_m \leftarrow \text{atan}(\tan(\text{Phi}_{low} + z \cdot \text{Phi}_{int})) \\ \quad K_{\text{Phil}_m} \leftarrow \tan\left(\frac{\pi}{4} + \frac{\text{Phil}_m}{2}\right)^2 \\ \quad N_{q_{v_m}} \leftarrow \frac{e^{\left[2 \cdot \left(\frac{3\pi}{4} - \frac{\text{Phil}_m}{2}\right) \cdot \tan(\text{Phil}_m)\right]}}{2 \cos\left(\frac{\pi}{4} + \frac{\text{Phil}_m}{2}\right)^2} \\ \quad N_{\gamma_{v_m}} \leftarrow \frac{1}{2} \left(\frac{K_{\text{Phil}_m}}{\cos(\text{Phil}_m)^2} - 1 \right) \tan(\text{Phil}_m) \\ \quad N_{c_{v_m}} \leftarrow \cot(\text{Phil}_m) \cdot (N_{q_{v_m}} - 1) \\ \quad q_{uglo_m} \leftarrow c \cdot N_{c_{v_m}} + q \cdot N_{q_{v_m}} + \frac{1}{2} \gamma_{sub} \cdot B \cdot N_{\gamma_{v_m}} \\ m \leftarrow m + 1 \end{array} \right] q_{uglo}$$

$$q_{u_global} := q_{ug}(\text{Phi}_{low}, \text{Phi}_{high}, \text{Phi}_{int}, q, c, B, \gamma_{sub})$$

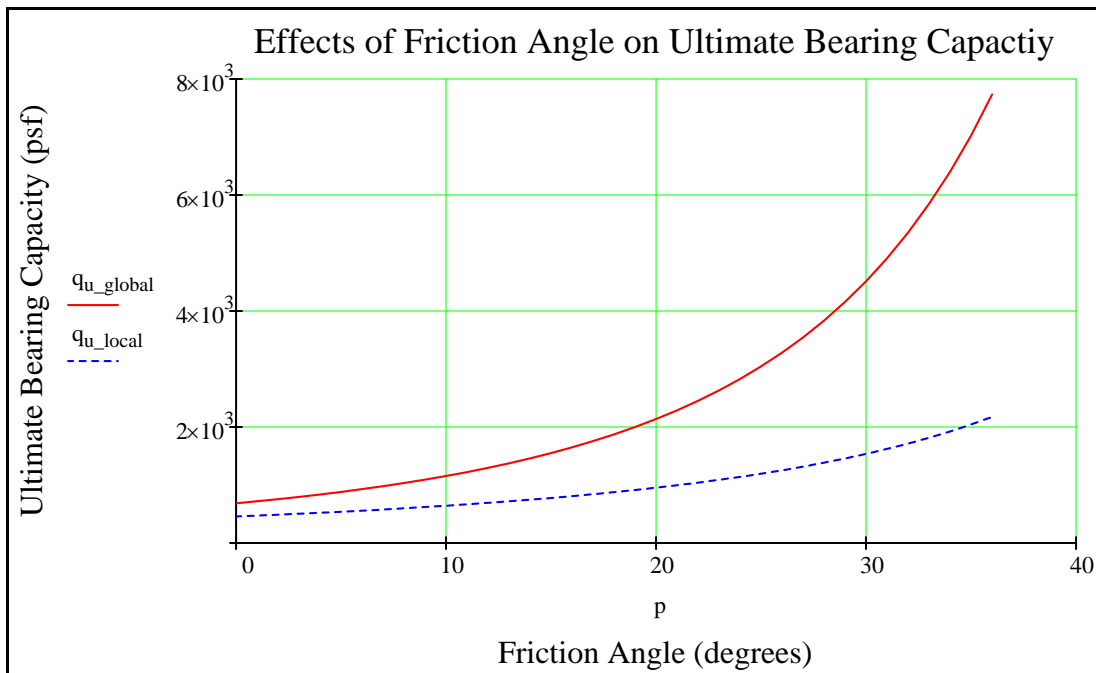

Factors of safety for bearing failure, undrained conditions:

$$FOS_g := \frac{q_{u_global_0}}{w_{cap}} = 6.973$$

$$FOS_l := \frac{q_{u_local_0}}{w_{cap}} = 4.649$$

WSW - Bearing Capacity

Terzaghi's bearing capacity theory

General equation for shallow, continuous, strip foundation:

$$\text{Continuous Foundation: } q_u = c'N_c + qN_q + 1/2\gamma N_\gamma$$

q_u = ultimate bearing capacity

c = soil cohesion

γ = unit weight of soil

D_f = depth of bearing surface below ground/sediment surface

$$q = \gamma D_f$$

N_c, N_q, N_γ = Bearing capacity factors

Cap material placed in strips across the slip. Each strip has width "B"

$$B := 3\text{ft}$$

All sediments in South Slip are submerged, submerged sediment unit weight should be used in bearing capacity calculations.

Submerged unit weight:

$$\gamma_d := 61.3 \frac{\text{lb}}{\text{ft}^3}$$

Dry unit weight of sediment

$$e_0 := 2.080$$

in-situ void ratio of sediment

$$\gamma_w := 62.4 \frac{\text{lb}}{\text{ft}^3}$$

Unit weight of water

$$\gamma_{\text{sub}} := \gamma_d - \frac{1}{(e_0 + 1)} \gamma_w = 41.04 \text{ ft}^{-3} \cdot \text{lb}$$

Submerged unit weight of sediment

Depth of foundation below ground surface:

$$D_f := 0\text{ft}$$

Undrained friction angle of soft sediments:

$$\phi := 26^\circ$$

Assumed value for drained silt (from Das).

Cohesion of sediment:

$$c := 120 \frac{\text{lb}}{\text{ft}^2}$$

Surcharge applied to footing.

$$q := D_f \cdot \gamma_{\text{sub}} = 0$$

Passive earth pressure coefficient.

$$K_{p\gamma} := \tan\left(\frac{\pi}{4} + \frac{\phi}{2}\right)^2 = 2.561$$

Terzaghi's bearing capacity factors:

$$N_q := \frac{e^{\left[2 \cdot \left(\frac{3\pi}{4} - \frac{\phi}{2}\right) \cdot \tan(\phi)\right]}}{2 \cos\left(\frac{\pi}{4} + \frac{\phi}{2}\right)^2} = 14.21$$

$$N_\gamma := \frac{1}{2} \left(\frac{K_{p\gamma}}{\cos(\phi)^2} - 1 \right) \tan(\phi) = 0.529$$

$$N_c := \cot(\phi) \cdot (N_q - 1) = 27.085$$

Ultimate bearing capacity of sediment (general failure surface):

$$q_u := c \cdot N_c + q \cdot N_q + \frac{1}{2} \cdot \gamma_{\text{sub}} \cdot B \cdot N_\gamma = 3.283 \times 10^3 \text{ ft}^{-2} \cdot \text{lb}$$

Load from weight of cap material (submerged):

$$\gamma_{\text{sand}} := 62.0 \frac{\text{lb}}{\text{ft}^3} \quad \text{Submerged unit weight of sand}$$

$$\gamma_{\text{stone}} := 72.6 \frac{\text{lb}}{\text{ft}^3} \quad \text{Submerged unit weight of 2" d50 armor stone}$$

$$t_{\text{sand}} := 4 \text{ ft} \quad \text{Thickness of sand layer}$$

$$t_{\text{gravel}} := 0.5 \text{ ft} \quad \text{Thickness of gravel layer}$$

$$w_{\text{cap}} := \gamma_{\text{sand}} \cdot t_{\text{sand}} + \gamma_{\text{stone}} \cdot t_{\text{gravel}} = 284.3 \text{ ft}^{-2} \cdot \text{lb}$$

Factor of safety against bearing failure when placing cap material:

$$\text{FOS} := \frac{q_u}{w_{\text{cap}}} = 11.547$$

Because the sediments in the South Slip are not consolidated, the bearing capacity should be calculated for the local failure assumption as well.

$$q_{u1} := \frac{2}{3} \cdot c \cdot N_{c1} + q \cdot N_{q1} + \frac{1}{2} \cdot \gamma_{\text{sub}} \cdot B \cdot N_{\gamma1}$$

All bearing capacity coefficients are calculated as above using the friction angle defined below:

$$\phi_{u1} := \text{atan}\left(\frac{2}{3} \tan(\phi)\right) = 0.314$$

$$q_{u1} := \frac{2}{3} \cdot c \cdot N_{c1} + q \cdot N_{q1} + \frac{1}{2} \cdot \gamma_{\text{sub}} \cdot B \cdot N_{\gamma1} = 1.253 \times 10^3 \text{ ft}^{-2} \cdot \text{lb}$$

$$\text{FOS}_1 := \frac{q_{u1}}{w_{\text{cap}}} = 4.408$$

Parametric study of bearing capacity with changes in undrained shear strength

$$c_{var} := 100 \frac{\text{lb}}{\text{ft}^2}, 101 \frac{\text{lb}}{\text{ft}^2} .. 130 \frac{\text{lb}}{\text{ft}^2}$$

$$c_{var1} := \frac{2}{3} \cdot 100 \frac{\text{lb}}{\text{ft}^2}, \frac{2}{3} \cdot 101 \frac{\text{lb}}{\text{ft}^2} .. \frac{2}{3} \cdot 130 \frac{\text{lb}}{\text{ft}^2}$$

$$f(c_{var}) := c_{var} \cdot N_c + q \cdot N_q + \frac{1}{2} \cdot \gamma_{sub} \cdot B \cdot N_\gamma$$

$$f_1(c_{var1}) := c_{var1} \cdot N_{c1} + q \cdot N_{q1} + \frac{1}{2} \cdot \gamma_{sub} \cdot B \cdot N_{\gamma1}$$

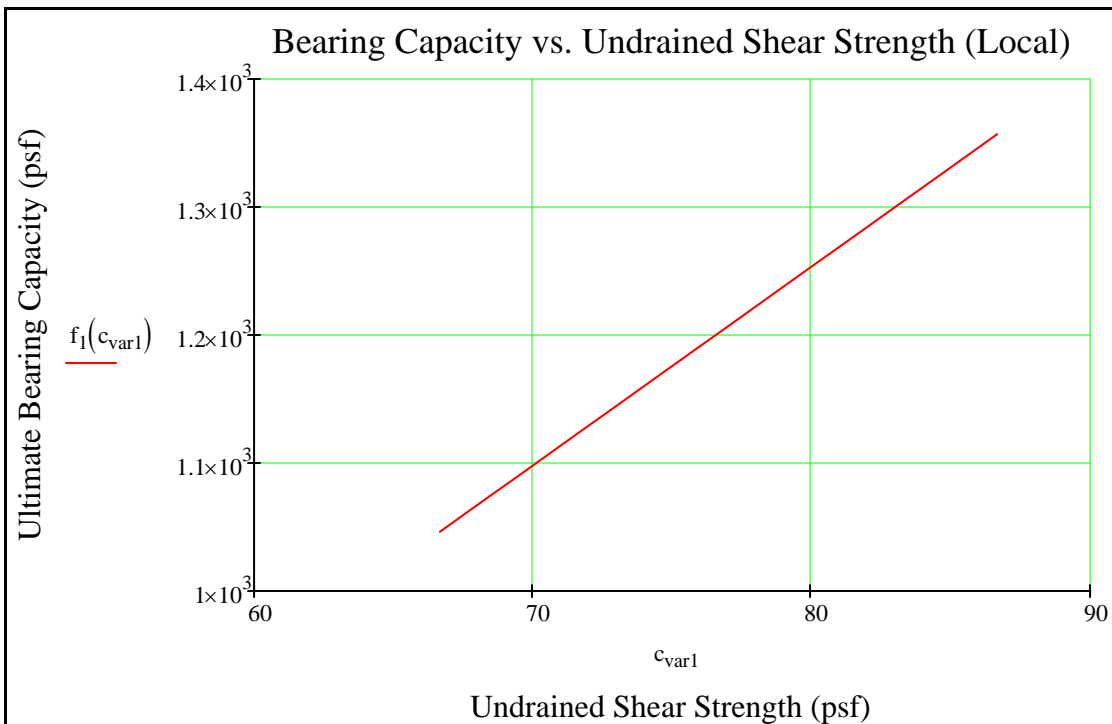
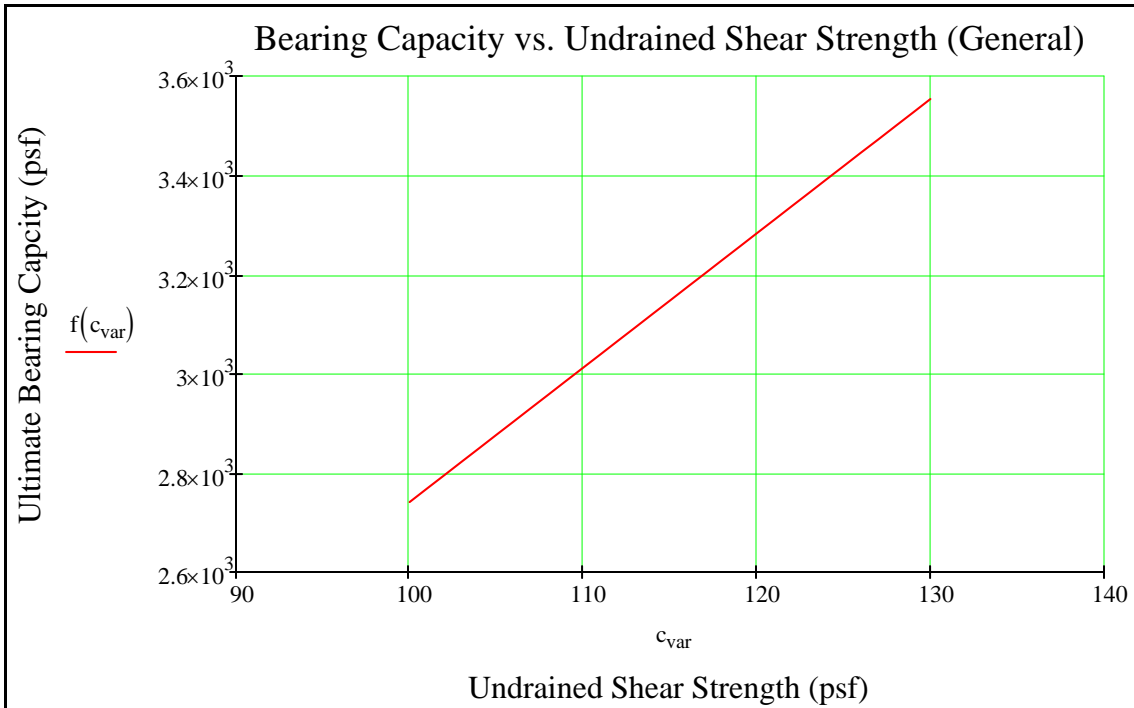

Program for parametric study of bearing capacity with changes in friction angle (local failure surface)

$$c = 120 \text{ ft}^{-2} \cdot \text{lb}$$

$$q = 0$$

$$\gamma_{\text{sub}} = 41.04 \text{ ft}^{-3} \cdot \text{lb}$$

$$\text{Phi}_{\text{low}} := 0.0001 \text{ deg}$$

$$\text{Phi}_{\text{high}} := 36 \text{ deg}$$

$$\text{Phi}_{\text{int}} := 1 \text{ deg}$$

```

qulo(Philow, Phihigh, Phiint, q, c, B, γsub) :=
int ←  $\frac{(\text{Phi}_{\text{high}} - \text{Phi}_{\text{low}})}{\text{Phi}_{\text{int}}}$ 
Phil ← 0
m ← 0
for z ∈ 0 .. int
  Philm ←  $\text{atan}\left(\frac{2}{3} \tan(\text{Phi}_{\text{low}} + z \cdot \text{Phi}_{\text{int}})\right)$ 
  KPhilm ←  $\tan\left(\frac{\pi}{4} + \frac{\text{Phil}_m}{2}\right)^2$ 
  Nqvm ←  $\frac{e^{\left[2 \cdot \left(\frac{3\pi}{4} - \frac{\text{Phil}_m}{2}\right) \cdot \tan(\text{Phil}_m)\right]}}{2 \cos\left(\frac{\pi}{4} + \frac{\text{Phil}_m}{2}\right)^2}$ 
  Nγvm ←  $\frac{1}{2} \left( \frac{K_{\text{Phil}_m}}{\cos(\text{Phil}_m)^2} - 1 \right) \tan(\text{Phil}_m)$ 
  Ncvm ←  $\cot(\text{Phil}_m) \cdot (N_{\text{qv}_m} - 1)$ 
  qulocm ←  $\frac{2}{3} c \cdot N_{\text{c}_m} + q \cdot N_{\text{qv}_m} + \frac{1}{2} \gamma_{\text{sub}} \cdot B \cdot N_{\gamma_{v}_m}$ 
  m ← m + 1
quloc

```

$$q_{u_local} := q_{ulo}(\text{Phi}_{\text{low}}, \text{Phi}_{\text{high}}, \text{Phi}_{\text{int}}, q, c, B, \gamma_{\text{sub}})$$

$$w := 0 \dots 36$$

$$p_w := w$$

Program for parametric study of bearing capacity with changes in friction angle (general failure surface)

$$q_{ug}(\text{Phi}_{low}, \text{Phi}_{high}, \text{Phi}_{int}, q, c, B, \gamma_{sub}) := \left[\begin{array}{l} \text{int} \leftarrow \frac{(\text{Phi}_{high} - \text{Phi}_{low})}{\text{Phi}_{int}} \\ \text{Phil} \leftarrow 0 \\ m \leftarrow 0 \\ \text{for } z \in 0 .. \text{int} \\ \quad \text{Phil}_m \leftarrow \text{atan}(\tan(\text{Phi}_{low} + z \cdot \text{Phi}_{int})) \\ \quad K_{\text{Phil}_m} \leftarrow \tan\left(\frac{\pi}{4} + \frac{\text{Phil}_m}{2}\right)^2 \\ \quad N_{qv_m} \leftarrow \frac{e^{\left[2 \cdot \left(\frac{3\pi}{4} - \frac{\text{Phil}_m}{2}\right) \cdot \tan(\text{Phil}_m)\right]}}{2 \cos\left(\frac{\pi}{4} + \frac{\text{Phil}_m}{2}\right)^2} \\ \quad N_{\gamma_v_m} \leftarrow \frac{1}{2} \left(\frac{K_{\text{Phil}_m}}{\cos(\text{Phil}_m)^2} - 1 \right) \tan(\text{Phil}_m) \\ \quad N_{cv_m} \leftarrow \cot(\text{Phil}_m) \cdot (N_{qv_m} - 1) \\ \quad q_{uglo_m} \leftarrow c \cdot N_{cv_m} + q \cdot N_{qv_m} + \frac{1}{2} \gamma_{sub} \cdot B \cdot N_{\gamma_v_m} \\ m \leftarrow m + 1 \\ q_{uglo} \end{array} \right.$$

$$q_{u_global} := q_{ug}(\text{Phi}_{low}, \text{Phi}_{high}, \text{Phi}_{int}, q, c, B, \gamma_{sub})$$

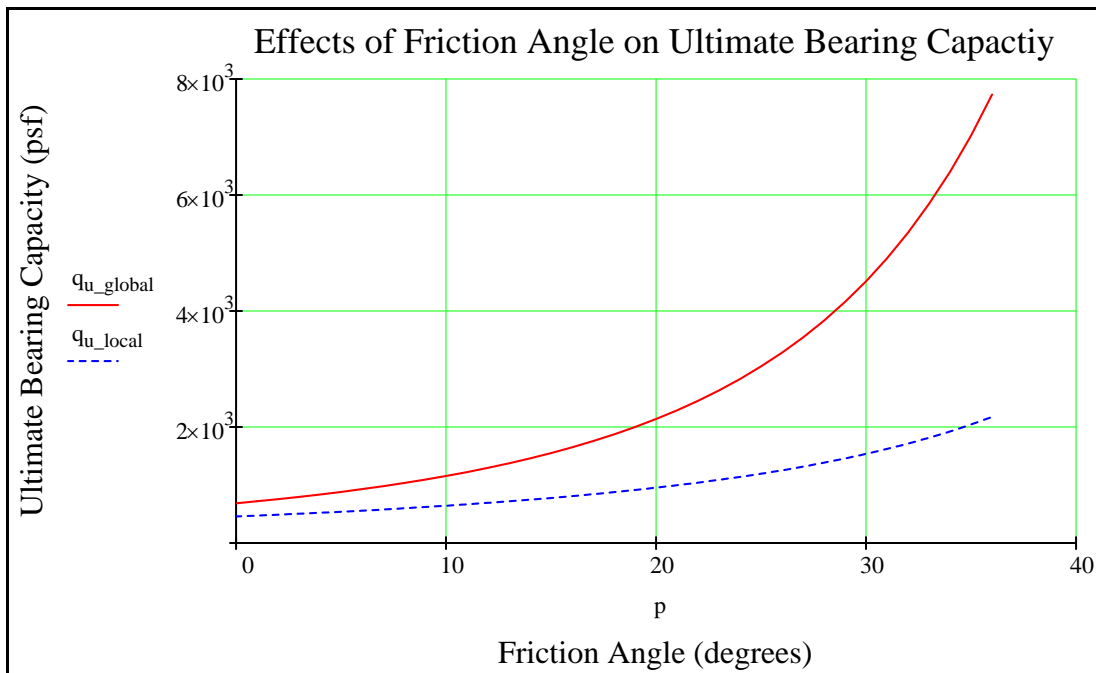

Factors of safety for bearing failure, undrained conditions:

$$FOS_g := \frac{q_{u_global_0}}{w_{cap}} = 2.411$$

$$FOS_l := \frac{q_{u_local_0}}{w_{cap}} = 1.607$$

CITY:(SYRACUSE,NY) DIV:(GROUP,ENCAD) DR:(SR,BLL) LD:(SBELL) PIC:() PN:(G,VANDERLAAN) TM:(G,VANDERLAAN) LVR:(ORION#:"OFF=REF") PLOTSTYLETABLE:PLT\FULL.CTB PLOTTED:6/9/2011 2:07 PM BY:BELL,STEVEN
G:\ENVCAD\SYRACUSE\ACT\CI000664\032\00001\DWG\00664g94.dwg LAYOUT: 1_SAVED: 6/9/2011 1:51 PM ACADVER: 18.1S (LMS TECH) PAGESETUP: PDF D2B

XREFS: 00664x01 00664x00
IMAGES: PROJECTNAME: --

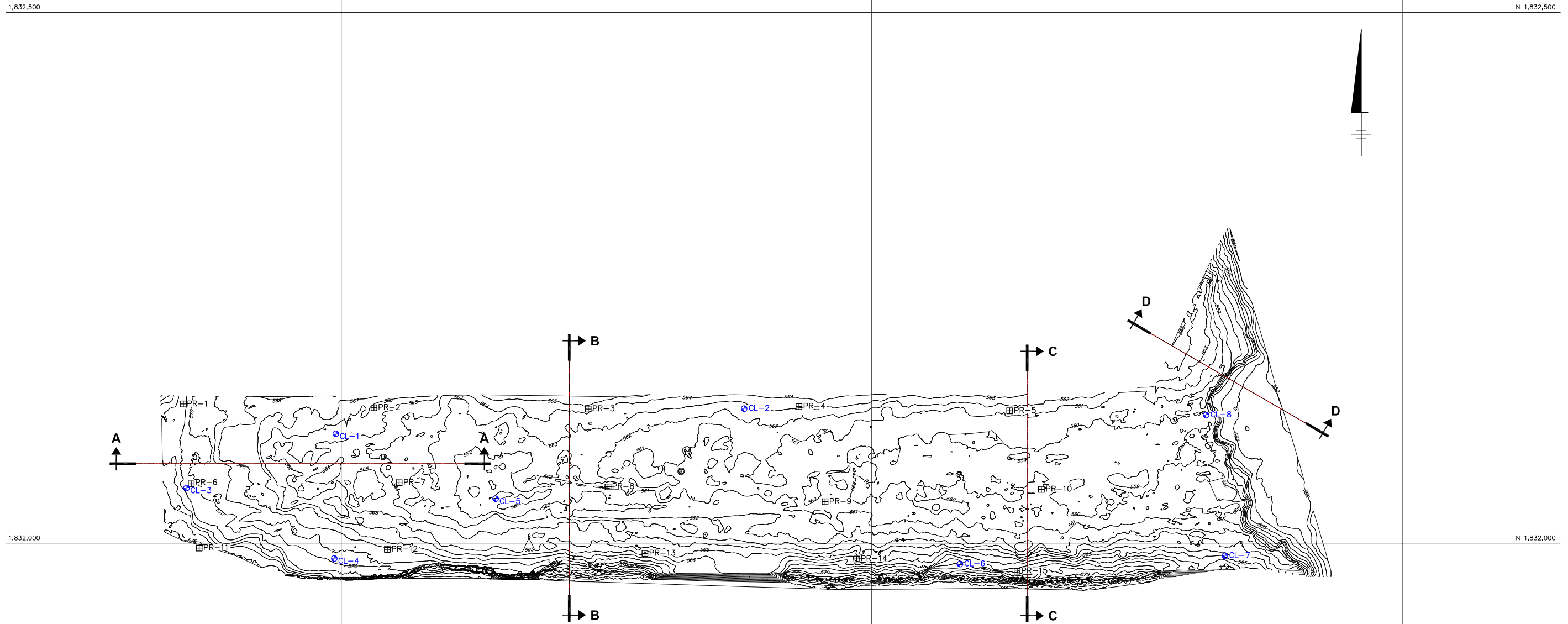

GENERAL PLAN

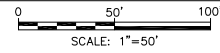

LEGEND:

- PR-# SEDIMENT PROBING LOCATION
- CL-# BORE HOLE LOCATION

FORMER WISONSIN STEEL WORKS
CHICAGO, IL
SOUTH SLIP REMEDIAL ACTION ALTERNATIVES

GENERAL PLAN



FIGURE
D3-1

Soil Data from WSW PDI, Spring 2011.

UU Test 1-D Consolidation Test Results

Sample Location	Sample Depth (ft bss)	Gravel Content (%)	Sand Content (%)	Fines Content (%)	Coefficient of Gradation (Cc)	Uniformity Coefficient (Cu)	Water Content (MC - %)	Wet Density (WD - pcf)	Dry Density (DD - pcf)	Liquid Limit (LL)	Plastic Limit (PL)	Plasticity Index (PI)	Organic Content (OC - %)	Undrained Shear Strength (Su = pcf)	Initial Void Ratio (e ₀)	Pre-consolidation Pressure (Pc)	Compression Index (Cc)	Recompression Index (Cr)	Specific Gravity	USCS Classification*	Soil Description**		
CL1	0 - 0.8	1.6	27.2	71.2	1.89	9.20	1.7						11.5						2.35	ML			
	2 - 4	0.0	15.2	84.8	1.66	6.60	78.3	78.5	44.1										2.23	MH	SILT, little sand		
CL2	2 - 4	0.0	6.9	93.1	0.76	4.78	105.9	83.3	40.5				7.6						2.74	MH	SILT, trace sand		
	4 - 6	1.8	12.8	85.4	1.43	4.14	80.8	84.4	46.7					2.663	0.63	0.58	0.04		MH				
	6 - 8									54	37	17								MH (v)			
	8 - 10	0.0	14.9	85.1	1.04	3.82	192.5	92.1	31.5										2.71	MH	SILT, little sand, little clay		
CL3	2 - 4	0.0	32.5	67.5	0.55	6.87	60.9	87.9	54.7										2.22	MH	SILT, some Sand, trace clay		
	4 - 6	0.0	17.2	82.8	1.32	6.22	2.7						18.3							MH	SILT, little sand, little clay		
	6 - 8	0.0	32.0	68.0	0.51	10.35	68.5	86.7	51.4											MH	SILT, some Sand, little clay		
	8 - 10						57.7	86.9	55.1										2.57	MH (v)			
CL4	4 - 6	0.0	35.0	65.0	0.68	21.41	72.1		43.2				18.6							MH			
	8 - 10	0.0	16.1	83.9	1.25	2.85	99.2	80.3	40.3											MH	SILT, some Sand, trace clay		
CL5	2 - 4	0.0	12.1	87.9			38.6	107.0	77.2											ML	CLAY, some Silt, trace sand		
	4 - 6	0.0	18.3	81.6	0.90	3.69	74.3	86.7	49.8										2.82	MH	SILT, little sand, little clay		
CL6	6 - 8						82.4		62.2	42	30	12	6.0							2.93	ML		
	8 - 10																				MH (v)		
	10 - 12						89.6	89.6	44.6	56	37	19	7.8							2.95	MH (v)		
	12 - 14	4.4	14.4	81.2	1.13	4.34	86.1	92.7	49.8	51	38	13	8.3	173.0						2.73	MH		
CL7	2 - 4	0.0	21.3	78.7	0.89	6.40				57	39	18									MH	SILT, some Sand, little clay	
	4 - 6	0.0	6.2	93.8	1.49	3.80	69.2			52	36	16		110.0						3.04	MH		
	6 - 8	0.2	12.9	86.9	1.33	6.99	76.0	100.0	56.8	47	36	11			2.289	0.71	0.54	0.04	2.99	ML			
	10 - 12	1.5	16.5	82.0	0.94	5.60	75.3	99.9	57.0	51	36	15		161.0	2.237	0.81	0.50	0.03	2.96	MH			
	14 - 16	0.9	8.4	90.7																	MH	SILT, some Clay, trace sand, trace gravel	
CL8	2 - 4	0.0	4.8	95.2			72.2		61.3	50	36	14	5.6	122.0	2.080	0.74	0.60	0.05	3.02	MH			
	4 - 6	0.2	14.5	85.3	0.76	7.03															MH		
	8 - 10	0.6	62.2	37.2	0.91	51.90	27.2	112.7	88.6												SM	SAND, some Silt, little clay, trace gravel	
	10 - 12									22	15	7										CL-ML	
	12 - 14																					ML (v)	
PDI-SS-1	0 - 0.8	24.6	38.3	37.1	0.54	59.13															SM	SAND, some Silt, some Gravel, trace clay	
PDI-SS-2	0 - 0.8	0.0	15.7	84.3	2.56	13.61															ML	SILT, little sand, little clay, trace gravel	
PDI-SS-3	0 - 0.8	20.2	39.1	40.7	1.29	17.07	2.5			40	29	11	7.9						2.45	SM	SAND and SILT, some Gravel, trace clay		
PDI-SS-4	0 - 0.8	0.7	13.8	85.5	1.62	9.19															ML		
PDI-SS-5	0 - 0.8	0.0	14.9	85.1	1.57	8.01	2.3						9.2								ML	SILT, little clay, little sand	

Cu - Uniformity Coefficient

Cc - Coefficient of Gradation

*Based on gradation and atterberg limits

**Based on % content by weight

Reporting discrepancy

Questionable value

Calculated value

Below soft sediment

Date Start/Finish: 3/30/11 Drilling Company: RDnP Driller's Name: Don Eger, Don Smith Drilling Method: HSA Casing Size: 4" ID Rig Type: Mobile B 4300 Track Rig Sampling Method: 2" Split Spoon / Osterberg, ASTM D1586/D158	Northing: 1831980.2 Easting: 1197083.1 Borehole Depth: 16' bss. Water Surface Elevation: 577.4' Descriptions By: Ron Kuhn / Pat Dougher	Well/Boring ID: CL-6 Client: Navistar, LLC Location: WSW South Slip, Chicago, IL <h1 style="text-align: center;">DRAFT</h1>
----------------------------------------------------------------------------------------------------------------------------------------------------------------------------------------------------------------------------------------------------------------------------------------------------	---------------------------------------------------------------------------------------------------------------------------------------------------------------------------------------------------	-----------------------------------------------------------------------------------------------------------------------------------------------------------------------

DEPTH	ELEVATION	Sample Run Number	Sample/Int/Type	Recovery (feet)	Blow Counts	N - Value	Geologic Column	Stratigraphic Description	Well/Boring Construction
-------	-----------	-------------------	-----------------	-----------------	-------------	-----------	-----------------	---------------------------	--------------------------

0		Ponar	0'-0.8'	0.8	NA	NA		Grey brown fine SAND, little coarse Sand, trace fine to coarse gravel.	
								No recovery.	
		2" SS	2'-4'	0.0	1/12"	1			
					WOR			No recovery.	
	56.0	2" SS	4'-6'	0.0	1/12"	1			
5					1/12"				
		Ost.	6'-8'	2.0	NA	NA		Dark brown SILT.	
								Dark brown SILT, trace fine sand, odor. (Very Soft)	
	55.5	2" SS	8'-10'	2.0	1/24"	1			
10								Dark brown SILT. MC = 101.2, WD = 89.6, DD = 44.6, OC = 7.8, LL = 56, PL = 37, PI = 19.	
		Ost.	10'-12'	2.0	NA	NA			
								SAA. MC = 86.1, WD = 92.7, DD = 49.8, OC = 8.3, Su = 173.	
		Ost.	12'-14'	2.0	NA	NA			
	55.0							Grey SILT, trace fine sand, trace fine gravel. (Hard)	
15		2" SS	14'-16'	1.2	8 15 19 23	34			
								Boring terminated at 16.0' bss.	
									Boring backfilled to sediment surface with 3 bags of bentonite chips.

 Infrastructure · Water · Environment · Buildings	Remarks: Modified Burmister classification system used. SS = split spoon; Ost. = osterberg sampler; bss = below sediment surface; NA = Not Applicable/Available; WOR = weight of rod; SAA = same as above; HSA = hollow stem auger; Cc = coefficient of gradation; Cu = uniformity coefficient; MC = moisture content (%); WD = wet density (pcf); DD = dry density (pcf); OC = organic content (%); LL = liquid limit; PL = plastic limit; PI = plasticity index; Su = undrained shear strength (psf) 140 lb auto hammer used. Water Depth (at time of drilling) = 13.0 ft.
-----------------------------------------------------------------------------------------------------------------------------------------	-------------------------------------------------------------------------------------------------------------------------------------------------------------------------------------------------------------------------------------------------------------------------------------------------------------------------------------------------------------------------------------------------------------------------------------------------------------------------------------------------------------------------------------------------------------------------------------------

Date Start/Finish: 3/31/11 Drilling Company: RDnP Driller's Name: Don Eger, Don Smith Drilling Method: HSA Casing Size: 4" ID Rig Type: Mobile B 4300 Track Rig Sampling Method: 2" Split Spoon / Osterberg, ASTM D1586/D158	Northing: 1831988.0 Easting: 1197332.8 Borehole Depth: 16 Water Surface Elevation: 577.2' Descriptions By: Ron Kuhn / Pat Dougher	Well/Boring ID: CL-7 Client: Navistar, LLC Location: WSW South Slip, Chicago, IL <h1>DRAFT</h1>
----------------------------------------------------------------------------------------------------------------------------------------------------------------------------------------------------------------------------------------------------------------------------------------------------	---------------------------------------------------------------------------------------------------------------------------------------------------------------------------------------------	-------------------------------------------------------------------------------------------------------------------------------------------

DEPTH	ELEVATION	Sample Run Number	Sample/Int/Type	Recovery (feet)	Blow Counts	N - Value	Geologic Column	Stratigraphic Description	Well/Boring Construction
-------	-----------	-------------------	-----------------	-----------------	-------------	-----------	-----------------	---------------------------	--------------------------

0		Ponar	0'-0.8'	0.8	NA	NA		Dark brown fine to coarse GRAVEL, trace silt, trace metal.	
		2" SS	2'-4'	2.0	WOR WOR WOR	0		Dark brown SILT, trace to little clay, odor. (Very Soft) Cc = 0.9, Cu = 6.4, LL = 57, PL = 39, PI = 18.	
560		Ost.	4'-6'	2.0	NA	NA		Dark brown SILT.	
5		Ost.	6'-8'	2.0	NA	NA		SAA. MC = 76.0, WD = 100.0, DD = 56.8.	
		2" SS	8'-10'	2.0	WOR WOR WOR	0		Dark brown SILT, trace intermittent fine sand laminae, trace fine gravel, odor. (Very Soft)	
555		Ost.	10'-12'	2.0	NA	NA		Dark brown SILT.	
10		2" SS	12'-14'	1.0	6 11 11 12	22		Grey to brown fine SAND and SILT, trace medium to coarse sand. (Medium Dense) MC = 74.1, WD = 99.9, DD = 57.4.	
		2" SS	14'-16'	1.7	12 14 16 22	30		Grey to brown SILT and CLAY, trace fine sand, trace fine gravel. (Very Stiff)	
15								Boring Terminated at 16.0' bss.	Boring backfilled to sediment surface with 3 bags of bentonite chips.



Remarks: Modified Burmister classification system used.
 SS = split spoon; Ost. = osterberg sampler; bss = below sediment surface; NA = Not Applicable/Available; WOR = weight of rod; SAA = same as above; HSA = hollow stem auger; Cc = coefficient of gradation; Cu = uniformity coefficient; MC = moisture content (%); WD = wet density (pcf); DD = dry density (pcf); OC = organic content (%); LL = liquid limit; PL = plastic limit; PI = plasticity index; Su = undrained shear strength (psf)
 140 lb auto hammer used.
 Water Depth (at time of drilling) = 13.0 ft.

Date Start/Finish: 3/31/11 Drilling Company: RDnP Driller's Name: Don Eger, Don Smith Drilling Method: HSA Casing Size: 4" ID Rig Type: Mobile B 4300 Track Rig Sampling Method: 2" Split Spoon / Osterberg, ASTM D1586/D158	Northing: 1832120.7 Easting: 1197315.1 Borehole Depth: 14' bss Water Surface Elevation: 577.2' Descriptions By: Ron Kuhn / Pat Dougher	Well/Boring ID: CL-8 Client: Navistar, LLC Location: WSW South Slip, Chicago, IL <h1 style="text-align: center;">DRAFT</h1>
----------------------------------------------------------------------------------------------------------------------------------------------------------------------------------------------------------------------------------------------------------------------------------------------------	--------------------------------------------------------------------------------------------------------------------------------------------------------------------------------------------------	-----------------------------------------------------------------------------------------------------------------------------------------------------------------------

DEPTH	ELEVATION	Sample Run Number	Sample/Int/Type	Recovery (feet)	Blow Counts	N - Value	Geologic Column	Stratigraphic Description	Well/Boring Construction
-------	-----------	-------------------	-----------------	-----------------	-------------	-----------	-----------------	---------------------------	--------------------------

0		Ponar	0'-0.8'	0.8	NA	NA		Dark brown SILT, little shells, trace coarse gravel.		
		Ost.	2'-4'	2.0	NA	NA		Dark brown SILT.		
555		2" SS	4'-6'	2.0	WOR WOR WOR WOR	0		Dark brown SILT, little clay. (Very Soft)		
5		2" SS	6'-8'	2.0	WOR WOR WOR WOR	0		SAA. (Very Soft)		
		Ost.	8'-10'	2.0	NA	NA		Dark brown SILT (on top). SILT and CLAY (on bottom). Cc = 0.9, Cu = 51.9, MC = 27.2, WD = 112.7, DD = 88.6.		
550		2" SS	10'-12'	1.7	3 12 13 19	25		Grey to brown SILT, trace fine sand. (Very Stiff) LL = 22, PL = 15, PI = 7.		
10		2" SS	12'-14'	1.5	16 19 23 24	42		Gray to brown SILT and CLAY, trace fine to coarse sand. (Hard)		
		Boring Terminated at 14.0' bss. Too dense for shelly tube from 14'-16' bss.								Boring backfilled to sediment surface with 5 bags of bentonite chips.

 ARCADIS <i>Infrastructure · Water · Environment · Buildings</i>	Remarks: Modified Burmister classification system used. SS = split spoon; Ost. = osterberg sampler; bss = below sediment surface; NA = Not Applicable/Available; WOR = weight of rod; SAA = same as above; HSA = hollow stem auger; Cc = coefficient of gradation; Cu = uniformity coefficient; MC = moisture content (%); WD = wet density (pcf); DD = dry density (pcf); OC = organic content (%); LL = liquid limit; PL = plastic limit; PI = plasticity index; Su = undrained shear strength (psf) 140 lb auto hammer used. Water Depth (at time of drilling) = 18.0 ft.
------------------------------------------------------------------------------------------------------------------------------------------------------------------	----------------------------------------------------------------------------------------------------------------------------------------------------------------------------------------------------------------------------------------------------------------------------------------------------------------------------------------------------------------------------------------------------------------------------------------------------------------------------------------------------------------------------------------------------------------------------------------------

Appendix E

Development of Background
Threshold Values

Navistar, Inc.

South Slip Sediment Cap Design Report

Development of Background Threshold Values

Former Wisconsin Steel Works
Chicago, Illinois

June 2012

1.	Introduction	1
2.	Methods	2
2.1	Data Set Definition	2
2.2	Exploratory Data Analysis	2
2.3	Probability Plots	2
2.4	Goodness-of-Fit Testing	3
2.5	Outlier Analysis	3
3.	Background Threshold Values	4
4.	Results	5
4.1	Mercury	5
4.2	Total HPAHs	5
4.3	Total LPAHs	5
4.4	Total PAHs	5
4.5	Total PCBs	6
5.	Conclusion	7
6.	References	8

Tables

E-1	Background Sediment Statistical Summary
E-2	Decision Tree for Statistic Used for Background Threshold Value
E-3	Background Threshold Values

Figures

E-1	Background Sampling Locations
E-2	Normal Quantile Plot for Mercury
E-3	Normal Quantile Plot for Total HPAHs
E-4	Normal Quantile Plot for Total HPAHs (two outliers removed)
E-5	Lognormal Quantile Plot for Total LPAHs

E-6	Normal Quantile Plot for Total PAHs
E-7	Normal Quantile Plot for Total PAHs (two outliers removed)
E-8	Gamma Quantile Plot for Total PCBs

1. Introduction

This appendix describes statistical Background Threshold Values (BTVs) developed for mercury (Hg), polychlorinated biphenyls (PCBs), and polycyclic aromatic hydrocarbons (PAHs) for the South Slip at the former Wisconsin Steel Works site, Chicago, Illinois. BTVs were based on data collected on November 20, 2008 from 0 to 0.5 feet below sediment surface (ft bss) at nine background locations (BK-01, BK-02, BK-03, BK-04, BK-05, BK-07, BK-08, BK-09, and BK-10) indicated on Figure E-1.

BTVs were calculated and selected based on an objective decision process to define performance standards that the cap would be designed to achieve. The approach involved goodness-of-fit (GOF) evaluations and probability plots used to: a) determine the overall distribution of each data set; and b) identify potential outliers that could elevate the BTV. Potential outliers were tested statistically and a 95/95 upper tolerance limit (UTL) was calculated with and without statistical outliers when applicable.

2. Methods

Sediment concentrations for five constituents were evaluated in this assessment, including mercury, total high molecular weight PAHs (HAPs), total low molecular weight PAHs (LPAHs), total PAHs, and PCBs. BTVs are typically represented by UTLs calculated from a background data set. Tolerance limits provide an interval within which at least a certain proportion of the population lies, with a specified probability that the stated interval does indeed “contain” that proportion of the population (USEPA 2006). For example, a 95/95 UTL indicates a value that contains 95% of the population (i.e., coverage) with 95% confidence.

Prior to calculating BTVs, a series of exploratory data analysis (EDA) steps and statistical analyses were implemented. The sections below summarize the methods selected and the corresponding results for each constituent.

2.1 Data Set Definition

BTVs were based on data collected on November 20, 2008 from 0 to 0.5 ft bss at nine background locations (BK-01, BK-02, BK-03, BK-04, BK-05, BK-07, BK-08, BK-09, and BK-10). Locations are indicated on Figure E-1. One duplicate was collected for PCBs and metals at station 5 (BK-05SED-PC). For the purposes of calculating statistics, the field duplicate sample result was averaged with the parent sample result. The data set is summarized in Table E-1.

2.2 Exploratory Data Analysis

The objective of EDA was to ensure that the data used to develop BTVs were representative of a single population and that each observation was within a plausible range of background conditions. Consistent with statistical guidance from USEPA (2006, 2009, 2010), data were evaluated for statistical outliers and multiple populations prior to conducting the analysis. This assessment was performed with USEPA’s (2010) ProUCL 4.1.00 software. For this analysis, the EDA steps included probability plots (i.e., quantile-quantile [Q-Q] plots), GOF testing, and an outlier analysis.

2.3 Probability Plots

Probability plots (or p-plots) serve multiple purposes in EDA for establishing background conditions. They allow for a visual inspection of the data distribution, which complements formal statistical tests for GOF. Inflection points or changes in slope can indicate that the data represent a mixture of multiple populations, which may reflect multiple background sources or a combination of background and site-related sources. Finally, p-plots can be

used to identify extreme values in the upper tail of a distribution, which may be indicative of potential outliers. The identification of potential outliers is the first step in an outlier analysis, which is an important component of EDA of background data.

Q-Q plots were generated for this analysis to evaluate fits to normal, lognormal, and gamma distributions. Q-Q plots show the quantiles of the empirical distribution versus the quantiles of the hypothesized distribution. A straight-line fit on a Q-Q plot provides evidence that the data are from a single population with the specified distribution. Values that deviate substantially from this line may represent potential outliers and may require further statistical outlier testing.

2.4 Goodness-of-Fit Testing

GOF testing is performed to determine if parametric or nonparametric statistical methods are most appropriate for calculating BTVs and conducting statistical tests for outliers. Consistent with the USEPA (2010) guidance, data were evaluated for fits to normal, lognormal, and gamma distributions at an alpha level (α) of 0.05 (95% significance level). Using USEPA's (2010) ProUCL 4.1.00 software, optimal statistical tests were applied depending on distribution and sample size (n ; e.g., normal and lognormal: Shapiro-Wilk Test for $n \leq 50$ or Lilliefors Test for $n > 50$, gamma: Kolmogorov-Smirnov Test).

2.5 Outlier Analysis

Potential outliers were identified based on the probability plots. Values that appeared to be extreme values in the upper tail of a distribution were visually identified (Figure E-3). Potential outliers were evaluated statistically using Dixon's test, as the sample size was less than 25, or the Interquartile Range (IQR) method (results exceeding 3 times the IQR).

- For total HPAHs, two potential outliers were identified and were determined to be statistically significant by Dixon's test (32,260 micrograms per kilogram [$\mu\text{g}/\text{kg}$] at BK-02SED-PC and 46,270 $\mu\text{g}/\text{kg}$ at BK-05SED-PC).
- For total PAHs, two potential outliers were identified and were determined to be statistically significant by Dixon's test and the IQR method, respectively (75,240 $\mu\text{g}/\text{kg}$ at BK-05SED-PC and 54,250 $\mu\text{g}/\text{kg}$ at BK-02SED-PC).

These statistical outliers were excluded from the BTV evaluation. No other outliers were identified.

3. Background Threshold Values

The 95/95 UTL is an appropriate statistic for calculating a BTV from a data set when the intent is to compare data from unimpacted locations with data from potentially impacted locations. A minimum of eight observations and five detections are needed in the background data set to calculate a 95/95 UTL (USEPA 2010). If insufficient data are available, the BTV may be approximated by the maximum detected concentration in the background data set.

Table E-2 summarizes the criteria for selecting the most reliable method of UTL calculation, in accordance with USEPA (2010), depending on sample size, degree of censoring, GOF testing results, and skewness (as determined by the standard deviation of the natural logarithm of the detections). The UTL was selected from among five possible methods: normal UTL, lognormal UTL, gamma UTL, Kaplan-Meier (KM) UTL, or nonparametric UTL. In general, normal and gamma 95/95 UTLs tend to yield the lowest values and the nonparametric UTL usually equates to the maximum detection. In addition, it is not uncommon for one of the parametric 95/95 UTLs to exceed the maximum detection in the background data set. This is more likely when the data set is small and/or the variance is high. The use of 95/95 UTLs in these cases introduces a source of uncertainty, but when the distribution fit is reasonable, this extrapolation may be preferable to scaling back to the maximum of a sample, which is an inherently unstable statistic. Both values were considered to determine if the choice would affect the overall findings of the background evaluation.

4. Results

4.1 Mercury

The BTV for mercury is 0.248 milligrams per kilogram (mg/kg) (Table E-3) based on the 95/95 UTL assuming a normal distribution. All nine samples were detected and ranged from 0.11 mg/kg (BK-01) to 0.21 mg/kg (BK-05). No outliers were identified based on inspection of the p-plots and the data are approximately normally distributed (Figure E-2). It is noted that the BTV exceeds the maximum value of 0.21 mg/kg (average of parent and field duplicate at BK-05); however, given the good fit of the data to a normal distribution, extrapolation of the BTV beyond the maximum detect was considered justified.

4.2 Total HPAHs

The BTV for total HPAHs is 25,910 $\mu\text{g}/\text{kg}$ (Table E-3) and is based on the maximum detection after excluding two statistical outliers. All nine samples were detected and ranged from 20,940 $\mu\text{g}/\text{kg}$ (BK-01) to 46,270 $\mu\text{g}/\text{kg}$ (BK-05). Two potential outliers were identified based on inspection of the normal p-plot (Figure E-3) and were identified as statistical outliers based on Dixon's test. Although the data excluding outliers fit a normal distribution (Figure E-4), the BTV was based on the maximum detect (excluding outliers) since the final data set contained insufficient samples (<8) to calculate a UTL (USEPA 2010).

4.3 Total LPAHs

The BTV for total LPAHs is 38,699 $\mu\text{g}/\text{kg}$ (Table E-3) and is based on the lognormal 95/95 UTL. All nine samples were detected and ranged from 11,690 $\mu\text{g}/\text{kg}$ (BK-08) to 28,970 $\mu\text{g}/\text{kg}$ (BK-05). No potential outliers were identified based on inspection of the normal p-plot (Figure E-5). It is noted that the BTV exceeds the maximum value of 28,970 $\mu\text{g}/\text{kg}$; however, given the good fit of the data to a lognormal distribution, extrapolation of the BTV beyond the maximum detect was considered justified.

4.4 Total PAHs

The BTV for total PAHs is 39,620 $\mu\text{g}/\text{kg}$ (Table E-3) and is based on the maximum detection after excluding two statistical outliers. All nine samples were detected and ranged from 34,780 $\mu\text{g}/\text{kg}$ (BK-08) to 75,240 $\mu\text{g}/\text{kg}$ (BK-05). Two potential outliers were identified based on inspection of the normal p-plot (Figure E-6) and were identified as statistical outliers based on Dixon's test. Although the data excluding outliers fit a normal distribution (Figure E-7), the BTV was based on the maximum detect (excluding outliers)

since the final data set contained insufficient samples (<8) to calculate a UTL (USEPA 2010).

4.5 Total PCBs

The BTV for total PCBs is 2,858 $\mu\text{g}/\text{kg}$ (Table E-3) and is based on a gamma 95/95 UTL. All nine samples were detected and ranged from 590 $\mu\text{g}/\text{kg}$ (BK-01) to 2,700 $\mu\text{g}/\text{kg}$ (BK-02). No potential outliers were identified based on inspection of the normal p-plot (Figure E-8). It is noted that the BTV exceeds the maximum value of 2,700 $\mu\text{g}/\text{kg}$; however, given the good fit of the data to a gamma distribution, extrapolation of the BTV beyond the maximum detect was considered justified.

5. Conclusion

The purpose of this assessment was to develop BTVs for Mercury, PCBs, and PAHs in the sediment of the South Slip. BTVs were based on data collected on November 20, 2008 from 0 to 0.5 ft bss at nine background locations (BK-01, BK-02, BK-03, BK-04, BK-05, BK-07, BK-08, BK-09, and BK-10). Several data sets included statistical outliers and the proposed BTV is conservatively based on the data set excluding statistical outliers. BTVs are summarized below.

Constituent	Proposed BTV	Remarks
Mercury	0.248 mg/kg	95/95UTL assuming a normal distribution
HPAHs	25,910 µg/kg	Maximum detection (after excluding two statistical outliers)
LPAHs	38,699 µg/kg	Lognormal 95/95 UTL
Total PAHs	39,620 µg/kg	Maximum detection (after excluding two statistical outliers)
Total PCBs	2,858 µg/kg	Gamma 95/95 UTL

6. References

USEPA. 2006. Data Quality Assessment: Statistical Methods for Practitioners. United States Environmental Protection Agency, Office of Environmental Information, Washington, D.C. EPA QA/G-9S. EPA/240/B-06/003. Available online at <http://www.epa.gov/quality1/qs-docs/g9s-final.pdf>. February.

USEPA. 2009. Statistical Analysis of Groundwater Monitoring Data at RCRA Facilities, Unified Guidance. United States Environmental Protection Agency, Office of Resource Conservation and Recovery, Program Implementation and Information Division. EPA 530-R-09-007. Available online at <http://www.epa.gov/waste/hazard/correctiveaction/resources/guidance/sitechar/gwstats/unified-guid-toc.pdf>. March.

USEPA. 2010. ProUCL Version 4.1 Technical Guide (Draft). Prepared by Anita Singh, PhD, Lockheed Martin Environmental Services, Las Vegas, Nevada, and Ashok K. Singh, PhD, Department of Hotel Management, University of Nevada, Las Vegas. United States Environmental Protection Agency, Office of Research and Development, Washington, D.C. EPA/600/R-07/041. May.

TABLE E-1. BACKGROUND SEDIMENT STATISTICAL SUMMARY

**SOUTH SLIP
FORMER WISCONSIN STEEL WORKS
CHICAGO, ILLINOIS**

Parameter Group	Analyte	Units	Frequency of Detection		Range of Detection Limits	Summary Statistics of Detected Concentrations				Location of Maximum Detect
						Minimum	Maximum	Mean	SD	
Inorganics	Mercury	mg/kg	9 / 9	100%	NA	0.11	0.21	0.15	0.03	BK-05SED-PC
	PAHs									
	Total HMW PAHs	ug/kg	9 / 9	100%	NA	20,940	46,270	26,892	8,022	BK-05SED-PC
	Total LMW PAHs	ug/kg	9 / 9	100%	NA	11,690	28,970	16,384	5,652	BK-05SED-PC
	Total PAHs	ug/kg	9 / 9	100%	NA	34,780	75,240	43,277	13,378	BK-05SED-PC
PCBs	Total PCBs	ug/kg	9 / 9	100%	NA	590	2,700	1,206	758.8	BK-02SED-PC

Abbreviations:

HMW = high molecular weight
 LMW = low molecular weight
 mg/kg = milligram(s) per kilogram
 NA = not available; not applicable
 PAHs = polycyclic aromatic hydrocarbons
 PCBs = polychlorinated biphenyl
 SD = standard deviation
 ug/kg = microgram(s) per kilogram

TABLE E-2. DECISION TREE FOR STATISTIC USED FOR BACKGROUND THRESHOLD VALUE

**SOUTH SLIP
FORMER WISCONSIN STEEL WORKS
CHICAGO, ILLINOIS**

Sample Size	Censoring	Distribution ¹	Skewness ²	Normality ³	Statistic Used for BTV ^{4, 5}
n < 8	Detects < 8	NA	NA	NA	Maximum detect
n ≥ 8	Detects < 5	NA	NA	NA	Maximum detect
	Detects ≥ 5 ND = 0	N N and LN N and LN and G	NA	NA	Normal 95/95 UTL
		LN	NA	NA	Lognormal 95/95 UTL
		G LN and G	NA	X ^(1/3) ~ N X ^(1/4) ~ N	WH Gamma 95/95 UTL HW Gamma 95/95 UTL
		not N, LN, or G	NA	NA	Nonparametric 95/95 UTL ⁶
	Detects ≥ 5 ND > 0	not N, LN, or G	Mild	NA	Kaplan-Meier 95/95 UTL
			Moderate to High	NA	Nonparametric 95/95 UTL ⁶
		N, LN, or G	NA	NA	Kaplan-Meier 95/95 UTL

Abbreviations:

95/95 UTL = one-sided 95 percent upper confidence limit for the 95th percentile
 BTV = background threshold value
 G = gamma distribution
 HW = Hawkins-Wixley
 LN = lognormal distribution
 n = sample size
 N = normal distribution
 NA = not applicable
 ND = nondetects
 WH = Wilson-Hilferty

Notes:

- Goodness-of-fit test at α=0.05 significance level implemented with ProUCL Version 4.1.00 (USEPA, 2010). Distributions tested for normality or lognormality using Shapiro Wilk (n ≤ 50) and Lilliefors (n > 50) and for gamma distribution using Kolmogorov-Smirnov.
- Skewness estimated using the standard deviation of the log-transformed data (detects only) (σ). Datasets with σ ≤ 1.0 are considered mildly skewed, whereas datasets with σ > 1.0 are considered moderately to highly skewed (USEPA, 2010).
- Gamma UTL selection depends on the normality of the transformed X. Compare the normality tests for X^{1/3} and X^{1/4} to determine if Wilson-Hilferty (WH) or Hawkins-Wixley (HW) more closely approximates the gamma UTL (USEPA, 2010).
- Use of UTLs for establishing upper bound for background is consistent with USEPA guidance (1989; 1992; 2009). Requirements for minimum sample size and number of detects, and hierarchy for preferred distributions are consistent with USEPA (2009).
- If the result is greater than the maximum detected concentration, then BTV = maximum detect.
- Nonparametric UTL is based on a rank-ordered value in the data set. For sample sizes n < 92, the nonparametric 95/95 UTL is equivalent to the maximum detect (Conover, 1999).

References:

Conover, W.J. 1999. Practical Nonparametric Statistics. Third Edition. John Wiley & Sons.
 USEPA. 1989. Statistical Analysis of Ground-water Monitoring Data at RCRA Facilities. Interim Final Guidance. Office of Solid Waste, Waste Management Division. April.
 USEPA. 1992. Statistical Analysis of Ground-water Monitoring Data at RCRA Facilities. Addendum to Interim Final Guidance. Office of Solid Waste. July.
 USEPA. 2009. Statistical Analysis of Groundwater Monitoring Data at RCRA Facilities, Unified Guidance. Office of Resource Conservation and Recovery. EPA/530/R-09/007. March.
 USEPA. 2010. ProUCL Version 4.1.00 Technical Guide (Draft). Office of Research and Development. EPA/600/R-07/041. May.

TABLE E-3. BACKGROUND THRESHOLD VALUES

**SOUTH SLIP
FORMER WISCONSIN STEEL WORKS
CHICAGO, ILLINOIS**

Parameter Group	Analyte	Units	Outliers ¹	N	Detects	FOD %	Distribution ²	Skewness ³	Maximum Detect	95 th Percentile ⁴	95/95 UTL ⁵	UTL Method ⁶	Final BTV ⁷
Inorganics PAHs	Mercury	mg/kg	None	9	9	100%	N/G/Ln	0.291	0.205	0.204	0.248	Normal 95/95 UTL	0.248
	Total HPAHs	ug/kg	32,260 *	9	9	100%	NP	2.141	46,270	40,666	46,270	Nonparametric 95/95 UTL	25,910 (max detect excluding outliers)
	Total HPAHs (excl. 2 outliers)	ug/kg	46,270 *	7	7	100%	N/G/Ln	-0.00998	25,910	26,577	NA	Max Detect	
	Total LPAHs	ug/kg	None	9	9	100%	Ln	1.717	28,970	25,608	38,699	Lognormal 95/95 UTL	38,699
	Total PAHs	ug/kg	75,240 *	9	9	100%	NP	2.14	75,240	66,844	75,240	Nonparametric 95/95 UTL	39,620 (max detect excluding outliers)
	Total PAHs (excl. 2 outliers)	ug/kg	54,250 *	7	7	100%	N/G/Ln	-0.0872	39,620	40,582	NA	Max Detect	
PCBs	Total PCBs	ug/kg	None	9	9	100%	G/Ln	1.405	2,700	2,679	2,858	WH Gamma 95/95 UTL	2,858

Abbreviations:

95/95 UTL = one-sided upper 95 percent confidence limit for the 95th percentile
 BTV = background threshold value
 FOD = frequency of detection
 G = gamma
 GOF = goodness-of-fit
 HPAHs = high molecular weight polycyclic aromatic hydrocarbons
 IQR = interquartile range (75th - 25th percentiles)
 Ln = lognormal
 LPAHs = low molecular weight polycyclic aromatic hydrocarbons
 max = maximum
 mg/kg = milligram(s) per kilogram
 N = normal
 NP = nonparametric
 PAHs = polycyclic aromatic hydrocarbons
 PCBs = polychlorinated biphenyls
 ug/kg = microgram(s) per kilogram
 WH = Wilson-Hilferty

Notes:

- Identification of potential outliers based on quantile plots for the listed distribution. Potential outliers were initially retained in the statistical analysis. Potential outliers determined to be statistically significant at $\alpha=0.05$ using Dixon's test ($n < 25$, $\%ND < 15\%$, normal/lognormal) were removed and statistics were recalculated. Dixon test outliers are identified with an asterisk.
- Distribution assessed by GOF tests based on detected values only conducted using ProUCL 4.1.00 at a 95% confidence level ($\alpha = 0.05$). Distribution for BTV selected according to the following hierarchy: normal > gamma > lognormal > nonparametric.
- Skewness estimated using the standard deviation of the log-transformed data (detects only) (σ). Datasets with $\sigma \leq 1.0$ are considered mildly skewed, whereas datasets with $\sigma > 1.0$ are moderately to highly skewed (USEPA, 2010). See Table 2 for how skewness informs the choice of UTL methods.
- Percentile calculation method corresponds to the UTL method in order to show correspondence with upper confidence limit on the 95th percentile (i.e., 95/95 UTL). Nonparametric 95th percentile is based on linear interpolation of rank-ordered statistics using the following formula for the i th ranked value: $\text{percentile} = i / (n+1)$. For $n < 19$, the maximum is less than the 95th percentile (i.e., $n/(n+1) = 19 / (19+1) = 0.950$) and result is listed as "--". For normal, gamma, and lognormal distributions, 95th percentile is calculated by standard parametric equations.
- Unless otherwise noted, UTLs only calculated for analytes with at least 8 total observations and 5 detected observations (USEPA 2010). Calculation method selected in accordance with Table 2.
- UTL method selected as in accordance with decision tree presented in Table 2.
- Final BTV selected in accordance with decision tree presented in Table 2.

References:

USEPA. 2010. ProUCL Version 4.1.00 Technical Guide. Office of Research and Development. EPA/600/R-07/041. May.

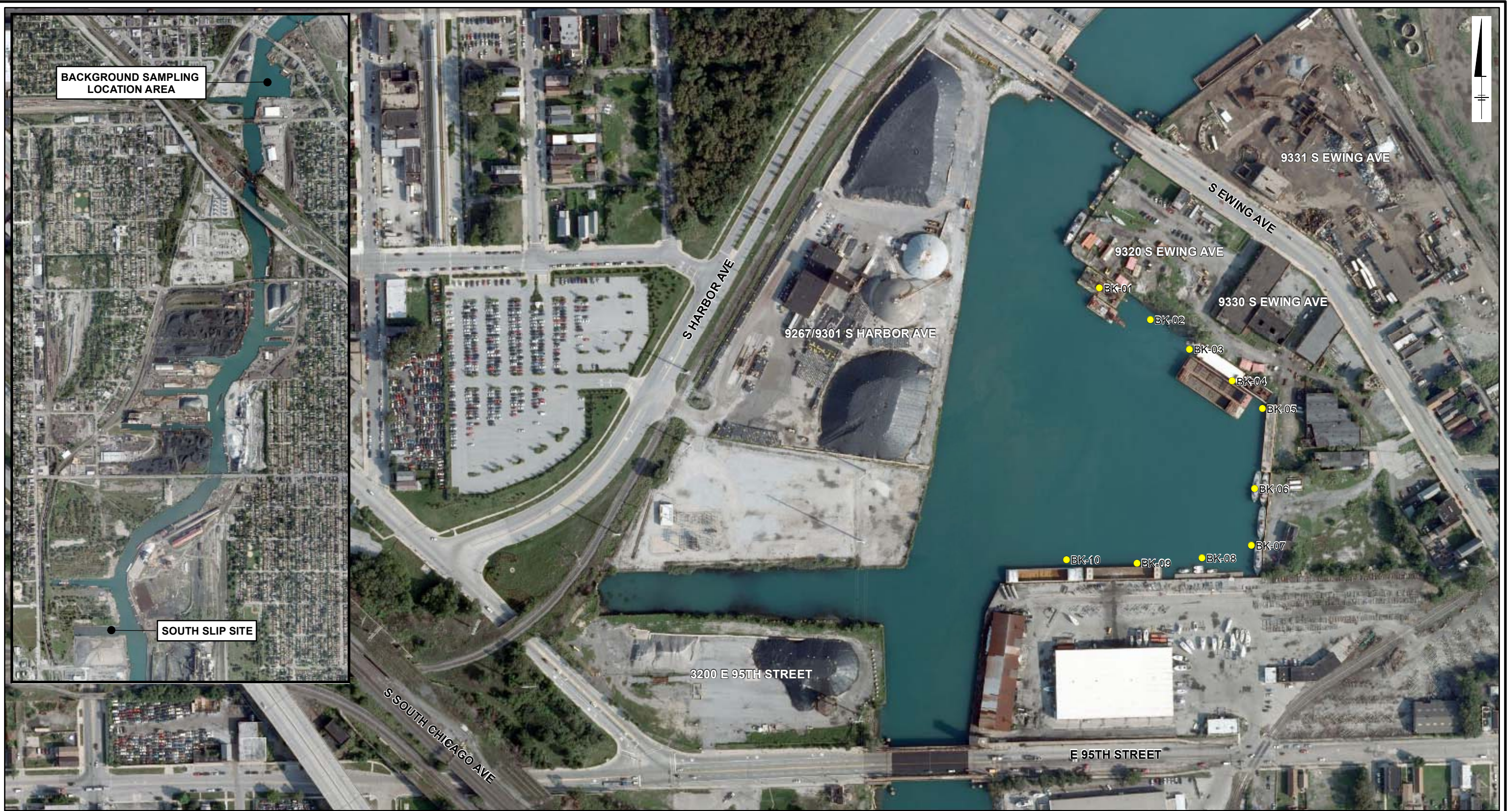

LEGEND:

- BACKGROUND SAMPLE LOCATION

NOTES:

1. 2010 AERIAL PHOTOGRAPHY OBTAINED FROM BING IMAGERY SERVICE LICENSED THROUGH ESRI SOFTWARE.
2. SEDIMENT SAMPLES AT PROPOSED BACKGROUND LOCATION BK-06 COULD NOT BE COLLECTED DUE TO COMPACTED SEDIMENTS AT THIS LOCATION.

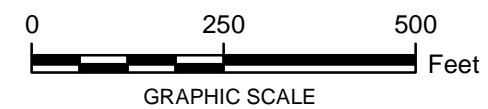

FORMER WISCONSIN STEEL WORKS
CHICAGO, ILLINOIS

BACKGROUND SAMPLING LOCATIONS



FIGURE
E-1

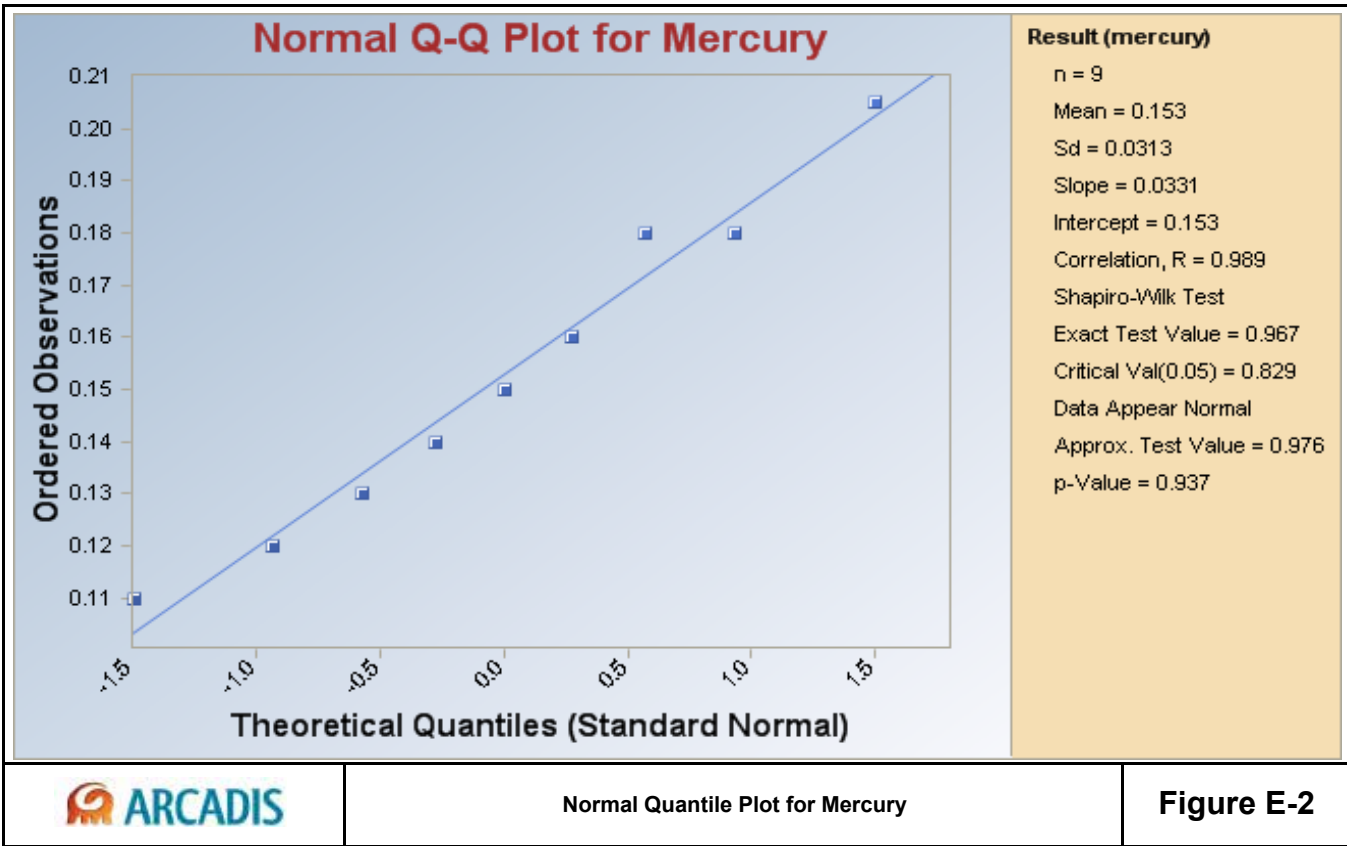

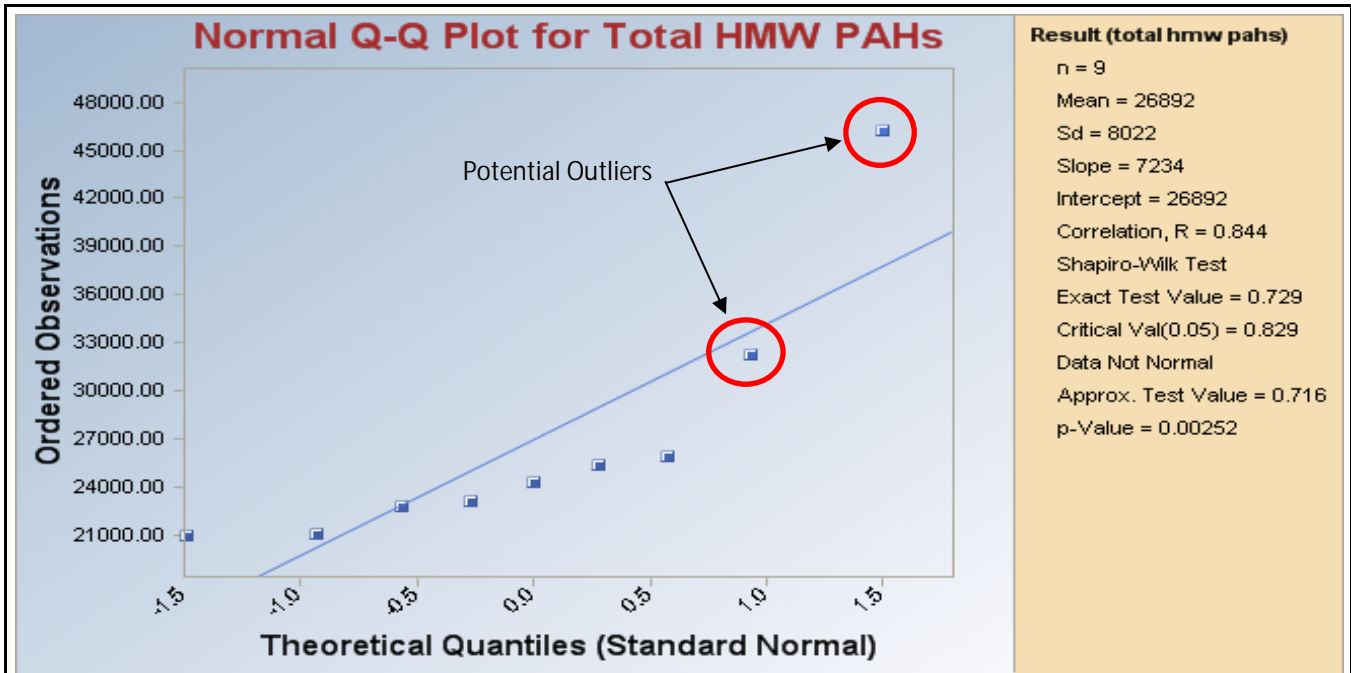

Normal Quantile Plot for Total HPAHs

Figure E-3

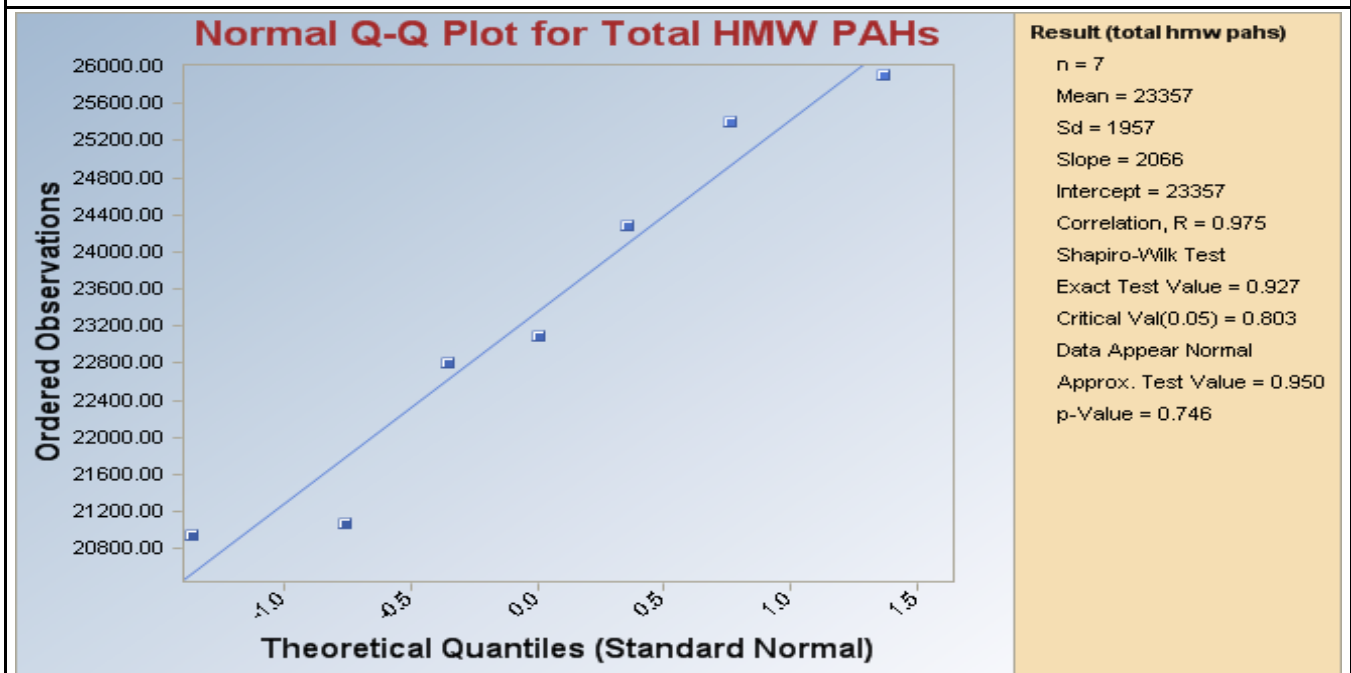

Normal Quantile Plot for Total HPAHs
(two outliers removed)¹

Figure E-4

Note:

¹ Prior to removing the outlier, the data did not fit a normal, lognormal or gamma distribution.

Lognormal Q-Q Plot for Total LMW PAHs

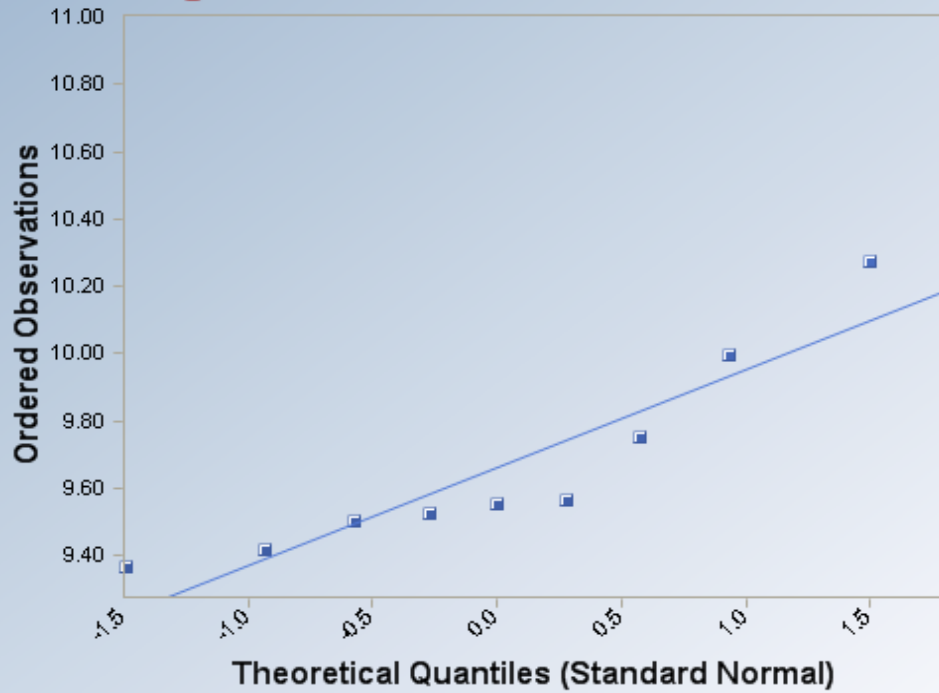

Result (total lmw pahs)

n = 9

Mean = 9.661

Sd = 0.298

Slope = 0.293

Intercept = 9.661

Correlation, R = 0.92

Shapiro-Wilk Test

Exact Test Statistic = 0.848

Critical Value(0.05) = 0.829

Data Appear Lognormal

Approx. Test Value = 0.847

p-Value = 0.068



Lognormal Quantile Plot for Total LPAHs

Figure E-5

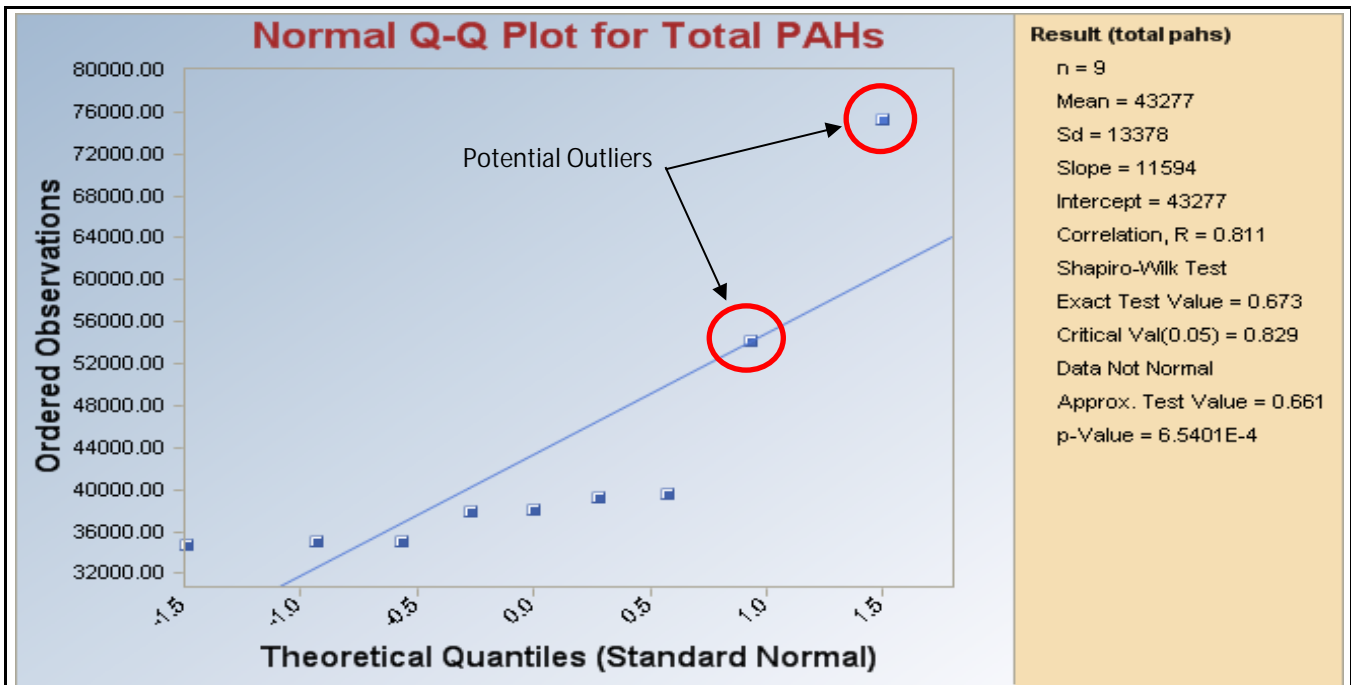

Normal Quantile Plot for Total PAHs

Figure E-6

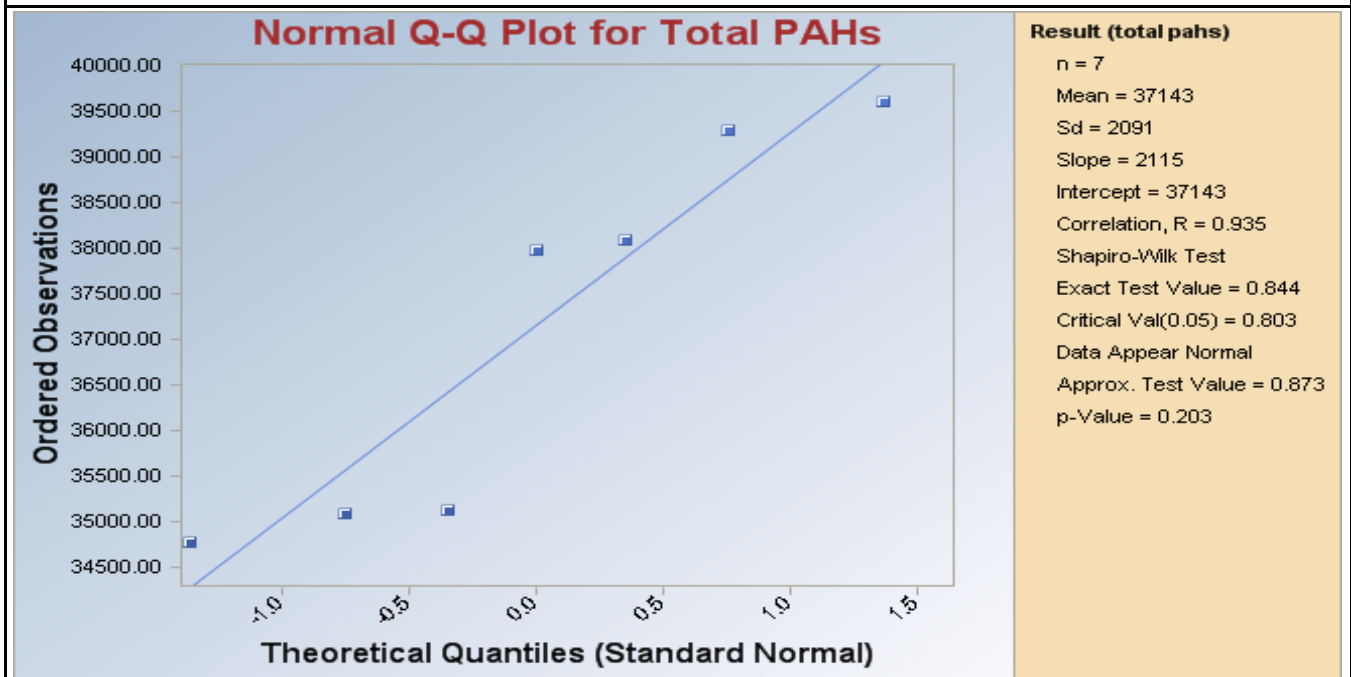

Normal Quantile Plot for Total PAHs
(two outliers removed)¹

Figure E-7

Note:

¹ Prior to removing the outliers, the data did not fit a normal, lognormal or gamma distribution.

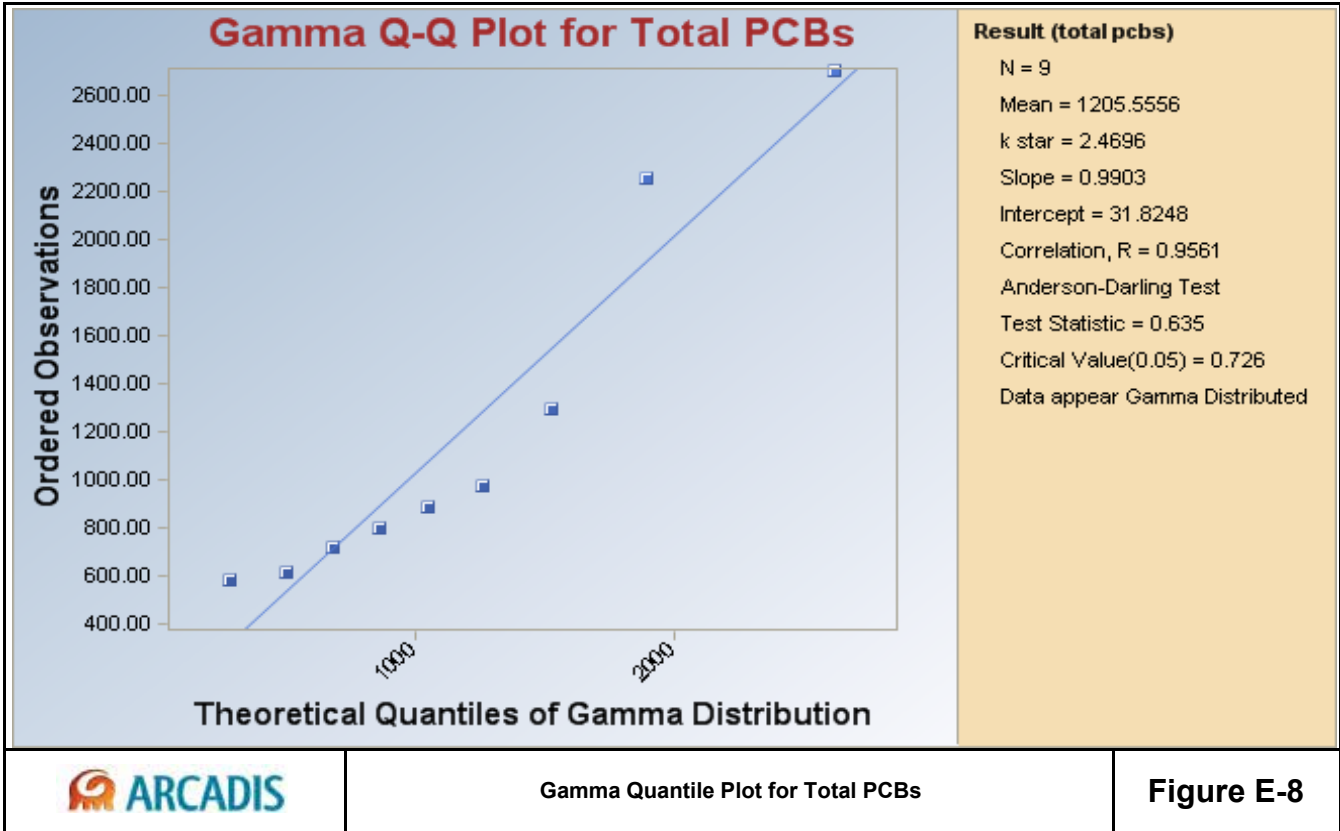

Appendix F

Construction Quality Assurance Plan



Navistar, Inc.

South Slip Sediment Cap Design Report

Construction Quality Assurance Plan

Former Wisconsin Steel Works
Chicago, Illinois

June 2012



Mark Graveling, PE
Engineer of Record

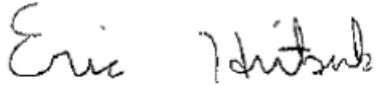

Eric Hritsuk, PE
Project Engineer

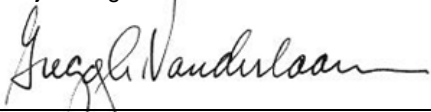

Gregory A. Vanderlaan
Project Manager

**South Slip Sediment Cap
Design Report - Construction
Quality Assurance Plan**

Former Wisconsin Steel Works
Chicago, Illinois

Prepared for:
Navistar, Inc.

Prepared by:
ARCADIS US, Inc.
10 S. Riverside Plaza
Suite 1900
Chicago Illinois 60606
Tel 312.575.3700
Fax 312.775.9322

Our Ref.:
CI000664.0037.0001

Date:
June 2012

This document is intended only for the use of the individual or entity for which it was prepared and may contain information that is privileged, confidential and exempt from disclosure under applicable law. Any dissemination, distribution or copying of this document is strictly prohibited.

1. Introduction	1
1.1 Overview of Remedial Action	1
1.2 Definitions and Terms	1
1.3 CQAP Organization	2
2. Key Personnel and Qualifications	4
2.1 CQA Management Organization	4
2.2 Contractor Qualifications and Responsibilities	8
2.3 Other CQA Organizations	9
3. Documentation Requirements	10
3.1 Documentation	10
3.1.1 Daily Construction Reports	10
3.1.2 Problem/Deficiency Identification and Corrective Action Documentation	11
3.1.3 Weekly Erosion and Sediment Control Inspection Reports	12
3.1.4 Construction Submittals	13
3.1.5 Remedial Action Completion Report	14
3.2 Project Meetings	14
3.2.1 Pre-Construction Meeting/Walkthrough	15
3.2.2 Daily Site Safety/Coordination Meetings	16
3.2.3 Periodic Project Coordination Meetings	16
4. Pre-Construction Activities/Mobilization	17
4.1 Material Testing	17
4.2 Mobilization	18
4.3 Erosion and Sediment Control Measures	19
4.4 Material Staging, Containment, and Decontamination Areas	19
5. Capping of Sediments	20
5.1 Material Specifications	20

5.2	Delivery, Storage, and Placement of Cap Materials	20
5.3	Quality Control Requirements	20
6.	Water Column Monitoring	23
7.	Decontamination Activities	25
8.	Site Restoration/Demobilization	27
8.1	Surface Restoration	27
8.2	Pre-Final Inspection	28
8.3	Demobilization	29
8.4	Post-Construction Walkthrough	29

Table

F-1	Contractor Submittal Tracking Form
-----	------------------------------------

1. Introduction

This Construction Quality Assurance Plan (CQAP) has been prepared in support of the construction of a sediment cap at the former Wisconsin Steel Works (WSW) South Slip site in Chicago, Illinois (the Site). The primary objectives of this CQAP are to:

- Present the key personnel and organizational structure proposed for implementation and monitoring of the construction quality assurance (CQA) program described herein; and
- Describe the materials, procedures, and testing necessary for assessing the construction of the cap and the achievement of construction goals and benchmarks, and assurance of appropriate documentation during implementation of remedial activities.

The remainder of this section presents a summary of the remedial program and the organization of this CQAP.

1.1 Overview of Remedial Action

The sediment cap to be constructed in the South Slip has been designed to isolate the native sediment from surficial ecological receptors, and retard the transport of sediment-related constituents to the cap surface. Construction of the sediment cap includes the following primary components:

- Mobilization and Site Preparation
- Cap Installation
- Demobilization and Site Restoration

1.2 Definitions and Terms

The following terms and abbreviations are used throughout this CQAP. The definition of each term or abbreviation is consistent throughout this plan.

ASTM – American Society for Testing and Materials.

Contractor – The person or persons selected by Navistar, Inc. (Navistar) for the construction of the South Slip sediment cap, including any person or persons hired by the Contractor (i.e., subcontractors) for performance of the work.

Remedial Design – Documents included as part of the Remedial Design include the *South Slip Sediment Cap Design Report* (DR) and all associated appendices (i.e., Site Photos, Design Drawings, Cap Material Design and Assessment, Sediment Consolidation, Slope Stability, and Sediment Bearing Capacity Evaluations, Development of Background Threshold Values, and this CQAP).

CQA – Construction quality assurance.

CQC – Construction quality control.

Engineer – The person or persons responsible for the design aspects of the project. The Engineer’s duties include reviewing modifications to the Remedial Design. In addition, the Engineer will be responsible for the quality assurance/quality control (QA/QC) aspects of the project. Duties will include CQA sampling, testing, determination of work limits, and confirmation of work performed for payment and final achievement of construction goals.

Manufacturer – The person or persons designated by the Contractor to provide construction materials.

1.3 CQAP Organization

The CQAP is organized as follows:

Section	Purpose
Section 1 – Introduction	Provides the objectives of this CQAP, overview of the Remedial Action, definitions and terms, and the CQAP organization.
Section 2 – Key Personnel and Qualifications	Presents a description of personnel responsible for proper implementation of CQAP procedures.
Section 3 – Documentation Requirements	Presents a description of proper communication and documentation of work activities.
Section 4 – Pre-Construction Activities/Mobilization	Presents a description of CQA/CQC requirements for pre-construction activities/mobilization/site preparation.
Section 5 – Capping of Sediments	Presents a description of CQA/CQC requirements for sediment capping activities.

Section 6 – Water Column Monitoring	Presents the water column monitoring program to be performed by the CQA team during remedial activities.
Section 7 – Decontamination Activities	Presents a description of CQA/CQC requirements during decontamination activities.
Section 8 – Site Restoration/ Demobilization	Presents a description of CQA/CQC requirements for site restoration/demobilization.

2. Key Personnel and Qualifications

This section presents the key personnel and organizational structure needed for CQA during performance of the Remedial Action. The following table identifies the key CQA personnel and their roles and provides details on the duties of each CQA team member, including position descriptions, responsibilities, and experience requirements.

Function	Contact Name	Organization
Owner’s Project Manager	Edith Ardiente	Navistar
Engineer-of-Record	Mark O. Graveling, P.E.	ARCADIS
ARCADIS Project Manager	Gregory Vanderlaan	ARCADIS
CQA Engineer	Eric Hritsuk	ARCADIS
CQA Observer(s)	Michelle Rumler	ARCADIS
Contractor’s Project Manager	TBD	TBD
CQA Laboratory	TBD	TBD
CQA Surveyor	TBD	TBD
Regulatory Agency Project Manager	Todd Gross	Illinois Environmental Protection Agency (Illinois EPA)
Regulatory Onsite Inspector	Todd Gross	Illinois EPA

1. Note that the Engineer-of-Record, ARCADIS Project Manager, and CQA Engineer are all affiliated with ARCADIS, and for the purposes of this document may be collectively referred to as the Engineer.
2. Note that the United States Army Corps of Engineers (USACE) may also function as a Regulatory Agency during portions of the work.

The CQA Engineer will have overall responsibility for carrying out the provisions of this CQAP, including observing and documenting the activities detailed in the DR. The Contractor and subcontractors will discuss all matters relating to the CQAP with the CQA Engineer. The CQA Engineer will be responsible for documenting, in accordance with this CQAP, that the remedial activities are conducted in a manner consistent with the Design Drawings (Appendix B of the DR).

2.1 CQA Management Organization

In general, observation, sampling, testing, and/or documentation of construction materials installation and associated procedures will be performed by a person or persons familiar with contemporary construction procedures and materials. The project personnel will be

under the supervision of a Professional Engineer (i.e., the Engineer-of-Record) licensed in the State of Illinois. CQA personnel will be familiar with the use of equipment and methodology needed to sample and test soil, sediment, water, and other materials (as applicable). When necessary, CQA personnel will provide proof that field personnel are appropriately trained and/or certified for the use of applicable testing equipment.

Specific qualifications for personnel affiliated with implementation of the CQAP are as follows:

Owner (Navistar) – Navistar is responsible for performing and documenting remedial activities performed in association with the Remedial Action. Navistar has retained ARCADIS to serve as the Engineer and to procure a Contractor to fulfill its responsibilities for completion of the remedial efforts.

Engineer-of-Record – The Engineer-of-Record is a Professional Engineer licensed in Illinois. The CQA team will be under the supervision of the Engineer-of-Record. The Engineer-of-Record, working together with the CQA Engineer, will direct preparation of the Remedial Action Completion Report (RACR) certifying that the construction activities have been completed in conformance with the Remedial Design documents. The Engineer-of-Record will have the following responsibilities related to implementation of the procedures in the CQAP:

- Attend the pre-construction meeting (or designate a representative to do so);
- Maintain routine contact with the Project Manager, CQA Engineer, and the Contractor regarding conformance with the QC requirements;
- Review the selected Contractor's Operations Plan and pre-mobilization submittals;
- Provide the appropriate technical review of the Remedial Design, and approve any field modifications to the Remedial Design;
- Review shop drawings and other submittals from the Contractor for conformance with the Design Drawings, and take appropriate action after review; and
- Direct preparation of and certify the RACR.

Project Manager – The Project Manager will have the following responsibilities during the implementation of the procedures in the CQAP:

- Attend the pre-construction site meeting;
- Maintain responsibility for the implementation of the procedures in the CQAP;
- Provide the appropriate technical review of the Remedial Design, modifications to the Remedial Design, and RACR;
- Maintain contact with the Owner, the Engineer-of-Record, the CQA Engineer, Contractor, and subcontractors regarding conformance with the requirements in this plan;
- Provide overall coordination of the remedial activities;
- Provide assistance in the review and interpretation of field and laboratory testing results;
- Provide assistance in the review of shop drawings and other submittals from the Contractor;
- Perform periodic site visits to review construction progress;
- Review the installed portion of work to permit further construction;
- Identify noted deficiencies during construction activities (based on QC testing results) so corrective actions can be taken;
- Review daily construction summary reports; and
- Oversee preparation of the RACR.

CQA Engineer – The CQA Engineer will be knowledgeable of the project requirements and objectives, Remedial Design, construction/remediation techniques, and performance of associated QA/QC methods. The CQA Engineer will have the following responsibilities in the implementation of the procedures in the CQAP:

- Oversee and coordinate the QA/QC monitoring, sampling, and testing;
- Attend the pre-construction site meeting;

- Record onsite activities that could result in damage to the Site and report these activities to the Contractor and Project Manager;
- Review daily construction reports prepared by CQA Observer(s) and provide to the Project Manager;
- Serve as the daily contact person for the CQA personnel;
- Maintain routine contact with the Owner, CQA Observer(s), and the Contractor regarding conformance with CQA and CQC requirements;
- Review shop drawings and other submittals from the Contractor;
- Review field and laboratory CQA and CQC testing results, including analytical results provided by the Contractor for construction materials (e.g., fill, stone, cap materials) proposed for delivery to the Site, for conformance with the Remedial Design;
- Identify areas that may require rework and/or repair;
- Monitor the delivery of samples to the CQA Laboratory for testing;
- Coordinate the activities of the CQA Observer(s); and
- Perform regular site walkthroughs to review progress and QA/QC procedures.

CQA Observer(s) – The CQA Observer(s) must demonstrate knowledge of the project requirements and objectives, Remedial Design, construction/remediation techniques, performance of associated CQA and CQC methods, construction documentation, and applicable materials testing methods. The CQA Observer(s) will be physically onsite during performance of the Remedial Action-related activities. The CQA Observer(s) will have the following responsibilities in the implementation of the procedures in the CQAP:

- Attend the pre-construction meeting;
- Attend daily tailgate safety meetings and weekly progress meetings;
- Perform and document field testing, including environmental monitoring (e.g., turbidity monitoring), at the frequency established in the Remedial Design;
- Identify areas of nonconformance based upon the results of field and laboratory testing;

- Review/inspect construction materials, such as soils, stone, cap materials, and geosynthetics, delivered to the Site, to determine general conformance with material specifications;
- Observe and record procedures used for pre-construction activities/mobilization;
- Observe and record procedures used for installation and monitoring of erosion and sediment control measures;
- Observe and record procedures used by the Contractor for verification the installed cap meets the minimum requirements outlined in the Remedial Design documents (e.g., thickness, extent);
- Observe and record procedures used during decontamination;
- Observe and record procedures used for site restoration/demobilization; and
- Prepare daily construction reports.

2.2 Contractor Qualifications and Responsibilities

The Contractor will be trained and experienced, and demonstrate that the superintendent, field crew foreman, and subcontractors have similar experience in the construction, installation, and performance of the various components outlined in the Remedial Design, including cap placement activities. The Contractor shall provide evidence of prior work on satisfactorily completed projects of similar magnitude and complexity to this project. The Contractor will have the following responsibilities for implementing the procedures presented in the CQAP:

- Review and be completely familiar with the Remedial Design;
- Maintain lines of communication with the CQA Personnel to identify and discuss field issues as they arise;
- Coordinate with all equipment suppliers to document compliance with the CQAP requirements;
- Provide the CQA Engineer with at least 5 days written notice of any tests or inspections required by the Remedial Design; timely notice of all other tests and inspections; and an additional 48 hours notice prior to the actual performance of any test or inspection;

- Prepare and submit to the CQA Engineer all shop drawings and other required submittals specified in the Remedial Design;
- Identify any potential design and/or construction issues as early as possible to allow resolution in a manner that will not impact the quality of the construction or the schedule of construction activities;
- Maintain a continuous record of any approved changes or modifications to the Remedial Design; and
- Prepare weekly erosion and sediment control inspection reports.

2.3 Other CQA Organizations

During construction, it will be necessary to use other qualified professional organizations to implement the CQA activities, such as an analytical testing laboratory and licensed surveyor.

Analytical Laboratory – The analytical laboratory(s) selected by the Contractor will be approved to perform the required testing on soil/sediment samples collected during implementation of remedial activities as required by this CQAP and/or the Remedial Design. Test data and reports completed by the laboratory will be submitted to both the Contractor and the CQA Engineer.

CQA Surveyor Qualifications – All surveys necessary for implementation of the South Slip sediment cap and for the collection of as-built information will be carried out by personnel practiced in land and/or bathymetric survey techniques.

3. Documentation Requirements

3.1 Documentation

The documentation of CQA activities will support a determination of whether construction activities have been carried out in general accordance with the Remedial Design. The documentation process includes identification of construction tasks that will be observed and documented, assignment of responsibilities for the observation, testing, and documentation of such tasks, and completion of the required reports, data sheets, forms, and checklists to provide an accurate record of the work performed during cap construction.

3.1.1 Daily Construction Reports

The CQA Observer, with input and review from the CQA Engineer, will complete a daily summary report of each day's construction activities. The daily construction report will contain, at a minimum, the following information:

- Date, project name, location, and the number and names of people onsite;
- Time that work starts and ends, in addition to the time of work stoppages related to inclement weather, or insufficient equipment or personnel or other reasons;
- Weather conditions, including temperature, humidity, wind direction, and speed, cloud cover, and precipitation;
- Contractor's workforce, equipment, and materials delivered to or removed from the job site;
- Chronological description of work in progress, including notices to or requests from the Contractor and/or installer;
- Project status and the end of each day;
- Photographs of work activities, which will be filed in chronological order in a permanent protective file and computer storage system, and include the following information: date and time; location where photograph was taken; and description of the subject matter;
- A description of any health and safety issues;
- Results of CQA testing performed onsite;

- Problem/deficiency identification and documentation describing corrective actions taken for field problems and nonconformance with this plan;
- A listing of laboratory samples collected, marked, and delivered to the CQA/CQC Laboratory;
- A record of communications with other onsite parties, outside companies, regulatory agencies, or consultants regarding the day's construction activities; and
- A record of calibrations or standardizations performed on field testing equipment, including actions related to the results of recalibrations.

3.1.2 Problem/Deficiency Identification and Corrective Action Documentation

Daily construction reports will include documentation of problems and/or deficiencies noted during construction (e.g., when construction material or activity is observed or tested that does not meet the requirements set forth in this plan), and any corrective action employed by the Contractor to address the problems or deficiencies. The daily construction reports will be cross-referenced to any reports, data sheets, forms, or checklists that contain data or observations leading to the determination of a problem or deficiency. Problem and deficiency identification and corrective action documentation may include the following information:

- A description of the problem or deficiency, including reference to supplemental data or observations related to the determination of the problem or deficiency;
- Location of the problem or deficiency, including how and when the problem or deficiency was discovered; and
- The corrective action taken for resolving the problem or deficiency. If the corrective action has already been implemented, observations and documentation showing that the problem or deficiency was resolved will be included. If the problem or deficiency has not been resolved by the end of the day upon which it was discovered, the documentation will state that the deficiency was unresolved at the end of the day.

If the problem or deficiency has not been resolved, then the Engineer-of-Record, ARCADIS Project Manager, and the CQA Engineer will discuss the corrective actions necessary to resolve the problem or deficiency as soon as possible.

The Engineer-of-Record, working with the CQA Engineer, will determine if the problem and/or deficiency indicates a situation that might require changes to the Remedial Design. If this situation develops, a meeting/teleconference will be held with the appropriate project personnel to determine if revisions should be made. Any revisions made to the Remedial Design or the CQAP must be reviewed by the Engineer-of-Record.

3.1.3 Weekly Erosion and Sediment Control Inspection Reports

The Contractor will complete a weekly inspection report that summarizes the results of erosion and sediment control inspections (as described below in Section 4.3). The weekly erosion and sediment control inspection reports will contain, at a minimum, the following information:

- Date and time of inspection;
- Name and title of person(s) performing inspection;
- A description of the weather and soil conditions (e.g., dry, wet, saturated) at the time of the inspection;
- A description of the condition of the all potential points of discharge from the construction site, including discharges from conveyance systems (i.e., pipes, culverts, ditches, etc.) and over-land flow;
- Identification of all erosion and sediment control practices that need repair or maintenance;
- Identification of all erosion and sediment control practices that were not installed properly or are not functioning as designed and need to be reinstalled or replaced;
- Description and sketch of areas that are disturbed at the time of the inspection and areas that have been stabilized (temporary and/or final) since the last inspection; and
- Corrective action(s) that must be or have been taken to install, repair, replace, or maintain erosion and sediment control practices.

A copy of the inspection report will be provided to the CQA Engineer in a timely manner (i.e., within 48 hours) following the inspection.

3.1.4 Construction Submittals

The Contractor shall prepare and submit to the CQA Engineer, copies of all submittals required in the Remedial Design for distribution and review (Table F-1). For pre-mobilization submittals discussed in the Remedial Design (e.g., Operations Plan, Contingency Plan, Health and Safety Plan [HASP], Traffic Control Plan), the Contractor must submit a copy of each submittal to ARCADIS within 30 days of the contract award. For submittals related to proposed construction materials, the Contractor will provide the required submittals to the CQA Engineer a minimum of 20 calendar days prior to the intended use of the item covered by the submittal, unless otherwise stated in Table F-1 or agreed upon with the CQA Engineer, and construction activities that require submittals will not be allowed to commence until submittal requirements are fulfilled. The Contractor's submittals must be easily legible, clean, and clearly reproduced.

All required submittals shall be reviewed by the CQA Engineer for conformance with the requirements presented in the Remedial Design. The Contractor will not be permitted to perform any activity that directly or indirectly involves the item or items covered by a submittal until a "reviewed" or "reviewed and noted" stamp is provided by the Engineer. As appropriate, certain submittals will also be provided to Illinois EPA for further review.

The CQA Engineer's review shall in no way be construed as permitting departure from the Remedial Design, except where the written request by the Contractor and written acceptance by the CQA Engineer and Project Manager for such departure is provided. The CQA Engineer's review does not relieve the Contractor of any responsibility to comply with applicable laws, rules, regulations, or agreements. Certain technical submittals will be reviewed and stamped by the CQA Engineer as follows:

1. "Reviewed" if no objections are observed or comments made;
2. "Reviewed and Noted" if minor objections, comments, or additions are made but resubmittal is not necessary and objections, comments, and additions will become a part of the submittal and are binding to the Contractor;
3. "Resubmit" if the objections, comments, or additions are extensive and the Contractor must resubmit items after correction; and
4. "Rejected" if the submittal does not comply, even with reasonable revision, with contract conditions. In this case, the Contractor shall resubmit to the CQA Engineer within 4 days a new or modified supplemental submittal that meets the scope and intent of the work specified herein.

“For Your Information” will be noted if a submittal does not require the CQA Engineer’s review and is being filed for informational purposes only (this code is generally used in acknowledging receipt of field conformance test reports and Health and Safety Plans).

The CQA team will maintain copies of and will observe and document compliance with the reviewed submittals.

3.1.5 Remedial Action Completion Report

A RACR consistent with 35 IAC 740.450 and documenting the completion of activities will be assembled by the CQA Engineer at the end of construction. At a minimum, the RACR will contain the following information:

- A description of the construction activities, including deviations (if any) from the Remedial Design;
- Drawings showing the installation of each construction material as it relates to the plan views with individual details;
- Correspondence with the Illinois EPA and others, as deemed relevant to construction or any potential modifications to the Remedial Design, including copies of regulatory permits;
- A summary of field observations and tests performed, laboratory samples collected, and test results reported;
- A summary of problems and deficiencies encountered during construction, including recurring problems and/or deficiencies discovered; and
- Documentation indicating that acceptance criteria were met, including a comparison of documented procedure data with the Remedial Design.

3.2 Project Meetings

Daily and weekly site safety inspections and project coordination/progress meetings will be conducted with representatives of the Contractor and the CQA Observer, as well as the CQA Engineer, as needed. Such meetings may also be attended by an Illinois EPA or other regulatory agency (i.e., USACE) representative for the duration of the construction activities. A brief description of the site meetings and inspections/reviews to be conducted is provided below.

3.2.1 Pre-Construction Meeting/Walkthrough

Following award of the Contract and prior to Contractor mobilization, a pre-construction meeting will be held at the Site to introduce project team members representing the Contractor and the Engineer. Representatives from the Illinois EPA or any other regulatory agency (i.e., USACE) and the Owner may also be invited to the pre-construction meeting. The meeting will be scheduled by the Engineer shortly after the award of the Contract. The meeting will be conducted to observe and document (via photograph and/or videotaping) the pre-remediation conditions of the property, review Contract requirements, determine lines of authority and communication for each organization, establish a detailed schedule of operations, and resolve issues (if any) raised by the attending parties. In addition, the topics covered will include, but may not be limited to, the following:

- Established procedures or protocols for construction, field decisions, proposal requests, submittals, change orders, deficiencies, repairs, and retesting;
- Methods for documenting and reporting construction observation data;
- Methods for distributing and storing documents and reports;
- Work area security, safety protocol, and health and safety concerns/issues (specifically including task-specific hazards related to working on or near water);
- Procedures for the location and protection of construction materials, and for prevention of damage to the materials from inclement weather or other adverse conditions;
- Temporary utilities and facilities;
- Housekeeping procedures;
- Walkthrough to review staging and storage locations;
- Procedures and timing for each representative to receive relevant CQAP documents and supporting information; and
- This CQAP and its purpose relative to the Design Drawings (which include the Technical Specifications).

The CQA Engineer will prepare a summary of the pre-construction meeting. A copy of this summary will be provided to each of the parties in attendance.

3.2.2 Daily Site Safety/Coordination Meetings

Daily meetings will be attended by the Contractor's onsite project foreman, the CQA Observer, the Engineer, and other parties (such as Illinois EPA/USACE). These meetings will be held onsite during the day to discuss day-to-day operations, daily schedule, health and safety issues, Contractor coordination issues, and general project status.

3.2.3 Periodic Project Coordination Meetings

Periodic project coordination meetings will be held onsite at least weekly for the duration of the project. Participants in these meetings will include at a minimum onsite representatives of the Contractor, officers of the Contractor's firm (as requested by the Owner), the CQA Engineer, and the CQA Observer. The Owner and Illinois EPA/USACE also may attend some or all of the weekly progress meetings. Weekly progress meetings will be held to discuss issues including, but not limited to, project status, schedule, scope of work, and overall project implementation.

The weekly progress meetings will be scheduled by the CQA Engineer.

4. Pre-Construction Activities/Mobilization

This section describes the construction and testing procedures for the activities that will take place during mobilization and leading up to and including the site preparation phase of construction. Pre-construction activities include testing of construction materials (e.g., cap material, restoration materials, stone), a pre-construction site meeting/walkthrough (discussed above), and site preparation activities such as erosion and sediment control measure installation and material staging, containment, and decontamination area construction.

4.1 Material Testing

Offsite materials brought onsite for use as fill, sand cap material, and/or restoration materials (i.e., topsoil) must be from a pre-approved source or sampled and analyzed by a certified laboratory for pesticides, polychlorinated biphenyls (PCBs), total petroleum hydrocarbon, volatile organic compounds (VOCs), polycyclic aromatic hydrocarbons (PAHs), and total metals, mercury, total cyanide, and pH to demonstrate that the offsite materials are suitable for use onsite. Analytical results for grain-size of the sand and stone cap materials, United Soil Classification System (USCS), and total organic carbon (TOC) content for the sand cap material will also be submitted to the CQA Engineer prior to placement to confirm materials used are in accordance with the Remedial Design. Materials will either be certified from an Illinois Department of Transportation (Illinois DOT-approved borrow source, or be submitted to an USACE and American Association of State Highway and Transportation Officials (AASHTO) accredited geotechnical laboratory for testing.

For clean fill, sand cap materials, and restoration materials, the Contractor will collect representative samples and provide associated analytical results for the above listed analytes at a minimum frequency of one sample per 2,500 cubic yards (cy) of material anticipated for use. The laboratory analytical results will be compared by the CQA Engineer and, at a minimum, must be lower than the Tiered Approach to Corrective Action Objectives (TACO) 35 IAC 742 Tier 1 Residential Screening Criteria to be used onsite. Samples collected for grain-size analysis must also be submitted for analysis at a minimum frequency of one sample per 2,500 cy of material anticipated for use.

Samples of the sand cap material for the isolation layer (i.e., sand with 2% TOC) must also be submitted for TOC analysis (Lloyd Khan method) at a rate of one sample per 1,000 cy. If the proposed material source does not meet the minimum 2% TOC standard, the Contractor shall secure another source or propose an amendment (i.e., topsoil) that may be mixed with the initial source material to create a blended material with a minimum 2% TOC.

If the Contractor proposes to use a blended material as the source for the isolation layer material, such material shall be sampled at a rate of one sample per 500 cy.

Sampling and analyses will be performed for imported backfill in accordance with the requirements of this CQAP. Prior to construction, the name and location of the borrow source(s), the proposed application of the materials, and any laboratory testing results or source certification statements will be provided to the CQA Engineer for review. The CQA Engineer will indicate if the information and data are in accordance with the requirements of the Remedial Design or otherwise suitable for use. Materials may be rejected by the Engineer if not in compliance.

4.2 Mobilization

Mobilization activities will be executed prior to beginning any remediation-related activities. Contractor mobilization activities (at a minimum) will include the following:

- Mobilizing personnel, equipment, and materials necessary to complete the Remedial Action activities;
- Clean/decontaminate all construction-related equipment brought onsite prior to its use;
- Establishing project support facilities (e.g., office trailers, sanitary facilities) and provisions for site security;
- Constructing/marketing out the work area(s), material and equipment staging area(s), and decontamination area(s), as indicated below; and
- Locating and marking out subsurface utilities using Illinois One-Call and a private utility-locating agency, as necessary.

The CQA Observer will observe the mobilization activities to document that the following activities are completed:

- Equipment and construction-related materials are delivered to the work area in a clean and well-maintained condition;
- Work area(s), material staging area(s), and decontamination area(s) are constructed in accordance with the Design Drawings; and

- Subsurface utilities are located and field marked and protected prior to completing any earthwork activities.

4.3 Erosion and Sediment Control Measures

Prior to the start of construction, erosion and sediment control measures (i.e., silt fence, turbidity curtain) will be constructed/installed/placed by the Contractor in general accordance with the Remedial Design. The CQA Observer(s) will observe the sediment and erosion control measures deployed by the Contractor and will document those observations each day on the daily construction reports. Observed nonconformance with the Remedial Design will be reported to the CQA Engineer and corrected promptly.

4.4 Material Staging, Containment, and Decontamination Areas

During site preparation activities, the Contractor will construct remedial support areas including, but not limited to, material staging, containment, and equipment/personnel decontamination areas. The Contractor will be responsible for submitting a figure as a part of their Operations Plan indicating the proposed locations of material staging, containment, and decontamination areas for approval prior to initiating cap installation activities. The CQA Observer(s) will observe that the material staging, containment, and decontamination areas are constructed in accordance with the Remedial Design, and will document nonconformance, which will be reported to the CQA Engineer and corrected promptly.

As necessary, the Contractor will provide a decontamination area for personnel (as specified in the Contractor's HASP). This decontamination area (within the contamination reduction zone) will include those facilities necessary to decontaminate personnel upon exit of the work area if there was contact with materials other than the clean capping material (i.e., native material and/or debris from within the South Slip), in accordance with the Contractor's HASP, and in accordance with local, state, and federal laws and regulations.

An equipment decontamination pad will be constructed for trucks, equipment, and personnel that come into contact with impacted materials during remedial activities. The decontamination pad will have an impermeable underlayment and will be capable of containing and collecting fluids. Sidewalls will be constructed to prevent errant overspray, especially when decontaminating large equipment.

5. Capping of Sediments

Sediment capping activities, including placement of the granular cap materials and scour protection materials, will be performed by the Contractor in accordance with the Remedial Design.

5.1 Material Specifications

The extent of the sediment cap will conform to the specifications set forth in the Remedial Design. Specifically, the sand isolation layer for the sediment cap will consist of clean fine to coarse sand material with a minimum TOC content of 2%, with not greater than 10% material passing the #200 sieve. The stone layer for the sediment cap will consist of clean poorly graded angular stone with a median diameter (D_{50}) of 2 inches.

5.2 Delivery, Storage, and Placement of Cap Materials

Clean cap and fill material will be delivered to the Site and stored in the temporary staging and stockpiling area. The Contractor will be responsible for ensuring that all materials meet specifications. The CQA Engineer will maintain a log of material deliveries, as well as a daily log of progress, including the quantity of cap material placed, the extent of coverage of cap materials, and other related observations.

The CQA Observer(s) will observe capping activities to: 1) document that they are being performed in accordance with the Remedial Design; and 2) report nonconformances to the CQA Engineer. The CQA Observer(s) will monitor for irregularities and indications that the delivered material and/or the placed material does not meet the specifications of the Remedial Design. Such instances will be reported to the CQA Engineer.

5.3 Quality Control Requirements

During placement of the granular cap material, a series of collection pans (typically approximately 2 feet x 2 feet in dimension) will be deployed by the Contractor as a line of evidence to assess the thickness of each placed lift of cap material. Initially at the start of each day, at least two such pans will be lowered in front of the days anticipated cap placement progression (i.e., in front of the barge, if barge-mounted equipment is used to place the cap material) using a submerged retrieval line. Up to 24 hours will be allowed for proper settling of the cap material such that on a daily basis, and prior to initiating cap placement operations for the day, the pan(s) placed during the preceding day's operations will be lifted and visually inspected. The thickness of material placed in the pan will be measured to ensure the proper lift thickness has been placed. As necessary, the Contractor

may make adjustments to cap placement methods (e.g., adjustment of feed rate) to ensure proper lift thickness. Once placement activities have been well established, and based on the results of the lift thickness monitoring, the frequency of collection pan use may be reduced, with only periodic use, as needed, throughout the remainder of the capping project.

Following placement of the sand isolation layer, and prior to commencing any placement of the armoring, the CQA Engineer will conduct, with the help of the CQA team, interim monitoring through a cap probing program designed to estimate interim cap thickness. It is anticipated that the probing will be conducted at up to 15 locations selected to represent approximately five locations per acre, and will be performed by gently pushing a grade stake (or equivalent) into the subaqueous cap until the Engineer observes a difference in resistance (i.e., until the probe pushes through the sediment cap and into the native material below). The depth markings on the grade stake will be documented at the interface between the water column and the sediment cap, and then again at the interface between the sediment cap and the underlying native sediment, and the difference between the two measurements will be used to measure the thickness of the cap at each location. If difficulties arise in approximating from the water surface the apparent interface between the bottom of the cap and the top of the native sediment layer (or the fill layer, for portions of the South Slip where clean fill is placed to create a maximum slope per the Remedial Design), alternative methods of monitoring may be employed (e.g., core collection), as necessary.

Based on the results of this interim monitoring, modifications may be made to the cap placement methods (i.e., target thickness of each lift, equipment type, placement rate). Any such modifications in cap placement rate or techniques will be discussed with Illinois EPA prior to implementation.

Following placement of the armoring, the CQA Engineer, with the help of the CQA team, will conduct post-placement monitoring through a cap coring program designed to estimate final cap thickness. It is anticipated that cores will be collected from the water surface by pushing 3-inch Lexan tubes gently through the bottom of the cap and into the top of the native sediment layer. Cores will be collected at up to 15 locations selected to represent approximately five locations per acre for any areas for which the cap material was installed. During core collection care will be taken to minimize material disturbance and/or loss of cap material; however, the granular, less-cohesive nature of the underlying sediment and bottom layer of the cap materials may possibly cause difficulties with standard core collection techniques. Additionally, difficulties may arise in approximating from the water surface the apparent interface between the bottom of the cap and the top of the native sediment layer. As necessary, alternative methods of core collection or divers may be employed to facilitate core collection if conventional direct-push collection from the surface

is infeasible. The CQA Engineer, and associated field personnel, will process the collected cores (i.e., measure the thickness of the cap layer) and maintain a log of the thickness of the two individual cap material layers observed at each location as well as any other general observations made during coring activities.

The results of this collection event will be used to verify that the horizontal and vertical extents of placement as defined in the Remedial Design have been achieved. Areas of the cap that do not meet the specified required thickness will be corrected by placing additional material.

In addition to the cap thickness CQA requirements presented above, the CQA Observer will verify that fill and sand isolation materials are placed on the side slopes in accordance with the Remedial Design. Materials placed on side slopes will be placed from the toe upward to the top of slope, and be placed in no greater than 6-inch lifts. The CQA Observer shall also confirm that sloughing or mud-waving does not occur during or immediately following placement.

For existing sediment slope areas that are steeper than 2H:1V (as shown on Design Drawings 5 and 6), the CQA Observer shall also periodically verify (using probing techniques) that those areas are filled by the Contractor to a minimum 2H:1V or flatter prior to sand isolation cap placement. Upon completion of the fill materials, the CQA observer shall probe these areas on 50-foot transects and record the approximate slope. These observations will be recorded in addition to any conformance requirements for which the Contractor is responsible.

The CQA Observer shall document any observations or nonconformance in the daily CQA report and notify the CQA Engineer of any nonconformance no later than the end of the work day.

6. Water Column Monitoring

During the performance of capping activities, environmental conditions in the adjacent Calumet River will be monitored twice per day to verify that there are no adverse impacts to the river associated with cap placement. Specifically, turbidity levels will be monitored (by the CQA Observer) outside of the work area turbidity controls at two locations in the Calumet River: upstream and downstream of the confluence with the South Slip (as shown on Figure 2 of the DR), allowing for a direct assessment of the potential contribution of the capping in the slip to the environmental conditions in the river.

It is anticipated that handheld, manually operated field turbidity meter(s) will be used for monitoring. These units will be calibrated, operated, and maintained according to the manufacturer's instructions and will be capable of collecting point turbidity readings from water as deep as 15 feet. The meter(s) will be able to measure turbidity at a resolution of +/- 1 nephelometric turbidity unit (NTU).

Evaluation of potential water column impacts during the ongoing removal activities will be based on the turbidity results. The proposed action levels for turbidity results are as follows:

$$\text{Turbidity}_{\text{Downstream}} \geq \text{Turbidity}_{\text{Upstream}} + 50 \text{ NTUs}$$

In the event that an elevated downstream turbidity measurement is obtained (as defined above) a number of site assessment activities will be initiated, including, but not limited to, the following:

- Review of the ongoing activities and modification of the condition or performance of the existing erosion and sedimentation control measures, including the turbidity curtain, and/or placement techniques/rate.
- Continued monitoring at the downstream location to determine if the prior result was an anomaly or if the elevated reading was possibly a short duration event.
- Collection of additional readings from various locations within or adjacent to the capping area to identify the potential source(s) of the elevated reading.
- If the exceedance is not an anomaly and is detected a second day, water samples will be collected at the upstream and downstream monitoring points and analyzed for total suspended solids (TSS).

If these assessment activities indicate that the elevated downstream turbidity reading reflects a water quality impact that could persist or recur and that it is related to specific remedial activities or site controls, the pertinent activities will be modified to the extent feasible, or additional controls will be implemented.

The Contractor will inspect the turbidity control system each day prior to commencing capping activities. Such daily inspections will consist of a surface assessment of the condition, location, and anchoring of turbidity curtains. If warranted, additional inspections may be conducted following higher-flow periods, noticeable turbidity increases outside the system, unexpected system position/behavior, contact with the system by equipment or debris, or other abnormal events. In addition, during these inspections, observations of weather, sewer discharges, or any other environmental conditions that would aid in evaluating water quality observations and measurements will be noted. The CQA Observer(s) will observe the turbidity control measures deployed by the Contractor and will document those observations each day on the daily construction reports. Observed nonconformance with the Remedial Design will be reported to the CQA Engineer and corrected promptly.

The turbidity curtain shall not be removed until the turbidity within the South Slip area is less than 50 NTU above the upstream turbidity level.

7. Decontamination Activities

The Contractor will decontaminate (as necessary) all personnel and equipment that have come into contact with native material from within the South Slip that may be impacted, in accordance with the Remedial Design. The decontamination area(s) will be constructed in accordance with the details provided in the Contractor's approved HASP, and this plan will also establish procedures for decontamination of any impacted vehicles and equipment.

As discussed in the DR, the procedures established as part of the Contractor's Contingency Plan (submitted as part of the Contractor's Operations Plan) for decontamination of all vehicles and equipment will be reviewed by the CQA Engineer prior to initiation of construction activities. Visual observation of the equipment will be performed by the Contractor. As appropriate, this observation will occur while the equipment is positioned in the Equipment Decontamination Area. Any visible soils or other native debris will be promptly removed and disposed of at an Owner-approved facility.

Unless otherwise directed by the Owner or the CQA Engineer, any equipment to be taken offsite will be subject to final visual observation and decontamination (if necessary) at a designated Equipment Decontamination Area. In general, this area will consist of an impermeable barrier, which shall be sloped to a collection sump. Precautions shall be taken to limit contact between the equipment, personnel performing the decontamination activities, and any decontamination liquids that may accumulate in the decontamination area. The Contractor shall be responsible for constructing and maintaining the decontamination area to accommodate all loads, equipment, and migration scenarios. The Contractor will dismantle and properly dispose of all materials associated with the decontamination area and will restore the area to its original conditions.

Wash water, solids, and other materials generated during equipment cleaning will not contact native soils and existing facilities, and will be collected by the Contractor and placed into designated containers. Disposal of collected wash water, solids, and other materials shall be at an Owner-approved facility.

Personnel engaged in vehicle decontamination will use personal protective equipment including disposable clothing in accordance with the Contractor's HASP.

Should vehicles be required to transport materials over site roadways or roadways traversed by local traffic, it is imperative that these roads be kept free of any potentially impacted as well as non-impacted soils due to Contractor's operations.

The CQA Observer(s) will observe decontamination activities to document that the following activities are completed in accordance with the Remedial Design, Contractor's Contingency Plans, and Contractor's HASP, including (but not limited to):

- Project equipment (trucks, hand tools, etc.) that comes in contact with native material from the South Slip that may be impacted is decontaminated prior to demobilization from the Site and prior to handling non-impacted (i.e., cap) material;
- No visible sediment, debris, or stains are present on the equipment surfaces (to the satisfaction of the CQA Observer) of each piece of equipment, indicating decontamination has been completed; and
- Solids and other materials generated during equipment cleaning that require offsite treatment/disposal are collected and placed into appropriate containers for characterization (as appropriate) and offsite disposal.

The extent and method of decontamination will be at the discretion of the Contractor; however, equipment and materials will be observed by the CQA Observer prior to its departure from the Equipment Decontamination Area. In addition, Navistar and/or the CQA Observer reserve the right to require additional decontamination if deemed necessary.

8. Site Restoration/Demobilization

Following completion of remedial activities, the Contractor will demobilize labor, equipment, and materials from the Site in accordance with the Remedial Design. This section also addresses CQA requirements for restoring areas of the Site that housed the temporary support facilities. Site restoration and demobilization activities will be completed and tested as indicated below.

8.1 Surface Restoration

Following capping activities, site restoration will include clearing material stockpile areas and material staging areas, and demobilization of work area trailers (if any). Additionally, disturbance and/or damage to adjacent land areas, offsite roadways, concrete walkways, curbs, gutters, and existing fence as a result of remedial activities will be repaired as needed to restore damaged features to their pre-construction condition.

As noted in Section 3.2.1, as part of the pre-construction walkthrough (i.e., prior to the start of construction), the CQA Observer(s) will obtain photographic documentation of pre-construction conditions in all areas that are indicated to be restored to pre-construction conditions within the Remedial Design.

During restoration activities, the CQA Observer(s) will observe surface restoration activities to document that the following activities are completed in accordance with the Remedial Design, including (but not limited to):

Gravel Road Surfaces (if any):

- All depressions that develop in the subgrade under rolling are filled with acceptable material and re-rolled;
- Soft areas of the subgrade are removed and filled with acceptable materials and re-rolled;
- Should the sub-grade become rutted or displaced prior to placing road surface materials, it is reworked to bring to line and grade; and
- No depressions remain in the final surface that could retain water.

Vegetated Surfaces:

- A minimum of 6 inches of topsoil is placed over all backfilled surfaces to the lines and grades indicated in the Remedial Design, and lightly compacted;
- Prior to placement of seed and mulch, the topsoil surface is lightly loosened, roughened, or tracked;
- Seed and mulch is placed at the minimum required application rates specified in the Remedial Design, and uniformly distributed over the entire area to be revegetated; and
- Following seeding and mulching, the Contractor continues to maintain the vegetated areas (including reseeded, if necessary) until a minimum 80 percent density of native perennial vegetation is established in all restored vegetated areas.

Soil Cover Area:

- Restore the engineered soil cover area to match pre-construction elevations with clean fill similar to currently in-place materials; and
- Perform a post-restoration topographic survey to ensure that the restored elevation is at a minimum at the pre-construction elevations shown on the Design Drawings included in the DR.

8.2 Pre-Final Inspection

Near the completion of remedial activities, the CQA Engineer and the Contractor will conduct a pre-final inspection. The pre-final inspection will consist of a work area walkthrough to evaluate the completeness of remedial construction efforts and its consistency with the Design Drawings and this CQAP.

Following the pre-final inspection, the CQA Engineer will either specify activities to address any deficiencies or deviations from the design documents, as appropriate, or will determine that the Remedial Action activities are complete. If additional construction activities are required, the CQA Engineer will prepare a "punch list" and corresponding schedule to complete the activities and issue to the Contractor and Owner for review. The Contractor will then complete the additional activities within the timeframe set forth in the agreed-upon schedule.

8.3 Demobilization

The Contractor will demobilize from the Site following completion of all South Slip sediment cap remediation activities. Demobilization activities will include, at a minimum, the following:

- Dismantling the work area(s), staging area(s), and equipment decontamination area(s), if any;
- Disposing of material staging and decontamination (if any) area construction materials at an Owner-approved facility;
- Cleaning/decontaminating equipment and construction-related materials prior to removal from the Site, if necessary; and
- Removing from the Site all materials, equipment, and support structures.

CQA Observations

The CQA Observer(s) will observe the Contractor demobilization activities to document that the following activities are completed in accordance with the Remedial Design:

- Equipment and construction-related materials have been cleaned/decontaminated, as necessary, prior to demobilization from the Site;
- Work area(s), material staging area(s), and equipment and personnel decontamination area(s) (if any) have been dismantled; and
- All Contractor materials, equipment, and support systems have been removed from the Site.

8.4 Post-Construction Walkthrough

After restoration and demobilization is complete, a walkthrough of the work area will be conducted with the CQA Engineer and the Contractor to observe and document restored conditions (the Owner and representatives from various regulatory agencies may attend). Results of the post-construction walkthrough will be documented in a memorandum (or other appropriate format) and distributed to all parties in attendance.

**Table F-1
Contractor Submittal Tracking Form
Former Wisconsin Steel Works, Chicago, IL
South Slip Sediment Cap Design Report**

Item No.	Submittal Description	Date Received	Review Conducted by:		Interim Status/Date (see Note 1)	Final Status/Date (see Note 1)	Notes
			CQA Engineer	Engineer of Record			
1	<p>Operations Plan:</p> <ul style="list-style-type: none"> • Erosion and sediment control plan. • A description of storm water, sediment/soil erosion, noise, and dust control measures. • Specific details related to material handling and staging approach including discussion of the proposed location, alignment, number, and size of material staging, containment, and decontamination areas. • Technical specifications related to any geosynthetic fabrics, if any, proposed for use within material staging, containment, and decontamination areas. • Description of the approach to the installation, operation, and maintenance of turbidity controls, and specific responses to turbidity exceedances. • Work schedule, including the initiation and completion of mobilization, capping, and site restoration activities. • List of subcontractors. • Traffic Control Plan. • Discussion of design details and means and methods associated with subaqueous debris removal including, but not limited to, discussion of target location methods and post-removal material handling approach. • Discussion of design details and specifications for the proposed system for placement of the sediment cap and verification of individual lift thicknesses and extents. • A description of project progress tracking including an example of daily progress reports summarizing the work activities of the day as well as the performance/results of routine inspections and monitoring. • Details for material transport which will include at a minimum the types of equipment and procedures to be used to transport the cap material from the source to the location of placement. • Survey control plan. • Dust, odor, and noise control/suppression plan. • List of disposal facilities for offsite disposition. • Equipment cleaning procedures. 						
2	<p>Health and Safety Plan:</p> <ul style="list-style-type: none"> • Identification of Key Personnel - Identify, by name and by title, the onsite and offsite health and safety personnel responsible for the implementation of health and safety procedures. All onsite personnel involved in the measures must have OSHA 40-hour Hazardous Waste Training (29 CFR 1910.120 and 1926.65) and the corresponding 8-hour refresher course update. • Training - Describe and provide certification of all supervisory and onsite personnel having received appropriate health and safety training. This requirement also includes all other relevant training certificates (e.g., crane operator license, welder certification, electrician certification, etc., as appropriate). • Medical Surveillance - Certify that all supervisory and onsite personnel have received appropriate medical examinations and are able to conduct the tasks required for this Project. • Task-specific Hazard/Risk Analysis - Identify and provide a means of mitigating all foreseeable biological, chemical, and physical hazards associated with the Project including, but not limited to, hazards associated with exposure to constituents of concern, heavy equipment operation, site conditions, weather, material handling, and work near water. • Work Zones - Provide a site plan that depicts the designation of zones, including: Exclusion Zone(s), Decontamination Zone(s), and Support Zone(s). The level of personal protection required for each zone must be included. • Personal Safety Equipment and Protective Clothing - Identify personal safety equipment and protective clothing to be available at the work site and used by Project personnel. This shall include identifying expected levels of protection (EPA Protection Levels A, B, C, and D) for each task and the action levels for personal protective equipment (PPE) upgrades. A respiratory protection program that meets the requirements of 29 CFR 1910.134 and establishes specific requirements for respirator use shall be included. • Work Zone Air Monitoring - Identify protocols and criteria associated with work zone air monitoring. • Work Zone Air Monitoring - Detailed plan for the specified requirements of the air monitoring program, including measures to be implemented to control dust and odors, and response measures to be implemented in the event of an exceedance of air monitoring action levels set forth in the HASP. • Work Zone Air Monitoring - Site plan showing the anticipated locations of the air monitoring stations, and available manufacturer's specifications associated with air monitoring equipment installation and operation. • Work Zone Air Monitoring - The Contractor shall maintain a written copy of the 15-minute running average concentrations for PM10 for each workday, as well as a weekly summary, to be available by 10:00 a.m. the following workday (for the Engineer for review at any time). Written documentation shall include an appropriately scaled map of the work area depicting community air monitoring locations, wind direction, and other pertinent meteorological data, date, time, instrumentation readings, calibration records, applicable standards, and engineering controls implemented (if necessary). • Personnel Decontamination - Describe methods and procedures to be used for personnel decontamination. • Material Safety Data Sheets - Provide Material Safety Data Sheets (MSDSs) for all materials to be brought onsite, as well as constituents which are expected to be encountered during the course of the Project. • Construction Safety Procedures (OSHA 1926.1 - 1926.652, Subparts A-P) to address excavation shoring and trenching safety, as well as a daily site safety inspection checklist to evaluate these items. • Standard Operating Procedures (SOPs) and Safety Programs as required by applicable sections of 29 CFR 1910 and 1926. 						

**Table F-1
Contractor Submittal Tracking Form
Former Wisconsin Steel Works, Chicago, IL
South Slip Sediment Cap Design Report**

Item No.	Submittal Description	Date Received	Review Conducted by:		Interim Status/Date (see Note 1)	Final Status/Date (see Note 1)	Notes
			CQA Engineer	Engineer of Record			
3	<p>Contingency Plan:</p> <ul style="list-style-type: none"> • Spill prevention and control plan for all materials brought to the work site. This plan should also include methods to address spills (should they occur). • Emergency vehicular access/egress. • Evacuation procedures of personnel from the work site. • Flood event contingency plan with measures to protect the site and waterways from impacts in the event of high water and/or flood conditions. The flood event contingency plan shall consider the following: <ul style="list-style-type: none"> - Monitoring weather reports (at least daily) to identify potential conditions that may result in a flood event. - Adjusting onsite activities in response to monitored stormwater flows and weather reports. - Providing pump system(s) to remove/handle ponded water at the support areas. These pumps would be used to handle non-contact stormwater (if necessary). - Relocating equipment to areas of the site that are not as prone to flooding, if necessary. - Monitoring the flood conditions to determine when remedial activities could resume (if the activities are discontinued due to a flood event). The determination to discontinue remedial activities due to a flood event will be agreed to in the field between the Contractor and the Owner. - Maintaining a stockpile of cap material onsite to allow capping activities to be implemented without delays associated with waiting for delivery of the material to the site. The amount of material to be stockpiled, the location of the stockpile, and the methods to secure the stockpile should be clearly outlined. Stockpiled materials must be protected against fugitive dusting and erosion. • List of all contact personnel with phone numbers, including: the Contractor; local fire official(s); ambulance service; local, county, and state police; and local hospitals, including routes to local hospitals and procedures for notifying each. • Identification of responsible personnel who will be in a position at all times to receive incoming phone calls and to dispatch Contractor personnel and equipment in the event of an emergency situation. 						
4	Environmental Protection Procedures - Product information for temporary seeding, silt fencing, turbidity curtains, and any other materials required per the Contractor's Erosion and Sedimentation Control Plan and/or the Remedial Design.						
5	Environmental Protection Procedures - Weekly inspection reports for erosion and sediment control measures.						
6	<p>Project Record Documents - Within 21 days following the completion of the Project, and prior to final payment, the Contractor shall provide one complete, accurate, and legible set of as-built survey drawings to the Engineer depicting and documenting the following:</p> <ul style="list-style-type: none"> • Existing (pre-construction) conditions, including bathymetry (minimum 1-foot contours), site features (e.g., fencing, roads, curbs, sidewalks, etc.), and subsurface features (e.g., utilities, foundations, etc.) encountered during the work, if any. • Final (post-construction) conditions, including surface topography and grade breaks (minimum 1-foot contours), sub-aqueous bathymetry, site features (e.g., fencing, roads, curbs, sidewalks, etc.), and subsurface features (e.g., utilities, manholes, etc.) installed/realigned during the work, if any. 						
7	<p>Project Record Documents - Once reviewed and accepted by the Engineer, provide finalized as-built survey drawings stamped and signed by a licensed Land Surveyor.</p> <ul style="list-style-type: none"> • Provide one (1) complete set of finalized, stamped/signed as-built survey drawings on 24- by 36-inch sheets. • Provide electronic copies (in Adobe® PDF format) of finalized, stamped/signed as-built survey drawings. • Provide AutoCAD files (Release 2000 or newer) of finalized as-built survey drawings. 						
8	<p>Fill/Cap/Topsoil Materials:</p> <ul style="list-style-type: none"> • Source name and location for clean fill and sediment cap materials. Similar information shall be provided for imported topsoil materials, if offsite sources are needed. • Samples and sieve analysis (ASTM D422) reports for the proposed fill and capping materials. • Analytical results for the proposed fill material (2 weeks prior to use onsite). Similar information, including pH and organic content, shall be provided for imported topsoil materials, if offsite sources are needed. 						
9	<p>Daily progress reports that will include, at a minimum, the following:</p> <ul style="list-style-type: none"> • Area capped each day, and the total square footage and the volume of materials placed. • Equipment maintenance and hours of downtime due to equipment breakdowns. • Weather conditions and hours of delays caused by weather conditions. • Hours of downtime due to Work Restrictions. 						

Notes:

1. Submittal status nomenclature is as follows:
 R - Reviewed
 N - Reviewed and noted
 S - Resubmit
 J - Rejected
 I - For your information