

# **State of the Great Lakes 2005 - DRAFT**

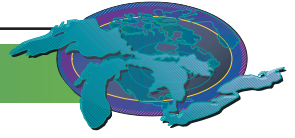


**Draft for Discussion at SOLEC 2004  
October 6 - 8, 2004**

# **State of the Great Lakes 2005 - DRAFT**

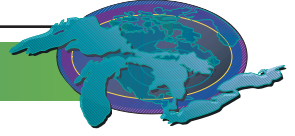


**Draft for Discussion at SOLEC 2004  
October 6 - 8, 2004**



## Table of Contents

Preface .....	1
1.0 Introduction .....	2
2.0 Management Challenges .....	7
3.0 Lake and River Assessments .....	9
4.0 Indicator Assessments	
4.1 Bundle Assessments and Tables .....	53
4.2 Indicator Reports .....	75
5.0 Progress Towards Indicator Reporting .....	307
6.0 Acknowledgements .....	317
7.0 Appendix .....	319



## State of the Great Lakes 2005 – Draft for Discussion

### Preface

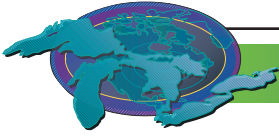
SOLEC 2004 organizers are pleased to provide you with this report, *The State of the Great Lakes 2005 – Draft for Discussion*. It has been prepared in order to form the basis for presentation and discussion at the conference. It pulls together indicator reports, assessments, and lake and river reports into a draft document.

It is hoped that by providing this information, stakeholders within the Great Lakes basin can use it as the basis for making sound decisions.

We welcome comments on this report, the information contained within, or any other component of the Conference. Please feel free to submit comments to the SOLEC co-chairs.

Harvey Shear  
Canadian Co-chair  
[Harvey.shear@ec.gc.ca](mailto:Harvey.shear@ec.gc.ca)

Paul Horvatin  
U.S. Co-chair  
[Horvatin.paul@epa.gov](mailto:Horvatin.paul@epa.gov)



## State of the Great Lakes 2005 - Draft for Discussion

### Introduction

#### SOLEC Overview

This *State of the Great Lakes 2005* report represents the sixth in a series, beginning in 1995, that provide biennial assessments of the Great Lakes basin ecosystem components as part of the State of the Lakes Ecosystem Conference (SOLEC) process. The information contained within the report represents the combined efforts of many stakeholders of the Great Lakes representing Federal, Tribal/First Nations, State, Provincial and Municipal governments; non-government organizations, industry, academia, and private citizens.

The SOLEC process was established by the governments of Canada and the U.S. in response to elements of the Great Lakes Water Quality Agreement that call for regular reporting on progress toward Agreement goals and objectives. Since the first conference in 1994, SOLEC has evolved into a two-year cycle of data collection, assessment and reporting on conditions in the Great Lakes basin. The objectives for SOLEC are:

- To assess the state of the Great Lakes ecosystem based on accepted indicators
- To strengthen decision-making and environmental management concerning the Great Lakes
- To inform local decision-makers of Great Lakes environmental issues
- To provide a forum for communication and networking amongst all the Great Lakes stakeholders

The Conferences themselves are attended by a diverse representation of government and non-government organizations, and the participants are encouraged to discuss and evaluate the information being presented. Beginning in 1998, the evaluations of Great Lakes ecosystem components have been based on a suite of carefully screened indicators that provide scientifically sound information on many ecosystem components. Recent themes for the Conferences have included the Nearshore Zone and Developing an Indicator Suite (1998), Reporting with Indicators and Biodiversity Investment Areas (2000), Biological Integrity (2002), and Physical Integrity (2004).

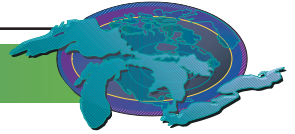
Following each Conference, participants and others interested in the Great Lakes are invited to provide further reviews, comments and suggestions regarding the information and evaluations to SOLEC organizers. A *State of the Great Lakes* report is then issued as a joint publication of the U.S. Environmental Protection Agency and Environment Canada.

#### What is new for 2005?

After the report *State of the Great Lakes 2003* was issued, two reviews of SOLEC processes and products were conducted. One was a review by experts on indicator systems outside the Great Lakes basin to evaluate the overall effectiveness and efficiency of SOLEC, and the other was a review by Great Lakes stakeholders to evaluate the entire suite of indicators developed to date. Significant improvements in both the SOLEC process and the configuration of the indicator suite were made as a result of these reviews, including the deletion, modification, addition or combination of indicators. Details of the modifications are documented in a companion report, *The Great Lakes Indicators Suite: Changes and Progress 2004*.

Another change introduced at SOLEC 2004 is the concept of indicator “bundles.” In previous *State of the Great Lakes* reports, indicators were grouped by geographic areas and issues (e.g., offshore and nearshore aquatic, nearshore terrestrial, coastal wetlands, human health, societal) or by indicator function (e.g., state of the environment, pressures on the environment, and human responses). For SOLEC 2004, indicators are grouped into more logical “bundles,” including Contamination, Biotic Communities, Invasive Species, Coastal Zones, Aquatic Habitats, Human Health, Land Use/Land Cover, Resource Utilization, and Climate Change. Within most of the main bundles are sub-bundles to further delineate issues or geographic areas. Under this model for grouping indicators, some indicators logically contribute to more than one bundle and are therefore listed more than one time.

The assessments for each indicator and for the Lake and River reports have been modified slightly to provide both a “status” component (Good, Fair, Poor, Mixed) and a “trajectory” component (Improving, Unchanging, Deteriorating, Undetermined). Definitions for these categories are as follows:



#### Status

**Good.** The state of the ecosystem component is presently meeting ecosystem objectives or otherwise is in acceptable condition.

**Fair.** The ecosystem component is currently exhibiting minimally acceptable conditions, but it is not meeting established ecosystem objectives, criteria, or other characteristics of fully acceptable conditions.

**Poor.** The ecosystem component is severely negatively impacted and it does not display even minimally acceptable conditions.

**Mixed.** The ecosystem component displays both good and degraded features.

#### Trajectory

**Improving.** Information provided by the report shows the ecosystem component(s) to be changing toward more acceptable conditions.

**Unchanging.** Information provided by the report shows the ecosystem component(s) is/are neither getting better nor worse.

**Deteriorating.** Information provided by the report shows the ecosystem component(s) to be changing away from acceptable conditions.

**Undetermined.** Data are not available to assess the ecosystem component(s) over time, so no trend can be identified.

Considerable progress was also achieved for previously under-developed indicator categories. The indicators for Coastal Wetlands have now been defined, refined, and in many cases reported on. Groundwater indicators have also been refined, and case studies have been piloted for their ability to be reported effectively. The indicators for Forest Lands were the subjects of debate among various forestry stakeholders in the Great Lakes basin, but a consensus approach was achieved, and a detailed report for the first of the sub-groupings (on *Conservation of Biological Diversity*) was submitted as indicator #8500 Forest Lands. Additional details of the process and results of deliberations of the Forest Lands working group are documented in a companion report, *Developing SOLEC Forest Indicators*.

#### The State of the Great Lakes 2005 Report

This is the first attempt by SOLEC organizers to prepare a *State of the Great Lakes* report for SOLEC participants prior to the Conference itself. In previous years, a compilation of indicator reports was prepared and distributed as a document, *Implementing Indicators: Draft for Discussion at SOLEC*. With the draft 2005 report, however, additional sections were added to more closely align the draft report with the expected final product.

Features of the *State of the Great Lakes 2005* report include:

##### 1. Management Challenges

[*Note to SOLEC 2004 Participants: For this Draft State of the Great Lakes 2005 report, Management Challenges have been brought forward from the State of the Great Lakes 2003 report. SOLEC participants are invited and requested to suggest updates to these Challenges, and to provide additional challenges stemming from the information in the indicator reports for SOLEC 2004.*]

##### 2. Lake, River and Connecting Channel Reports

[*Note to SOLEC 2004 Participants: The Lake and River reports have been part of the previous State of the Great Lakes reports, but they have not been prepared prior to SOLEC Conferences. Comments and suggestions for improving the reports are welcomed.*]

##### 3. Indicators grouped by “bundles”

The indicators for which reports are available are grouped according to defined “bundles” and sub-bundles. Overviews of each main bundle and the sub-bundles have been provided by an expert who was not an author of one of the indicator reports within the bundle. A listing of each of the indicators in each bundle is also provided. Because many of the indicators are associated with more than one bundle, the indicator reports are arranged in numeric order according to indicator I.D. number.

The listing of the *State of the Great Lakes 2005* indicator reports, the “bundle” categories, and the indicator assessments for 2005, 2003, and 2001 are provided in the following table. A complete listing of all indicators in the Great Lakes suite can be found in Appendix 1.



# STATE OF THE GREAT LAKES 2005-DRAFT

ID #	Indicator Name	2005 Assessment (Status, Direction)	2003 Assessment	2001 Assessment
<b>CONTAMINATION</b>				
<b>Nutrients</b>				
111	Phosphorus Concentrations and Loadings	Mixed, Undetermined	Mixed	Mixed
7061	Nutrient Management Plans	(2002 report)	No Assessment	
<b>Toxics in Biota</b>				
114	Contaminants in Young-of-the-Year Spottail Shiners	Mixed, Improving	Mixed Improving	
115	Contaminants in Colonial Nesting Waterbirds	Mixed, Improving	Mixed Improving	Good
121	Contaminants in Whole Fish	Mixed, Improving	No Assessment	
124	External Anomaly Prevalence Index for Nearshore Fish	Mixed, Undetermined	No Assessment	
4177	Biologic Markers of Human Exposure to Persistent Chemicals	Mixed, Undetermined		
4201	Contaminants in Sport Fish	Mixed, Improving	Mixed Improving (#4083)	Mixed Improving (#4083)
4506	Contaminants in Snapping Turtle Eggs	Mixed, N/A	Mixed	Mixed
8135	Contaminants Affecting Productivity of Bald Eagles	Mixed, Improving	Mixed Improving	Mixed Improving
8147	Contaminants Affecting the American Otter	(2002 report)	Mixed	No Assessment
<b>Toxics in Media</b>				
117	Atmospheric Deposition of Toxic Chemicals	Mixed, Improving & Mixed, Unchanging	Mixed	Mixed Improving
118	Toxic Chemical Concentrations in Offshore Waters	Mixed, Improving	Mixed Improving	Mixed
119	Concentrations of Contaminants in Sediment Cores	Mixed, Improving	Mixed Improving	
4175	Drinking Water Quality	Good, Unchanging	Good	Good
4202	Air Quality	Mixed, Improving	Mixed	Mixed
9000	Acid Rain	Mixed, Improving	Mixed Improving	Mixed
<b>Sources and Loadings</b>				
117	Atmospheric Deposition of Toxic Chemicals	Mixed, Improving & Mixed, Unchanging	Mixed	Mixed Improving
4202	Air Quality	Mixed, Improving	Mixed	Mixed
9000	Acid Rain	Mixed, Improving	Mixed Improving	Mixed
<b>BIOTIC COMMUNITIES</b>				
<b>Fish</b>				
8	Salmon and Trout	Mixed, Improving	Mixed	
9	Walleye	Good, Unchanging	Mixed	Good
17	Preyfish Populations	Mixed, Deteriorating Mixed, Improving	Mixed Deteriorating	Mixed Improving
93	Lake Trout	Mixed, Improving & Mixed, Unchanging	Mixed	Mixed
125	Status of Lake Sturgeon in the Great Lakes	Mixed, Undetermined	No Assessment	
4502	Coastal Wetland Fish Community Health	No Assessment		
<b>Birds</b>				
115	Contaminants in Colonial Nesting Waterbirds	Mixed, Improving	Mixed Improving	Good
4507	Wetland-Dependent Bird Diversity and Abundance	Mixed, Deteriorating	Mixed Deteriorating	Mixed Deteriorating
8135	Contaminants Affecting Productivity of Bald Eagles	Mixed, Improving	Mixed Improving	Mixed Improving
<b>Mammals</b>				
8147	Contaminants Affecting the American Otter	(2002 report)	Mixed	No Assessment



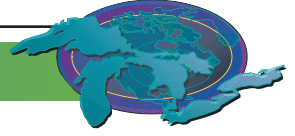
<b>Amphibians</b>				
4504	Coastal Wetland Amphibian Diversity and Abundance	Mixed, Deteriorating	Mixed Deteriorating	Mixed Deteriorating
7103	Groundwater Dependant Plant and Animal Communities	No Assessment		
<b>Invertebrates</b>				
68	Native Freshwater Mussels	No Assessment	No Assessment	Mixed Deteriorating
104	Benthos Diversity and Abundance	(2002 report)	Mixed	
116	Zooplankon Populations	(2002 report)	No Assessment	Mixed
122	Hexagenia	Mixed, Improving	Mixed Improving	Mixed Improving
123	Abundances of the Benthic Amphipod <i>Diporeia</i>	Mixed, Deteriorating	Mixed Deteriorating	Mixed
4501	Coastal Wetland Invertebrate Community Health	No Assessment		
<b>Plants</b>				
109	Phytoplankton Populations	(2002 report)	No Assessment	Mixed
4862	Coastal Wetland Plant Community Health	Mixed, Deteriorating Mixed, Improving		
8500	Forest Lands - Conservation of Biological Diversity	Mixed, Improving		
<b>INVASIVE SPECIES</b>				
<b>Aquatic</b>				
18	Sea Lamprey	Good-Fair, Improving	Mixed Improving	Mixed
9002	Non-Native Species (Aquatic)	Poor, Deteriorating	Poor	Poor
<b>COASTAL ZONES</b>				
<b>Nearshore Aquatic</b>				
4861	Effects of Water Levels Fluctuations	(2002 report)	Mixed	Mixed Deteriorating
8131	Extent of Hardened Shoreline	(2000 report)	(2000 report)	Mixed Deteriorating
<b>Coastal Wetlands</b>				
4501	Coastal Wetland Invertebrate Community Health	No Assessment		
4502	Coastal Wetland Fish Community Health	No Assessment		
4504	Coastal Wetland Amphibian Diversity and Abundance	Mixed, Deteriorating	Mixed Deteriorating	Mixed Deteriorating
4506	Contaminants in Snapping Turtle Eggs	Mixed, N/A	Mixed	Mixed
4507	Wetland-Dependent Bird Diversity and Abundance	Mixed, Deteriorating	Mixed Deteriorating	Mixed Deteriorating
4510	Coastal Wetland Area by Type	Mixed, Deteriorating		Mixed Deteriorating
4861	Effects of Water Levels Fluctuations	(2002 report)	Mixed	Mixed Deteriorating
4862	Coastal Wetland Plant Community Health	Mixed, Deteriorating Mixed, Improving		
<b>Terrestrial</b>				
4861	Effects of Water Levels Fluctuations	(2002 report)	Mixed	Mixed Deteriorating
8129	Area, Quality, and Protection of Special Lakeshore Communities - Cobble Beaches	Mixed, Deteriorating		
8129	Area, Quality, and Protection of Special Lakeshore Communities - Alvars	(2000 report)	(2000 report)	Mixed
8131	Extent of Hardened Shoreline	(2000 report)	(2000 report)	Mixed Deteriorating
<b>AQUATIC HABITATS</b>				
<b>Open Lake</b>				
111	Phosphorus Concentrations and Loadings	Mixed	Mixed	Mixed
118	Toxic Chemical Concentrations in Offshore Waters	Mixed, Improving	Mixed Improving	Mixed
119	Concentrations of Contaminants in Sediment Cores	Mixed, Improving	Mixed Improving	
8131	Extent of Hardened Shoreline	(2000 report)	(2000 report)	Mixed Deteriorating





# STATE OF THE GREAT LAKES 2005-DRAFT

<b>Groundwater</b>				
7100	Natural Groundwater Quality and Human-Induced Changes	No Assessment	No Assessment	
7101	Groundwater and Land: Use and Intensity	No Assessment	No Assessment	
7102	Base Flow Due to Groundwater Discharge	Mixed, Deteriorating	No Assessment	
7103	Groundwater Dependant Animal and Plant Communities	No Assessment		
<b>HUMAN HEALTH</b>				
4175	Drinking Water Quality	Good, Unchanging	Good	Good
4177	Biologic Markers of Human Exposure to Persistent Chemicals	Mixed, Undetermined		
4200	Beach Advisories, Postings and Closures	Mixed, Undetermined	Mixed (#4081)	Mixed (#4081)
4201	Contaminants in Sport Fish	Mixed, Improving	Mixed Improving (#4083)	Mixed Improving (#4083)
4202	Air Quality	Mixed, Improving	Mixed (#4176)	Mixed (#4176)
<b>LAND USE - LAND COVER</b>				
<b>General</b>				
7002	Land Cover - Land Conversion	No Assessment		
7101	Groundwater and Land: Use and Intensity	No Assessment		
<b>Forest Lands</b>				
8500	Forest Lands - Conservation of Biological Diversity	Mixed, Improving		
<b>Agricultural Lands</b>				
7028	Sustainable Agriculture Practices	(2002 report)	No Assessment	Mixed
7061	Nutrient Management	(2002 report)		
7062	Integrated Pest Management	(2002 report)		
<b>Urban/Suburban Lands</b>				
7000	Urban Density	Mixed, N/A	Mixed Deteriorating	Unable to Assess
7006	Brownfield Redevelopment	(2002 report)	Mixed Improving	Mixed Improving
<b>Protected Areas</b>				
8129	Area, Quality, and Protection of Special Lakeshore Communities - Cobble Beaches	Mixed, Deteriorating		
8129	Area, Quality, and Protection of Special Lakeshore Communities - Alvars	(2000 report)	(2000 report)	Mixed
<b>RESOURCE UTILIZATION</b>				
3514	Commercial/Industrial Eco-Efficiency	(2002 report)	No Assessment	
7043	Economic Prosperity	(2002 report)	Mixed	Mixed
7056	Water Withdrawal	Mixed, Unchanging		
7057	Energy Consumption	Mixed, N/A	Mixed Deteriorating	
7060	Solid Waste Generation	(2002 report)	Mixed	
<b>CLIMATE CHANGE</b>				
4858	Climate Change: Ice Duration on the Great Lakes	(2002 report)	Mixed Deteriorating	



## State of the Great Lakes 2005 - Draft for Discussion

### Management Challenges

*Note to SOLEC 2004 participants:*

*The Management Challenges presented here were excerpted from the **State of the Great Lakes 2003** report. They were based on the lake and river basin assessments and the indicator reports that were prepared for SOLEC 2002 and updated for the State of the Great Lakes 2003 report. Five general themes emerged: land use, habitat degradation, climate change, toxic contamination, and indicator development.*

*You are urged to review these Management Challenges for their relevance to current conditions (both environmentally and politically). You are also urged to suggest changes or new Challenges based on the status and trends information about the Great Lakes basin ecosystem provided in this report and at SOLEC 2004.*

*Your insights and suggestions will be the basis for the updated Management Challenges in the final **State of the Great Lakes 2005** report. Please forward your thoughts to Nancy Stadler-Salt ([nancy.stadler-salt@ec.gc.ca](mailto:nancy.stadler-salt@ec.gc.ca)) or Paul Bertram ([bertram.paul@ec.gc.ca](mailto:bertram.paul@ec.gc.ca)) at your earliest convenience.*

### Land Use

*Management Challenge: What land use decisions will sustain the ecosystem over the long term, thereby contributing to improvements in the quality of land and water?*

Current land use decisions throughout the basin are affecting the chemical, physical and biological aspects of the ecosystem. Each Lake and River assessment presented at SOLEC 2002 cited the need for improved land use decisions to counter the detrimental effects of urban sprawl and increased population growth (<http://www.epa.gov/glnpo/solec/2002/plenaries.html>). One approach to analyzing land use, the “ecological footprint,” has been applied to the Great Lakes basin by the originators of the approach, Mathis Wackernagel and William Rees (*Our Ecological Footprint*, 1996). They estimate that an area equivalent to 50 percent of the land mass of the United States is needed to support the current lifestyle of Great Lakes basin citizens. Managers are keenly aware of the importance of using the most current information when making land use decisions that may contribute to either the sustenance or degradation of the ecosystem.

*(Note to readers: we will be presenting a more accurate ecological footprint of the residents in the Great Lakes basin at SOLEC 2004.)*

### Habitat Degradation

*Management Challenge: How can essential habitats be protected and restored to preserve the species and unique and globally significant character of the Great Lakes ecosystem?*

Many factors, including the spread of non-native species, degrade plant and animal habitats. For example: native mussel species are facing extinction due to pressures from non-native zebra and quagga mussels; hydrological alterations are impacting the functioning of wetland habitats; and, poorly planned development is degrading or destroying essential habitats. Ecological protection and restoration actions are needed to sustain these essential Great Lakes habitats. Managers need current data, research to determine appropriate ecological protection and restoration tools and technologies, monitoring programs to understand species trends, and educational programs that provide the public with a broad spectrum of actions.



### **Climate Change**

*Management Challenge: What research is needed to respond to potential climate change impacts?*

Climate change has the potential to impact Great Lakes water levels, habitats for biological diversity, and human land uses such as agriculture. In Ohio, for example, a string of mild winters has contributed to an infestation of slugs in corn and soybean crops. Farmers may be faced with a return to tillage plowing or the use of molluscicides to control the infestation. Either choice would reverse some of the most encouraging progress toward controlling non-point source pollution. A management challenge is the need to research further the potential impacts of climate change on the basin and to adapt to those changes as required.

### **Toxic Contamination**

*Management Challenge: How will we address the economic and practical issues of the continued removal of toxic contamination from our ecosystem?*

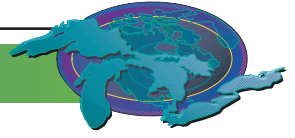
The Great Lakes community has been remediating toxic contamination in water, fish, sediments, air, and people for more than 30 years, yet problems persist. Although loadings of contaminants to the Lakes have been greatly reduced from their peak in the 1970s, pathogens in the water at swimming beaches, for example, are a continuing concern. Controls on industrial emissions of contaminants have been legislated and enforced, resulting in reductions in levels of contaminants in the environment. Non-point source runoff reductions are significant, and optimal reductions are not yet being achieved. The approach to dealing with agricultural practices to reduce runoff of pesticides and fertilizers may require a mix of approaches including voluntary measures and incentives. A management challenge is to economically and practically continue to remove toxic contamination and excess nutrients from the ecosystem.

### **Indicator Development**

*Management Challenge: What method for developing indices will assist Great Lakes managers to better interpret indicator information?*

Given the large number of current and potential indicators, it is difficult to sort and interpret findings in a way that is expedient and productive for managers. Managers and others prefer a few scientifically sound indices, based on the suite of indicators, so that they can make appropriate management decisions, or can better interpret the information presented in the State of the Great Lakes reports. A management challenge is to find a method for indexing groups of indicators in a way that leads to more informed management decision making.

*(Note to readers: for SOLEC 2004, the organizers have bundled indicators into nine categories and have had experts prepare assessments of each category. Does this impart the right information to managers? Does this impart enough information to the managers? We need your feedback!)*



## State of the Great Lakes 2005 - Draft for Discussion

### Lake and River Assessments

This section of *State of the Great Lakes 2005 – Draft for Discussion* provides a summary narrative of the state of each of the five Great Lakes, the St. Clair-Detroit River ecosystem, and the St. Lawrence River. Each narrative also includes an overall assessment based on reviews of available scientific data, reports, and the best professional judgment of the involved scientists and policy makers, along with the information provided in the indicator reports found in the next section. These assessments were provided by primary authors with consultation among the various agencies, groups and organizations involved in the ecosystem management of these large water bodies.

Four broad ranking categories were used to characterize the assessments:

**Good.** The state of the ecosystem component(s) is/are presently meeting ecosystem objectives or otherwise is in acceptable condition.

**Fair.** The ecosystem component(s) is/are currently exhibiting minimally acceptable conditions, but it is not meeting established ecosystem objectives, criteria, or other characteristics of fully acceptable conditions.

**Poor.** The ecosystem component(s) is/are severely negatively impacted and it does not display even minimally acceptable conditions.

**Mixed.** The ecosystem component(s) displays both good and degraded features.

In addition, one of four ecosystem trajectories (or trends over time) was requested:

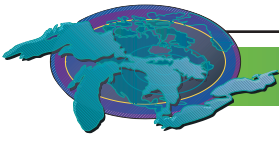
**Improving.** Information provided by the report shows the ecosystem component(s) to be changing toward more acceptable conditions.

**Unchanging.** Information provided by the report shows the ecosystem component(s) is/are neither getting better nor worse.

**Deteriorating.** Information provided by the report shows the ecosystem component(s) to be changing away from acceptable conditions.

**Undetermined.** Data are not available to assess the ecosystem component(s) over time, so no trend can be identified.

In addition to the assessments and summary narratives, the reports also include a discussion of the pressures on the system, and future and emerging management issues. An underlying emphasis on “physical integrity” throughout the reports reflects the overall theme for SOLEC 2004.



## Lake Superior

### Assessment: Mixed

*The state of the Lake Superior ecosystem remains mixed*. Non-native species continue to be a problem; some trends in contaminant loadings are showing declines while others remain constant; and fisheries recovery indicators are good although non-native species remain a threat to the recovering fish population. Bald eagles, gray wolf and cormorants have recovered and forest cover has increased. Stresses on the system include shoreline development, habitat loss, land use change and emerging chemical contaminants.

### Summary of the State of Lake Superior

Lake Superior is the largest freshwater lake in the world by area and third largest by volume; it averages 147 m in depth, with maximum depth of 406 m. The total watershed area is 88,031 mi<sup>2</sup> (228,000 km<sup>2</sup>) including Lake Nipigon and two major diversions; water transparency can reach a depth of 23 meters (75 feet); and has the lowest summer surface temperature (13 C) and mean annual water temp (3.6 C, 34 degrees F) of the Great Lakes. The watershed contains many globally rare vegetation types, including arctic alpine communities, sand dunes, and pine barrens. The three principal industries are forestry, mining and tourism.

### Chemical Contaminants

Over the last 30 years, concentrations of nearly all measured contaminants in fish and the water column, with the exception of toxaphene, have declined in Lake Superior. Because of its remote location, limited industrial activity and large surface to watershed ratio, Lake Superior receives the majority of its loading via atmospheric deposition, especially with regard to PCBs, mercury and toxaphene.

For example, Figure 1 shows the mercury decreases that have occurred between 1990 and 2000. While significant reductions have occurred in products and mining, emissions from fuel combustion are virtually unchanged.

### Water Column

Concentrations of a suite of toxic organic contaminants in water including the Lake Superior critical and lakewide remediation pollutants declined more than 50 percent between 1986 and 1997. Nevertheless, of the nine critical pollutants, dieldrin, mercury, PCBs and toxaphene concentrations in Lake Superior continue to exceed the most stringent water quality standards

### Gull Eggs

Herring Gull eggs have been collected and analyzed annually from the same two Lake Superior sites since 1974 for selected contaminants. 64.3% of contaminant-colony comparisons are declining as fast or faster than they were earlier in the study, while 28.6% have declined more slowly in recent years. Dieldrin and heptachlor epoxide are declining faster now than they did earlier in the study, although data for 1998-2002 show that gull eggs from Lake Superior sites were among the most contaminated in the Great Lakes.

### Fish Contaminants

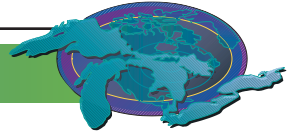
DDT: USEPA Great Lakes National Program Office (GLNPO) and Canada Department of Fisheries and Ocean (DFO) lake trout data both display a general fluctuation in concentrations from year to year with a recent increase in concentration. Fluctuations are likely due to changes in food web or subpopulations. Lake trout DDT concentrations are below the GLWQA criteria.

Toxaphene: Concentrations of toxaphene have declined dramatically in lake trout across all Great Lakes except for Lake Superior. Lower productivity, colder temperatures and large surface area are likely responsible for higher Superior levels.

PCBs: GLNPO lake trout collections show some fluctuation with a leveling off beginning in the 1980s; DFO lake trout data show very little recent change in mean PCB concentrations. Lake trout concentrations remain above the GLWQA criteria.

Mercury: DFO smelt data continue show a steady decline in Hg concentrations through 2002, with the lowest recorded concentration since 1981; levels are below GLWQA criteria. Sea lamprey and other Lake Superior biota, however, contained the highest concentrations of all the Great Lakes in 2001-2002.

GLNPO has lake trout contaminant data in the Apostle Islands that show similar decreases. Figure 2 shows the trends for four of the



Lake Superior critical chemicals. Dieldrin and chlordane appear to be leveling off, DDT appears to be increasing slightly and PCBs are fluctuating, although levels have dropped since 1980.

The number and geographic extent of sport fish consumption advisories in Lake Superior is expected to decrease as contaminant concentrations decline. However, the ecosystem requires decades to purify itself, and agencies will likely continue to issue sport fish advisories for some time.

### **Atmospheric Deposition**

Data from the Great Lakes Integrated Atmospheric Deposition Network (IADN) indicate that levels of PCBs and banned organochlorine pesticides are declining at all master stations. For Lake Superior, the Duluth/Superior area appears to have some influence on PAHs and possibly HCB deposition to the lake. There is no apparent effect of this urban area on PCB deposition. IADN data also suggest that the Canadian prairie provinces and the southern US are sources of lindane to Lake Superior. Lake trout from Lake Superior have higher concentrations of PCBs than lake trout in smaller lakes, which may be attributable to the food web in Superior, the large surface area, slow turnover rate, and the old age of lake trout in the lake.

## **WILDLIFE AND HABITAT**

### **Forest**

Forest fragmentation and changes in forest composition are two of the seminal changes to the Lake Superior basin since settlement times. Beginning in the 1880's US forests were almost entirely clear-cut. Aspen, birch, fir and poplar have increased since logging while spruce and pines have been severely reduced. Forest cover is anticipated to remain the same or slightly increase in the future. Forest fragmentation of hardwoods will continue to increase due to development and including road construction. For example, the overall amount of transportation in the basin increased by 34% between 1987 and 1998, due in part to a shift in housing from urban to rural areas. In Michigan, a 79% increase in the second home market is expected to occur between 1995 and 2015 indicating that road networks will continue to expand.

The Great Lakes Forestry Alliance reported in 1995 that timber growth in Michigan, Minnesota, and Wisconsin exceeded harvest by 90 percent and timber volume increased from about 25 billion cubic feet in 1952 to more than 50 billion cubic feet in 1992.

### **Wetlands**

About 15% of the US basin and 6-25% of the Canadian basin are wetlands. The greatest threats to Lake Superior's wetlands are wetland draining and filling, toxic contamination, water level regulation and site-specific stresses such as shoreline development. Other threats include invasive species and diminished water quality. Although there have been many wetland restoration success stories, it is not possible to determine if there has been a net loss or gain because of limitations on, and lack of coordination among, current monitoring efforts.

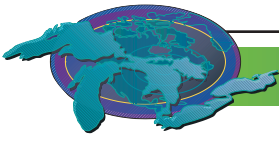
Loss of wetland habitat has been small in some counties but most of the St. Louis River estuary wetlands at Duluth have been lost since the early 1900's. The wetlands of the Apostle Islands, Bad River and Kakagon Slough are largely intact. Wetland loss in Ontario is low (0 – 25 percent) for most of the basin, but locally, wetland losses are substantial, especially in AOCs in Thunder Bay, Nipigon Bay, Jackfish Bay, and Peninsula Harbor due to shoreline modification and urban encroachment. Wetland area around the city of Thunder Bay has declined by over 30 percent since European settlement.

Lake Superior shoreline wetlands are a particular concern in Ontario, given their scarcity and proximity to developed areas. Continued cottage development at Cloud Bay, Sturgeon Bay and Pine Bay threatens wetlands.

### **Wildlife**

Habitat changes on the landscape, as well as harvest and management of select species, have created some dramatic changes in wildlife communities over the past 150 years. Ungulates, wolves and furbearers were hunted to near extinction but are now rebounding, while Caribou and Canadian lynx are still scarce.

Eighteen animal species found in the Lake Superior watershed, including mammals, birds, insects and herptiles, are listed by Canada and/or the U.S. as endangered. In addition, there are 400 species in the basin listed by provincial or state jurisdictions as endangered,



threatened, or of special concern. Of the 400 species, nearly 300 are plants. The preparation of recovery plans or conservation strategies is underway for 26 species.

Successful reintroduction of peregrine falcons is underway within the basin; recovery planning is also underway for a number of species at risk in the basin, i.e., caribou, piping plover and wood turtle. Cormorants and herring gulls are recovering after being decimated by toxic contaminants in the 70's.

Little work has been done to monitor and classify the status of amphibians and reptiles in comparison to other vertebrates, although the planning of a basin-wide monitoring program for herptiles is underway. Thirty-seven species of reptiles and amphibians have been documented – 7 salamander, 12 frog, 6 turtle, 2 lizard and 1 snake.

As with many vertebrates, the widespread changes in habitat cover across the landscape have had a dramatic effect on the community composition of amphibians and reptiles. However, local population declines of many amphibians are becoming a concern worldwide. Many possible reasons exist for these declines; monitoring programs have been initiated to document trends.

### **Aquatic Communities**

The fish community of Lake Superior is generally good and remains relatively intact compared to the other Great Lakes. Through rehabilitation, lake trout and lake whitefish stocks have increased substantially and may be approaching ancestral states. Some stocking still occurs in selected regions but indigenous species are naturally reproducing throughout the lake and in numbers sufficient to sustain themselves. Diporeia populations appear stable. Lake herring have recovered but under sporadic recruitment. Natural reproduction supports most salmonid populations. Some nearshore fish populations –especially lake sturgeon, walleye and brook trout, remain below historical levels.

Non-native species continue to be introduced to Lake Superior, although the fish community appears to contain enough buffering capacity to withstand and minimize the current levels of non-native species. Sea lampreys still kill thousands of lake trout each year, round gobies and ruffe have colonized some areas and have the ability to negatively impact nearshore cool-water fish community.

### **Aquatic Habitat**

All the offshore and most of the nearshore habitat remain healthy and productive; as a result, all forms of lake trout are abundant. The majority of impairments to aquatic habitat and water quality are found in embayments and tributaries. These tributaries remain significantly degraded by such stressors as agriculture, mining, hydroelectric dams, industrial effluents and waste, wetland dredging and filling, nonpoint source pollution, shoreline development and use practices that lead to increased runoff and erosion. In particular, discharges of mine chemicals and tailings have degraded a few local areas of the nearshore habitat zone along the MN and MI shorelines. Atmospheric deposition of contaminants lakewide has degraded all habitat zones to some degree.

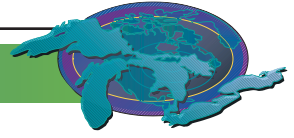
## **SHORELINE DEVELOPMENT and HARDENING**

Shoreline development is one of the most pressing issues facing the Lake Superior Basin today. The Keweenaw Peninsula on Michigan's Upper Peninsula has seen unprecedented growth in the past 20 years, mainly as recreational homes; over 50 percent of the homes in Keweenaw County are now classified as second homes. Population growth is greatest in the Duluth/Superior areas and the Bayfield Peninsula. In Ontario, this trend is greatest along the shorelines east and west of Thunder Bay and north of Sault Ste. Marie.

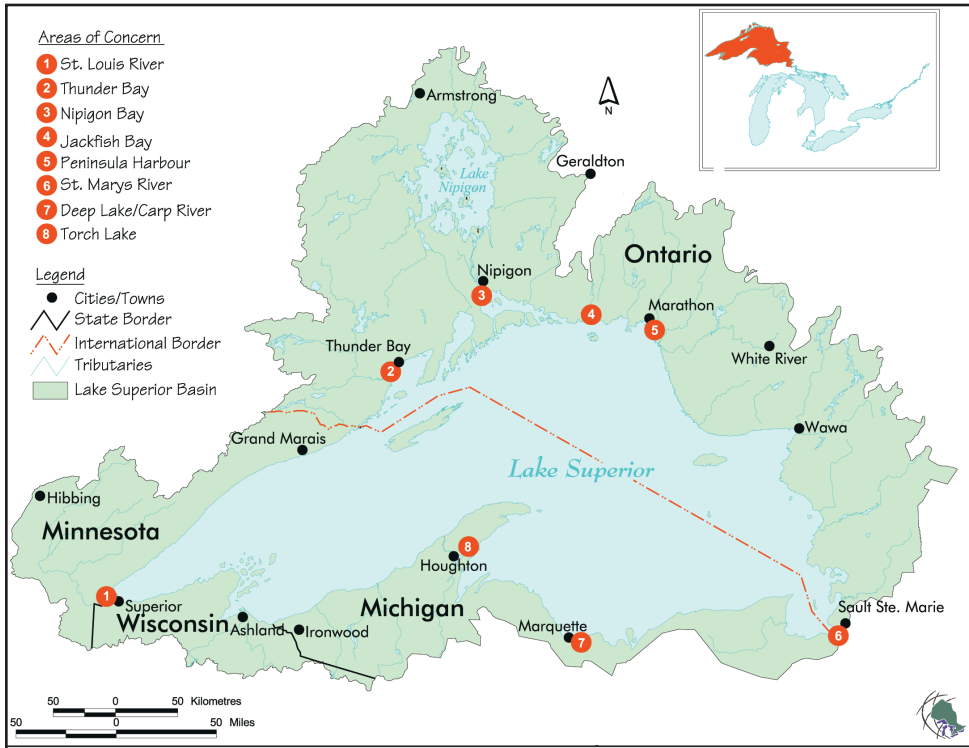
Shoreline hardening, which consists of sheet piling, rip rap or other erosion control structures, is an increasing problem for Lake Superior. Although Lake Superior has the lowest percentage of shoreline hardening – 3.1% of the shoreline is 70-100% hardened and 1% is 40-70% hardened – the trend is increasing.

### **Summary**

Lake Superior has many pressures on its system – continued degradation of tributary and embayment aquatic habitat, shoreline and other habitat development, continued introduction and impacts of non-native species; continued deposition of critical pollutants, emerging chemicals such as polybrominated diphenyl ethers (PBDE-flame retardants), pharmaceuticals, and personal health products. Global warming, climate change, increasing water temperature, large-scale water export are other critical issues facing the



ecosystem. The governments recently reaffirmed their commitment to the Zero Discharge Demonstration Program, the Lake Superior cooperative monitoring program has been working to develop priorities for the Lake Superior monitoring year in 2005-6, many habitat inventory, assessment and monitoring programs are being implemented and rehabilitation of critical aquatics habitat is underway.



Lake Superior Drainage Basin.

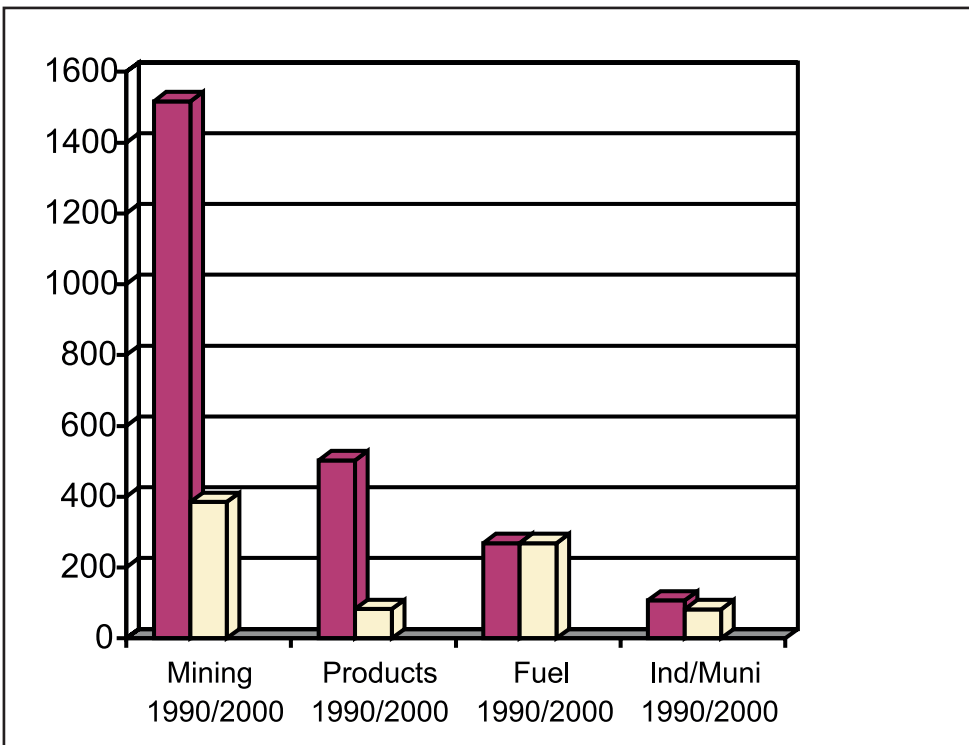


Figure 1. Mercury emissions from sources in the Lake Superior basin: 1990 and 2000 (kilograms/year). Source: Lake Superior LaMP Chemical Committee, 2003



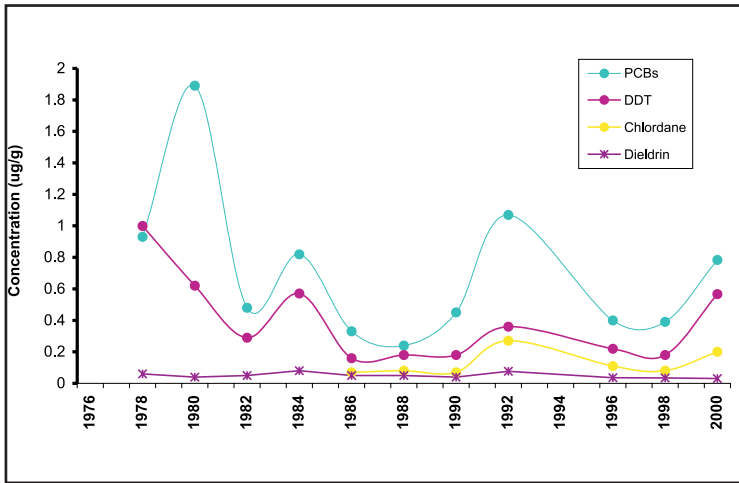
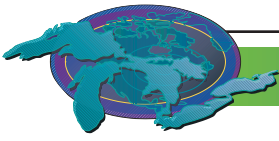


Figure 2. Apostle Island lake trout contamination trends, 1978-2000. Source: Murphy, 2004

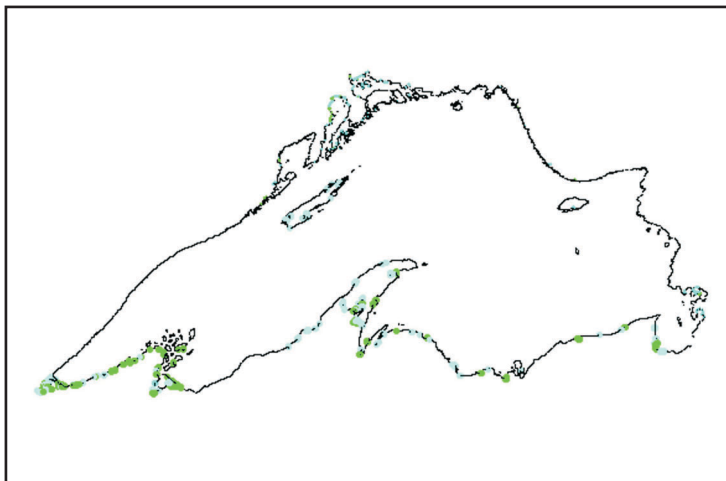


Figure 3. Lake Superior shoreline wetlands: extensive (green) and fringing (blue) (compiled from U.S. EPA 1994 and Environmental Canada 1993).

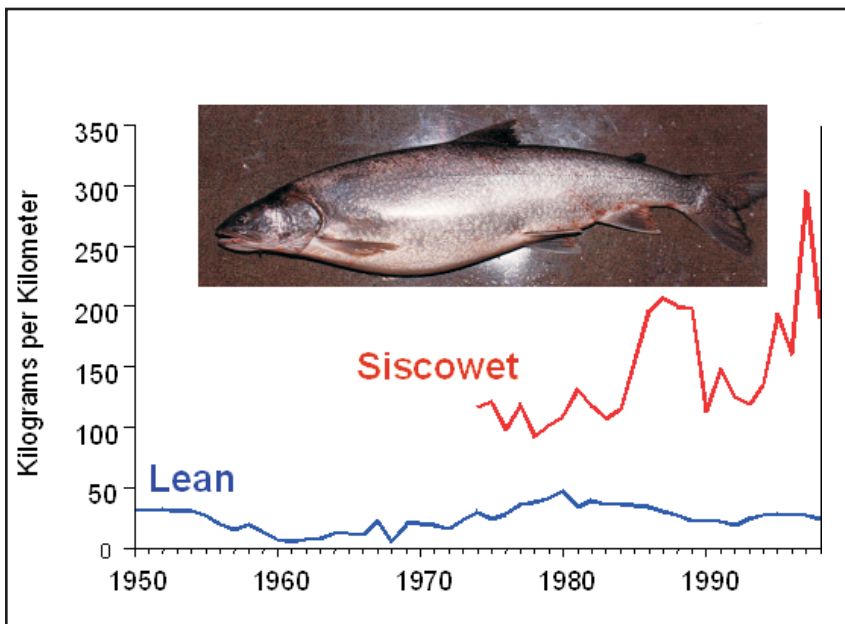


Figure 4. All forms of lake trout abundance.

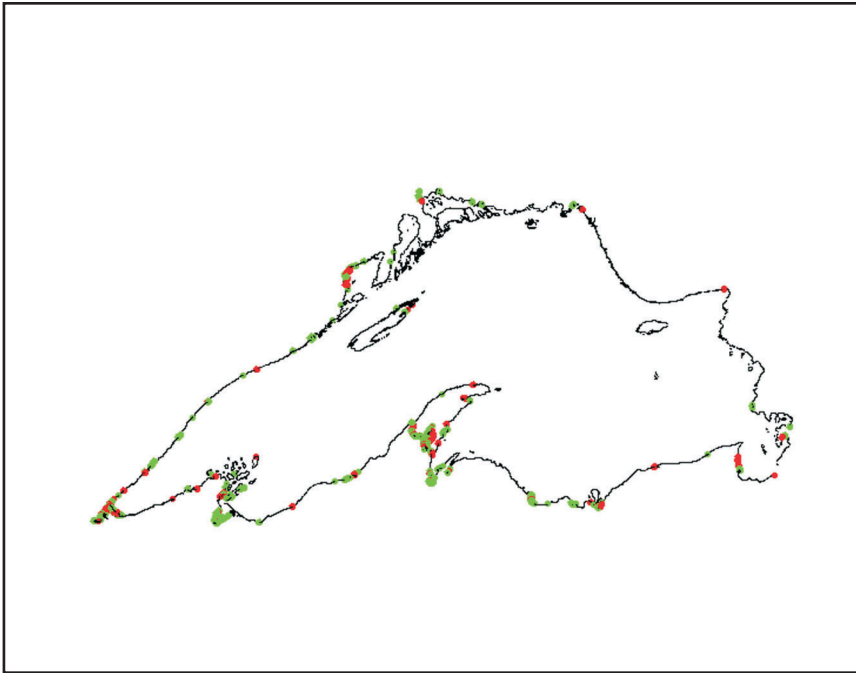
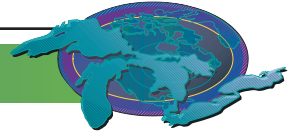


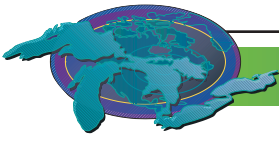
Table 1. Status of Amphibian Species found in the Lake Superior basin in Minnesota and Wisconsin.  
 Source: Compiled from Casper, 1998; Moriarty 1998; Mossman and others 1998.

Species	MN	WI
Wood frog	→	↑
Northern leopard frog	→↓	↓
Pickerel frog		↓
Mink frog	?	?
Green frog	→	→
Chorus frog	?	→
Northern spring peeper	→	↓↓
Eastern gray treefrog	→	→
Cope's gray treefrog	?	↓
Blanchard's cricket frog	SC	SE
American toad	→	→
Blue-spotted salamander	→	→
Eastern tiger salamander	↓?	
Spotted salamander		→
Four-toed salamander	?	SC
Redback salamander	→	
Mudpuppy	?	?

KEY	
®	Relatively stable
	Increasing
?	Decreasing
SE	State Endangered
SC	Special Concern

Figure 5. Man-made shorelines: red is retaining walls, harbor structure, and breakwater; green is rip-rap.



## Lake Michigan

### Assessment: Mixed

The 2000 Lake Michigan Lakewide Management Plan's assessment remains valid in 2004: "Lake Michigan is an outstanding natural resource of global significance, under stress and in need of special attention." Since that assessment there have been both positive and negative change, keeping the assessment as mixed.

### Background Summary

Lake Michigan's is one of the most complex of the Great Lakes due to its length of 307 miles from north woods forest to southern dune and swale ecosystems. The largest collection of fresh water sand dunes in the world is also a prominent feature. Lake Michigan Islands can be grouped into two northern archipelagoes. The 19 Grand Traverse islands are in Lake Michigan and Green Bay in the Door county area while The Beaver Islands lie east of those. Many are developed with loss of natural habitat and are moderately degraded. Several of the Beaver Island group are part of the Michigan Islands National Wildlife Refuge providing 235 acres of habitat for migratory and colonial nesting birds and federally threatened plants like dwarf iris and Pitcher's thistle.

Lake Michigan is second largest Great Lake by volume and contains 40% of the Great Lakes Coastal Wetlands responsible for the quantity and diversity of aquatic life seen in the lake. Protection and enhancement of these areas is key to the future sustainability of the coastal ecosystem.

Lake Michigan is uniquely positioned with direct connection to the Mississippi River System, and as such has become both a vector and receiver of many threats to the biological integrity of all the Great Lakes.

Lake Michigan has 10 Areas of Concern (AOCs) and 33 8-digit hydrologic unit code (HUC) tributary watersheds, most with some impairments. Many of the tributaries have been dammed in the past, but recent dam removals in Southeastern Wisconsin have resulted in improved fish habitat, water quality and diversity of species including the rare greater redhorse in the Milwaukee River section in Grafton, WI. The removal of dams is also an issue in Michigan on a number of tributaries.

Lake Michigan is home to the largest US population of all the Great Lakes with over 10 million dependent on the lake for high quality drinking water. Since passage of the BEACH Act of 2000 the four Lake Michigan states are on track in implementing the provisions, with an average of 50% more monitoring using enhanced standards. The results has led to increased advisories and studies to determine sources.

### Groundwater Flow

Groundwater divides are not necessarily the same as the Great Lakes surface/watershed divide. In the Great Lakes basin, most shallow flow discharges to local streams - the Great Lakes watershed divide (i.e., the subcontinental divide) also serves as a groundwater divide for shallow flow. Most deep flow discharges to regional sinks and the deep aquifer divide, however, can be distant from the surface watershed divide.

Groundwater divides move in response to pumping. Pre-development, 1950, and 2000 divides for the deep bedrock aquifer show a pattern of movement. The western basin ground water that once flowed east toward Lake Michigan is now intercepted by pumping and diverted west under the surface-water divide.

After use, it is often discharged to surface water within the Mississippi River Basin. Since the late 1940s, development on the Mississippi Basin side of the subcontinental divide has reversed deep flow patterns between west of the divide and the Milwaukee area. The groundwater levels are low enough that the lake can migrate into the groundwater.

### Groundwater's role in the Health of the Lake Michigan Ecosystem

The Great Lakes are in topographically low settings that, under natural flow conditions, causes them to function as discharge areas or "sinks" for the ground-water-flow system. Most ground water that discharges directly into the lakes is believed to take place near the shore (Grannemann and Weaver, 1999). Of all the Great Lakes, Lake Michigan has the largest amount of direct ground water discharge (2,700 ft<sup>3</sup>/s) because it has more sand and gravel aquifers near the shore than any of the other Great Lakes (Grannemann and



Weaver, 1999). Although this is a relatively low inflow compared to the total streamflow into the lake from land areas (41,200 ft<sup>3</sup>/s) (Croley and Hunter, 1994), it is nearly equal to the amount of water diverted from Lake Michigan through the Chicago Ship and Sanitary Canal (Oberg and Schmidt, 1996).

#### **Ground water provides refuge for aquatic organisms**

Ground-water discharge to streams may help provide important habitat for aquatic organisms, including fish. In addition, because ground water temperatures are nearly constant throughout the year, stream reaches with relatively large amounts of ground water discharge can provide refuge to organisms from heat in summer and from cold in winter. For example, some stream reaches in the region remain unfrozen even though air temperatures are well below 32° Fahrenheit. Other possible benefits to the survival of aquatic organisms related to ground water discharge to streams include increasing concentrations of dissolved oxygen, adding small amounts of nutrients that are essential to the health of organisms, providing cold pockets of water in summer, and maintaining streamflow during dry periods.

#### **Lake Levels**

Lake Michigan was measured at 2 feet below the long-term average in 2001, having dropped more than 40 inches since 1997 when it was at near record highs. Levels increased for the 2002, but were still below average. The decrease in precipitation over the last five years and resulted in Lake Michigan being at its lowest point since 1966. Lake levels rose between the mid 1960s and the late 1990s.

The lower lake level has caused problems for the shipping and boating industry. Cargo ships were forced to lighten their loads, and many boat ramps became inaccessible. According to the U.S. Great Lakes Shipping Association, for every inch of water that Lake Michigan loses, a cargo ship must reduce its load by 90 to 115 metric tons, leading to losses of between \$22,000 and \$28,000 per trip.

Early reports for 2004 indicate that the lake is at about average due to increased rainfall early in the year. This fluctuation may be part of a 30 year cycle that deserves continued monitoring.

#### **Beaches**

Lake Michigan contains the world's largest collection of freshwater sand dunes and associated beaches, particularly along its eastern shore. Of a total of 3,100 coastal acres, 1,200 acres are publicly owned and available for use, while another 1,200 privately owned acres have significant potential for public use. In addition to swimming advisories due to water quality, there has been a resurgence of the macroalgae *Cladophora* along the coast. *Cladophora* blooms result in reduced water quality and beach use. Causes of the problem may be multiple factors, including lower lake levels, increased water temperature and near shore nutrients as well as zebra mussels activity that brings water clarity allowing sunlight to promote algae growth.

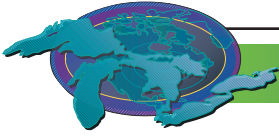
#### **Aquatic Food Web**

The Lake Michigan Aquatic Food Web is threatened due to invasive species competition for food and changing the physical environment as Zebra Mussels filter the water allowing sun light to penetrate to greater depths, possibly causing algae blooms. The invertebrate *Diporeia* is decreasing rapidly in Lake Michigan thus removing a foundation component of the food web. The yellow perch population remains low and zebra mussels, first introduced in 1989, have shown a decline in certain areas. Sea Lamprey populations have increased in abundance and are now higher than in Lakes Superior or Huron. Lake Trout are still not reproducing naturally and Lake Sturgeon were reintroduced in 2003 with hopes the stocked sturgeon will flourish but not genetically impact the small remnant native population.

The most dramatic threat is from the Asian carp species working their way up the Illinois waterway system from the Mississippi River where they were released from fish farms due to the 1993 flood. An experimental electrical barrier is in place with improvements and an additional barrier planned. These large carp species, up to 90 pounds, are considered a major threat to the Great Lakes food web.

#### **Other Species**

Other species are faring better as the grey wolf is now listed as recovered and bald eagles have nested in the area of the Little Calumet River for the first time in 100 years. Kirtland's warbler, piping plover, Hine's emerald dragonfly and the Karner blue butter-



fly all have recovery plans in place. An aggressive program to train Whooping Cranes to migrate and return to Wisconsin's Lake Michigan wetlands for nesting in the future is underway.

#### **Natural Areas**

Wetlands, which naturally help control runoff from urban areas by storing flood and surface water and slowly releasing and filtering it, have been destroyed in the Lake Michigan basin states to a greater degree than elsewhere in the country, an estimated 21.9 million acres or 62.9% on average. An estimated 12.9 million wetland acres remain in the four states, about 12.3% of the lower 48 states wetlands. Wetland status is therefore mixed.

Forest status in the basin is good due to revisions to national forest plans and the continued practice of sustainability forestry management by the Menominee Tribal Enterprises. The new forest plans address old growth management issues. The Menominee Reservation 235,000 acres of forest land represent 150 years of sustainable forest practice in the Wisconsin portion of the Lake Michigan basin.

Lakeplain system of prairies and savannas found in the southern part of the basin are two of the most imperiled ecological communities in North America. Alvars, open areas of thin soils over bedrock found in the northern basin, provide habitat for a number of rare plants and animals. Both of these systems are facing fragmentation and destruction due to land use development.

#### **Pressure on the System**

Areas of Concern. The 10 Areas of Concern all have contaminated sediment problems and either combined sewer overflows (CSO) and/or storm water problems. All ten have had some remedial sediment work with much more remaining to be done. For most of the sediment sites and CSOs there are plans in place but implementation is often out to 2020. PCBs are the main sediment contaminant and fish advisories are in place around the lake thus keeping the status as mixed.

Land Use. The urbanized land area in the United States has quadrupled since 1954. To compound the problem, populations in coastal areas, which contain some of the most sensitive ecosystems, have been increasing even faster than in the rest of the country. From 1982 to 1996, the population in the Chicago-Northwest Indiana area grew by 10.9 percent but consumed 44.2 percent of the land. (Urban Roadway Congestion: Annual Report 1998) The Northeastern Illinois Planning Commission's portion of the area is estimated to grow by 21% from 2000 to 2030. This growth pattern is similar to other growth areas around the lake and will tax water infrastructure and resources.

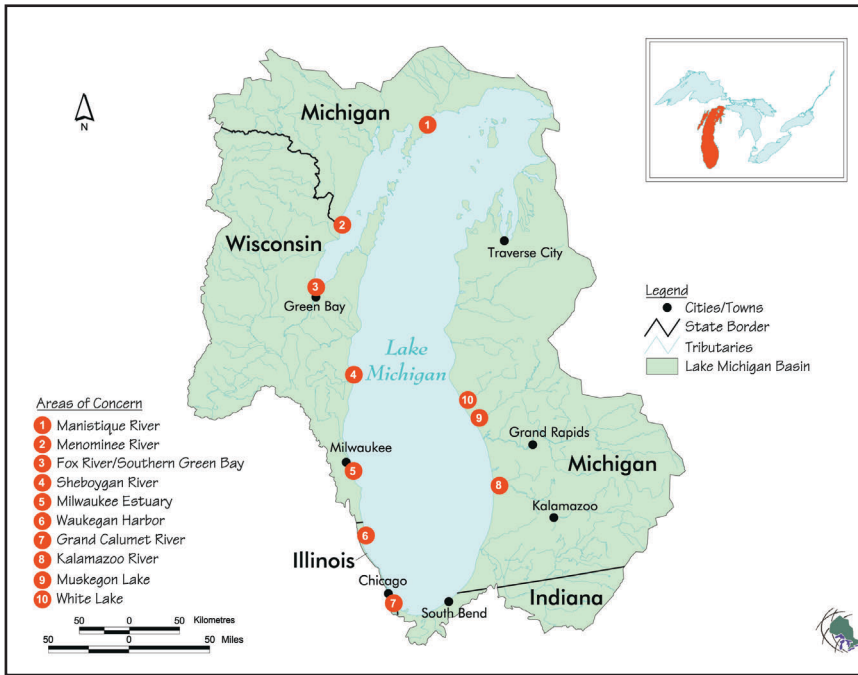
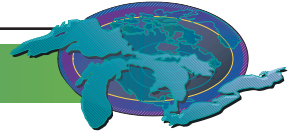
EPA's Office of Environmental Information states "the construction of impervious surfaces such as roads and rooftops leads to the degradation of water quality by increasing runoff volume, altering regular stream flow and watershed hydrology, reducing groundwater recharge, and increasing stream sedimentation and water acidity." A 1-acre parking lot produces a runoff volume 16 times as large as that produced by an undeveloped meadow. Many impervious construction materials have higher surface temperatures that may cause ambient air temperatures to rise. When combined with a decrease in natural vegetation, areas are subject to what is called the urban heat island phenomenon, which may increase utility bills, cause health problems associated with heat stress, and accelerate formation of harmful smog. Clearly the effect of urban development on our communities and environment is a cross-cutting issue.

The Lake Michigan Mass Balance Study has modeled the pesticide Atrazine in the basin and determined a 57% annual reduction in loadings is necessary to keep steady state in the lake. While nutrient levels are up in the nearshore areas, they are not at levels of concern in the open lake.

Invasives, groundwater usage and lake levels are mentioned above.

#### **Management Actions**

There are overall research needs for groundwater, *Cladophora* and *E. Coli*. The Lake Michigan Watershed Academy has identified a need for training on models and GIS work at the local level where the authority and land use decision making is housed.



Lake Michigan Drainage basin.

Lake	Overlake Precipitation (percent)	Surface-Runoff (percent)	Indirect groundwater discharge (percent)
Superior	56.3	11.0	32.7
Michigan	56.2	9.3	34.5
Huron	42.2	16.3	41.5
Erie	53.5	24.3	22.2
Ontario	34.8	22.8	42.4

Table 1. Basin water supply for the Great Lakes.

(USGS, 1998. Water Supply Paper 98-52, D.J. Holtschlag and J.R. Nicholas)

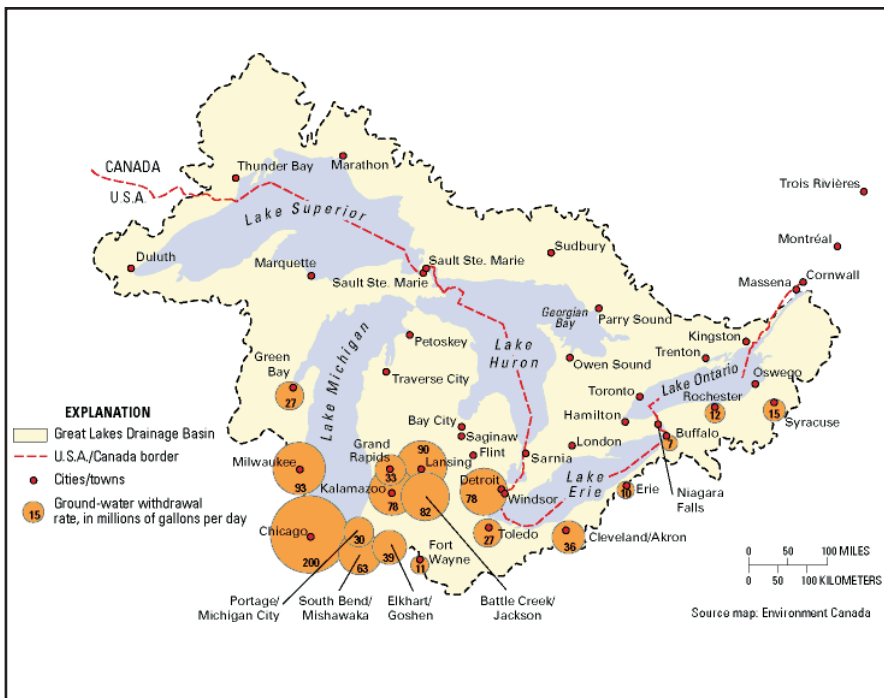


Figure 1. Groundwater withdrawal map.

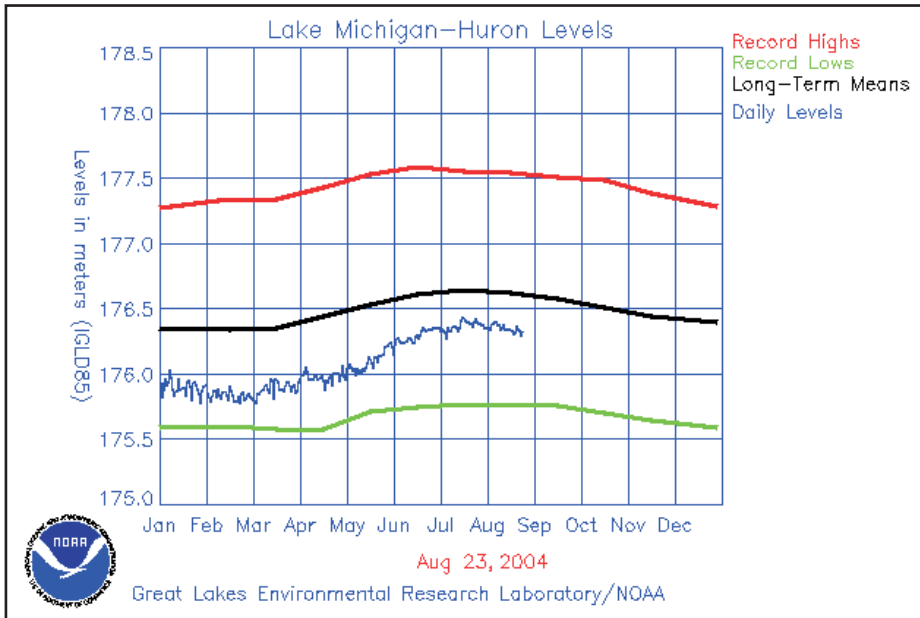
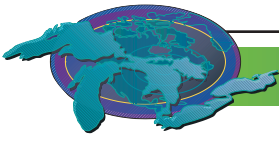


Figure 2. Lake Michigan-Huron water levels.  
Source: Great Lakes Environmental Research Laboratory/NOAA

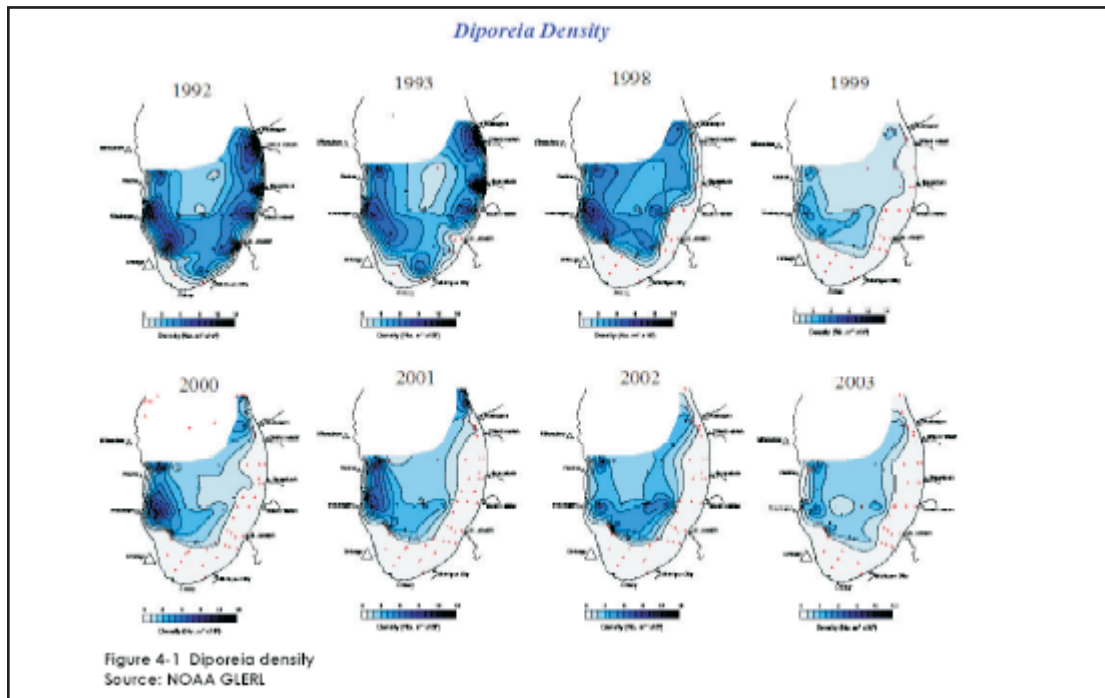


Figure 3. Diporeia density.  
Source: Great Lakes Environmental Research Laboratory/NOAA

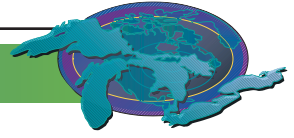


Figure 4.

The Lake Michigan Food Web. Diporeia, central in the diagram (p), was historically an important food for the fish on the second line in the red squares. They are the prey for the large predator fish like Salmon and Lake Trout at the top of the chart and food web in the purple squares. Non-native species are competing with, and possibly replacing the Diporeia in the Lake Michigan ecosystem. The loss of Diporeia threatens the species that feed upon it and the whole food web

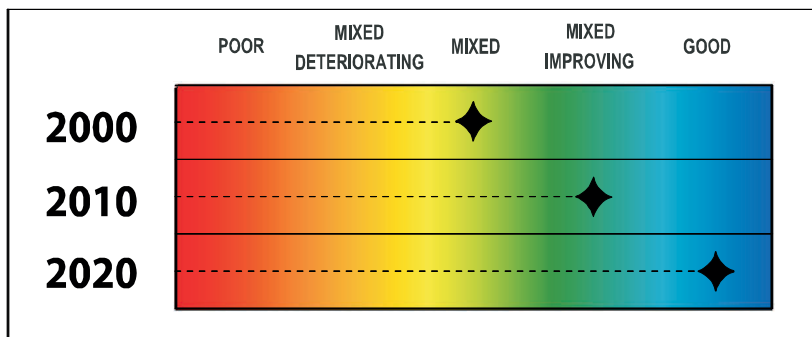
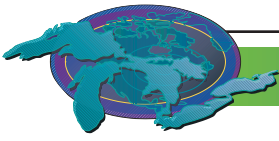


Figure 4. Projected restoration dates for Lake Michigan.





## Lake Huron

### **Assessment: *The state of the Lake Huron ecosystem is mixed.***

While contaminant levels are low compared to the other Great Lakes and much of the main basin, Saginaw Bay, Georgian Bay, and the North Channel still support extensive high quality coastal habitat, there are still issues regarding fish consumption restrictions, ecosystem change and the effects of non-native species as well as loss of fish and wildlife habitat. Shoreline development pressure, bacteria and nutrient problems, botulism outbreaks and concerns over water levels persist. Two AOCs have been delisted, one has completed all actions and the clean up of Saginaw Bay continues.

### **Summary of the State of the Huron**

The diverse shoreline of Lake Huron is the longest of the Great Lakes, its length extended by the shores of its numerous islands. Rocky shores associated with the Precambrian shield cover the northern and eastern shores, limestone dominates the shores of Manitoulin Island and the northern shore of the Bruce Peninsula, and glacial deposits of sand, gravel, and till predominate in the western, southern, and southeastern portions of the shore. Shoreline and inshore habitats are correspondingly diverse.

Lake Huron basin is heavily forested in the northern portion and then becomes increasingly agricultural in the south with its urbanized areas in Saginaw Bay and along the southernmost portion of the lake. Much of southern part of the Huron basin is devoted to intensive cultivated field crops and, beef and dairy farms, particularly in the "thumb" area of Michigan, along the Bruce Peninsula, and the southeast shore of the main basin. Mining of limestone, nickel, uranium, copper, platinum and gold has been an important activity in the northern portion of the Lake Huron basin.

The Lake Huron watershed is home to about 2.5 million people. Both sides of Lake Huron have relatively low human population densities. As a result Lake Huron retains much of its historic fish and wildlife habitat. Saginaw Bay, Georgian Bay, and the North Channel still support some of the most extensive high quality coastal habitat in the Great Lakes.

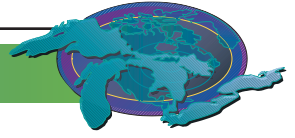
Lake Huron is the third largest freshwater lake in the world in terms of area, and the sixth largest in volume and boasts the largest island (Manitoulin) of any freshwater lake on Earth. The retention time for water in Lake Huron is 22 years, and the average depth is 59 metres (195 feet). This long retention time and large surface area have resulted in the build up of persistent substances that bioaccumulate in fish and wildlife.

Four Areas of Concern (AOCs) were identified in the Lake Huron basin. Within the basin two AOCs, Saginaw Bay, Michigan, and Spanish Harbour, Ontario remain. The causes of impairment within the AOCs are being addressed, and habitat, fish and wildlife populations, and environmental quality are recovering. Canada and Ontario have recognized Spanish Harbour as an "Area in Recovery" where all remedial actions have been implemented and the environment will take some time to respond and the goals to be achieved. Severn Sound, Ontario was delisted as an AOC in 2003 and the Collingwood Harbour AOC, also in Ontario, was delisted in 1994.

From the late 1970's to the early 1990's, concentrations of persistent, bioaccumulative substances such as PCB, DDT, dieldrin, dioxins, and furans declined significantly in Lake Huron lake trout. However, while concentrations of DDT continued to decline up until 1995, PCB concentrations have not declined significantly since the mid 1980s. As with other trends, concentrations decreased significantly in the late 1970s but have remained relatively stable since.

In the early 1970s, fish-eating birds (eagles, gulls, cormorants, etc.) on Lake Huron suffered widespread contaminant-induced reproductive failure, declining populations and eggshell thinning. With reductions in loadings of persistent toxic contaminants, such as PCBs, most fish-eating bird populations have recovered; numbers of herring gulls, Caspian terns, black-crowned night-herons and double-crested cormorants have increased significantly. However, some contaminant-associated problems, e.g. birth defects, impaired physiological responses and/ or reproductive failure, continue to occur in a small percentage of the populations in local areas.

The lake ecosystem has undergone many changes. Among the most significant change to the fish community have been the invasion of rainbow smelt (*Osmerus mordax*) in the 1920's, and alewife (*Alosa pseudoharengus*) and sea lamprey (*Petromyzon marinus*) in the 1930s. Sea lamprey predation and overfishing led to the collapse of lake trout (*Salvelinus namaycush*) by the 1950's (although



two remnant stocks barely survived). With no predators to control alewife and smelt populations their numbers exploded and nuisance die-offs of alewife commonly littered beaches during the 1960s. The turnaround came with sea lamprey control in the 1960s which allowed the survival of stocked Pacific salmon (*Oncorhynchus spp.*), lake trout and other predators. Restocking controlled both smelt and alewife populations, prevented nuisance alewife die-offs and resulted in exceptionally good fishing.

The original Lake Huron ecosystem had lake trout as the main predator together with burbot (*Lota lota*) in the deeper waters, and walleye (*Sander vitreus*) the main nearshore area predator. The historic prey base was dominated by lake herring (or cisco) (*Coregonus artedii*) and a number of other species of deepwater ciscos (*Coregonus spp.*), with sculpins (*Cottus spp.* and *Myoxocephalus quadricornis*), lake trout (*Coregonus clupeaformis*) and round whitefish (*Prosopium cylindraceum*) contributing to a lesser extent. The historic Lake Huron off-shore ecosystem had fewer predators and many more prey fish species. The current ecosystem has many more predators and both predators and prey are dominated by introduced species. Many of the original deepwater cisco species in Lake Huron are extirpated.

Today chinook salmon (*Oncorhynchus tshawytscha*) are the dominant consumer in the lake, feeding mainly on non-native forage (alewife are their main prey with smelt being second) and lake trout are still a significant factor due to continued stocking. The abundance of both alewife and smelt can fluctuate significantly between years which can influence growth rates and survival of predators. Six sites of natural reproduction of lake trout have been documented on Lake Huron and one has been deemed rehabilitated. Despite this level of success much work is needed to rehabilitate lake trout to even a small portion of their former abundance across the lake.

The current lake ecosystem may not be as productive as in the past since non-native prey species are not as efficient in utilizing the primary and secondary production of the lake as were historic species, such as the diversity of ciscos that once inhabited the lake. The introduction of non-native species such as zebra (*Dreissena polymorpha*) and quagga mussels (*Dreissena bugensis*) and the spiny water flea (*Bythotrephes cederstroemi*) may also divert much of the primary and secondary production of the lake to different pathways, making it unavailable to top predators.

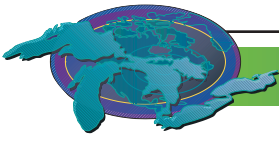
### Pressures on the System

Continuing sources of contaminants are primarily from sediments contaminated by historic discharges, airborne deposition, industrial and municipal discharges and land runoff. Contaminants enter Lake Huron through a variety of pathways including direct discharges, atmospheric deposition, and tributary discharge. Pesticides such as DDT, Toxaphene, Mirex, Chlordane and Aldrin/Dieldrin have been banned from use in the U.S. and Canada; however, they are still cycling within the environment through run-off, sediment resuspension and long range atmospheric transport. Lake Huron has relatively few local contaminant point sources but has a large surface area which makes it vulnerable to atmospheric deposition of contaminants. Pollutant loadings to Lake Huron from water sources are lowest of all the Great Lakes but air sources are highest.

Wildlife information has indicated that PCBs, chlordane, dioxins and DDT are a concern in the Lake Huron basin although, with the exception of Saginaw Bay (PCBs, dioxin), concentrations are low compared to the other Great Lakes. Concentrations have declined significantly since the early 1970s but still remain at levels associated with deformities and reproductive effects in several local watersheds in Michigan, especially Saginaw Bay. Data collected in Ontario's wildlife species were generally not at levels of concern although sporadic elevated measurements support the need for continued ongoing monitoring.

Lake Huron has been dramatically and forever changed by the invasion of non-native species, which have decimated native fish populations and in some cases permanently impacted fish communities. Invasive species are defined as species that do not originate in the Lake Huron ecosystem and have been introduced either intentionally or accidentally. Invasive species threaten the diversity and abundance of native species and the ecological stability of infested waters. The introduction of invasive species into Lake Huron has altered or disrupted existing relationships and ecological processes. This disruption can cause significant changes to the Lake Huron ecosystem such as alterations of food webs, nutrient dynamics, reproduction, sustainability, and biodiversity. Invasive species have few natural enemies such as pathogens, parasites and predators. Without co-evolved parasites and predators, they out-compete and even displace native populations. Not only do invasive species compete with native species for food and habitat, they may also increase cycling of persistent bioaccumulative chemicals in the food chain. For example, research has shown that zebra mussels and round gobies are contributing to the cycling and bioaccumulation of PCBs.

Many fishes need to migrate between different habitats throughout their life histories. In the past, Lake Huron was connected to



diverse array of stream and inland lake habitats. Historically, tributaries were important sources of cool, high quality water, and they served as spawning and nursery habitats for many species. Fish were excluded from many of these areas in the 1800's through construction of mill dams and later through hydroelectric facilities. Dams now fragment many streams where historical spawning occurred for adfluvial fish (live in the open waters of the Great Lakes and use tributaries for spawning). Many important fisheries and spawning rapids are no longer accessible.

In recent years, outbreaks of Type E Botulism have left thousands of fish and waterbirds dead on Lake Huron (Ontario) area beaches. In 1998 and 1999, the outbreak appeared to be concentrated at the south end of the lake between Goderich and Sarnia. In 2002 and 2003, outbreaks occurred each year in the Goderich to Port Elgin area. The occurrences began in late summer and continued through the fall season until late November. There were also observations of decomposing algae collecting in embayments in the Kincardine area in the late summer. These events on Lake Huron are being studied along with similar events on Lakes Erie and Ontario to determine what conditions lead to these events.

The watershed of Lake Huron along its south-east shore (Sauble Beach to Sarnia) is a draw for thousands of tourists and cottagers annually as it boasts some of the finest freshwater beaches in the world. High levels of nutrients and bacteria (*E. coli*) along the beaches and in the tributaries have led to numerous postings of beaches warning of unsafe conditions for swimming. These conditions have existed for many years yet have received heightened attention due to recent media coverage. Complaints from residents about algae have been less consistent, and are sporadic geographically and over time with some years much worse than others. The relative contributions of sources of nutrients and bacteria have not been specifically quantified, however agricultural practices, municipal wastewater, septic systems and wildlife sources are all contributors.

#### **Future and Emerging Management Issues**

In comparison to the other Great Lakes, contaminant concentrations are relatively low in Lake Huron. Nevertheless, fish consumption advisories exist for the open lake and all Areas of Concern (St. Marys River, Saginaw Bay and the Spanish River).

The recent invasion of zebra and quagga mussels, round gobies, the spiny water flea, white perch (*Morone Americana*) and ruffe (*Gymnocephalus cemuus*) into Lake Huron heightens the uncertainty for expectations from the ecosystem. Recently *Diporeia hoyi* (scud), a native invertebrate has declined significantly in abundance, especially in southern Lake Huron. There is a suspicion that the *Diporeia* decline may be related to the invasion of zebra mussels. *Diporeia* is a key diet item of lake whitefish and other desirable sport and commercial fish species.

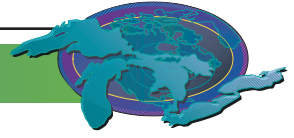
Though residential land use makes up a small percentage of total land use, much rural development has occurred along the shoreline. In the past 20 years there has been increasing development pressure for cottages and year-round retirement properties. Undoubtedly, the next 20 years will bring more as urban populations grow and the retired population increases.

Recent advances in chemical detection techniques have revealed the presence of low concentrations of chemical contaminants that were previously not known to be present. Studies in other aquatic systems have detected a wide range of chemicals including personal care products (soaps and perfumes), human and veterinary drugs (antibiotics), natural and synthetic hormones, plasticizers, insecticides, fire retardants, and caffeine from coffee drinkers. Concentrations of these chemicals almost never exceed standards set for drinking water, but there are no standards for many substances because it was not known that they were even present. The primary concern with low-level contaminants is that they may serve as endocrine disrupters that affect growth, maturation, and reproduction of aquatic organisms. The problem is so new that many basic questions are as yet unanswered.

Looking toward the future, the year 2007 has been tentatively identified for the comprehensive monitoring and analysis of the health of Lake Huron. This year appears to work well for existing monitoring schedules, although much more work will be necessary to coordinate monitoring on this geographic scale.

#### **Acknowledgments/Sources of Information:**

This report consists of excerpts from the 2004 *Lake Huron Binational Partnership Action Plan*. Please see this document for a fuller discussion of the topics discussed above.



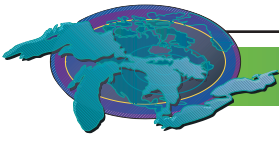
**Contacts**

James Schardt  
 U.S. Environmental Protection Agency  
 Great Lakes National Program Office  
 (312) 353-5085  
[schardt.james@epa.gov](mailto:schardt.james@epa.gov)

Janette Anderson  
 Environment Canada  
 Ontario Region  
 (905) 336-6277  
[janette.anderson@ec.gc.ca](mailto:janette.anderson@ec.gc.ca)



Lake Huron Drainage Basin.



## St. Clair – Detroit River Ecosystem – “The Corridor”

### Assessment: Mixed

*The status of the St. Clair – Detroit River ecosystem is mixed.* Stressors to natural ecosystem persist, including the impacts of land use, shoreline alteration, nutrients and chemical contamination, and exotic invasive species on habitat quality. Contaminant levels in water and sediment continue to decrease, and habitat protection activities have increased.

### Summary of the Status of the St. Clair – Detroit River Ecosystem

The St. Clair River, Lake St. Clair and Detroit River together serve as a corridor connecting Lake Huron and Lake Erie and serve as a major shipping channel linking the Upper and Lower Great Lakes. As a result of this shipping link, the region has developed into one of the most highly industrialized and environmentally altered areas in the Great Lakes basin. The cities of Port Huron and Detroit, Michigan and Sarnia and Windsor, Ontario are significant petrochemical and manufacturing centres within North America.

Beginning at Lake Huron, the St Clair River flows approximately 64 km (40 mi) dropping 1.5 m (5 ft) through a predominately straight channel in a southerly direction before entering Lake St. Clair. Flowing through mostly urbanized areas, its banks are hardened with structures such as riprap and retaining walls with a few narrow beaches and vegetated bluffs.

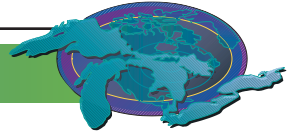
The rapid deceleration of the flow from the St. Clair River as it enters the wide shallow Lake St. Clair allowed suspended sediment loads held in the river to settle out and over millennium has formed the St. Clair Delta, one of the largest freshwater deltas in the world. The delta has a complex shoreline with many channels and shallow bays, providing some of the most significant fish and wildlife habitat in the Great Lakes. The opening of the Channel Cutoff in 1962, to improve commercial shipping, forever decreased the flow in the North Channel and the proportion of river water entering the lake through Anchor Bay. This has forever altered the hydrology and habitat availability of Anchor Bay.

Lake St. Clair has an area of 1,115 km<sup>2</sup> (430 mi<sup>2</sup>) with a shoreline length of 272 km (169 mi) plus the delta shoreline. Its average depth is only 3.7 m (12 ft) with a maximum natural depth of 6.4 m (21 ft). A commercial navigation channel, running through the lake from the St. Clair River to the Detroit River, is 18 m (59 ft) wide and 8.3 m (27.2 ft) deep, making it the deepest point in the Lake. The retention time for water in the Lake ranges from four days for water from the Middle Channel to 30 days for water from the Thames River. Due to the shallow nature of the lake, it never thermally stratifies and oxygen levels throughout the water column are close to saturation. These characteristics provide the structure necessary to support large beds of emergent and submergent aquatic vegetation, diverse habitats, and significant fish and wildlife populations. They also make the lake vulnerable to non-native invasive species; annual and seasonal changes in water levels; weather; wake disturbance; and contaminants.

Lake St. Clair is effectively divided into two separate water masses (northwestern and southeastern). Water quality measurements indicate that these water masses rarely mix. The southeastern water mass is eutrophic and supports a diversity of nearshore and wetland habitats. The northwestern water mass is oligotrophic, and supports generally cooler, clearer water with less submergent vegetation.

Lake St. Clair has been affected by many invasive species that alter the lake's physical integrity and its overall ecology. For example, zebra mussels (*Dreissena polymorpha*) first invaded the lake in 1988. Prior to their colonization (1976 – 1988) water transparency in the lake ranged from 0.9 – 1.9 m in Ontario waters. Post colonization (1989 -1993) water transparency ranged from 1.2 – 4.0 m. Their introduction has resulted in dramatic ecological changes to the lake including: decreased preferred habitat for walleye, a collapse of the native mussel population in the open lake, increased submergent aquatic vegetation, and an overall decrease in lake productivity.

Lake St. Clair drains into the Detroit River, running approximately 51 km (32 mi) and falling 0.9 m (3 ft) before discharging into Lake Erie. The river varies in depth from 1 m to 15 m (3 ft – 50 ft). There are twelve islands in the river. The river can be divided into two reaches, upper and lower, with different hydraulic characteristics. The upper reach can be generalized as a narrow, deep channel with a steep shoreline that extends from Lake St. Clair to Fighting Island (approximately 21 km or 13 mi) with a fall of only 0.3 m (1 ft). The lower reach by contrast is a wide, shallow channel with numerous (ten) islands. The river falls 0.5 m (1.5 ft) between Fighting Island and Bois Blanc Island, leaving a fall of less than 0.2 m (0.5 ft) for the remainder of the river. Extensive rock excavation and dredging was required to create the 5 navigational channels through the lower reach, forever altering the bottom



structure.

Flowing through the cities of Detroit, Michigan and Windsor, Ontario the Detroit River shorelines are densely industrialized and highly urbanized. This development altered significant amounts of shoreline, caused dredging, and caused watershed alterations that have resulted in very little natural habitat remaining in the Detroit River or its watershed.

Tributaries and sewers drain approximately 2097 km<sup>2</sup> (807 mi<sup>2</sup>) directly into the Detroit River. These inputs drain large industrial and urban areas and often contain elevated levels of sediment, nutrients, bacteria, metals, and chemicals. Large impermeable surfaces in the watershed often mean increased risks of local flooding; which further alters the natural watershed hydrology and contributes even more contaminants to the Detroit River.

These contaminants can bioaccumulate through the food chain impacting the health of fish and wildlife communities, resulting in consumption restrictions. Within the St. Clair Detroit River ecosystem monitoring by government agencies shows concentrations of mercury, PCBs, and several pesticides in water and sediment are declining, while phosphorus and bacterial levels show no declines. Large areas of elevated contaminant concentrations can be found in the St. Clair River, Rouge River, and the Trenton Channel, Detroit River. In some locations monitoring is showing contaminant concentrations exceeding Probable Effect Limits in recently deposited sediment, indicating that contaminated discharges are still occurring.

#### **Pressures on the System**

Environmental improvements within the St. Clair – Detroit River ecosystem are slowly occurring. However, exotic invasive species, contaminants, hardened shorelines, loss of habitat and land use alterations continue to challenge the physical integrity of the system. The physical integrity of the St. Clair – Detroit River ecosystem means that change often occurs rapidly and more often than not permanently.

There is an ongoing threat from new exotic invasive species. Established invasive exotic species have irreversibly altered the ecology of the St. Clair – Detroit River ecosystem resulting in changes at all levels of the ecosystem.

Climate change resulting in changes to air temperatures, water levels, significant weather events, and ice cover duration and thickness may have extensive and dramatic effects to this shallow, productive and fast flowing St. Clair – Detroit River system. This is of particular concern for littoral zones on the eastern and northern Lake St. Clair shorelines that are influenced by prevailing southwest winds. If water levels were to drop below a certain threshold, wave energy can be dissipated at an offshore bar and this, in turn, may cause significant changes to the water transparency and sediment re-suspension in the littoral zone. Models predict significant shoreline and lake bed exposure, loss of critical open water and wetland habitats, increased requirements for dredging of marinas and the navigational channel, etc.

Historical and current discharges from industrial, urban, rural and agricultural land use affect the health and vitality of fish and wildlife populations and result in consumption restrictions, drinking water closures and beach closures.

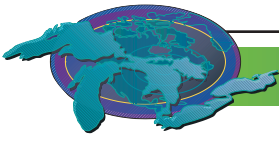
Dredging and shoreline hardening to facilitate shipping or recreational boating and to protect against flooding including dyking associated with residential areas, cottages, marinas, and agriculture has significantly altered the hydrology of the St. Clair – Detroit River system. The altered hydrology changes the movement of sediments within the system, and can irreversibly change the location, extent, and diversity of habitats.

#### **Future and Emerging Management Issues:**

The implementation of activities to eliminate chemical inputs, manage sediment and nutrient inputs, reduce the effects of exotic invasive species, prevent the introduction of new exotic species, and manage for a more natural hydrology will improve the quality and quantity of habitats in the St. Clair – Detroit River system.

#### **Acknowledgements/Sources of Information**

Canadian Lake St. Clair Watershed Coordination Council. In press. The Lake St. Clair Canadian Watershed Technical Report: An examination of current conditions.



Michigan Department of Natural Resources and Ontario Ministry of the Environment. 1991. Stage 1 Remedial Action Plan for the Detroit River Area of Concern.

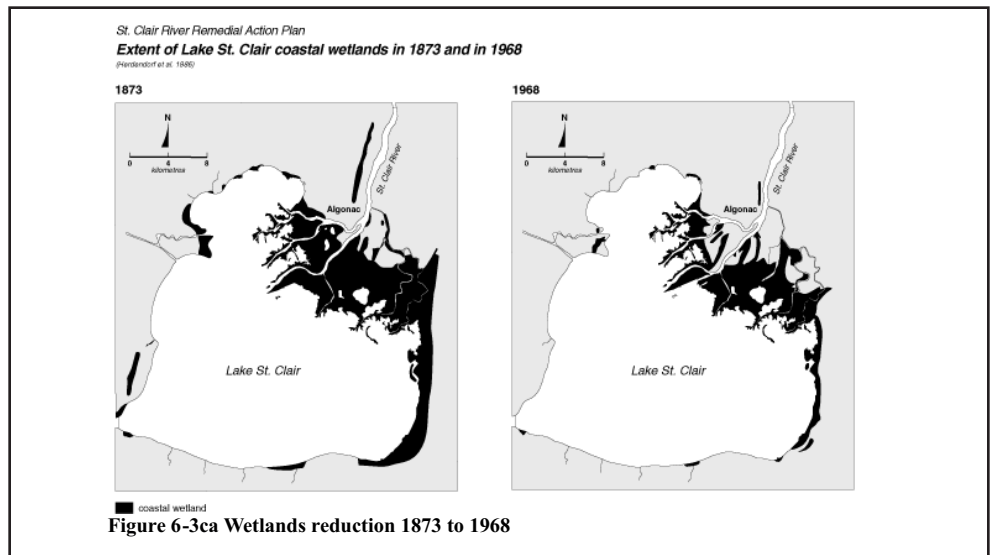
North-South Environmental Inc. In press. 2003 St. Clair River RAP Progress Report. Volume 1 – Synthesis Report.

U.S. Army Corps of Engineers. In press. St. Clair River – Lake St. Clair Binational Comprehensive Management Plan.

St. Clair River-Lake St. Clair-Detroit River Ecosystem.



Figure 1.



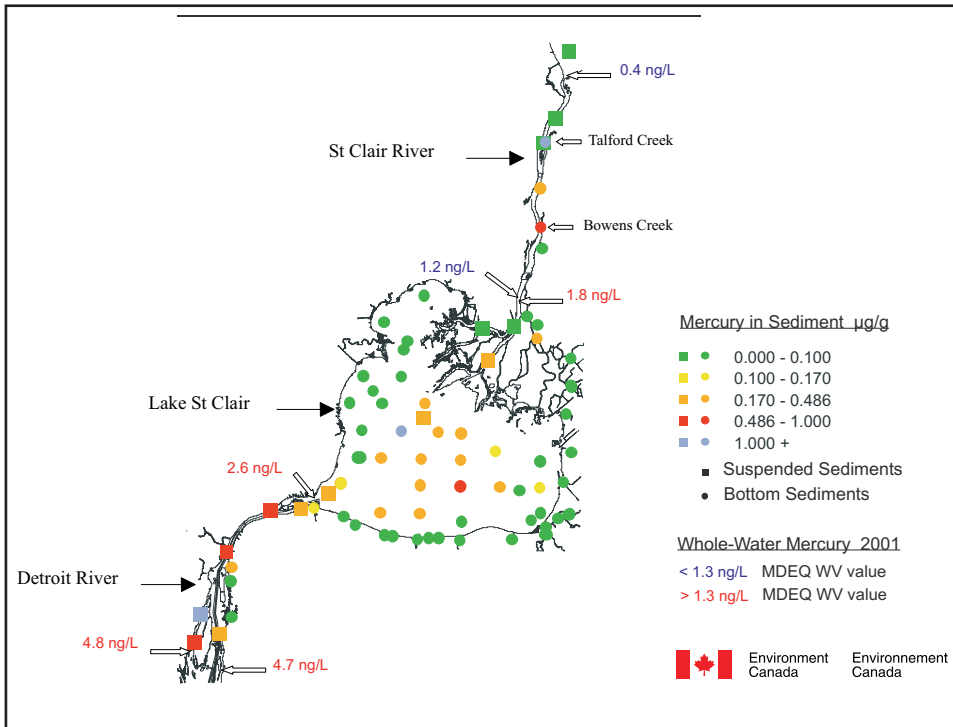
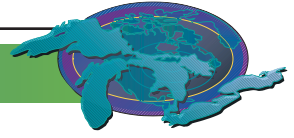


Figure 2. Mercury in the St. Clair - Detroit River ecosystem.

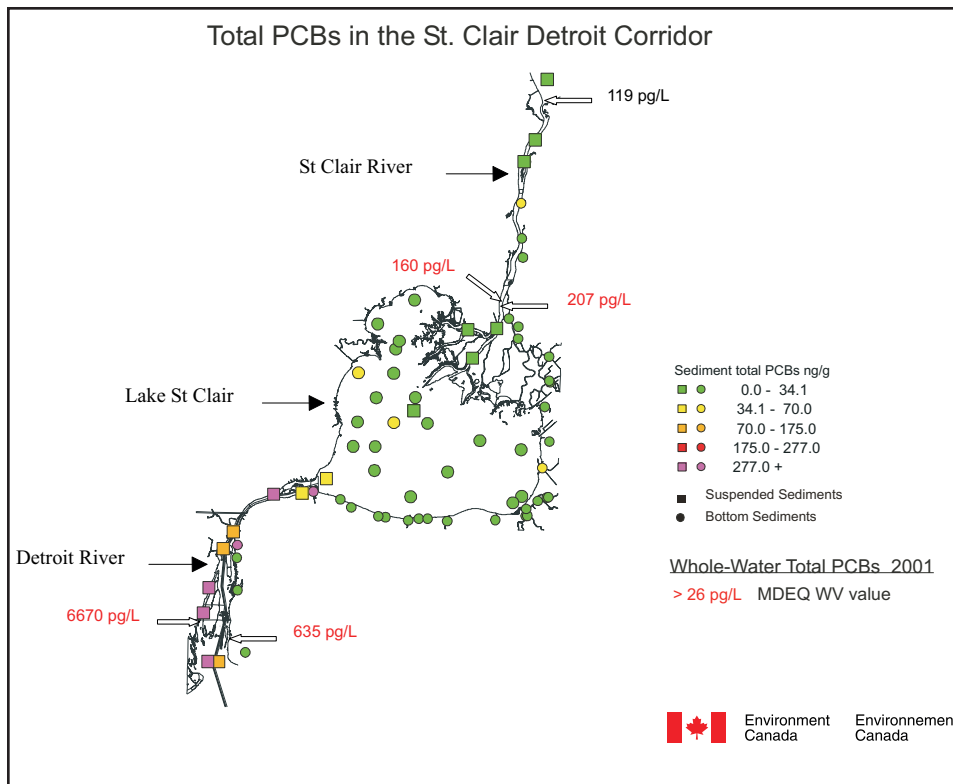
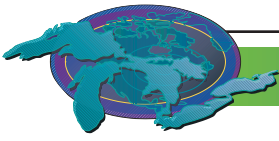


Figure 3.





## Lake Erie

### Assessment: Mixed

*The status of the Lake Erie ecosystem is mixed.* Stressors to natural ecosystem persist, including impacts of changing land use, shoreline alteration, nutrient loading and chemical contamination, and exotic invasive species on habitat quality and food web dynamics. Contaminant levels in water and sediment continue to decrease, and habitat protection activities have increased.

### Summary of the Status of the Lake Erie Ecosystem

The physical integrity of Lake Erie has a direct bearing on how the lake ecosystem reacts to various stressors. Approximately 80 percent of Lake Erie's total inflow of water comes through the Detroit River, 11 percent from precipitation, with the remaining 9 percent from tributaries flowing through watersheds in Michigan, Ohio, Pennsylvania, New York and Ontario (Bolsenga and Herdendorf, 1993). The Niagara River is the main outflow from the lake. Lake Erie by volume is the smallest of the Great Lakes, and next to smallest in surface area. As the shallowest of the Great Lakes, it warms quickly in the spring and summer and cools quickly in the fall, making it the most biologically productive of the Great Lakes.

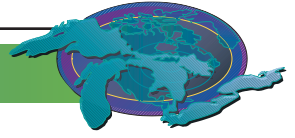
About one-third of the total population of the Great Lakes basin resides within the Lake Erie watershed. This amounts to 11.6 million people (10 million U.S. and 1.6 million Canadian), including seventeen metropolitan areas, each with more than 50,000 residents. Many of these metropolitan areas use Lake Erie as a source for drinking water. Continued development and urbanization has led to increased demand for drinking water and requests for diversions of Lake Erie water outside of the basin. The cumulative effects of these diversions are unknown but unless carefully managed, could have significant long-term impacts on surface and groundwater hydrology and ecosystem function.

Lake Erie is naturally divided into three basins (Figure 1). The western basin is very shallow with an average depth of 7.4 meters (24 ft.) and a maximum depth of 19 meters (62 ft.). The central basin is uniform in depth, with the average depth being 18.3 meters (60 ft.) and a maximum depth of 25 meters (82 ft.). The eastern basin is the deepest of the three with an average depth of 25 meters (82 ft.) and a maximum depth of 64 meters (210 ft.). Each spring, Lake Erie waters thermally stratify isolating oxygen-rich surface waters from cooler, deeper bottom waters. However, western basin waters rarely stratify due to shallow water depths and associated mixing due to storms. Stratification impacts the internal dynamics of the lake, physically, biologically, and chemically.

Even though phosphorus loadings into the central basin have been reduced and are well within target limits, there has been an expansion of an anoxic zone (the "Lake Erie dead zone") within the central basin within the past several years. The contributory effects of zebra/quagga mussel nutrient recycling toward the development of anoxic bottom waters are unknown. However, recent studies (Lam et al. 1987, 2002; Charlton and Milne 2004) have shown that oxygen depletion in Lake Erie Central Basin hypolimnion was affected more by thermal layer thicknesses than by nutrient loads or exotic species invasion. When a thin hypolimnion develops (e.g. under prolonged solar heating, insufficient wind mixing, and lower lake levels), hypolimnion volume is reduced and a strong thermal stratification usually occurs and prevents oxygen from upper layers to replenish the oxygen depleted in the hypolimnion. Anoxic bottom waters adversely affect benthic communities, food web dynamics, and anaerobic processes may increase pollutant availability.

Urbanization and intensive agricultural development, particularly in southwest Ontario and northwest Ohio, have contributed to high sediment loads to the lake. Suspended sediment is a pollutant in itself and also carries many persistent toxic chemicals as well. Suspended sediments have profoundly influenced the ecology of the western basin and the river mouths of most of the Lake Erie tributaries. Most of the lake bottom is covered with fine sediments that are re-suspended when the shallow lake is disturbed by winds. The western basin is generally the most turbid region of the lake, and much of its sediment load eventually moves into the central and eastern basins. Even though sediment loads are still high, implementation of non-point programs and the application of best management practices (BMPs) on agricultural lands have reduced suspended sediment daily loads into the lake by more than 50% over the past 20 years in some areas of the basin (e.g. Richards et al. 1998). Continued reductions in sediment loads will improve the quality and clarity of Lake Erie waters, improve tributary and coastal habitats, and reduce the amount and frequency of material dredged to maintain navigation channels.

Contaminant loadings and accumulation of persistent toxic chemicals in water, sediment, fish and wildlife continue to decline. The development of extensive pollution control regulations, improvements in treatment technologies, adoption of stringent water quality standards, bans on production and use of certain chemicals, and pollution prevention has greatly reduced the direct discharge of con-



taminants into Lake Erie. However, Lake Erie still receives the largest amount of effluent from sewage treatment plants (Dolan, 1993) and combined sewer overflows (CSOs) continue to be problematic in many metropolitan areas. Considerable progress has been made reducing the use of mercury and PCB containing products in the basin, with Canadian and U.S. mercury emissions decreasing approximately 83 and 40 percent, respectively since 1990. However, atmospheric deposition of contaminants (mercury) from outside the basin and non-point pollution (nutrients and pesticides) remains problematic. Contaminated sediments containing mercury, PCB's, trace metals, and pesticides are still present in many of our waterways and can bioaccumulate through the food chain impacting the health of fish and wildlife communities, resulting in consumption advisories. There are ten Areas of Concern (AOCs) closely associated with Lake Erie: the Detroit River (Binational); the Raisin River (Michigan); the Maumee, Black, Cuyahoga and Ashtabula Rivers (Ohio); Presque Isle (Pennsylvania); Buffalo River (New York); Wheatley Harbour (Ontario); and the Niagara River (Binational). RAP teams have or are currently developing strategies to deal with site-specific contaminated sediment issues at most of these AOCs, but progress is slow. Only one of these sites, the Presque Isle Pennsylvania AOC has recently been designated as an "Area in Recovery".

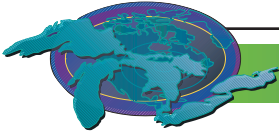
Habitat loss and degradation in the Lake Erie basin over the last 200 years has been extensive (Hartman 1973; Bolsenga and Herdendorf 1993; Halyk and Davies 1998). The most pronounced impacts have been to tributaries, coastal wetlands, and nearshore habitats that are crucial fish spawning, nursery, and food production areas. These coastal systems are comprised of diverse habitats that are interconnected and dependent upon the physical integrity of natural coastal processes to maintain them. Impacts have been most pronounced along the southern and western shore of Lake Erie, where dredging, shoreline armoring, infilling and diking of wetlands, and other shoreline modifications have eliminated land-margin connections, altered substrate and water-mass characteristics, and affected natural coastal processes. For example, the shorelines of river mouths and estuaries of Lake Erie are densely industrialized and highly urbanized eliminating or degrading critical spawning and nursery habitat for a wide variety of fish species. Loss of historic wetlands in the Lake Erie basin is estimated to be approximately 80%, which has affected Lake Erie hydrology and directly impacted wildlife and waterfowl habitat in the basin (Snell 1987; Maynard and Wilcox 1996). Fortunately, the rate of habitat loss and degradation has slowed dramatically within the past decade with the implementation of more comprehensive habitat protection programs and policies, but incremental losses still occur in both Canada and the U.S.

Erosion control and navigation structures such as breakwaters, jetties, and piers interrupt nearshore sediment transport processes and energy dynamics, change water depths, and alter nearshore circulation patterns and substrates. In 1993, approximately 50 % of the Lake Erie shoreline was protected by some type of man-made structure (Figure 2a – IJC 1993). In Ohio, recent work by the Ohio Geological Survey has shown that the percentage of protected shoreline more than doubled between 1970 and 2000 in response to increased shoreline development and erosion caused by near-record high Lake Erie water levels (Figure 2b). In Ohio, which has one of the most extensively developed shorelines in the Great Lakes, the percentage of protected shoreline in 2000 ranged from 62% in Ashtabula County to 98% in Lucas County. Given continuing development pressures on the Lake Erie shoreline, it is likely the percentage of protected shoreline will continue to increase over the next several decades, albeit at a somewhat lower rate as Lake Erie water levels have receded from near historic highs.

The introduction of zebra mussels (*Dreissena polymorpha*) in the late 1980s triggered a tremendous ecological change in the lake. Zebra mussels have changed the habitat in the lake, altering food web dynamics, energy transfer, and how nutrients and contaminants are cycled within the lake ecosystem. Additional non-indigenous invasive species such as the quagga mussel (*Dreissena bugensis*), round goby (*Neogobius melanostomus*), and several large zooplankton species (e.g. *Bythotrephes cederstroemi*, *Cercopaegis pengoi*) have further altered the system. Increased water transparency due to the combined effects of nutrient control and *Dreissena* spp. filtering has reduced habitat for walleye in the western, central, and eastern basins since walleye avoid high light conditions. Increased water transparency at combined with lower Lake Erie water levels has resulted in an increase of submerged macrophytes (aquatic vegetation) and has increased benthic production. Lake Erie beaches and submerged sediment substrates have also been affected by *Dreissena* spp. with a significant loss of soft substrates on the bed of Lake Erie (Berkman et al. 1998). Moreover, the food web is currently in transition. Changes in trophic conditions initiated by loading reductions became a significant problem after *Dreissena* spp. initiated biological oligotrophication by further redirecting nutrients from pelagic production to benthic production (Johannsson et al.2000).

### Pressures on the System

Environmental conditions in the Lake Erie ecosystem continue to improve, but impacts of exotic invasive species, contaminants, hardened shorelines, loss of habitat and land use alterations continue to challenge the physical integrity of the system. The Lake Erie



ecosystem continues to be impaired by stressors caused by:

1. Introduction of exotic species;
2. Urban sprawl, development, and associated habitat destruction and loss;
3. Shoreline development and alterations;
4. Agricultural and industrial practices within the basin;
5. Atmospheric contaminant deposition from outside the basin; and
6. Global climate change.

There is an ongoing threat from new exotic invasive species. Established invasive exotic species have irreversibly altered the ecology of the Lake Erie ecosystem resulting in changes at all levels of the ecosystem. Lake Erie ranks second to Lake Ontario (31 sites) of all Great Lakes for first records of aquatic invasive species. There have been 22 sites in the open waters of Lake Erie where ANS were first reported (Corkum and Grigorovich 2003). Lake Erie proper has 34 non-native invasive fish species and new species are likely to enter the lake from the Mississippi drainage basin and from adjacent lakes. Additional exotic species, including European ruffe and Asian carp, pose potential threats to Lake Erie. European ruffe are present in the upper Great Lakes and Asian carp are on the verge of entering Lake Michigan via the Chicago Sanitary and Shipping Canal. Impacts to the physical integrity of the ecosystem have reduced the resilience of the ecosystem to exotic species introductions. Moreover, ANS threats exist from intentional introductions through aquaculture, live fish markets, sport fishing, pet trade, and bait fishes.

Land use change has altered the physical integrity of the system and has increased suspended solids, BOD and sediment loadings to coastal wetlands, estuaries, and many nearshore areas; increasing turbidity, decreasing DO, and destroying submerged aquatic vegetation. This has, in turn, depressed zooplankton and benthic invertebrate production, particularly in nearshore areas. The result is reduced energy available for many forage and larval fishes at nearshore locations, especially estuaries that were formerly extremely important nursery zones for high value fish species.

Healthy wetlands are a valuable and intensively utilized fish habitat in the Great Lakes. Hardening of natural habitat has resulted in the loss of access (connectivity) to coastal wetlands for wetland species (40% of the Lake Erie fish assemblage) and loss of historically significant production to the littoral zone and open lake. Direct and irreversible loss of coastal wetland and estuarine habitat and degradation of remaining wetlands by infilling, dredging, diking, tributary loadings, and other physical, chemical, and biological perturbations is likely one of several major factors responsible for altering the Lake Erie food web and fish community structure.

Regional climate change models (Canadian Centre for Climate Modeling CCGM1 and UKMO/Hadley Centre HADCM2) project a 1 to 2 m decline in long-term annual water levels over the next 70 years for the Great Lakes (e.g. Lofgren et al. 2002; Mortsch and Quinn 1996; Lee et al. 1996). Recent work by Wuebbles and Hayhoe (2003) using the HADCM3 model projects higher temperature changes for the Midwestern US than those predicted by the CCGM1 and HADCM2 models. Fan and Fay (2004) using net basin supply models based on four climate-change scenarios show that, as compared to the base case, the levels of Lake Erie would fall by 15 cm to 81 cm. Lee et al. (1996) predicted that a reduction in long-term annual water levels in Lake Erie and Lake St. Clair by 1.5 m or more would significantly reducing the lakes' surface area and moving the shoreline distances less than 1 km to as much as 6 km lakeward. Reductions in water levels will likely hydrologically isolate many high-quality wetland and estuarine areas that are currently protected or maintained by government agencies and/or non-governmental conservation organizations (Mortsch 1998). Moreover, reduced water levels will alter nearshore littoral and sub-littoral habitats, permanently altering benthic and fish community structure throughout the Great Lakes. The effects of lower water levels will also fundamentally affect seasonal timing and connectivity, food-web dynamics, and the distribution and diversity of biological communities in the basin (e.g. Kling et al. 2003, Casselman et al. 2002).

#### **Future and Emerging Management Issues:**

The most pressing management needs include:

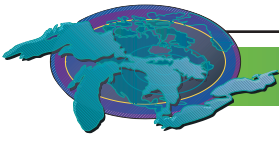
1. More effective methods to prevent the introduction of new exotic species into the basin and ways to prevent the spread of those that are already established;
2. Restoration of natural processes that restore the physical integrity of the Lake Erie ecosystem, including: protecting Lake Erie's water resources (diversions), restoration of natural flow regimes and connectivity in tributary and coastal systems, restoration of natural coastal processes, controlling urban sprawl and limiting habitat destruction and loss; and



3. Anticipating long-term impacts of global change on water resources, habitat, and the Lake Erie ecosystem.

#### Acknowledgements/Sources of Information

- Berkman, P.A., Haltuch, M.A., Tichich, E., P.A., Garton, D.W., Kennedy, G.W., Gannon, J.E., Mackey, S.D., Fuller, J.A., and Liebenenthal, D.L., 1998, Zebra mussels invade Lake Erie muds: *Nature*, v. 393, p. 27-28.
- Bolsenga, S.J., and C.E. Herdendorf [Eds]. 1993. *Lake Erie and Lake St. Clair Handbook*. Wayne State University Press, Detroit, Michigan.
- Casselman, J.M. 2002. Effects of temperature, global extremes, and climate change on year-class production of warmwater, coolwater, and coldwater fishes in the Great Lakes basin: *American Fisheries Society Symposium* 32, p. 39–60.
- Charlton, M.N. and J.E. Milne. 2004. Review of Thirty Years of Change in Lake Erie Water Quality, NWRI Contribution No. 04-167, Burlington, ON, Canada.
- Corkum, L.D. and I.A. Grigorovich. 2003. Update on Non-Native Invasive Species in Lake Erie, Chapter 11.2, Draft 2004 LaMP Report.
- Dolan, D.M. 1993. Point Source Loading of Phosphorus to Lake Erie. *J. Great Lakes Res.* 19:212-223.
- Fan, Y. and D. Fay. 2004. Upper Great Lakes Water Levels for Four Climate Change Scenarios, Great Lakes –St Lawrence Regulation Office, Meteorological Service of Canada, Environment Canada
- Halyk, L.C. and D.H. Davies. 1998. Impairment of the Beneficial Use of Lake Erie fish habitat. Draft summary. Prepared for the Lake Erie LaMP Beneficial Use Sub-Committee. 61 pp.
- Hartman, W.L. 1973. Effects of exploitation, environmental changes, and new species on the fish habitats and resources of Lake Erie. *Great Lakes Fishery Commission Technical Report No. 22*. 43 pp.
- IJC. 1993. Levels Reference Study – Great Lakes-St. Lawrence River Basin. Annex 2: Land Use and Management. Report submitted to the Levels Reference Study Board, Phase II, IJC Levels Reference Study, 302 pp. plus appendices.
- Johannsson. O.E., R. Dermott, D.M. Graham, J.A. Dahl, E.S. Millard, D.D. Myles, and J. LeBlanc, 2000. Benthic and Pelagic Secondary Production in Lake Erie After the Invasion of *Dreissena* spp. with Implications for Fish Production, Fisheries and Oceans Canada. *J. Great Lakes Res.* 26(1): 31-54
- Kling, G.W., K. Hayhoe, L.B. Johnson, J.J. Magnuson, S. Polasky, S.K. Robinson, B.J. Shuter, M.M. Wander, D.J. Wuebbles, D.R. Zak, R.L. Lindroth, S.C. Moser, and M.L. Wilson. 2003. *Confronting Climate Change in the Great Lakes Region: Impacts on our Communities and Ecosystems: Union of Concerned Scientists, Cambridge, Massachusetts, and Ecological Society of America, Washington, D.C., 105 p.*
- Lam, D.C.L., W.M. Schertzer and McCrimmon, 2002, Modelling changes in phosphorus and dissolved oxygen pre- and post-zebra mussel arrival in Lake Erie. NWRI Contribution No. 02-198, Environment Canada, Burlington, ON, Canada.
- Lam, D.C.L., W.M. Schertzer and A.S. Fraser. 1987. A post-audit analysis of the NWRI nine-box water quality model for Lake Erie. *J. Great Lakes Res.* 13: 782-800.
- Lee, D.H., R. Moulton, and D.A. Hibner. 1996. Climate change impacts on Western Lake Erie, Detroit River, and Lake St. Clair water levels: Great Lakes – St. Lawrence Basin Project, Environment Canada and NOAA, GLERL Contribution #985, 44 p.
- Lofgren, B.M., F.H. Quinn, A.H. Clites, R.A. Assel, A.J. Eberhardt, and C.L. Luukkonen. 2002. Evaluation of potential impacts on Great Lakes Water Resources based on climate scenarios of two GCM's: *J. Great Lakes Res.* 28(4): 537-554.
- Maynard, L. and D. Wilcox. 1996. Coastal Wetlands. State of the Great Lakes Ecosystem Conference (SOLEC) Working Paper.



Mortsch, L.D. 1998. Assessing the impact of climate change on the Great Lakes shoreline wetlands: *Climate Change*, Vol. 40, p. 391-416.

Mortsch, L.D. and F.H. Quinn. 1996. Climate change scenarios for Great Lakes Basin ecosystem studies: *Limnology and Oceanography*, Vol. 40, p. 903-911.

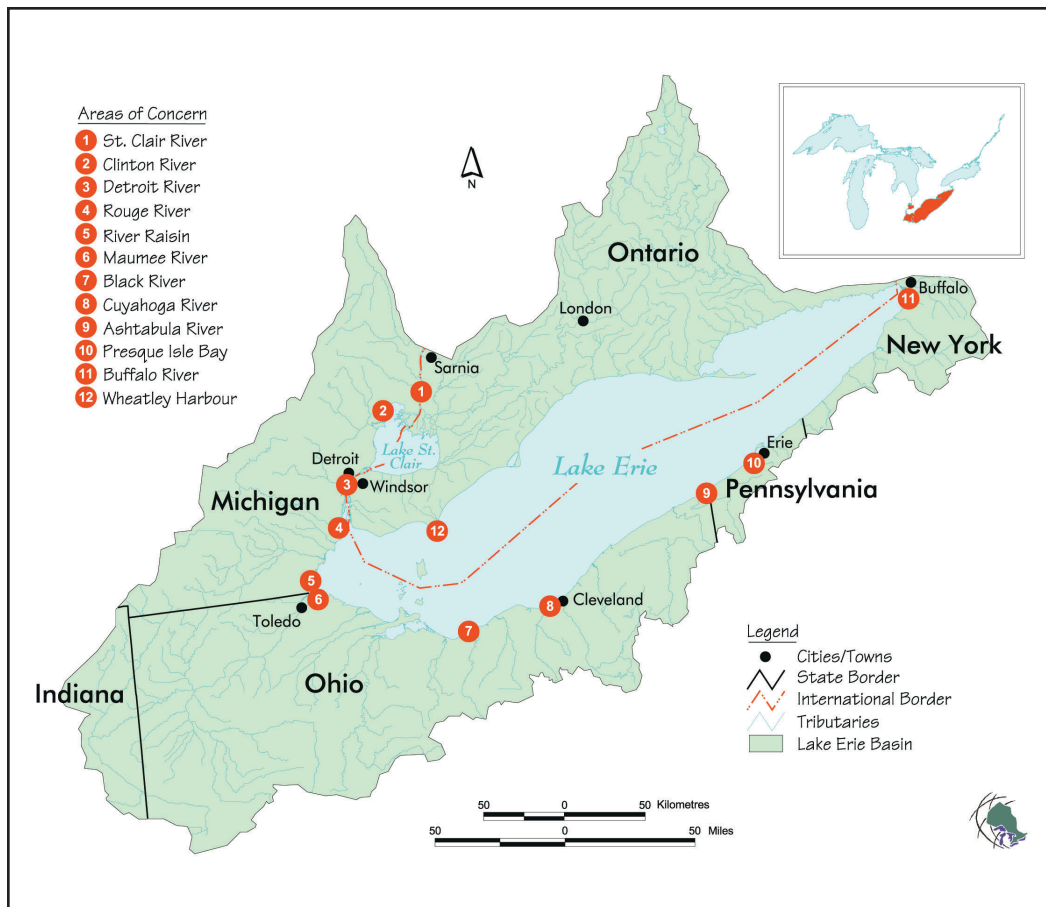
National Geophysical Data Center. 1998. Bathymetry of Lake Erie and Lake Saint Clair. In *World Data Center for Marine Geology and Geophysics report #MGG-13*. L.A. Taylor, P. Vincent, and J.S. Warren (eds.). National Geophysical Data Center. Boulder, CO.

ODNR – Division of Geological Survey. 2004. Ohio Lake Erie Shore Structure Inventory. Personal Communication.

Richards, R.P. and D.B. Baker. 1998. Twenty Years of Change: The Lake Erie Agricultural Systems for Environmental Quality (LEASEQ) Project. In *Proceedings: National Watershed Water Quality Project Symposium*, pp. 223-229. EPA/625/R-97/008.

Snell, E.A. 1987. Wetland distribution and conversion in southern Ontario. Canada Land Use Monitoring Program. Working Paper No. 48. Inland Lands and Waters. Directorate. Environment Canada.

Wuebbles, D.J. and K. Hayhoe. 2004. Climate change projections for the United States Midwest: Mitigation and Adaptation Strategies for Global Change, XX. p. 1-29.



Lake Erie Drainage Basin.

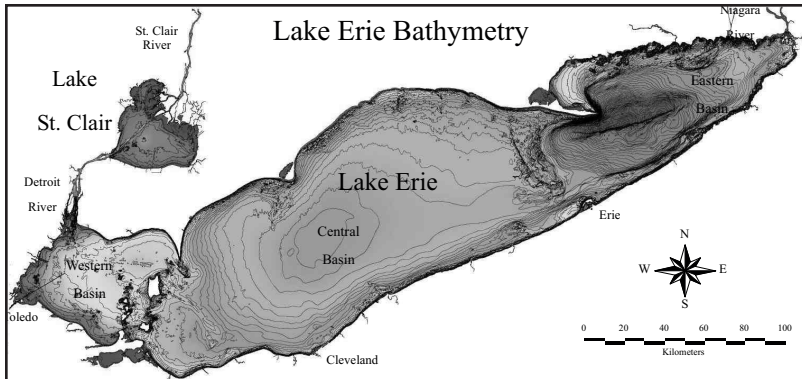
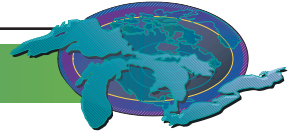


Figure 1. Map of Lake Erie bathymetry illustrating three distinct basins. Eighty percent of Lake Erie's total inflow of water comes through the Detroit River. Bathymetric 1-meter contour intervals are shown (National Geophysical Data Center 1998)

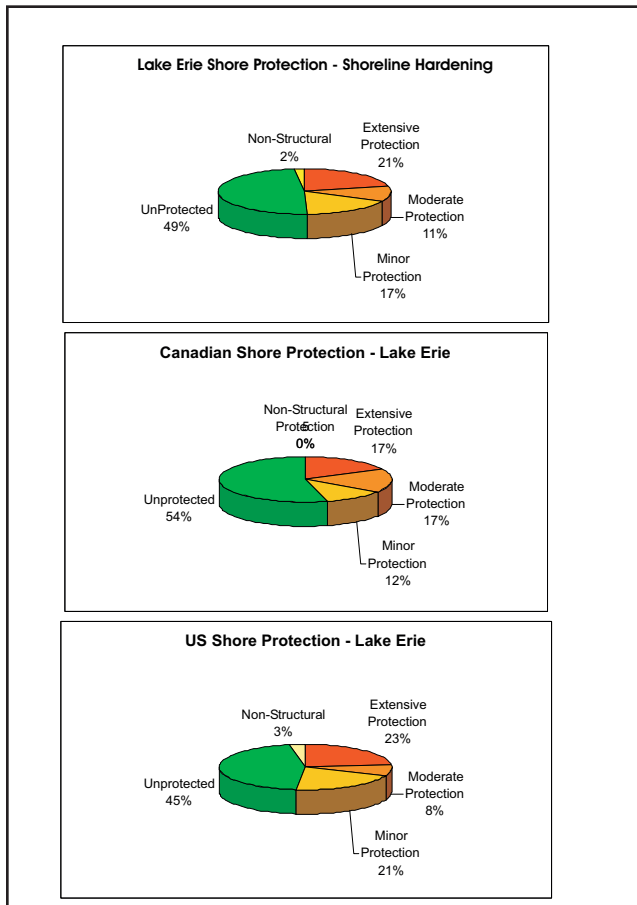


Figure 2a. In 1993, approximately half of Lake Erie shoreline was protected by some type of man-made structure (IJC 1993). These structures affect natural coastal processes that create and maintain critical coastal and nearshore habitats.

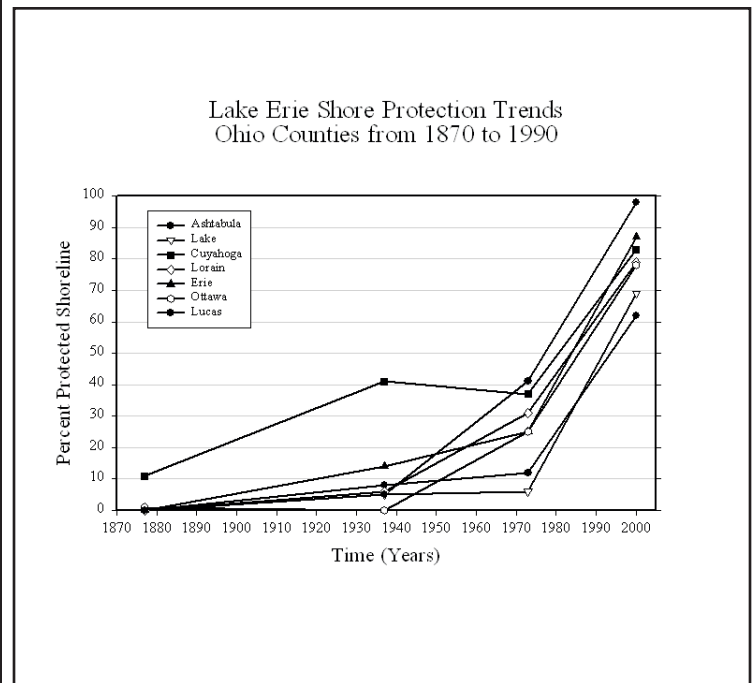
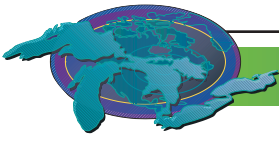


Figure 2b. In Ohio, the percentage of protected shoreline more than doubled between 1970 and 2000 in response to increased shoreline development and erosion caused by near-record high Lake Erie water levels (ODNR – Ohio Division of Geological Survey).



## Lake Erie Fish Community

Five fishery management agencies (Michigan DNR, Ohio DNR, Pennsylvania Fish and Boat Commission, New York DEC, Ontario MNR and three federal agencies (USGS, USFWS, DFO Canada) collaborate through the Great Lakes Fisheries Commission to support annual population assessments for key species in Lake Erie (walleye, yellow perch, lake whitefish, lake trout, rainbow trout, burbot, sea lamprey, smelt, and lake herring; [www.glfsc.org](http://www.glfsc.org)). Information for other species (smallmouth bass, white perch, white bass, may be obtained from agency reports.

Our evaluation of the status of the Lake Erie fish community will be provided in reference to three perspectives: the historical reference, post GLWQA or early 1980s, and the current vision of the LEC, documented in “Fish Community Goals and Objectives” (Ryan et al. 2001).

A map of lake bathymetry shows that the lake depths increase from west to east (Figure 1). Nutrient levels decline along the same gradient, so that the western basin is mesotrophic, the east is oligotrophic and the central basin shows the gradient between them. The west and east basins are perceived as the centres of organization for two different fish community types, resulting in the need for management goals for each community:

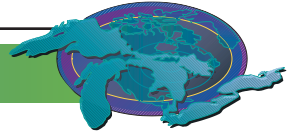
1. To secure a balanced, predominantly cool-water fish community, with walleye as a key predator in the western basin, central basin, and the near-shore waters of the eastern basin, characterized by self-sustaining indigenous and naturalized species that occupy diverse habitats, provide valuable fisheries, and reflect a healthy ecosystem.
2. To secure a predominately cold-water fish community in the deep, offshore waters of the eastern basin with lake trout and burbot as key predators.

Most of the lake volume is classified as cool-water habitat (75% of volume, Christie and Regier 1988), and this makes the cool-water community dominant.

The biomass composition in western Lake Erie (Figure 2) includes strong representation from the cool-water fish community (temperature preferences 20-28C) and some warm-water species. The cool-water community has lost significant biodiversity through the extinction of the blue pike (walleye subspecies Table 1), and sauger (walleye genus, separate species), and by the major decline in the abundance and distribution of lake sturgeon. Walleye stocks have increased beyond their apparent historical abundance, exhibit migratory behavior similar to the blue pike and may be providing a similar predator function in the lake. Yellow perch have increased beyond their apparent historical abundance. The burrowing mayfly is a key benthic species whose abundance has recovered to historical levels in major areas of the western basin, where it provides a valuable food supply to percids and other fish species. Walleye and perch both showed strong declines after zebra & quagga mussels colonized the lake, but yellow perch made a strong recovery beginning in the late 1990s and then walleye has begun a recovery with stronger reproduction in 2003. Walleye and burrowing mayflies are indicators of the health of mesotrophic food webs (Edwards and Ryder), and both are showing signs of improvement in the 2000s.

### Coolwater Community Status – Mixed/Improving

The biomass of the community in the eastern basin (Figure 3) shows strong representation from cold-water species. The coldwater community (temperature preferences < 20C) has exhibited a catastrophic loss of biodiversity. Sculpins (slimy, spoonhead), deepwater (longjaw) and shallow-water cisco (lake herring) and lake trout have not been recorded since the 1960s. A lake trout stocking program was initiated by NYDEC and USFWS (1970s), and survival of lake trout has improved with establishment of sea lamprey control in the 1980s. Similarly the native burbot have increased in abundance after sea lamprey control. The coldwater food web is centered in the deep waters of the eastern basin and near-by waters of the central basin which usually maintain sufficient dissolved oxygen during the summer. Some former key invertebrate components of that food web are either rare (Opossum shrimp since 1960s or earlier) or apparently extinct (deepwater burrowing amphipod since late 1990s). These organisms are used as food by all of the deepwater fish species for at least part of their life history, in north-temperate lakes, so this is a critical loss of biodiversity. Fish biomass in coldwater habitat in the 1990s was dominated by rainbow smelt, a non-native invasive species. Smelt and alewife (NIS) can affect the reproduction success of the fish which consume them, because of their content of thiaminase which affects the viability of their predator's eggs. The recovery of a lake trout population by stocking is continuing to be adapted to the lake's environmental



conditions by selection of lake trout genetic strains, stocking strategies and by marking of historical spawning areas to attract spawners, by stocking of sac-fry stage trout. Survival of the stocked fish in recent years has improved in recent years, indicating that the status of lake trout is improving. The lake whitefish population increased substantially in the 1980s, and has remained at a higher level of abundance. The deepwater ampipod was the other indicator species for coldwater or oligotrophic food webs (Ryder and Edwards), and it has shown no sign of recovery. Although there are sporadic reports of lake herring, most of the native species biodiversity of the coldwater food web has been lost. Functional biodiversity may be making some recovery as more of the Caspian fauna associated with quagga mussels have colonized coldwater habitat. Compositional biodiversity (native species) is low, functional biodiversity low but improving.

### **Coldwater Community Status – Mixed/Improving**

The warm-water fish community (temperature preference > 28C) are significant components of the fish community but on a more local scale such as shorelines, river mouths, bays and coastal wetlands. Information concerning rare, threatened and endangered species in US waters (<http://endangered.fws.gov/>) and in Canadian waters (<http://www.cosewic.gc.ca/index.htm> , [http://www.dfo-mpo.gc.ca/species-especies/home\\_e.asp](http://www.dfo-mpo.gc.ca/species-especies/home_e.asp)).

#### **“Stocks-R-U.s”**

Lake Erie’s fisheries are primarily based on wild native fish species (walleye, yellow perch, smallmouth bass, lake whitefish) and on wild, “naturalized” stocks of rainbow trout. The Lake Erie Committee recognizes the stock concept in management:

“Stocks (or populations) are the basic unit for conservation and management and should, where feasible, be identified, monitored, and appropriately managed. “

A wild fish population, such as the walleye in Lake Erie (Figure 4), must rely upon lake and stream environments to provide suitable conditions for their life cycle ie spawning, nursery, juvenile and adult habitats. Over the ca. 6000 years that Lake Erie has been at the current water level, there has been adaption to local conditions by the evolution of the population into stocks. Walleye that were tagged from the Grand River Ohio return there, rather than go to other spawning areas. The “spawning ground fidelity” that these fish show, allows them to adapt to the local conditions. DNA testing can tell you how similar or divergent walleye stocks are from each other, which is an indication of the level of adaption and separation between stocks. Dr. Mark Gross (of U of T), refers to stocks as the “Rembrandts of natural selection”.

We know the most about walleye stocks, because of our long history of tagging studies and adaption of new technology to stock identification. A number of walleye stocks are depressed or have apparently been lost, as indicated on this map. Poor environmental conditions in tributaries and dams have contributed to loss of stocks and may prevent recovery. The life history for a walleye stock shows how the local environmental conditions in a tributary affects the walleye fishery in the lake. The current initiatives under the GLWQA (RAPS – eg Detroit R., Maumee R., Buffalo Harbour, Cuyahoga R., Lake Erie LaMP, Lake St. Clair Plan) are critical to complete in order to allow recovery or restoration of walleye stocks and other species in the lake.

### **Assessment – Stocks Mixed/Improving**

There was a high level of integration of the Lake Erie ecosystem by fish migrations in the 1800s. Lake herring migrated from eastern to western basins, and up the Detroit River to Lake St. Clair. Lake whitefish had a similar migration and entered the Detroit River. Similarly the extinct blue pike (blue sub-species of walleye) formerly migrated between basins. The smelt and alewife which replaced lake herring do not exhibit migratory behavior. In 2000, the movement of walleye is similar to that of blue pike. Whitefish have maintained their migratory pattern as they started to recover (1980s-90s). An index of ecosystem integration represented by fish migration would be judged to be “mixed/improving”.

### **Pressures on the System**

The early 1980s were an opportunity to see the response of the fish communities to achievement of GLWQA goals relative to eutrophication, and with recovery of walleye as a top predator in the community. The picture was very favourable (see Makarewicz and Bertram 1993). Since then, new invasive species (Spiny water flea) and the Caspian Sea fauna have had strong impacts on the ecosystem and shaped the fish communities, since then. The zebra mussel proliferated rapidly (1987-1989) but was quickly replaced by the quagga mussel (early 1990s), while its Caspian predator (Round goby) and another Caspian species (Echinogammarus) exhibited slower rates of range expansion in Lake Erie. The spread of zebra/quagga mussels was associated with a phenomenon called





biological oligotrophication. The amount of suspended algae or phytoplankton in the water was reduced by the filtration of the mussels, so that we didn't have that material available as food to other organisms and the water was much clearer. It is called oligotrophication, because high transparency is typical of oligotrophic lakes (eg offshore areas of the other great lakes). Under these conditions, there was a recovery of native species biodiversity for fish in the western waters of the lake (Ludsin et al. 2001). At a broader scale, there was a decline in the capacity of the lake to support cool-water species such as yellow perch and walleye with the arrival of the mussels, until a recovery became apparent for yellow perch in the late 1990s and very recently for walleye. The capacity of the cold-water habitat to support fish was substantially reduced as indicated by a decline in smelt biomass, and reduced survival of young lake trout. This appeared to be linked to the loss of the deepwater amphipod from the coldwater food web, as quagga mussels colonized the habitat. Reversal of trends in the two communities seems to have followed the range expansion of gobies in the lake.

### Definitions

The following definitions are being used to guide the qualitative assessment of ecosystem conditions based on an indicator: Both a statement of current condition and an ecosystem trajectory are requested.

- Good.** The state of the ecosystem component is presently meeting ecosystem objectives or otherwise is in acceptable condition.
- Fair.** The ecosystem component is currently exhibiting minimally acceptable conditions, but it is not meeting established ecosystem objectives, criteria, or other characteristics of fully acceptable conditions.
- Poor.** The ecosystem component is severely negatively impacted and it does not display even minimally acceptable conditions.
- Mixed.** The ecosystem component displays both good and degraded features.
- Improving.** Information provided by the indicator shows the ecosystem component to be changing toward more acceptable conditions.
- Unchanging.** Information provided by the indicator shows the ecosystem component is neither getting better nor worse.
- Deteriorating.** Information provided by the indicator shows the ecosystem component to be changing away from acceptable conditions.
- Undetermined.** Data are not available to assess the ecosystem component over time, so no trend can be identified.

### References

Christie & Regier

Edwards, C.J. and R.A. Ryder. 1990. Biological surrogates of mesotrophic ecosystem health in the Laurentian Great Lakes. Int. Joint Comm., Windsor, Ont.

Ludsin, S.A., M.W. Kershner, K.A. Blocksom, R.A. Stein and R.L. Knight. 2001. Life after death in Lake Erie: nutrient controls drive fish species richness, rehabilitation. *Ecol. Appl.* 11: 731-746.

Lake Erie Committee Task Group Reports (4) and "State of the Lake" Presentations. 2004.

Makarewicz, J.C. and P. Bertram. 1993. Evidence for the restoration of the Lake Erie ecosystem. *BioScience* 41: 216-223.

NOAA map credit

Ryan, P.A., L.D. Witzel, J. Paine, M. Freeman, M. Hardy, S. Scholten, L. Sztramko and R. MacGregor. 1999. Recent trends in fish populations in eastern Lake Erie in relation to changing lake trophic state and food web. p. 241–289 *In* State of Lake Erie (SOLE)—Past, Present and Future. M. Munawar, T. Edsall and I. F. Munawar [eds.] *Ecovision World Monograph Series*. Backhus Publisher, Leiden, The Netherlands.

Ryder, R.A. and C.J. Edwards (Eds.). 1985. *A Conceptual Approach for the Application of Biological Indicators of Ecosystem Quality in the Great Lakes Basin*. Great Lakes Science Advisory Board, International Joint Commission, Windsor, Ont., and Great Lakes Fish. Comm., Ann Arbor, Mich.

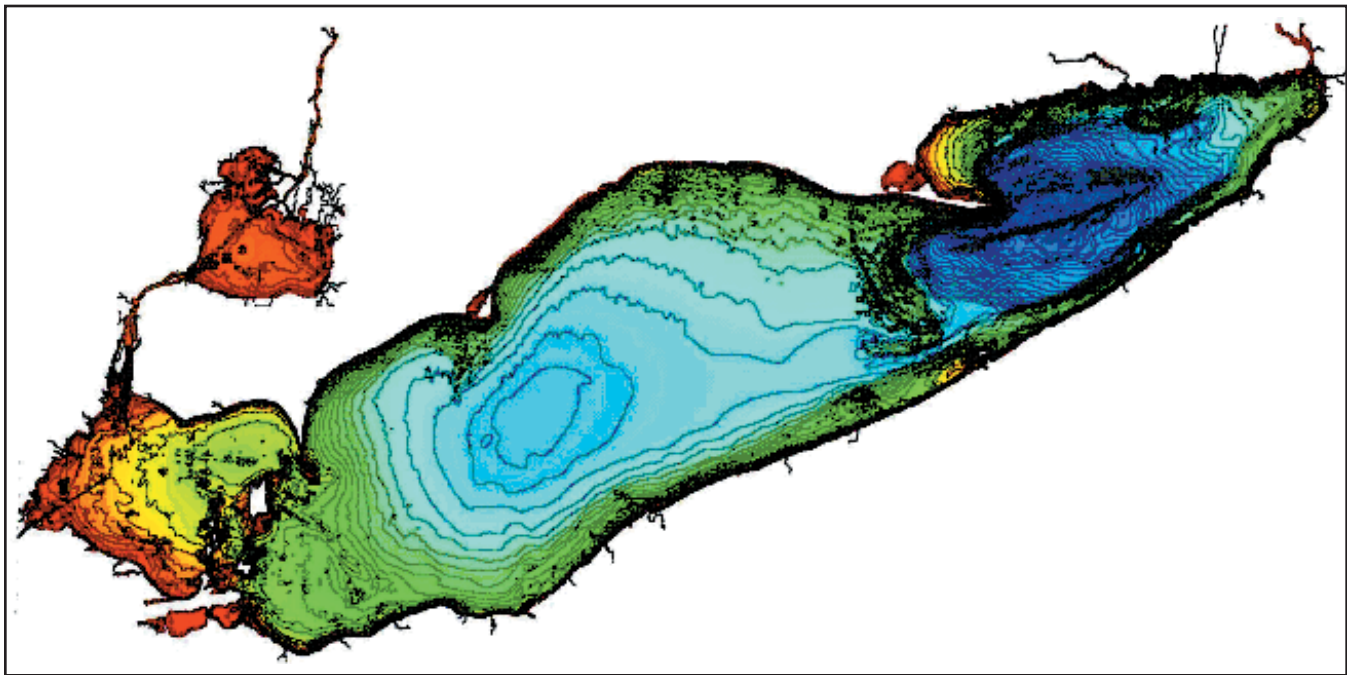
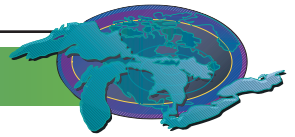


Figure 1. Bathymetry map of Lake Erie.

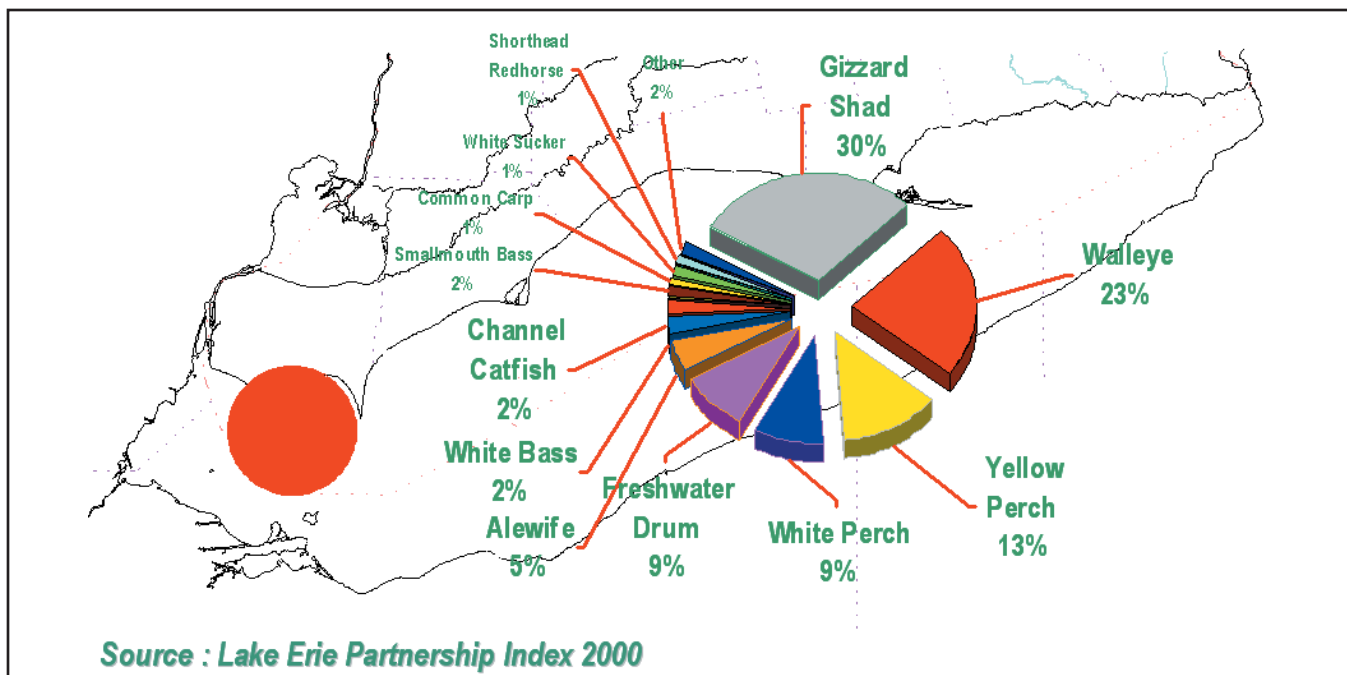


Figure 2. Biomass composition in the western basin of Lake Erie.  
Source: Lake Erie Partnership Index 2000

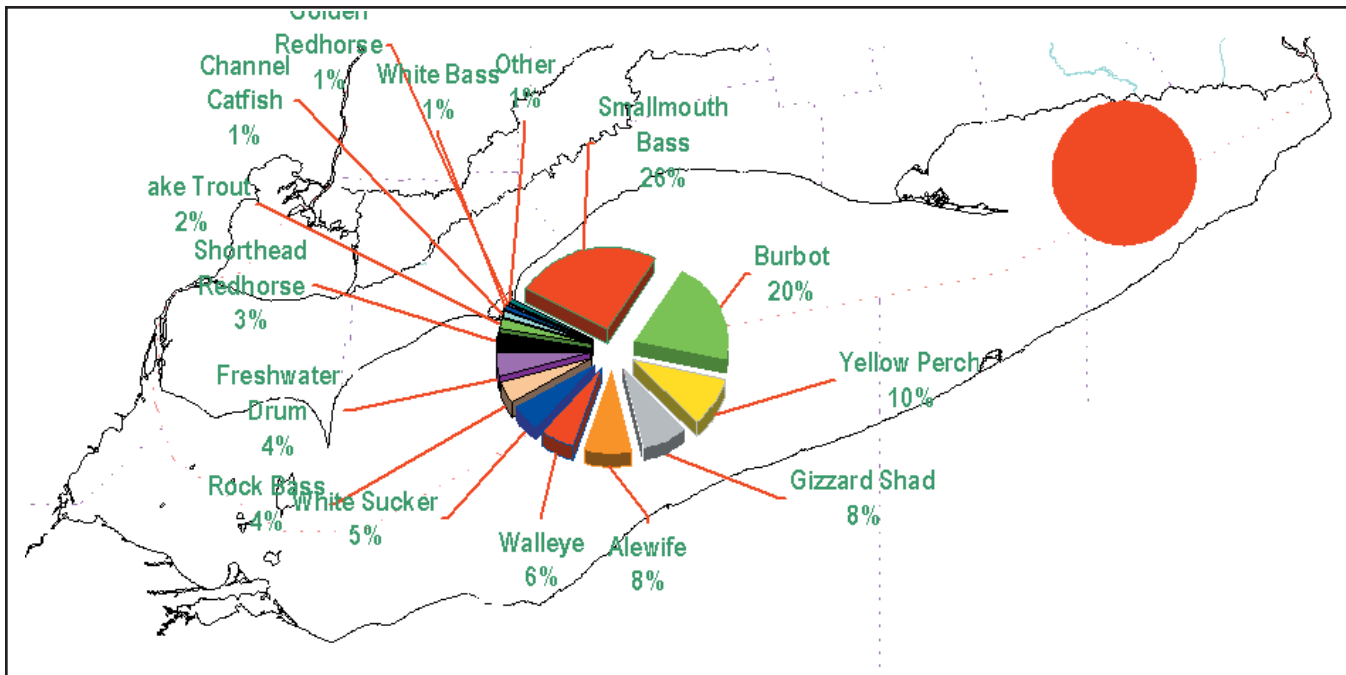
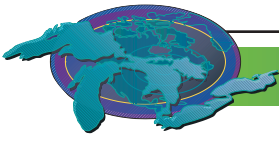


Figure 3. Biomass composition in the eastern basin of Lake Erie.  
Source: Lake Erie Partnership Index 2000.

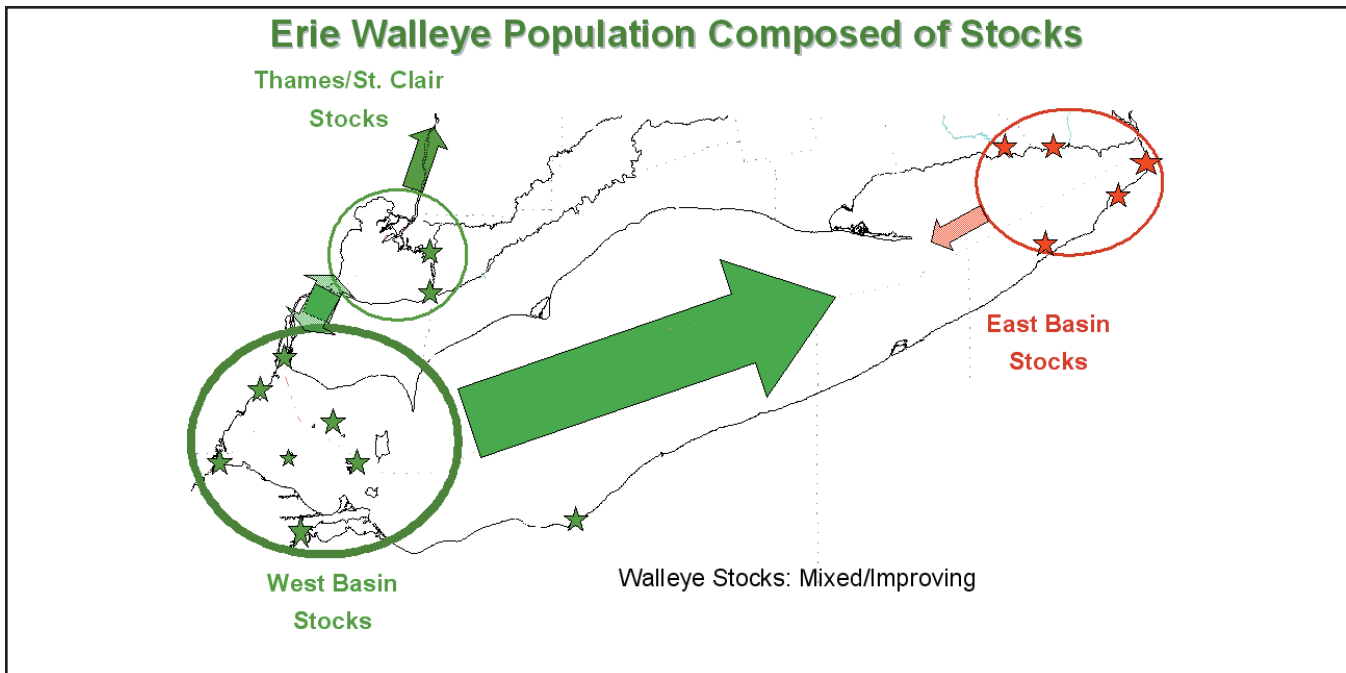
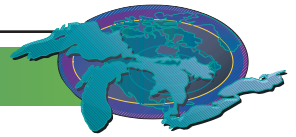
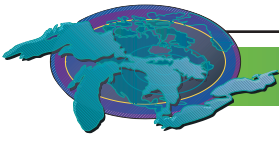


Figure 4. Lake Erie Walleye Population Composed Stocks.



Coldwater and associated species				
Long-jaw Cisco	"extinct"			
Lake Herring	rare			
Slimy Sculpin	"extinct"			
Spoonhead Sculpin	"extinct"			
Lake Trout	extinct	pre-lamprey control	stocked	Improving
Deepwater Amphipod	"extinct"	+++		
Opossum Shrimp	"rare"		Poor	Undetermined
Lake Whitefish	"common"	+	Mixed	Natural variability
Burbot	abundant	+	Good	Natural variability
<i>Rainbow Trout</i>			naturalized/stocked	
<i>Rainbow Smelt</i>			++++	
<i>Alewife</i>			+	
<i>Round Goby</i>			++	
<i>Quagga Mussel</i>			++++	
<b>Community Status</b>			<b>Mixed</b>	
			<b>Improving</b>	

Table 1. Major species and status for 2 dominant food web types in Lake Erie.  
Code: less than "++++" indicates species below potential capacity of lake.



## Lake Ontario

**Assessment:** *The status of the Lake Ontario ecosystem is mixed.*

Lake Ontario is an ecosystem in transition. Over the last hundred years the Lake has been subjected to a number of stresses including: urban development, overfishing, nutrient enrichment, contaminant discharges, the introduction of non-native species (e.g. alewife and sea lamprey), and water level regulation- which have led to the degradation of water quality, the loss of fish and wildlife habitat and the decline of native fish communities. While the ecosystem has shown a remarkable capacity to respond and repair the damage done, new forms of stress keep appearing.

Over the last decade zebra and quagga mussels have significantly disrupted Lake Ontario's aquatic foodweb. Key native benthic organisms vital to the health of fisheries disappeared in the years following the arrival of these exotic mussels. These changes threaten efforts to restore naturally reproducing populations of native lake trout and have severely impacted whitefish commercial fisheries.

On the Canadian side of the basin, land use and population growth are also putting an enormous stress on the system and this stress is growing. It is projected that by 2030- 3.0 million more people will live in the Lake Ontario basin, with almost all that growth concentrated at the western end of the Lake.

### Summary of the Status of the Lake Ontario Ecosystem

#### Background

Lake Ontario is the last in the chain of Great Lakes. Lake Ontario is also the smallest of the Great Lakes in terms of surface area, although it is relatively deep, with an average depth of 84 meters, and a water retention time estimated to be about seven years. Over 80 percent of the water flowing into Lake Ontario comes from the upper Great Lakes through the Niagara River.

More than eight million people live in the Lake Ontario basin, concentrated in the northwest part of the Canadian shoreline. This region, commonly referred to as the "Golden Horseshoe", is highly urbanized and industrialized. The U.S. side of the lake is not as heavily populated, although there are concentrated areas of urbanization at Rochester, Syracuse and Oswego. Outside of these areas, agriculture and forests dominate the land uses within the basin. The forested areas, however, are mainly in the northernmost and easternmost areas of the watershed. Nearer to the Lake, forest habitat is highly fragmented.

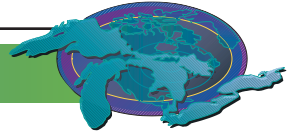
There are nine Areas of Concern (AOCs) in the Lake Ontario basin, including the Niagara River AOC. The causes of impairments within the AOCs are being addressed, and fish and wildlife habitat, populations, and environmental quality are slowly recovering, although in the heavily urbanizing areas (for example, the Golden Horseshoe) the gains being made may be offset by development pressures.

#### Contaminants

As a result of actions taken by Canada and the U.S. to ban and control contaminants (such as PCBs, DDT, mirex, dioxin/furans, mercury and dieldrin) entering the Great Lakes- levels of contaminants in the Lake Ontario ecosystem have decreased significantly over the last twenty to twenty-five years. Recent findings indicate that the management of these critical pollutants has been effective in reducing their presence in the ecosystem, and that fish and wildlife have responded positively.

Critical pollutant levels in fish tissue have shown a significant reduction (Figure 2). For example: levels of critical pollutants in Lake Ontario coho salmon have been decreasing steadily (PCB levels have gone down by 66 percent; concentration of mirex by 50 percent). However, levels for some contaminants still exceed fish consumption advisories.

Levels of contaminants in herring gull eggs have also decreased dramatically (Figure 3). In the 1970's, fish eating birds in Lake Ontario were found to have very high levels of contaminants in their eggs. Some species exhibited much thinner eggshells than normal, elevated rates of embryonic mortality and deformities, total reproductive failure, and declining population levels. Most of these conditions have improved greatly: contaminant levels have declined; successful reproduction is occurring; and population levels have generally increased. The results are encouraging- suggesting that the food base for fish eating birds in Lake Ontario is becoming



ing less contaminated.

However, there are emerging contaminant issues in the Lake Ontario ecosystem which include brominated flame retardants (PBDEs) and fluorinated surfactants (PFOS). See Contaminants in Whole Fish Indicator Report (#121) for details.

Some fish and wildlife populations once on the verge of extinction have rebounded. Populations of fish-eating waterbirds on Lake Ontario have recovered and are reproducing normally. Caspian terns, common terns, gulls and cormorants have all benefited from the reduction of pollutants. Several key indicator species such as the bald eagle, river otter and mink are also making a comeback in the Lake Ontario ecosystem. Aquatic communities, however, are still under stress from other factors (see status assessment prepared by the Lake Ontario Committee of the Great Lakes Fishery Commission).

It appears that the most significant source of critical pollutants to Lake Ontario now comes from outside the Lake Ontario basin. Upstream sources are responsible for most of the PCBs, DDT and dieldrin that enter the Lake; most of the mirex comes from the Niagara River basin; and atmospheric deposition is the other main source.

#### Aquatic Communities

(See status assessment prepared by Lake Ontario Committee of the Great Lakes Fishery Commission)

#### Fish and Wildlife Habitat

On the other hand, loss of fish and wildlife habitat is a lakewide problem caused by: artificial lake level management; the introduction of non-native species; and the physical loss, modification or destruction of habitats (through for example, deforestation and damming of tributaries). Two major power facilities located on the St. Lawrence River obstruct upstream/downstream fish passage and have impacted fish community structure

There has been a long history of loss, modification or destruction of habitats in Lake Ontario- dating back to colonial times: clearing the land, damming of tributaries and streams. Before European settlement nearly the entire Lake Ontario watershed was forested.

Of special note are wetlands which provide vital habitat to many of Lake Ontario's wildlife species. It is estimated that about 50% of Lake Ontario's wetlands throughout the basin have been lost. Along the intensively urbanized coastlines, 60 to 90 percent of wetlands have been lost. These losses are a result of multiple effects associated with urban development and human alterations, such as dyking, dredging, and disturbances by public utilities.

### Pressures on the System

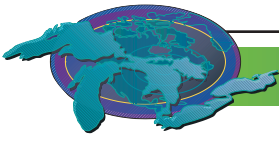
#### Lake Level Regulation

Water level regulation has had serious and lasting impacts on Lake Ontario's natural resources, including fish and wildlife, shoreline habitat and dune barrier systems, and the numerous wetland complexes that line the shoreline.

The artificial management of lake levels has inadvertently reduced the area, quality, and functioning of Lake Ontario nearshore wetlands. As a result of lake level regulation, Lake Ontario wetlands are no longer experiencing the same range of periodic high and low water levels. This reduction in range has resulted in some wetlands becoming a monoculture of cattails-greatly reducing the biodiversity of nearshore areas.

#### Introduction of Non-Native Species

In Lake Ontario, zebra and quagga mussels have changed many aspects of the physical habitat of the Lake. Their filtering activities have greatly reduced the amounts of material in the water column, thereby increasing light penetration. Increased light penetration has, in turn, allowed re-growth of extensive macrophyte beds in many littoral areas. The innumerable shells released as the mussels die have modified onshore and nearshore habitats, creating shell beaches, like the one pictured here, that in many cases have smothered shoreline boulder complexes, filling in most crevasses and fissures in rock formations. Colonies have coated many harder substances as well, encrusting many manmade features. In littoral and sublittoral areas, colonies have formed clumps and piles over soft substrates, creating structured habitats for other macrobenthos and holdfasts for algae. Deeper still, the quaggas have formed colonies that sit on top of mud substrates. In fact, it is believed that the changes brought about by zebra and quagga mussels in the



lake will persist and will potentially be compounded by the arrival of additional invasive species.

Not only have these non-native mussels affected the physical habitat of the Lake, they have also dramatically impacted the Lake's biological and chemical integrity. The zebra and quagga mussels filter water to feed on microscopic phytoplankton and other organic material, thereby reducing the amount of food available to other benthic organisms. As a result, populations of important native benthic organisms have generally declined, and this has created a ripple effect that has affected the health of the fisheries

As new exotic species continue to be introduced from ballast water from overseas shipping and other sources, the potential for impacts from other non-native species is considerable. Some recently introduced species in Lake Ontario, such as a fish called the Round Goby and a zooplankton species called the Fish-Hook Water Flea, have taken advantage of the unstable conditions in Lake Ontario and have expanded rapidly as well.

Interactions between zebra and quagga mussels with the round goby may have created conditions that favor the growth of Type E Botulism. Botulism was a major problem on Lake Erie in recent years and now been detected at a few locations along the Lake Ontario shoreline- most recently this summer on the North East shore.

From a management perspective, it is not clear what the future holds. Once a non-native species is introduced, it disrupts the food web and creates a ripple effect. You can never go back to what you had originally- the changes are irreversible- which is why prevention is the key.

#### Urbanization

On the Canadian side of the basin, land use and population growth are putting an enormous stress on the system and this stress is growing. Human populations are growing very rapidly. By 2030, it is projected that 3.0 million more people will live in the Lake Ontario Basin with almost all of the growth concentrated in the Golden Horseshoe, where low-density urban sprawl is spreading rapidly over the countryside, removing large areas of farmland and natural habitats. This rapid urban growth is projected to continue around Toronto and into the Hamilton-Niagara Area. Between 1996 and 2001 more than 90% of Ontario's population growth took place in this region. In fact, this is the third fastest growing area in North America and one of the top 10 most sprawling regions in the world. It is projected that the region's population will grow from 7.4 million in 2000 to 10.5 million in 2031- an increase of 43%. In the region, more than 1000 square kilometers of land will be urbanized- most of it prime agricultural land. This is almost double the area of the City of Toronto and represents a 45% increase in the amount of urbanized land in the region.

At issue is not only the absolute growth in population, but the nature of that growth (Figure 4). The fringe development is sprawling- consuming 2 to 3 times more land per person than neighbourhoods in the old City of Toronto, which were built prior to World War 2. Rural areas are changing too, with larger farms, fewer farmers, and many more country homes in rural subdivisions or scattered lots. Because these residential uses are often located within scenic natural areas, they often come into conflict with wildlife habitats. In simple terms, the large quantities of land consumed per person through urbanization have resulted in: increases in the amount of impervious land area, increases in vehicular travel and transportation related emissions; and increases in stormwater runoff.

Figure 5 illustrates the future growth areas in Southern Ontario. With these development pressures, it will be very difficult, if not impossible to maintain the recommended 30% natural cover guidelines at the western end of Lake Ontario. It is important to note, however, that these growth pressures are not being felt on the U.S. side, where only modest increases in population are forecast (i.e., between 2000 and 2020- only 3.7% increase).

In terms of management considerations- can't stop more growth and development. The challenge will be to design our communities to accommodate more people- without rampant urban sprawl- and to protect nature for future generations.

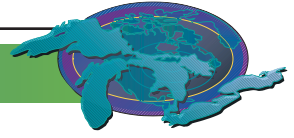


Figure 1. Lake Ontario Drainage Basin and Areas of Concern  
Source: Environment Canada

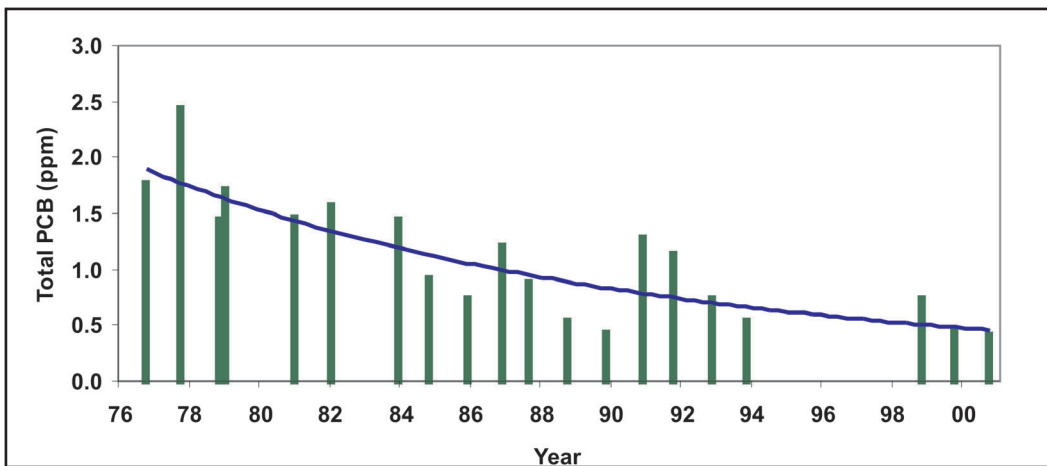


Figure 2. Total PCB Levels in 50cm Coho Salmon from the Credit River, 1976-2001.  
Source: Ontario Ministry of the Environment (A. Todd, A. Hayton), unpublished data.

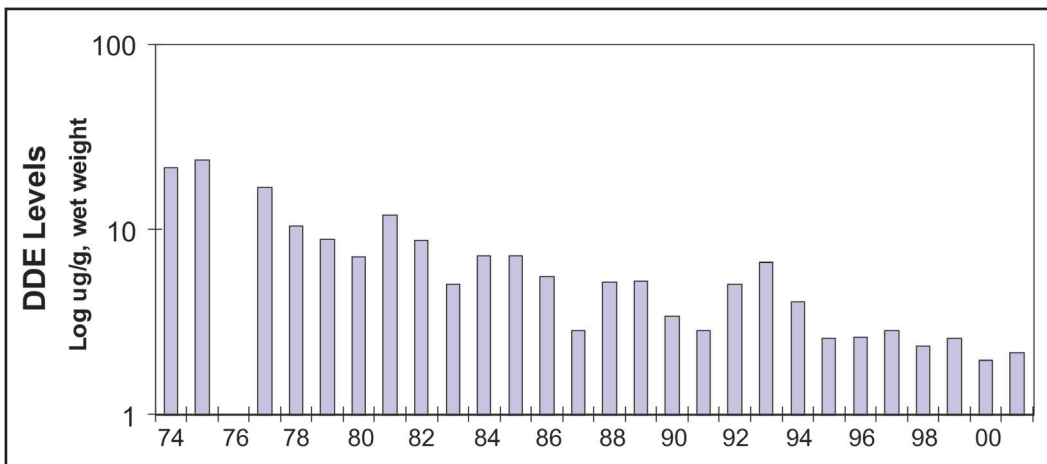


Figure 3. DDE Levels in Herring Gull eggs from Kingston Harbour, 1974-2001.  
Source: Bishop et al., 1992; Pettit et al., 1994; Canadian Wildlife Service, unpublished.



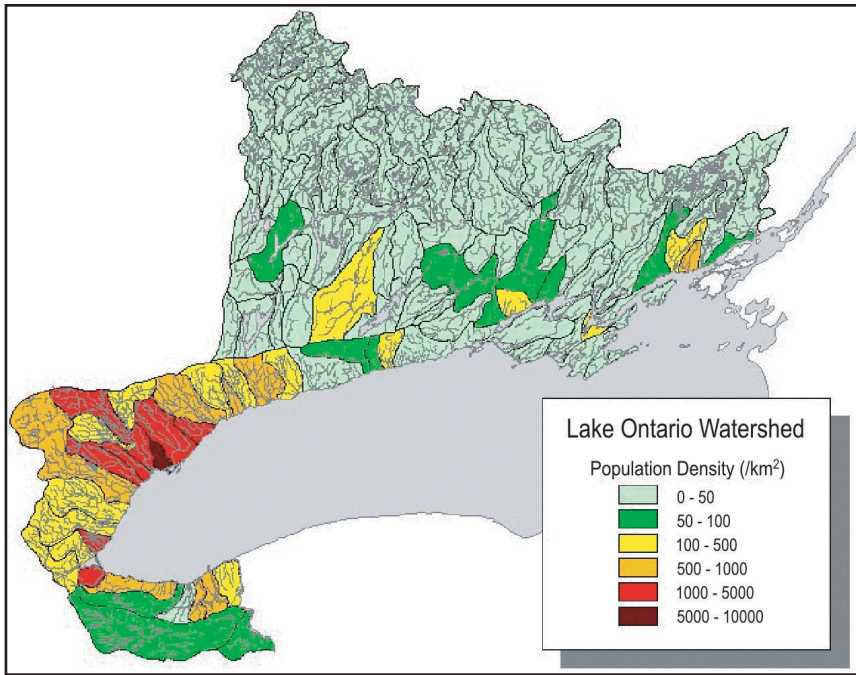
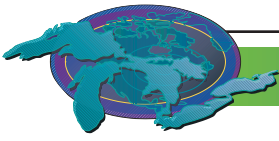


Figure 4. Population Density of the Canadian Lake Ontario Basin.  
Source: Ontario Ministry of the Environment

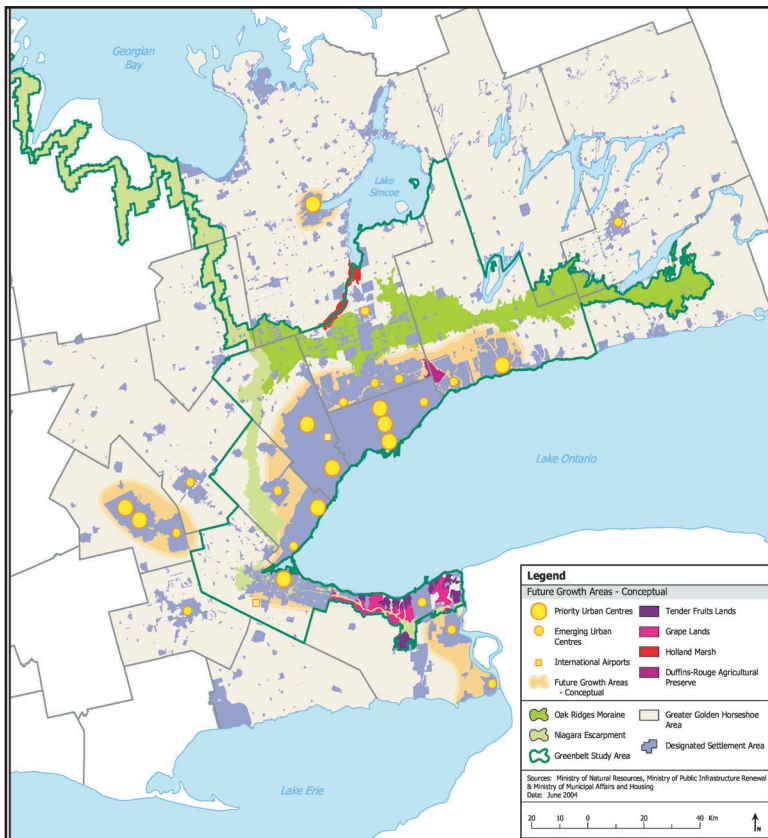
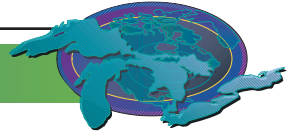


Figure 5. Proposed Areas of Future Growth in Ontario.  
Source: Ontario Ministry of the Environment



## Lake Ontario Fishery

### Assessment: Mixed, Undetermined

The assessment of Lake Ontario indicators is based on a wide variety of fishery dependent and independent field programs. These programs are delivered by several agencies including NYSDEC, OMNR, and the USGS. Offshore programs include; angler creel surveys, bottom trawling surveys, hydroacoustic assessment, gill net surveys and stocking in the lake and its tributaries. Stocking includes fry and fingerlings of salmon and trout. Salmon and trout populations are also monitored in tributaries as they return to spawn and by using angler creel surveys.

The near shore is dominated by warm water fish species and the programs used to assess them range from multi-mesh size index gillnets to bottom trawls to angler creels.

Sea lamprey are monitored by a wide variety of programs focusing primarily on larval and adult life stages. In addition, scarring rates on lake trout caused by juvenile sea lamprey are an important Great Lakes Fishery Commission abundance indicator.

### Summary of the State of the Lake Ecosystem

The offshore lake ecosystem (>15m depth) is a dynamic and a relatively less species rich with respect to the near shore. It continues to rely heavily on introduced salmonines (salmon and trout) to provide fisheries for recreational use and to act as top predators for alewife and smelt (see Salmon and trout indicator section in this report). The current salmon and trout complex remains reliant on alewife and smelt and both forage species are in mixed or deteriorating states (Figure 1 and 2). In response, the top predators, particularly Chinook salmon are showing signs of reduced weight at age (Figure 3). The pelagic salmonine species (Chinook salmon, rainbow trout (including steelhead), brown trout, and Coho salmon) continue to support a recreational fishery with a high catch per unit effort and are showing variable rates of wild reproduction in many tributaries. Thus, they are in a fair state but given the forage base, the direction they will take in the future is uncertain. Atlantic salmon restoration remains a research initiative. Size related consumption advisories for a variety of chemicals including dioxins, Mirex, PCBs exist for brown and rainbow trout, and Chinook and Coho salmon in both New York and Ontario waters of Lake Ontario and some tributaries.

Lake trout have shown signs of natural reproduction every year since 1993 but are reliant on stocking to support the recreational fishery. Survival of recently stocked lake trout is poor. Larger lake trout continue to show persistent contaminant issues related to a variety of chemicals including PCBs, dioxins and Mirex (Consumption Guidelines, Ministry of Environment 2003, NYSDEC 2002). Thus lake trout are in a mixed to poor state and their future direction is undetermined.

Sea lamprey scarring rates on lake trout have remained at or below the targeted level of 2 per 100 lake trout.

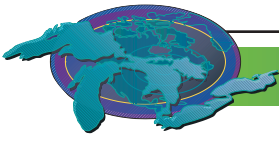
The main indicator species for the near shore is walleye. In eastern Lake Ontario including the Bay of Quinte, walleye are showing relatively stable but much reduced abundance with respect to the late 1980s (Figure 4)(see also Walleye Indicator Section in this report). They are still the number one fish species sought in the Bay of Quinte and for the first time in several years, the effort expended by anglers increased in 2003 (Figure 5). Recruitment of walleye appears to be relatively consistent in recent years. There is a wide range of age classes present in the population. However, alewife are the main prey item for walleye (especially fish older than age 5) and as such it is difficult to determine the direction they will take. Fortunately, walleye are less particular about their diet than salmonines. Consumption advisories for mercury exist for walleye greater than 23 inches total length in Ontario waters of Lake Ontario due to a difference in Health Canada and Federal Drug Administration guidelines.

### Pressures on the System

The current pressures on the ecosystem are: invasive species, continued colonization by cormorants, fishing pressure, effects of thiaminase, continued reliance on stocking, continued changes to both the near shore and off shore food web (as indicated by declines in lake whitefish, lake herring, and both slimy and deep water sculpins) and persistence of contaminants in many fish species including walleye and lake trout. These current pressures will also remain in the future however, the contaminant list may grow as new contaminants are listed (eg. PBDE fire retardants). The pressures caused by introduced salmonines and stocking are described in the Salmon and Trout indicators section (this report).

### Future and Emerging Management Issues

Future activities that could mitigate the thiaminase issue and in turn, lake trout and Atlantic salmon survival, are research and stock-



ing of ciscoes into Lake Ontario. The Lake Ontario Committee and the Great Lakes Fishery Commission have begun preliminary work into the feasibility of re-introducing ciscoes. Invasive species legislation has been introduced in Ontario and is in accord with that in New York. Amendments to the Lacey Act would also mitigate the potential for new invasive species in Lake Ontario.

There are few measures for mitigation of many of the pressures listed above.

**Acknowledgments**

Author: Bruce Morrison, Ontario Ministry of Natural Resources

**Sources of Information**

Fisheries information was provided by the New York State Department of Environmental Conservation, Ontario Ministry of Natural Resources and United States Geological Survey. Information on contaminants was provided by the Ontario Ministry of Environment and US Environmental Protection Agency.

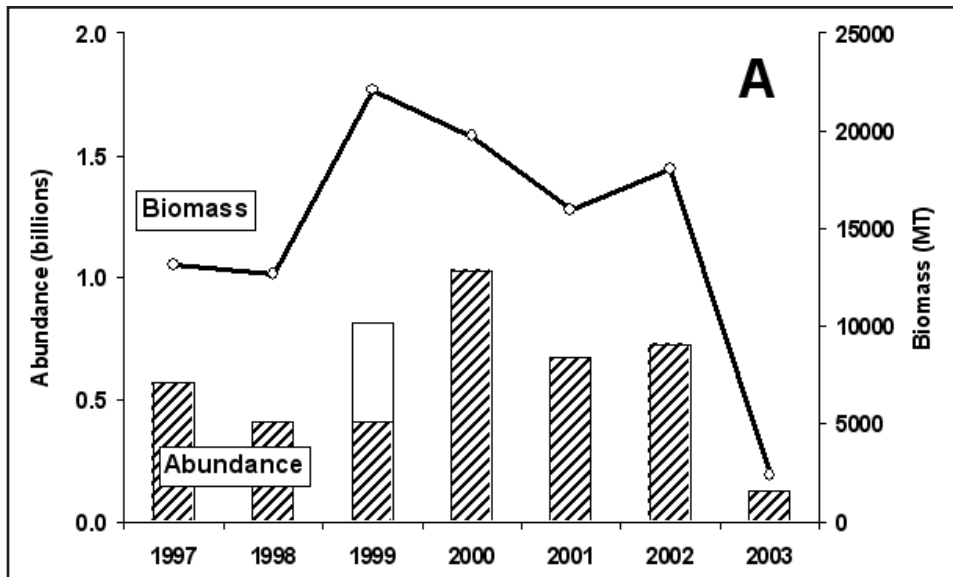
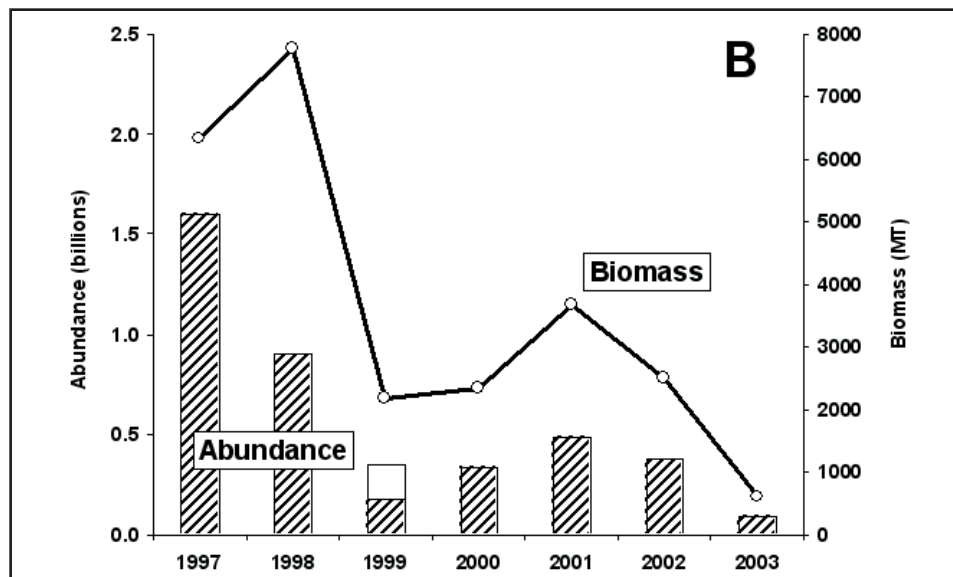


Figure 1. Abundance and biomass of yearling-and-older alewife (A) and yearling-and-older rainbow smelt (B). Abundance estimates were derived directly from hydroacoustic surveys; biomass estimates were obtained by applying average weights measured in midwater trawls to hydroacoustic abundance estimates. The abundance estimates for 1999 (dark plus light bars) was obtained by doubling the 1999 half-lake estimate (dark bar). Average weights used in biomass calculations in 2002 (alewife) and 2002 to 2003 (smelt) were based on pooled data from other years.



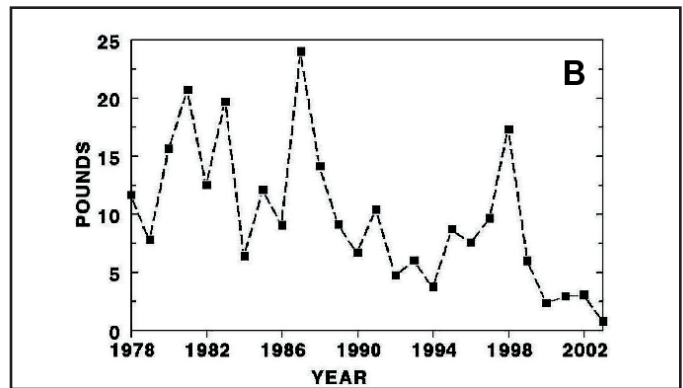
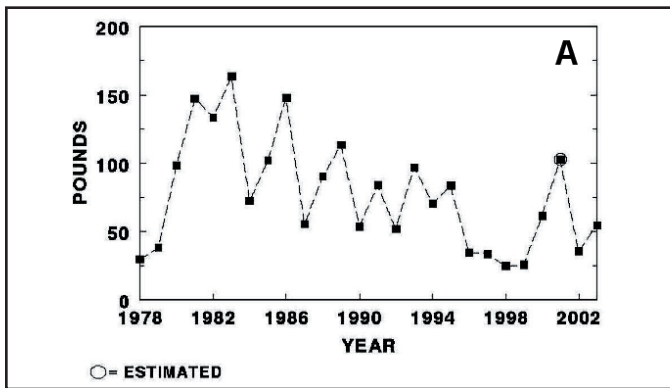
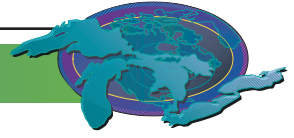


Figure 2. Stratified mean catch of adult alewives (age-2 and older) (A) in late April-early May, and rainbow smelt (age-1 and older) (B) in June, with bottom trawls in U.S. waters of Lake Ontario 1978-2003. Note: 1 lb = 0.45 kg.

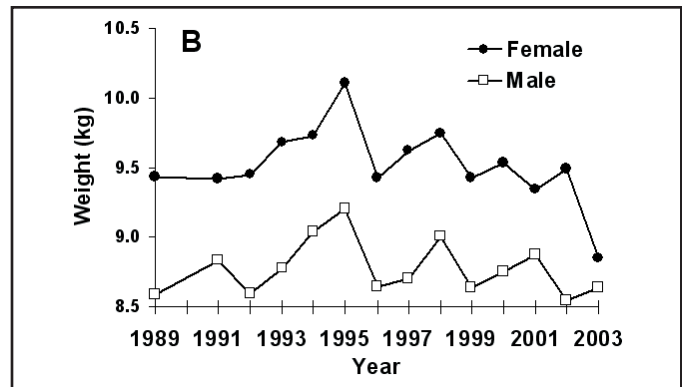
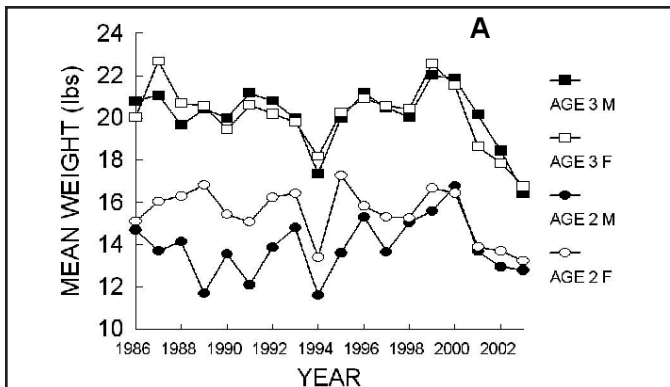


Figure 3. Time series trends of mean weight (lb) of age 2 and 3 male and female Chinook salmon in the Salmon River, New York (A) and mean weight (kg) of a 900 mm (35.4 inch) Chinook salmon in the Credit River, Ontario during the spawning run; about October 1 (B). Note: 1 lb = 0.45 kg.

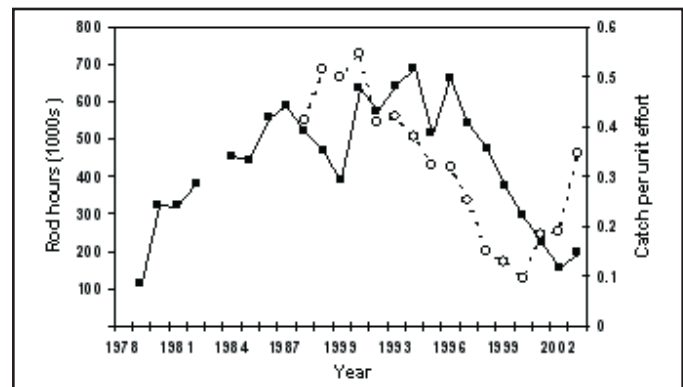
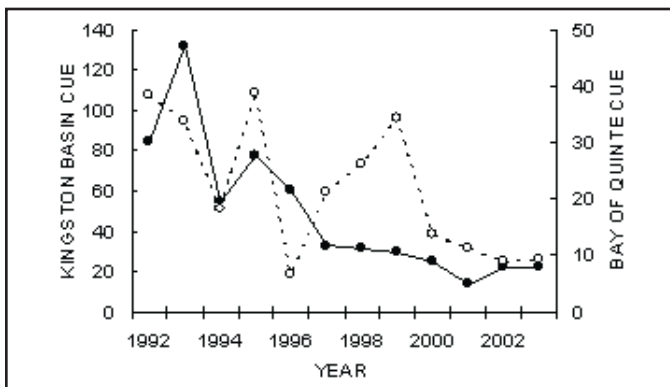
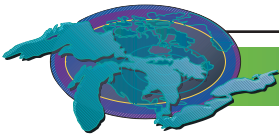


Figure 4. Catch per gillnet set (CUE) of walleye in the Bay of Quinte (closed circles) and in the Kingston Basin Lake Ontario (open circles), 1992 to 2003.

Figure 5. Angling effort (closed squares) and catch per unit effort (CUE, open circles) for walleye fishing in the Bay of Quinte, eastern Lake Ontario, 1978 to 2003.



## St. Lawrence River

**Assessment:** The status of the ecosystem is **mixed**.

Shore erosion is a natural process, but climate changes and urbanisation may exacerbate the phenomenon. On the North Shore of the Gulf of St. Lawrence, towns and villages are located in coastal plain deltas. In the absence of a continuous coastal fast ice over the last years, those geological formations have undergone strong erosion. In order to protect properties and highway infrastructure, shores have been hardened on several kilometers, and protected with additional wave breakers, with the added consequence of more severe erosion downstream of the structures.

In the Gaspésie Peninsula, the regional road is built at the bottom of erodable siltstone cliffs and is furthermore subject to flood during storm surges which exacerbate the erosion processes.

### Alterations to the hydrodynamic

There is no need to insist on the impacts brought about by the structural changes upstream of Montreal since they have so drastically and permanently modified the River from a fast water river to a lacustrine flow.

In Lake St. Pierre, prior to dredging, strong currents were limited to the channels at the head and the mouth, while a wide area at the center showed fast moving waters and weakest currents limited to the nearshore. The dredging of a 11,3 m deep and 230 m wide shipping channel has drastically changed the hydrodynamic of the Lake. The water flow is mainly restricted to the shipping channel with much reduced currents on each side, and even wider zones of weak currents by the shores. Such situation is exacerbated in years of low discharge. Important variations in water level and velocity bring about major changes in wetland plant community structures from the low marsh to the tree swamps.

### Alterations to the shoreline

From Cornwall to the downstream end of Montreal Island, some 80 % of the shores are hardened and 20 % are natural, while the reverse situation occurs in the fluvial sector, down to the outlet of Lake St. Pierre where 80 % of the shores are natural. Downstream to Quebec City, the ratio hardened/natural shores is 40:60. The most severe erosion is observed on the islands of the fluvial sector between Montreal and Lake St. Pierre; it is due mostly to navigation and overall disruption of the sediment dynamic of the system. Around Montreal Island, hardened shores due in large parts to urbanization and civil protection have resulted in major losses of wetlands and accompanying biological resources

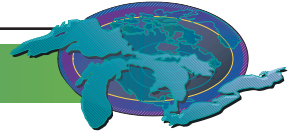
Severe coastal erosion in the St. Lawrence Estuary and Gulf due mainly to climate change will require difficult social and economical decisions in the near future. Very costly shore protection structures do not resist to winter storms threatening inhabitants in their homes and on highways.

### Alterations to habitats and biological resources

It has been demonstrated that invasion of non native species may be facilitated by man made or natural perturbations. The exponential distribution of a European race of Common Reed in the Boucherville Islands just downstream of Montreal is a good example. Very dense beds of that plant hinder the establishment and growth of naturally occurring vegetation and have further impacts on birds and fish communities and may threaten local populations.

### State of the St. Lawrence Indicators

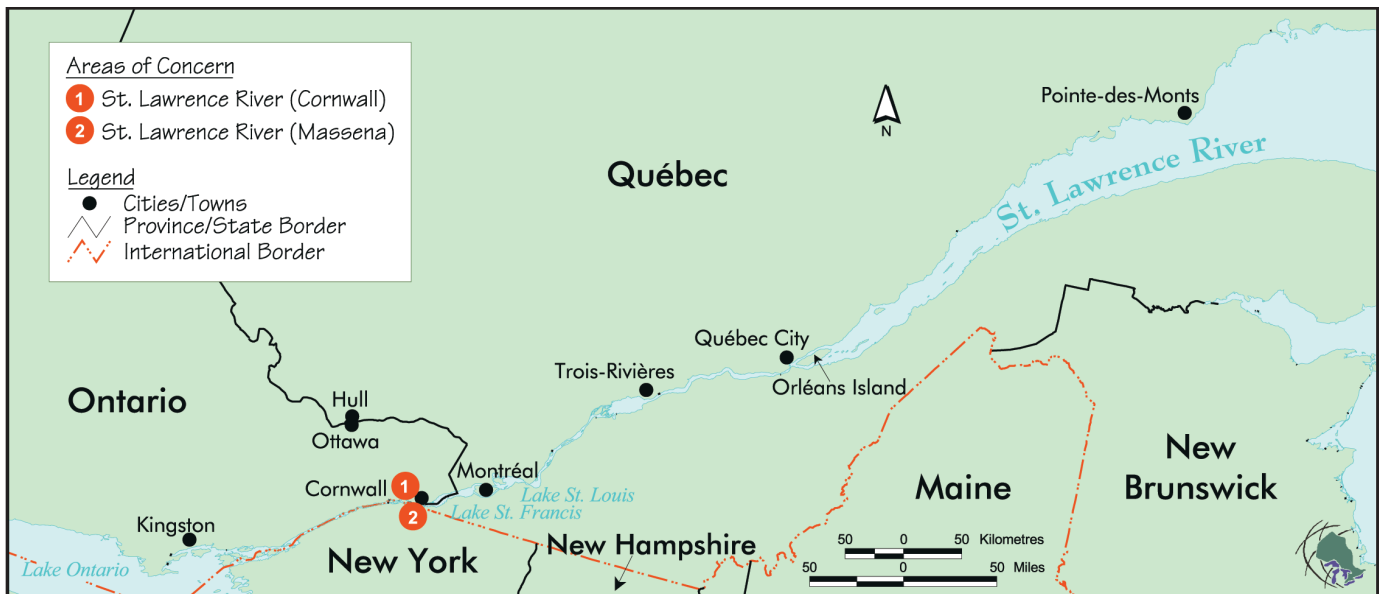
Provincial and federal governmental departments have united their expertise for the implementation of a long term environmental monitoring program. A series of indicators pertaining to water quantity and quality, sediment quality as well as diversity and condition of biological resources at the habitat, community and species level serve as a tool to assess the state of the ecosystems. Results show that since the 1970s, toxics have decreased in water, sediments and biota, some endangered animal populations have been re established or will soon be, marine organisms and fresh water fish are safe to eat and losses of wetlands have essentially disappeared. However, there

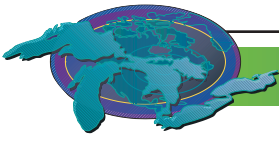


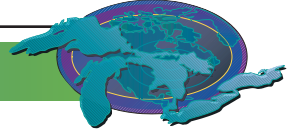
are still important concerns, such as uses restriction due to bacterial contamination, emerging toxic substances, long term and cumulative impacts of toxics and invasive species.

As it has been demonstrated here, despite the major structural modifications to its physical environment, the River still show strong resilience of its ecosystems as shown by the encouraging signals of improving environmental conditions. The strong pressures that threaten to jeopardize passed success will require all of our attention.

(Figures to be included in the final draft)







## Indicator Assessments

This section of *State of the Great Lakes 2005* provides overviews and assessments of the Great Lakes basin ecosystem based on reports for 56 of 81 indicators. These reports were prepared because data were readily available basinwide, or at least for a portion of the basin. Staff from more than 30 governmental and non-governmental entities contributed to the preparation, analysis, interpretation and assessment of data for these indicator reports.

In response to comments heard at and since SOLEC 2002 (including comments from the Indicator Review workshop held in January 2004), indicator reports have been grouped into nine categories (“bundles”) of interest. This has been done to improve the overall reporting and assessment process for determining the health of the Great Lakes basin ecosystem and its components. In some cases the categories have been further divided into sub-categories.

The categories and sub-categories are:

### **Contamination**

- Nutrients
- Toxics in Biota
- Toxics in Media
- Sources and Loadings

### **Biotic Communities**

- Fish
- Birds
- Mammals
- Amphibians
- Invertebrates
- Plants

### **Non-Native Invasive Species**

- Aquatic

### **Coastal Zones**

- Nearshore Aquatic
- Coastal Wetlands
- Terrestrial

### **Aquatic Habitats**

- Open Lakes
- Groundwater

### **Human Health**

### **Land Use-Land Cover**

- General
- Forest Lands
- Agricultural Lands
- Urban/Suburban Lands
- Protected Areas

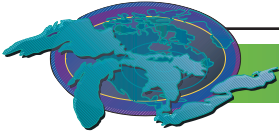
### **Resource Utilization**

### **Climate Change**

Some of these categories are under-development and will require additional indicators and subcategories to become complete. For example, the Aquatic Habitat category should be expanded to include indicators of riverine/tributary habitats as well as inland lakes. For more detailed information, including additional proposed subcategories and a listing of the indicators within each category, please see the report, *The Great Lakes Indicators Suite: Changes and Progress 2004*.

In most cases the indicator reports, which include assessments of conditions and trends, were prepared by acknowledged experts from the Great Lakes community. The same four rankings that were applied to the assessments of Lakes and Rivers in the previous section (Good, Fair, Poor, Mixed) were used to characterize each indicator assessment. The same four ecosystem trajectories





(Improving, Unchanging, Deteriorating, Undetermined) were also used. In addition to the assessment, each indicator report includes the purpose, the ecosystem objective, the state of the ecosystem, pressures and management implications.

In some cases, the indicators do not warrant a new report every two years. For these indicators (14 of them) the reports are ‘brought forward’ from a previous reporting cycle. When an indicator report has been ‘brought forward’, it is noted with the year it was prepared.

Category and sub-category overviews have also been prepared by experts from the Great Lakes community who did not author any of the indicator reports within the group. These overviews include the same ranking system and trajectories used in other sections of this report, and they also include a short justification of how the expert(s) arrived at that ranking (including pointing out gaps and inadequacies in the data).

In this section, the category and subcategory overviews are presented first, along with a listing of the indicators (and their SOLEC identification numbers) that were included in each category. Because many of the indicators are relevant to more than one category, the individual indicator reports are presented in the numeric order of their i.d. numbers following the overview discussions. This arrangement of indicators should facilitate the rapid location of any indicator report by the reader without needing to explore multiple bundles to find a particular report.



## Contaminant Assessment

### Assessment

Ecosystem Condition: Mixed

Ecosystem Trajectory: Improving

### State of the Ecosystem

Analysis of contaminant indicators suggest an overall improvement in the ecosystem from thirty years ago. There is a marked reduction in concentrations of toxics in most monitored media, and many indicator species demonstrate improvements since the beginning of Great Lakes monitoring programs. Management activities have resulted in the regulation of many sources of contaminants and, the reduction of loadings of these contaminants into the Great Lakes basin. However, although the overall health of the ecosystem shows signs of improvement, many ecosystem objectives have not been achieved.

The progress within the ecosystem is disjointed as various environmental and historical factors affect the ability for recovery. Various lakes continue to exhibit damage caused by acid rain; many indicator species still display concentrations of persistent bioaccumulative toxics above established guidelines; and, concentrations of phosphorus in areas within the Great Lakes continue to exceed targets.

Additional factors will place future pressures on the projected trajectory of the ecosystem. Future reductions in the emissions of contaminants are expected to decelerate as management efforts are offset by the by-products of population growth and urban sprawl. Global conditions, such as climate change and long range transport, will illustrate the limits in the ability of one jurisdiction to effect change in isolation. And the pervasiveness of emerging chemicals of concern, like PBDE and PCN, are raising concerns as we grow to understand their effects on the health of the ecosystem and all of its inhabitants.

### Subcategories

Nutrients: *Undetermined*

(SOLEC Indicators #111, 4860, 7061)

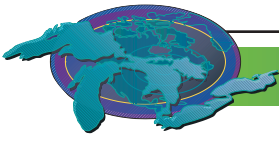
The analysis of the Nutrients subcategory is incomplete as there was insufficient information available to comment on the status of *Phosphorus and Nitrogen Levels* (SOLEC #4860) and on *Nutrient Management* (SOLEC #4860). And although an assessment was made on *Phosphorus Concentrations and Loadings* (SOLEC #111), this was not adequate for an general assessment of all the indicators in the bundle. As such, the assessment for the Nutrients subcategory is marked as *Undetermined*.

In relation to *Phosphorus Concentrations and Loadings* (SOLEC #111), analysis of total phosphorus concentrations in all five lakes suggest an overall improvement in the ecosystem from the 1970's. There has been a marked reduction in total phosphorus loadings to each of the Great Lakes since the 1970's and 1980's, with most loading calculations stopping in the early 1990s as objectives appeared to have been attained and external loadings under control at or below the target loadings for each of the Great Lakes. Management activities that brought about these reductions focused on the removal of total phosphorus inputs from municipal waste treatment plants with more than a million gallon per day discharge, the removal of soluble phosphorus laundry detergents from the market place and the control of non-point source agricultural run off through "no-till" farming practices.

Total phosphorus concentrations have decreased or held steady during this time frame in all the Great Lakes, except for Lake Erie where total phosphorus concentrations have increased during the 1990's. Loadings to Lake Erie were extended through the 1990's and showed that external loads appear to be under control and not increasing. However, there is concern that the total phosphorus concentration increases in Lake Erie are due to changes in the internal processing of phosphorus, which may have been brought on by the introduction of exotic species, such as the *Dreissena*. Thus, although the overall health of the open lake ecosystems shows signs of improvement (Lakes Michigan and Ontario) or no changes (Lakes Superior and Huron), the ecosystems objectives in Lake Erie have not been achieved.

Toxics in Biota: *Mixed, Improving*

(SOLEC Indicators #114, 115, 121, 124, 4177, 4201, 4506, 8135, 8147)



Level 1 Persistent Toxic Substances have generally declined in biota the Great Lakes basin ecosystem over the past thirty years. Levels of PCBs, DDT and other pesticides have declined dramatically since the 1970s in trout, salmon, herring gull eggs, and spot-tail shiners, however, in many cases, levels still exceed health based criteria and/or guidelines (e.g., fish advisories remain in place on all five Great Lakes, for mercury, PCBs, and various organochlorine pesticides). With regard to mercury, trend monitoring of herring gull communities and in fish generally indicate a 50% decline in mercury levels through the Great Lakes since the late 1970s. Bald eagle territories continue to recover, however, evidence of toxics related developmental deformities continue to persist.

In terms of gross ecological effects (e.g., egg shell thinning, population declines) most species have recovered, however recent measurements in more subtle physiological and genetic endpoints such as male-biased sex ratio in hatchlings, feminization in males, and suppressed immune system, indicate the need to investigate endocrine disrupting chemical effects in the basin.

Emerging contaminants such as brominated flame retardants and perflouroocatane sulfonate are have been increasing exponentially in some biota (e.g., trout, gull eggs), and other studies show similar increases in human breast milk in North American women. More work needs to be done to understand the health impacts of these emerging chemicals in the basin.

Toxics in Media: Mixed, Improving  
(SOLEC Indicators #117, 118, 119, 4202, 9000)

Overall, there has been significant progress in reducing concentrations of most chemicals of concern in the Great Lakes basin. Management efforts to control emissions inputs of critical pollutants have resulted in reductions in concentrations in the Great Lakes. Regulations in the electricity generating industry have seen success in reducing sulfur dioxide emissions, and are expected to reduce atmospheric loadings of mercury. Organochlorines are declining in offshore water samples, and in certain cases, like dieldrin, hexachlorobenzene, octachlorostyrene and mirex, have decreased in the Niagara River by 70%. Conditions now are better than they were twenty years ago, though progress has not been uniform, and differences between the lakes have resulted in some isolated areas of concern.

Legacy sources of toxics in the sediment persist in affecting water quality in areas of Lakes Ontario, Erie and Michigan. Ground level ozone and fine particulate matter remain concerns in the Great Lakes basin, and acid deposition continues to be a significant problem, with a greater environmental impact than previously thought.

Although management actions have resulted in decreased emissions of most chemicals of concern, the legacy of degraded sites, long range transport, population growth and urban sprawl will continue to affect future emission reductions. Concentrations of emerging chemicals of concern are increasing and will pose future stressors to the ecosystem as they are detected in greater and greater concentrations by Great Lakes monitoring programs.

Sources and Loadings: Mixed, Improving  
(SOLEC Indicators #117, 3515, 4202, 9000)

There has been a marked reduction in sources and loadings of contaminants into the Great Lakes ecosystem over the last thirty years. Collaboration between governments and the private sector have been largely responsible for source reductions of lead, sulfur dioxide and carbon monoxide. Many municipalities on both sides of the basin have begun to enact restrictions on the use of cosmetic pesticides, regulating a source of endocrine disruptors from the water supply. Voluntary pollution prevention activities, technology-based pollution controls, and chemical substitution have aided in the reduction of toxic substances into the Great Lakes.

While management actions have resulted in the source reductions of many chemicals of concern, there exists some isolated areas of concern. Nitrous oxide emissions project to be a major concern in combating acid deposition. Monitoring programs have seemingly detected a “leveling off” in the reduction of the concentration of PCB in air, fish and other biota. PAHs and metals continue to be emitted in large quantities, especially near large population centers.

In addition, residual sources continue to affect ambient concentrations in the ecosystem. Factors like population growth, climate change and long range transport will affect future management actions in terms of source management and loadings reductions. Emerging chemicals of concern are becoming a growing source of contaminants in the Great Lakes basin that will need to be



addressed through continued monitoring.

### Acknowledgements

Smith, Edwin (Ted). *Great Lakes National Program Office, U.S. Environmental Protection Agency*

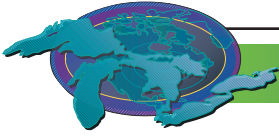
Waffle, Alan. *Environmental Protection Branch, Environment Canada*

Rockwell, David C.. *Great Lakes National Program Office, U.S. Environmental Protection Agency*

Chen-See, Oscar. *Environmental Protection Branch, Environment Canada*

### CONTAMINATION

ID #	Indicator Name	2005 Assessment
<b>Nutrients</b>		
111	Phosphorus Concentrations and Loadings	Mixed, Undetermined
7061	Nutrient Management Plans	(2002 report)
<b>Toxics in Biota</b>		
114	Contaminants in Young-of-the-Year Spottail Shiners	Mixed, Improving
115	Contaminants in Colonial Nesting Waterbirds	Mixed, Improving
121	Contaminants in Whole Fish	Mixed, Improving
124	External Anomaly Prevalence Index for Nearshore Fish	Mixed, Undetermined
4177	Biologic Markers of Human Exposure to Persistent Chemicals	Mixed, Undetermined
4201	Contaminants in Sport Fish	Mixed, Improving
4506	Contaminants in Snapping Turtle Eggs	Mixed, N/A
8135	Contaminants Affecting Productivity of Bald Eagles	Mixed, Improving
8147	Contaminants Affecting the American Otter	(2002 report)
<b>Toxics in Media</b>		
117	Atmospheric Deposition of Toxic Chemicals	Mixed, Improving & Mixed, Unchanging
118	Toxic Chemical Concentrations in Offshore Waters	Mixed, Improving
119	Concentrations of Contaminants in Sediment Cores	Mixed, Improving
4175	Drinking Water Quality	Good, Unchanging
4202	Air Quality	Mixed, Improving
9000	Acid Rain	Mixed, Improving
<b>Sources and Loadings</b>		
117	Atmospheric Deposition of Toxic Chemicals	Mixed, Improving & Mixed, Unchanging
4202	Air Quality	Mixed, Improving
9000	Acid Rain	Mixed, Improving



## Biotic Communities Assessment

### Assessment of Biological Integrity:

**Terrestrial [forests]: Improving**

**Aquatic: Open Waters: Mixed, with no obvious trajectory**

### State of the Ecosystem

#### Terrestrial:

##### Forest Cover

Total forested areas increased across the Great Lakes Basin in recent decades, a sure and positive sign that water quality might improve, along with more normal patterns of run-off. Total forest cover for Southern Ontario streams of at least 60% by area are anticipated to contribute to the restoration of much of the terrestrial, aquatic and groundwater resources in urban catchments presently with little forest-cover. Increases in total area of riparian vegetation will improve land-water interfaces in lakes and streams, as well as re-establish associated avian and mammalian species like mink and otter. Forested corridors will provide transport corridors for wildlife and the basis for trail systems for people.

#### Aquatic:

##### Invertebrates

Native benthos continues to lose ground [Lakes Erie and St Clair have lost 99%], and remaining Great Lakes populations are dispersed and fragmented. Dreissenids are a threat to native benthos and other non-native species such as the spiny waterflea continue to affect detrimentally populations of native zooplankton.

Hexagenia appears to be improving, a welcomed sign because this genus is a major energy transfer at sediment levels in mesotrophic water [e.g. L. Erie] as it feeds on organic material settling in the water column. However the group is still susceptible to releases of untreated sewage, and its relationship with the *Dreissena* spp is unknown.

The benthic amphipod, *Diporeia* is an excellent bio-indicator of offshore waters >30 m, and an excellent food source for salmonids and lake whitefish. In Lake Superior, significant reductions in populations of lake whitefish are associated with declining numbers of *Diporeia*. In Lake Huron, there has been a sequential decline in nearly all benthic invertebrates, with *Diporeia* now absent or declining at even deep [73 m] stations, while populations of the quagga mussel, *Dreissena bugensis* have increased.

Physical changes in habitat along with eutrophication continue to threaten the wetland invertebrate community by providing conditions more suitable to the production of non-native species and alterations to natural hydrographs.

##### Fish

The indicator for salmon & trout reports a mixed/improving assessment across the Basin. Lake trout stocking in Lake Huron has re-established a significant biomass, and stocking effectiveness remains high, but adequate spawning stocks [>age 6] are not yet established because predation by sea lamprey in upper and mid-lake regions may be limiting recovery. In Lake Superior in 2003, sea lamprey consumed as much biomass as was taken by all fishing activities. As well, thiamine-deficiency in salmonids caused by feeding on alewife remains problematic. In Lake Ontario, despite lower rates of stocking, chinook salmon abundance is stable, possibly because natural reproduction is contributing to higher survival rates of young fish, although the condition of the spawning chinook has deteriorated.

Walleye populations are threatened by losses of habitat for spawning and early life-stages, caused by changes in land-use, and shifts in energy-transfers caused by non-native species. Despite these negative pressures, for example, sport catch-per-unit-of-effort [CUE] for walleye in Lake Erie increased in 2003, with a concomitant increase in mean age of fish in both angling and commercial fisheries. In Lake Ontario, younger year-class numbers improved slightly, so that age 3 and older fish populations should remain steady at least for the next several years.

Preyfish populations are in various stages of deterioration especially where the bulk of the biomass has been smelt and alewife. However, the traditional forage of native species like bloater and herring is showing signs of recovery; yellow perch populations



remained high in Lake Erie.

Lake trout, the keystone species for Great Lakes oligotrophic waters is having variable success of recovery, but the trajectory is improving. For example, in Lake Ontario, lake trout reproduction was more successful in 2003 than in previous five years, two new spawning sites were found in Lake Huron, and, in the Erie Eastern Basin, 2003 was the third consecutive year with an increase for assessment catches, likely because of high survival of 1999 to 2002 fish-stockings.

However, abundance of some mature lake trout stocks continues to decline because smaller prey-fish biomasses may be limiting, and Dreissina are adversely impacting spawning shoals.

Lake sturgeon has a potential for spectacular recovery after many years of decline and extirpation in part of its range; recovery results from more restrictive fishing, habitat repair, and removal of dams on tributaries, the latter being a mixed blessing because more open streams also increases sea lamprey spawning.

Botulism E in various fish species may cause mortality. Live fish, especially gobies, and perhaps other non-native species, may be the transfer-link to waterbirds; infected fish display loss-of-equilibrium and surface-breaching, becoming more susceptible to capture by predating birds.

Non-native species remain a wild card in any recovery program.

#### Amphibians

There has been a general decline in populations of American toad and the frogs, Chorus, Green & Northern likely because of continuing losses of suitable habitats.

The value of groundwater for certain life-history stages of brook trout [and, by extension, several species of amphibians] is demonstrated by spawning surveys on a tributary to the Grand River in Southern Ontario. Uncontrolled pumping from wells and groundwater-dependant streams threaten survival and reproduction of many groundwater-dependant species. As well, urbanization affects runoff quality and reduces infiltration because of increases in hardened surfaces.

#### Birds

General decreases in wetland-dependant birds along a similar change with amphibians suggest that quality and quantity of wetlands continue to deteriorate. Some birds are also detrimentally affected by regulated water-levels. Loss of quality wetlands habitats combined with chemical levels that are potentially limiting indicates more stress and limits-to-growth for wetland bird communities. Bald eagle populations continue expansion into new territories even when deformities related to toxic substances still occur.

#### Mammals

Otters are still threatened by contaminants in food web.

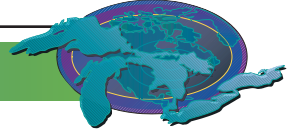
#### **Acknowledgements:**

Doug Dodge, Streambenders



**BIOTIC COMMUNITIES**

<b>ID #</b>	<b>Indicator Name</b>	<b>2005 Assessment (Status, Direction)</b>
<b>Fish</b>		
8	Salmon and Trout	Mixed, Improving
9	Walleye	Good, Unchanging
17	Preyfish Populations	Mixed, Deteriorating Mixed, Improving
93	Lake Trout	Mixed, Improving & Mixed, Unchanging
125	Status of Lake Sturgeon in the Great Lakes	Mixed, Undetermined
4502	Coastal Wetland Fish Community Health	No Assessment
<b>Birds</b>		
115	Contaminants in Colonial Nesting Waterbirds	Mixed, Improving
4507	Wetland-Dependent Bird Diversity and Abundance	Mixed, Deteriorating
8135	Contaminants Affecting Productivity of Bald Eagles	Mixed, Improving
<b>Mammals</b>		
8147	Contaminants Affecting the American Otter	(2002 report)
<b>Amphibians</b>		
4504	Coastal Wetland Amphibian Diversity and Abundance	Mixed, Deteriorating
7103	Groundwater Dependant Plant and Animal Communities	No Assessment
<b>Invertebrates</b>		
68	Native Freshwater Mussels	No Assessment
104	Benthos Diversity and Abundance	(2002 report)
116	Zooplankon Populations	(2002 report)
122	Hexagenia	Mixed, Improving
123	Abundances of the Benthic Amphipod <i>Diporeia</i>	Mixed, Deteriorating
4501	Coastal Wetland Invertebrate Community Health	No Assessment
<b>Plants</b>		
109	Phytoplankton Populations	(2002 report)
4862	Coastal Wetland Plant Community Health	Mixed, Deteriorating Mixed, Improving
8500	Forest Lands - Conservation of Biological Diversity	Mixed, Improving



## Invasive Species Assessment

### Assessment

**Ecosystem Condition:** *Mixed*

**Ecosystem Trend:** *Unchanging*

The status of invasive species in the Great Lakes is *Mixed, Unchanging* for non-native aquatic species and *Unknown* for non-native terrestrial species, based on an assessment of two indicators. Only one invasive species, sea lamprey, was assessed. The non-native species indicator is broad and has not been fully developed for terrestrial species. Additional work needs to fully develop a suite of indicators to assess impacts of invasive species for both aquatic and terrestrial habitats, including both non-native species and native species that are considered invasive. Given the limited amount of information reported on, we can expect non-native invasive species numbers to increase in both aquatic and terrestrial ecosystems. Additional research is needed to understand the biology of invasive species and their impacts on Great Lakes ecosystems.

### Aquatic: *Mixed, Unchanging*

- |   |                      |       |                    |
|---|----------------------|-------|--------------------|
| ✓ | Good/Fair, Improving | #18   | Sea Lamprey        |
| ✓ | Poor, Deteriorating  | #9002 | Non-Native Species |

In Lake Superior over the past 20 years, sea lamprey populations have fluctuated but remain at levels less than ten percent peak abundance. In Lake Michigan, the population has shown a continuing, slow trend upward since 1980. Increases are attributed to the St. Mary's River. In Lake Erie, following the completion of the first full round of stream treatment in 1987, sea lamprey populations collapsed. As a result, wounding rates on lake trout have declined. In Lake Ontario, abundance of spawning sea lamprey has shown a continuing declining trend since the early 1980s.

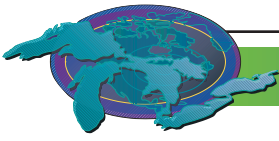
Human activities associated with shipping are responsible for over half of non-native species introductions to the Great Lakes. Total numbers of non-native species introduced and established have increased since the 1830s and the numbers of ship-introduced species have increased exponentially during the same time period. Contrary to expectations, the rate of introductions have increased following initiation of voluntary ballast management guidelines in 1989 and mandated in 1993. Recent studies indicate the Great Lakes may vary in vulnerability to invasion in space and time. Of particular concern are aquaria, garden ponds, bait fish and live food fish markets. In the United States, the Lacey Act prohibits interstate transport of some aquatic nuisance species, however, there are currently shortcomings in legal safeguards relating to commerce in exotic live fish.

The potential for sea lamprey to colonize new locations is increased with improved water quality and removal of dams. Any areas newly infested with sea lamprey will require some form of control. Non-native species have been introduced to the Great Lakes from around the world and increasing world trade and travel will elevate the risk that new species will continue to gain access to aquatic ecosystems. Existing diversions of water into the Great Lakes such as the Chicago Sanitary and Ship Canal, and growth of industries such as aquaculture, live food markets, and aquarium retail stores will also increase the risk that species will continue to be introduced. Changes in water quality, global climate change, and previous introductions may make the Great Lakes more hospitable for the establishment of new invaders.

The Great Lakes Fishery Commission has increased stream treatments and lampricide applications in response to increasing abundances during 2001 through 2004. The Commission is continuing to focus efforts on research and development of alternative control strategies. Computer models are being used to best allocate treatment resources. Targeted increases in lampricide treatments are predicted to reduce sea lamprey to acceptable levels. Efforts to identify all sources of sea lamprey need to continue. In addition, research to understand lamprey/prey interactions and population dynamics that survive control actions are needed to maintain populations at tolerable levels.

Researchers are studying the links between vectors and donor regions, the receptivity of the Great Lakes ecosystem, and the biology of new invaders in order to make recommendations to reduce the risk of future invasions. Without measures that effectively eliminate or minimize the role of ship-borne and other emerging vectors, we can expect the number of non-native species in the Great Lakes to continue to rise, with an associated loss of native biodiversity and an increase in unpredicted ecological disruptions.





**Terrestrial: *Unknown***

✓ Unknown #9002 Non-Native Species

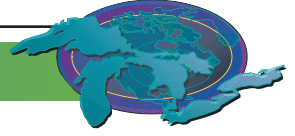
Only a small percentage of non-native species introduced to terrestrial ecosystems pose human health, environmental, or economic hazards. Lack of naturally occurring predators, however, allows some non-native species to become invasive by colonizing and proliferating unchecked. Invasive non-native species destroy wildlife habitats, crowd out competitors and depletes prey, thereby threatening biodiversity. The negative impact of a wide range of non-native species, such as reed canary grass, garlic mustard, common buckthorn, and purple loosestrife, has been documented throughout the Great Lakes basin. However, the extent of invasion by terrestrial non-native species is not known. Growth and trade and travel increases the risk that a larger number of terrestrial non-native species will become established in the Great Lakes region. Agencies and organizations are actively collecting data on terrestrial non-native species. Most projects focus on single species on a local basis, however, Wisconsin has organized an invasive species task force that is setting priorities for prevention, control, and education. The Nature Conservancy is working across the basin to formulate a protocol for tracking invasive, non-native terrestrial species.

**Author**

U.S. Environmental Protection Agency: Karen Rodriguez

**INVASIVE SPECIES**

<b>ID #</b>	<b>Indicator Name</b>	<b>2005 Assessment (Status, Direction)</b>
<b>Aquatic</b>		
18	Sea Lamprey	Good-Fair, Improving
9002	Non-Native Species (Aquatic)	Poor, Deteriorating



## Coastal Zone Bundle

### Assessment

**Ecosystem Condition: *Mixed***

**Ecosystem Trend: *Deteriorating***

The Great Lakes Coastal Zone, comprised of nearshore aquatic, coastal wetland, and nearshore terrestrial habitats, is considered *Mixed, Deteriorating*, based on an assessment of eleven indicators that assessed physical, chemical, and biological conditions. The nearshore aquatic is considered *Mixed, Deteriorating* because of continued shoreline hardening. One indicator, however, is inadequate to properly understand the status of this complex area. Coastal wetlands have recently been classified and mapped by the Great Lakes Coastal Wetlands Consortium. The Consortium assessed eight indicators and concluded the status of coastal wetlands is *Mixed, Deteriorating* due to continued anthropogenic pressures that include habitat loss and degradation, non-indigenous species, and contamination. The nearshore terrestrial zone is considered *Mixed, Deteriorating/Undetermined* as a result of the evaluation of the continued degraded condition of sand dunes and beaches, rocky shores and alvars.

Although progress is being made in setting up a long term monitoring program for coastal wetlands, and collaborators are working basinwide to better understand both nearshore aquatic and terrestrial ecosystems, much work is yet to be done to get to a point where indicators are meaningful in assessing ecosystem status. Clearly, the work of the last couple of years by coastal wetlands and islands scientists and managers has led to an appreciation of the roles of these habitats in maintaining water quality and ecosystem health.

### Nearshore Aquatic: *Mixed, Deteriorating*

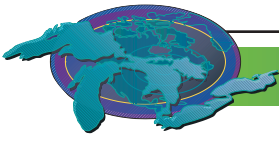
	Not Reported	#6	Fish Habitat
✓	Mixed, Deteriorating	#8131	Extent of Hardened Shoreline ( <i>from the SOLEC 2000 report</i> )
	Not Reported	#8142	Sediment Available for Coastal Nourishment
	Not Reported	#8146	Artificial Coastal Structures
	Not Reported	#4860	Phosphorus and Nitrogen Levels
	Not Reported	#new	Human Impact Measures

Shoreline hardening is the construction of sheet piling, rip rap, or other erosion control structures. Shoreline hardening will continue to impact additional stretches of shoreline aquatic habitats, especially during periods of high Lake levels. The hardening will starve the down-current areas of sediment to replenish that which eroded away, causing further erosion and providing further incentive for additional hardening. The effect is the destruction of habitat and the disruption of shoreline sediment transport needed to nourish aquatic habitats. The St. Clair, Detroit and Niagara Rivers have a higher percentage of their shorelines hardened than anywhere else in the basin. Of the Lakes themselves, Lake Erie has the highest percentage of its shoreline hardened, and Lakes Huron and Superior have the lowest. Shoreline hardening directly destroys natural features and aquatic habitats and disrupts biological communities that depend upon the transport of shoreline sediment by lake currents.

Recognizing the need for a better suite of indicators and for information about the nearshore aquatic coastal zone in general, the Great Lakes Fishery Trust, Great Lakes Fisheries Commission, and U.S. Environmental Protection Agency, Great Lakes National Program Office will be working together to synthesize information regarding the status of research and management techniques that address inventory, assessment, and protection and restoration of Great Lakes nearshore habitats.

### Coastal Wetlands: *Mixed, Deteriorating*

✓	Mixed, Undetermined	#4501	Invertebrate Community Health
✓	Mixed, Undetermined	#4502	Fish Community Health
✓	Mixed, Deteriorating	#4504	Amphibian Diversity and Abundance
✓	Mixed, Unchanging	#4506	Contaminant Accumulation (Snapping Turtle Eggs)
✓	Mixed, Deteriorating	#4507	Bird Community Diversity and Abundance
✓	Mixed, Deteriorating	#4510	Coastal Wetland Area by Type
	Not Reported	#4511	Coastal Wetland Restored Area by Type
	Not Reported	#4860	Phosphorus and Nitrogen Levels
✓	Mixed, Undetermined	#4861	Effect of Water Level Fluctuations ( <i>from the SOLEC 2002 report</i> )

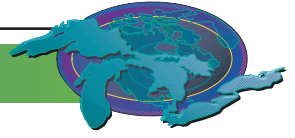


- ✓ Mixed, Deteriorating
- Not Reported
- Not Reported
- Not Reported
- #new Plant Community Health
- #new Sediment Flow and Availability
- #new Land Cover Adjacent to Coastal Wetlands
- #new Human Impact Measures

Wetlands continue to be lost and degraded, yet the ability to track and determine the extent and rate of this loss in a standardized way is not yet feasible. Coastal wetlands totaling 216,545 ha have been identified within the Great Lakes and connecting rivers up to Cornwall, Ontario. Despite significant loss of coastal wetland habitat in some regions of the Great Lakes, the lakes and connecting rivers still support a diversity of wetland types. Barrier protected coastal wetlands are a prominent feature in the upper Great Lakes, accounting for over 50,000 ha of the identified coastal wetland area in Superior, Huron and Michigan. Lake Erie supports 25,127 ha of coastal wetland with protected embayment wetlands accounting for over one third of the total area. In Lake Ontario, barrier protected and drowned rivermouth coastal wetlands account for 14,164 ha, approximately two thirds of the total coastal wetland area. The St. Clair River delta occurs where the St. Clair River outlets into Lake St. Clair and is the most prominent single wetland feature accounting for over 13,000 ha. The Upper St. Lawrence River also supports a large area of wetland habitats that are typically numerous small embayment and drowned rivermouth wetlands associated with the Thousand Island region and St. Lawrence River shoreline. However, due to existing data limitations, estimates of coastal wetland extent, particularly for the upper Great Lakes, are acknowledged to be incomplete.

Recent research has determined that wetland invertebrate communities of Northern Lakes Michigan and Huron generally produced the highest Index of Biotic Integrity (IBI) scores. In the drowned river mouth wetlands of eastern Lake Michigan, invertebrate communities show a linear relationship with latitude that reflects anthropogenic disturbances. In studies in the Upper Great Lakes it was concluded that natural water level changes were likely to alter communities and invalidate IBI metrics. The composition of fish communities is significantly related to plant community type within wetlands and, within plant community type, is related to amount of anthropogenic disturbance. There is no data to suggest that fish communities of any single Great Lake are more impacted than any other. However, of the 61 wetlands sampled in 2002 from all five lakes, Lakes Erie and Ontario tended to have more wetlands containing cattail communities (a plant community type that correlates with nutrient enrichment). The fish communities found in cattails tended to have lower richness and diversity than fish communities found in other vegetation types. Wetlands found in northern Lakes Michigan and Huron tended to have relatively high quality coastal wetland fish communities. Trends in amphibian occurrence were assessed for eight species commonly detected on Marsh Monitoring Program routes (469 routes throughout the Great Lakes basin). Statistically significant declines in occurrence trends were detected for the American Toad, Chorus Frog, Green Frog, and Northern Leopard Frog. Further data are required to conclude whether Great Lakes wetlands are successfully sustaining amphibian populations. From 1995 through 2002, 53 species of birds that use marshes for feeding, nesting or both were recorded by Marsh Monitoring Program volunteers at 419 routes throughout the Great Lakes basin. Tree Swallows and Barn Swallows were the most common species that typically feed in the air above marshes. The Red-winged Blackbird was the most commonly recorded marsh nesting species, followed by Swamp Sparrow, Common Yellowthroat and Yellow Warbler. Species with significant basinwide declines were the Least Bittern, Black Tern, Marsh Wren, undifferentiated American Coot/Common Moorhen (their calls are difficult to distinguish), Pied-billed Grebe, Red-winged Blackbird, and Virginia Rail. Statistically significant basinwide population increases were observed for the Willow Flycatcher, Common Yellowthroat, and Mallard. In the coastal wetlands of Lakes Erie, Michigan, and Huron, population trends of the American Coot, Least Bittern, Marsh Wren, Pied-billed Grebe, Sora, Swamp Sparrow, and Virginia Rail were positively correlated with water levels, and thus, seemed to track fluctuations in Great Lakes water levels. Differences in habitats, regional population densities, timing of survey visits, annual weather variability, and other additional factors likely interplay with water levels to explain variation in species-specific bird populations.

The state of coastal wetland plant communities is quite variable across the Great Lakes basin. And trends in wetland health based on plants is not well established. However, there is evidence that the plant component in some wetlands is deteriorating in response to extremely low water levels, but this deterioration is not seen in all wetlands. In general, there is slow deterioration in many wetlands as shoreline alterations introduce exotic species. On the other hand, the turbidity of the southern Great Lakes has reduced with expansion of zebra mussels, resulting in improved submergent plant diversity in many wetlands. Long-term high-low water level fluctuation puts natural stress on coastal wetlands that is vital in maintaining wetland diversity. During periods of high water levels, there is a die-off of vegetation that cannot tolerate long periods of high water. At the same time, there is an expansion of aquatic communities into the newly inundated area. During periods of low water, woody plants and emergents expand again to reclaim their former area as aquatic communities establish themselves further outward into the Lake. Because Lake Superior is at the upper end of



the watershed, the fluctuations there have less amplitude than in the other Lakes. Lake Ontario showed these quasi-periodic fluctuations but the amplitude has been eliminated since the Lake level began to be regulated in 1959. The consequence for Lake Ontario is that coastal wetlands occupy a narrower zone with fewer species.

Although not basinwide, available data indicate both a decline in contaminants in Snapping Turtles and contaminants that continue to exceed guidelines. Twenty years of monitoring by the Canadian Wildlife Service (CWS) indicates that contaminants in Snapping Turtle eggs change over time and among sites, with significant differences between contaminated and reference sites. Rates of abnormal development of Snapping Turtle eggs from 1986-1991 were highest at all four Lake Ontario sites compared to other sites studied. Mean sum PCBs varied considerably throughout the lower Great Lakes, ranging from 0.02 µg/g at Algonquin Park (reference site) to 1.76 µg/g at Hamilton Harbour (Grindstone Creek). Sum PCB levels were highest at Hamilton Harbour (Grindstone Creek), followed by the second site at Hamilton Harbour (Cootes Paradise), then Lyons Creek (Niagara River) and Turkey Creek (Detroit River). However, there is evidence that PCB levels in Snapping Turtle eggs have been declining at the inland reference site of Algonquin Park (1981 – 2003) and the heavily contaminated Hamilton Harbour AOC (1984 to 2003).

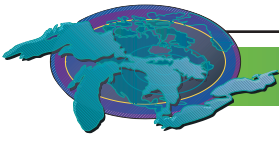
Many coastal and inland Great Lakes wetlands are at the lowest elevations in watersheds that support very intensive industrial, agricultural and residential development, and therefore are under pressure through polluted inflow received from their watersheds. Even more subtle impacts such as water level stabilization, sedimentation, contaminant and nutrient inputs, climate change, and invasion of exotic species continue to degrade wetlands across the Great Lakes region. In particular, physical alteration and eutrophication of wetland ecosystems continue to be a threat to invertebrates of Great Lakes coastal wetlands. Based on intensive fish sampling at more than 60 sites spanning all the Great Lakes, the exotic fish round goby has not been sampled in large numbers at any wetland or been a dominant member of any wetland fish community. Likewise, the exotic ruffe has never been found in high densities in coastal wetlands anywhere in the Great Lakes. It seems likely that wetlands may be a refuge for native fishes, at least with respect to the influence of certain invasive fish species. There have been a number of carp introductions that have the potential for substantial impact on Great Lakes fish communities, however. These species are a threat to food webs in wetlands and nearshore habitats with macrophytes.

Intact, diverse wetlands can be found for most geomorphic wetland types although low water levels have resulted in the almost explosive expansion of reed canary grass (*Phalaris arundinacea*) in many wetlands, especially in Lake St. Clair and southern Lake Huron. One disturbing trend is the expansion of frog bit, a floating plant that forms dense mats capable of eliminating submergent plants, from the St. Lawrence River and Lake Ontario westward into Lake Erie. In addition to exotic species, other pressures on wetland plants leading to the degradation of coastal wetlands include agricultural runoff, urban development, residential shoreline development, mechanical alteration of the shoreline.

There is a need to address more subtle impacts that are detrimental to wetland health, such as inputs of toxic chemicals, nutrients and sediments. Currently there are limited examples of the effects of changing management on plant composition, for example, where even slight levels of nutrient enrichment cause dramatic increases in submergent plant coverage. So for most urban areas, it may prove impossible to adequately reduce nutrient loads sufficiently in order to restore native aquatic vegetation. Contaminants in Snapping Turtles are persistent and bioaccumulative, with diet being the primary source of exposure. Thus, the contamination observed in the turtle eggs is present throughout the entire food web. Future withdrawals or diversions of water from the Lakes represent a potential pressure on the ecosystem. Additional regulation of high and low water levels will impact water levels. Global warming has the potential to alter water levels as well.

#### Nearshore Terrestrial: *Mixed, Deteriorating/Undetermined*

- |   |                      |  |
|---|----------------------|--|
| ✓ | Mixed, Undetermined  | #4861 Effect of Water Level Fluctuations ( <i>from the SOLEC 2002 report</i> ) |
| ✓ | Mixed, Deteriorating | #8131 Extent of Hardened Shoreline ( <i>from the SOLEC 2000 report</i> )       |
|   | Not Reported         | #8132 Nearshore Land Use   |
|   | Not Reported         | #8136 Extent and Quality of Nearshore Natural Land Cover                       |
|   | Not Reported         | #8137 Nearshore Species Diversity and Stability                                |
|   | Not Reported         | #8142 Sediment Available for Coastal Nourishment                               |
| ✓ |                      | #8149 Protected Nearshore Areas  |
|   | Not Assessed         | #8129 Islands  |
| ✓ | Mixed, Deteriorating | #8129 Sand Dunes and Beaches   |



- ✓ Mixed, Deteriorating #8129 Rocky Shores
- ✓ Mixed, Undetermined #8129 Alvars (*from the SOLEC 2000 report*)
- Not Reported #new Human Impact Measures

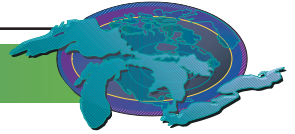
Great Lakes sand dunes comprise the world's largest collection of freshwater dunes. Approximately 131,546 ha of sand dunes can be found along the coasts of all the Great Lakes. Lake Michigan has the greatest number with a total of 111,291 ha, followed by Ontario with 8,910 ha, Indiana with 6,070 ha, New York with 4,850 ha, and Wisconsin with 425 ha. This information is not complete. No comprehensive map of Great Lakes sand dunes exists. Cobble beaches comprise an estimated 1,019 miles of the Great Lakes shoreline. This shoreline is decreasing, however, due to shoreline development. Alvar communities are naturally open habitats occurring on flat limestone bedrock. More than 90 percent of the world's alvars occur in the Great Lakes. More than 90 percent of the original extent of alvar habitats has been destroyed or substantially degraded. Approximately 64 percent of the remaining alvar area exists in Ontario. Less than 20 percent of the nearshore alvar acreage is currently fully protected and 60 percent is at high risk. The Great Lakes contain the world's largest freshwater island system and are globally significant in terms of their biological diversity. New research indicates that nearshore island areas in the Ontario waters of Lake Huron account for 58 percent of the fish spawning and nursery habitat and are thus critically important to the Great Lakes fishery.

There is a continued loss of sand dunes to development, sand mining, recreational trampling, and non-indigenous invasive species. Loss of sediment transport due to shoreline hardening is also a major pressure. Cobble beaches are most frequently threatened and lost by shoreline development. Homes and increased human activity are resulting in damage to rare plants and a loss of biodiversity. Continuing pressures on alvars include habitat fragmentation and loss, off-road vehicles, and resource extraction. Proposals to develop islands are increasing. In addition to development, island pressures include shoreline modification, non-indigenous, invasive species, agriculture and forestry practices, and contamination.

A group of sand dune managers and scientists is organizing to convene a conference for all persons involved in Great Lakes sand dune ecosystem ecology, management, research and education efforts. The purposes of the conference will be to compile information about sand dunes and sand dune research and management and to form the Great Lakes Sand Dune Coalition. Not much research has been done on cobble beach communities; therefore, no baseline data has been set. A closer look into the percentage of cobble beaches that already have homes on them or are plotted for development would yield a more accurate trend. Protection of alvars has focused on best quality sites. Ten securement projects over the last several years have resulted in the protection of more than 5,000 acres across the Great Lakes basin. The Great Lakes Islands Collaborative will soon recommend management strategies on Great Lakes islands to preserve the unique ecological features that make islands so important. In addition, based on a proposed threat assessment to be completed in 2005, the Collaborative will recommend management strategies to reduce the pressures on a set of priority islands areas. A suite of indicators that can be monitored to assess change, threats, and progress towards conservation of Great Lakes islands biodiversity is being developed by the Collaborative. Three indicators are currently proposed.

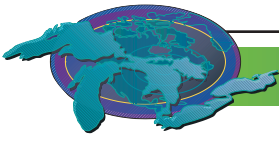
**Authors:**

U.S. Environmental Protection Agency: Karen Rodriguez  
Great Lakes Commission: Ric Lawson



## COASTAL ZONES

ID #	Indicator Name	2005 Assessment (Status, Direction)
<b>Nearshore Aquatic</b>		
4861	Effects of Water Levels Fluctuations	(2002 report)
8131	Extent of Hardened Shoreline	(2000 report)
<b>Coastal Wetlands</b>		
4501	Coastal Wetland Invertebrate Community Health	No Assessment
4502	Coastal Wetland Fish Community Health	No Assessment
4504	Coastal Wetland Amphibian Diversity and Abundance	Mixed, Deteriorating
4506	Contaminants in Snapping Turtle Eggs	Mixed, N/A
4507	Wetland-Dependent Bird Diversity and Abundance	Mixed, Deteriorating
4510	Coastal Wetland Area by Type	Mixed, Deteriorating
4861	Effects of Water Levels Fluctuations	(2002 report)
4862	Coastal Wetland Plant Community Health	Mixed, Deteriorating Mixed, Improving
<b>Terrestrial</b>		
4861	Effects of Water Levels Fluctuations	(2002 report)
8129	Area, Quality, and Protection of Special Lakeshore Communities - Cobble Beaches	Mixed, Deteriorating
8129	Area, Quality, and Protection of Special Lakeshore Communities - Alvars	(2000 report)
8131	Extent of Hardened Shoreline	(2000 report)



## Aquatic Habitats Assessment

The overall assessment for this bundle was not available at the time of this report preparation. Included here is the assessment for the Groundwater sub-bundle.

## Assessment of Groundwater Indicators

Four indicators to assess the state of groundwater resources in the Great Lakes watershed have been accepted for SOLEC 2004. They are: 1) base flow due to groundwater discharge, 2) natural and human induced groundwater quality, 3) groundwater and land use and intensity, and 4) groundwater dependent plant and animal communities. Because these four groundwater indicators are new to the SOLEC process, indicator reports for the entire Great Lakes watershed are currently available only for the base flow indicator and the authors of this report state that more analyses are needed to verify the conclusions of the report. Three indicator reports were written for the Grand River watershed in Ontario. The authors of these reports state that their conclusions may not apply to the entire Great Lakes watershed. In spite of these limitations, the four indicators written for the 2004 SOLEC, when combined with other groundwater information in the Great Lakes, make a good case for *an overall evaluation of groundwater resources in the Great Lakes to be mixed/deteriorating*.

### Base Flow Due to Groundwater Discharge

The discharge of groundwater to surface-water features is the endpoint for nearly all of the water that is recharged to the groundwater system. This discharge to streams, wetlands, and lakes generally provides good quality water that, in turn, promotes habitat for aquatic plants and animals and sustains them during periods of low precipitation. Human activities impact groundwater discharge by modifying the rates of discharge and the quality of the discharging water. The effects of urban development and agricultural practices are beginning to be documented by analysis of stream-flow information. However, because of the slow movement of groundwater, the effects of surface activities and groundwater withdrawal on groundwater resources can sometimes take years to manifest themselves. Therefore, it is important to continually update the current analyses and to search for new ways to evaluate information about base flow to better quantify the effects of human activities on this component of stream flow that is critical for healthy ecosystems.

### Natural and Human Induced Groundwater Quality

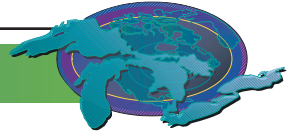
The quality of groundwater is particularly important when it is the source of drinking water, but quality is also a critical component for ecosystem function. Groundwater quality can be degraded both from human-caused and natural sources. Considerable progress has been achieved in reducing and cleaning up point sources of human-caused groundwater contamination. Non-point sources of contamination that affect groundwater quality have not been addressed as effectively. In addition, the fact that groundwater generally moves slowly from the time it is recharged until it is discharged often creates a delay in the awareness of impaired groundwater quality. Although the 2004 SOLEC indicator report for groundwater quality was specifically written for the Grand River watershed in Ontario, similar conclusions about groundwater quality have been reached as a result of regional water-quality studies in the Lake Erie – Lake St. Clair and the western Lake Michigan watersheds in the United States. These types of studies have not been conducted for the entire Great Lakes watershed. It should also be noted that nearly the entire fresh groundwater resource in the Great Lakes region is underlain by naturally occurring saline groundwater and, therefore, simply drilling deeper wells is not a solution for most groundwater quality problems.

### Groundwater and Land Use and Intensity

Understanding the impact of water use on groundwater resources in the Great Lakes watershed will require a better understanding of how much water is available and how much is needed for maintaining healthy ecosystems and providing for sustained human uses. The conclusions for the Grand River watershed that more consistent and improved monitoring and data collection are needed to accurately estimate groundwater demand as well as determine long-term trends in land use is also accurate for nearly the entire Great Lakes watershed. Better analysis of the amount of groundwater that is consumptively used is an especially important need.

### Groundwater Dependent Plant and Animal Communities

The relationship between groundwater discharge to streams and aquatic habitat has long been noted but rarely quantified. As human activities increasingly cause changes in both the quantity and quality of groundwater discharging to streams, the need for a better



understanding of this relationship needs to be promoted. The indicator report for the Grand River watershed is an excellent example of how to promote this relationship. Similar work is being conducted in the United States as part of a Great Lakes Aquatic Gap Project. However, these are only the beginning steps in quantifying the effects of human activities on ecosystem function as it relates to groundwater discharge to streams.

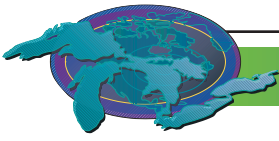
**Acknowledgements:**

Norman Grannemann, U.S. Geologic Survey

**AQUATIC HABITATS**

<b>ID #</b>	<b>Indicator Name</b>	<b>2005 Assessment (Status, Direction)</b>
<b>Open Lake</b>		
111	Phosphorus Concentrations and Loadings	Mixed
118	Toxic Chemical Concentrations in Offshore Waters	Mixed, Improving
119	Concentrations of Contaminants in Sediment Cores	Mixed, Improving
8131	Extent of Hardened Shoreline	(2000 report)
<b>Groundwater</b>		
7100	Natural Groundwater Quality and Human-Induced Changes	No Assessment
7101	Groundwater and Land: Use and Intensity	No Assessment
7102	Base Flow Due to Groundwater Discharge	Mixed, Deteriorating
7103	Groundwater Dependiant Animal and Plant Communities	No Assessment





## Human Health Assessment

### Assessment

Ecosystem Condition: Mixed

Ecosystem Trajectory: Generally Improving

### State of the Ecosystem

The Great Lake indicators for human health are generally improving. Due to the wide range of public health indicator topics, it is difficult to assign a specific ecosystem trajectory that is applicable to all topics. PCBs in fish continue to decline, biological markers of human exposure are better assessed, progress is being made in reducing air pollution, beaches are better assessed and more frequently monitored, and drinking water quality continues to be good.

Assessment of health indicators has improved over the past 20 years. However, a greater understanding of human health and environmental interaction is needed. For example, the relationship between environmental exposures and biological markers in humans and beach advisories, postings and closures tend to have complex issues that warrant more research. Monitoring of these issues needs to be continued and enhanced.

### Contaminant in Sport Fish (Indicator #4201) - Assessment Mixed Improving

Since the 1970's there have been declines in many persistent bioaccumulative toxic (PBT) chemicals in the Great Lakes basin. Once such chemical, PCBs, is analyzed in coho salmon to better understand potential human exposure and general, temporal trends. While the data collected in coho salmon in the Great Lakes shows that concentrations of the contaminants are generally decreasing, other contaminants, such as mercury and PBDE, will need to be better understood through improved monitoring and risk analysis. State, Tribe, and Federal fish consumption advisories are important for protecting the public, especially sensitive populations, from exposure to contaminants in fish. Enhanced partnerships between the parties involved in issuing advisories will improve both commercial and sport fish consumption advisory programs.

### Air Quality (Indicator #4176) - Assessment Mixed Improving

Overall, there has been significant progress in reducing air pollution in the Great Lakes basin. In general there has been a reduction of urban/local pollutants over the past decade, though there are a few remaining problems districts. Regional pollutants such as, ground-level ozone and fine particulates remain a concern in the Great Lakes basin, especially in the Detroit-Windsor-Ottawa corridor, the Lake Michigan basin, and the Buffalo-Niagara area. Air quality will be further impacted by population growth and climate change. Continuing health research is both broadening the number of identified toxins and producing evidence that existing standards should be lowered.

### Biological Markers of Human Exposure to Persistent Chemicals (Indicator #4177) - Assessment Mixed Undetermined

There are several studies underway in the Great Lakes basin evaluating the connection between fish consumption and chemical exposure. Some of these studies go further and evaluate the potential of harmful health effects from chemical exposure. Two studies were evaluated as part of this indicator. The first study, completed by Wisconsin Department of Health and Family Services, analyzed the level of bioaccumulation toxic chemicals found in sensitive populations in the Great Lakes basin. Based on this analysis, it appears that there is a correlation between hair mercury levels and the number of fish meals consumed over three months. In the EAGLE Project (Effects on Aboriginals of the Great Lakes), the effects of contaminants on the health of the Great Lakes aboriginal population was examined and results of this study indicated that contaminant levels were found to be below or within the range of other Canadian health Studies completed in the Great Lakes basin. The Agency for Toxic Substances and Disease Registry (ATSDR) established the Great Lakes Human Health Effects Research Program through legislative mandate in 1992. This program is tasked with assessing critical pollutants of concern, identifying vulnerable and sensitive populations, prioritizing areas of research and funding research projects within the Great Lakes and many of their research projects are highlighted in the indicator report.

Continued coordination between governments and researchers should continue. In addition, a gap analysis of biomarker studies in the Great Lakes basin should be conducted.

### Beach Advisories, Postings and Closures (Indicator #4200) - Assessment Mixed Undetermined

Bacterial count in nearshore water is one of the most important indicators to determine if health-related closings, postings and advi-



sories at beaches are needed. Recreational waters may become contaminated with animal and human feces from sources and conditions such as combined sewer overflows (CSO) and sanitary sewer overflows (SSO), malfunctioning septic systems and poor live stock management practices. States, tribes and provinces are continuing to identify and improve remediation measures to reduce the number of closings, postings and advisories at beaches. Trends in the US and Canada show that as the frequency of monitoring and reporting increase, more advisories, posting and closures are observed. Data collected at some beaches in the basin are using their monitoring data, in addition to meteorologic, and other information along with computer modeling to better forecast beach closures.

#### **Drinking Water Quality (SOLEC Indicator #4175) - Assessment Good Unchanging**

There are several Great Lakes Basin sources of drinking water for tap water including lakes, rivers, streams, ponds, reservoirs, springs, and wells. Water traveling over the surface of the land or through the ground is vulnerable to contamination by naturally occurring minerals, substances resulting from animals or anthropogenic activity, and in some instances, radioactive material. U.S. and Canadian finished water and Canadian raw water was evaluated for this report and originated from many water sources in the Great Lakes basin including Lake Erie, Lake Huron, Lake Michigan (US only), Lake Ontario, Lake Superior, rivers, small lakes/reservoirs, and groundwater. Ten drinking water parameters were chosen to provide the best pictures of drinking water quality in the Great Lakes Basin, including several chemical parameters, microbiological parameters, and other indicators of potential health hazards.

The quality of finished drinking water in the Great Lakes basin is good based on the information provided by the Ontario Ministry of the Environment and data collected as part of the Canadian Drinking Water Surveillance Program, in addition to information gathered from 2002 and 2003 US Consumer Confidence / Water Quality Report data. The information provided helps to demonstrate that both the U.S. and Canadian Water Treatment Plants are employing treatment technologies that successfully treat water; thus enabling them to provide quality drinking water. Few, if any, violations of federally regulated standards were reported, supporting the claim that drinking water quality is good. The risk of human exposure to a noted chemical and/or microbiological contaminants in drinking water is generally low. Therefore, the potential for humans to develop health complications as a result of consuming drinking water containing these contaminants from the Great Lakes basin is also low.

#### **Acknowledgements**

##### **Authors**

Agency for Toxic Substance and Disease Registry - Heraline E., Hicks

Environment Canada - Susan Arndt; Kate Cave, Harold Leadlay; Lindsay Silk

Minnesota Department of Health - Patricia McCann

U.S. Environmental Protection Agency - Jacqueline Fisher, Kimberly Harris, Sandra Hellman, Christyanne Melendez, Elizabeth Murphy, Todd Nettesheim, David Rockwell, William Spaulding, Holiday Wirick

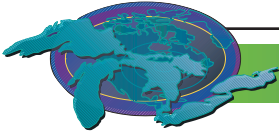
Wisconsin Department of Health and Family Services - Henry A. Anderson

Wisconsin Division of Public Health - Dyan Steenport

Ontario Ministry of the Environment - Environmental Monitoring and Reporting Branch and Standards Development Branch

#### **HUMAN HEALTH**

<b>ID #</b>	<b>Indicator Name</b>	<b>2005 Assessment (Status, Direction)</b>
4175	Drinking Water Quality	Good, Unchanging
4177	Biologic Markers of Human Exposure to Persistent Chemicals	Mixed, Undetermined
4200	Beach Advisories, Postings and Closures	Mixed, Undetermined
4201	Contaminants in Sport Fish	Mixed, Improving
4202	Air Quality	Mixed, Improving

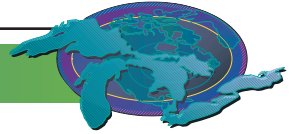


## Land Use - Land Cover Assessment

The overall assessment for this bundle of indicators was not available at the time of this report preparation.

### LAND USE – LAND COVER

ID #	Indicator Name	2005 Assessment (Status, Direction)
<b>General</b>		
7002	Land Cover - Land Conversion	No Assessment
7101	Groundwater and Land: Use and Intensity	No Assessment
<b>Forest Lands</b>		
8500	Forest Lands - Conservation of Biological Diversity	Mixed, Improving
<b>Agricultural Lands</b>		
7028	Sustainable Agriculture Practices	(2002 report)
7061	Nutrient Management	(2002 report)
7062	Integrated Pest Management	(2002 report)
<b>Urban/Suburban Lands</b>		
7000	Urban Density	Mixed, N/A
7006	Brownfield Redevelopment	(2002 report)
<b>Protected Areas</b>		
8129	Area, Quality, and Protection of Special Lakeshore Communities - Cobble Beaches	Mixed, Deteriorating
8129	Area, Quality, and Protection of Special Lakeshore Communities - Alvars	(2000 report)



## Resource Utilization Assessment

The overall assessment for this bundle of indicators was not available at the time of this report preparation.

### RESOURCE UTILIZATION

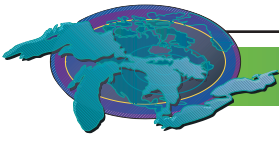
ID #	Indicator Name	2005 Assessment (Status, Direction)
3514	Commercial/Industrial Eco-Efficiency	(2002 report)
7043	Economic Prosperity	(2002 report)
7056	Water Withdrawal	Mixed, Unchanging
7057	Energy Consumption	Mixed, N/A
7060	Solid Waste Generation	(2002 report)

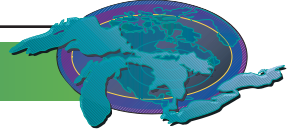
## Climate Change Assessment

There will not be an overall assessment for Climate Change at this time since only two indicators fall within this bundle.

### CLIMATE CHANGE

ID #	Indicator Name	2005 Assessment (Status, Direction)
4858	Climate Change: Ice Duration on the Great Lakes	(2002 report)





## Salmon and Trout

SOLEC Indicator #8

**Assessment:** Mixed, Improving.

### Purpose

This indicator illustrates trends in populations of introduced salmon and trout species and species diversity in the Great Lakes basin. These trends have been used to evaluate the resulting impact on native fish populations and the prey fish population that supports them.

### Ecosystem Objective

In order to manage Great Lakes fisheries, a common fish community goal was developed by management agencies responsible for the Great Lakes fishery. The goal is:

*“To secure fish communities, based on foundations of stable self-sustaining stocks, supplemented by judicious plantings of hatchery-reared fish, and provide from these communities an optimum contribution of fish, fishing opportunities and associated benefits to meet needs identified by society for wholesome food, recreation, cultural heritage, employment and income, and a healthy aquatic environment” (GLFC 1997).*

Objectives for fish communities (FCOs) of each lake address introduced salmonines such as chinook and coho salmon, rainbow and brown trout (see Table 1 for definitions of fish terms). These objectives are used to establish stocking and harvest targets consistent with FCOs for restoration of native salmonines such as lake trout, brook trout, and, in Lake Ontario, Atlantic salmon.

Term	Definition
Salmonine	Refers to true salmon and trout species.
Salmonid	Refers to any species of fish with an adipose fin, including trout, salmon, whitefish, grayling, and cisco.
Pelagic	Living in open water, especially where the water is more than 20 m deep.

Table 1. Glossary of various terms found in paper.

**Lake Ontario (1999):** Establish a diversity of salmon and trout with an abundant population of rainbow trout and the chinook salmon as the top predator supported by a diverse prey-fish community with the alewife as an important species. Amounts of naturally produced (wild) salmon and trout, especially rainbow trout, that are consistent with fishery and watershed plans.

**Lake Erie and Lake St. Clair (2003):** Manage the eastern basin to provide sustainable harvests of valued fish species, including...lake trout, rainbow trout, and other salmonids.

**Lake Huron (1995):** Establish a diverse salmonine community that can sustain an annual harvest of 2.4 million kg with lake trout the dominant species and stream-spawning species also having a prominent place.

**Lake Michigan (1995):** Establish a diverse salmonine community capable of sustaining an annual harvest of 2.7 to 6.8 million kg (6 to 15 million lb), of which 20-25% is lake trout, and establish self-sustaining lake trout populations.

**Lake Superior (2003):** Manage populations of pacific salmon, rainbow trout, and brown trout that are predominantly self-sustaining but may be supplemented by stocking that is compatible with restoration and management goals established for indigenous fish species.

### State of the Ecosystem

First introduced to the Great Lakes in the late 1870s, non-native salmonines have emerged as a prominent component of the Great Lakes ecosystem and an important tool for Great Lakes fisheries management. Fish managers stock non-native salmonines to suppress abundance of the non-native preyfish, alewife—thereby reducing alewife predation and competition with native fish—while seeking to avoid wild oscillations in salmonine-predator/alewife-prey ratios. In addition, non-native salmonines are stocked to create



recreational fishing opportunities with substantial economic benefit (Rand and Stewart, 1998).

Non-native alewives prey on the larvae of a variety of native fishes, including yellow perch and lake trout, and compete with native fishes for zooplankton. In addition, the enzyme thiaminase in alewives causes Early Mortality Syndrome (EMS) in salmonines that consume alewife, threatening lake trout rehabilitation in the lower four lakes and Atlantic salmon restoration in Lake Ontario. As alewife populations increase, massive over-winter die-offs can occur—particularly in severe winters—fouling local beaches that are used for recreation and impacting the health of the surrounding ecosystem. Originating in the Atlantic Ocean, the alewife is not adapted to cold water temperatures (Indiana Division of Fish and Wildlife, 1997).

After decimation of the native top predator (lake trout) by the non-native, predaceous sea lamprey, stocking of non-native salmonines increased dramatically in the 1960s and 1970s. It is estimated from stocking data obtained from the website of the Great Lakes Fishery Commission or GLFC that ~ 848 million non-native salmonines have been stocked in the Great Lakes basin between 1966 and 2001. This value excludes the stocking of Atlantic salmon in Lake Ontario as they are native to this lake. Non-native salmonines also reproduce in the Great Lakes, for example, many of the chinook salmon in Lake Huron are wild and not stocked.

Figure 1 shows the total number of non-native salmonines stocked in each of the Great Lakes from 1966-2001. Of the five major Great Lakes (excluding Lake St. Clair) depicted in Figure 1, it is evident that Lake Michigan is the most heavily stocked lake, with a maximum stocking level in 1998 greater than 16 million non-native salmonines. In contrast, Lake Superior has the lowest rates of stocking, with a maximum greater than 5 million non-native salmonines in 1991. Lakes Ontario, Huron and Erie all seem to display a similar overall downward trend in stocking, especially in recent years. Since the late 1980s, the number of non-native salmonines stocked in the Great Lakes has been leveling off or slightly declining with the exception of a 1998 peak in Lakes Michigan and Huron. In Lake Ontario, this trend can be explained by stocking cuts implemented in 1993 by fisheries managers to lower prey consumption by salmonine species by 50 percent over two years (Schaner et al. 2001).

Of non-native salmonines, chinook salmon are the most heavily stocked (figure 2, accounting for ~ 45% of all non-native salmonine releases. Chinook salmon, which prey almost exclusively on alewife, are the least expensive of all non-native salmonines to rear, thus making them the backbone of stocking programs in alewife-infested lakes, such as Lakes Michigan, Huron and Ontario (Bowlby and Daniels, 2002). Like other salmonines, chinook salmon are also stocked in order to provide an economically important sport fishery. While chinook salmon have the greatest prey demand of all non-native salmonines, an estimated 76,000 tones of alewife are consumed annually by all salmonine predators (Kocik and Jones, 1999).

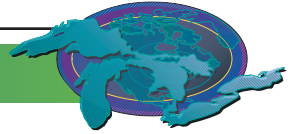
### Pressures

The introduction of non-native salmonines into the Great Lakes basin, beginning in the late 1870s, has placed pressures on both the introduced species and the Great Lakes ecosystem. The effects of introduction on the non-native salmonine species include survival, growth and development, dispersion and migration, reproduction, and alteration of life-history characteristics (Crawford, 2001).

The effects of non-native salmonine introductions on the Great Lakes ecosystem are numerous. Some of the effects on native species are; 1) the risk of introducing and transferring pathogens and parasites (e.g. furunculosis, whirling disease, bacterial kidney disease, and infectious pancreatic necrosis), 2) the possibility of local decimation or extinction of native prey fish populations through predation, 3) competition between introduced and native species for food, stream position, and spawning habitat, and 4) genetic alteration due to the creation of sterile hybrids (Crawford, 2001). The introduction of non-native salmonines to the Great Lakes basin is a significant departure from lake trout's historic dominance as key predator.

With few exceptions (such as kokanee salmon), introduced salmonines are now reproducing successfully in portions of the basin, and are considered naturalized components of the Great Lakes ecosystem. Therefore, the question is no longer whether non-native salmonines should be introduced, but rather how to determine the appropriate abundance of salmonine species in the lakes.

Within any natural system there are limits to the level of stocking that can be maintained. The limits to stocking are determined by the balance between lower and higher trophic level populations (Kocik and Jones, 1999). Rand and Stewart (1998), suggest that predatory salmonines have the potential to create a situation where prey (alewife) is limiting and ultimately predator survival is reduced. For example, during the 1990s, chinook salmon in Lake Michigan suffered dramatic declines due to high mortality and high prevalence of Bacterial Kidney Disease (BKD) when alewife were no longer as abundant in the prey fish community (Hansen and



Holey, 2002). Salmonine predators could have been consuming as much as 53 percent of alewife biomass in Lake Michigan annually (Brown et al. 1999). While suppressing alewife populations, managers seek to avoid extreme “boom and bust” predator and prey populations, a condition not conducive to biological integrity. Currently managers seek to produce a predator/prey balance by adhering to stocking ceilings established for lakes such as Michigan and Ontario, based on assessment of forage species and naturally produced salmonines. Because of their importance as a forage base for the salmonine sport fishery, alewife are no longer viewed as a nuisance by some managers (Kocik and Jones, 1999). With finite prey and habitat resources for salmonine production, each species unavoidably exists at some expense to others.

### Management Implications

In Lakes Michigan, Huron, and Ontario, many salmonine species are stocked in order to maintain an adequate population to suppress non-native prey species (alewife) as well as to support recreational fisheries. Determining stocking levels that will avoid oscillations in the forage base of the ecosystem is an ongoing challenge. Alewife populations, in terms of an adequate forage base for introduced salmonines, are difficult to estimate as there is a delay before stocked salmon become significant consumers of alewife; meanwhile, alewife can suffer severe die offs in particularly severe winters.

Fisheries managers seek to improve their means of predicting appropriate stocking levels in the Great Lakes basin based on the alewife population. Long-term data sets and models track the population of salmonines and species with which they interact. However, more research is needed to determine the optimal number of non-native salmonines, to estimate abundance of naturally produced salmonines, to assess the abundance of forage species, and to better understand the role of non-native salmonines and non-native prey species in the Great Lakes ecosystem.

Chinook salmon will likely continue to be the most abundantly stocked salmonine species in Lakes Michigan, Huron, and Ontario since they are inexpensive to rear, feed heavily on alewife, and are highly valued by recreational fishers. Fisheries managers should continue to model, assess, and practice adaptive management with the ultimate objective being to support fish community goals and objectives that GLFC lake committees established for each of the Great Lakes.

This indicator should be reported frequently as salmonine stocking is a complex and dynamic management intervention in the Great Lakes Ecosystem.

### Acknowledgements

Author: Erin Clark, Environment Canada, Downsview, ON

Author: Melissa Greenwood, Environment Canada, Downsview, ON

### Sources

Bowlby, J.N. and Daniels, M.E. *Lake Ontario Pelagic Fish 2: Salmon and Trout. 2002 Annual Report.* Retrieved May 14, 2004, from the Lake Ontario management Unit Web site [www.glfc.org/lakecom/loc/mgmt\\_unit/index.html](http://www.glfc.org/lakecom/loc/mgmt_unit/index.html).

Brown Jr., E.H., Busiahn, T.R., Jones, M.L., and Argyle, R.L. (1999). *Allocating Great Lakes Forage Bases in Response to Multiple Demand. Great Lakes Fisheries Policy and Management: a Binational Perspective.* Taylor, W.W. and Ferreri C.P. (eds). East Lansing, MI, Michigan State University Press: pp. 355-394

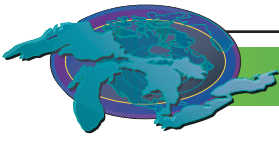
Crawford, S.S. *Salmonine Introductions to the Laurentian Great Lakes: An Historical Review and Evaluation of Ecological Effects.* Canadian Special Publication of Fisheries and Aquatic Sciences. 132:205 pp.

GLFC-Great Lakes Fishery Commission (1997). *A Joint Strategic Plan for Management of Great Lakes Fisheries.* Retrieved April 28, 2004, from the Great Lakes Fishery Commission Web site [www.glfc.org/fishmgmt/sglfmp97.htm](http://www.glfc.org/fishmgmt/sglfmp97.htm).

GLFC-Great Lakes Fishery Commission (2001). *Strategic Vision of the Great Lakes Fishery Commission for the First Decade of the New Millennium.* Retrieved April 30, 2004, from the Great Lakes Fishery Commission Web site [www.glfc.org](http://www.glfc.org).

Hansen, M.J. and M.E. Holey. 2002. *Ecological factors affecting the sustainability of chinook and coho salmon populations in the Great Lakes, especially Lake Michigan.* pp. 155-179 in Lynch, K.D., Jones, M.L. and Taylor, W.W. *Sustaining North American*





salmon: Perspectives across regions and disciplines. American Fisheries Society Press, Bethesda, MD.

Indiana Division of Fish and Wildlife (1997). *Alewife Die-Offs Expected on Indiana Shores*. Retrieved May 4, 2004, from the Great lakes Sport Fishing Council Web site [www.great-lakes.org/5-05-97.html](http://www.great-lakes.org/5-05-97.html).

Kocik, J.F., and Jones, M.L. (1999). Pacific *Salmonines in the Great Lakes Basin*. *Great Lakes Fisheries Policy and Management: a Binational Perspective*. Taylor, W.W. and Ferreri C.P. (eds). East Lansing, MI, Michigan State University Press ([www.msu.edu/unit/msupress](http://www.msu.edu/unit/msupress)): pp 455-489.

Rand, P.S. and Steward D.J. (1998). *Prey fish exploitation, salmonine production, and pelagic food web efficiency in Lake Ontario*. Canadian Journal of Fisheries and Aquatic Science 55(2): 318-327.

Schaner, T., Bowlby, J.N., Daniels, M., Lantry, B.F. (2001). *Lake Ontario Offshore Pelagic Fish Community*. Lake Ontario Fish Communities and Fisheries: 2000 Annual Report of the Lake Ontario Management Unit. P. 1.1-1.10.

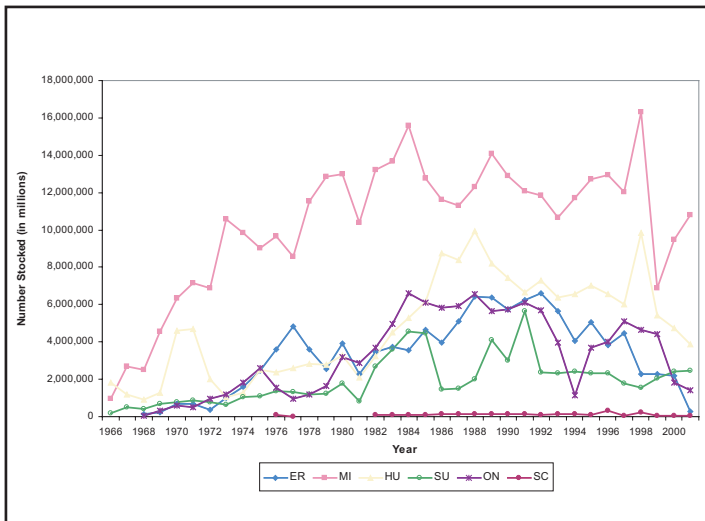


Figure 1: Total number of non-native salmonines stocked in the Great Lakes, 1966–2001 excluding Atlantic salmon in Lake Ontario and brook trout in all Great Lakes.  
Data Source: Great Lakes Fishery Commission Fish Stocking Database ([www.glfc.org/fishstocking](http://www.glfc.org/fishstocking))

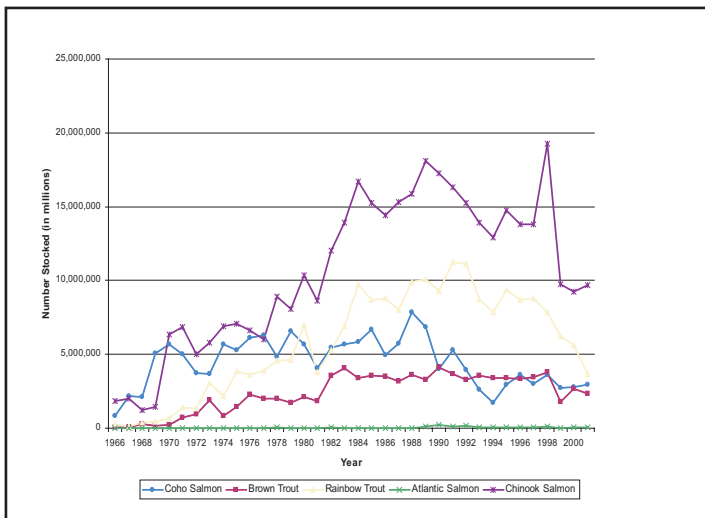
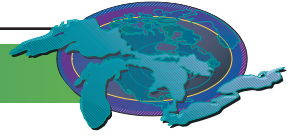


Figure 2: Non-Native salmonine stocking by species in the Great Lakes, 1966-2001 excluding Atlantic salmon in Lake Ontario and brook trout in all Great Lakes  
Data Source: Great Lakes Fishery Commission Fish Stocking Database ([www.glfc.org/fishstocking](http://www.glfc.org/fishstocking))



## Walleye

SOLEC Indicator #9

**Assessment: Good, Unchanging**

### Purpose

Trends in walleye fishery yields generally reflect changes in walleye health. As a top predator, walleyes can strongly influence overall fish community composition and affect the stability and resiliency of Great Lakes aquatic communities. Therefore, walleye health is a useful indicator of ecosystem health, particularly in moderately productive (mesotrophic) areas of the Great Lakes.

### Ecosystem Objective

Protection, enhancement, and restoration of historically important, mesotrophic habitats that support natural stocks of walleye as the top fish predator are necessary for stable, balanced, and productive elements of the Great Lakes ecosystem.

### State of the Ecosystem

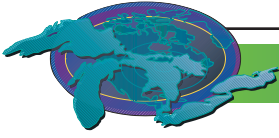
Reductions in phosphorus loadings during the 1970s substantially improved spawning and nursery habitat for many fish species in the Great Lakes. Improved mesotrophic habitats (i.e., western Lake Erie, Bay of Quinte, Saginaw Bay, and Green Bay) in the 1980s, along with interagency fishery management programs that increased adult survival, led to a dramatic recovery of walleyes in many areas of the Great Lakes, especially in Lake Erie. High water levels also may have played a role in the recovery in some lakes or bays. Annual trends in fishery harvests generally track walleye recovery in these areas, with peak harvests occurring in the mid-1980s to early 1990s followed by declines from the mid-1990s through 2003 in most areas. Total yields were highest in Lake Erie (averaged about 4,600 metric tons, 1975-2003), intermediate in Lakes Huron and Ontario (<300 metric tons in all years), and lowest in Lakes Michigan and Superior (<10 metric tons). Declines after the mid-1990s were likely related to shifts in environmental states (i.e., from mesotrophic to less favorable oligotrophic conditions), less frequent production of strong hatches, and changing fisheries. The effects of exotic species on the food web or on walleye behavior (increased water clarity can limit daytime feeding) also may have been a contributing factor. In general, walleye yields peaked under ideal environmental conditions and declined under less favorable (i.e., non-mesotrophic) conditions. Despite recent declines in walleye yields, environmental conditions remain improved relative to the 1970s.

### Pressures

Natural, self-sustaining walleye populations require adequate spawning and nursery habitats. In the Great Lakes, these habitats lie in tributary streams and nearshore reefs, wetlands, and embayments and have been used by native walleye stocks for thousands of years. Degradation or loss of these habitats is the primary concern for the health of walleye populations and can result from both human causes, as well as from natural environmental variability. Increased human use of nearshore and watershed environments continues to alter the natural hydrologic regime, affecting water quality (i.e., sediment loads) and rate of flow. Environmental factors that affect precipitation patterns ultimately alter water levels, water temperature, water clarity, and flow. Thus, global warming and its subsequent effects on temperature and precipitation in the Great Lakes basin may become increasingly important determinants of walleye health. Exotic invaders, like zebra and quagga mussels, ruffe, and round gobies continue to disrupt the efficiency of energy transfer through the food web, potentially affecting growth and survival of walleye and other fishes through a reduced supply of food. Moreover, alterations in the food web can affect environmental characteristics (like water clarity), which can in turn affect fish behavior and fishery yields.

### Management Implications

To improve the health of Great Lakes walleye populations, managers must enhance their reproduction, growth, and survival rates. Most walleye populations are dependent on natural reproduction, which is largely driven by uncontrollable environmental events (i.e., spring weather patterns). However, a lack of suitable spawning and nursery habitat is limiting walleye reproduction in some areas due to human activities and can be remedied through such actions as dam removal, substrate enhancement, or improvements to watersheds to reduce siltation and restore natural flow conditions. Growth rates are dependent on weather (i.e., water temperatures), quality of the prey base, and walleye density, most of which are not directly manageable. Survival rates can be altered through fisheries management, which is generally conservative across all of the Great lakes. Continued interactions between land managers and fisheries managers to protect and restore natural habitat conditions in mesotrophic areas of the Great Lakes are essential for the long-term health of walleye populations. Elimination of additional introductions of invasive species and control of existing exotics,



where possible, is also critical to future health of walleyes and other native species.

### Acknowledgments

Author: Roger Knight, Ohio Department of Natural Resources

Fishery harvest data were obtained Jim Hoyle (Lake Ontario-OMNR), Steve Lapan (Lake Ontario -NYDEC), Karen Wright (Upper Lakes tribal data-COTFMA), Dave Fielder (Lake Huron-MDNR), Lloyd Mohr (Lake Huron-OMNR), Kevin Kapuscinski (Green Bay-WDNR), Ken Cullis (Lake Superior-OMNR), various annual OMNR and ODNR Lake Erie fisheries reports, and the GLFC commercial fishery data base. *Fishery data should not be used for purposes outside of this document without first contacting the agencies that collected them.*

### Sources

Lake Superior: Ken Cullis, OMNR, [ken.cullis@mnr.gov.on.ca](mailto:ken.cullis@mnr.gov.on.ca)

Lake Michigan: Karen Wright, CORA, [kwright@sault.com](mailto:kwright@sault.com)  
Kevin Kapuscinski, WDNR, [kevin.kapuscinski@dnr.state.wi.us](mailto:kevin.kapuscinski@dnr.state.wi.us)

Lake Huron: Dave Fielder, MDNR, [fielderd@state.mi.us](mailto:fielderd@state.mi.us)  
Lloyd Mohr, OMNR, [lloyd.mohr@mnr.gov.on.ca](mailto:lloyd.mohr@mnr.gov.on.ca)

Lake Erie: Brian Locke, OMNR, [brian.locke@mnr.gov.on.ca](mailto:brian.locke@mnr.gov.on.ca)  
Roger Knight, ODNR, [roger.knight@dnr.state.oh.us](mailto:roger.knight@dnr.state.oh.us)

Lake Ontario: Jim Hoyle, OMNR, [jim.hoyle@mnr.gov.on.ca](mailto:jim.hoyle@mnr.gov.on.ca)  
Steve Lapan, NYDEC, [slapan@gw.dec.state.ny.us](mailto:slapan@gw.dec.state.ny.us)

### Further Work Necessary

Fishery yields are appropriate indicators of walleye health but only in a general sense. Yield assessments are lacking for some fisheries (recreational, commercial, or tribal) or in some years for all of the areas. Moreover, measurement units are not standardized among fishery types (i.e., commercial fisheries are measured in pounds while recreational fisheries are typically measured in numbers), which means additional conversions are necessary and may introduce errors. Therefore, trends in yields across time (blocks of years) are probably better indicators than absolute values within any year, assuming that any introduced bias is relatively constant over time. Given the above, I recommend a 10-year reporting cycle on this indicator and encourage all agencies to compile walleye harvest data from their major fisheries. In light of serious fiscal constraints now being imposed on virtually all agencies, this recommendation will be difficult to achieve. Alternatively, many agencies have developed, or are developing, population estimates for many Great Lakes fishes. Walleye population estimates for selected areas (i.e., Lake Erie, Saginaw Bay, Green Bay, and Bay of Quinte) would probably be a better assessment of walleye population health in the Great Lakes than harvest estimates across all lakes and I recommend switching to them as they become available in all areas.

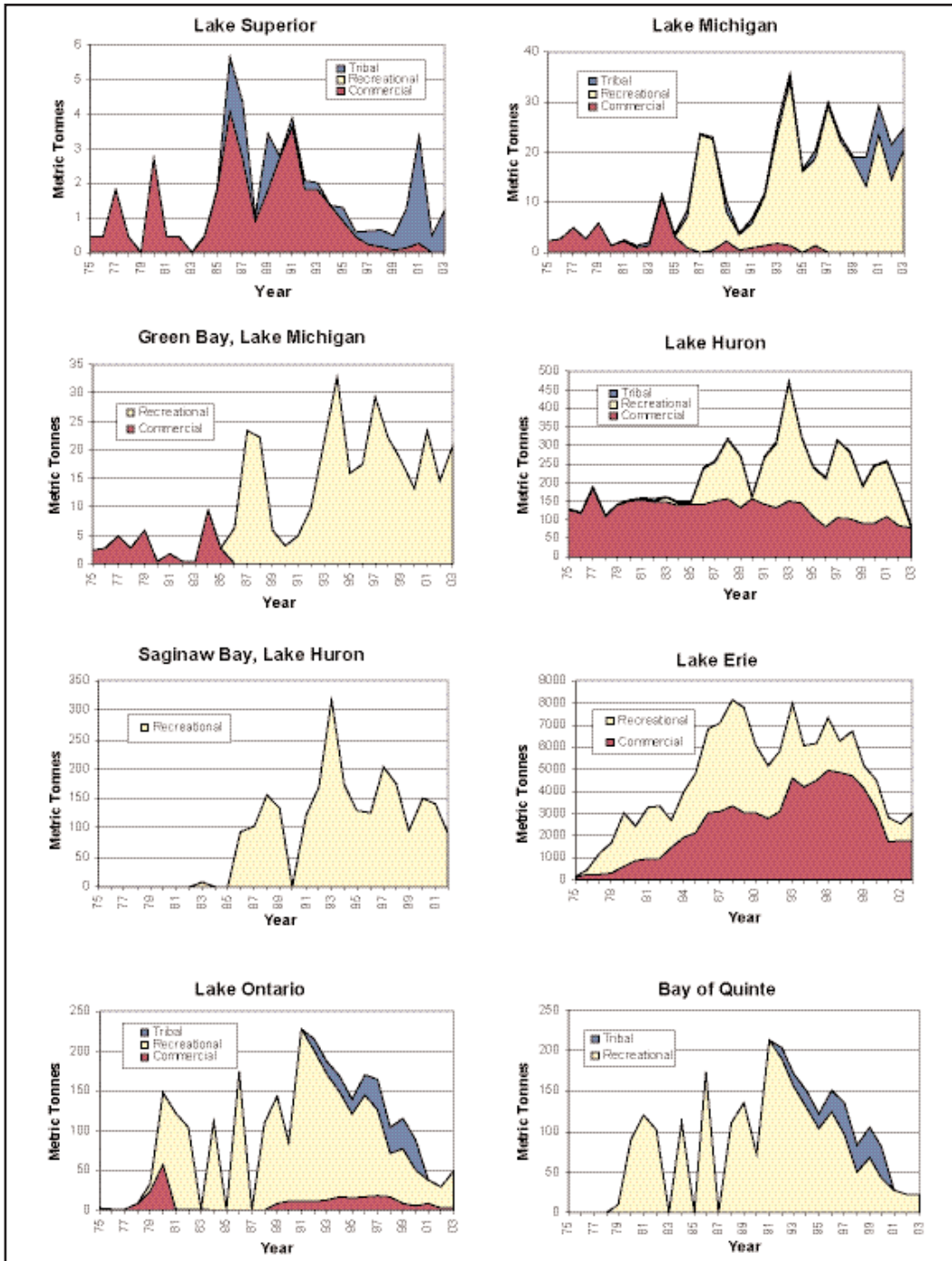
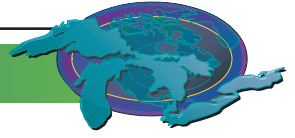
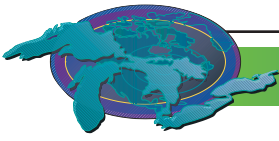


Figure 1



## Preyfish Populations

SOLEC Indicator #17

**Assessment: Mixed, Deteriorating except in Lake Superior where conditions are Mixed, Improving**

### Measure

Quantify the status and trends in the abundance and structure (i.e., age and size distributions) of prey fish populations in each lake.

### Purpose

To directly measure abundance and diversity of preyfish populations, especially in relation to the stability of predator species necessary to maintain the biological integrity of each lake.

### Ecosystem Objective

The importance of preyfish populations to support healthy, productive populations of predator fishes is recognized in the FCGOs for each lake. For example, the fish community objectives for Lake Michigan specify that in order to restore an ecologically balanced fish community, a diversity of prey species at population levels matched to primary production and predator demands must be maintained. This indicator also relates to the 1997 Strategic Great Lakes Fisheries Management Plan Common Goal Statement for Great Lakes fisheries agencies.

The preyfish assemblage forms important trophic links in the aquatic ecosystem and constitute the majority of the fish production in the Great Lakes. Preyfish populations in each of the lakes are currently monitored on an annual basis in order to quantify the population dynamics of these important fish stocks leading to a better understanding of the processes that shape the fish community and to identify those characteristics critical to each species. Populations of lake trout, Pacific salmon, and other salmonids in have been established as part of intensive programs designed to rehabilitate (or develop new) game fish populations and commercial fisheries. These economically valuable predator species sustain an increasingly demanding and highly valued fisheries and information on their status is crucial. In turn, these apex predators are sustained by forage fish populations. In addition, the bloater and the lake herring, which are native species, and the rainbow smelt are also directly important to the commercial fishing industry. Therefore, it is very important that the current status and estimated carrying capacity of the preyfish populations be fully understood in order to fully address (1) lake trout restoration goals, (2) stocking projections, (3), present levels of salmonid abundance and (4) commercial fishing interests.

### Features

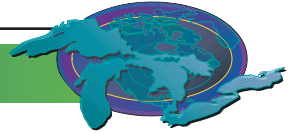
The segment of the Great Lakes' fish communities that we classify as preyfish comprises species – including both pelagic and benthic species – that prey on invertebrates for their entire life history. As adults, preyfish depend on diets of crustacean zooplankton and macroinvertebrates *Diporeia* and *Mysis*. This convention also supports the recognition of particle-size distribution theory and size-dependent ecological processes. Based on size-spectra theory, body size is an indicator of trophic level and the smaller, short-lived fish that constitute the planktivorous fish assemblage discussed here are a discernable trophic group of the food web. At present, bloaters (*Coregonus hoyi*), lake herring (*Coregonus artedii*), rainbow smelt (*Osmerus mordax*), alewife (*Alosa pseudoharengus*), and deepwater sculpins (*Myoxocephalus thompsoni*), and to a lesser degree species like lake whitefish (*Coregonus clupeaformis*), nine-spine stickleback (*Pungitius pungitius*) and slimy sculpin (*Cottus cognatus*) constitute the bulk of the preyfish communities.

In Lake Erie, the prey fish community is unique among the Great Lakes in that it is characterized by relatively high species diversity. The prey fish community comprises primarily gizzard shad (*Dorosoma cepedianum*) and alewife (grouped as clupeids), emerald (*Notropis atherinoides*) and spottail shiners (*N. hudsonius*), silver chubs (*Hybopsis storeriana*), trout-perch (*Percopsis omiscomaycus*), round gobies (*Neogobius melanostomus*), and rainbow smelt (grouped as soft-rayed), and age-0 yellow (*Perca flavescens*) and white perch (*Morone americana*), and white bass (*M. chrysops*)(grouped as spiny-rayed).

### State of the Ecosystem

Lake Ontario –

The non-native alewives, and to a lesser degree rainbow smelt, dominate the prey fishes. The alewife population remains at a level well below that of the early 1980s. Rainbow smelt declined to a new low, well below that of the previous record low, and have an abbreviated age and size structure that suggests the population is under heavy predation pressure. Abundance of slimy sculpins



along the south shore at depths >70 m remain well below the 1991 peak and is unlikely to recover in the absence of *Diporeia*. No deepwater sculpins *Myoxocephalus thompsoni* were collected in 2001-2003. **Assessment for Lake Ontario: Mixed, deteriorating.**

#### Lake Erie –

The prey fish community in all three basins of Lake Erie has shown declining trends. In the eastern basin, rainbow smelt have shown declines in abundance over the past two decades, although slight increases have occurred in the past couple years. The declines have been attributed to lack of recruitment associated with expanding Dreissenid colonization and reductions in productivity. The western and central basins also have shown declines in forage fish abundance associated with declines in abundance of age-0 white perch and rainbow smelt, respectively. The clupeid component of the forage fish community has shown no overall trend in the past decade, although gizzard shad and alewife abundance has been quite variable across the survey period, and in 2003 declined to the low levels observed in 1998. The biomass estimates for western Lake Erie were based on data from bottom trawl catches, data from acoustic trawl mensuration gear, and depth strata extrapolations (0-6 m, and >6 m). **Assessment for Lake Erie: Mixed, deteriorating.**

#### Lake Michigan –

In recent years, alewife biomass has remained at consistently lower levels compared to the 1970-1980s. Some increase in abundance is noted with strong 1995 and 1998 year classes, but the current low population levels appear to be driven in large part by predation pressure. Rainbow smelt have declined and remain at lower levels, possibly due to predation. The decline in bloater biomass after 1990 has been attributed to a lack of recruitment and slow growth. Since 2000 bloater has declined more slowly, and may rebound as part of an anticipated natural cycle in abundance. Deepwater sculpins remain at the same level of abundance and continue to contribute a significant portion of the preyfish biomass. Yellow perch year-class strength was poor in 2003, indicating another in a series of failed year classes since 1989. Lake-wide biomass of Dreissenid mussels increased from 14 kt to 43 kt between 1999 and 2001 but afterwards decreased sharply, reaching 14 kt in 2003 (with the quagga mussel invasion well underway) while *Diporeia* populations continue to decline. The first catch of round gobies appeared in our annual lake-wide survey in 2003. **Assessment for Lake Michigan: Mixed, deteriorating.**

#### Lake Huron –

The fish community of Lake Huron during 2003 was very different from recent years. Adult alewife abundance during 2003 was extremely low, presumably due to a combination of over winter mortality during 2002-2003 and salmonid predation. However, age-0 alewives were more abundant than at any time since 1992 due to an exceptionally strong year class. Adult rainbow smelt abundance was the lowest observed since 1992, but age-0 rainbow smelt were abundant, indicating a potentially strong year class. Adult bloater abundance increased slightly from 2002, but age-0 bloaters were ubiquitous. The CPE of juvenile bloaters was the highest recorded since 1992, and the 2003 year class may be one of the largest since annual surveys began in 1973. Abundances for most other prey species were stable, but round gobies continued to increase at southern ports. Prey biomass available to the trawl increased during 2003 with alewives comprising the bulk of the biomass; However, unlike 2002, alewife biomass was composed almost entirely of age-0 fish rather than adults. Predators in Lake Huron face potential prey shortages. Although overall prey density was high, there were few adult alewives or rainbow smelt available. Predator feeding conditions during 2004 will depend on over winter survival of age-0 alewife and the ability of large predators to subsist on small or non-traditional prey. Overall, the L. Huron fish community is dominated by non-native species, notably alewife. Round gobies and Dreissenid mussels are proliferating throughout the lake and increasing in abundance. **Assessment for Lake Huron: Mixed, deteriorating.**

#### Lake Superior –

Over the past 10-15 years, prey fish populations declined in total biomass when compared to the peak years in 1986, 1990, and 1994, a period when lake herring was the dominant prey fish species and wild lake trout populations were starting to recover. Since the early 1980s, dynamics in the total biomass of prey fish has been driven largely by variation in recruitment of age-1 lake herring. Strong year classes in 1984, 1989, and 1998 were largely responsible for peak lake herring biomass in 1986, 1990-1994, and 1999. Recent survey data now suggests that a strong year class was produced in 2003. During 1978-1984, rainbow smelt was the dominant prey fish and subsequently declined to a lower but relatively constant level during the 1984-2001 interval. During the recent 2002-2003 interval, rainbow smelt biomass declined to the lowest levels in the time series. There is strong evidence that declines in smelt biomass are tied to increased predation by recovered lake trout populations. Biomass of bloater and whitefish has increased since the early 1980s and biomass for both species has been more constant than lake herring. The rise and fall of total prey fish biomass over 1984-2003 reflects the recovery of wild lake trout stocks and resumption of commercial harvest of lake herring in Lake



Superior. Increases in prey fish populations are not likely without reductions in harvest by predators and commercial fisherman. Other species, notably sculpins, burbot, and stickleback have declined in abundance since the recovery of wild lake trout populations in the mid-1980s. Thus, the current state of the Lake Superior fish community appears to be largely the result of the recovery of wild lake trout stocks coupled with the resumption of human harvest of key prey species. **Assessment for Lake Superior: Mixed, improving.**

#### **Future Pressures**

The influences of predation by salmon and trout on preyfish populations appear to be common across all lakes. Additional pressures from *Dreissena* populations are apparent in Lakes Ontario, Erie, and Michigan. “Bottom-up” effects on the prey fishes have already been observed in Lake Ontario following the dreissenid-linked collapse of *Diporeia* and are likely to become apparent in lakes Michigan and Huron as Dreissenids expand and *Diporeia* decline. Furthermore, anecdotal observations in Lake Ontario indicate that *Mysis* are declining as Dreissenids proliferate in profundal waters, suggesting that dynamics of prey fish populations in future years could be driven by bottom-up rather than top-down effects in lakes Michigan, Huron, and Ontario.

#### **Future Activities**

Recognition of significant predation effects on preyfish populations has resulted in recent salmon stocking cutbacks in Lakes Michigan, Huron, and Ontario. However, even with a reduced population, alewives have exhibited the ability to produce strong year classes such that the continued judicious use of artificially propagated predators seems necessary to avoid domination by alewife. It should be noted that this is not an option in Lake Superior since lake trout and salmon are almost entirely lake-produced. Potential “bottom-up” effects on prey fishes would be difficult to mitigate owing to our inability to affect changes – this scenario only reinforces the need to avoid further introductions of exotics into the Great Lake ecosystems.

#### **Further Work Necessary**

It has been advanced that in order to restore an ecologically balanced fish community, a diversity of prey species at population levels matched to primary production and predator demands must be maintained. However, the current mix of native and naturalized prey and predator species, and the contributions of artificially propagated predator species into the system confound any sense of balance in lakes other than Superior. The metrics of ecological balance as the consequence of fish community structure are best defined through food-web interactions. It is through understanding the exchanges of trophic supply and demand that the fish community can be described quantitatively and ecological attributes such as balance can be better defined and the limits inherent to the ecosystem realized.

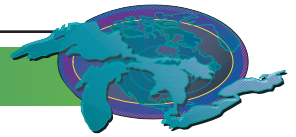
Continued monitoring of the fish communities and regular assessments of food habits of predators and prey fishes will be required to quantify the food-web dynamics in the Great Lakes. This recommendation is especially supported by continued changes that are occurring not only in the upper but also in the lower trophic levels. Recognized sampling limitations of traditional capture techniques (bottom trawling) has prompted the application of acoustic techniques as another means to estimate absolute abundance of prey fishes in the Great Lakes. Though not an assessment panacea, hydro-acoustics has provided additional insights and has demonstrated utility in the estimates of preyfish biomass.

Protecting or reestablishing rare or extirpated members of the once prominent native prey fishes, most notably the various members of the whitefish family (*Coregonus* spp), should be a priority in all the Great Lakes. This recommendation would include the deep-water cisco species and should be reflected in future indicator reports. Lake Superior, whose preyfish assemblage is dominated by indigenous species and retains a full complement of ciscoes, should be examined more closely to better understand the trophic ecology of its more natural system.

With the continuous nature of changes that seems to characterize the prey fishes, the appropriate frequency to review this indicator is on a 5-year basis.

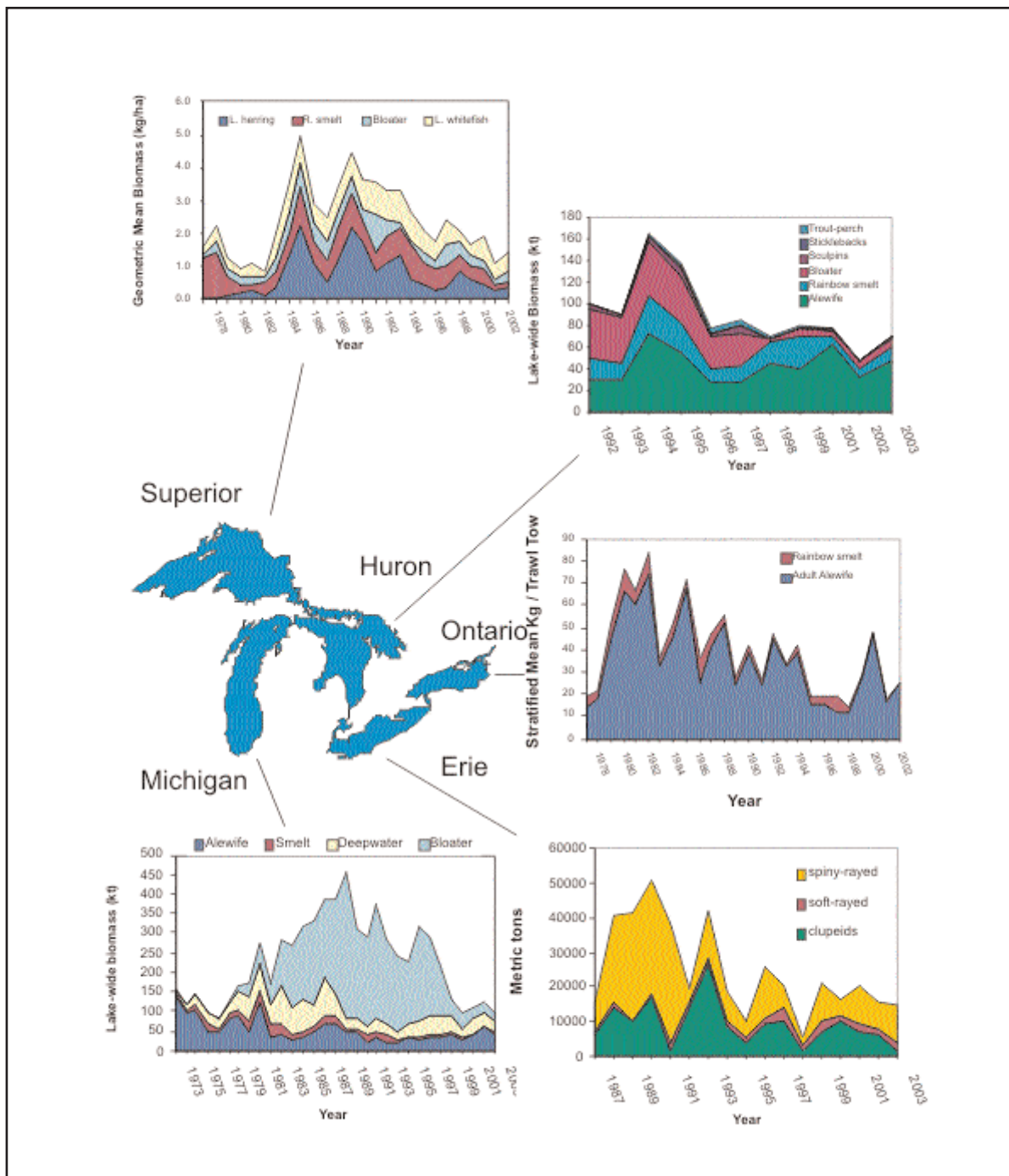
#### **Acknowledgements**

This report was compiled by Owen T. Gorman, USGS Great Lakes Science Center, Lake Superior Biological Station, Ashland, WI; with contributions from Robert O’Gorman and Randy W. Owens, USGS Great Lakes Science Center, Lake Ontario Biological Station, Oswego NY; Charles Madenjian and Jeff Schaeffer, USGS Great Lakes Science Center, Ann Arbor, MI.; Mike Bur USGS Great Lakes Science Center, Lake Erie Biological Station, Sandusky, OH; and Jeffrey Tyson, Ohio Div. of Wildlife Sandusky Fish

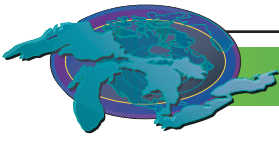


Research Unit, Sandusky, OH.

All preyfish trend figures are based on annual bottom trawl surveys performed by USGS Great Lakes Science Center, except the Lake Erie figure, which is from surveys conducted by the Ohio Division of Wildlife and the Ontario Ministry of Natural Resources.







## Sea Lamprey

SOLEC Indicator #18

**Assessment: Good/Fair Improving**

### Purpose

Estimates of the abundance of sea lamprey are presented as an indicator of the status of this invasive species and of the damage it causes to the fish communities and aquatic ecosystems of the Great Lakes. Populations of the native top predator, lake trout, and other fishes are negatively affected by mortality caused by sea lamprey.

### Ecosystem Objective

The 1955 Convention of Great Lakes Fisheries created the Great Lakes Fishery Commission (GLFC) “to formulate and implement a comprehensive program for the purpose of eradicating or minimizing the sea lamprey populations in the Convention area” (GLFC 1955). Under the Joint Strategic Plan for Great Lakes Fisheries, all fishery management agencies established Fish Community Objectives (FCOs) for each of the lakes. These FCOs call for suppressing sea lamprey populations to levels that cause only insignificant mortality on fish in order to achieve objectives for lake trout and other members of the fish community (Horns et al 2003, Eshenroder et al. 1995, DesJardin et al. 1995, Ryan et al. 2003., Stewart et a. 1999.)

The GLFC and fishery management agencies have agreed on target abundance levels for sea lamprey populations that correspond to the FCOs. Targets were derived from available estimates of the abundance of spawning-phase sea lampreys and data on wounding rates on lake trout. Suppressing sea lampreys to abundances within the target range is predicted to result in tolerable mortality on lake trout and other fish species.

	FCO Sea Lamprey Abundance Targets	Target Range (+/- 95% Confidence Interval)
Superior	35,000	18,000
Michigan	58,000	13,000
Huron	74,000	20,000
Erie	3,000	1,000
Ontario	29,000	4,000

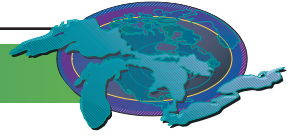
Table 1. Fish Community Objectives for sea lamprey abundance targets

### State of the Ecosystem

The first complete round of stream treatments with the lampricide TFM, as early as 1960 in Lake Superior, successfully suppressed sea lamprey to less than 10% of their pre-control abundance in all of the Great Lakes.

Mark and recapture estimates of the abundance of sea lamprey migrating up rivers to spawn are used as surrogates for the abundance of parasites feeding in the lakes during the previous year. Estimates of individual spawning runs in trappable streams are used to estimate lake-wide abundance using a new regression model that relates run size to stream characteristics (Mullett *et al.* 2003). Sea lamprey spend one year in the lake after metamorphosing, so this indicator has a two-year lag in demonstrating the effects of control efforts. Figure 1 presents these individual lake-wide estimates and 95% confidence intervals since 1980. The FCO targets and ranges are included in the figures

*Lake Superior:* During the past 20 years, populations have fluctuated but remain at levels less than 10% of peak abundance (Heinrich *et al.* 2003). Abundances were within the FCO target range during the late 1980s and mid 1990s. Abundances have trended upward from a low during 1994 and have been above the target range from 1999-2003. These recent increases in abundance have raised concern in all waters. Marking rates have shown the same pattern of increase. These increases appear to be most dramatic in the Nipigon Bay and north-western portion of the lake and in the Whitefish Bay area in the south-eastern portion of the lake. Survival objectives for lake trout continue to be met but lake trout populations could be threatened if these increases continue. In response to this increased abundance of sea lampreys, stream treatments with lampricides were increased beginning in 2001 through 2004. The effects of the increased treatments during 2001 may have contributed to the downward trend in the 2003 observation. The effects of additional stream treatments in 2002 and beyond will be observed in the spawning-run estimates during 2004 and following years.



*Lake Michigan:* The population of sea lamprey has shown a continuing, slow trend upward since 1980 (Lavis *et al.* 2003). The population was at or below the FCO target range until 2000. The marking rates on lake trout have shown the same upward trend past target levels during the recent years. Increases in abundance during the 1990s had been attributed to the St. Marys River. The continuing trend in recent years suggests sources of sea lamprey in Lake Michigan itself. Stream treatments were increased beginning in 2001 through 2004. This increase included treatment of newly discovered populations in lentic areas and treatment of the Manistique River, a large system where the deterioration of a dam near the mouth allowed sea lamprey access to nursery habitat. The 2003 spawning-phase population estimate did not show any decrease as a result of the increased treatments during 2001.

*Lake Huron:* The first full round of stream treatments during the late 1960s suppressed sea lamprey populations to levels less than 10% of those before control. (Morse *et al.* 2003). During the early 1980s, abundance increased in Lake Huron, particularly the northern portion of the lake, peaking in 1993. Through the 1990s there were more sea lampreys in Lake Huron than all the other lakes combined. FCOs were not being achieved. The damage caused by this large population of parasites was so severe that the Lake Huron Committee abandoned its lake trout restoration objective in the northern portion of the lake during 1995. The St. Marys River was identified as the source of the increasing sea lamprey population. The size of this connecting channel made traditional treatment with the lampricide TFM impractical. A new integrated control strategy including targeted application of a new formulation of a bottom-release lampricide, enhanced trapping of spawning animals, and sterile-male release was initiated in 1997 (Schleen *et al.* 2003). As predicted, the spawning-phase abundance has been significantly lower since 2001 as a result of the completion of the first full round of lampricide spot treatments during 1999. However the population shows considerable variation and increased during 2003. Wounding rates and mortality estimates for lake trout have also declined during the last three years. The full effect of the St. Marys River control program will not be observed for another 2-4 years (Adams *et al.* 2003). The GLFC has repeated lampricide treatments in limited areas with high densities of larvae during 2003 and 2004. These additional treatments are aimed at continuing the decline in sea lamprey in Lake Huron.

*Lake Erie:* Following the completion of the first full round of stream treatments in 1987, sea lamprey populations collapsed (Sullivan *et al.* 2003). Marking rates on lake trout declined and survival increased to levels sufficient to meet the rehabilitation objectives in the eastern basin. However, during the mid-1990s, sea lamprey abundance has increased to levels that threatened the lake trout restoration effort. A major assessment effort during 1998 indicated that the source of this increase was several streams in which treatments had been deferred due to low water flows or concerns for non-target organisms. These critical streams were treated during 1999 and 2000. Sea lamprey abundance was observed to decline to target levels in 2001 through 2003. Wounding rates on lake trout have also declined in the lake.

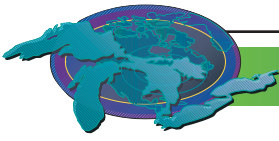
*Lake Ontario:* Abundance of spawning-phase sea lamprey has shown a continuing declining trend since the early 1980s (Larson *et al.* 2003). The abundance of sea lamprey has remained stable in the FCO target range during 2000-2003.

#### **Future Pressures**

Since parasitic-phase sea lamprey are at the top of the aquatic food chain and inflict high mortality on large piscivores, population control is essential for healthy fish communities. Increasing abundance in Lake Erie demonstrates how short lapses in control can result in rapid increases of abundance and that continued effective stream treatments are necessary to overcome the reproductive potential of this invading species. The potential for sea lamprey to colonize new locations is increased with improved water quality and removal of dams. For example, the loss of integrity of the dam on the Manistique River and subsequent production from this river have contributed to the increase in sea lamprey abundance in Lake Michigan. Any areas newly infested with sea lamprey will require some form of control to attain target abundance levels in the lakes.

As fish communities recover from the effects of sea lamprey predation or overfishing, there is evidence that the survival of parasitic sea lamprey may increase due to prey availability. Better survival means that there are more residual sea lamprey to cause harm. Significant additional control efforts, like those on the St. Marys River, may be necessary to maintain suppression.

The GLFC has a goal of reducing reliance on lampricides and increasing efforts to integrate other control techniques, such as the sterile-male-release-technique or the installation of barriers to stop the upstream migration of adults. Pheromones that affect migration and mating have been discovered and offer exciting potential as new alternative controls. The use of alternative controls is consistent with sound practices of integrated pest management, but can put additional pressures on the ecosystem such as limiting



the passage of fish upstream of barriers. Care must be taken in applying new alternatives or in reducing lampricide use to not allow sea lamprey abundance to increase.

#### **Future Actions**

The GLFC has increased stream treatments and lampricide applications in response to increasing abundances during 2001 through 2004. The GLFC has targeted these additional treatments to maximize progress toward FCO targets. The GLFC continues to focus on research and development of alternative control strategies. Computer models, driven by empirical data, are being used to best allocate treatment resources, and research is being conducted to better understand and manage in the variability in sea lamprey populations.

#### **Further Work Necessary**

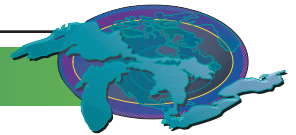
Targeted increases in lampricide treatments are predicted to reduce sea lamprey to acceptable levels. The effects of increased treatments will be observed in this indicator two years after they occur. Discrepancies among estimates of different life-history stages need to be resolved. Efforts to identify all sources of sea lamprey need to continue. In addition, research to better understand lamprey/prey interactions, the population dynamics of sea lamprey that survive control actions, and refinement of alternative control methods are all key to maintaining sea lamprey at tolerable levels.

#### **Acknowledgments**

Author: Gavin Christie, Great Lakes Fishery Commission, Ann Arbor, MI

#### **Sources**

- Adams, J.V., Bergstedt, R.A., Christie, G.C., Cuddy, D.W., Fodale, M.F., Heinrich, J.W., Jones, M.L., McDonald, R.B., Mullett, K.M., and Young, R.J. 2003. Assessing assessment: can we detect the expected effects of the St. Marys River sea lamprey control strategy? *J. Great Lakes Res.* 29 (Supplement 1): 717-727.
- DesJardine, R.L., Gorenflo, T.K., Payne, R.N., and Schrouder, J.D. 1995. Fish-community objectives for Lake Huron. *Great Lakes Fish. Comm. Spec. Pub.* 95-1. 38 p.
- Eshenroder, R.L., Holey, M.E., Gorenflo, T.K., and Clark, R.D. J.D. 1995. Fish-community objectives for Lake Michigan. *Great Lakes Fish. Comm. Spec. Pub.* 95-3. 56 p.
- Great Lakes Fishery Commission. 1955. Convention on Great Lakes Fisheries. Great Lakes Fishery Commission, Ann Arbor, MI.
- Heinrich, J.W., Mullett, K.M., Hansen, M.J., Adams, J.V., Klar, G.T., Johnson, D.A., Christie, G.C., and Young, R.J. 2003. Sea lamprey abundance and management in Lake Superior, 1957-1999. *J. Great Lakes Res.* 29 (Supplement 1): 566-583.
- Horns, W.H., C.R. Bronte, T.R. Busiahn, M.P. Ebener, R.L. Eshenroder, T. Gorenflo, N. Kmiecik, W. Mattes, J.W. Peck, M. Petzold, D.R. Schneider. 2003. Fish-community objectives for Lake Superior. *Great Lakes Fish. Comm. Spec. Pub.* 03-01. 78 p.
- Larson, G.L., Christie, G.C., Johnson, D.A., Koonce, J.F., Mullett, K.M., and Sullivan, W.P. 2003. The history of sea lamprey control in Lake Ontario and updated estimates of suppression targets. *J. Great Lakes Res.* 29 (Supplement. 1): 637-654.
- Lavis, D.S., Hallett, A., Koon, E.M., and McAuley, T. 2003.. History of and advances in barriers as an alternative method to suppress sea lampreys in the Great Lakes. *J. Great Lakes Res.* 29 (Supplement 1): 584-598.
- Morse, T.J., Ebener, M.P., Koon, E.M., Morkert, S.B., Johnson, D.A., Cuddy, D.W., Weisser, J.W., Mullet, K.M., and Genovese, J.H. 2003. A case history of sea lamprey control in Lake Huron: 1979-1999. *J. Great Lakes Res.* 29 (Supplement 1): 599-614.
- Mullett, K.M., Heinrich, J.W., Adams, J.V., Young, R. J., Henson, M.P., McDonald, R.B., and Fodale, M.F. 2003. Estimating lake-wide abundance of spawning-phase sea lampreys (*Petromyzon marinus*) in the Great Lakes: extrapolating from sampled streams using regression models. *J. Great Lakes Res.* 29 (Supplement 1): 240-253
- Ryan, P.S., R. Knight, R. MacGregor, G. Towns, R. Hoopes, and W. Culligan. 2003. Fish-community goals and objectives for Lake



Erie. *Great Lakes Fish. Comm. Spec. Publ.* 03-02. 56 p.

Schleen, L.P., Christie, G.C., Heinrich, J.W., Bergstedt, R.A., Young, R.J., Morse, T.J., Lavis, D.S., Bills, T.D., Johnson J., and Ebener, M.P. *in press*. Development and implementation of an integrated program for control of sea lampreys in the St. Marys River. *J. Great Lakes Res.* 29 (Suppl. 1)

Stewart, T.J., Lange, R.E., Orsatti, S.D., Schneider, C.P., Mathers, A., and Daniels M.E. 1999. Fish-community objectives for Lake Ontario. *Great Lakes Fish. Comm. Spec. Pub.* 99-1. 56 p.

Sullivan, W.P., Christie, G.C., Cornelius, F.C., Fodale, M.F., Johnson, D.A., Koonce, J.F., Larson, G.L., McDonald, R.B., Mullet, K.M., Murray, C.K., and Ryan, P.A. 2003. The sea lamprey in Lake Erie: a case history. *J. Great Lakes Res.* 29 (Supplement. 1): 615-637.

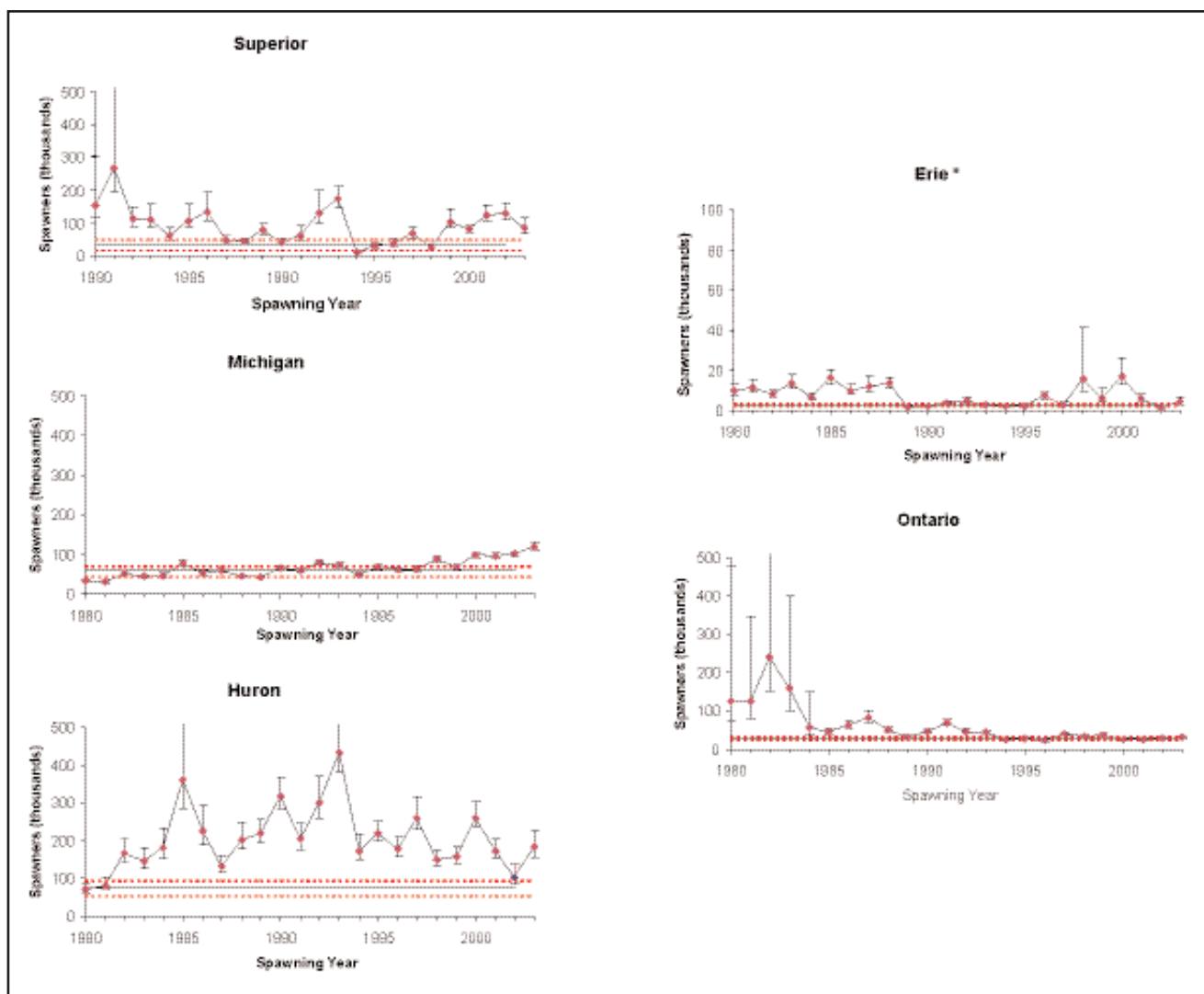
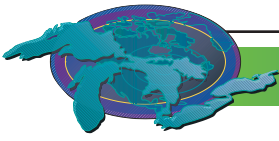


Figure 1. Total abundance of sea lampreys estimated during the spawning migration.

\*Note the scale for Lake Erie is 1/5 that of the other four lakes.



## Native Freshwater Mussels

SOLEC Indicator #68

### Assessment: Not Assessed

Data are not system-wide.

### Purpose

The purpose of this indicator is to report on the location and status of freshwater mussel (unionid) populations and their habitats throughout the Great Lakes system, with emphasis on endangered and threatened species. This information will be used to direct research aimed at identifying the factors responsible for mussel survival in refuge areas, which in turn will be used to predict the locations of other natural sanctuaries and guide their management for the protection and restoration of Great Lakes mussels.

### Ecosystem Objective

Restoration of the richness, distribution, and abundance of mussels throughout the Great Lakes reflecting the general health of the basin ecosystems. The long-term goal is for mussel populations to be stable and self-sustaining wherever possible throughout their historical range in the Great Lakes, including the connecting channels and tributaries.

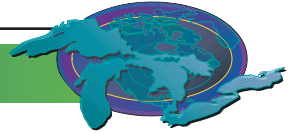
### State of the Ecosystem

Freshwater mussels (Bivalvia: Unionacea) are of unique ecological value as natural biological filters, food for fish and wildlife, and indicators of good water quality. In the United States, some species are commercially harvested for their shells and pearls. These slow-growing, long-lived organisms can influence ecosystem function such as phytoplankton ecology, water quality, and nutrient cycling. As our largest freshwater invertebrate, freshwater mussels may also constitute a significant proportion of the large freshwater invertebrate biomass. Because they are sensitive to toxic chemicals, mussels may serve as an early-warning system to alert us of water quality problems. They are also good indicators of environmental change due to their longevity and sedentary nature. Since mussels are parasitic on fish during their larval stage, they depend on healthy fish communities for their survival.

The richness, distribution, and abundance of mussels reflect the general health of the aquatic ecosystems and their shells make them easy to find. These shells, like butterflies, were prized by amateur collectors and naturalists in the past. As a result, many museums have extensive shell collections dating back 150 years or more that provide us with an invaluable “window to the past” that is not available for other aquatic invertebrates.

Freshwater mussels have severely declined across North America, particularly in the Great Lakes. Nearly 72% of the 300 species in North America are vulnerable to extinction or already extinct. The decline of unionids has been attributed to commercial exploitation, water quality degradation (pollution, siltation), habitat destruction (dams, dredging, channelization) riparian and wetland alterations, changes in the distribution and/or abundance of host fishes, and competition with non-native species. In the Great Lakes watershed, zebra mussels have caused a severe decline in unionid populations. Native mussels are particularly sensitive to biofouling from the non-native zebra mussel, *Dreissena polymorpha*, and to food competition with both the zebra mussel and quagga mussel (*Dreissena bugensis*). Many areas in the Great Lakes such as Lake St. Clair, and Lake Erie have lost over 99% of their unionid fauna (of all species) as dreissenid populations continue to expand. Only remnant unionid populations can be found in isolated habitats such as river mouths and lake-connected wetlands. These fragmented populations are at severe risk. Reproduction is occurring at some of these sites, but not all. Further problems are associated with unionid species that were in low numbers before the influx of the non-native dreissenids. A number of species listed as endangered or threatened in the United States or Canada, or in individual states (freshwater mussels are not considered for provincial listing at present), are found in some of these isolated populations in the Great Lakes and in associated tributaries. In the United States, these include the clubshell (*Pleurobema clava*), fat pocketbook (*Potamilus capax*), northern riffleshell (*Epioblasma torulosa rangiana*), and white catspaw (*Epioblasma obliquata peobliqua*). In Canada, the northern riffleshell, rayed bean (*Villosa fabalis*), wavy-rayed lampmussel (*Lampsilis fasciola*), mudpuppy mussel (*Simpsonia ambigua*), snuffbox (*Epioblasma triquetra*), round hickorynut (*Obovaria subrotunda*) and kidneyshell (*Ptychobranhus fasciolaris*) are listed as endangered.

The introduction of the zebra mussel to the Great Lakes in the late 1980s has decimated unionid communities throughout the system. Zebra mussels attach to a mussel's shell, where they interfere with activities such as feeding, respiration and locomotion - effectively



robbing it of the energy reserves needed for survival and reproduction. Lake Erie, Lake St. Clair and their connecting channels historically supported a rich mussel fauna of about 35 species. Unionid mussels were slowly declining in some areas even before the zebra mussel invasion. For example, densities in the western basin of Lake Erie decreased from 10 unionids/m<sup>2</sup> in 1961 to 4/m<sup>2</sup> in 1982, probably due to poor water quality. In contrast, the impact of the zebra mussel was swift and severe. Unionids were virtually extirpated from the offshore waters of western Lake Erie by 1990 and Lake St. Clair by 1994, with similar declines in the connecting channels and many nearshore habitats. The average number of unionid species found in these areas before the zebra mussel invasion was 18 (Fig. 1). After the invasion, 60% of surveyed sites had 3 or fewer species left alive, 40% of sites had none left, and abundance had declined by 90-95%.

It was feared that unionid mussels would be extirpated from Great Lakes waters by the zebra mussel. However, significant communities were recently discovered in several nearshore areas where zebra mussel infestation rates are low (Fig. 1).

All of the refuge sites discovered to date have two things in common: they are very shallow (<1-2 m deep), and they have a high degree of connectivity to the lake that ensures access to host fishes. These features appear to combine with other factors to discourage the settlement and survival of zebra mussels. Soft, silty substrates and high summer water temperatures in Metzger Marsh, Thompson Bay and Crane Creek encourage unionids to burrow, which dislodges and suffocates attached zebra mussels. Unionids living in firm, sandy substrates at the Nearshore Western Basin site were nearly infestation-free. The few zebra mussels found were less than 2 years old, suggesting that they may be voluntarily releasing from unionids due to harsh conditions created by wave action, fluctuating water levels and ice scour. The St. Clair Delta site has both wave-washed sand flats and wetland areas with soft, muddy sediments. It is thought that the numbers of zebra mussel veligers reaching the area may vary from year to year, depending on wind and current direction and water levels.

Since zebra mussels have a planktonic larval stage (called a veliger) that requires an average of 20-30 days to develop into the benthic stage, rivers and streams have limited colonization potential and can provide natural refugia for unionids. However, regulated rivers, i.e., those with reservoirs, may not provide refugia. Reservoirs with retention times greater than 20-30 days will allow veligers to develop and settle, after which the impounded populations will seed downstream reaches on an annual basis. It is therefore vital to prevent the introduction of zebra mussels into reservoirs.

#### **Future Pressures**

Zebra mussel expansion is the main threat facing unionids in the Great Lakes drainage basin. Zebra mussels are now found in all of the Great Lakes and in many associated water bodies - including at least 260 inland lakes and river systems such as the Rideau River in Ontario. Other nonnative species may also impact unionid survival through the reduction or redistribution of native fishes. Non-native fish species such as the Eurasian ruffe (*Gymnocephalus cernuus*) and round goby (*Neogobius melanostomus*) can completely displace native fish, thus causing the functional extirpation of local unionid populations. Continuing changes in land-use (increasing urban sprawl, growth of factory farms, etc.), elevated use of herbicides to remove aquatic vegetation from lakes for recreational purposes, climate change and the associated lowering of water levels, and many other factors will continue to have an impact on unionid populations in the future.

#### **Future Activities**

The long-term goal is for unionid mussel populations to be stable and self-sustaining wherever possible throughout their historical range in the Great Lakes, including the connecting channels and tributaries. The most urgent activity is to prevent the further introduction of non-native species into the Great Lakes. A second critical activity is to prevent the further expansion of non-native species into the river systems and inland lakes of the region where they may seriously harm the remaining healthy populations of unionids that could be used to re-inoculate the Great Lakes themselves in the future.

#### **Further Work Necessary**

1. Compile and review all existing information on the status of freshwater mussels throughout the Great Lakes drainage basin. A complete analysis of trends over space and time are needed to properly assess the current health of the fauna.
2. To assist with the above exercise, and to guide future surveys, combine all data into a computerized, GIS-linked database (similar to the 6000-record Ontario database managed by the National Water Research Institute) accessible to all relevant jurisdictions.



3. Conduct additional surveys to fill data gaps, using standardized sampling designs and methods for optimum comparability of data. The Freshwater Mollusk Conservation Society is currently preparing a peer-reviewed, state-of-the art protocol that should be consulted for guidance. Populations of endangered and threatened species should be specifically targeted.
4. Document the locations of all existing refugia, both within and outside of the influence of zebra mussels, and protect them by all possible means from future disturbance.
5. Conduct research to determine the mechanisms responsible for survival of unionids in the various refuge sites, and use this knowledge to predict the locations of other refugia and to guide their management. Research in the St. Clair Delta refuge will begin in 2003. Ensure that the environmental requirements of unionids are taken into account in wetland restoration projects.
6. Actively pursue all avenues for educating the public about the plight of unionids in the Great Lakes, and legislating their protection. This includes ensuring that all species that should be listed are listed as quickly as possible.
7. Apply the principles of the National Strategy for the Conservation of Native Freshwater Mussels (The National Native Mussel Conservation Committee 1998) to the conservation and protection of the Great Lakes unionid fauna.

#### Acknowledgments

Authors: Janice L. Smith, Biologist, Aquatic Ecosystem Impacts Research Branch, National Water Research Institute, Burlington, ON, E-mail: [Janice.Smith@ec.gc.ca](mailto:Janice.Smith@ec.gc.ca) and S. Jerrine Nichols, U.S. Geological Survey, Biological Resources Division, Ann Arbor, MI., E-mail: [s\\_jerrine\\_nichols@usgs.gov](mailto:s_jerrine_nichols@usgs.gov)

#### Sources

Bowers, R. and F. De Szalay. 2003. Effects of hydrology on unionids (Unionidae) and zebra mussels (Dreissenidae) in a Lake Erie coastal wetland. *American Midland Naturalist*. 151:286-300.

Freshwater Mollusk Conservation Society website: <http://ellipse.inhs.uiuc.edu/FMCS/>

Martel, A.L., D.A. Pathy, J.B. Madill, C.B. Renaud, S.L. Dean and S.J. Kerr. 2001. Decline and regional extirpation of freshwater mussels (Unionidae) in a small river system invaded by *Dreissena polymorpha*: the Rideau River, 1993-2000. *Can. J. Zool.* 79(12): 2181-2191.

Masteller, E.C. Pennsylvania State University at Erie, PA. Personal Communication, December 2001.

Metcalf-Smith, J.L., D.T. Zanatta, E.C. Masteller, H.L. Dunn, S.J. Nichols, P.J. Marangelo, and D.W. Schloesser. 2002. Some nearshore areas in Lake Erie and Lake St. Clair provide refuge for native freshwater mussels (Unionidae) from the impacts of invading zebra and quagga mussels (*Dreissena* sp.). Presented at the 45th Conference on Great Lakes Research, June 2-6, 2002, Winnipeg, Manitoba, abstract on p.87 of program.

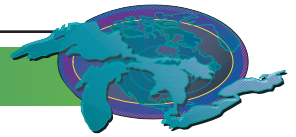
Nichols S.J. and J. Amberg. 1999. Co-existence of zebra mussels and freshwater unionids; population dynamics of *Leptodea fragilis* in a coastal wetland infested with zebra mussels. *Can. J. Zool.* 77(3): 423-432.

Nichols, S.J. and D.A. Wilcox. 1997. Burrowing saves Lake Erie clams. *Nature* 389: 921.

Schloesser, D.W., R.D. Smithee, G.D. Longdon, and W.P. Kovalak. 1997. Zebra mussel induced mortality of unionids in firm substrata of western Lake Erie and a habitat for survival. *American Malacological Bulletin* 14: 67-74.

The National Native Mussel Conservation Committee. 1998. National strategy for the conservation of native freshwater mussels. *J. Shellfish Res.* 17(5): 1419-1428.

Zanatta, D.T., G.L. Mackie, J.L. Metcalfe-Smith and D.A. Woolnough. 2002. A refuge for native freshwater mussels (Bivalvia: Unionidae) from impacts of the non-native zebra mussel (*Dreissena polymorpha*) in Lake St. Clair. *J. Great Lakes Res.* 28(3): 479-



489.

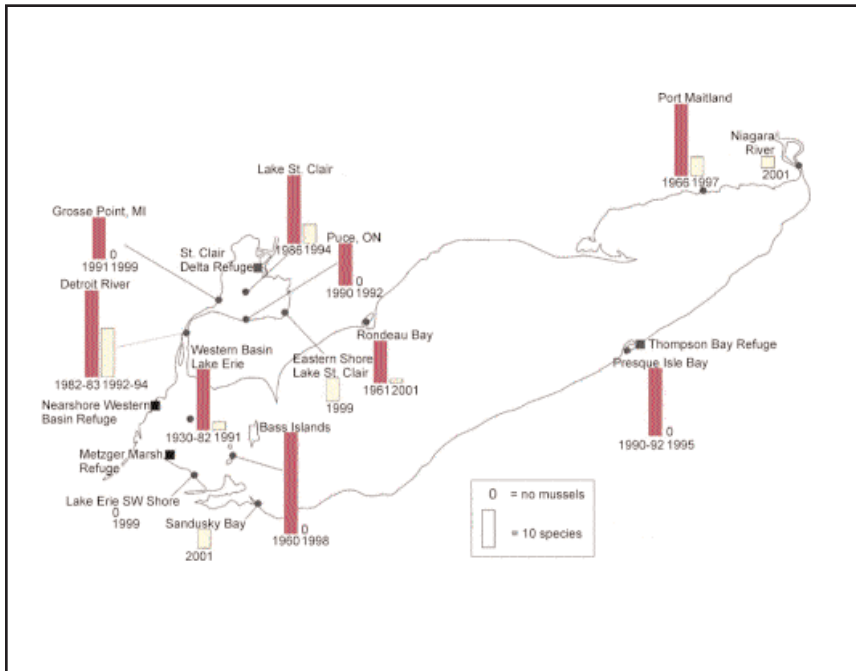
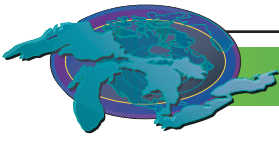


Figure 1: Numbers of freshwater mussel species found before and after the zebra mussel invasion at 13 sites in Lake Erie, Lake St. Clair, and the Niagara and Detroit rivers (no “before” data available for 4 sites), and the locations of the four known refuge sites (Thompson Bay, Metzger Marsh, Nearshore Western Basin, and St. Clair Delta). Source: Metcalfe-Smith, J.L., D.T. Zanatta, E.C. Masteller, H.L. Dunn, S.J. Nichols, P.J. Marangelo, and D.W. Schloesser. 2002.





## Lake Trout

SOLEC Indicator #93

**Assessment:**     **Mixed, Improving (Lakes Superior & Huron)**  
                          **Mixed, Unchanging (Lakes Michigan, Erie, & Ontario)**

### Purpose

This indicator tracks the status and trends in lake trout populations, and will be used to infer the basic structure of the cold water predator community and the general health of the ecosystem. Lake trout were historically the principal salmonine predator in the coldwater communities of the Great Lakes. By the late 1950s, lake trout were extirpated throughout most of the Great Lakes mostly from the combined effects of sea lamprey predation and over fishing. Restoration efforts began in the early 1960s with chemical control of sea lamprey, controls on exploitation, and stocking of hatchery-reared fish to rebuild populations. Full restoration will not be achieved until natural reproduction is established and maintained to sustain populations. To date, only Lake Superior has that distinction.

### Ecosystem Objective

Self-sustaining, naturally reproducing populations that support target yields to fisheries are the goal of the lake trout restoration program. Target yields approximate historical levels of lake trout harvest or adjusted to accommodate stocked non-native predators such as Pacific salmon. These targets are 4 million pounds (1.8 million kg) from Lake Superior, 2.5 million pounds (1.1 million kg) from Lake Michigan, 2.0 million pounds (0.9 million kg) from Lake Huron and 0.1 million pounds (0.05 million kg) from Lake Erie. Lake Ontario has no specific yield objective but has a population objective of 0.5-1.0 million adult fish that produce 100,000 yearling recruits annually through natural reproduction.

### State of Ecosystem

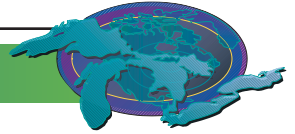
Lake trout abundance dramatically increased in all the Great Lakes after initiation of sea lamprey control, stocking, and harvest control. Natural reproduction from large parental stocks of wild fish is occurring throughout Lake Superior supports both onshore and offshore populations, and it may be approaching historical levels. Stocking there has been largely discontinued. Sustained natural reproduction, albeit at low levels, has also been occurring in Lake Ontario since the early 1990s, and in isolated areas of Lake Huron, but has been largely absent elsewhere in the Great Lakes. Parental stock sizes of hatchery-reared fish are relatively high in Lake Ontario and southern Lake Huron and in a few areas of Lake Michigan, but sea lamprey predation, fishery extractions, and low stocking densities have limited population expansion elsewhere.

### Future Pressures

Sea lamprey continues to limit population recovery, particularly in northern Lake Huron. Fishing pressures also continue to limit recovery. More stringent controls on fisheries are required to increase survival of stocked fish. In northern Lake Michigan parental stock sizes are low and young in age due to low stocking densities and moderate fishing mortality; hence egg deposition is low in most historically important spawning areas. High biomass of alewives and predators on lake trout spawning reefs are thought to inhibit restoration through egg and fry predation, although the magnitude of this pressure is unclear. A diet dominated by alewives may be limiting fry survival (early mortality syndrome) through thiamine deficiencies. The loss of *Diporeia* and dramatic reductions in the abundance of slimy sculpins is reducing prey for young lake trout and may be affecting survival. Current strains of lake trout stocked may not be appropriate for offshore habitats therefore limiting colonization potential.

### Future Activities

Continued sea lamprey control, especially on the St. Marys River is required to increase survival of lake trout to adulthood. New sea lamprey control options, which include pheromone systems that increase trapping efficiency and disrupt reproduction, are being researched and hold promised for improved control. Continued and enhanced control on exploitation is being improved through population modeling in the upper Great Lakes but needs to be applied throughout the basin. Stocking densities need to be increased in some areas, especially in Lake Michigan and the use of alternate strains of lake trout from Lake Superior could be candidates for deep, offshore areas not colonized by traditional strains used for restoration. The relationship between early mortality syndrome and alewives as prey needs to be further investigated to account for inconsistent experimental and empirical results. Directly stocking of eggs, fry, and yearling on or near traditional spawning sites should be used where possible to enhance colonization.



### Further Work Necessary

Reporting frequency should be every 5 years. Monitoring systems are in place but in most lakes measures do not directly relate to stated harvest objectives. Objectives may need to be redefined as end points in units measured by the monitoring activities.

### Acknowledgments

Authors: Charles R. Bronte, U.S. Fish and Wildlife Service, Green Bay, WI, James Markham, New York Department of Environmental Conservation, Brian Lantry, U.S. Geological Survey, Oswego, NY, Aaron Woldt, U.S. Fish and Wildlife Service, Alpena, MI, and James Bence, Michigan State University, East Lansing, MI.

### Sources

Bence, J.R. and M.P. Ebener (eds). 2002. Summary status of lake trout and lake whitefish populations in 1936 treaty-ceded waters of Lakes Superior, Huron and Michigan in 2000, with recommended yield and effort levels for 2001. Technical Fisheries Committee, 1836 Treaty-Ceded Waters of Lakes Superior, Huron and Michigan.

Bronte, C.R., S.T. Schram, J.H. Selgeby, and B.L. Swanson. 2002. Reestablishing a spawning population of lake trout in Lake Superior with fertilized eggs in artificial turf incubators. *N. Am. J. Fish. Manage.* 22:796-805.

Bronte, C.R. and 12 co-authors. 2003a. Success of current strategies to re-colonize lake trout spawning reefs in northern Lake Michigan. Final report, Project 1999.6, Great Lakes Fishery Trust.

Bronte, C.R., Ebener, M.P., Schreiner, D.R., DeVault, D.S., Petzold, M.M., Jensen, D.A., Richards, C., and Lozano, S.J. 2003b. Fish community change in Lake Superior, 1970-2000. *Can. J. Fish. Aquatic. Sci.* 60: 1552-1574.

Bronte, C. R., Jonas, J., Holey, M.E., Eshenroder, R.L., Toneys, M.L., McKee, P., Breidert, B., Claramunt, R.M., Ebener, M.P., Krueger, C.C., Wright, G., and Hess, R. 2003c. *Possible impediments to lake trout restoration in Lake Michigan*. Lake Trout Task Group report to the Lake Michigan Committee, Great Lakes Fishery Commission.

Cornelius, F.C., K.M. Muth, and R. Kenyon. 1995. Lake trout rehabilitation in Lake Erie: a case of history. *Journal of Great Lakes Research* 21 (Supplement 1):65-82.

DesJardine, R.L., T.K. Groenflo, R.N. Payne, and J.D. Schrouder. 1995. Fish community objectives for Lake Michigan. *Great Lakes Fish. Comm. Spec. Pub.* 95-1. 38p.

Elrod, J.H., R. O'Gorman, C.P. Schneider, T.H. Eckert, T. Schaner, J.N. Bowlby, and L.P. Schleen. 1995. Lake trout rehabilitation in Lake Ontario. *J. Great Lakes Res.* 21 (Suppl. 1): 83-107

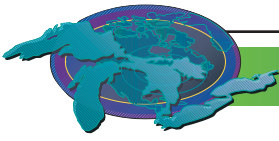
Eshenroder, R.L., M.E. Holey, T.K. Gorenflo, and R.D. Clark, Jr. 1995. Fish community objectives for Lake Michigan. *Great lakes Fish. Comm. Spec. Pub.* 95-3 56p.

Eshenroder, R.L., N.R. Payne, J.E. Johnson, C.A. Bowen II, and M.P. Ebener. 1995. Lake trout rehabilitation in Lake Huron. *Journal of Great Lakes Research* 21 (Supplement 1): 108-127

Hansen, M.J. [ED.]. 1996. A lake trout restoration plan for Lake Superior. *Great Lakes Fish. Comm.* 34p.

Hansen, M.J. 1999. Lake trout in the Great Lakes: basinwide stock collapse and binational restoration. *In Great Lakes Fisheries Policy and Management. Edited by W.W. Taylor and C.P. Ferreri.* Michigan State University Press, East Lansing, MI. pp. 417-454.

Holey, M.E., R.R. Rybicki, G.W. Eck, E.H. Brown, Jr., J.E. Marsden, D.S. Lavis, M. L. Toneys, T.N. Trudeau, and R.M. Horrall. 1995. Progress toward lake trout restoration in Lake Michigan. *Journal of Great Lakes Research* 21 (Supplement 1):128-151



Horns, W.H., C.R. Bronte, T.R. Busiahn, M.P. Ebener, R.L. Eshenroder, T. Gorenflo, N. Kmiecik, W. Mattes, J.W. Peck, M. Petzold, D.R. Schreiner. 2003. Fish community objectives for Lake Superior. Great Lakes Fish. Comm. Spec. Pub. 03-01. 78p.

Lake Trout Task Group. 1985a. A Strategic Plan for the rehabilitation of lake trout in eastern Lake Erie. Lake Erie Committee. Ann Arbor, MI.

Lantry, B.F., Eckert, T.H., O’Gorman, R. and Owens, R.W. 2003. Lake trout rehabilitation in Lake Ontario, 2002. In: NYDEC Annual Report to the Great Lakes Fishery Commission’s Lake Ontario Committee, March, 2003.

LSLTTTC (Lake Superior Lake Trout Technical Committee). 1986 A lake trout restoration plan for Lake Superior. In Minutes of the Lake Superior Committee (1986 annual minutes), Ann Arbor, MI, Great Lakes Fishery Commission, March 20, 1986.

Ryan, P.A., R. Knight, R. MacGregor, G. Towns, R. Hoopes, and W. Culligan. 2003. Fish-community goals and objectives for Lake Erie. Great Lakes Fish. Comm. Spec. Publ. 03-02. 56p.

Schneider, C.P., T. Schaner, S. Orsatti, S. Lary, and D. Busch. 1997. A Management Strategy for Lake Ontario Lake Trout. Report to the Lake Ontario Committee, Great Lakes Fishery Commission.

Wilberg, M. J., M. J. Hansen, and C. R. Bronte. 2003. Historic and modern density of wild lean lake trout in Michigan waters of Lake Superior: implications for restoration goals. *North American Journal of Fisheries Management* 23:100-108.

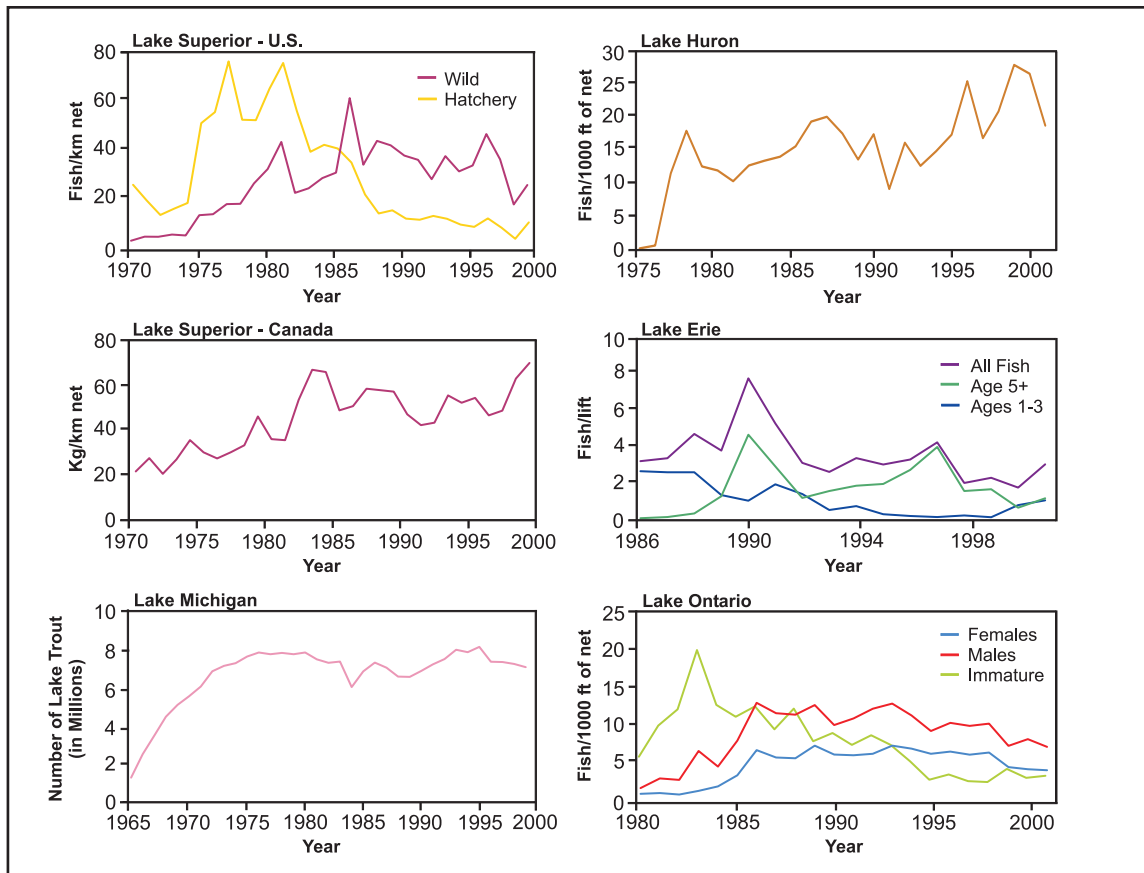
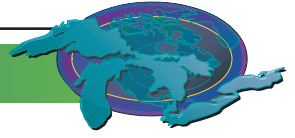


Figure 1: Relative or absolute abundance of lake trout in the Great Lakes. The measurement reported varies from Lake to Lake, as shown on the vertical scale, and comparisons between Lakes may be misleading. Overall trends over time provide information on relative abundances. Source: U.S. Fish and Wildlife Service



## Benthic Diversity and Abundance-Aquatic Oligochaete Communities

SOLEC Indicator #104

*This indicator report is from 2002.*

### Assessment: Mixed

#### Purpose

To assess species diversity and abundance of aquatic oligochaete communities in order to determine the trophic status and relative health of benthic communities in the Great Lakes.

#### Ecosystem Objective

Develop a measure of biological response to organic enrichment of sediments based on Milbrink's (1983) Modified Environmental Index. This measure will have wide application in nearshore, profundal, riverine, and bay habitats of the Great Lakes. This indicator supports Annex 2 of the Great Lakes Water Quality Agreement.

#### State of the Ecosystem

Shortly after intensive urbanization and industrialization during the first half of the 20<sup>th</sup> century, pollution abatement programs were initiated in the Great Lakes. Slowly, degraded waters and substrates, especially in shallow areas, began to improve in quality. By the early 1980s, abatement programs and natural biological processes changed habitats to the point where aquatic species tolerant of heavy pollution began to be replaced by species intolerant of heavy pollution.

Use of Milbrink's index values to characterize aquatic oligochaete communities provided one of the earliest measures of habitat quality improvements (e.g., western Lake Erie). This index has been used to measure changing productivity in waters of North America and Europe and, in general, appears to be a reasonable measure of productivity in waters of all the Great Lakes (Figures 1 and 2). Most index values from sites in the upper Lakes are relatively low and fall into the oligotrophic category, whereas index values from sites in known areas of higher productivity (e.g., nearshore southeastern Lake Michigan; Saginaw Bay, Lake Huron) exhibit higher index values. Sites in Lake Erie, which exhibit the highest index values, generally fall in the mesotrophic to eutrophic range, while in Lake Ontario nearshore sites are classified as mesotrophic, and offshore sites are oligotrophic.

#### Future Pressures

At present, future pressures that may change suitability of habitat for aquatic oligochaete communities are unknown. Undoubtedly, pollution programs and natural processes will continue to improve water and substrate quality. However, measurement of improvements could be overshadowed by things such as zebra and quagga mussels, which were an unknown impact only 10 years ago. Possible pressures include non-point pollution, regional temperature and water level changes, and discharges of contaminants such as pharmaceuticals, as well as from an as yet unforeseen source.

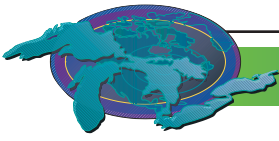
#### Future Activities

Continued pollution abatement programs aimed at point source pollution will continue to reduce undesirable productivity and past residual pollutants-as a result, substrate quality will improve.

Whatever future ecosystem changes occur in the Great Lakes, it is likely aquatic oligochaete communities will respond early to such changes.

#### Further Work Necessary

Biological responses of aquatic oligochaete communities are excellent indicators of substrate quality, and when combined with a temporal component allow the determination of subtle changes in environmental quality, possibly decades before single species indicators. It is only in the past few years, however, that this benthic index has been routinely applied to the open waters of all the Great Lakes. It is therefore critical that routine monitoring of oligochaete communities in the Great Lakes continue. In addition, oligochaete taxonomy is a highly specialized and time consuming discipline, and the classification of individual species responses to organic pollution is continually being up-dated. As future work progresses it is anticipated that the ecological relevance of existing and new species comprising the index will increase. It should be noted that even though this index only addresses responses to



organic enrichment in sediments, it may be used with other indicators to assess the effects of other sediment pollutants.

**Acknowledgments**

Authors: Don W. Schloesser, U.S. Geological Survey, Ann Arbor, MI; Richard P. Barbiero, Dyncorp I & ET, Inc., Chicago, IL, and Mary Beth Giancarlo, USEPA - Great Lakes National Program Office, Chicago, IL.

**Sources**

Data Source: USEPA Great Lakes National Program Office, Biological Open Water Surveillance Program of the Laurentian Great Lakes, 1997-1999.

Barbiero, Richard P. and Marc L. Tuchman. Results From GLNPO's Biological Open Water Surveillance Program Of The Laurentian Great Lakes 1999. EPA-905-R-02-001, January 2002.

Milbrink, G. 1983. An improved environmental index based on the relative abundance of oligochaete species. *Hydrobiologia* 102:89-97.

Quality Assurance Project Plan for the Great Lakes Water Quality Surveys, version March 2002, Great Lakes National Program Office-found in the Sampling and Analytical Procedures for GLNPO's Open Lake Water Quality Survey of the Great Lakes manual, version 2002, GLNPO-contact: Louis Blume, 312-353-2317, [blume.louis@epa.gov](mailto:blume.louis@epa.gov)

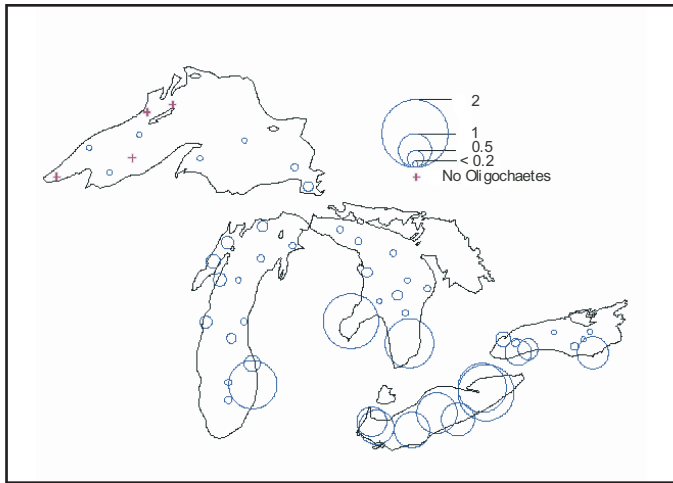
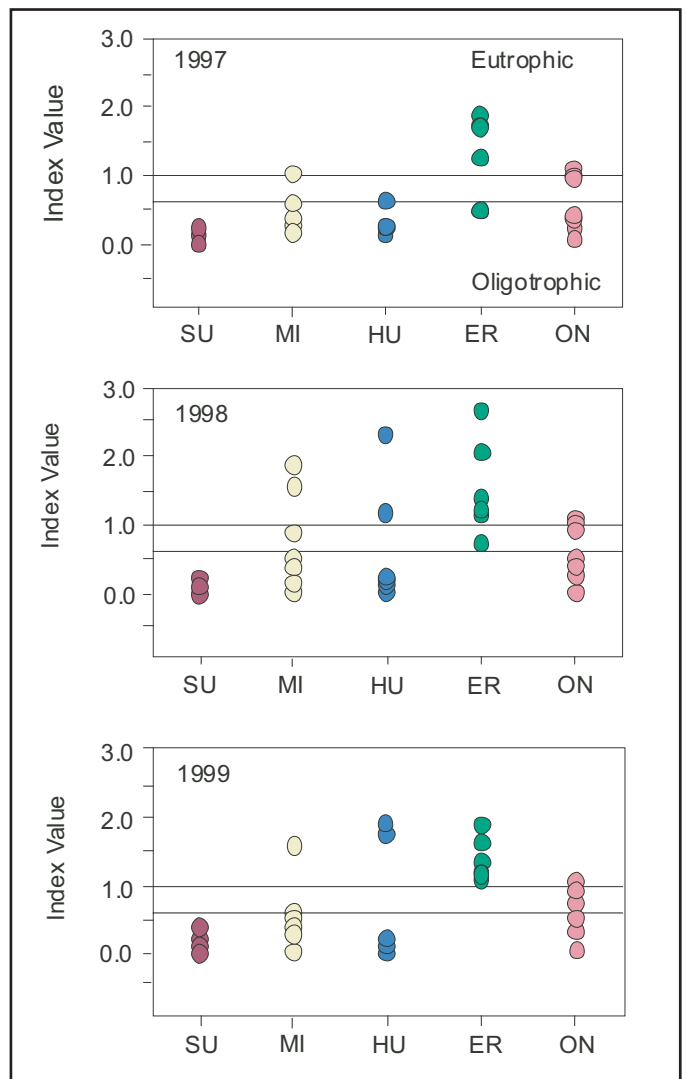
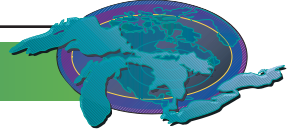


Figure 1: Milbrink's Modified Environmental Index applied to benthic oligochaete communities in the Great Lakes. Data are from 1999, U.S. Environmental Protection Agency - Great Lakes National Program Office Biological Open Water Surveillance Program of the Laurentian Great Lakes 1999, January 2002. Source: Barbiero, Richard P. and Marc Tuchman, 2002

Figure 2: Scatter plots of values of Milbrink's (1983) Modified Environmental Index, applied to data from GLNPO's 1997-1999 summer surveys. Source: U.S. Environmental Protection Agency, 1997-1999





## Phytoplankton Populations

SOLEC Indicator #109

*This indicator report is from 2002.*

### Assessment: Mixed

*This assessment is based on historical conditions and expert opinion. Specific objectives or criteria have not been determined.*

### Purpose

This indicator involves the direct measurement of phytoplankton species composition, biomass, and primary productivity in the Great Lakes, and indirectly assesses the impact of nutrient/contaminant enrichment and invasive non-native predators on the microbial food-web of the Great Lakes. It assumes that phytoplankton populations respond in quantifiable ways to anthropogenic inputs of both nutrients and contaminants, permitting inferences to be made about system perturbations through the assessment of phytoplankton community size, structure and productivity.

### Ecosystem Objective

Desired objectives are phytoplankton biomass size and structure indicative of oligotrophic conditions (i.e. a state of low biological productivity, as is generally found in the cold open waters of large lakes) for Lakes Superior, Huron and Michigan; and of mesotrophic conditions for Lakes Erie and Ontario. In addition, algal biomass should be maintained below that of a nuisance condition in Lakes Erie and Ontario, and in bays and in other areas wherever they occur. There are currently no guidelines in place to define what criteria should be used to assess whether or not these desired states have been achieved.

### State of the Ecosystem

Records for Lake Erie indicate that substantial reductions in summer phytoplankton populations occurred in the early 1990's in the western basin. The timing of this decline suggests the possible impact of zebra mussels. In Lake Michigan, a significant increase in the size of summer diatom populations occurred during the 1990's. This is most likely due to the effects of phosphorus reductions on the silica mass balance in this lake, and suggest that diatom populations in this lake might be a sensitive indicator of oligotrophication in Lake Michigan. No trends are apparent in summer phytoplankton Lakes Huron or Ontario, while only three years of data exist for Lake Superior. Data on primary productivity are no longer being collected.

No assessment of "ecosystem health" is currently possible on the basis of phytoplankton community data, since reference criteria and endpoints have yet to be developed.

It should be noted that these findings are at variance with those reported for SOLEC 2000. This is due to problems with historical data comparability that were unrecognized during the previous reporting period. These problems continue to be worked on, and as such conclusions reported here should be regarded as somewhat provisional.

### Future Pressures

The two most important potential future pressures on the phytoplankton community are changes in nutrient loadings and continued introductions and expansions of non-native species. Increases in nutrients can be expected to result in increases in primary productivity and possibly also in increases in phytoplankton biomass. In addition, increases in phosphorus concentrations might result in shifts in phytoplankton community composition away from diatoms and towards other taxa. As seen in Lake Michigan, reductions in phosphorus loading might be expected to have the opposite effect. Continued expansion of zebra mussel populations might be expected to result in reductions in overall phytoplankton biomass, and perhaps also in a shift in species composition, although these potential effects are not clearly understood. It is unclear what effects, if any, might be brought about by changes in the zooplankton community.

### Future Actions

The effects of increases in nutrient concentrations tend to become apparent in nearshore areas before offshore areas. The addition of nearshore monitoring to the existing offshore monitoring program might therefore be advisable. Given the greater heterogeneity of the nearshore environment, any such sampling program would need to be carefully thought out, and an adequate number of sampling



stations included to enable trends to be discerned.

### Further Work Necessary

A highly detailed record of phytoplankton biomass and community structure has accumulated, and continues to be generated, through regular monitoring efforts. However, problems exist with internal comparability of this database. Efforts are currently underway to rectify this situation, and it is essential that the database continue to be refined and improved.

In spite of the existence of this database, its interpretation remains problematic. While the use of phytoplankton data to assess “ecosystem health” is conceptually attractive, there is currently no objective, quantitative mechanism for doing so. Reliance upon literature values for nutrient tolerances or indicator status of individual species is not recommended, since the unusual physical regime of the Great Lakes makes it likely that responses of individual species to their chemical environment in the Great Lakes will vary in fundamental ways from those in other lakes. Therefore, there is an urgent need for the development of an objective, quantifiable index specific to the Great Lakes to permit use of phytoplankton data in the assessment of “ecosystem health”.

### Acknowledgments

Authors: Richard P. Barbiero, DynCorp, A CSC company, Chccicago, IL, rick.barbiero@dyncorp.com, and Marc L. Tuchman, USEPA GLNPO, Chicago, IL, [tuchman.marc@epa.gov](mailto:tuchman.marc@epa.gov).

### Sources

U.S. Environmental Protection Agency, Great Lakes National Program Office, Chicago, IL, unpublished data.

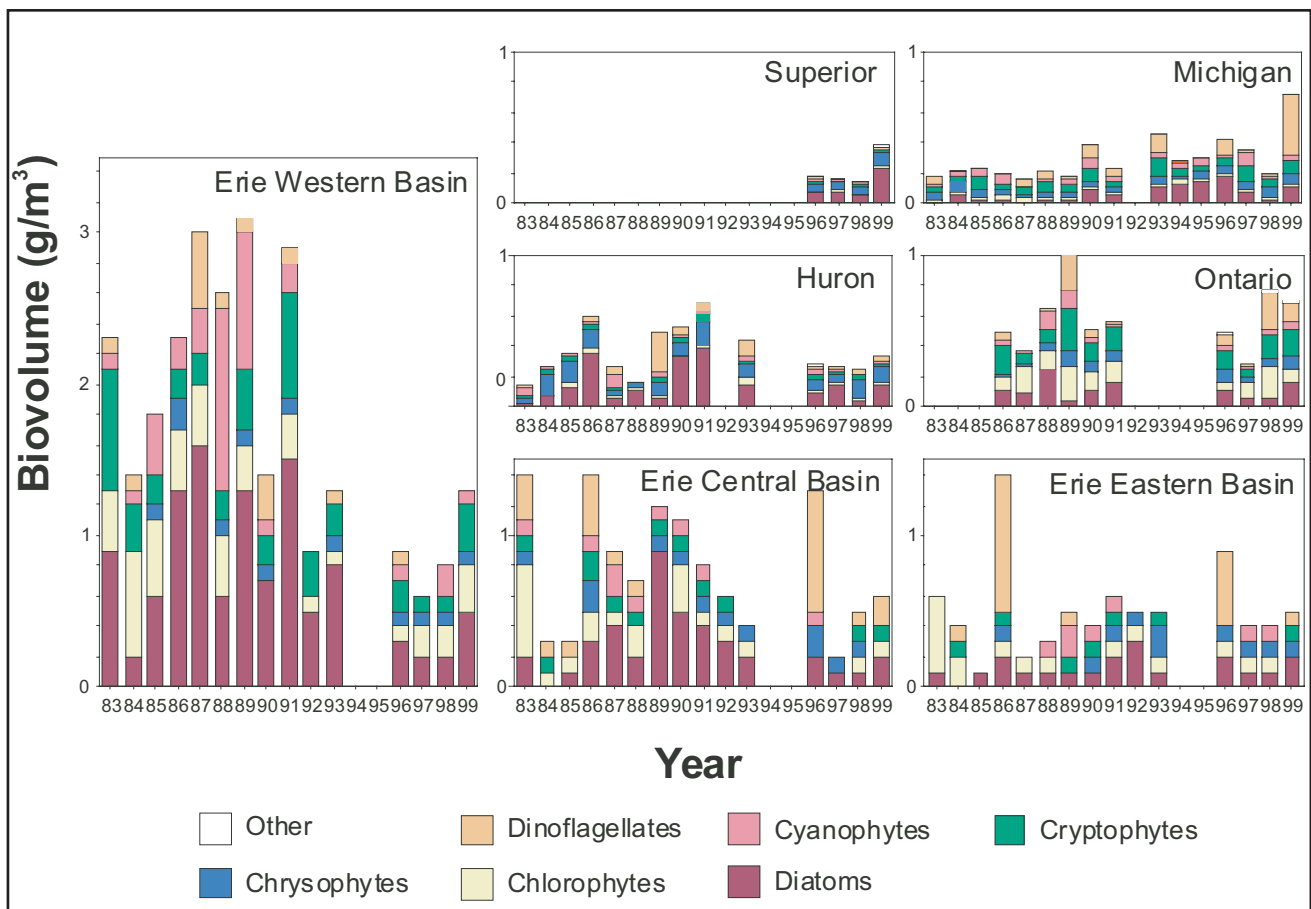
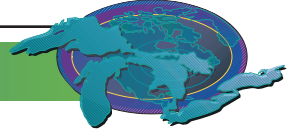


Figure 1. Trends in phytoplankton biovolume (g/m<sup>3</sup>) and community composition in the Great Lakes 1983- 1999. Samples were collected from offshore, surface waters during August.

Source: U.S. Environmental Protection Agency, Great Lakes National Program Office



## Phosphorus Concentrations and Loadings

SOLEC Indicator #111

**Assessment: Mixed, Undetermined**

### Purpose

This indicator assesses total phosphorus levels in the Great Lakes, and is used to support the evaluation of trophic status and food web dynamics in the Great Lakes. Phosphorus is an essential element for all organisms and is often the limiting factor for aquatic plant growth in the Great Lakes. Although phosphorus occurs naturally, the historical problems caused by elevated levels have originated from manmade sources. Detergents, sewage treatment plant effluent, agricultural and industrial sources have historically introduced large amounts into the Lakes.

### Ecosystem Objective

The goals of phosphorus control are to maintain an oligotrophic state in Lakes Superior, Huron and Michigan; to maintain algal biomass below that of a nuisance condition in Lakes Erie and Ontario; and to eliminate algal nuisance growth in bays and in other areas wherever they occur (GLWQA Annex 3). Maximum annual phosphorus loadings to the Great Lakes that would allow achievement of these objectives are listed in the GLWQA. The expected concentrations of total phosphorus in the open waters of the Great Lakes, if the maximum annual loads are maintained, are listed in the following table:

Lake	Phosphorus Guideline ( $\mu\text{g/L}$ )
Superior	5
Huron	5
Michigan	7
Erie - Western Basin	15
Erie - Central Basin	10
Erie - Eastern Basin	10
Ontario	10

Table 1. Phosphorus guidelines for the Great Lakes

### State of the Ecosystem

Strong efforts begun in the 1970s to reduce phosphorus loadings have been successful in maintaining or reducing nutrient concentrations in the Lakes, although high concentrations still occur locally in some embayments and harbors. Phosphorus loads have decreased in part due to changes in agricultural practices (e.g., conservation tillage and integrated crop management), promotion of phosphorus-free detergents, and improvements made to sewage treatment plants and sewer systems.

Average concentrations in the open waters of Lakes Superior, Michigan, Huron, and Ontario are at or below expected levels. Concentrations in the three basins of Lake Erie fluctuate from year to year (Figure 1) and frequently exceed target concentrations. In Lakes Ontario and Huron, although most offshore waters meet the desired guideline, some offshore and nearshore areas and embayments experience elevated levels which could promote nuisance algae growths such as the attached green algae, *Cladophora*.

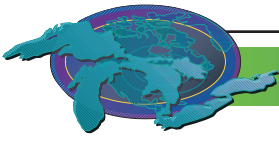
### Future Pressures

Even if current phosphorus controls are maintained, additional loadings can be expected. Increasing numbers of people living along the Lakes will exert increasing demands on existing sewage treatment facilities, possibly contributing to increasing phosphorus loads.

### Future Actions

Because of its key role in productivity and food web dynamics of the Great Lakes, phosphorus concentrations continue to be watched by environmental and fishery agencies. Future activities that are likely to be needed include: 1) Assess the capacity and operation of existing sewage treatment plants in the context of increasing human populations being served. Additional upgrades in construction or operations may be required; 2) Conduct sufficient tributary monitoring to support the calculation of annual loadings of phosphorus to each Great Lake by source category (i.e., sewage treatment plants, tributaries, etc.). If the phosphorus concentrations remain stable at or below the maximum target levels for most of the Lakes, loadings information might be useful, but not critical.





### Further Work Necessary

The analysis of phosphorus concentrations in the Great Lakes is ongoing and reliable. However, a coordinated enhanced monitoring program is required with agreement on specifics such as analytical and field methodologies, sampling locations, inclusion of nearshore and embayment sites, determination of the indicator metric and the index. The recent reappearance of *Cladophora* in some areas of the Great Lakes strengthens the importance of nearshore measurements. The data needed to support loadings calculations have not been collected since 1991 in all lakes except Erie, which has loadings information up to 2002, and Michigan with information for 1994 and 1995. Efforts to do so should be reinstated for at least Lake Erie. Otherwise, the loadings component of this SOLEC indicator will remain unreported, and changes in the different sources of phosphorus to the Lakes may go undetected.

### Acknowledgments

Authors: Scott Painter, Environment Canada, Burlington, ON & Glenn Warren, US EPA Chicago, Ill

### Sources

Great Lakes Water Quality Agreement (GLWQA). 1978. Revised Great Lakes Water Quality Agreement of 1978. As amended by Protocol November 18, 1987. International Joint Commission, Windsor, Ontario.

Richardson, V. Environmental Conservation Branch, Environment Canada.

Warren, G. Great Lakes National Program Office, U.S. Environmental Protection Agency.

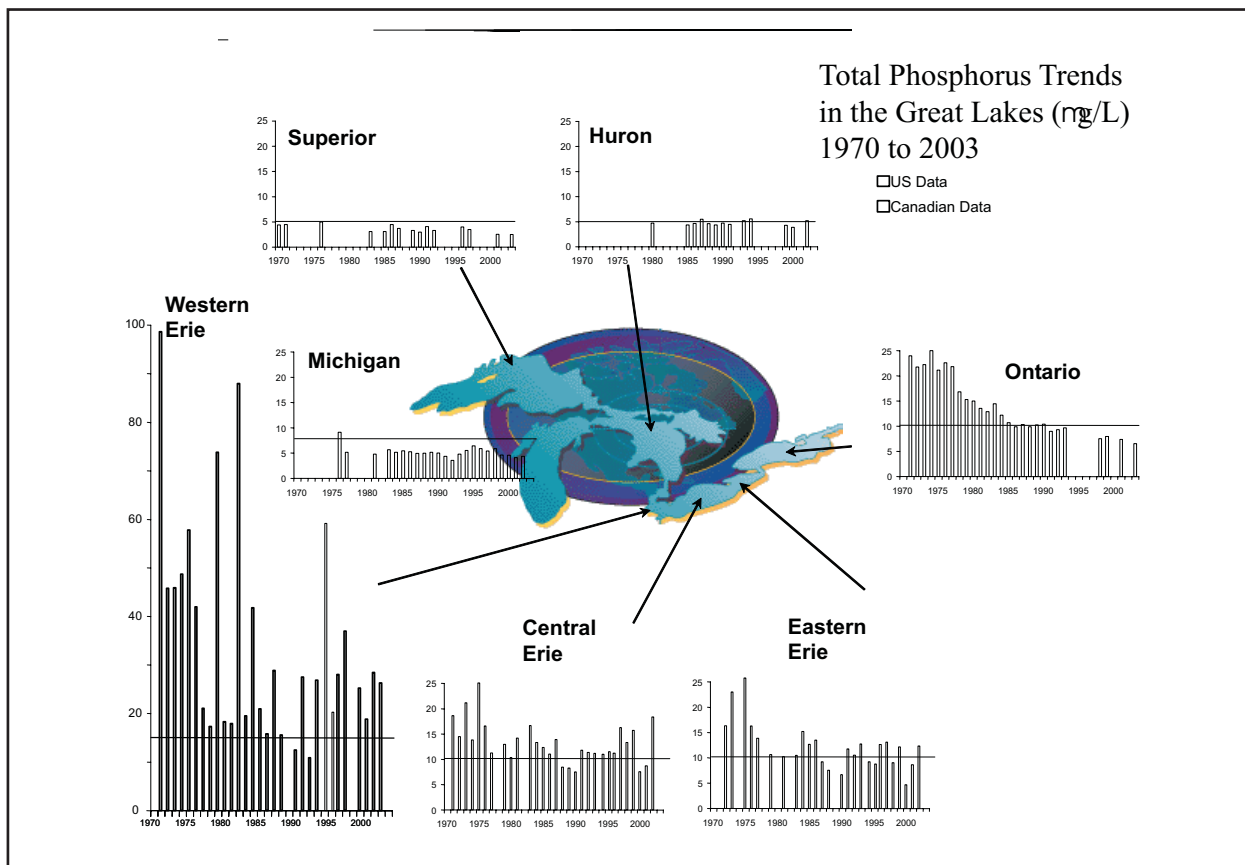
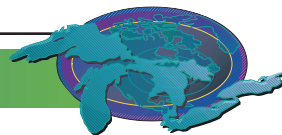


Figure 1. Total phosphorus trends in the Great Lakes 1971-2003 (Spring, Open Lake, Surface). Blank indicates no sampling. Horizontal line on each graphic represents the phosphorus guideline as listed in the Great Lakes Water Quality Agreement for each Lake. White bar graphs represent Environment Canada data. Black bar graphs represent U.S. Environmental Protection Agency data.

Source: Environmental Conservation Branch, Environment Canada and U.S. Environmental Protection Agency



## Contaminants in Young-of-the-Year Spottail Shiners

Indicator ID #114

**Assessment: Mixed, Improving**

### Purpose

Contaminant levels in fish are an important indicator of contaminant levels in a system because of the bioaccumulation of organochlorine chemicals in their tissues. Contaminants that are often undetectable in water may be detected in juvenile fish. Contaminant levels in young fish are a measure of the risk that these contaminants pose to fish-eating wildlife. Juvenile spottail shiner (*Notropis hudsonius*) was originally selected by Suns and Rees (1978) as the principal biomonitor for assessing trends in contaminant levels in local or nearshore areas. It was chosen as the preferred species because of its limited range in the first year of life; undifferentiated feeding habits in early stages; importance as a forage fish; and its presence throughout the Great Lakes. The position it holds in the food chain also creates an important link for contaminant transfer to higher trophic levels.

### Ecosystem Objective

To identify areas of concern and monitor contaminant trends over time for the near shore waters of the Great Lakes.

Concentrations of toxic contaminants in juvenile forage fish should not pose a risk to fish-eating wildlife. The International Joint Commission's Aquatic Life Guideline (GLWQA 1978), the New York State Department of Environmental Conservation (NYSDEC) Fish Flesh Criteria (Newell *et al.* 1987) for the protection of piscivorous wildlife and the Canadian Environmental Quality Guidelines (CCME 2001) are used as acceptable guidelines for this indicator. CCME guidelines for total DDT and dioxins and furans were not used in previous SOLEC reports and are much more stringent than the NYSDEC Fish Flesh Criteria that they replace. Contaminants detected in forage fish and their respective guidelines are listed in Table 1.

Contaminant	Tissue Residue Criteria (ng/g)
PCBs	100*
DDT, DDD, DDE	14 <sup>†</sup> (formerly 200)
Chlordane	500
Dioxin/Furans	0.00071 <sup>‡</sup> (formerly 0.003)
Hexachlorobenzene	330
Hexachlorocyclohexane (BHC)	100
Mirex	below detection*
Octachlorostyrene	20

\*IJC Aquatic Life Guideline for PCBs (IJC 1988); <sup>‡</sup> Environment Canada, 2000 (CCME 2001); <sup>†</sup> Environment Canada, 1997 (CCME 2001). All other values from NYSDEC Fish Flesh Criteria (Newell *et al.* 1987). Guidelines based on mammals and birds.

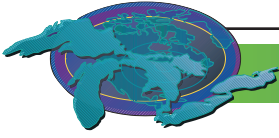
Table 1. Tissue Residue Criteria for various organochlorine chemicals or chemical groups for the protection of wildlife consumers of aquatic biota.

The guideline for mirex is below the detection limit, therefore, if mirex is detected, the guideline has been exceeded.

### State of the Ecosystem

With the incorporation of the new CCME guidelines, the total DDT (dichlorodiphenyl- trichloroethane) tissue residue criterion is exceeded at most locations. After total DDT, PCB (polychlorinated biphenyls) is the contaminant most frequently exceeding the guideline. Mirex is detected and exceeds the guideline only at Lake Ontario locations. Other contaminants listed in Table 1 are often not detected, or are present at levels well below the guidelines.

*Lake Erie:* Trends were examined for four locations in Lake Erie: Big Creek, Thunder Bay Beach, Grand River and Leamington. Overall, the trends show higher concentrations of PCBs in the early years with a steady decline over time. At Big Creek, PCB concentrations were elevated (>300 ng/g) until 1986. Since 1986, concentrations have remained near the guideline (100 ng/g). At the Grand River and Thunder Bay beach locations, PCBs exceeded the guideline in the late 1970s but in recent years have declined to less than the detection limit (20 ng/g). At Leamington, PCB concentrations declined from 888 ng/g in 1975 to 204 ng/g in 2001. Concentrations exceeded the guideline in all years except for a period in the early to mid-1990s. PCB concentrations continue to exceed the guideline in the most recent collection (2001). PCB levels at this site are considerably higher than at the other Lake Erie sites.



Total DDT concentrations at Lake Erie sites have also been declining. Concentrations of total DDT at Big Creek, Grand River and Thunder Bay Beach have declined considerably to near the guideline (14 ng/g). Maximum concentrations at these sites were found in the 1970s and ranged from 38 ng/g at Thunder Bay Beach to 75 ng/g at Big Creek. At Leamington, however, total DDT levels peaked at 183 ng/g in 1986. Since then, levels have declined but remain above the guideline.

*Lake Huron:* Trend data are available for two Lake Huron sites: Collingwood Harbour and Nottawasaga River. At Collingwood Harbour the highest PCB concentrations were found when sampling began in 1987 (206 ng/g). Since then, PCB concentrations have remained near or just below the guideline. At the Nottawasaga River the highest concentration of PCBs was in 1977 (90 ng/g). Concentrations declined to less than the detection limit by 1987. In 2002, PCBs were detected at very low levels.

Total DDT concentrations at Collingwood Harbour have remained near 40 ng/g since 1987. The guideline of 14 ng/g was exceeded in all years. At the Nottawasaga River site, there has been a steady decline in total DDT since 1977 when concentrations peaked at 106 ng/g. In 2002, levels were below the guideline.

*Lake Superior:* Trend data were examined for four locations in Lake Superior: Mission River, Nipigon Bay, Jackfish Bay and Kam River. In recent years, spottail shiners have become increasingly difficult to find. Therefore, at the first three locations, juvenile fish contaminant data have not been available recently, making it difficult to assess contaminant trends in the Lake.

Generally PCB concentrations were low in all years and at all locations. The highest PCB concentrations in Lake Superior were found at the Mission River in 1983 (139 ng/g). All other analytical results were below the guideline (100 ng/g). The highest concentrations of PCBs at the other three Lake Superior sites were also found in 1983 and ranged from 51 ng/g at Nipigon Bay to 89 ng/g at Jackfish Bay.

At Mission River and Nipigon Bay, total DDT levels were high in the late 1970s but decreased below the guideline (14 ng/g) by the mid 1980s. By 1990, DDT levels at Nipigon Bay rose to 66 ng/g which was the highest concentration in juvenile fish from Lake Superior. At Jackfish Bay and the Kam River, total DDT levels have been below the guideline each year, except for the Kam River in 1991, where levels rose above the guideline to 37 ng/g.

*Lake Ontario:* Contaminant concentrations from five sites were examined for trend analysis: Twelve Mile Creek, Burlington Beach, Bronte Creek, Credit River and the Humber River.

PCBs, total DDT and mirex are generally higher at these (and other Lake Ontario) locations than elsewhere in the Great Lakes. Overall, PCBs at all locations tended to be higher in the early years, ranging from 3 to 30 times the guideline. The highest concentrations of PCBs were found at the Humber River in 1978 (2938 ng/g). In recent years PCBs at the five sites have generally ranged from 100 ng/g to 200 ng/g.

Total DDT concentrations at all five locations have declined considerably since the late 1970s and early 1980s. However, at all of these locations, levels in juvenile fish still exceed the guideline (14 ng/g). The maximum reported concentration was at the Humber River in 1978 (443 ng/g). Currently, the typical concentration of total DDT at all five locations is approximately 50 ng/g.

Mirex has been detected intermittently at all five locations. The maximum concentration was 37 ng/g at the Credit River in 1992. Since 1992, mirex has not been detected at any of these locations.

*Lake Michigan* No spottail shiners were sampled from Lake Michigan.

#### **Future Activities**

Organochlorine contaminants have declined in juvenile fish throughout the Great Lakes. However, regular monitoring should continue for all of these areas to determine if levels are below wildlife protection guidelines. Analytical methods should be improved to accommodate revised guidelines and to include additional contaminants such as dioxins and furans, dioxin-like PCBs and polybrominated diphenyl ethers. For Lake Superior, the historical data do not include toxaphene concentrations. Since this contaminant is responsible for most of the consumption advisories and restrictions on sport fish from this lake (Scheider *et al.*, 1998), it is recommended that analysis of this contaminant be included in any future biomonitoring studies in Lake Superior.



Spottail shiners have been a useful indicator of contaminant levels in the past. However, this species is more difficult to find than it once was. Due to the difficulties in collecting this species in all areas of the Great Lakes, consideration should be given to adopting another forage fish species as the indicator when spottail shiners are not available. This will improve temporal and spatial trend data and result in a more complete dataset for the Great Lakes.

#### **Acknowledgements**

Author: Emily Awad and Alan Hayton, Sport Fish Contaminant Monitoring Program, Ontario Ministry of Environment, Etobicoke, ON.

Data: Sport Fish Contaminant Monitoring Program, Ontario Ministry of Environment.

#### **Sources**

CCME, 2001 'Canadian Environmental Quality Guidelines'. Canadian Council of Ministers of the Environment.

Great Lakes Water Quality Agreement (GLWQA). 1978. Revised Great Lakes Water Quality Agreement of 1978. As amended by Protocol November 18, 1987. International Joint Commission, Windsor, Ontario.

Newell, A.J., D.W. Johnson and L.K. Allen. 1987. Niagara River Biota Contamination Project: Fish Flesh criteria for Piscivorous Wildlife. Technical Report 87-3. New York State Department of Environmental Conservation, Albany, New York.

Scheider, W.A., C. Cox, A. Hayton, G. Hitchin, A. Vaillancourt. 1998. 'Current Status and Temporal Trends in Concentrations of Persistent Toxic Substances in Sport Fish and Juvenile Forage Fish in the Canadian Waters of the Great Lakes'. *Environmental Monitoring and Assessment*. **53**: 57-76.

Suns, K. and Rees, G. 1978. 'Organochlorine Contaminant Residues in Young-of-the-Year Spottail Shiners from Lakes Ontario, Erie, and St. Clair'. *J. Great Lakes Res.* **4**: 230-233.

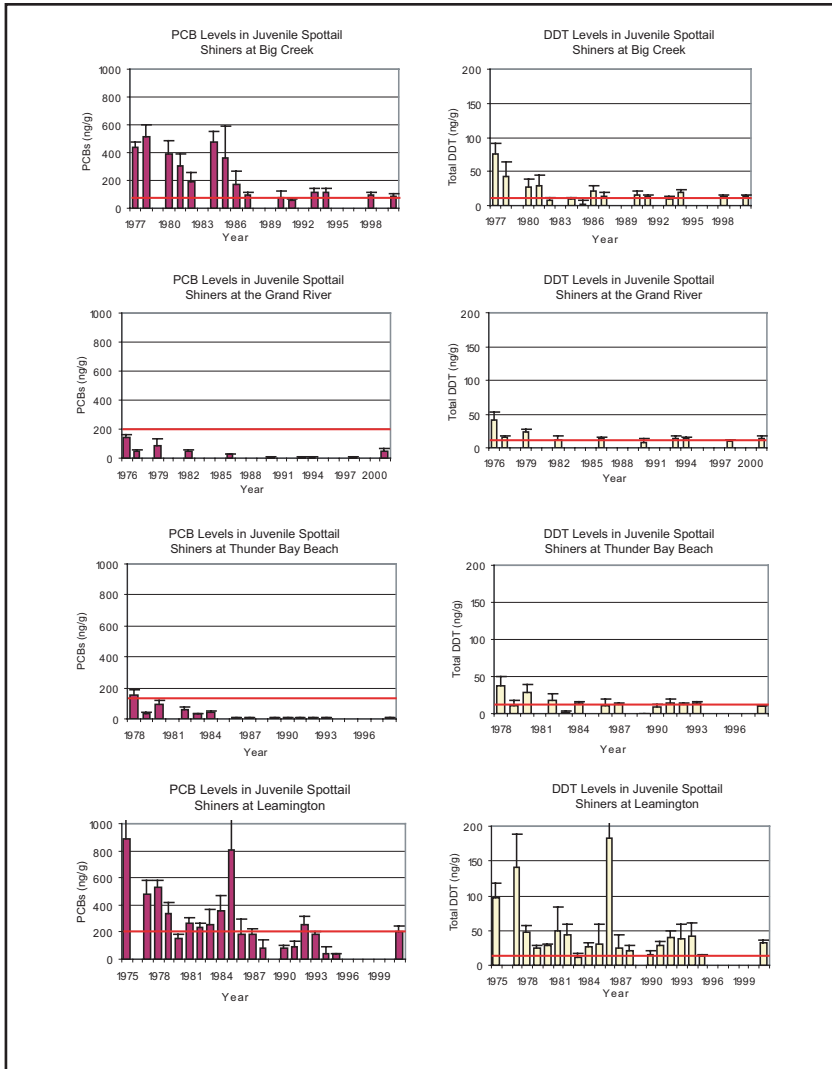
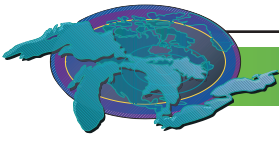


Figure 1. PCB and total DDT levels in juvenile spottail shiners from four locations in Lake Erie. The figures show mean concentration plus standard deviation. The red line indicates the wildlife protection guideline. When not detected, one half of the detection limit was used to calculate the mean concentration. Source: Ontario Ministry of the Environment

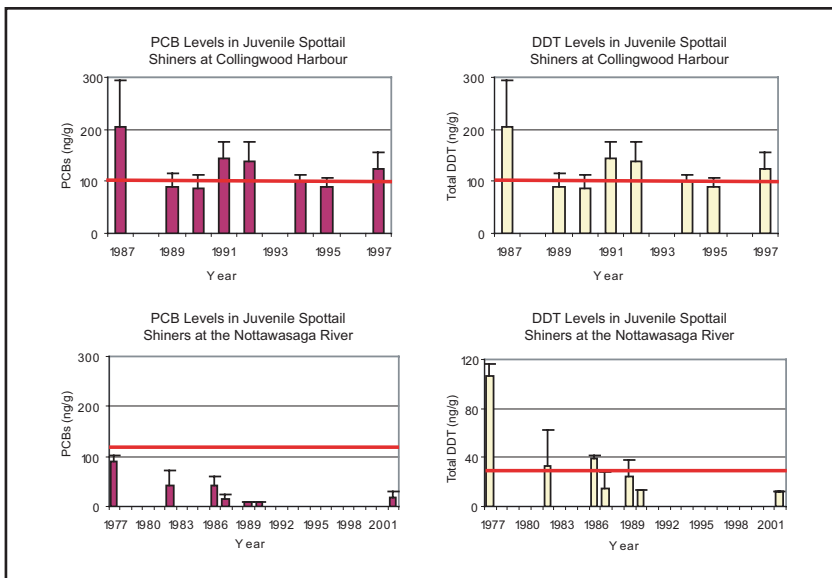


Figure 2. PCB and total DDT levels in juvenile spottail shiners from two locations in Lake Huron. The figures show mean concentration plus standard deviation. The red line indicates the wildlife protection guideline. When not detected, one half of the detection limit was used to calculate the mean concentration. Source: Ontario Ministry of the Environment

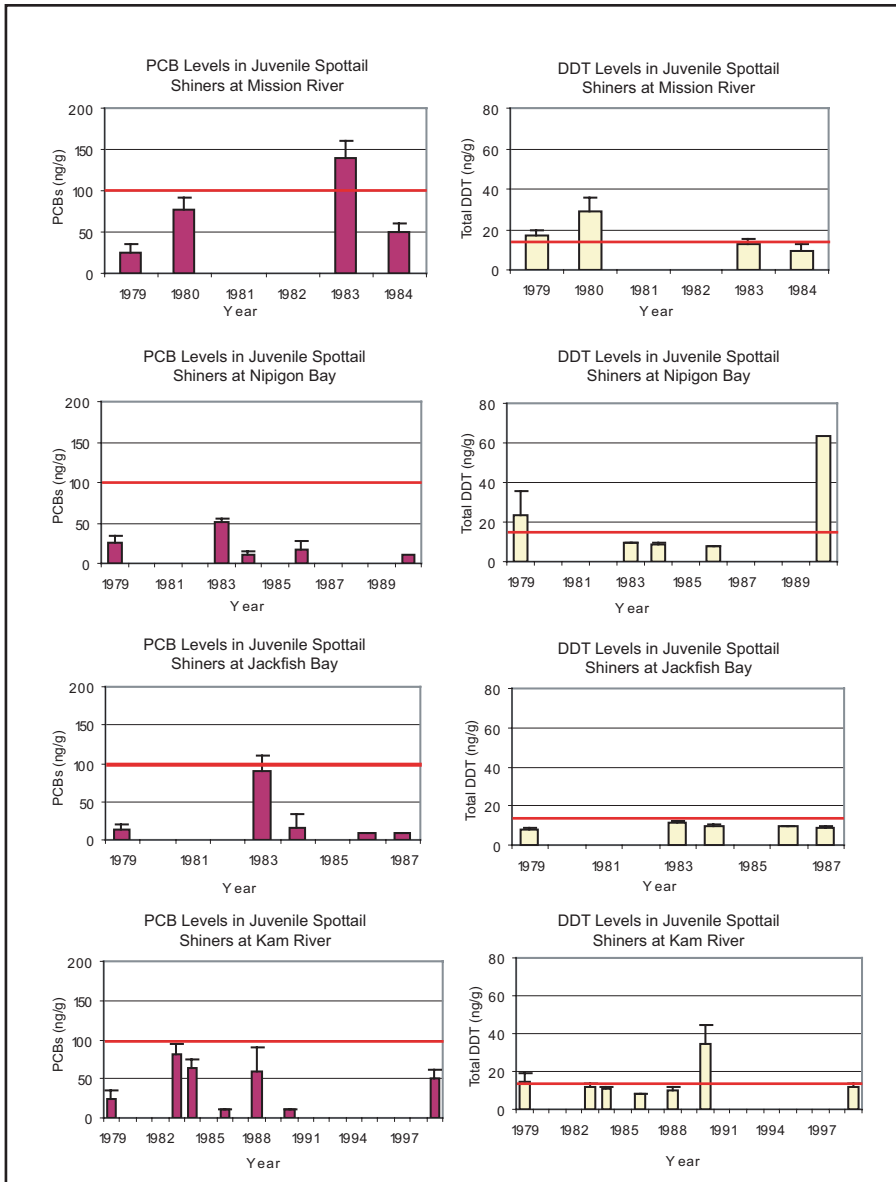
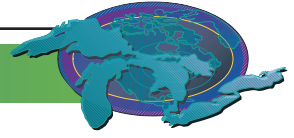


Figure 3. PCB and total DDT levels in juvenile spottail shiners from four locations in Lake Superior. The figures show mean concentration plus standard deviation. The red line indicates the wildlife protection guideline. When not detected, one half of the detection limit was used to calculate the mean concentration. Source: Ontario Ministry of the Environment

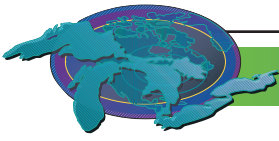
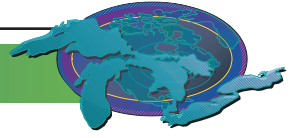


Figure 4. PCB, mirex, and total DDT levels in juvenile spottail shiners from five locations in Lake Ontario. The figures show mean concentration plus standard deviation. The red line indicates the wildlife protection guideline for PCBs and total DDT. For mirex, the red line indicates the detection limit (5ng/g). When not detected, one half of the detection limit was used to calculate the mean concentration.

Source: Ontario Ministry of the Environment



## Contaminants in Colonial Nesting Waterbirds

SOLEC Indicator #115

**Assessment: Mixed, Improving**

### Purpose

This indicator assesses current chemical concentrations and trends as well as ecological and physiological endpoints in representative colonial waterbirds (gulls, terns, cormorants and/or herons) on the Great Lakes. These features are used to infer and measure the impact of contaminants on the health, i.e. the physiology and breeding characteristics, of the waterbird populations. This indicator is important because colonial waterbirds are one of the top aquatic food web predators in the Great Lakes ecosystem and they are very visible and well known to the public. They bioaccumulate contaminants to the greatest concentration of any trophic level organism and they breed on all the Great Lakes. Thus, they are a very cost efficient monitoring system and allow easy inter-lake comparisons. The current Herring Gull Egg Monitoring Program is the longest continuous running annual wildlife contaminants monitoring program in the world (1974-present). It determines concentrations of up to 20 organochlorines, 65 PCB congeners and 53 PCDD and PCDF congeners (Braune *et al* 2003).

### Ecosystem Objective

One of the objectives of monitoring colonial waterbirds on the Great Lakes is to reach the point when there is no difference in contaminant levels and related biological endpoints between birds on and off the Great Lakes. When colonial waterbirds from the Great Lakes do not differ in chemical and biological parameters from birds off the Great Lakes, e.g. birds in northern Saskatchewan or the Maritimes, then one of our clean-up objectives will have been reached. Other objectives include determining temporal and spatial trends in contaminant levels in colonial waterbirds and detecting changes in their population levels on the Great Lakes. This includes promoting, developing and maintaining declining concentrations of all contaminants in Herring Gull eggs. With the exception of brominated diphenyl ethers, most of this objective has already been achieved (see below).

### State of the Ecosystem

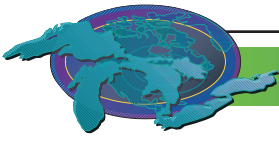
The Herring Gull Egg Monitoring Program has provided researchers and managers with a powerful tool (a 30 year database) to evaluate changes in contaminant concentrations in Great Lakes wildlife (Figure 1). The extreme longevity of the egg database makes it possible to calculate temporal trends in contaminant concentrations in wildlife and to look for significant changes within those trends. The database shows that most contaminants in gull eggs have declined a minimum of 50% and many have declined more than 90% since the program began in 1974 (Figure 2). In 2003, PCB, HCB, DDE, HE, dieldrin, mirex and 2,3,7,8-TCDD levels measured in eggs from the Annual Monitor Colonies (N=105 comparisons) were analysed for temporal trends. Analysis showed that in 72% of cases (76/105), the contaminants were decreasing as fast as or faster in recent years than they had in the past. In 22% of cases (23/105), contaminants were decreasing slower than they had in the past. (Calculated from Bishop *et al.* 1992, Pettit *et al.* 1994, Pekarik *et al.* 1998 and Jermyn *et al.* 2003, as per Pekarik and Weseloh, 1998.) PCBs were the compound showing the most frequent reduction in their rate of decline.

The sole exception to these declining Herring Gull egg contaminant concentrations appears to be brominated diphenyl ethers. These compounds, which are used as fire retardants in plastics, furniture cushions, etc. have increased dramatically in gull eggs in the last 20 years (Norstrom *et al.* 2002).

A comparison of concentrations of six contaminants at the 15 sites in 2001 and 2003 (N=90 comparisons) showed that in 51% of the cases (46/90), levels had decreased since 2001. In 47% of the cases (42/90), levels increased since 2001. DDE, dieldrin and PCBs were the most frequently declining contaminants, while mirex and HCB were the most frequently increasing contaminants. Two percent of the cases (2/90), both involving HCB, showed no change in levels from 2001 to 2003 (CWS unpubl. data). Annual fluctuations like these, including both short-term increases and decreases, are part of current contaminant patterns (Figure 1).

Another extremely useful way in which the Herring Gull data are used is in the determination of spatial patterns. For example, contaminant “hot spots” for wildlife have been identified by testing for spatial patterns among the 15 Annual Monitor Colonies (Weseloh *et al.* 1990, Ewins *et al.* 1992, Weseloh and Pekarik 2004) (Figures 3 and 4). Mean egg contaminant values for 1998-2002 showed that those from Channel-Shelter I. (LH) had the greatest concentrations of PCBs, TCDD and HCB; those from Gull I. (LM) had the greatest concentrations of DDE, dieldrin, HE and mercury; and, those from Snake I. (LO) had the greatest concentra-





tions of mirex (Figure 5). Overall eggs from these sites were the three dirtiest of the 15 sites, respectively. Eggs from Middle I. (LE), Chantry I. (LH) and Port Colborne (LE) were the least contaminated (Figure 3) (Jermyn *et al.* 2003).

In terms of gross ecological effects of contaminants on colonial waterbirds, e.g. eggshell thinning, failed reproductive success and population declines, most species seem to have recovered. Populations of most species have increased over the past 25-30 years, e.g. see Figure 6 (Blokpoel and Tessier 1993, 1996, 1997, 1998; Austin *et al.* 1996; Scharf and Shugart 1998, Cuthbert *et al.* 2001, Weseloh *et al.* 2002; Morris *et al.* 2003, Havelka and Weseloh (in review), Hebert *et al.* (in review), CWS unpubl. data). Although the gross effects appear to have subsided (but see Custer *et al.* 1999), there are many other subtle, mostly physiological and genetic endpoints that are being measured now that were not measured in earlier years (Fox 1993, Grasman *et al.* 1996, Yauk and Quinn 1999). A recent and ongoing study, the Fish and Wildlife Health Effects and Exposure Study, is assessing whether there are fish and wildlife health effects in Canadian Areas of Concern (AOCs) similar to those reported for the human population (Environment Canada 2003). To date, the following abnormalities have been found in Herring Gulls in one or more Canadian AOCs on the lower Great Lakes: a male-biased sex ratio in hatchlings, elevated levels of embryonic mortality, indications of feminization in more than 10% of adult males, a reduced or suppressed ability to combat stress, an enlarged thyroid with reduced hormone production and a suppressed immune system. Although there is little question that Herring Gulls and colonial waterbirds on the Great Lakes are healthier now than they were 30 years ago, these findings show that they are in a poorer state of health than are birds from clean reference sites in the Maritimes (Environment Canada 2003).

#### **Pressures**

Future pressures for this indicator include all sources of contaminants which reach the Great Lakes. This includes those sources that are already well known, e.g. point sources, re-suspension of sediments, as in western Lake Erie, and atmospheric inputs, such as PCBs in Lake Superior, as well as lesser known ones, such as underground leaks from landfill sites.

#### **Management Implications**

Data from the Herring Gull Egg Monitoring Program suggest that, for the most part, contaminant levels in wildlife are continuing to decline at a constant rate. However, even at current contaminant levels, physiological abnormalities in Herring Gulls are being found at Great Lakes sites compared to off the Lakes sites and research continues. Also, with the noted increase in concentrations of PBDEs, steps should be taken to identify and reduce sources of this compound to the Great Lakes. In short, although almost all contaminants are decreasing and many biological impacts have improved, we do not yet know the full health implications of the subtle effects.

#### **Future Activities**

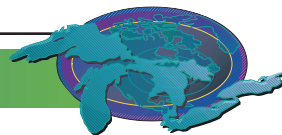
The annual collection and analysis of Herring Gull eggs from 15 sites on both sides of the Great Lakes and the assessment of that species' reproductive success is a permanent part of the CWS Great Lakes surveillance activities; likewise, so is the regular monitoring of population levels of most of the colonial waterbird species. The plan is to continue these procedures. Research work on improving and expanding the Herring Gull Egg Monitoring program is done on a more opportunistic, less predictable basis (see below, Further Work Necessary). A lake by lake intensive study of possible biological impacts to Herring Gulls is currently underway in the lower lakes.

#### **Further Work Necessary**

We have learned much about interpreting the Herring Gull egg contaminants data from associated research studies. However, much of this work is done on an opportunistic basis, when funds are available. Several research activities should be incorporated into routine monitoring, e.g. tracking of porphyria, vitamin A deficiencies and evaluation of the avian immune system. Likewise, more research should focus on new areas, e.g. the impact of endocrine disrupting substances and factors regulating chemically-induced genetic mutations.

#### **Acknowledgments**

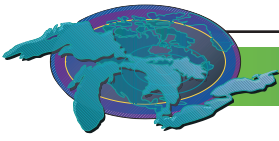
Authors: D.V. Chip Weseloh and Tania Havelka, Canadian Wildlife Service (CWS), Environment Canada, Downsview, ON. Thanks to past and present staff at CWS-Ontario Region, including Glenn Barrett, Christine Bishop, Birgit Braune, Neil Burgess, Rob Dobos, Pete Ewins, Craig Hebert, Kate Jermyn, Margie Koster, Brian McHattie, Peirre Mineau, Cynthia Pekarik, Karen Pettit, Jamie Ried, Peter Ross, Dave Ryckman, John Struger and Stan Teeple as well as past and present staff at the CWS National Wildlife Research Centre (Ottawa, ON), including Masresha Asrat, Glen Fox, Michael Gilbertson, Andrew Gilman, Jim Learning, Rosalyn



McNeil, Ross Norstrom, Laird Shutt, Mary Simon, Suzanne Trudeau, Bryan Wakeford, Kim Williams and Henry Won and wildlife biologists Ray Faber, Keith Grasman, Ralph Morris, Jim Quinn and Brian Ratcliff for egg collections, preparation, analysis and data management over the 30 years of this project. We are also grateful for the logistical and graphical support of the Technical Operations Division and the Drafting Department at the Canada Centre for Inland Waters, Burlington, Ontario.

#### Sources

- Austen, M.J., H. Blokpoel and G.D. Tessier. 1996. Atlas of colonial waterbirds nesting on the Canadian Great Lakes, 1989-1991. Part 4. Marsh-nesting terns on Lake Huron and the lower Great Lakes system in 1991. CWS, Ontario Region, Technical Report No. 217. 75pp.
- Bishop, C.A., D.V. Weseloh, N.B. Burgess, R.J. Norstrom, R. Turle and K.A. Logan. 1992. An atlas of contaminants in eggs of colonial fish-eating birds of the Great Lakes (1970-1988). Accounts by location & chemical. Volumes I & 2. CWS, Ontario Region, Technical Report Nos. 152 & 153, 400 & 300 pp.
- Blokpoel, H. and G.D. Tessier. 1993-1998. Atlas of colonial waterbirds nesting on the Canadian Great Lakes, 1989-1991. Parts 1-3, 5. CWS, Ontario Region, Technical Report Nos. 181, 225, 259, 272. 93 pp, 153 pp, 74 pp, 36 pp.
- Braune B.M., C.E. Hebert, L.S. Benedetti and B.J. Malone. 2003. An Assessment of Canadian Wildlife Service Contaminant Monitoring Programs. CWS Technical Report No. 400. Headquarters. Ottawa. 76 p.
- Custer, T.W., C.M. Custer, R.K. Hines, S. Gutreuter, K.L. Stromborg, P.D. Allen and M.J. Melancon. 1999. Organochlorine contaminants and reproductive success of Double-crested Cormorants from Green Bay, Wisconsin, USA. *Environmental Toxicology & Chemistry* 18:1209-1217.
- Environment Canada. 2003. Fish and wildlife health effects in the Canadian Great Lakes Areas of Concern. Great Lakes Fact Sheet. Catalogue No. CW/66-223/2003E. ISBN 0-662-34076-0
- Cuthbert, F.J., J. McKearnan and A.R. Joshi. 2001. Distribution and abundance of colonial waterbirds in the U.S. Great Lakes, 1997-1999. Report to U.S. Fish and Wildlife Service, Twin Cities, Minnesota.
- Ewins, P.J., D.V. Weseloh and P. Mineau. 1992. Geographical distribution of contaminants and productivity measures of Herring Gulls in the Great Lakes: Lake Huron 1980. *Journal of Great Lakes Research* 18(2):316-330.
- Fox, G.A. 1993. What have biomarkers told us about the effects of contaminants on the health of fish-eating birds in the Great Lakes? The theory and a literature review. *Journal of Great Lakes Research* 19:722-736.
- Fox, G.A., S.W. Kennedy, R.J. Norstrom, and D.C. Wgfield. 1988. Porphyria in herring gulls: a biochemical response to chemical contamination in Great Lakes food chains. *Environmental Toxicology & Chemistry* 7:831-839.
- Grasman, K.A., G.A. Fox, P.F. Scanlon and J.P. Ludwig. 1996. Organochlorine-associated immunosuppression in pre fledging Caspian terns and herring gulls from the Great Lakes: an ecoepidemiological study. *Environmental Health Perspect.* 104:829-842.
- Havelka, T. and D.V. Weseloh. In review. Continued growth and expansion of the Double-crested Cormorant (*Phalacrocorax auritus*) population on Lake Ontario, 1982-2002.
- Hebert, C.E. D.V. Weseloh, T. Havelka, C. Pekarik and F. Cuthbert. In review. Lake Erie colonial waterbirds: Trends in populations, contaminant levels and diet. The State of Lake Erie, M. Munawar (Ed.) Ecovision World Monograph Series, Aquatic Ecosystem Health and Management Society.
- Jermyn, K., C. Pekarik, T. Havelka, G. Barrett and D.V. Weseloh. 2003. An atlas of contaminants in eggs of colonial fish-eating birds of the Great Lakes (1998-2001). Accounts by location & chemical. Volumes I & 2. CWS, Ontario Region, Unpublished Report.



Morris, R.D., D.V. Weseloh and J.L. Shutt. 2003. Distribution and abundance of nesting pairs of Herring Gulls (*Larus argentatus*) on the North American great Lakes. *Journal of Great Lakes Research*. 29:400-426.

Norstrom, R.J., M. Simon, J. Moisey, B. Wakeford and D.V.C. Weseloh. 2002. Geographical distribution (2000) and temporal trends (1981-2000) of brominated diphenyl ethers in Great Lakes Gull eggs. *Environ. Sci. Technol.* 36:4783-4789.

Pekarik, C. and D.V. Weseloh. 1998. Organochlorine contaminants in Herring Gull eggs from the Great Lakes, 1974-1995: change-point regression analysis and shortterm regression. *Environmental Monitoring and Assessment* 53:77-115.

Pekarik, C., D.V. Weseloh, G.C. Barrett, M. Simon, C.A. Bishop, and K.E. Pettit. 1998. An atlas of contaminants in the eggs of fish-eating colonial birds of the great lakes (1993-1997). Accounts by location & chemical. Volumes I & 2. CWS, Ontario Region, Technical Report Nos. 321 & 322, 245 & 214 pp.

Pettit, K.E., C.A. Bishop, D.V. Weseloh and R.J. Norstrom. 1994. An atlas of contaminants in eggs of colonial fish-eating birds of the Great Lakes (1989-1992). Accounts by location & chemical. Volumes I & 2. CWS, Ontario Region, Technical Report Nos. 194 & 195, 319 & 300 pp.

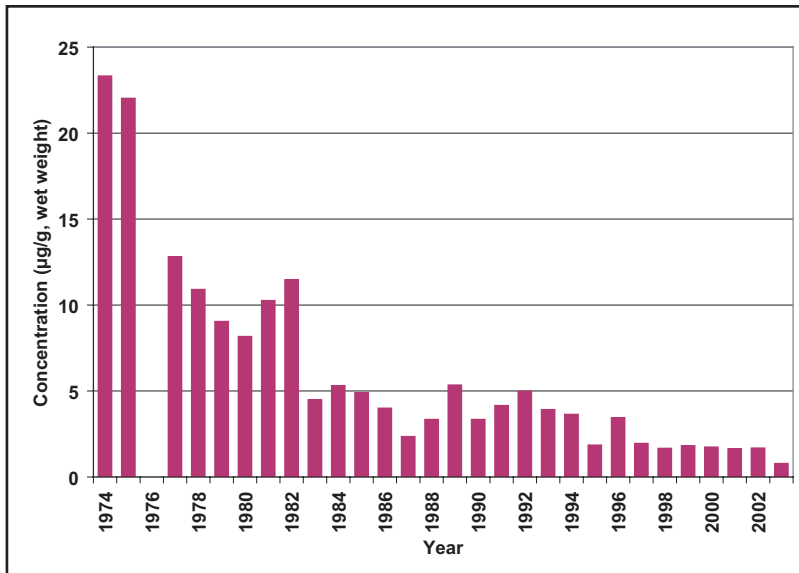


Figure 1. Temporal trends in concentrations of DDE in Herring Gull eggs, Toronto Harbour, 1974-2003.

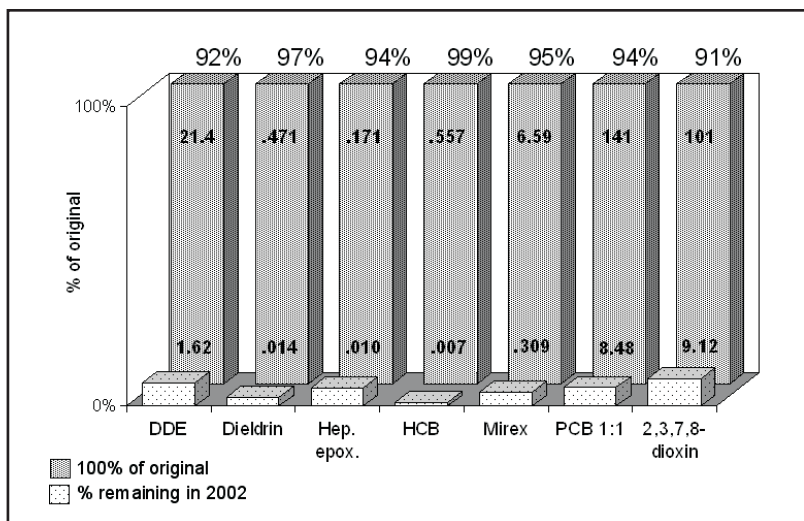


Figure 2. Mean contaminant concentrations and percent decline of 7 contaminants in Herring Gull eggs from year of first analysis (1974 for all compounds except 2,3,7,8-dioxin which was first analyzed in 1984) to present (2002), Snake Island, Lake Ontario. Concentrations in µg/g wet weight except for dioxin in pg/g wet weight.

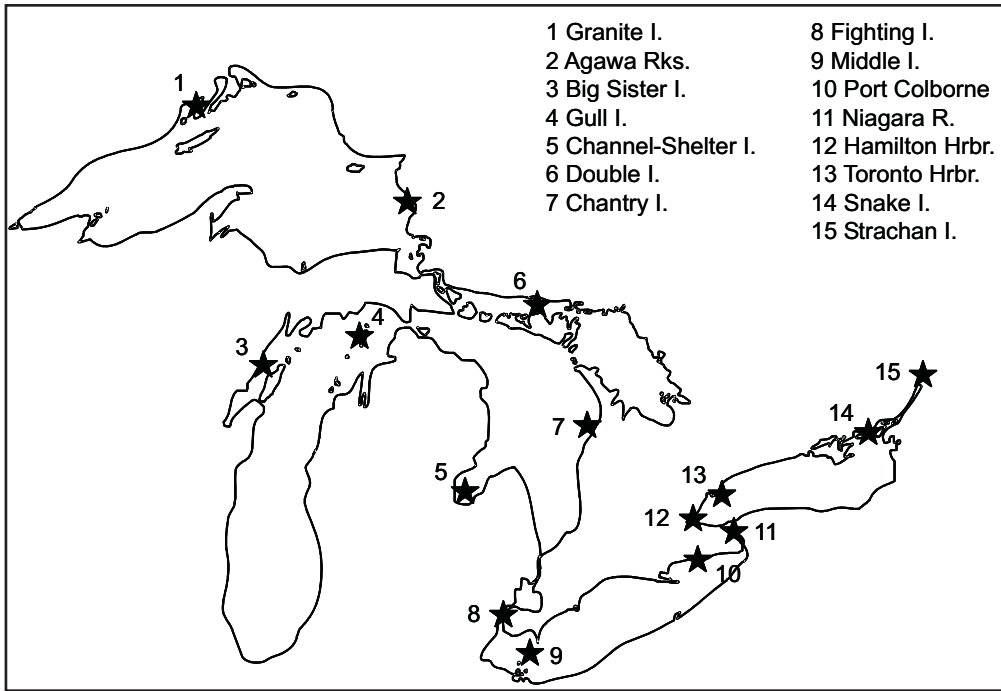
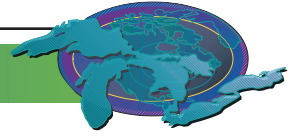


Figure 3. The distribution and locations of the 15 Herring Gull Annual Monitoring Colonies.

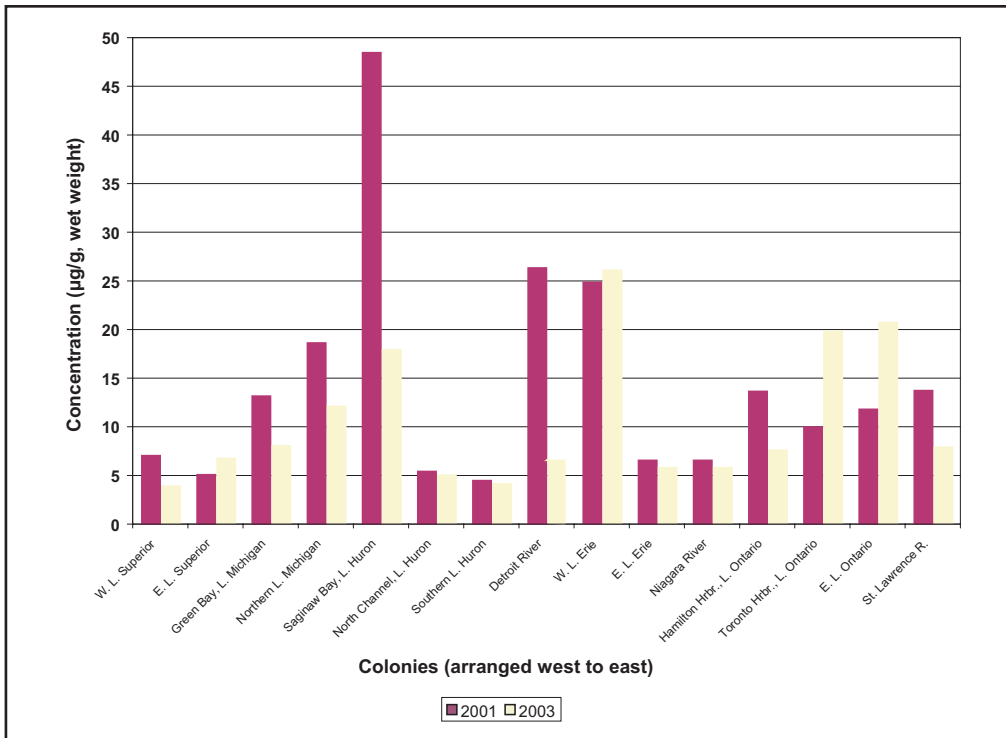


Figure 4. A comparison of PCB concentrations at all sites for 2001 and 2003. Note the between year differences as well as the variation among sites.

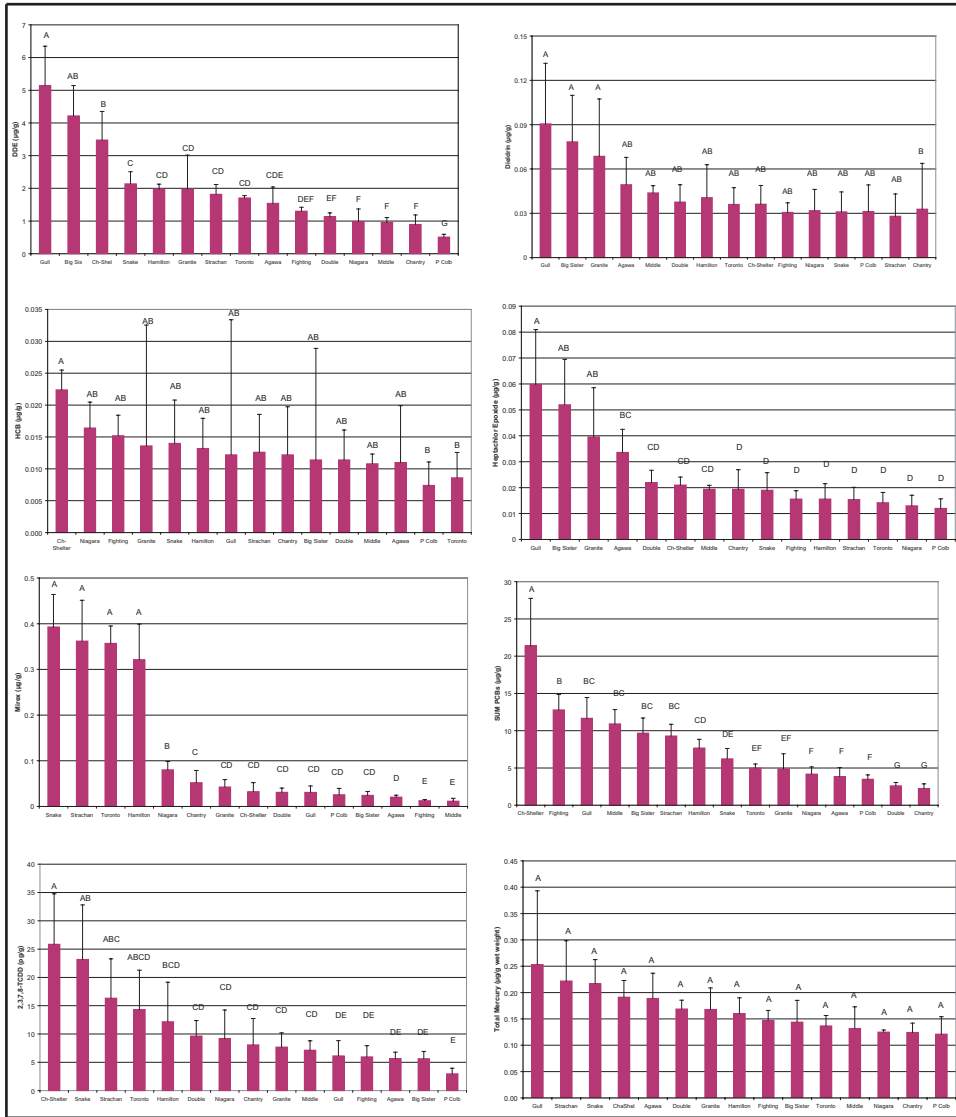
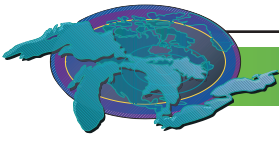


Figure 5. Spatial trends, 1998-2002. Means with the same letter are not significantly different (SNK Test). Error bars represent one standard deviation from the mean. Concentrations are reported in ug/g wet weight, except 2,3,7,8-dioxin which is reported as pg/g wet weight.

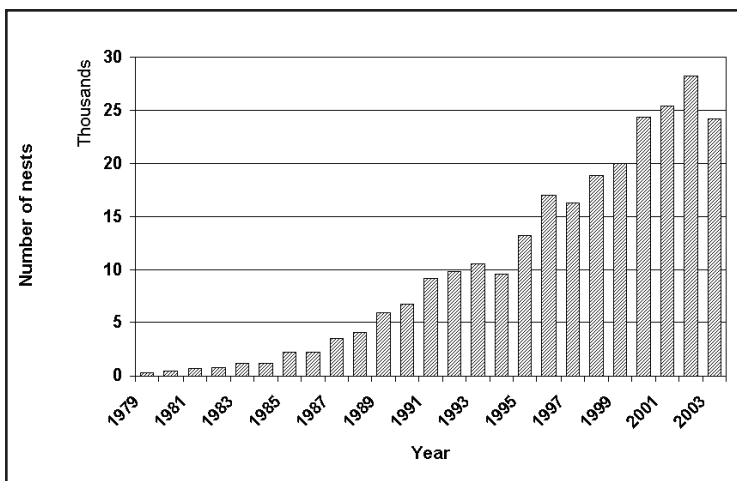
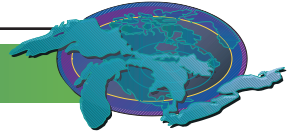


Figure 6. Double-crested Cormorant nests (breeding pairs) on Lake Ontario, 1979-2003.



## Zooplankton Populations

SOLEC Indicator #116

*This indicator report is from 2000. Assessment has been reevaluated in 2003. Specific objectives or criteria for assessment have not been determined.*

**Assessment: Mixed**

### Purpose

This indicator directly measures changes in community composition, mean individual size and biomass of zooplankton populations in the Great Lakes basin, and indirectly measures zooplankton production as well as changes in food-web dynamics due to changes in vertebrate or invertebrate predation; changes in system productivity, and changes in the type and intensity of predation and in the energy transfer within a system. Suggested metrics include zooplankton mean length, the ratio of calanoid to cladoceran and cyclopoid crustaceans, and zooplankton biomass.

### Ecosystem Objective

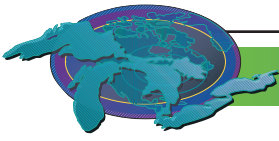
Ultimately, analysis of this indicator should provide information on the biological integrity of the Great Lakes, and lead to the support of a healthy and diverse fishery. However, the relationship between these objectives and the suggested metrics have not been fully worked out, and no specific criteria have yet been identified for these metrics. A mean individual size of 0.8 mm has been suggested as “optimal” for zooplankton communities sampled with a 153 mm mesh net, although the meaning of deviations from this objective, and the universality of this objective remain unclear. In particular, questions regarding its applicability to dreissenid impacted systems have been raised. In general, calanoid/cladoceran+cyclopoid ratios tend to increase with decreasing nutrient enrichment. Therefore high ratios are desirable. As with individual mean size, though, clear objectives have not presently been defined.

### State of the Ecosystem

The most recent available data (1998) suggests that mean individual lengths of offshore zooplankton populations in the three upper lakes and the central basin of Lake Erie exceed the objective of 0.8 (Fig. 1), suggesting a fish community characterized by a high piscivore/planktivore ratio. Mean individual lengths of zooplankton populations in the western and eastern basins of Lake Erie, as well as most sites in Lake Ontario, were substantially below this objective. Interquartile ranges for most lakes (considering the three basins of Lake Erie separately) were generally on the order of 0.1-0.2 mm, although Lake Ontario was substantially greater. Historical data from the eastern basin of Lake Erie, from 1985 to 1998, indicate a fair amount of interannual variability, with values from offshore sites ranging from about 0.5 to 0.85 (Fig. 2). As noted above, interpretation of these data are currently problematic. The ratio of calanoids to cladocerans and cyclopoids showed a clear relationship with trophic state. The average value for the oligotrophic Lake Superior was at least four times as high as that for any other lake, while Lakes Michigan and Huron and the eastern basin of Lake Erie were also high (Fig. 3). The western basin of Lake Erie and Lake Ontario were identically low, while the central basin of Lake Erie had an intermediate value. Historical comparisons of this metric are difficult to make because most historical data on zooplankton populations in the Great Lakes seems to have been generated using shallow (20 m) tows. Calanoid copepods tend to be deep living organisms; therefore the use of data generated from shallow tows would tend to contribute a strong bias to this metric. This problem is largely avoided in Lake Erie, particularly in the western and central basins, where most sites are shallower than 20 m. Comparisons in those two basins have shown a statistically significant increase in the ratio of calanoids to cladocerans and cyclopoids between 1970 and 1983-1987, with this increase sustained throughout the 1990's, and in fact up to the present. A similar increase was seen in the eastern basin, although some of these data were generated from shallow tows, and are therefore subject to doubt.

### Future Pressures on the Ecosystem

The zooplankton community might be expected to respond to changes in nutrient concentrations in the lakes, although the potential magnitude of such “bottom up” effects are not well understood. The most immediate potential threat to the zooplankton communities of the Great Lakes is posed by invasive species. An exotic predatory cladoceran, *Bythotrephes cederstroemii*, has already been in the lakes for over ten years, and is suspected to have had a major impact on zooplankton community structure. A second predatory cladoceran, *Cercopagis pengoi*, was first noted in Lake Ontario in 1998, and is expected to spread to the other lakes. In addition, the continued proliferation of dreissenid populations can be expected to impact zooplankton communities both directly through the alter-



ation of the structure of the phytoplankton community, upon which many zooplankton depend for food.

#### **Future Actions**

Continued monitoring of the off shore zooplankton communities of the Great Lakes is critical, particularly considering the current expansion of the range of the non-native cladoceran *Cercopagis* and the probability of future invasive zooplankton and fish species.

#### **Further Work Necessary**

Currently the most critical need is for the development of quantitative, objective criteria that can be applied to the zooplankton indicator. The applicability of current metrics to the Great Lakes is largely unknown, as are the limits that would correspond to acceptable ecosystem health. The implementation of a long term monitoring program on the Canadian side is also desirable, to expand both the spatial and the temporal coverage currently provided by American efforts. Since the of various indices is dependent to a large extent upon the sampling methods employed, coordination between of these two programs, both with regard sampling dates and locations, and especially with regard to methods, would be highly recommended.

#### **Acknowledgments**

This report was prepared by Richard P. Barbiero, DynCorp, A CSC company, Chcicago, IL, rick.barbiero@dyncorp.com, Marc L. Tuchman, USEPA GLNPO, Chicago IL USA, tuchman.marc@epa.gov, and Ora Johannsson, Fisheries and Oceans Canada, Burlington, Ontario Canada.

#### **Sources**

Johannsson, O.E., C. Dumitru, and D.M. Graham. 1999. Examination of zooplankton mean length for use in an index of fish community structure and application in Lake Erie. *J. Great Lakes Res.* 25:179-186.

U.S. Environmental Protection Agency, Great Lakes National Program Office, Chicago, IL, unpublished data.

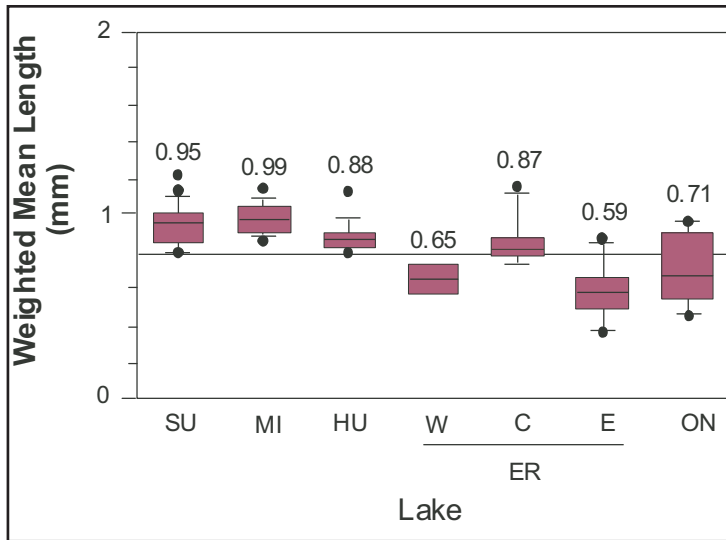
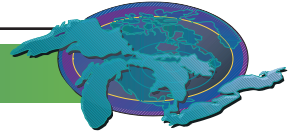


Figure 1. Average individual mean length of zooplankton for the five Great Lakes. Lake Erie is divided into western, central and eastern basins. Length estimates were generated from data collected with 153µm mesh net tows to a depth of 100m or the bottom of the water column, whichever was shallower. Numbers indicate arithmetic averages.  
Source: U.S. EPA – GLNPO, August, 1998

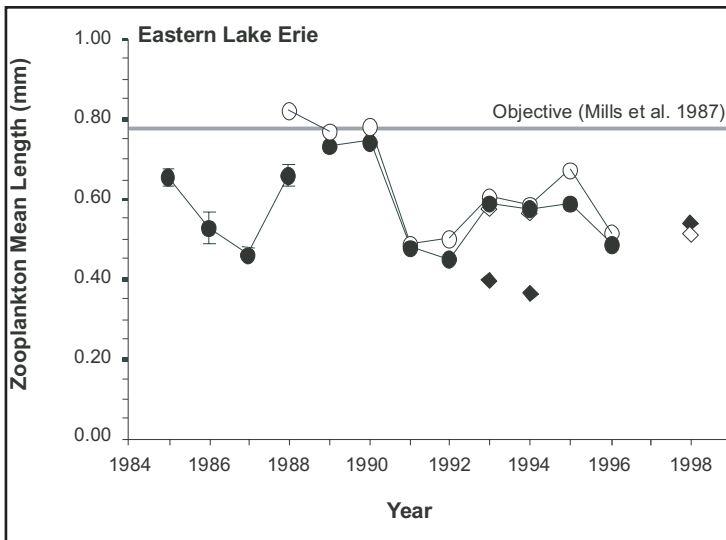


Figure 2. Trend in Jun27-Sep30 mean zooplankton length: NYDEC data (circles) collected with 153µm mesh net, DFP data (diamonds) converted from 64µm to 153µm mesh equivalent. Open symbols = offshore, solid symbols = nearshore (<12m). 1985-1988 are means +/- 1 S.E.  
Source: Johannsson et al., 1999

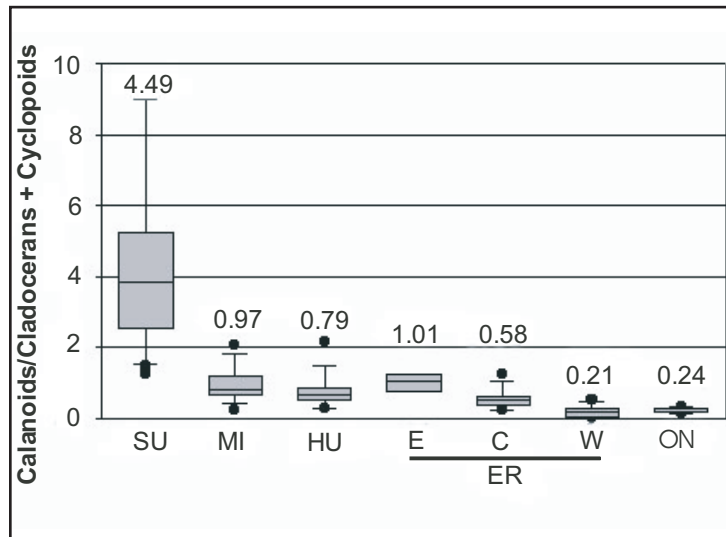
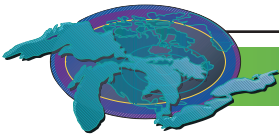


Figure 3. Ratio of biomass of calanoid copepods to that of cladocerans and cyclopoid copepods for the five Great Lakes. Lake Erie (ER) is divided into Western, Central and Eastern basins. Data collected with 153 µm mesh net tows to a depth of 100 meters of the bottom of the water column, whichever was shallower. Numbers indicate arithmetic averages.  
Source: U.S. Environmental Protection Agency-Great Lakes National Program Office, 1998





## Atmospheric Deposition of Toxic Chemicals

SOLEC Indicator #117

### Assessment:

**Mixed, Improving for polychlorinated biphenyls (PCBs), banned organochlorine pesticides, and dioxins and furans**  
**Mixed, Unchanging for polycyclic aromatic hydrocarbons (PAHs) and mercury**

Although concentrations and loadings of banned or restricted toxic chemicals (PCBs and banned organochlorine pesticides such as DDT) and concentrations of dioxins and furans are generally decreasing, concentrations and inputs of other substances are either staying level (PAHs, mercury) or possibly increasing (polybrominated diphenyl ethers [PBDEs], used as flame retardants, and other pollutants of emerging concern). While concentrations of some of these substances are very low at rural sites, they may be much higher in “hotspots” such as urban areas.

### Purpose

To estimate the annual average loadings of persistent bioaccumulative toxic (PBT) chemicals from the atmosphere to the Great Lakes and to determine trends over time in contaminant concentrations. This information will be used to aid in the assessment of potential impacts of toxic chemicals from atmospheric deposition on human health and the Great Lakes aquatic ecosystem, as well as to track the progress of various Great Lakes programs toward virtual elimination of toxic chemicals to the Great Lakes. Tracking atmospheric inputs is important since the air is a primary pathway by which PBTs reach the Great Lakes. Once PBTs reach the Great Lakes, they can bioaccumulate in fish and other wildlife and cause fish consumption advisories.

### Ecosystem Objective

The Great Lakes Water Quality Agreement (GLWQA) and the Binational Toxics Strategy both state the virtual elimination of toxic substances in the Great Lakes as an objective. Additionally, GLWQA General Objective (d) states that the Great Lakes should be free from materials entering the water as a result of human activity that will produce conditions that are toxic to human, animal, or aquatic life.

### State of the Ecosystem

The Integrated Atmospheric Deposition Network (IADN) consists of five master sampling sites, one near each of the Great Lakes, and several satellite stations. This joint United States-Canada project has been in operation since 1990. Since that time, thousands of measurements of the concentrations of PCBs, pesticides, PAHs, and trace metals have been made at these sites. Concentrations are measured in the atmospheric gas and particle phases and in precipitation. Spatial and temporal trends in these concentrations and atmospheric loadings to the Great Lakes can be examined. Data from other networks are used here to supplement the IADN data for mercury and dioxins and furans.

### Concentrations

Concentrations of gas-phase PCBs (SPCB) have generally decreased over time at the master stations (see Figure 1). SPCB is a suite of congeners that make up most of the PCB mass and represent the full range of PCBs. Some increases are seen during the late 1990s for Lakes Michigan and Erie and during 2000-2001 for Lake Superior. These increases remain unexplained, although there is some evidence of connections with atmospheric circulation phenomena such as El Nino (Ma et al. 2004a). Levels decrease again by 2002. It is assumed that PCB concentrations will continue to decrease slowly.

The Lake Erie site consistently shows relatively elevated SPCB concentrations compared to the other master stations. Back-trajectory analyses have shown that this is due to possible influences from upstate New York and the East Coast (Hafner and Hites 2003). Figure 2 shows that SPCB concentrations at the satellite station in downtown Chicago are about ten times higher than at the more remote master stations. Preliminary data from the new Cleveland station indicate that PCB levels in that city are lower than those in Chicago, but higher than at the master stations.

In general, concentrations of banned or restricted pesticides measured by the IADN (such as a-HCH and DDT) are decreasing over time in air and precipitation.

Benzo[*a*]pyrene (BaP), a PAH, is produced by the incomplete combustion of almost any fuel and is a probable human carcinogen.

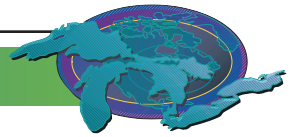


Figure 3 shows the annual average particle-phase concentrations of BaP. The concentrations of BaP (and PAHs in general) are relatively high at Lakes Erie and Ontario, sites near major population centers, and have not changed much over time at all sites. In general, PAH concentrations in Chicago, not shown, are about ten to one hundred times higher than at the master stations.

Data from the Canadian Atmospheric Mercury Network (CAMNet) for the IADN stations at Egbert and Point Petre indicate relatively stable total gaseous mercury concentrations between 1997 and 2000 (Blanchard et al. 2002).

Concentrations of dioxins and furans have decreased over time (Fig. 4) with the largest declines in areas with the highest concentrations (unpublished data, Environment Canada 2004).

PBDE data for IADN samples collected during 1997 through 1999 indicate relatively constant levels during that time period (Strandberg et al. 2001). However, a meta-analysis of PBDE concentrations in various environmental compartments and biota worldwide revealed exponentially increasing concentrations with doubling times of about 4-6 years and higher levels in North America than in Europe (Hites 2004). This implies that air concentrations in the Great Lakes may also be increasing; such a trend would be revealed once more data are collected in the basin.

#### Loadings

An atmospheric loading is the amount of a pollutant entering a lake from the air, which equals wet deposition (rain) plus dry deposition (falling particles) plus gas absorption into the water minus volatilization out of the water. Absorption minus volatilization equals net gas exchange, which is the most significant part of the loadings for most IADN pollutants. Figure 5 shows net gas exchange loadings for Lake Michigan for PCBs, *a*-HCH, and *g*-HCH (lindane). A bar pointing downward indicates that the net loading is negative, and the compound is volatilizing into the atmosphere. This occurs after the main sources to the air have been cut off and the air becomes “cleaner” relative to the water. The figure shows that the absolute values of the loadings are getting smaller, which indicates that the lake water and the air above it are close to being in equilibrium. PCBs continue the trend of volatilizing out of the Lakes but tending towards equilibrium (Blanchard et al. 2004).

Like concentrations, loadings of banned organochlorine pesticides continue to decline. Current-use pesticides, such as *g*-HCH (lindane) and  $\gamma$ -endosulfan, are still depositing to the Lakes from the atmosphere.

In general, for trace metals wet deposition is always more important than dry deposition and there is a lack of trend over time. This is consistent with continuing emissions of trace metals.

A report on the atmospheric loadings of these compounds to the Great Lakes has recently been published for data through 2000. It is available online at:

<http://www.epa.gov/glnpo/monitoring/air/iadn/iadn.html>

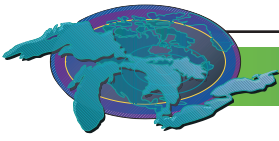
To receive a hardcopy, please contact one of the agencies listed at the end of this report.

#### **Future Pressures**

Atmospheric deposition of toxic compounds to the Great Lakes is likely to continue into the future. Compounds no longer in use, such as most of the organochlorine pesticides, may decrease to undetectable levels, especially if they are phased out in developing countries, as is being called for in international agreements.

Residual sources of PCBs remain in the U.S. and throughout the world; therefore, atmospheric deposition will still be significant at least decades into the future. PAHs and metals continue to be emitted and therefore concentrations of these substances may not decrease or will decrease very slowly. Even though emissions from many sources of mercury and dioxin have been reduced over the past decade, both pollutants are still seen at elevated levels in the environment. This problem will continue unless the emissions of mercury and dioxin are further reduced.

Atmospheric deposition of chemicals of emerging concern, such as brominated flame retardants and other compounds that may currently be under the radar, could also serve as a future stressor on the Great Lakes. Actions are being taken in the United States and in



Europe to reduce use of certain types of PBDEs. IADN is starting to monitor PBDEs; thus in the future decreases in levels of these chemicals may be observed.

### **Management Implications**

In terms of in-use agricultural chemicals, such as lindane, further restrictions on the use of these compounds may be warranted. Transport of lindane to the Great Lakes following planting of lindane-treated canola seeds in the Canadian prairies has been demonstrated by modelers (Ma et al. 2004b). Controls on the emissions of combustion systems, such as factories and motor vehicles, could decrease inputs of PAHs to the Great Lakes' atmosphere.

Although concentrations of PCBs continue to decline slowly, somewhat of a "leveling-off" seems to be occurring in air, fish, and other biota as shown by various long-term monitoring programs. Remaining sources of PCBs, such as contaminated sediments, sewage sludge, and in-use electrical equipment, may need to be addressed more systematically through efforts like the Canada-US Binational Toxics Strategy and EPA's Persistent Bioaccumulative Toxics (PBT) Program in order to see more significant declines. Many such sources are located in urban areas, which is reflected by the higher levels of PCBs measured in Chicago by IADN and by other researchers in other areas (Wethington and Hornbuckle in review; Totten et al. 2001). Research to investigate the significance of these remaining sources is underway. Such work will help prioritize PCB disposal and remediation projects in order to further reduce atmospheric deposition. This is important since fish consumption advisories for PCBs exist for all five Great Lakes.

Progress has been made in reducing emissions of dioxins and furans, particularly through regulatory controls on incinerators. Residential garbage burning (burn barrels) is now the largest current source of dioxins and furans (GLBTS Annual Progress Report 2002). Basin- and nationwide efforts are underway to eliminate emissions from burn barrels.

Regulations on coal-fired electric power plants, the largest remaining source of anthropogenic mercury air emissions, will help to decrease loadings of mercury to the Great Lakes.

Voluntary pollution prevention activities, technology-based pollution controls, and chemical substitution (for pesticides and industrial chemicals) can aid in reducing the amounts of toxic chemicals deposited to the Great Lakes. Efforts to achieve reductions in use and emissions of toxics worldwide through international assistance and negotiations should also be supported, since PBTs used in other countries can reach the Great Lakes through long-range transport.

Continued long-term monitoring of the atmosphere is necessary in order to measure progress brought about by toxic reduction efforts. Environment Canada and USEPA are currently adding dioxins and PBDEs to the IADN as funding allows. Mercury monitoring at Canadian stations is being done through the Canadian Atmospheric Mercury Network (CAMNet). Further funding is needed to implement mercury monitoring for the U.S. side of IADN. Additional urban monitoring is also needed to better characterize atmospheric deposition to the Great Lakes.

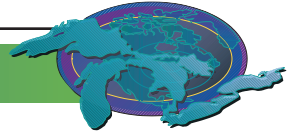
### **Acknowledgments**

Author: This report was prepared on behalf of the IADN Steering Committee by Melissa Hulting, IADN Program Manager, US EPA Great Lakes National Program Office.

### **IADN Contacts**

IADN Principal Investigator  
Air Quality Research Branch  
Environment Canada  
4905 Dufferin Street  
Toronto, ON M3H 5T4

IADN Program Manager  
Great Lakes National Program Office  
US Environmental Protection Agency  
77 West Jackson Boulevard, G-17J  
Chicago, IL 60604



## Sources

Blanchard et al. 2002. Four Years of Continuous Total Gaseous Mercury (TGM) Measurements at Sites in Ontario, Canada. *Atmospheric Environment* 36 (23): 3735-43.

Blanchard et al. 2004. Atmospheric Deposition of Toxic Substances to the Great Lakes: IADN Results Through 2000. United States Environmental Protection Agency and Environment Canada, 129 pp. (ISBN# 0-662-37467-3. Public Works and Government Services Canada Catalogue Number En56-156/2000-1E. US EPA Report Number 905-R-04-900.)

Environment Canada National Air Pollution Surveillance (NAPS) Network 2004, unpublished.

Environment Canada and U.S. Environmental Protection Agency 2003. The Great Lakes Binational Toxics Strategy 2002 Annual Progress Report. <http://binational.net/bns/2002/index.html>.

Hafner, W. and Hites, R. 2003. Potential Sources of Pesticides, PCBs, and PAHs to the Atmosphere of the Great Lakes. *Environmental Science and Technology* 37 (17): 3764-3773.

Hites, R. 2004. Polybrominated Diphenyl Ethers in the Environment and in People: A Meta-Analysis of Concentrations. *Environmental Science and Technology* 38 (4): 945-956.

IADN Steering Committee 2004, unpublished. (Figures 1, 2, and 3).

Ma et al. 2004a. How Do Climate Fluctuations Affect Persistent Organic Pollutant Distribution in North America? Evidence from a Decade of Air Monitoring. *Environmental Science and Technology* 38 (9): 2538–2543

Ma et al. 2004b. Impacts of Lindane Usage in the Canadian Prairies on the Great Lakes Ecosystem: 2. Modeled Fluxes and Loadings to the Great Lakes. *Environmental Science and Technology* 38 (4): 984-990.

Strandberg et al. 2001. Concentrations and Spatial Variations of Polybrominated Diphenyl Ethers and Other Organohalogen Compounds in Great Lakes Air. *Environmental Science and Technology* 35 (6): 1078-1083.

Totten et al. 2001. Dynamic Air-Water Exchange of Polychlorinated Biphenyls in the New York-New Jersey Harbor Estuary. *Environmental Science and Technology* 35 (19): 3834-3840.

Wethington, D. and Hornbuckle K., in review. Milwaukee, WI is a Source of Atmospheric PCBs to Lake Michigan. *Environmental Science and Technology*.

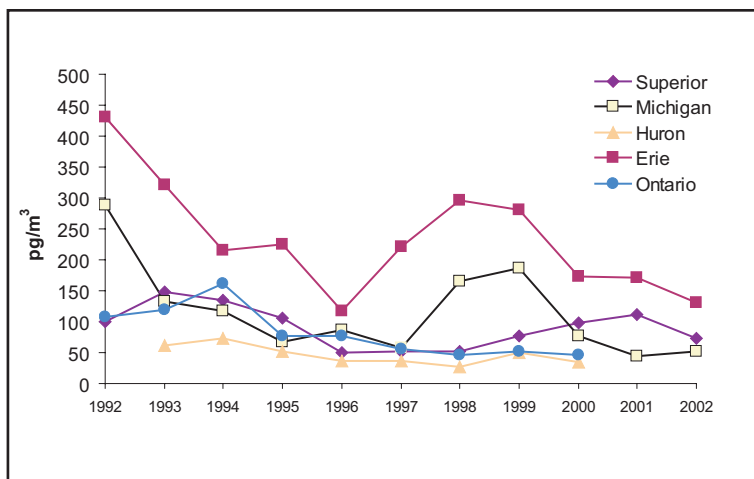


Figure 1. Gas Phase Concentrations of Total PCBs (PCB Suite). Source: IADN Steering Committee, unpublished, 2004.

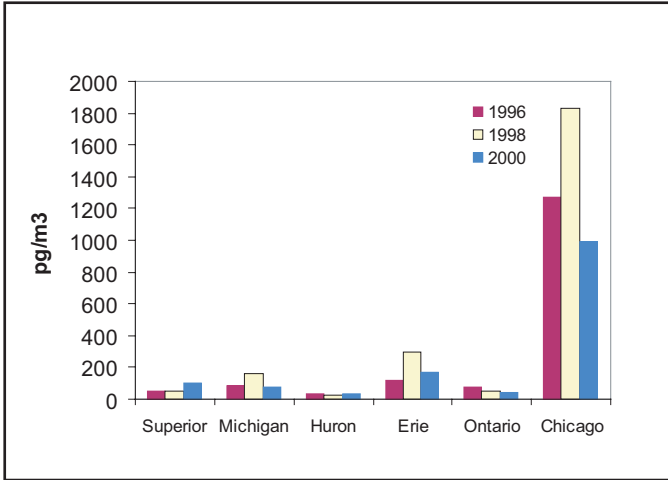
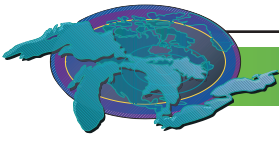


Figure 2. Gas Phase PCB concentrations for rural sites versus Chicago. Source: IADN Steering Committee, unpublished, 2004.

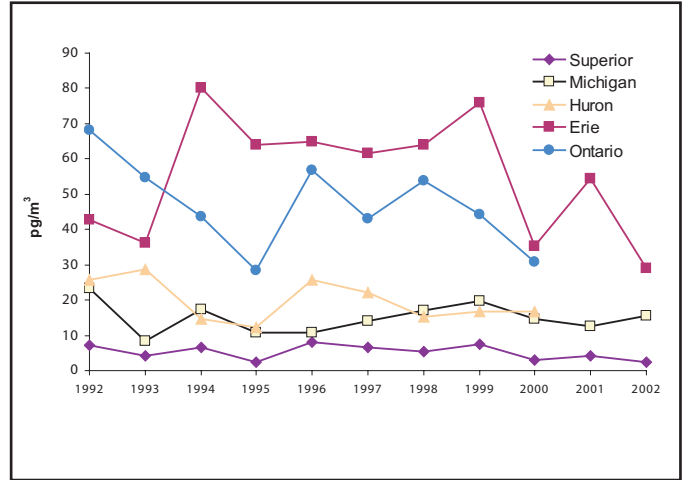


Figure 3. Particulate Concentrations of Benzo(a)pyrene. Source: IADN Steering Committee, unpublished, 2004.

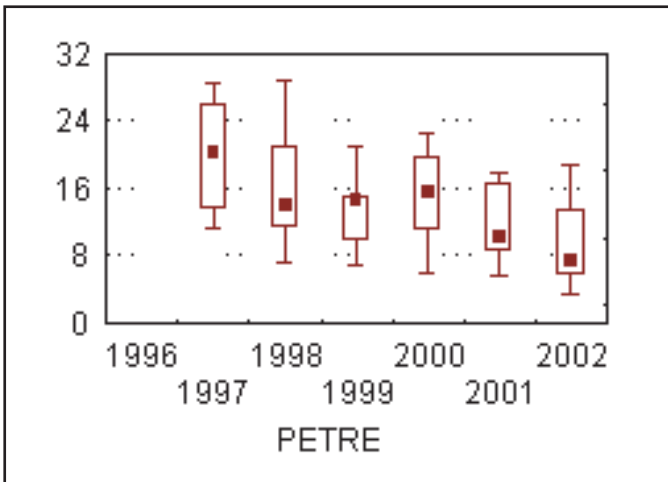


Figure 4. Concentrations of dioxins and furans expressed as TEQ (Toxic Equivalent) in  $\text{fg}/\text{m}^3$  at Point Petre on Lake Ontario. Source: Environment Canada National Air Pollution Surveillance (NAPS) network, unpublished, 2004.

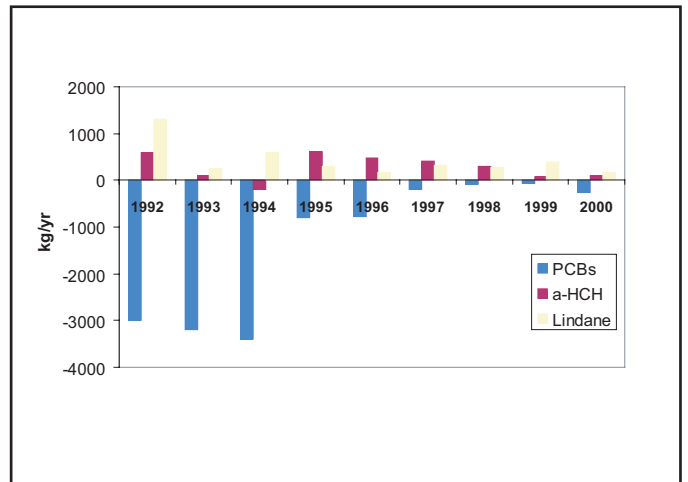


Figure 5. Net Gas Exchange Atmospheric Loadings to Lake Michigan. Source: Blanchard et al. 2004.



## Toxic Chemical Concentrations in Offshore Waters

SOLEC Indicator #118

### Assessment: Mixed Improving

Data are not system-wide.

### Purpose

This indicator reports the concentration of priority toxic chemicals in offshore waters, and by comparison to criteria for the protection for aquatic life and human health infers the potential for impacts on the health of the Great Lakes aquatic ecosystem. As well, the indicator can be used to infer the progress of virtual elimination programs.

### Ecosystem Objective

The Great Lakes should be free from materials entering the water as a result of human activity that will produce conditions that are toxic or harmful to human, animal, or aquatic life (GLWQA, Article III(d)).

### State of the Ecosystem

Many toxic chemicals are present in the Great Lakes and it is impractical to summarize the spatial and temporal trends of them all within a few pages. For more information on spatial and temporal trends in toxic contaminants in offshore waters, the reader is referred to Marvin et al. (2004) and Chapter 9 of the Great Lakes Binational Toxics Strategy 2002 Progress report.

Organochlorines, several of which are on various “critical pollutant” lists, have and are still declining in the Great Lakes in response to management efforts. Spatial concentration patterns illustrate the ubiquitous nature of some, or the influence of localized source(s) of others.

An example of an organochlorine with more widespread distribution is dieldrin. Concentrations of dieldrin in the Great Lakes continue to decrease (Marvin et al., 2004). Concentrations of dieldrin in the Niagara River have decreased by more than 70% between 1986 and 2000/01 (Williams and O’Shea, 2003).

Hexachlorobenzene (HCB), octachlorostyrene, and mirex exemplify organochlorines whose presence is due to historical, localized sources. Consequently, their occurrence in the environment is isolated to specific locations in the Great Lakes basin. Concentrations of all three in the Niagara River have decreased by more than 70% between 1986 and 2000/01 (Williams and O’Shea, 2003).

### Future Pressures

Management efforts to control inputs of organochlorines have resulted in decreasing concentrations in the Great Lakes, however, historical sources for some still appear to affect ambient concentrations in the environment. Chemicals such as endocrine disrupting chemicals, in-use pesticides, and pharmaceuticals are emerging issues.

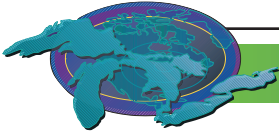
### Future Actions

The Great Lakes Binational Toxics Strategy efforts need to be maintained to identify and track the remaining sources and explore opportunities to accelerate their elimination.

Targeted monitoring to identify and track down local sources should be considered for those chemicals whose distribution suggests localized influences.

### Further Work Necessary

Beginning in 1986, Environment Canada has conducted toxic contaminant monitoring in the shared waters of the Great Lakes. In 2004, USEPA initiated a monitoring program for toxics in offshore waters. EPA’s analyte list includes PCBs, organochlorine pesticides, toxaphene, dioxins/furans, PBDEs, selected PAHs, mercury, PFOS (perfluorooctanyl sulfonate) and PFOA (perfluorooctanoic acid). Environment Canada and EPA are discussing their two programs with basinwide reporting possibilities for the SOLEC 2006 report. An agreed upon approach for summarizing and reporting the indicator will also be required given that many chemicals and locations have unique stories to tell.



**Acknowledgments**

Author: Scott Painter, Environment Canada, Burlington, ON.

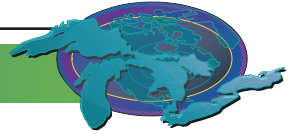
**Sources**

Great Lakes Binational Toxics Strategy. 2002 Progress Report. Environment Canada and US Environmental Protection Agency.

Great Lakes Water Quality Agreement (GLWQA). 1978. Revised Great Lakes Water Quality Agreement of 1978. As amended by Protocol November 18, 1987. International Joint Commission, Windsor, Ontario.

Marvin, C., S. Painter, D. Williams, V. Richardson, R. Rossmann, P. Van Hoof. 2004. Spatial and temporal trends in surface water and sediment contamination in the Laurentian Great Lakes. *Environmental Pollution*. 129(2004): 131-144.

Williams, D.J. and M.L O'Shea. 2003. Niagara River Toxics Management Plan (NRTMP) Progress Report and Work Plan. Prepared for the Niagara River Secretariat. Environment Canada, US Environmental Protection Agency, Ontario Ministry of Environment and New York State Department of Environmental Conservation.



## Concentrations of Contaminants in Sediment Cores

SOLEC Indicator #119

### Assessment: Mixed Improving

#### Purpose

This indicator analyzes the concentration of toxic chemicals in sediments from two perspectives: 1) by comparing contaminant concentrations to available sediment quality guidelines, we can infer potential harm to aquatic ecosystems from contaminated sediments; and 2) by assessing surficial sediment contamination and using contaminant concentration profiles in sediment cores from open lake and, where appropriate, Areas of Concern index stations, we can infer progress towards virtual elimination of toxics in the Great Lakes.

#### Ecosystem Objective

The Great Lakes should be free from materials entering the water as a result of human activity that will produce conditions that are toxic or harmful to human health, animal, or aquatic life (GLWQA, Article III(d)). The GLWQA and the Binational Strategy both state the virtual elimination of toxic substances to the Great Lakes as an objective.

#### Sediment Quality Index

A sediment quality index (SQI) has been developed from the metrics used in the recently approved Canadian Water Quality Index. The SQI was calculated according to an equation incorporating three elements; scope – the % of variables that did not meet guidelines; frequency – the % of failed tests relative to the total number of tests in a group of sites, and; amplitude – the magnitude by which the failed variables exceeded guidelines. A modified SQI was also developed, using only the scope and amplitude elements, which computed the SQI score per site with no grouping of sites. A full explanation of the SQI derivation process and a possible classification scheme based on the SQI score (0 – 100, poor to excellent) is provided in Grapentine et al. (2002 In Press).

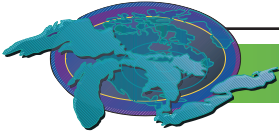
#### State of the Ecosystem

Environment Canada initiated a comprehensive sediment contaminant survey of the open waters of the Great Lakes in 1997. Data for 34 chemicals with guidelines were available for Lakes Erie and Ontario. Generally, the Canadian federal probable effect level (PEL) guideline (CCME, 2001) was used when available, otherwise the Ontario lowest effect level (LEL) guideline (Persaud et al., 1992) was used. Application of the SQI to Lakes Erie and Ontario is reported in Marvin et al. (2004). Work towards application of the SQI to all lakes, including Lake St. Clair, is ongoing. Data for lead, zinc, copper, cadmium, and mercury have been collated. Generally, the Canadian federal probable effect level (PEL) guideline (CCME, 2001) was used when available, otherwise the Ontario lowest effect level (LEL) guideline (Persaud et al., 1992) was used. The SQI ranged from fair in Lake Ontario to excellent in eastern Lake Erie (Table 1). Spatial trends in sediment quality in Lakes Erie and Ontario reflected overall trends for individual contaminant classes such as mercury and polychlorinated biphenyls. The spatial representation of sediment quality using the individual site SQI scores as well as the area SQI scores represent the individual spatial patterns in the 34 chemicals. Figure 1 illustrates the site by site SQI for Great Lakes sediments based on these metals. The general trend in sediment quality across the Great lakes basin for the five metals is generally indicative of trends for a wide range of persistent toxics. Areas of Lakes Erie, Ontario and Michigan show the poorest sediment quality as a result of historical urban and industrial activities.

Application of the SQI has been expanded to include contaminants in streambed and riverine sediments for whole-watershed assessments. The SQI map for the Lake Erie – Lake St. Clair drainages is shown in Figure 2. Poorest sediment quality is primarily associated with AOCs where existing multi-stakeholder programs (e.g., RAPs) are in place to address environmental impairments related to toxics. The SQI was applied to 5 priority AOCs for which the USEPA has collected sediment data. Table 2 contains the SQI scores for these 5 priority AOCs. SQI scores for these AOCs are based on the results of available chemical analysis for surficial sediment concentrations only. Future sediment data collected in AOCs at these sites can be compared to current SQI scores to determine trends in sediment contamination.

Environment Canada and USEPA integrated available data from each of the open waters of the Great Lakes. To date, data on lead, zinc, copper, cadmium, and mercury have been integrated. Figure 1 illustrates the site by site SQI for Great Lakes sediments based on these metals.





### Future Pressures

Management efforts to control inputs of historical contaminants have resulted in decreasing contaminant concentrations in the Great Lakes open-water sediments for the standard list of chemicals. However, additional chemicals such as brominated flame retardants polybrominated diphenyl ethers (BFRPDBEs), polychlorinated naphthalenes (PCNs), polychlorinated alkanes (PCAs), endocrine disrupting chemicals, and in-use pesticides and pharmaceuticals and personal care products (PPCPs) represent emerging issues, and potential future stressors to the ecosystem. Environment Canada is investigating the occurrence and distribution of these compounds in sediments in both open water areas and AOCs. The distribution of hexabromocyclododecane (HBCD) in Detroit River suspended sediments is shown in Figure 3. This compound is the primary flame retardant used in polystyrene foams. Elevated levels of HBCD were associated with heavily urbanized/industrialized areas of the watershed, indicating that large urban centers can act as diffuse sources of contaminants. The HBCD distribution differs somewhat from PCBs, which are primarily associated with areas of contaminated sediment resulting from historical industrial activities including steel manufacturing and chlor-alkali production.

### Future Actions

Binational Toxics Strategy needs to be maintained to identify and track the remaining sources of contamination and to explore opportunities to accelerate their elimination.

1. Targeted monitoring to identify and track down local sources of pollution should be considered for those chemicals whose distribution in the ambient environment suggests localized sources.

### Further Work Necessary

1. Environment Canada, Ontario Ministry of the Environment, and the USEPA need to determine the availability of historical and current sediment quality data (both near-shore and open lake) to facilitate both spatial analysis AND to confirm the availability of Index sites to examine temporal trends.
2. Continued exploration and refinement of the SQI approach should be explored, especially the issue of agreement on guidelines to use in implementing the SQI and an appropriate classification scheme.

### Acknowledgments

Authors: Scott Painter and Chris Marvin, Environment Canada, Burlington, ON.

### Sources

Canadian Council of Ministers of the Environment (CCME). 1999, updated 2001. Canadian Environmental Quality Guidelines. Canadian Council of Ministers of the Environment. Winnipeg, MB, Canada.

Grapentine L., C. Marvin, S. Painter. (2002 In Press). Development and evaluation of a sediment quality index for the Great Lakes and associated Areas of Concern. *Human and Ecological Risk Assessment* 8(7): 1549-1567.

Marvin, C., et al. Application of a sediment quality index to the lower Laurentian Great Lakes. *Environmental Monitoring and Assessment*. 91: 1-16.

Persaud, D., R. Jaagumagi, and A. Hayton. 1992. Guidelines for the Protection and Management of Aquatic Sediment Quality in Ontario. Water Resources Branch, Ontario Ministry of the Environment and Energy. June 1992.

Rossman, R. USEPA, ORD-NHEERL-MED, 1994-1996. Unpublished data.

US Geological Survey. 2000. Areal distribution and concentrations of contaminants of concern in surficial streambed and lakebed sediments, Lake Erie – Lake St. Clair drainages, 1990-97. Water Resources Investigations Report 00-4200.

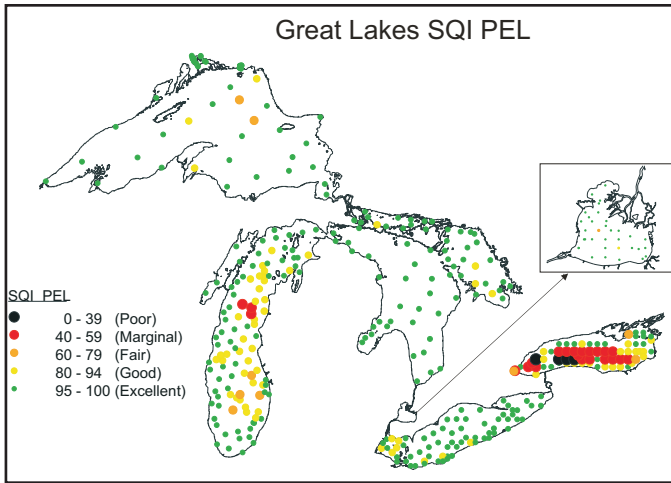
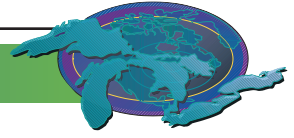


Figure 1. Site Sediment Quality Index (SQI) based on lead, zinc, copper, cadmium and mercury. Source: Chris Marvin, Environment Canada, National Water Research Institute (1997-2001 data for all Lakes except Michigan); and Ronald Rossmann, USEPA (1994-1996 data for Lake Michigan).

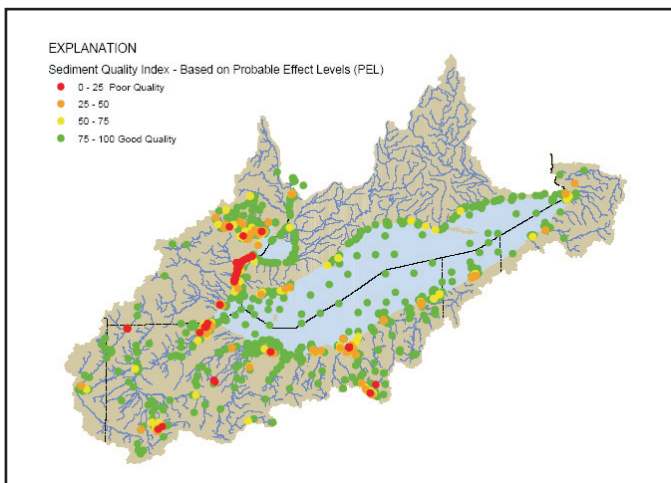


Figure 2. Sediment Quality Index (SQI) for the Lake Erie - Lake St. Clair drainages. More detailed information on contaminants in sediments in the Lake Erie - Lake St. Clair drainages has been reported by the USGS (2000). Source: Dan Button, US Geological Survey.

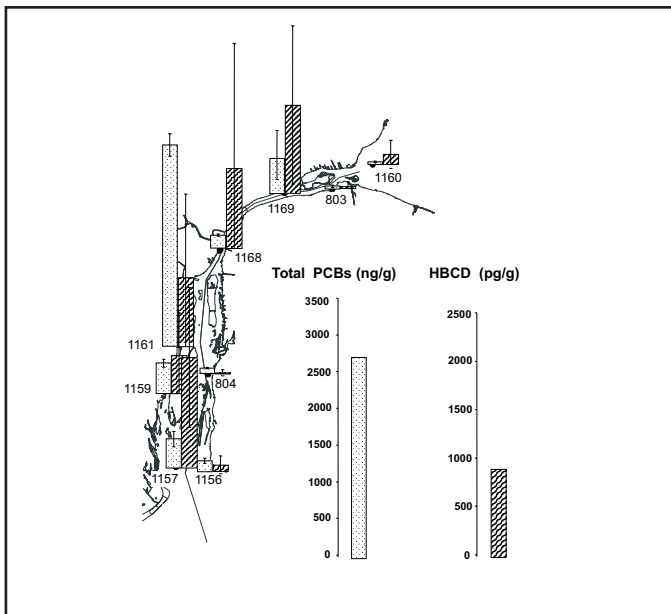
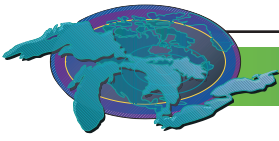


Figure 3. Distribution of hexabromocyclododecane (HBCD) and PCBs in suspended sediments in the Detroit River. Source: Chris Marvin, Environment Canada, National Water Research Institute.



## Contaminants in Whole Fish

SOLEC Indicator #121

**Assessment:** Mixed, Improving

### Purpose

Annual or biennial analysis of contaminant burdens in representative open water fish species from throughout the Great Lakes provides data to describe temporal and spatial trends of bioavailable contaminants. These contaminants are a measure of both the effectiveness of remedial actions related to the management of critical pollutants and are an indicator of emerging problems.

### Ecosystem Objective

Great Lakes waters should be free of toxic substances that are harmful to fish and wildlife populations and the consumers of this biota. Data on status and trends of contaminant conditions, using fish as biological indicators, supports the requirements of the Great Lakes Water Quality Agreement (GLWQA) Annexes 1 (Specific Objectives), 2 (Remedial Action Plans and Lakewide Management Plans), 11 (Surveillance and Monitoring), and Annex 12 (Persistent Toxic Substances).

### State of the Ecosystem

Long-term (>25 yrs), basin wide monitoring programs measuring whole body concentrations of contaminants in top predator (lake trout and/or walleye) and forage fish (smelt) are collected by the US Environmental Protection Agency's Great Lakes National Program Office (GLNPO) and the Canadian Department of Fisheries and Oceans (DFO) to develop trend data on bioavailable toxic substances in the Great Lakes aquatic ecosystem. DFO reports contaminant burdens annually in similarly aged fish (4<sup>+</sup> -6<sup>+</sup> range), while GLNPO reports contaminant burdens annually in similarly sized fish (lake trout 600-700 mm & walleye 400-500 mm total length). Since the late 1970's, concentrations of historically regulated contaminants such as PCBs, DDT and Hg have generally declined in most monitored fish species. Some other contaminants, both currently regulated and unregulated, have demonstrated either slowing declines or, in some cases, increases in selected fish communities. The changes are often lake specific and relate both to the specific characteristics of the substances involved and the biological conditions of the fish community surveyed.

Trends:

The GLWQA was first signed in 1972 and renewed in 1978, and expresses the commitment of Canada and the United States to restore and maintain the chemical, physical and biological integrity of the Great Lakes Basin Ecosystem. The GLWQA criterion for PCBs states that, "The concentration of total polychlorinated biphenyls in fish tissues (whole fish, calculated on a wet weight basis), should not exceed 0.1 micrograms per gram for the protection of birds and animals which consume fish. The GLWQA criterion for DDT and metabolites states that, "The sum of the concentrations of DDT and its metabolites in whole fish should not exceed 1.0 microgram per gram (wet weight basis) for the protection of fish-consuming aquatic birds". The GLWQA criteria for mercury states that, "the concentration of total mercury in whole fish should not exceed 0.5 micrograms per gram (wet weight basis) to protect aquatic life and fish-consuming birds". The following table defines species and locations where GLWQA criteria are exceeded based on current data collected by DFO and GLNPO's Great Lakes Fish Monitoring Program. DFO collects lake trout and smelt from all lakes and walleye from Lake Erie. GLNPO collects lake trout from all lakes except Lake Erie, where walleye are collected.



Lake	Species	Hg *	PCB*, **	ΣDDT***	ΣDDT****
Ontario	Smelt	√	X*	√	
	Lake Trout	No Data	X	√	√
Erie	Smelt	√	√*	√	
	Lake Trout	No Data	X*	√	
	Walleye	√	X	√	√
Huron	Smelt	√	√*	√	
	Lake Trout	No Data	X	√	√
Superior	Smelt	√	√*	√	
	Lake Trout	No Data	X	√	√
Michigan	Lake Trout		X		√

\*Data Source: DFO Fish Contaminants Surveillance Program (2002-2003)  
 \*\* Data Source: GLNPO Great Lakes Fish Monitoring Program (1999-2000)  
 \*\*\*ΣDDT = (p,p' DDD + p,p' DDT + o,p' DDT + p,p' DDE) - DFO  
 \*\*\*\*ΣDDT = (p,p' DDD + p,p' DDT + p,p' DDE) - GLNPO  
 √ – Below Agreement Objective  
 X – Exceeds Agreement Objective

Table 1. Fish Species and Locations Where GLWQA Specific Objectives Are Exceeded Currently\*

**Lake Michigan** – Σ DDT and Total PCB lake trout concentration data show consistent declines through 2000. GLNPO recorded concentrations of Σ DDT have remained below the GLWQA criteria since 1986. Recorded concentrations of total PCBs in Lake Michigan lake trout remain above the GLWQA criteria.

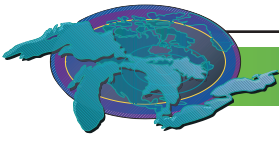
**Lake Superior** – Σ DDT: Both GLNPO and DFO lake trout data display a general fluctuation concentrations from year to year with a recent increase in concentration. However, DFO concentrations recorded in 2002 are within the range of concentration means reported between 1996 and 2002. The increased concentration in the 2000 collections compared to the 1998 collections may be due to this change in collection sites. One possible explanation is that the population sampled in 2000 was consuming more contaminated prey than the population collected in 1998, which led to higher contaminant concentrations in those lake trout. DFO smelt data show a steady decline through 2002. GLNPO recorded concentration of Σ DDT in Lake Superior lake trout have remained below the GLWQA criteria since 1989 and DFO lake trout and smelt concentrations have never been observed to be above GLWQA criteria.

Total PCBs: GLNPO lake trout data show some fluctuation with movement toward a leveling off beginning in the the1980s. DFO lake trout data show very little recent change in the mean PCB concentrations of this age class cohort of Lake Superior lake trout through 2002. DFO smelt show a steady decline in PCB concentrations through 2002. After peaking in 1985, the 2002 level was the lowest recorded concentration since Lake Superior monitoring began in 1981. Recorded concentrations of total PCBs in both GLNPO and DFO Lake Superior lake trout collections remain above the GLWQA criteria. DFO collected Lake Superior smelt have consistently remained below GLWQA criteria since 1993.

Mercury: DFO smelt data continue to display a steady decline in Hg concentrations through 2002, with the lowest recorded concentration since 1981 and they have consistently remained below the GLWQA criteria.

**Lake Huron** – Σ DDT: Both GLNPO and DFO lake trout data show general decline in temporal trends. Both programs display large fluctuations in the early years of analysis followed recently by a relatively consistent year-to-year decline in mean ΣDDT concentrations. DFO Lake Huron smelt data for total DDT concentrations also display fluctuating concentrations with a recent downward trend. GLNPO and DFO recorded concentrations of Σ DDT in Lake Huron lake trout have consistently remained at or below the GLWQA criteria since 1988 and 1984, respectively. DFO collected Lake Huron smelt have never been observed to be above GLWQA criteria.

Total PCBs: Both GLNPO and DFO lake trout data show a general decline in concentrations with some occasional fluctuations upward. Concentrations in 2003 DFO lake trout samples are the second lowest ever recorded for the program initiated in 1980. DFO smelt data show significant fluctuation between 1979 and 2003. Total PCB concentrations recorded in GLNPO and DFO recorded concentrations of total PCBs in Lake Huron lake trout remain above the GLWQA criteria. DFO collected smelt have



consistently remained below GLWQA criteria since 1997.

**Mercury:** DFO smelt data show that Hg concentrations have fluctuated considerably over the period between 1979 and 2003. However, samples collected in 2003 DFO smelt have the highest lake wide concentration recorded since 1984. DFO collected smelt have never been observed to be above the GLWQA criteria.

**Lake Erie -  $\Sigma$  DDT:** All monitored species in Lake Erie display a similar pattern of general decline in concentration. Each species display fluctuation in concentration followed by moderate increase of  $\Sigma$  DDT concentration in the mid to late 1980's then a sharp decline in concentration. The sharp increase corresponds to the period of the rapid proliferation of the zebra mussel population within the lake basin. Both GLNPO and DFO walleye data follow the common pattern of annual concentration increases linked to changes in the zebra mussel population. It is important to note that DFO walleye collected in Lake Erie represent primarily conditions in the western and central basins of the lake. Fall DFO collections occur in the western basin but fish migrate between the western and central basins at points during each year, fall GLNPO walleye demonstrate similar characteristics. DFO lake trout data and smelt data trends also follow the fluctuating concentration pattern influenced by zebra mussel infestation. It is important to note that DFO lake trout collections in Lake Erie were only initiated in 1985. Therefore, the limited number of samples available in the selected age cohort over time makes rigorous temporal trend assessment difficult. Lake trout primarily represent conditions in the eastern basin of the lake as their movement is restricted by generally higher water temperatures prominent outside this basin. GLNPO and DFO recorded concentrations of  $\Sigma$  DDT in Lake Erie walleye have never been observed to be above GLWQA criteria. DFO recorded concentrations of  $\Sigma$  DDT in Lake Erie lake trout and smelt have never been observed to be above GLWQA criteria.

**Total PCBs:** Total PCB concentrations were also effected by the introduction of zebra mussels into Lake Erie and lead to a general increase in organic contaminant concentration in fish. GLNPO walleye demonstrate a period of increase in concentration from the late 1980s through the early 1990s, in correlation with the introduction of zebra mussels, followed by sharp declines in total PCB concentration. DFO walleye demonstrated a period of annual increases from 1985 through 1993 associated principally with the proliferation of the zebra mussel population in the lake basin followed by a decline in PCB concentration and then remained relatively steady over the past 4 years through 2003. DFO lake trout data show a decrease in concentration between 1990 and 2001, followed by a slight increase in concentration through to 2003. DFO smelt data show a decline in concentration between 1990 and 2001, followed by a sharp increase in 2002 and an 80% decrease in 2003. GLNPO and DFO recorded concentrations of Lake Erie walleye and lake trout are above GLWQA criteria. DFO measured Lake Erie smelt PCB concentrations have never been observed to be above GLWQA criteria.

**Mercury:** After a period of rapid decline from 1977 through 1983, Hg concentrations in Lake Erie walleye have remained steady. After 1996, the frequency of annual measurements of mercury burdens in walleye by DFO was reduced. The mean of two recent measurements made in 1999 and 2003 was  $\sim 15\%$  greater than the 5 year mean of the period 1992 through 1996. DFO smelt data show that concentrations of Hg measured in samples collected in 2002, had the highest concentrations reported since the whole lake survey was initiated in 1977. Subsequently the 2003 concentrations were the 2<sup>nd</sup> lowest concentration reported since 1977. DFO recorded concentrations of Lake Erie smelt are below GLWQA criteria.

**Lake Ontario -  $\Sigma$  DDT:** Both GLNPO and DFO lake trout data show a period of small fluctuation through the mid 1990's. Both programs identify a declining trend in  $\Sigma$  DDT concentration beginning in 1994 through the present. DFO smelt data has shown consistent decline between 1998 and 2002. There was a slight increase in reported 2003 smelt concentrations, but this was still an order of magnitude less than the value reported in the initial 1977 collection. GLNPO and DFO recorded concentrations of  $\Sigma$  DDT in Lake Ontario lake trout have consistently been below the GLWQA criteria since 1995 and DFO smelt have never been observed to be above GLWQA criteria.

**Total PCBs:** Both GLNPO and DFO lake trout data show a consistent decline in PCB concentrations through the present with very little change in concentration since the late 1990's. DFO smelt data show that there have been minor declines in PCB concentrations between 1999 and 2003 with a mean value of  $0.21 \pm 0.02 \mu\text{g/g}$ . GLNPO and DFO recorded concentrations of Lake Ontario lake trout and smelt are above the GLWQA criteria.

**Mercury:** DFO smelt data show that there has been very little change in the annual mean Hg level reported for smelt since the mid 1980's. Conversely though, the 2003 level of  $0.04 \mu\text{g/g}$  is the highest Hg concentration in smelt samples recorded since 1984 ( $0.67$



ug/g). DFO reported concentrations of Lake Ontario smelt have never been observed to be above the GLWQA criteria.

#### Emerging Contaminants:

There are a number of emerging contaminants reported in Great Lakes fish. The foremost is the group of brominated flame retardants (BFRs) that have been reported in fish tissues for several years throughout the Great Lakes basin. Retrospective analyses of archived samples confirms the continuing increase in concentrations of polychlorinated brominated diphenyl ethers in lake trout from Lake Ontario. Concentrations have increased exponentially from 0.54 ng/g in 1978 to 190 ng/g wet weight in whole fish samples collected in 2002 (Whittle et al., 2004) (Figure X).

One of the most widely used BFRs is hexabromocyclododecane (HBCD). Based on its use pattern, an additive BFR, it has the potential to migrate into the environment from its application site. Recent studies have confirmed that HBCD isomers do bioaccumulate in aquatic ecosystem and do biomagnify as they move up the food chain. Recent studies by Tomy et al. (2004) confirmed the food web biomagnification of HBCD isomers in Lake Ontario (Table 4).

Perfluorooctanesulfonate (PFOS) has also been detected in fish throughout the Great Lakes and has also demonstrated the capacity for biomagnification in food webs. PFOS is used in surfactants such as water repellent coatings (i.e. Scotchguard<sup>®</sup>) and fire suppressing foams. It has been identified in whole lake trout samples from all the Great Lakes at concentrations from 3 to 139 ng (wet weight) (Stock et al. 2003). In addition, retrospective analyses of archived lake trout samples from Lake Ontario have identified a 4.25-fold increase (43 - 180 ng/g wet weight, whole fish) from 1980 to 2001 (Martin et al. *In Press*).

The toxicological effects of these compounds are not yet completely known but the evidence on exponential increases in concentration over time, the ability to biomagnify in aquatic food webs and the documented presence in fish throughout the Great Lakes makes these compounds prime candidates for toxic chemical monitoring program parameters of interest.

#### Pressures

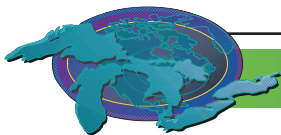
Current – The impact of invasive nuisance species on toxic chemical cycling in the Great Lakes is still an expanding topic. The number of both exotic invertebrates and fish species proliferating in Great Lakes ecosystems continue to increase in temporal and spatial manners. Changes imposed on the form and function of native fish communities by exotics will subsequently alter ecosystem energy flows. As a consequence the pathways and fate of persistent toxic substances will be altered resulting in different accumulation patterns, particularly at the top of the food web, proliferation of zebra mussels in Lake Erie. Some contaminant concentrations peaked for short periods in fish and subsequently decreased. Each of the Great Lakes is currently experiencing changes in the structure of the aquatic community and hence there may be periods of increases in contaminant burdens of some fish species.

A recently published, 15 year long Great Lakes study showed that lake trout embryos and sac fry are very sensitive to toxicity associated with maternal exposures to 2,3,7,8-tetrachlorodibenzo-*p*-dioxin (TCDD) and structurally related chemicals that act through a common aryl hydrocarbon receptor (AHR)-mediated mechanism of action (Cook et al. 2003). The increase in contaminant load of TCDD may be responsible for declining lake trout populations in Lake Ontario. The models used in this study can be used in the remaining Great Lakes.

Future - Added stressors in the future will be the issue of climate change with the potential for warming effects to change the availability of Great Lakes critical habitats, change the productivity of some systems, accelerate the movement of contaminants from abiotic sources into the biological community and further effect the composition of biological communities. In addition, associated changes in water concentrations, critical habitat availability and aquatic ecosystem reproductive success are also factors influencing contaminant trends of the Great Lakes in the future. Researchers are also discovering that pharmaceuticals, such as endocrine disruptors, may be a factor in declining populations of some fish species. As more work is conducted on this topic in the future, State, Federal, and Tribal governments will need to be prepared to react.

#### Management Implications

Much of the current basin wide persistent toxic substance data that is reported focus on legacy chemicals whose use has been previously restricted through various forms of legislation. There are a variety of emerging chemicals that are reported in literature at various locations throughout the Great Lakes. There is a need for a comprehensive basin wide assessment program to be developed to



acquire data on the presence and concentrations of these recently identified compounds in the Great Lakes ecosystems. The existence of long-term specimen archives (>25 yrs) in both Canada and the United States could allow for the establishment of trends for emerging contaminants in the Great Lakes. Retrospective analyses of samples contained in these archives can define if concentrations of recently detected contaminants are changing and identify if further control legislation needs to be developed for the management of specific chemicals.

#### Acknowledgements

D. Michael Whittle, DFO, Great Lakes Laboratory for Fisheries & Aquatic Sciences  
Michael J. Keir, DFO, Great Lakes Laboratory for Fisheries & Aquatic Sciences  
Elizabeth Murphy, USEPA-Great Lakes National Program Office  
J. Fraser Gorrie, Bio-Software Environmental Data

#### Sources

Cook, P.M., Robbins, J.A., Endicott, D.D., Lodge, K.B., Guiney, P.D., Walker, M.K., Zabel, E.W., and Peterson, R.E. 2003. Effects of Aryl Hydrocarbon Receptor-Mediated Early Life Stage Toxicity on Lake Trout Populations in Lake Ontario during the 20th Century. *Environmental Science and Technology*. 37(17) 3878 – 3884.

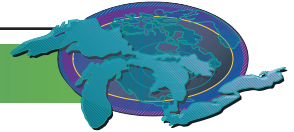
Great Lakes Water Quality Agreement of 1978. International Joint Commission United States and Canada. September, 1989. <http://www.ijc.org/rel/agree/quality.html>.

Martin, J.W., D. M. Whittle, D.C.G. Muir & S.A. Mabury. 2004 Perfluoroalkyl Contaminants in the Lake Ontario Food Web. *Environ. Sci. Technol.* 38 (*In Press*).

Stock, N.L. J. Bonin, D.M. Whittle, D.C.G. Muir & S.A. Mabury. 2003. Perfluorinated Acids in the Great Lakes. SETAC Europe 13<sup>th</sup> Annual Meeting, Hamburg, Germany April 27 - May 1, 2003.

Tomy, G.T., W. Budakowski, T. Halldorson, D.M. Whittle, M. Keir, C. Marvin, G. MacInnis & M. Alae. 2004. Biomagnification of  $\alpha$  and  $\gamma$ -Hexabromocyclododecane in a Lake Ontario Food Web. *Environ. Sci. Technol.* 38 (2298-2303).

Whittle, D.M. D.C. MacEachen, D.B. Sergeant, M.J. Keir & M.D. Moles. Food Web Biomagnification of Brominated Diphenyl Ethers in Two Great Lakes Fish Communities. 3<sup>rd</sup> International Workshop on Brominated Flame Retardants (pp 183-186). Toronto, ON June 6-9, 2004



Lake	Contaminant	Species	Highest Recorded Concentration		Most Recently Measured Con'c		% of Highest Recorded Concentration
			Year	Value (?g/g)	Year	Value (?g/g)	
Superior	ΣDDT	Lake Trout	1977	1.2	2000	0.567	47%
	Total PCBs	Lake Trout	1980	1.89	2000	0.784	41%
Michigan	ΣDDT	Lake Trout	1970	19.19	2000	1.056	6%
	Total PCBs	Lake Trout	1974	22.91	2000	1.614	7%
Huron	ΣDDT	Lake Trout	1979	3	2000	0.557	19%
	Total PCBs	Lake Trout	1979	3.66	2000	0.779	21%
Erie	ΣDDT	Walleye	1977	0.51	2000	0.085	17%
	Total PCBs	Walleye	1977	2.64	2000	1.241	47%
Ontario	ΣDDT	Lake Trout	1977	1.93	2000	0.864	45%
	Total PCBs	Lake Trout	1977	8.33	2000	1.174	14%

\*All concentrations based on whole fish samples

Table 2. Percent Change in Total PCB/DDT/Hg Concentrations for GLNPO Fish Collections (Size - Lake Trout: 600-700mm, Walleye: 450-550mm)

Lake	Contaminant	Species	Highest Recorded Concentration		Most Recently Measured Conc'n		% of Highest Recorded Concentration
			Year	Value (?g/g)	Year	Value (?g/g)	
Superior	ΣDDT	Lake Trout	1981	0.36	2002	0.10	28%
		Smelt	1982	0.09	2002	0.01	12%
	Total PCBs	Lake Trout	1988	1.91	2002	0.33	17%
		Smelt	1985	0.30	2002	0.03	10%
	Mercury	Smelt	1981	0.10	2003	0.02	20%
Huron	ΣDDT	Lake Trout	1981	1.10	2003	0.16	15%
		Smelt	1982	0.12	2003	0.02	17%
	Total PCBs	Lake Trout	1982	2.52	2003	0.43	17%
		Smelt	1982	0.29	2003	0.03	10%
	Mercury	Smelt	1980	0.07	2003	0.05	74%
Erie	ΣDDT	Walleye	1977	0.90	2003	0.06	7%
		Lake Trout	1989	0.83	2003	0.07	8%
		Smelt	1980	0.12	2003	0.01	8%
	Total PCBs	Walleye	1979	3.11	2003	1.08	35%
		Lake Trout	1990	1.75	2003	0.70	40%
		Smelt	1990	0.76	2003	0.08	11%
Mercury	Walleye	1977	0.37	2003	0.12	32%	
	Smelt	2002	0.05	2003	0.02	40%	
Ontario	ΣDDT	Lake Trout	1977	4.54	2003	0.36	8%
		Smelt	1977	0.60	2003	0.06	10%
	Total PCBs	Lake Trout	1977	9.05	2003	1.17	13%
		Smelt	1988	2.15	2003	0.18	8%
	Mercury	Smelt	1982	0.09	2003	0.04	44%

\*All concentrations based on whole fish samples

Table 3. Percent Change in Total PCB/DDT/Hg Concentrations for DFO Fish Collections: (Age 4+ -6+ range)

SPECIES	ΣHBDC (α+γ isomers) (ng/g wet wt ± S.E.)
Lake Trout	1.68 ± 0.67
Sculpin	0.45 ± 0.10
Smelt	0.27 ± 0.03
Alewife	0.13 ± 0.02
Mysis	0.07 ± 0.02
Diporeia	0.08 ± 0.01
Plankton	0.02 ± 0.01

Table 4. Lake Ontario Food Web Bioaccumulation of HBDC Isomers  
Source: Tomy et al, 2004



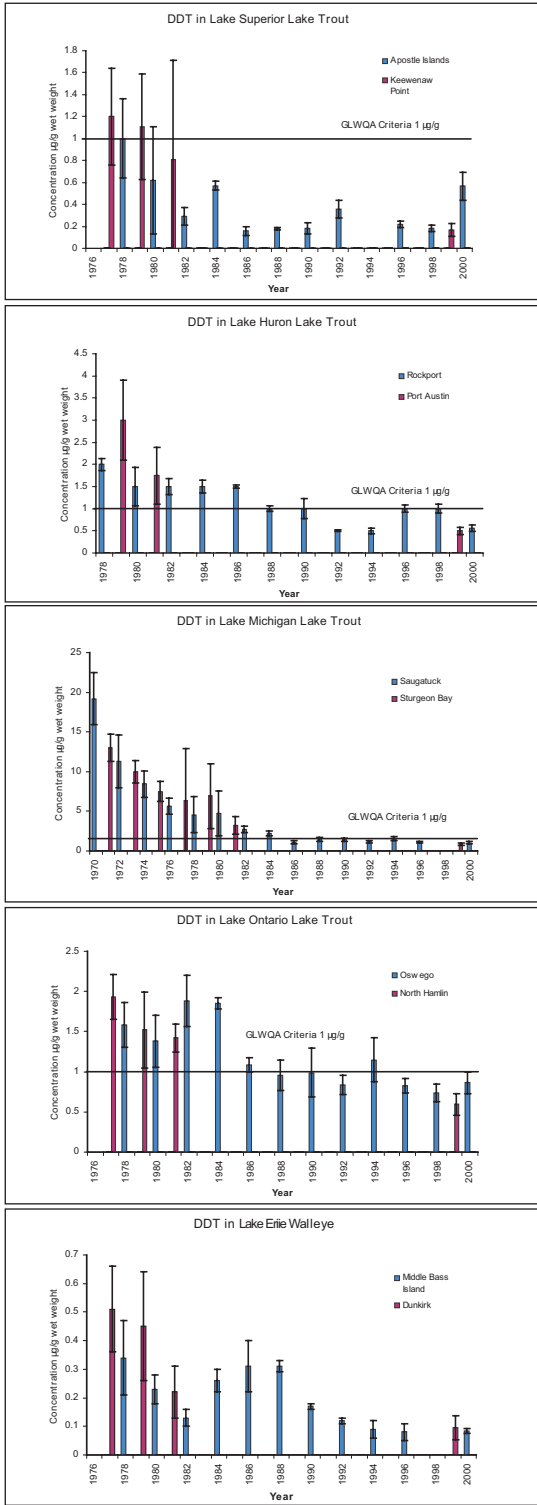
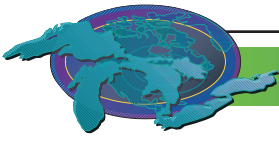


Figure 1. DDT levels in whole Lake Trout (Walleye in Lake Erie), 1972 - 2000. g/g wet weight +/- 95% C.I., composite samples. Lake Trout = 600 - 700 mm size range. Walleye = 450 - 550 mm size range. Note the different scales on Y axis between lakes. Source: US Environmental Protection Agency

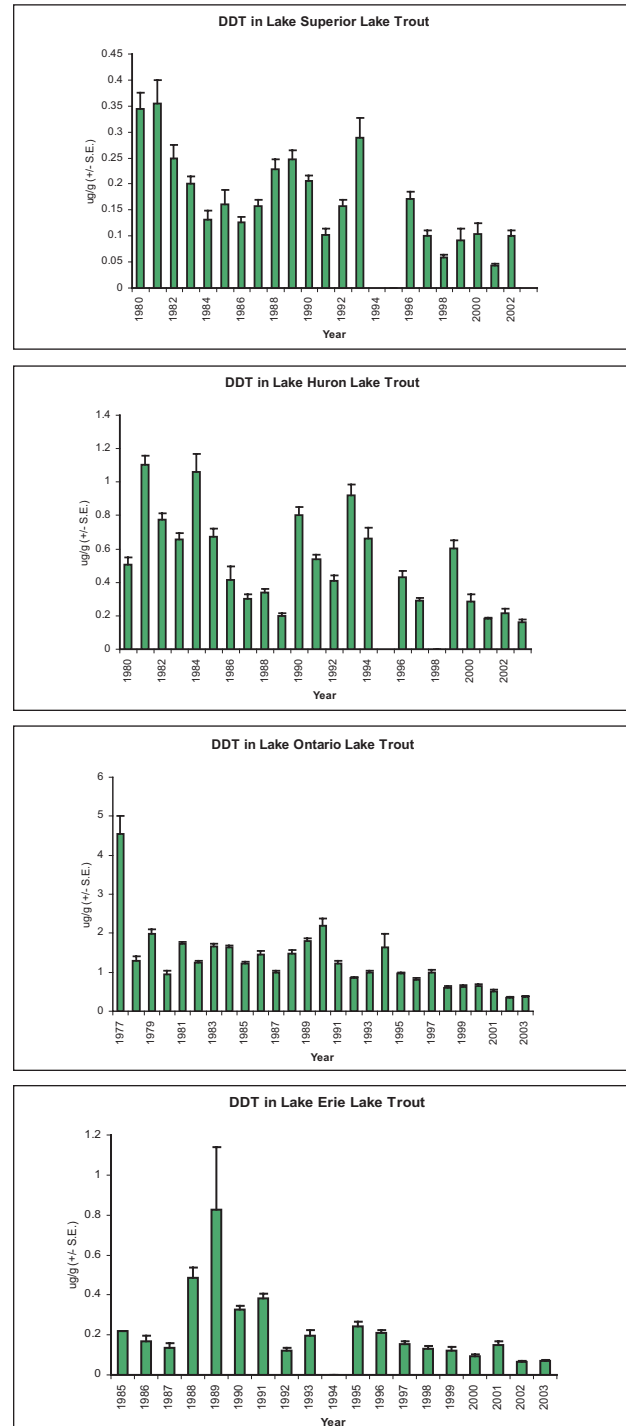


Figure 2. Total DDT levels in whole Lake Trout, 1977-2003. Canadian data ug/g wet weight +/- S.E., ages 4-6 years. Note the different scales between lakes. Source: Department of Fisheries and Oceans Canada

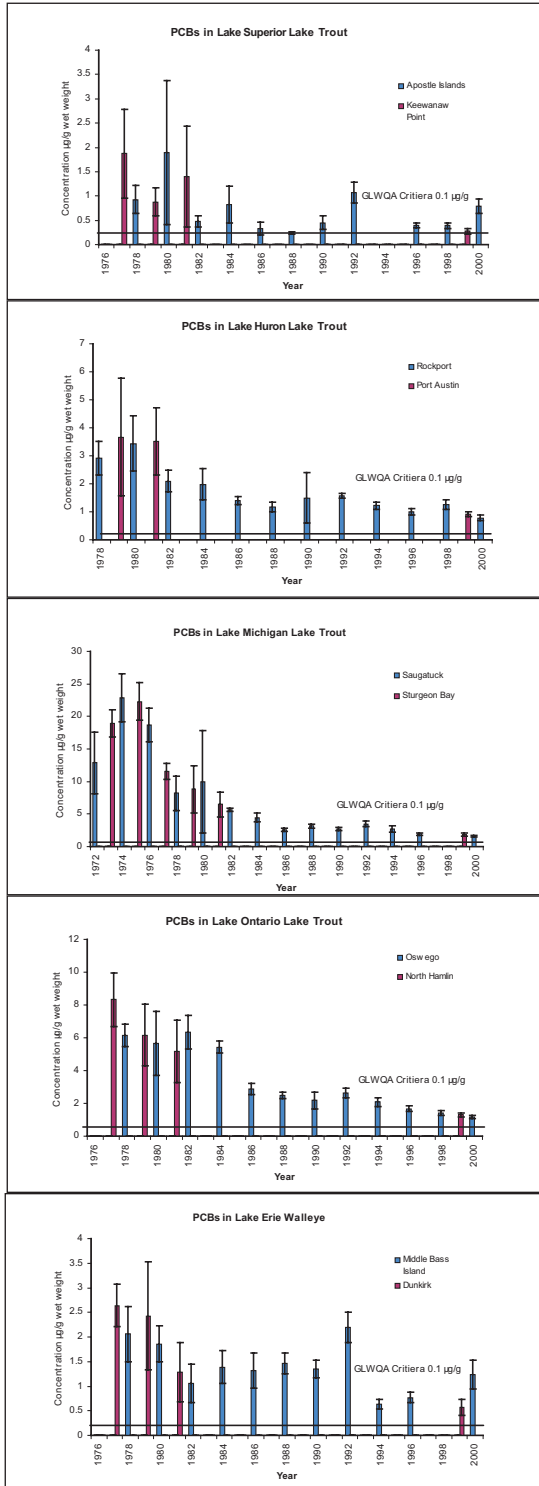
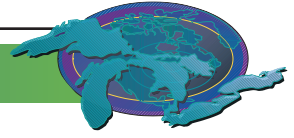


Figure 3. Total PCB levels in whole Lake Trout (Walleye in Lake Erie), 1972 - 2000. µg/g wet weight +/- 95% C.I., composite samples. Lake Trout = 600 - 700 mm size range. Walleye = 450 - 550 mm size range. Note the different scales on Y axis between lakes. Source: US EPA

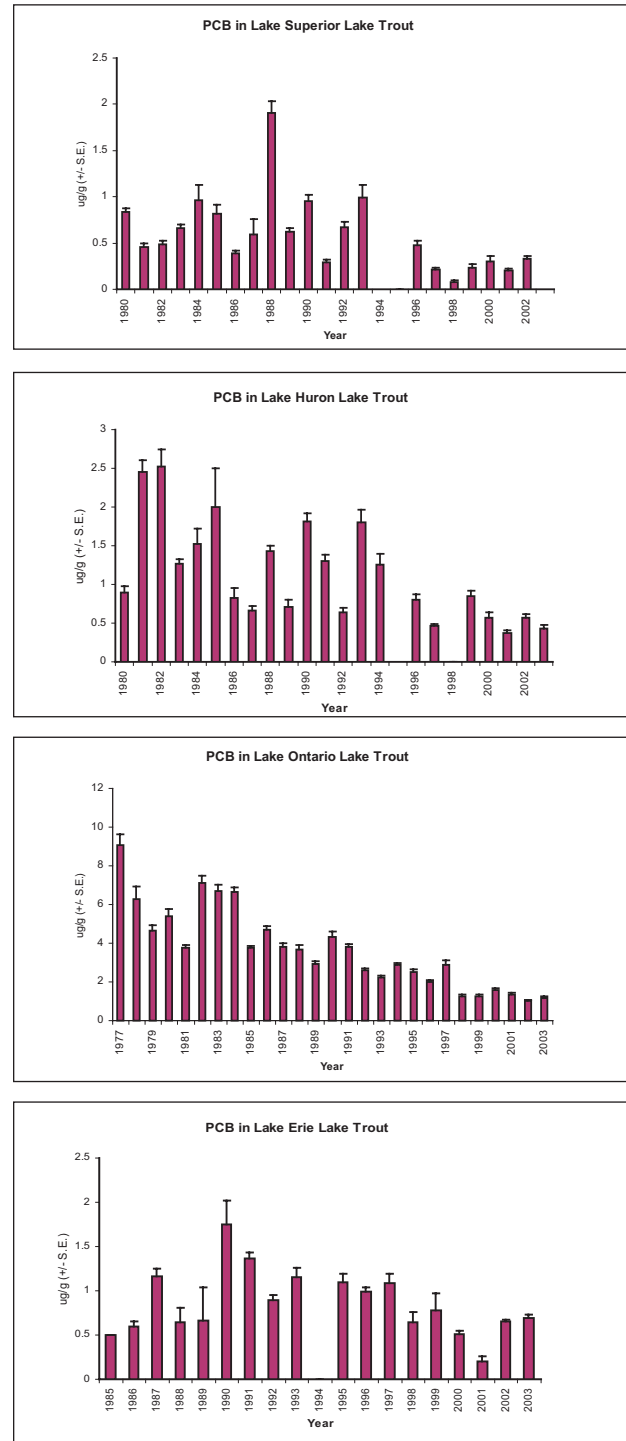


Figure 4. Total PCB levels in whole Lake Trout, 1977-2003. Canadian data ug/g wet weight +/- S.E., ages 4-6 years. Note the different scales between lakes. Source: Department of Fisheries and Oceans Canada

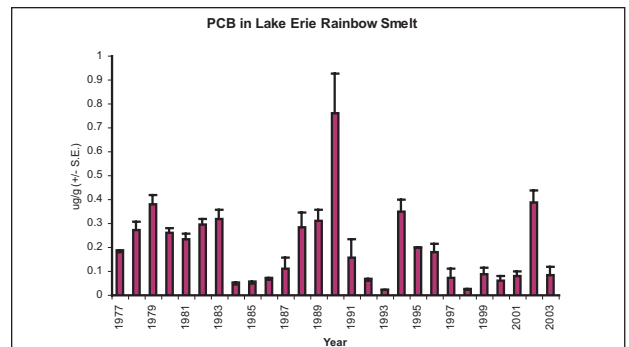
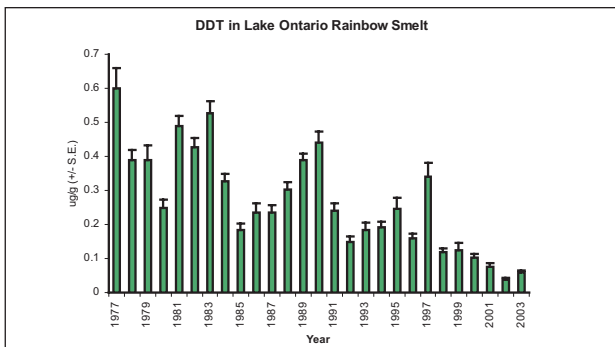
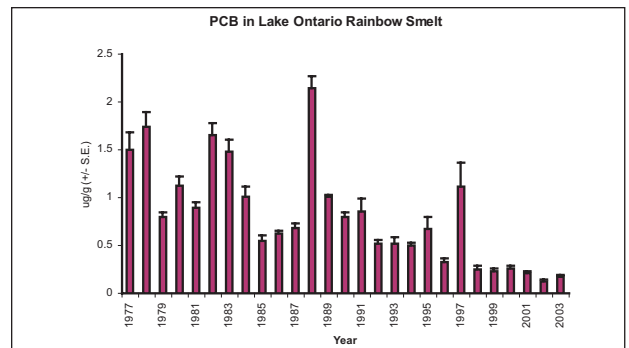
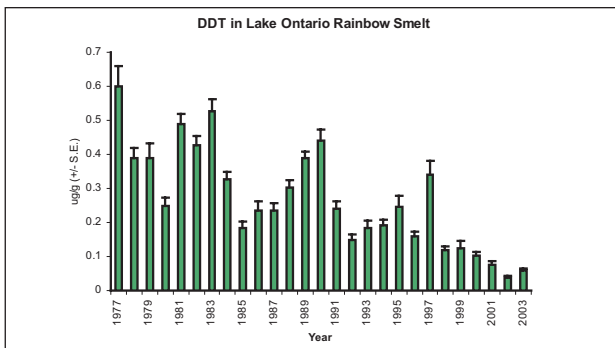
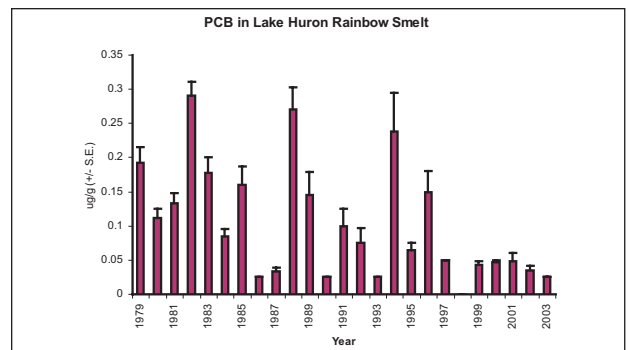
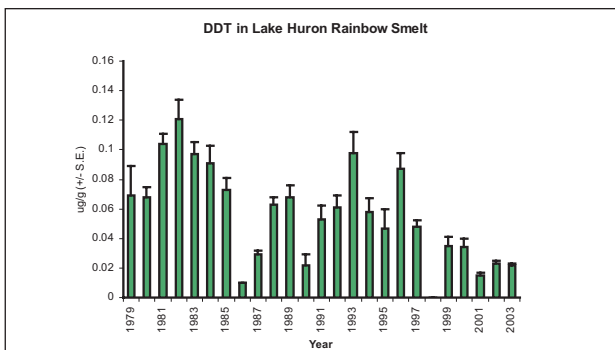
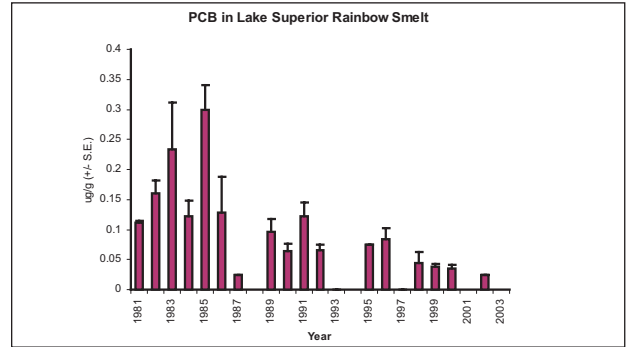
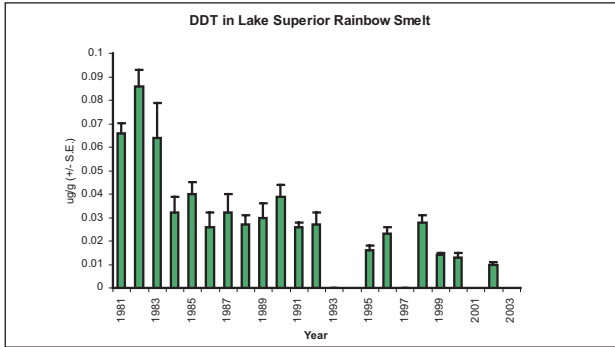
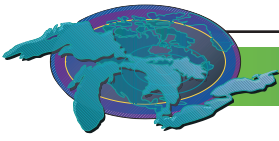


Figure 5. Total DDT levels in Great Lakes Rainbow Smelt, 1977-2003. Canadian data ug/g wet weight +/- S.E., whole fish. Note the different scales between lakes. Source: Department of Fisheries and Oceans Canada

Figure 6. Total PCB levels in Great Lakes Rainbow Smelt, 1977-2003. Canadian data ug/g wet weight +/- S.E., whole fish. Note the different scales between lakes. Source: Department of Fisheries and Oceans Canada

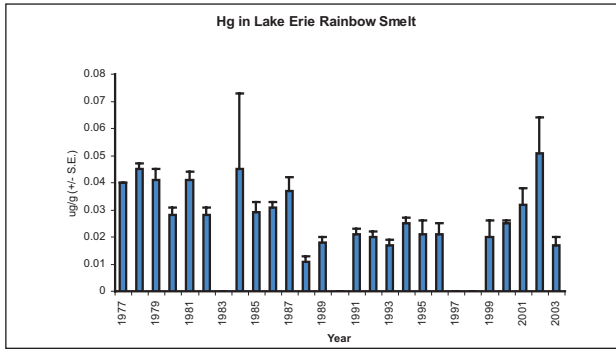
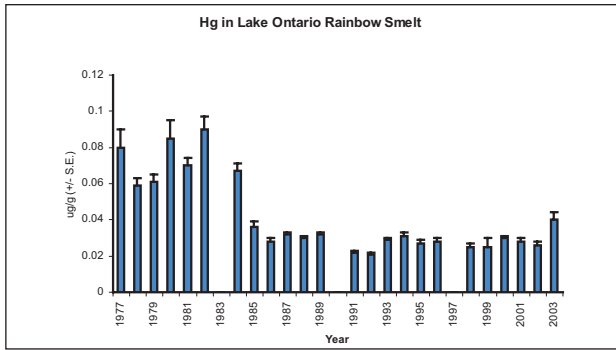
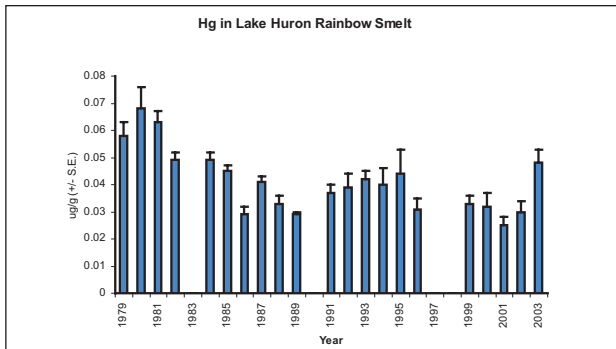
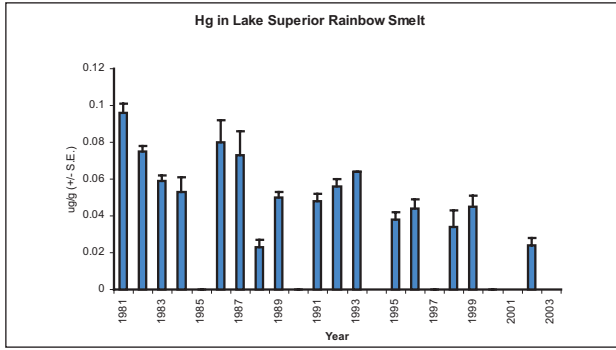
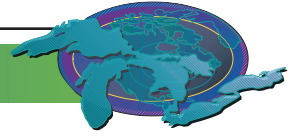


Figure 7. Total mercury levels in Great Lakes Rainbow Smelt, 1977-2003. Canadian data ug/g wet weight +/- S.E., whole fish. Note the different scales between lakes. Source: Department of Fisheries and Oceans Canada

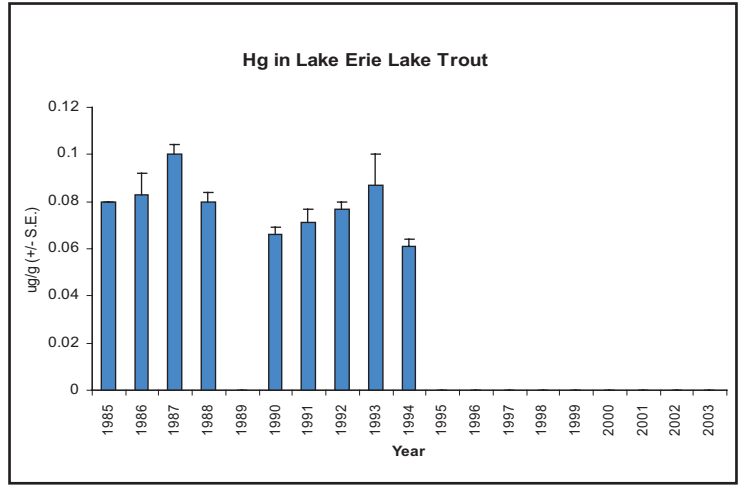


Figure 8. Total mercury levels in Lake Erie Lake Trout, 1985-1994. Canadian data ug/g wet weight +/- S.E., whole fish, ages 4-6 years. Source: Department of Fisheries and Oceans Canada

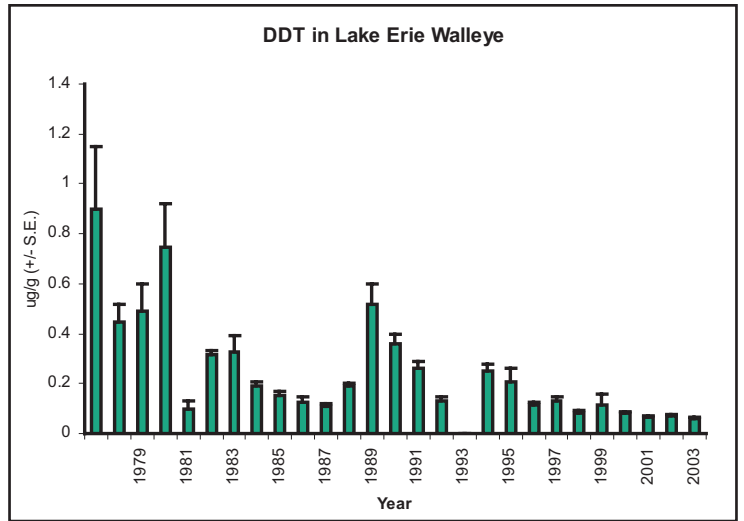


Figure 9. Total DDT levels in Lake Erie Walleye, 1977-2003. Canadian data ug/g wet weight +/- S.E., whole fish, ages 4-6 years. Source: Department of Fisheries and Oceans Canada

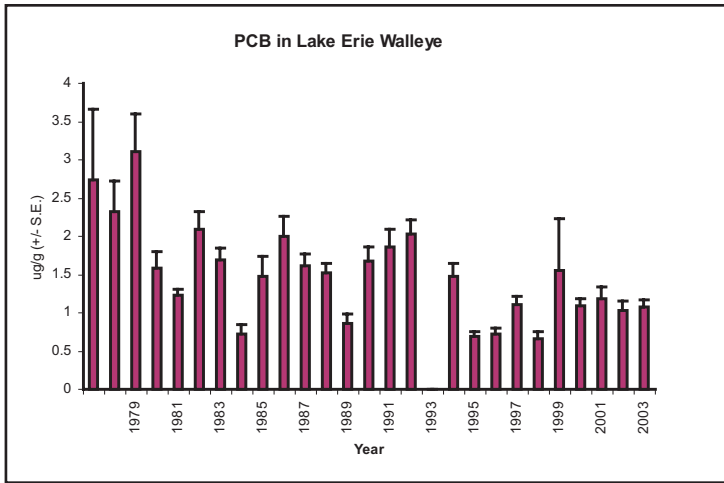
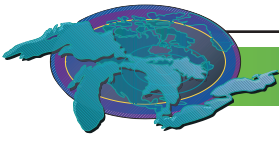


Figure 10. Total PCB levels in Lake Erie Walleye, 1977-2003. Canadian data ug/g wet weight +/- S.E., whole fish, ages 4-6 years. Source: Department of Fisheries and Oceans Canada

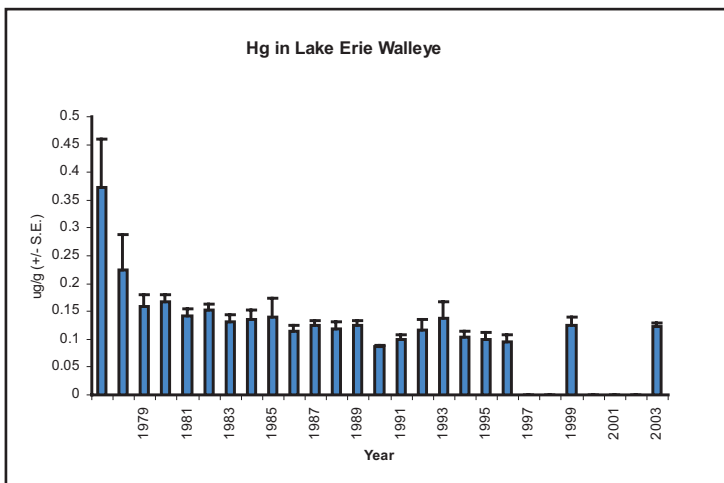


Figure 11. Total mercury levels in Lake Erie Walleye, 1977-2003. Canadian data ug/g wet weight +/- S.E., whole fish, ages 4-6 years. Source: Department of Fisheries and Oceans Canada

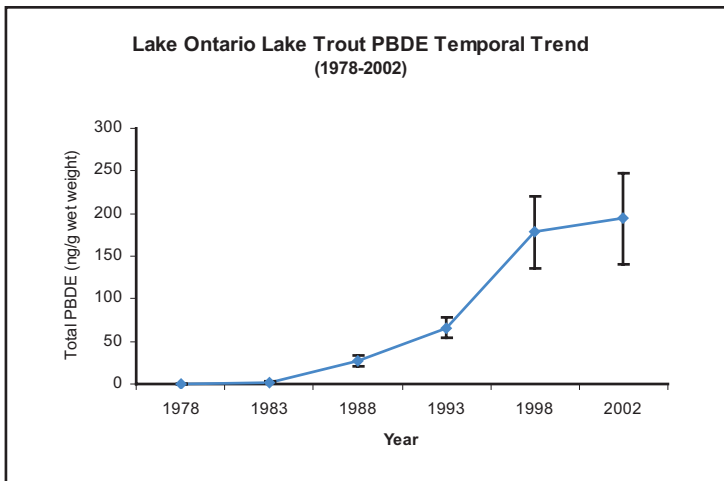
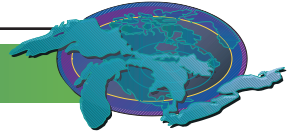


Figure 12. PBDE trends in Lake Ontario Lake Trout, 1978-2002. Canadian data ng/g wet weight +/- S.E. Source: Department of Fisheries and Oceans Canada



## Hexagenia

SOLEC Indicator #122

**Assessment: Mixed, Improving**

### Purpose

The distribution, abundance, biomass, and annual production of the burrowing mayfly *Hexagenia* in mesotrophic Great Lakes habitats is measured directly and used as the indicator. *Hexagenia* is used as an indicator of ecosystem health because it is intolerant of pollution and is thus a good reflection of water and lakebed sediment quality in mesotrophic Great Lakes habitats, where it was historically the dominant, large, benthic invertebrate and an important item in diets of many nearshore fishes.

### Ecosystem Objective

Historically productive Great Lakes mesotrophic habitats e.g., western Lake Erie; the Bay of Quinte, Lake Ontario; Saginaw Bay, Lake Huron; and southern and Green Bay, Lake Michigan, should be restored and maintained as balanced, stable, and productive elements of the Great Lakes ecosystem with *Hexagenia* as the dominant, large, benthic invertebrate.

### State of the Ecosystem

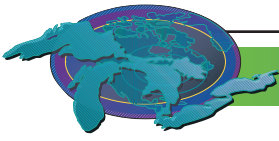
Major declines in the abundance of *Hexagenia* and low abundance or absence in some Great Lakes habitats where they were historically abundant have been linked to eutrophication and low dissolved oxygen in bottom waters and to pollution of sediments by metals and petroleum products. For example, *Hexagenia* was abundant in the western basin of Lake Erie in the 1930s and 1940s but an extensive mortality occurred in 1953. The population there recovered in 1954, but extirpation followed throughout the western basin by the early 1960s (reviewed in Schloesser et al. 2000). Improvements in water and sediment quality in historical *Hexagenia* habitat following the imposition of pollution controls in the 1970s were not immediately followed by the recovery of *Hexagenia* populations (Krieger et al. 1996). Surveys in spring 2001, indicate that; no recovery of *Hexagenia* occurred in Saginaw Bay, little recovery occurred in Green Bay, and a near-full recovery occurred in western Lake Erie (Edsall et al. 2003). In addition, Canadian biologists report the recovery of *Hexagenia* in the Bay of Quinte, Lake Ontario indicating pollution control programs have significantly improved the health of that habitat (personal communication Ron Dermott, Canadian Center of Inland Fisheries, Burlington, Ontario). However, *Hexagenia* was extirpated in polluted portions of the St. Marys and Detroit rivers by the mid-1980s and no recovery has yet been reported for some of these areas.

The recovery of *Hexagenia* in western Lake Erie is a sentinel event, which shows clearly that properly implemented pollution controls can bring about the recovery of a major Great Lakes mesotrophic ecosystem. With its partial recovery, the *Hexagenia* population in western Lake Erie will probably reclaim its functional status as a primary agent in sediment bioturbation and as a trophic integrator directly linking the detrital energy resource to fish, and particularly the economically valuable yellow perch-walleye community. The partial recovery of *Hexagenia* in western Lake Erie also helps remind us of one outstanding public outreach feature associated with using *Hexagenia* as an indicator of ecosystem health—the massive swarms of winged adults that are typical of healthy, productive *Hexagenia* populations in areas of historical abundance in the Great Lakes. These swarms are highly visible to the public who use them to judge the success of water pollution control programs and the health of Great Lakes mesotrophic ecosystems.

### Future Pressures

The virtual extirpation and delayed recovery of the *Hexagenia* population in western Lake Erie was attributed to the widespread, periodic occurrence of anoxic bottom waters, although little evidence existed to support low oxygen persistence over the past 25 years. However, recent, research has documented sporadic anoxia in portions of the basin and some data indicate different oxygen demand of sediments with and without recolonized mayfly nymphs (Bridgeman et al. In review; Schloesser et al. 2001; unpublished data, Schloesser). Most point-source inputs are now controlled, but in-place pollutants in lakebed sediments and non-point pollution appear to be a problem in some areas. Paved surface runoff, spills of pollutants, and combined sewer overflows also pose a major problem in some urban and industrial areas. Phosphorus loadings still exceed guideline levels in some portions of the Great Lakes and loadings may increase as the human population in the Great Lakes basin grows.

The effects of non-native species on *Hexagenia* and its usefulness as an indicator of ecosystem health are unknown and may be problematic. It has been postulated that the colonization of the western basin of Lake Erie by the zebra mussel (*Dreissena polymor-*



*pha*) and the recovery of *Hexagenia* are linked causally, but no specific mechanism has yet been proposed. Support for zebra mussel as a major factor in the recovery of *Hexagenia* in the western basin is perhaps eroded by the fact that Saginaw Bay, Lake Huron, is also heavily colonized by the zebra mussel, but the *Hexagenia* population there, which collapsed in 1955-1956, still has not shown signs of recovery.

#### **Future Activities**

Regulate point sources and non-point sources of pollution and sharply reduce spills of pollutants that enter nearshore waters to improve and maintain Great Lakes water and sediment quality consistent with the environmental requirements of healthy, productive populations of *Hexagenia*. Continue development and application of technology and practices designed to restore lakebed and riverbed sediment quality in Areas of Concern (AOCs) and critical *Hexagenia* habitat areas that have problem levels of persistent, in-place pollutants.

#### **Further Work Necessary**

1. Develop a monitoring program and collect baseline data for *Hexagenia* populations in all major, historical, Great Lakes mesotrophic habitats so that changes in ecosystem health can be monitored and reported, management strategies evaluated and improved, and corrective actions taken to improve ecosystem health and to judge progress toward reaching interim and long term targets and goals.
2. Implement monitoring protocols involving sampling in late spring, immediately prior to the annual emergence of adults.
3. Conduct studies needed to describe the interactions between *Hexagenia* and introduced aquatic species and the effect of those species, if any, on the utility of *Hexagenia* as an indicator of ecosystem health.
4. Determine the most important limiting factor to recovery mayfly populations in nearshore waters of the Great Lakes.
5. Develop predictive tools to estimate when mayfly populations will return to mesotrophic waters where they have not yet returned.

#### **Acknowledgments**

Author: Don W Schloesser, U.S. Geological Survey, Great Lakes Science Center, Ann Arbor, MI, dschloesser@usgs.gov

#### **Sources**

Bridgeman, T.B., Schloesser, D.W., and Goldman, S.L. In review. Can mayfly populations in western Lake Erie survive environmental variability? *Ecological Applications*.

Edsall, T.A., Bur, M.T., Gorman, O.T., and Schaeffer, J.S. 2002. Burrowing mayflies as indicators of ecosystem health: status of populations in western Lake Erie, Saginaw Bay (Lake Huron), and Green Bay (Lake Michigan). Report to USEPA/ GLNPO, January 2002. 28.pp.

Edsall, T.A., Hass, R.C., and Adams, J.V. 2001. Production of burrowing mayfly nymphs in U.S. waters of Lake St. Clair. *J. Great Lakes Res.* 27:449-456.

Krieger, K.A., Schloesser, D.W., Manny, B.A., Trisler, C.E., Heady, S.E., Ciborowski, J.J.H., and Muth, K.K. 1996. *Journal of Great Lakes Research* 22:254-263.

Schloesser, D.W., Krieger, K.A., Ciborowski, J.J.H., and Corkum, L.D. 2001. Recolonization and possible recovery of burrowing mayflies in Lake Erie of the Laurentian Great Lakes. *Journal of Aquatic Ecosystem Stress and Recovery* 8:125-141.

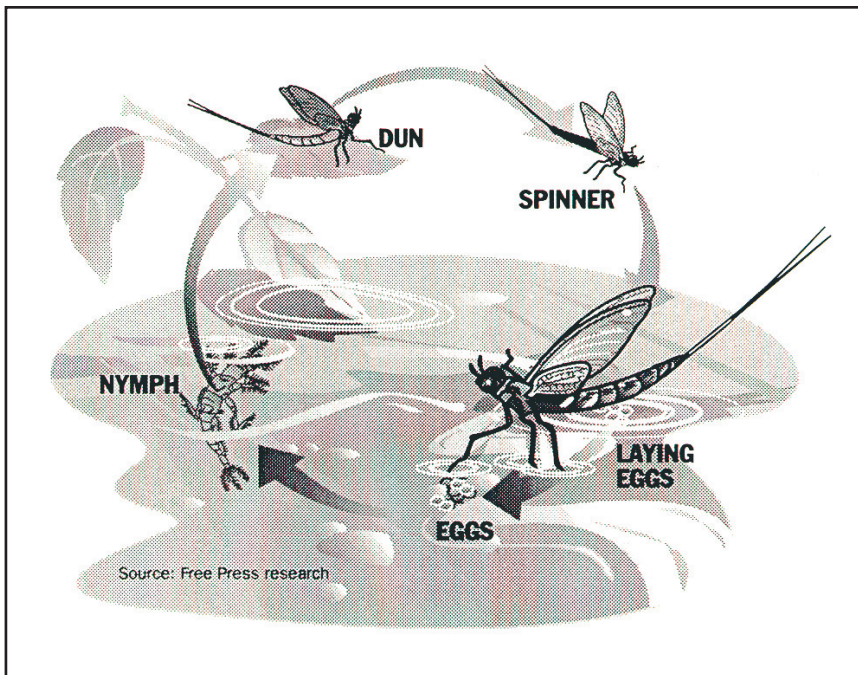
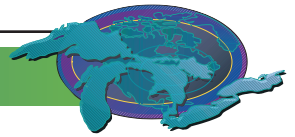


Figure 1. Hexagenia life cycle

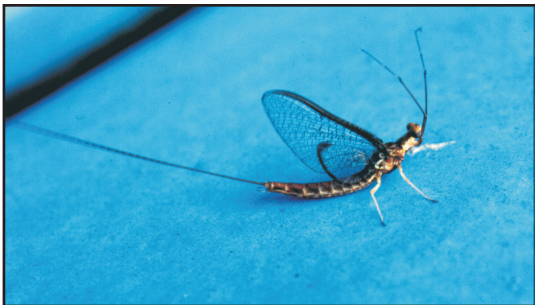
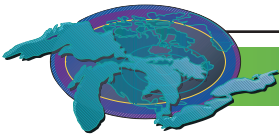


Figure 2. Male Hexagenia





## Abundances of the Benthic Amphipod *Diporeia*

SOLEC Indicator # 123

### Assessment: Mixed, Deteriorating

*Diporeia* is not declining in Lake Superior, but is still doing so in Lakes Michigan, Huron, and Ontario.

### Purpose:

This indicator provides a measure of the biological integrity of the offshore regions of the Great Lakes and consists of assessing the abundance of the benthic macroinvertebrate *Diporeia*. This glacial-marine relic is the most abundant benthic organism in cold, offshore regions (> 30 m) of each of the lakes. It is present, but less abundant in nearshore regions of the open lake basins, and is naturally absent from shallow, warm bays, basins, and river mouths. *Diporeia* occurs in the upper few centimeters of bottom sediment and feeds on algal material that freshly settles to the bottom from the water column (i. e. mostly diatoms). In turn, it is fed upon by most all species of fish. In particular, *Diporeia* is fed upon by many forage fish species, and these species serve as prey for the larger piscivores such as trout and salmon. For example, sculpin feed almost exclusively upon *Diporeia*, and sculpin are fed upon by lake trout. Also, lake whitefish, an important commercial species, feeds heavily on *Diporeia*. Thus, *Diporeia* is an important pathway by which energy is cycled through the ecosystem, and a key component in the food web of offshore regions. The importance of this organism is recognized in the Great Lakes Water Quality Agreement (Supplement to Annex 1 – Specific Objectives).

### Ecosystem Objective

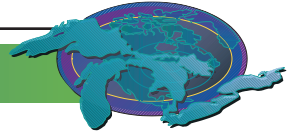
The ecosystem goal is to maintain a healthy, stable population of *Diporeia* in offshore regions of the main basins of the Great Lakes, and to maintain at least a presence in nearshore regions. On a broad scale, abundances are directly related to the amount of food settling to the bottom, and population trends reflect the overall productivity of the ecosystem. Abundances can also vary somewhat relative to shifts in predation pressure from changing fish populations. In nearshore regions, this species is sensitive to local sources of pollution.

### State of the Ecosystem

*Diporeia* populations are currently in the state of dramatic decline in Lakes Michigan, Ontario, and Huron, are completely gone or very rare in Lake Erie, but appear stable in Lake Superior. In all the lakes except Superior, abundances have decreased in both nearshore and offshore areas over the past 12 years, and large areas are now nearly devoid of this organism. Based on most recent data, areas where *Diporeia* are known to be rare or absent include the southern/southeastern and northern portions of Lake Michigan at depths < 70 m, most all of Lake Ontario at depths < 80 m, and the entire southern end and most nearshore areas (< 40 m) of Lake Huron (Figure 1). In Lake Erie, *Diporeia* are naturally absent from the shallower western and central basins, and are no longer present in the deeper eastern basin. In deeper areas of Lakes Michigan, Huron, and Ontario, *Diporeia* are still present but abundances are lower than abundances reported in the 1970s and 1980s. Typical decline patterns at three sites of different depths in Lake Ontario are given in Figure 2. Preliminary analysis of recent data (2003) collected in Lake Ontario indicates that *Diporeia* abundances remain generally similar to abundances found in 1998, with further declines noted along the north shore near Toronto. In all the lakes, population declines coincided with the introduction and rapid spread of the zebra mussel, *Dreissena polymorpha*, and the quagga mussel, *Dreissena bugensis*. These two species were introduced into the Great Lakes in the late 1980s via the ballast water of ocean-going ships. Reasons for the negative response of *Diporeia* to these mussel species are not entirely clear. One hypothesis is that dreissenid mussels are out competing *Diporeia* for available food. That is, large mussel populations were filtering food material before it reached the bottom, thereby decreasing amounts available to *Diporeia*. However, evidence suggests that the reason for the decline is more complex than a simple decline in food because *Diporeia* has completely disappeared from areas where food is still settling to the bottom and where there are no local populations of mussels.

### Pressures

As populations of dreissenid mussels continue to expand, it may be expected that declines in *Diporeia* will become more extensive. In the open waters of Lake Michigan, zebra mussels are most abundant at depths of 30-50 m, and *Diporeia* are now gone from lake areas as deep as 70 m. Quagga mussels have recently been reported from Lake Michigan and, since quagga mussels tend to occur deeper than zebra mussels, the decline or complete loss of *Diporeia* will likely extend to depths >70 m. In portions of Lake Ontario, *Diporeia* populations have disappeared at depths > 100 m.



### Management Implications

The continuing decline of *Diporeia* has strong implications to the Great Lakes food web. As noted, many fish species rely on *Diporeia* as a major prey item, and the loss of *Diporeia* will likely have an impact on these species. Responses may include changes in diet, movement to areas with more food, or a reduction in weight or energy content. Implications to populations include changes in distribution, abundance, growth, recruitment, and condition. Recent evidence suggests that fish are already being affected. For instance, the abundance and condition of an important commercial species, lake whitefish, has declined significantly in areas where *Diporeia* abundances are low in Lakes Michigan, Huron, and Ontario. Also, the condition and abundance of other fish species such as alewife, slimy sculpin, and bloater have also been affected. Management agencies must know the extent and implications of these changes when assessing the current state and future trends of the fishery. Any proposed rehabilitation of native fish species, such as the re-introduction of deepwater ciscoes in Lake Ontario, requires knowledge that adequate food and especially *Diporeia* is present.

### Further Work Necessary

Because of the rapid rate at which *Diporeia* is declining and its significance to the food web, agencies committed to documenting trends should report data in a timely manner. The population decline has a defined natural pattern, and studies of food web impacts should be spatially well coordinated. Also, studies to define the cause of the negative response of *Diporeia* to *Dreissena* should continue. With an understanding of exactly why *Diporeia* populations are declining, we may better predict what additional areas of the lakes are at risk.

### Acknowledgements

Authors: T. F. Nalepa, Great Lakes Environmental Research Laboratory, National Oceanic and Atmospheric Administration, Ann Arbor, MI.; R. Dermott, Great Lakes Laboratory for Fisheries and Aquatic Sciences, Fisheries and Oceans Canada, Burlington, Ontario.

### Sources

- Dermott, R. and D. Kerec. 1997. Changes in the deepwater benthos of eastern Lake Erie since the invasion of *Dreissena*: 1979-1993. *Can. J. Fish. Aquat. Sci.* 54: 922-930.
- Dermott, R. 2001. Sudden disappearance of the amphipod *Diporeia* from eastern Lake Ontario, 1993-1995. *J. Great Lakes Res.* 27: 423-433.
- Hondorp, D. W., Pothoven, S. A., and Brandt, S. B. Influence of varying *Diporeia* spp. density on offshore fish communities in southern Lake Michigan. (submitted).
- Hoyle, J. A., Shaner, T., Casselman, J. M., and Dermott, R. 1999. Changes in the lake whitefish (*Coregonus clupeaformis*) stocks in eastern Lake Ontario following *Dreissena* mussel invasion. *Great Lakes Res. Rev.* 4: 5-10.
- Lozano, S. J., J. V. Scharold, and T. F. Nalepa. 2001. Recent declines in benthic macroinvertebrate densities in Lake Ontario. *Can. J. Fish. Aquat. Sci.* 58: 518-529.
- Nalepa, T. F., D. J. Hartson, D. L. Fanslow, G. A. Lang, and S. J. Lozano. 1998. Declines in benthic macroinvertebrate populations in southern Lake Michigan, 1980-1993. *Can. J. Fish. Aquat. Sci.* 11: 2402-2413.
- Owens, R. W. and Dittman, D E. 2003. Shifts in the diets of slimy sculpin (*Cottus cognatus*) and lake whitefish (*Coregonus clupeaformis*) in Lake Ontario following the collapse of the burrowing amphipod *Diporeia*. *Aquat. Ecosys. Health Manag.* 6: 311-323.
- Pothoven, S. A., T. F. Nalepa, P. J. Schneeberger, and S. B. Brandt. 2001. Changes in diet and body condition of lake whitefish in southern Lake Michigan associated with changes in benthos. *N. Amer. J. Fish. Manag.* 21: 876-883.

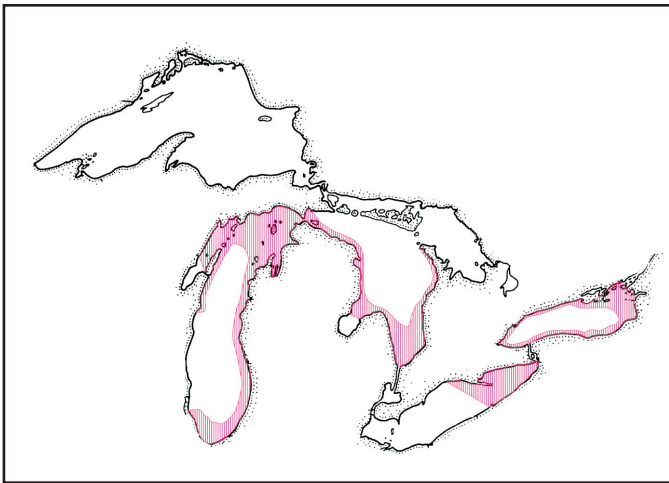
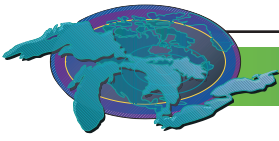


Figure 1. Areas in the Great Lakes where *Diporeia* were once present but have now completely disappeared (red hatch). *Diporeia* are naturally not present in inner Green Bay, inner Saginaw Bay, Lake St. Clair, and the western and central basins of Lake Erie. Because of insufficient data, areas of *Diporeia* loss in North Channel and Georgian Bay, Lake Huron are unknown. Populations are not declining in Lake Superior.

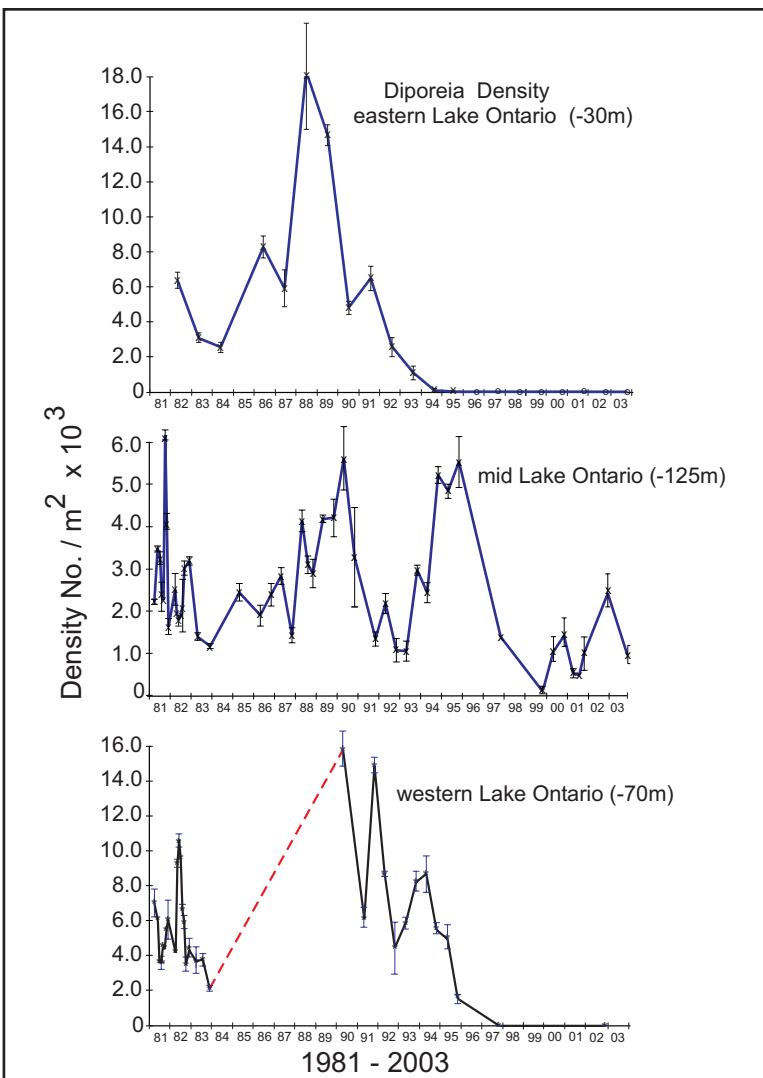
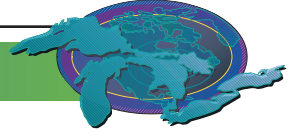


Figure 2. Trends in densities (no. m<sup>2</sup> x 10<sup>3</sup>) of *Diporeia* at three sites in Lake Ontario between 1983 and 2003. The sites represent different depths and regions within the lake.



## External Anomaly Prevalence Index (EAPI) for Nearshore Fish

SOLEC Indicator ID: #124 (June 9, 2004)

*This indicator replaced indicator #101*

### Assessment

Current Condition: Poor-Mixed

Trajectory: Underdetermined

### Purpose

This indicator will assess external anomalies in nearshore fish. An index will be used to identify areas where fish are exposed to contaminated sediments within the Great Lakes. The presence of contaminated sediments at Areas of Concern (AOCs) has been correlated with an increase incidence of anomalies in benthic fish species (brown bullhead and white suckers), that may be associated with specific groups of chemicals.

### Ecosystem Objective

As a result of clean-up efforts, AOCs that historically have had a high incidence of fish with external anomalies currently show fewer abnormalities. Use of an External Anomaly Prevalence Index (EAPI) based on prevalent external anomalies will help identify nearshore areas that have populations of benthic fish exposed to contaminated sediments and will help assess the recovery of AOCs following remedial activities. The objective is to help restoration and protection of beneficial uses in Areas of Concern or in open Great Lakes waters, including beneficial use (iv) *Fish tumors or other deformities* (GLWQA, Annex 2). This indicator also supports Annex 12 of the GLWQA.

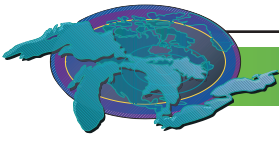
### State of the Ecosystem

Elevated incidence of liver tumors (histopathologically verified pre-neoplastic or neoplastic growths) were frequently identified during the past two decades. These elevated frequencies of liver tumors have been shown to be useful indicators of beneficial use impairment of Great Lakes aquatic habitat. External raised growths (sometimes as histopathologically verified tumors on the body and lips), such as lip papillomas have also been a useful indicator. Raised growths may not have a single etiology; however, they have been produced experimentally by direct application of PAH carcinogens to brown bullhead skin. Field and laboratory studies have correlated chemical contaminants found in sediments at some AOCs in Lake Erie, Michigan, Ontario and Huron with verified liver and external raised growths. Other external anomalies may also be used to assess beneficial use impairment; however, they must be carefully evaluated. The external anomaly prevalence index (EAPI) will provide a tool for following trends in fish population health that can be used by resource managers and community-based monitoring programs.

EAP Index — The external anomaly prevalence index (EAPI) has been developed for mature (> 3 years of age) fish as a marker of both contaminant exposure and of internal pathology. Brown bullhead has been used to develop the index. They are the most frequently used benthic indicator species in the southern Great Lakes and are been recommended by the International Joint Commission (IJC) as the key indicator species (IJC 1989). The most common external anomalies found in brown bullhead over the last twenty years from Lake Erie (Figure 1) are: 1) Abnormal barbels (BA); 2) Focal discoloration (FD); and 3) Raised growths (RG) - on the body and/or lips (L).

Initial statistical analysis of sediments and external anomalies at different locations indicates that variations in the chemical mixtures (PAH, PCB, OC, metals) are reflected in a differing prevalence of individual external anomalies. Impairment determinations should be based on comparing the prevalence of external anomalies at potentially contaminated sites with the prevalence at “reference” (least impacted) sites. Preliminary data indicates that if the prevalence of lip raised growths (lip papillomas) is >10%, or the external raised growths (body and Lip) >15% in brown bullhead, that the population should be considered impaired. The additional use of barbel abnormalities and focal discoloration (melanistic alterations) will help to differentiate degrees of impairment of fish population health. Figure 2 illustrates the comparison of AOCs with contaminated sediments to reference conditions at HUR (Huron River) and OWC (Old Woman Creek).

Surveys conducted in 1999 and 2000 in the Detroit, Ottawa, Black, Cuyahoga, Ashtabula, Buffalo, and Niagara Rivers and at Old Woman Creek in Lake Erie demonstrated that external raised growths are positively associated with both PAH metabolites in bile



and total PAH concentrations in sediment (Figures 3 & 4). The association with bile PAH metabolites (Figure 3) is stronger than that with sediment total PAH concentrations (Figure 4). Bile metabolite concentrations may be a better estimate of exposure. Barbel deformities (Figure 4) also showed a positive correlation with total PAH levels in sediment. In addition to the locations listed above, the Huron River and Presque Isle Bay sites all showed a statistically significant correlation between external raised lesions and concentrations of heavy metals in sediment (Figure 5).

### Pressures

Some Great Lakes AOCs and their tributaries remain in a degraded condition. Exposure of the fish populations to contaminated sediments continues and will continue to cause elevated incidence of external anomalies. The human population and industrialization of Great Lakes tributaries and shorelines will expand in the future. Thus, concurrently some areas of expanding growth will continue to deteriorate even as control measures and remediation improve conditions at the older contaminated sites.

### Management Implications

The EAPI provides managers and researchers a tool to monitor contaminant impacts to the fish populations in Great Lakes AOCs. Additional remediation to clean-up of contaminated sediments at Great Lakes AOCs will help to reduce rates of external anomalies. The EAPI, particularly for brown bullheads and white suckers, will help follow trends in fish population health and help to determine the status of AOCs that may be considered for delisting (IJC Delisting Criteria, see IJC 1996). The EAPI will serve as a significant monitoring tool to scrutinize select fish populations.

### Acknowledgments

Stephen B. Smith, U.S. Geological Survey, Biological Resources, Reston, VA; and Paul C. Baumann, U.S. Geological Survey, Biological Resources, Columbus, OH. Scott Brown, National Water Research Institute, Burlington, ON

### Sources

International Joint Commission. 1989. Guidance on characterization of toxic substances problems in areas of concern in the Great Lakes Basin. Report of the Great Lakes Water Quality Board. Windsor, ON, Canada.

International Joint Commission. 1996. Indicators to evaluate progress under the Great Lakes Water Quality Agreement. Indicators for Evaluation Task Force. ISBN 1-895058-85-3.

Smith, S.B., D.R.P. Reader, P.C. Baumann, S.R. Nelson, J.A. Adams, K.A. Smith, M.M. Powers, P.L. Hudson, A.J. Rosolofson, M. Rowan, D. Peterson, V.S. Blazer, J.T. Hickey, and K. Karwowski. 2003. Lake Erie Ecological Investigation; Summary of findings: Part 1; Sediments, Invertebrate communities, and Fish Communities: Part 2; Indicators, anomalies, Histopathology, and ecological risk assessment. U.S. Geological Survey Mimeo.

### Further Work Necessary

This external anomaly indicator for benthic species has potential for defining habitats that are contaminated. Collaborative U.S.-Canadian studies investigating the etiology and prevalence of external anomalies in benthic fishes over a gradient of polluted to pristine Great Lakes habitats are needed. These studies would create a common index that could be used as an indicator of ecosystem health.

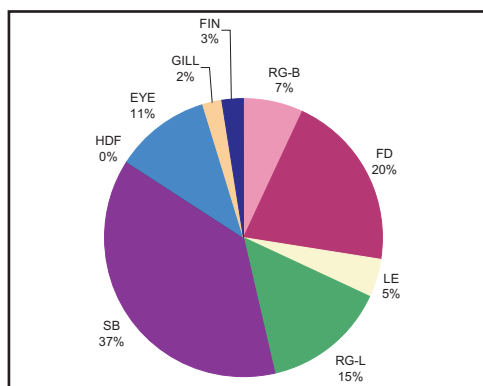


Figure 1. External anomalies on brown bullhead collected from Lake Erie from 1980s through 2000. BA – barbell abnormality, RG – raised growth (body and lip), FD – focal discoloration, LE – lesion (total 2439 fish). Source: Great Lake Science Center database, Ann Arbor, MI.

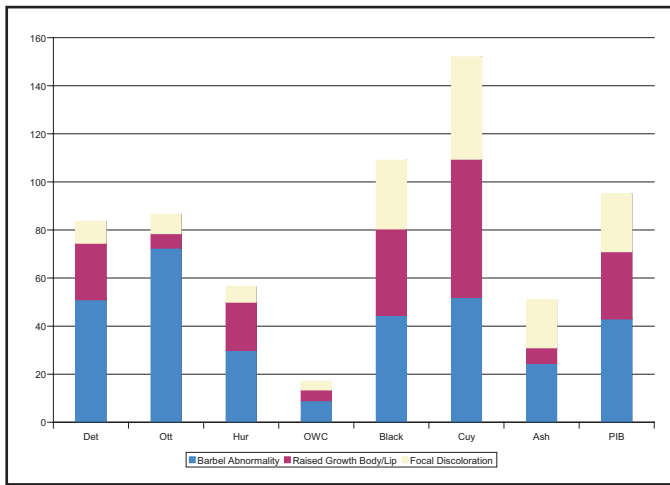
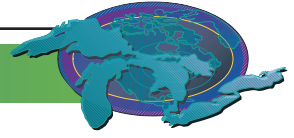


Figure 2. Prevalence of three most common external anomalies at Lake Erie AOCs. [Det - Detroit River, MI; Ott - Ottawa River, OH; Hur - Huron River, OH (Reference); OWC - Old Woman's Creek, OH (Reference); Black River, OH; Cuy - Cuyahoga River, OH - Cleveland Harbor and upstream combined; Ash - Ashtabula River, OH; PIB - Presque Isle Bay, PA]. Source; Smith et al. 2003

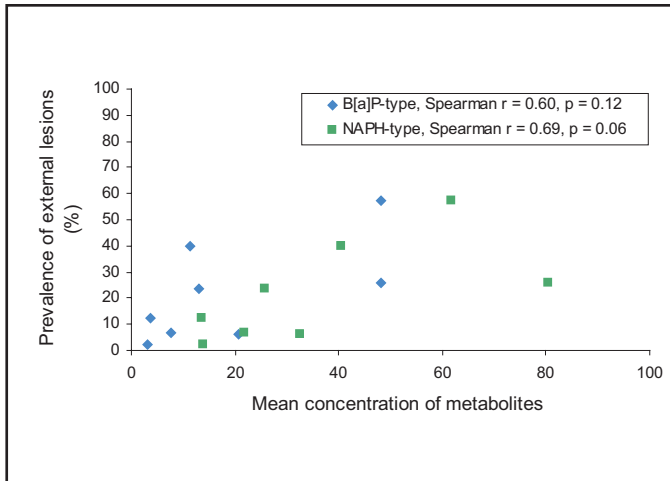


Figure 3. Prevalence of external raised lesions in brown bullhead from Lake Erie tributaries compared to PAH metabolite concentrations in bile (B[a]P and NAPH-type). Source: Yang and Baumann, unpublished data

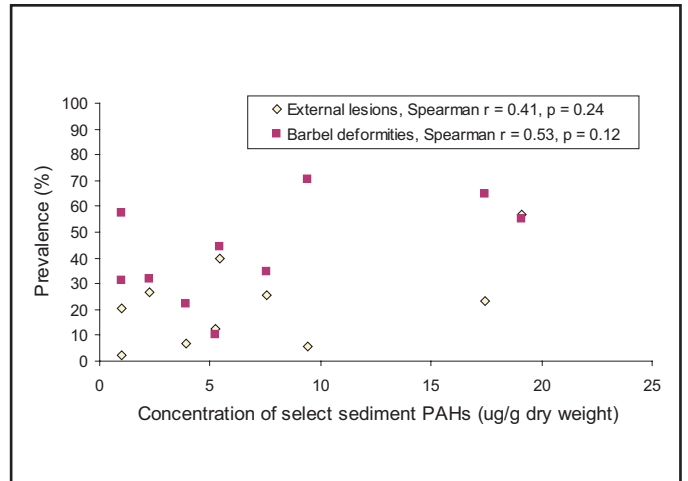


Figure 4. Prevalence of external raised lesions and barbel deformities in brown bullhead from Lake Erie tributaries compared to total PAH concentrations in sediment. Source: Yang and Baumann, unpublished data

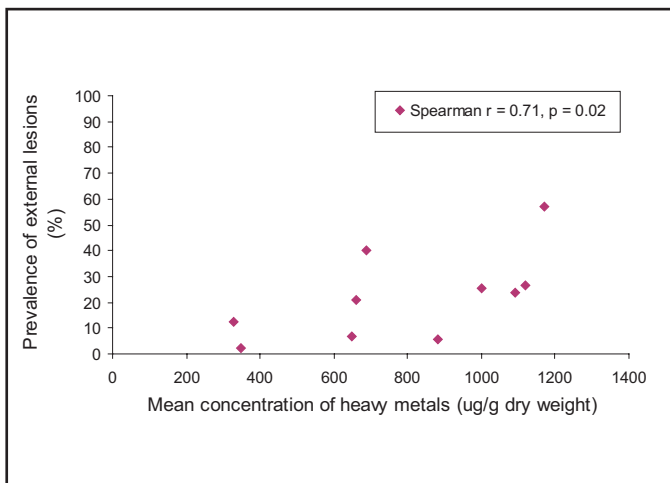
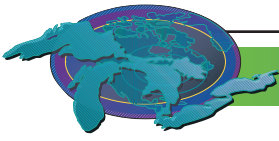


Figure 5. Prevalence of external raised lesions in brown bullhead from Lake Erie tributaries compared to concentrations of heavy metals in sediment. Source; Yang and Baumann, unpublished data



## Status of Lake Sturgeon in the Great Lakes

SOLEC Indicator #125

**Assessment:** Mixed, Undetermined

### Purpose

Lake sturgeon, *Acipenser fulvescens*, were historically abundant in the Great Lakes with spawning populations using many of the major tributaries, connecting waters, and shoal areas across the basin. Prior to European settlement of the region, they were a dominant component of the nearshore benthivore fish community, with populations estimated in the millions in each of the Great Lakes (Baldwin et al. 1979). In the mid to late 1800s, they contributed significantly as a commercial species ranking among the five most abundant species in the commercial catch (Baldwin et al. 1979, Figure 1).

The decline of lake sturgeon populations in the Great Lakes was rapid and commensurate with habitat destruction, degraded water quality, and intensive fishing associated with settlement and development of the region. Sturgeon were initially considered a nuisance species of little value by European settlers, but by the mid 1800s, their value as a commercial species began to be recognized and a lucrative fishery developed. In less than 50 years, their abundance had declined sharply, and since 1900, they have remained a highly depleted species of little consequence to the commercial fishery. Sturgeon are now extirpated from many tributaries and waters where they once spawned and flourished (Figure 2 and 3). They are considered rare, endangered, threatened, or of watch or special concern status by the various Great Lakes fisheries management agencies. Their harvest is currently prohibited or highly regulated in most U. S. and Canadian waters of the Great Lakes.

Lake sturgeon are an important native species that are listed in the fish community objectives for all of the Great Lakes. Many of the Great Lakes states and provinces either have or are developing lake sturgeon management plans promoting the need to inventory, protect, and restore the species to greater levels of abundance. Presence of lake sturgeon in abundance in the Great Lakes will indicate a healthy ecosystem. When the Great Lakes were still in pristine conditions (prior to European settlement) lake sturgeon were extremely abundant in the lakes. If the condition of the lakes were improved to the point where lake sturgeon numbers were able to increase, it would indicate a healthy improving ecosystem.

### Ecosystem Objective

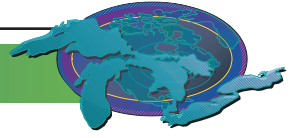
While overexploitation removed millions of adult fish, habitat degradation and alteration eliminated traditional spawning grounds. Current work is underway by state, federal, tribal, provincial, and private groups to document active spawning sites, assess habitat condition and availability of good habitat, and determine the genetics of remnant Great Lakes lake sturgeon populations.

Lake sturgeon is identified by all the Great Lakes in their Fish Community Objectives. Lake Superior has a lake sturgeon management plan, and many of the Great Lakes States have lake sturgeon recovery/rehabilitation plans which call for increasing numbers of lake sturgeon beyond current levels. Because lake sturgeon are a native species to the Great Lakes efforts should be put forth to restore their numbers.

### State of the Ecosystem

Efforts are underway by many groups to gather information on remnant spawning tributary and shoal populations in the Great Lakes. Lake sturgeon populations are known to be abundant in the connecting waterways of the Great Lakes. Very little information exists on juvenile lake sturgeon ages (0-2). In many systems, access to spawning habitat has been blocked, and other habitats have been altered. However, there are remnant populations in each basin of the Great Lakes, and some of these populations are large in number (10's of thousands of fish) (Figure 3).

Sturgeon populations in Lake Michigan continue to sustain themselves at a small fraction of their historical abundance. Optimistic estimates of the lakewide adult abundance are below 5,000 fish, well below 1% of the most conservative estimates of historic abundance (Hay-Chmielewski and Whelan 1997). Remnant populations currently are known to spawn in waters of at least 8 tributaries having unimpeded connections to Lake Michigan (Zollweg et al. 2003). Two rivers, the Menominee and Peshtigo appear to support annual spawning runs of 200 or more adults and four rivers, the Manistee, Muskegon, Fox and Oconto appear to support annual spawning runs of between 25 and 75 adults. Successful reproduction has been documented in all six of these rivers although actual recruitment levels remain unknown. However, abundance in some of these rivers appears to be increasing in recent years. Two



other rivers, the Manistique and Kalamazoo appear to have annual spawning runs of less than 25 fish and reproductive success remains unknown. Lake sturgeon have been observed during spawning times in a few other Lake Michigan tributaries such as the St. Joseph, Grand and Millecoquins, and near some shoal areas where sturgeon are thought to have spawned historically, but It is not known if spawning occurs regularly in these systems and their status is uncertain.

In Lake Superior, sturgeon are distributed throughout the basin with concentrations found near spawning tributaries in the U. S. and Canada. At least 22 tributaries historically supported spawning populations and current reproduction has been documented in 11 of these tributaries of which 10 are known to be self-sustaining populations. The tributaries in which current natural reproduction has been documented include: Sturgeon River, Michigan; Bad and White Rivers, Wisconsin; and Goulais, Batchawana, Michipicoten, Pic, Gravel, Nipigon, Black Sturgeon, and Kaministiquia Rivers in Ontario. Populations from each of these rivers are reduced from historical levels and the population status is described as “remnant”, indicating an annual spawning run of less than 1,000 individuals. Currently, there is no commercial harvest of lake sturgeon allowed in Lake Superior. Regulation of recreational and subsistence/home use harvest in Lake Superior varies by agency.

Lake Ontario has lake sturgeon spawning activity documented in two major tributaries (Niagara River and Trent River) and suspected in at least one more (Black River) on an infrequent basis. There is no targeted assessment of lake sturgeon in Lake Ontario, but incidental catches in research nets have occurred since 1997 (OMNR 2004) and 1995 (NYS DEC 2004) indicating a possible improvement in population status. Age analysis of lake sturgeon captured in the lower Niagara River indicates successful reproduction in the mid 1990's. NYS Department of Environmental Conservation initiated a stocking program in 1995 to recover lake sturgeon populations. Lake sturgeon were stocked in Oneida Lake, Genesee River, Black Lake, St. Regis River, and St. Lawrence River in 2003. There are sizeable populations within the St. Lawrence River system, most notably the Des Prairies River, Lac St. Pierre and the St. Maurice River. However, access is inhibited for many of the historical spawning grounds in tributaries by small dams and within the river by the Moses-Saunders Dam.

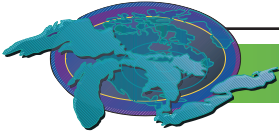
Lake Erie does not currently have lake sturgeon spawning activity documented in any major tributaries; however, spawning has been confirmed in the connecting waterways- Detroit River and further upstream in the St. Clair River. There is also a sizeable population in Lake St. Clair, sufficient to allow harvest by Michigan anglers. The western basin of Lake Erie continues to be a nursery area for juvenile lake sturgeon with incidental catches periodically in commercial fishing nets. Lake sturgeon are more scarce in the central and eastern basins with only occasional catches of subadult or adult lake sturgeon in commercial fishing nets and none in research nets. A botulism related die off in 2001 and 2002, and declines in sitings by anglers and other recreationalists near Buffalo indicate a possible decline in population abundance of lake sturgeon in Lake Erie.

Lake Huron populations of lake sturgeon are monitored primarily through the volunteer efforts of commercial fishers cooperating with the various resource management agencies. There are hundreds of lake sturgeon tagged in Saginaw Bay by commercial fishers and another cooperative project with a commercial fisher on southern Lake Huron has also resulted in many tagged fish and evidence of movement of fish between Saginaw Bay and southern Lake Huron when tagged fish are recaptured. There is a limited commercial harvest of lake sturgeon allowed in Canadian waters of Lake Huron, and some sport harvest is allowed in the tributaries with spawning populations. Recent research efforts on Lake Huron have been focused on migration patterns, testing archival tag technology and contaminant testing methodologies, as well as contributing samples for the Great Lakes Basin genetic structure of lake sturgeon (Hill and McClain 2004).

### Pressures

Low numbers or lack of fish (where extirpated) in itself is a significant impediment to recovery in many spawning areas. Barriers that prevent lake sturgeon from moving into tributaries to spawn are a major problem. Predation on eggs and newly hatched lake sturgeon by non-native predators may also be a problem. The genetic structure of remaining populations is being studied by university researchers and fishery managers and this information will be used to guide future management decisions. With the collapse of the Caspian Sea sturgeon populations black market demand for sturgeon caviar could put tremendous pressure on Great Lakes lake sturgeon populations. An additional concern for lake sturgeon in Lake Erie and Lake Ontario is the presence of high densities of round gobies and the spread of Botulism Type E which produced a die off of lake sturgeon in Lake Erie in 2001 and 2002, and may have been the cause of similar mortalities observed in Lake Ontario in 2003 and in Green Bay of Lake Michigan.





### **Management Implications**

Several meetings and workshops have been held focusing on identifying the research and assessment needs to further rehabilitation of lake sturgeon in the Great Lakes (Holey et al. 2000) and a significant amount of research and assessment directed towards these need has occurred in the last 10 years. Among these is the significant amount of work that has been ongoing to better define the genetic structuring of Great Lakes lake sturgeon populations and genetics based rehabilitation plans are being developed to help guide reintroduction and rehabilitation efforts being implemented across the Great Lakes. Research into new fish passage technologies that will allow safe upstream and downstream passage around barriers to migration also have been underway for several years. Many groups are continuing to work to identify current lake sturgeon spawning locations in the Great Lakes and studies are being initiated to identify habitat preferences for juvenile lake sturgeon (ages 0-2).

### **Acknowledgements**

Emily C. Zollweg, U. S. Fish and Wildlife Service, Lower Great Lakes FRO, 405 N. French Rd., Suite 120A, Amherst, NY 14228  
Emily\_Zollweg@fws.gov

Robert F. Elliott, U. S. Fish and Wildlife Service, Green Bay FRO, 2661 Scott Tower Drive, New Franken, WI 54229

Henry Quinlan, U. S. Fish and Wildlife Service, Ashland FRO, 2800 Lakeshore Drive E., Ashland, WI 54806

John Weisser, U. S. Fish and Wildlife Service, Marquette Biological Station, 1924 Industrial Parkway, Marquette, MI 49855

### **Sources**

Auer, Nancy. Lake Sturgeon: A Unique and Imperiled Species in the Great Lakes. Chapter 17 in Great Lakes Fisheries Policy and Management: A Binational Perspective.

Baldwin, N. S., R. W. Saalfeld, M. A. Ross and H. J. Buettner. 1979. Commercial fish production in the Great Lakes 1867-1977. Great Lakes Fishery Commission Technical Report 3.

Eckert, T. H. 2004. Summary of 1976-2003 Warm Water Assessment. in New York State Department of Environmental Conservation. Lake Ontario Annual Report 2003. Bureau of Fisheries, Lake Ontario Unit and St. Lawrence River Unit. Cape Vincent and Watertown, NY.

Hay-Chmielewski, E.M.; Whelan, G.E., 1997: Lake sturgeon rehabilitation strategy. Michigan Department of Natural Resources Fisheries Division, Special Report Number 18, Ann Arbor, MI. 51 pp.

Hill T. D. and J. R. McClain editors. 2004. 2002 Activities of the Central Great Lakes Binational Lake Sturgeon Group. U. S. Fish and Wildlife Service, Alpena, MI.

Holey, M. E., E. A. Baker, T. F. Thuemler, R. F. Elliott. 2000. Research and Assessment Needs to Restore Lake Sturgeon in the Great Lakes: Results of a Workshop Sponsored by the Great Lakes Fishery Trust. Lansing, MI. 39 pp.

Ontario Ministry of Natural Resources. 2004. Lake Ontario Fish Communities and Fisheries: 2003 Annual Report of the Lake Ontario Management Unit. Ontario Ministry of Natural Resources, Picton, Ontario, Canada.

Zollweg, Emily C., Robert F. Elliott, Tracy D. Hill, Henry R. Quinlan, Elizabeth Trometer, and John W. Weisser, Editors. 2003. Great Lakes Lake Sturgeon Coordination Meeting. Proceedings of the December 11-12, 2002 Workshop, Sault Ste. Marie, MI.

### **Further Work Necessary**

More information is needed to determine ways to get lake sturgeon past barriers on rivers. More monitoring is needed to determine the current status of Great Lakes lake sturgeon populations. More information is also needed on juvenile lake sturgeon. More law enforcement is needed to protect large adult lake sturgeon. In addition, there are significant, legal, logistical, and financial hurdles to overcome in order to restore degraded spawning habitats in connecting waterways and tributaries to the Great Lakes.

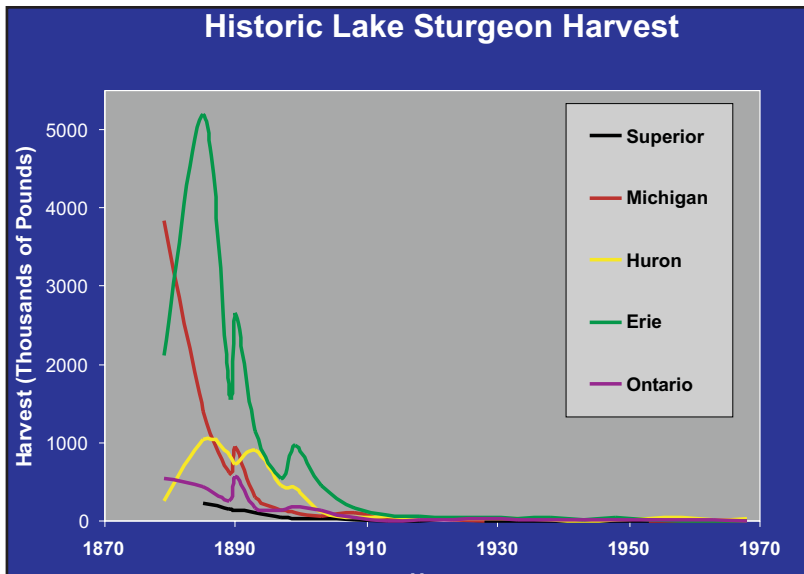
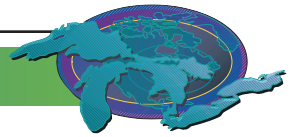


Figure 1

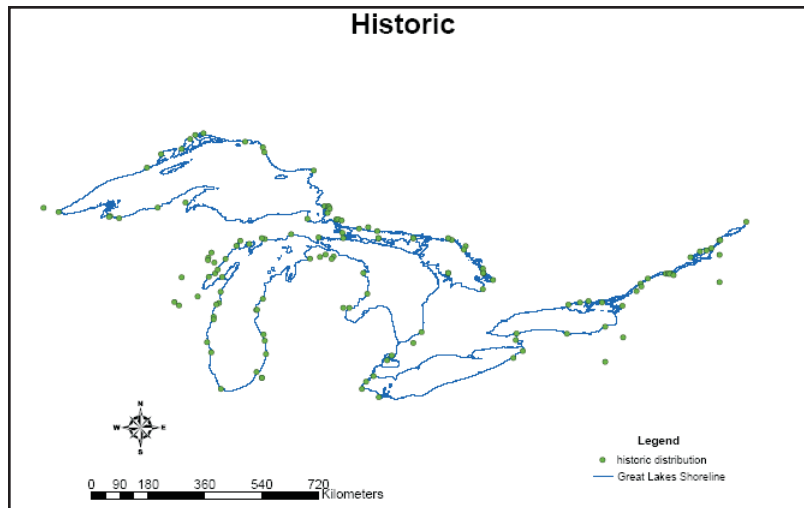


Figure 2

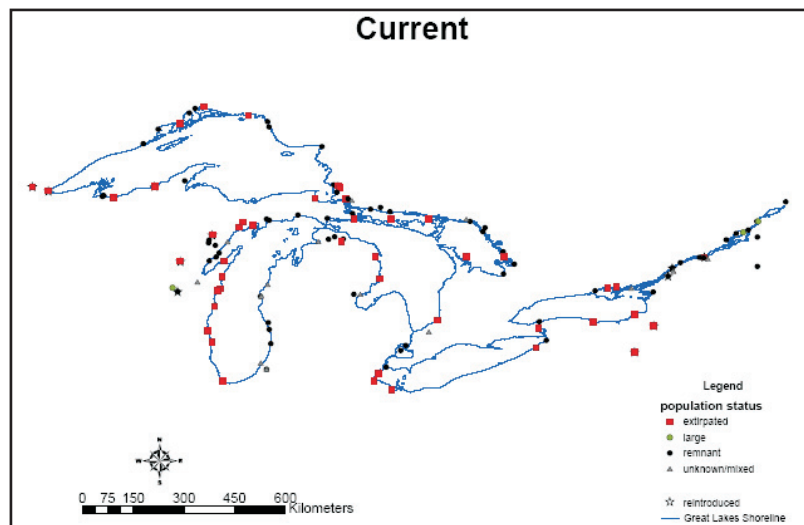
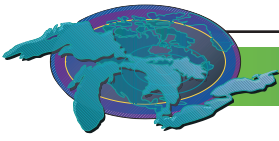


Figure 3



## Commercial / Industrial Eco-Efficiency Measures

SOLEC Indicator #3514

*This indicator report is from 2002.*

**Assessment: Unable to make an assessment until historical trend data is available. This is the first time this indicator has been measured.**

### Purpose

This indicator assesses the institutionalized response of the commercial/industrial sector to pressures imposed on the ecosystem as a result of production processes and service delivery. It is based upon the public documents produced by the 25 largest employers in the basin which report eco-efficiency measures and implement eco-efficiency strategies. The 25 largest employers were selected as industry leaders and proxy for assessing commercial/industrial eco-efficiency measures. This indicator should not be considered a comprehensive evaluation of all the activities of the commercial/industrial sector, particularly small-scale organizations, though it is presumed that many other industrial/commercial organizations are implementing and reporting on similar strategies.

### Ecosystem objective

The goal of eco-efficiency is to deliver competitively priced goods and services that satisfy human needs and increase quality of life, while progressively reducing ecological impacts and resource intensity throughout the lifecycle, to a level at least in line with the earth's estimated carrying capacity<sup>1</sup>. In quantitative terms, the goal is to increase the ratio of the value of output(s) produced by a firm to the sum of the environmental pressures generated by the firm<sup>2</sup>.

### State of the Ecosystem

Efforts to track eco-efficiency in the Great Lakes basin and in North America are still in the infancy stage. This is the first assessment of its kind in the Great Lakes region. It includes twenty-five of the largest private employers, from a variety of sectors, operating in the basin. Participation in eco-efficiency was tabulated from publicly available environmental reporting data from 10 Canadian companies and 14 American companies based in (or with major operations in) the Great Lakes.

Tracking of eco-efficiency indicators is based on the notion: "what is measured is what gets done". The evaluation of this indicator is conducted by recording presence/absence of reporting related to performance in 7 eco-efficiency reporting categories (net sales, quantity of goods produced, material consumption, energy consumption, water consumption, greenhouse gas emissions, emissions of ozone depleting substances)<sup>3</sup>. In addition, the evaluation includes an enumeration of specific initiatives that are targeted toward one or more of the elements of eco efficiency success (material intensity, energy intensity, toxic dispersion, recyclability and product durability).

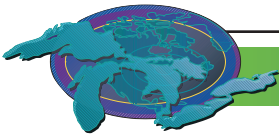
Of the 24 companies surveyed, 10 reported publicly (available online or through customer service inquiry) on at least some measures of eco-efficiency. Energy consumption and, to some extent, material consumption were the most commonly reported measures. Of the 10 firms that reported on some elements of eco-efficiency, 3 reported on all 5 measures.

More companies, 19 (76%) of the 25 companies surveyed, reported on implementation of specific ecoefficiency related initiatives. 2 companies reported activities related to all 5 success areas. Reported initiatives were most commonly targeted toward improved recycling and improved energy efficiency.

Overall, companies in the manufacturing sector tended to provide more public information on environmental performance than the retail or financial sectors. At the same time, nearly all firms expressed a commitment to reducing the environmental impact of their operations. A select number of companies, such as Steelcase Inc. and General Motors in the U.S.A. and Nortel Networks in Canada, have shown strong leadership in comprehensive, easily accessed, public reporting on environmental performance. Others, such as Haworth Inc. and Quad/Graphics, have shown distinct creativity and innovation in implementing measures to reduce their environmental impact.

## 2.1 SOCIETAL RESPONSE INDICATORS

The concept of eco-efficiency was defined in 1990 and was not widely known until several years later. Specific data on



commercial/industrial measures are only just being implemented; therefore, it is not yet possible to determine trends in eco-efficiency reporting. In general, firms appear to be working to improve the efficiency of their goods and service delivery. This is an important trend as it indicates the growing ability of firms to increase the quantity number of goods and services produced for the same or a lesser quantity of resources per unit of output.

While one or more eco-efficiency measures are often included in environmental reporting, only a few firms recognize the complete eco-efficiency concept. Many firms recognize the need for more environmentally sensitive goods and services delivery; however, the implementation of more environmentally efficient processes appears narrow in scope. These observations indicate that more could be done toward more sustainable goods and services delivery.

#### **Future Pressures**

Eco-efficiency per unit of production will undoubtedly increase over time, given the economic, environmental and public relations incentives for doing so. However, as Great Lakes populations and economies grow, quantity of goods and services produced will likely increase. If production increases by a greater margin than eco-efficiency Improvements, then the overall commercial/ industrial environmental impact will continue to rise. Absolute reductions in the sum of environmental pressures are necessary to deliver goods and services within the earth's carrying capacity.

#### **Future Action**

The potential for improving the environmental and economic efficiency of goods and services delivery is unlimited. To meet the ecosystem objective, more firms in the commercial/ industrial sector need to recognize the value of eco-efficiency and need to monitor and reduce the environmental impacts of production.

#### **Further Work Necessary**

By repeating this evaluation at a regular interval (2 or 4 years) trends in industrial/commercial ecoefficiency can be determined. The sustainability of goods and service delivery in the Great Lakes basin can only be determined if social justice measures are also included in commercial/industrial sector assessments. The difficulty in assessing the impacts of social justice issues precludes them from being included in this report, however, such social welfare impacts should be included in future indicator assessment.

#### **Acknowledgments**

Author: Laurie Payne, LURA Consulting. Contributors: Christina Forst, Oak Ridge Institute for Science and Education, on appointment to U.S. Environmental Protection Agency, Great Lakes National Program Office, and Dale Phenicie & George Kuper, Council of Great Lakes Industries. Tom Van Camp and Nicolas Dion of Industry Canada provided several data resources. Many of the firms surveyed in this report also contributed environmental reports and other corporate information. Chambers of commerce in many states and provinces around the Great Lakes provided employment data.

#### **Sources**

InfoUSA®, Omaha, NE. Largest Employers Database. 2001 [www.acinet.org](http://www.acinet.org), [employers.database@infoUSA.com](mailto:employers.database@infoUSA.com).

Organization for Economic Cooperation and Development (OECD), Environment Policy Committee, Environment Directorate, Eco-Efficiency: Environment Ministerial Steering Group Report, (Paris, March 1998).

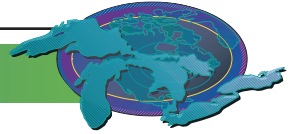
Report on Business Magazine. The TOP 1000 2002: 50 Largest Employers. <http://top1000.robmagazine.com/> July 2002. Canada.

Stratos: Strategies to Sustainability in collaboration with Alan Willis and Associates and SustainAbility. Stepping Forward: Corporate Sustainability Reporting in Canada. November 2001. Canada.

Vrooman Environmental Inc. and Legwork Environmental Inc for Industry Canada. The Status of Eco-Efficiency and Indicator Development in Canadian Industry. A Report on Industry Perceptions and Practices. February 2001.

World Business Council on Sustainable Development. Eco-efficiency: creating more value with less impact. August 2000.

World Business Council on Sustainable Development. Measuring eco-efficiency a guide to reporting company performance. June



2000.

National Round Table on Environment and Economy. Measuring eco-efficiency in business: feasibility of a core set of indicators. 1999. Ottawa, Canada.

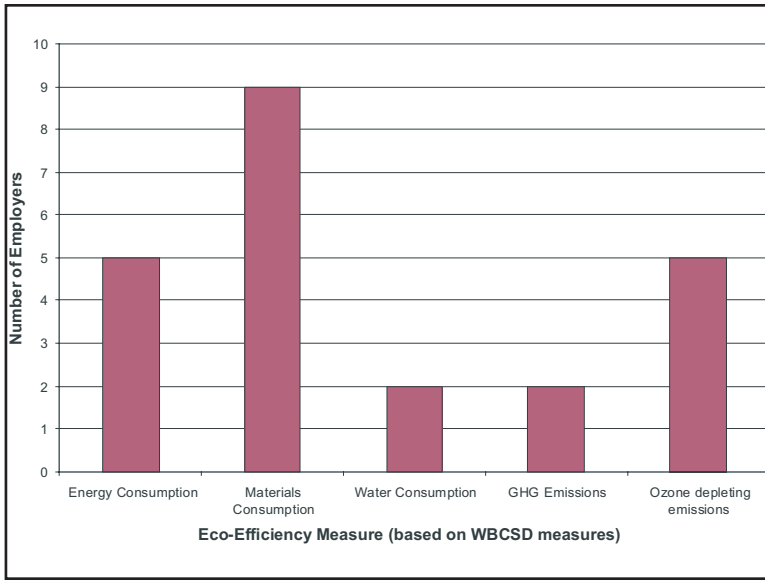


Figure 1. Number of the 25 largest employers in the Great Lakes basin that publicly report eco-efficiency measures. WBCSD = World Business Council for Sustainable Development GHG = green house gas.

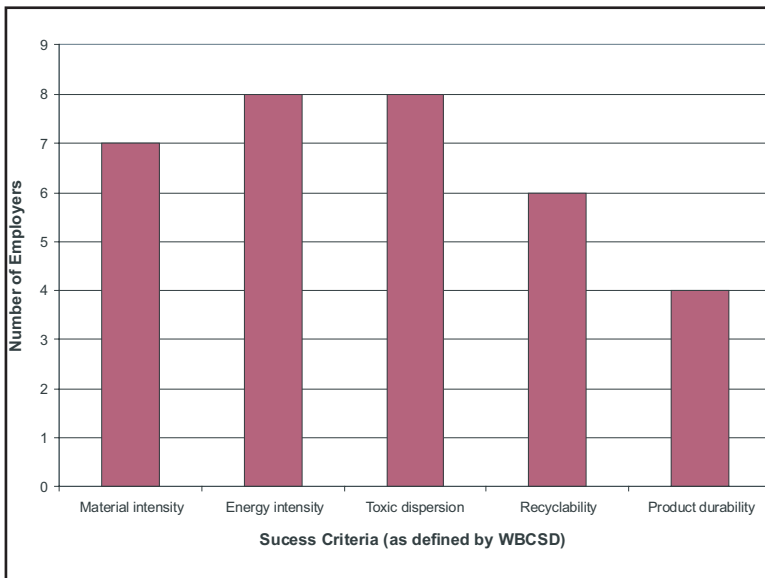
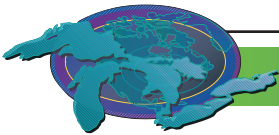


Figure 2. Number of the 25 largest employers in the Great Lakes basin that publicly report initiatives related to eco-efficiency success criteria. WBCSD - World Business Council for Sustainable Development.



## Drinking Water Quality

SOLEC Indicator #4175

**Assessment: Good, Unchanging**

### Purpose

The drinking water quality indicator was developed to evaluate the chemical and microbial contaminant levels in source water and in treated drinking water. In addition, this indicator serves to assess the potential for human exposure to drinking water contaminants and the effectiveness of policies and technologies to ensure safe drinking water. Information provided by the United States focuses mainly on finished, or treated, drinking water due to the difficulty of obtaining raw water data. In addition, finished water was chosen as the focus for U.S. reporting in order to adapt to the recommendations of the Environmental Health Indicator Project, <http://www.cdc.gov/nceh/indicators/default.htm>. Information provided by Canada focuses on both finished, or treated, and raw, or source, water. It is important to note that raw water can always affect the finished water that is consumed. Good quality raw water is an important part of a multi-barrier approach to assuring the safety and quality of drinking water.

### Ecosystem Objective

The ultimate goal of this indicator is to ensure that all drinking water provided to the residents of the Great Lakes Basin is protected at its source, and treated in such a way that it is safe to drink without reservation. As such, the treated water should be free from harmful chemical and microbiological contaminants. GLWQA Annexes 1, 2, 12, and 16 support this indicator.

### State of the Ecosystem

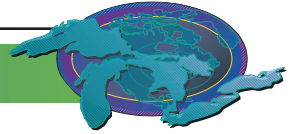
Due to the difficulty of gathering and analyzing raw water data in the U.S., finished water has been chosen as the best way to display drinking water quality in U.S. Water Treatment Plants (WTPs). Canadian information has been provided for both raw and finished water. Information gathered for this report was collected from 57 U.S. Water Treatment Plants and 74 Canadian Drinking Water Systems.

In the U.S., the Safe-Drinking Water Act Re-authorization of 1996 requires all drinking water utilities to provide water quality information to their consumers every year. To satisfy this requirement, U.S. WTPs provide an annual Consumer Confidence / Water Quality Report (CC/WQR) to their customers. The CC/WQRs include information on source water type, the water treatment process, contaminants detected in finished water, any violations, and other relevant information collected for the operational year 2002 (2003 when available) for WTPs catering to populations in the Great Lakes Basin equal to or greater than 50,000 people. Additional WTPs, catering to less than 50,000 people, were added to provide better geographic coverage. However, additional U.S. WTPs were added for geographic coverage, see GIS map (figure 1).

The U.S. based Safe Drinking Water Information System (SDWIS) was also used as a means to verify information presented in the reports and to provide any other relevant information, where consumer confidence / water quality reports were not yet available.

The data used for the Canadian side of the report were provided by the Ontario Ministry of the Environment and include results from two program areas. Data collected as part of the Drinking Water Surveillance Program (DWSP) was provided for the period 2001/2002. DWSP is a voluntary partnership program with municipalities that monitors drinking water quality. Ontario's Drinking Water Systems Regulation (O. Reg. 170/03), made under the *Safe Drinking Water Act, 2002*, requires that the owner of a drinking water system prepare an annual report on the operation of the system and the quality of its water. Drinking water systems (DWS) must provide the Ontario Ministry of the Environment (MOE) with their drinking water quality data. Data from January to June 2004, collected as part of this regulatory framework, was also provided for analysis.

There are several Great Lakes Basin sources of drinking water for tap water including lakes, rivers, streams, ponds, reservoirs, springs, and wells. Water traveling over the surface of the land or through the ground is vulnerable to contamination by naturally occurring minerals, substances resulting from animals or anthropogenic activity, and in some instances, radioactive material. Substances that may be present in the source water include: microbial contaminants, such as viruses and bacteria; inorganic contaminants, such as salts and metals; pesticides and herbicides; organic chemical contaminants, including synthetic and volatile organic chemicals; and radioactive contaminants.



Finished and raw water evaluated for this report originated from many water sources in the Great Lakes Basin including Lake Erie, Lake Huron, Lake Michigan (U.S. only), Lake Ontario, Lake Superior, rivers, small lakes/reservoirs, and groundwater. After collection, the raw water undergoes a detailed treatment process prior to being sent to the distribution system where it is then dispersed to consumer taps. The treatment process involves several basic steps, which are often varied and repeated depending on the condition of the source water.

Ten drinking water parameters were chosen to provide the best pictures of drinking water quality in the Great Lakes Basin, including several chemical parameters, microbiological parameters, and other indicators of potential health hazards. It is important to note that the majority of these parameters are no longer present in the finished water stage of the drinking water treatment process.

### **Chemical Contaminants**

Chemical contaminants of concern include atrazine, nitrate, and nitrite. These parameters can be present in raw and finished water. Exposure to these contaminants above the regulated standards has the potential to negatively effect human health.

*Atrazine* - Atrazine can enter source waters through its use as an herbicide and/or through effluents from manufacturing facilities. Consuming drinking water containing atrazine in excess of the standard can potentially lead to health complications depending on the length of exposure. The U.S. Environmental Protection Agency (EPA) set the Maximum Contaminant Level (MCL) for atrazine at 3 parts per billion (ppb) and the Ontario drinking water standards specify the Interim Maximum Acceptable Concentration (IMAC) to be 5 ppb. The Interim Maximum Acceptable Concentration is established for parameters either when there are insufficient toxicological data to establish a MAC with reasonable certainty, or when it is not feasible, for practical reasons, to establish a MAC at the desired level. These levels were established as the lowest level to which the WTPs/ DWSs could reasonably be required to remove this contaminant if it were present in drinking water given the present technology and resources.

In the U.S., atrazine rarely occurred in finished waters supplies. It was found only in finished water originating from Lake Erie, rivers, groundwater, and small lake/reservoirs. When detected, it was present at levels below the MCL. Violations of monitoring requirements were reported for one WTP that uses water from small reservoirs for failure to monitor for atrazine and other pesticides during February through most of June of 2003. However, no violations of the MCL were reported. The risk for human exposure to atrazine is low as indicated by the annual CC/WQRs.

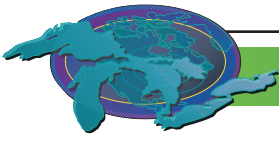
In the Ontario DWSP 2001/2002 data, the highest atrazine result detected for 134 raw water samples was .55 ppb and the highest atrazine result found in 325 DWSP treated water samples for 2001/2002 was .58 ppb, which is about one order of magnitude smaller than the IMAC for atrazine (5 ppb). Therefore, the 2001/2002 DWSP data do not show any atrazine concentration above the Ontario IMAC. In the 2004 Ontario data, atrazine was detected in both raw and treated water; however, the detections in treated water were never in amounts that exceeded the interim MAC. The 3 highest water sample results in 2001/2002 DWSP data were found in treated water samples where the raw water source is located in an agricultural watershed.

*Nitrogen* - Nitrogen is a nutrient that occurs naturally in the environment and is used in many agricultural applications. However, nitrogenous materials tend to be converted to nitrate in natural waters. Ingestion of drinking water containing nitrate exceeding the MCL or MAC can cause serious health effects, particularly to infants. The EPA has set the MCL for nitrate at 10 ppm and nitrite at 1 ppm and the province of Ontario has set the MAC for nitrate at 10 ppm and nitrite at 1 ppm.

In the U.S., nitrate was detected in finished water supplies from WTPs using all source water types and repeatedly detected in water originating from Lake Erie, Lake Ontario, Lake Superior, and small lakes/reservoirs. While it was seen as a reoccurring contaminant, it was never detected above the MCL. Therefore, while there is some risk of exposure to nitrate, it is not likely to lead to serious health complications. There were no violations of the nitrate MCL.

The Ontario data indicated that there were no observed results for nitrate in treated drinking water samples at levels above the standard at any of the reported drinking water systems.

In the U.S., nitrite was rarely detected in finished water supplies. It was found in water using Lake Erie, Lake Michigan, river, groundwater, and small lakes/reservoirs source water. As such, there is a small potential for human exposure to nitrite from drinking water. No nitrite violations were reported.



The Ontario data indicated that there were no observed results for nitrite in treated drinking water samples at levels above the standard, at any of the reported drinking water systems. In the DWSP 2001/2002 data the highest result values for 574 raw and 442 treated water samples were 0.434 ppm and 0.017 ppm respectively.

### Microbiological Parameters

Microbiological parameters evaluated include total coliform, *Escherichia coli* (*E.coli*), *Giardia*, and *Cryptosporidium*. These microbial contaminants are included as indicators for water quality and as an indication of the presence of hazardous and possibly fatal pathogens to humans. They occur predominately in raw water; however, inadequate treatment techniques or contamination post-treatment may result in their presence in finished water.

*Total Coliform* - Coliforms are a broad class of bacteria that are ubiquitous in the environment and the feces of humans and animals. The U.S. EPA has set a MCL for total coliforms in tap water that states that large WTPs that are required to take more than 40 samples/month must not find total coliforms in more than 5% of their monthly samples. Smaller WTPs required to take less than 40 samples/month must not find total coliforms in more than two of their monthly samples. Canada has set an MCL of 0 colony forming units (CFU) for DWS. Both Canada and the U.S. require additional analysis of positive total coliform samples to discern if specific types of coliform, such as fecal coliforms or *E. coli*, are present.

In the U.S., the presence of total coliform was detected in finished water from WTPs using all source water types, except Lake Superior. It was repeatedly detected in finished water from WTPs using Lake Huron, groundwater, and small lakes/reservoirs as source water. Violations of monitoring requirements of U.S. EPA's Total Coliform Rule (TCR) were reported in one WTP, for not collecting any, or not collecting enough, monthly routine samples for total coliform bacteria analysis during eight months of 2002. TCR repeat monitoring reporting violations were also reported for three other WTPs, for not collecting any, or not collecting enough, repeat samples after coliform bacteria was detected in monthly routine samples. Repeat samples must be collected at the same location as the positive total coliform bacteria sample, and at nearby locations to determine if the original positive sample indicated a localized water problem, or a sampling or testing error. There were a total of four repeat monitoring violations at these U.S. WTPs in the Basin, two in 2002 and two in 2003. While coliform bacteria were detected in the majority of finished water supplies, they were not found exceeding the MCL. Although there is potential for human exposure to total coliform, it is not likely to present a human health hazard in itself. However, the presence of coliform bacteria indicates the possibility that microbial pathogens may be present, and this can be hazardous to human health.

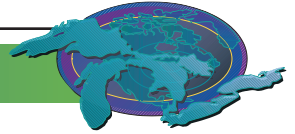
In Ontario, total coliform were detected in many of the raw water samples. The presence of total coliform was detected in treated water only on 3 occasions. It can be concluded that the treatment facilities are adequately removing the total coliform.

*Escherichia coli* (*E. coli*) – *E. coli* is a type of thermo tolerant (fecal) coliform bacteria that is generally found in the intestines of all animals, including humans. *E. coli* bacteria derived from animal and human fecal waste commonly enters source water through contaminated runoff water as a result of precipitation, among other routes of exposure. Detection of *E. coli* in water strongly indicates recent contamination of sewage or animal waste, which may contain many types of disease-causing organisms. *E. coli* bacteria may persist in drinking water after inadequate treatment. Both the U.S. and Canada require WTPs/DWSs to monitor for coliform bacteria. If monitoring tests reveal the presence of coliform bacteria, the same positive samples must be further analyzed for either fecal coliform or *E. coli*. It is mandatory for all WTPs/DWSs to inform consumers if *E. coli* is present in their drinking and/or recreational water (U.S. waters only).

In the U.S., *E. coli* was detected in a limited number of routine samples from one WTP using source water from a small lake. Despite this occurrence, there were no violations associated with this finding because, presumably, all of the total coliform repeat samples taken in response to the *E. coli* positive routine samples were negative. It was not detected in any of the other finished water supplies.

In Ontario, *E. coli* was detected in small amounts in raw water samples taken from Lake Erie, Lake Ontario, Lake Superior and Lake St. Clair. It was also detected in small amounts in other small lakes and rivers. The Detroit River and the Grand River had few occurrences of higher readings. Although *E. coli* was detected in raw water, its presence was not detected in any treated drinking water samples. Thus, it can be concluded that the treatment facilities and processes are working adequately; however, the sources of the *E. coli* in the raw water data should be investigated to determine the state of the environment.





*Giardia* and *Cryptosporidium* - *Giardia* and *Cryptosporidium* are parasites that exist in water and when ingested may cause gastrointestinal illness in humans. The presence of these microorganisms in treated water is controlled by treated water standards established by the U.S. These standards dictate that 99% of *Cryptosporidium* should be physically removed by filtration. In addition, *Giardia* must be 99.9% removed and/or inactivated by filtration and disinfection. This limit is confirmed by limits on post treatment turbidity and disinfectant residual levels. Ontario has also adopted removal/inactivation for *Giardia* and *Cryptosporidium*.

In the U.S., neither *Giardia* nor *Cryptosporidium* was detected in finished water supplies from any of the WTPs, as indicated by the CC/WQRs. However, their presences in raw water was discussed in the majority of the CC/WQRs and are reported as raw water information in 2002. The presence of these organisms in source water and not in finished water indicates that current treatment techniques are effective at removing these parasites from drinking water. Nevertheless, implementing measures to prevent or reduce microbial contamination from source waters should remain a priority. Even a well-operated WTP cannot ensure that drinking water will be completely free of *Cryptosporidium*. Furthermore, very low levels of *Cryptosporidium* may be of concern for the severely immunocompromised because exposure can compound their illness.

The annual CC/WQRs indicate that there is the potential to be exposed to the aforementioned microbiological contaminants. However, it is not likely that exposure to the contaminants from drinking water will lead to any serious health complications. Total coliform was the most common microbiological contaminant detected in finished water; however, there were no confirmed detections of the more serious contaminants including *E. coli*, *Giardia*, and *Cryptosporidium* detected in finished water (last two parameters based on U.S. data only).

#### **Treatment Technique Parameters**

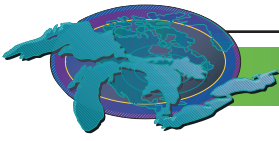
Treatment technique parameters evaluated include turbidity and total organic carbon (TOC) in the U.S. and dissolved organic carbon (DOC) in Canada. These parameters do not pose a direct health hazard but are often indicative of health hazards.

*Turbidity* – If turbidity levels in raw water are very high, it can inhibit the effectiveness of the disinfection/filtration process, conceal potentially hazardous microorganisms, and can be comprised of toxic particulate matter or that which is capable of absorbing or bonding with toxic substances. A significant relationship has been demonstrated between turbidity increases and the number of *Giardia* cysts and *Cryptosporidium* oocysts breaking through filters. In finished water, turbidity can also act as an indicator of the efficiency of the drinking water treatment process. In the U.S. with some possible exceptions, all systems using a surface water source or a Groundwater Source Under the Direct Influence (GUDI) of surface water must install filtration and disinfection treatment and meet filtration technique requirements. These requirements depend on the type of filtration treatment and the population served. For systems using conventional or direct filtration treatment serving 10,000 or more people, turbidity levels of filtered water must be less than or equal to 0.3 Nephelometric Turbidity Unit (NTU) in at least 95% of the measurements taken each month, and at no time can it exceed 1 NTU. Ontario has set the aesthetic objective for turbidity at 5.0 NTU, at which point turbidity becomes visible to the naked eye.

U.S. turbidity data was difficult to assess due to the varying formats of CC/WQRs and the way the data was presented. As such, it was difficult to assess quantitatively and compare the turbidity levels reported for finished water by each WTP. In 2002, four treatment technique violations were reported; however, it appears the violations were not related to turbidity levels that were well within the designated standards. Violations of reporting requirements were reported for two WTPs for failure to report monthly filter turbidity monitoring results for two months in 2003 at one WTP, and one month in 2003 at the other.

The aesthetic objective for turbidity in the Ontario Drinking Water Quality Standard (ODWQS) is 5.0 NTU at the point of consumption, and in DWSP 2001/2002 data, out of 385 samples, there was one treated water sample result of 7.74 NTU that exceeded the aesthetic objective. In the 2004 Ontario data, there were three instances reported where turbidity was detected, none of which surpassed 5.0 NTU. All three detections were in treated water, two from a groundwater source, and one from a canal.

*Total Organic Carbon* - Although the presence of TOC in water does not directly imply a health hazard, the organic carbon reacts with chemical disinfectants to form harmful byproducts. Removal of TOC in water is a treatment technique applicable to WTPs using conventional treatment that is amenable to TOC removal using enhanced coagulation or enhanced softening. Conventional WTPs with excess TOC in the raw water are required to remove a certain percentage of the TOC depending upon the TOC and alkalinity level of the raw water. A TOC and alkalinity analysis for these WTPs can be used to determine how much TOC the system



can reasonably remove from the raw water. The U.S. EPA does not have a MCL for TOC.

TOC was detected in finished water from WTPs using all source water types, except those using Lake Huron and Lake Superior source water. It was repeatedly detected in finished water from WTPs using Lake Erie source water. Violations of monitoring requirements were reported for two conventional WTPs for failure to collect monthly TOC and alkalinity levels in raw water and combined filter effluent during all twelve months of 2002.

*Dissolved Organic Carbon* – Dissolved organic carbon (DOC) can indicate the possibility of water deterioration during storage and distribution due to the carbon being a growth nutrient for biofilm dwelling bacteria. Biofilm is the microbial cells that attach to pipe surfaces and multiply to form a film or slime layer on the pipe which can harbor and protect coliform bacteria from disinfectants. High DOC levels also indicate the potential of chlorination by-product problems. The use of coagulant treatment or high pressure membrane treatment can be used to reduce DOC. The aesthetic objective for DOC in Ontario's drinking water is 5 ppm.

The 2001/2002 data for Ontario had one DOC violation out of 442 samples in treated water. The violation in the treated water sample had a value of 9.3mg/L and was from a small lake. There were only two occurrences of DOC reported in Ontario for January through June 2004. Both occurrences were in treated drinking water, but did not exceed the aesthetic objective. The largest concentration of the two was 4.5 ppm from a small lake.

#### **Taste and Odor**

While taste and odor do not necessarily reflect any health hazards, these water characteristics affect the consumer perception of the drinking water quality.

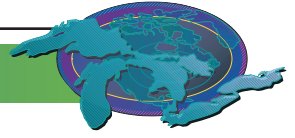
In the U.S., several complaints of bad taste and odor were recorded during the summer months. This was attributed to natural compounds released by benthic algae, which cause a distinct taste and odor during the warmer months. There were also complaints of chlorine taste and odor from customers of WTPs using Lake Michigan source water.

The quality of finished drinking water and raw water in the Great Lakes Basin is good based on the information provided by the annual CC/WQRs and the Ontario annual reports from the DWSs. These reports can be utilized to evaluate the efficiency of current treatment technologies. The information provided demonstrates that WTPs/DWSs are employing treatment technologies that are successfully treating water thus enabling them to provide quality drinking water. Few, if any, violations of federally regulated MCLs, MACs, or treatment techniques occurred. Other violations are also infrequent, supporting the claim that drinking water quality is good. The risk of human exposure to the noted chemical and/or microbiological contaminants is generally low. Therefore, the potential for humans to develop serious health complications as a result of consuming drinking water containing these contaminants from the Great Lakes Basin is also low.

#### **Pressures**

Previous SOLEC reports evaluated drinking water contaminants in raw water based upon their potential human health hazard. Although the majority of these contaminants are removed during the treatment process and therefore do not pose a human health hazard, the analysis and reporting of contaminants in raw water is still useful. In the event of a WTP failure, a storm water event, or a cut in funding, it is possible that raw water would not be treated properly before entering distribution systems. Therefore, it is important to maintain the quality of raw water. Contaminants in raw water are indicative of the potential human exposure, and the degree to which water must be treated to remove the contaminants. It is further indicative of the level of pollutant input to the region's potable water supply.

The greatest pressures come from degraded runoff. Reduced quality of runoff may be caused by a number of reasons, including the increasing rate of industrial development on or near water bodies, low-density urban sprawl, and agriculture, including both crop and livestock operations. In addition, point source pollution, such as that from wastewater treatment plants, also can contribute to contamination of raw water. It is unknown to what extent new pressures, such as newly introduced chemicals and invasive species, will impact water quality. If these problems persist, microbiological and chemical contaminants, in addition to disinfection byproducts, could pose a health risk.



### Management Implications

A more standardized approach to reporting the status of drinking water in the Great Lakes Basin needs to be created in the United States. Issues such as evaluation of raw vs. finished water, the size of WTPs/DWSs included in analysis, and standardized reporting formats need to be decided upon in order to best assess the potential human health hazard from drinking water. It is difficult to establish trend analysis of drinking water based upon CC/WQRs, as each report is issued in a different format and includes different information. A database containing all relevant information, accessible to all WTPs/DWSs, researchers, and the public, would aid in this process.

While the evaluation of finished water is important in order to protect human health, it is also vital to maintain the quality of raw water. Even a well-operated WTP cannot ensure that drinking water will be completely free of *Cryptosporidium*. For example, the detection of *Cryptosporidium* in finished water may be underestimated as analytical methods for *Cryptosporidium* have accuracy and reliability limitations.

The scattered geographical coverage provided by focusing on WTPs serving a population of 50,000 or greater in the U.S. provides a fragmented view of the drinking water patterns in the Great Lakes Basin. However, sporadically including additional WTPs to expand geographic coverage may introduce bias. In Ontario, the data for all DWSs serving a population of 10,000 or greater was analyzed. Future efforts should adhere to clear guidelines when identifying usable data, such that the information provided offers adequate geographical coverage and sufficient data.

While there are many precautions exercised to ensure quality finished water, contamination is also possible during the distribution stage and even as it travels through personal plumbing systems. For example, many WTPs/DWSs are engaging in actions to prevent corrosion of copper or lead from home and business plumbing pipes into water supplies and to limit bacterial growth. Continued sampling in the distribution stage, in combination with effective treatment to prevent future contamination at the finished water stage will continue to ensure quality drinking water at the consumer tap.

### Future Activities

Quality drinking water is an invaluable resource, one that should not be taken for granted. It is apparent from the annual CC/WQRs that the U.S. states in the Great Lakes Basin have been active in conducting source water assessments. Ontario is also developing source water protection measures. In many cases, assessment results were used to develop or initiate development of source water protection measures. WTP/DWS intake and other source water monitoring data is needed to help determine if source waters are meeting applicable water quality standards for drinking water and attaining their designated use as sources of drinking water as well as the need for and measuring the success of source water protection efforts.

Our scientific knowledge lags behind the true presence of pathogens and chemicals in our environment. As such, one must take a conservative approach in conclusions regarding risk and safety. Additional research is needed on emerging contaminants and pathogens.

### Acknowledgements

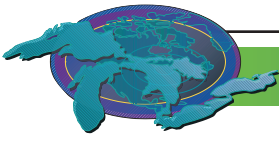
Authors: Christyanne Melendez, U.S. Environmental Protection Agency, Great Lakes National Program Office, Chicago, IL; Elizabeth Murphy, U.S. Environmental Protection Agency, Great Lakes National Program Office, Chicago, IL; Lindsay Silk, Environment Canada, Downsview, ON

Reviewers: Thomas Murphy, Kimberly Harris and William Spalding, U.S. Environmental Protection Agency, Groundwater and Drinking Water Branch; Environmental Monitoring and Reporting Branch, Ontario Ministry of the Environment; Standards Development Branch, Ontario Ministry of the Environment

### Sources

Guillarte, Angelica and Makdisi, Mike. 2003. *Implementing Indicators 2003, A Technical Report*. pp. 92-96.

Jarvis, Linda. 2004. Personal Communication. *Ontario Reg 170/03 Drinking Water Data (Jan-Jun 2004)*, Drinking Water Program Management Branch, Drinking Water Management Division, Ontario Ministry of the Environment.



Ministry of the Environment. 2003. *Technical Support Document for Ontario Drinking Water: Standards, Objectives and Guidelines*.

Sharifi, Mojan. 2004. Personal Communication. Ontario 2001/2002 Drinking Water Surveillance Program (DWSP) Data, Environmental Monitoring and Reporting Branch, Environmental Sciences and Standards Division, Ontario Ministry of the Environment.

### **Consumer Confidence Reports**

Akron Public Utilities Bureau Akron Metropolitan Service Area – Annual Drinking Water Quality Report for 2002

Alpena Water Treatment Plant – 2002 Annual Water Quality Report

Alpena Water Treatment Plant – 2003 Annual Water Quality Report

Ashland Water Utility – 2003 Consumer Confidence Report

Buffalo Water Authority – Annual Drinking Water Quality Report for 2003

City of Ann Arbor Water Utilities – 2002 Annual Report on Drinking Water

City of Ann Arbor Water Utilities – 2003 Annual Report on Drinking Water

City of Battle Creek Public Works – Water and Wastewater – 2002 Water Quality Report

City of Cleveland – 2002 Cleveland Water Quality Report

City of Duluth Public Works and Utilities Department – Duluth Water During 2002

City of Evanston – 2002 Water Quality Report

City of Evanston – 2003 Water Quality Report

City of Kenosha – 2002 Annual Drinking Water Report

City of Manistique – 2002 Water-Quality Report

City of Manistique – 2003 Water-Quality Report

City of Muskegon Water Filtration Plant (WFP) – 2002 Annual Water Quality Report

City of Muskegon Water Filtration Plant (WFP) – 2003 Annual Water Quality Report

City of Rochester – 2002 Water Quality Report

City of Sheboygan Water Utility – Sheboygan Water Utility Annual Report, Summer 2003

City of St. Ignace – 2002 Water Quality Report

City of Syracuse, Department of Water – Annual Drinking Water Quality Report for 2003

City of Toledo – Drinking Water Quality Report for 2002

City of Waukegan - Waukegan Water Quality Report – 2002

City of Wyoming – 2002 Water Quality Report

Consumers Ohio Water-Company (COWC) – 2002 Water Quality Report (lake shore Division)

Consumers Ohio Water-Company (COWC) – 2002 Water Quality Report (Stark Regional Division)

Consumers Ohio Water-Company (COWC) – 2002 Water Quality Report (Suburban Division)

Department of Utilities Appleton Water Treatment Facility – 2002 Annual Water Quality Report

Detroit Water and Sewerage Department – Water Quality Report 2002

East Lansing-Meridian Water and Sewer Authority – Consumer Confidence Report for 2002

Elyria Water Department – 2002 Annual Water Quality Report

Erie County Water Authority – 2002 Water Quality Report

Erie Water Works (EWW) – Water Quality Report for Year 2002

Fort Wayne City Utilities – 2003 Annual Drinking Water Quality Report

Grand Rapids Water System – 2002 Water Quality Report

Green Bay Water Utility – 2003 Annual Drinking Water Quality Report

Hammond Water Works Department – 2002 Annual Drinking Water Quality Report

Indiana-American Water Company, Inc. (Northwest Operations) – 2002 Annual Water Quality Report

Indiana-American Water Company, Inc. (Northwest Operations) – 2003 Annual Water Quality Report

Lake County Department of Utilities Division of Water – Water Quality Report 2002

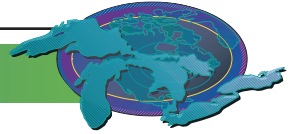
Lansing Board of Water & Light – 2002 Annual Water Quality Report

Lima Water Treatment Plant – 2002 Drinking Water Consumer Confidence Report

Lorain Water Purification Plant – Annual Water Quality Report for 2002

Lorain Water Purification Plant – Annual Water Quality Report for 2003

Michael C. O’Laughlin Municipal Water Plant – Annual Drinking Water Quality Report for 2002



Milwaukee Water Works – 2002 Water Quality Report  
Milwaukee Water Works – 2003 Water Quality Report  
Monroe County Water Authority – 2002 Annual Water Quality Report  
Onondaga County Water Authority (OCWA) – 2002 Consumer Confidence Report & Annual Water Supply Statement  
Oshkosh Water Utility – 2002 Consumer Confidence Report  
Oshkosh Water Utility – 2003 Consumer Confidence Report  
Port Huron Water Treatment Plant – 2002 Annual Drinking Water Quality Report  
Racine Water Utility – Annual Water System Report for 2002  
Saginaw Water Treatment Plant – Annual Drinking Water Quality Report for 2002  
South Bend Water Works – Water Quality Report 2002  
The City of Chicago – Water Quality Report 2002  
Town of Tonawanda Water System – Annual Drinking Water Quality Report for 2003  
Waterford Township – 2003 Water Quality Report

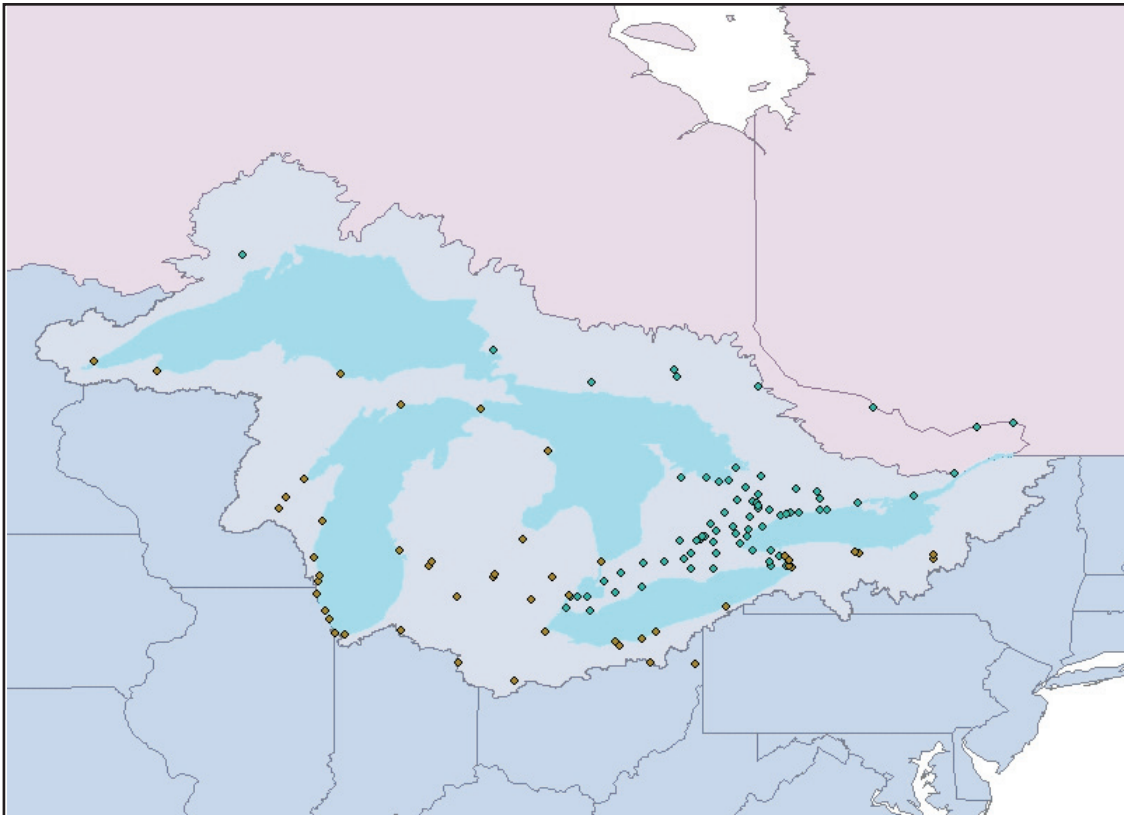
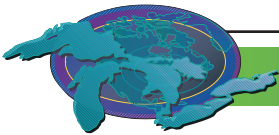


Figure 1. Analysis for 2004 SOLEC report based upon 57 Water Treatment Plants (U.S.) and 74 Drinking Water Systems (Canada).



## Biologic Markers of Human Exposure to Persistent Chemicals

SOLEC Indicator #4177

*This indicator has had a title change.*

**Assessment: Mixed, Undetermined**

### Purpose

To assess the levels of harmful toxicants such as methyl mercury, polychlorinated biphenyls (PCBs), and dichlorodiphenyl dichloroethenes (DDEs) in the human tissue of citizens of the Great Lakes Basin. Levels of persistent bioaccumulating toxic chemicals are gathered from hair and blood samples as biomarkers to measure human exposure. Evaluation of biological markers can be used as a way to infer the efficacy of policies and technology to reduce these persistent bioaccumulating toxic chemicals in the Great Lakes ecosystem.

### Ecosystem Objective

Citizens of the Great Lakes Basin should be safe from exposure to harmful bioaccumulating toxic chemicals found in the environment. Data on the status and trends of these chemicals should be gathered to help understand how human health is affected by multimedia exposure and the interactive effects of toxic substances. Collection of such data supports the requirement of the Great Lakes Water Quality Agreement Annex 1 (Specific Objectives), Annex 12 (Persistent Toxic Substances), and Annex 17 (Research and Development).

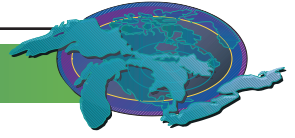
### State of the Ecosystem

Data presented for this indicator are solely based upon one biomonitoring study, Wisconsin Department of Public Health (WiDPH), conducted in the Basin. However, information on previous biomonitoring studies has been collected and is highlighted as a way to support the results of the WiDPH study and to illustrate previous and other ongoing efforts.

A recent study conducted by the Wisconsin Department of Public Health (WiDPH) analyzed the level of bioaccumulating toxic chemicals found in sensitive populations, women of childbearing age between 18 – 45 years of age, in the Great Lakes Basin. Samples were collected from women who used 3 different Women Infant and Child (WIC) clinics located along Lakes Michigan and Lake Superior. WIC clinics were chosen for sample collection due to the fact that approximately 40% of pregnant women are served by the clinics and WIC women represent a racially diverse sample overall. Three toxic chemicals, polychlorinated biphenyls (PCBs), DDEs, and methyl mercury were chosen as biomarkers due to their adverse effects upon human reproduction and infant development. The methodology used hair and blood samples as biomarkers to measure human exposure to environmental contaminants through sample collection and survey response. Contaminant levels measured were mercury, PCBs, and DDEs in blood samples and levels of mercury in hair. Knowledge of fish consumption and awareness of fish advisories was assessed in the survey.

Two versions of the survey were issued in order to achieve the most reliable information from participants. It was discovered that the first version (WIC 1) of the survey contained ambiguous questions and the reliability of the answers was questioned. A second version (WIC 2) was drafted and conclusions were gathered from that information. The wording of the questions in both surveys did not seem to influence whether a response was given. The answers for the fish consumption questions in WIC 2 survey provided more dependable data than the answers in WIC 1 survey. In WIC 1 survey, the respondents were asked about their total fish consumption (excluding shellfish) but the value of this question was limited because the total of the individual fish consumption answers often didn't match the total fish consumption answer. The survey showed that there was a greater awareness of fish consumption advisories in households where fishing occurred, see figure 1, and that there was greater awareness of advisories from individuals with at least a highschool education, figure 2. The survey also shows that the greatest awareness occurred in the 36-45 age category (figure 3), however, it is important to note that there was less than 50% awareness in all three cases. It appears that the greatest awareness of fish advisories occurred in Asians followed by those who identified themselves as white and that Hispanics had the least knowledge of fish consumption advisories, figure 4.

Biomarkers were collected through a voluntary basis from women using WIC clinics. Hair samples were easily obtained from the women during their appointments at the WIC clinics. The WIC staff was instructed in collecting hair samples and samples were sent to DPH via postal mail. Women were offered bath and body lotion and diapers for their participation and clinics were remunerated



for their recruitment efforts. Analysis was performed at the Wisconsin State Laboratory of Hygiene (WSLH). Sixty-five hair samples were analyzed for mercury levels. It appears that there is a correlation between hair mercury levels and the number of fish meals consumed over three months, see table 1. Obtaining blood samples, however, presented a challenge. Few women indicated on their completed survey that they were interested in having their blood drawn. Those who initially agreed either changed their minds or were difficult to contact. Telephone numbers and address indicated on their surveys were often no longer current. WIC clinics involved did not have a phlebotomist on staff and it was not efficient for DPH staff to drive to the clinics to draw blood. Also analysis for PCBs and DDEs was cost prohibitive. Cost per sample is \$800/sample. Five samples were drawn and analyzed for PCBs, DDEs and mercury levels. (See Table 2)

#### EAGLE Project (Effects on Aboriginals of the Great Lakes)

A similar study was conducted by a partnership between the Assembly of First Nations, Health Canada and First Nations in the Great Lakes basin between 1990 and 2000 to examine the effects of contaminants on the health of the Great Lakes Aboriginal population. The Contaminants in Human Tissues Program (CHT), a major component of the EAGLE Project, identified three main goals:

- To determine the levels of environmental contaminants in the tissues of First Nations people in the Great Lakes Basin;
- To correlate these levels with freshwater fish and wild game consumption; and
- To provide information and advice to First Nations people on the levels of environmental contaminants found in their tissues.

The EAGLE project also focused on the collection of blood serum and hair samples to analyze for levels of mercury in hair and PCBs and DDEs in serum in addition to a survey to identify frequency of fish consumption. However, the EAGLE project analyzed both male and female voluntary participants from 26 First Nations in the Great Lakes basin and the survey collected consumption information on both freshwater fish and wild game species. It should be noted that the results from the CHT sampling program are not necessarily representative of the Aboriginal populations under study, as participants were voluntary, and therefore were not selected on a random basis. This program was open to any resident and therefore did not specifically target only fish eaters.

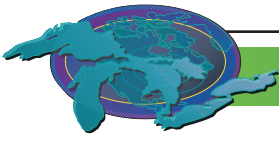
The survey identified that males consumed more fish than females and linked this pattern to the increased contaminant levels found in male participants. No significant relationship was found between total fish consumption or total wild game consumption and the contaminants included in the analysis. The results of mercury levels in hair participants in the EAGLE Project were within the range mean levels observed in Aboriginal and non-Aboriginal populations in the Great Lakes Basin and suggest that levels of mercury in hair from First Nations People in the Canadian Great Lakes Basin have decreased since 1970. The serum collection analysis identified PCBs and DDE as the most frequently appearing contaminants in the samples and identified a pattern of increased age and increased contaminant concentration. It was observed that mean levels of PCBs reported in the EAGLE CHT program were lower than or within the similar range of fish eaters in other Canadian Health studies (Great Lakes, Lake Michigan, and St. Lawrence). A possible explanation is that other Canadian Health studies targeted only freshwater fish eaters. Levels of DDE were determined to be similar to levels found in other Canadian Health Studies and that there was little difference between mean serum contaminant levels of DDE in male and female participants.

A comparison of the EAGLE Project's results with Health Canada's guidelines for PCBs in serum and mercury in hair at that time suggested that most people have levels that were within the guidelines. The results of the contaminant levels reported for this study were found to be below or within the range of other Canadian Health Studies completed in the Great Lakes basin in North America that are considered to pose a threat to human health.

#### ATSDR - Great Lakes Human Health Effects Research Program

The Agency for Toxic Substances and Disease Registry (ATSDR) and the Environmental Protection Agency (EPA) established the Great Lakes Human Health Effects Research Program through legislative mandate in September 1992 to "assess the adverse effects of water pollutants in the Great Lakes system on the health of persons in the Great Lakes States" (ATSDR, <http://www.atsdr.cdc.gov/grtlakes/historical-background.html>). This program is tasked with assessing critical pollutants of concern, identifying vulnerable and sensitive populations, prioritizing areas of research, and funding research projects. Several of the most recent Great Lakes biomonitoring research funded by ATSDR is listed below.

Data collected from 1980 to 1995 from Great Lakes sport fish eaters showed a decline in serum polychlorinated biphenyl levels from a mean of 24 parts per billion (ppb) in 1980 to 12 ppb in 1995. This decline was associated with an 83% decrease in the number of fish meals consumed (Tee PG et al, 2003).



2716 infants born between 1986 and 1991 to participants of the New York State Angler Cohort Study were studied with respect to duration of maternal consumption of contaminated fish and potential effects on gestational age and birth size. The data indicated no significant difference in gestational age or birth size in these infants from their mother's lifetime consumption of fish. The researchers noted that biological determinants such as parity, and placental infarction and maternal smoking were significant determinants of birth size (Buck et al. 2003).

The relationship between prenatal exposure to PCBs and methylmercury (MeHg) and performance on the McCarthy Scales of Children's Abilities was assessed in 212 children. Negative associations between prenatal MeHg exposure and McCarthy performance were found in subjects with higher levels of prenatal PCB exposure at 38 months. However, no relationship between PCBs and MeHg and McCarthy performance was observed when the children were reassessed at 54 months. These results partially replicated the findings of other and suggest that functional recovery of others and suggest that functional recovery may occur. The researchers concluded that the interaction between PCBs and MeHg can not be considered conclusive until it has been replicated in subsequent investigations (Steward et al. 2003a).

Response inhibition in preschool children exposed parentally to PCBs may be due to incomplete development of their nervous system. One hundred and eighty-nine children in the Oswego study were tested using a continuous performance test. The researchers measured the splenium of the corpus callosum, a pathway implicated in the regulations of response inhibition, in these children by magnetic resonance imaging. The results indicated the smaller of the splenium, the larger the association between PCBs and the increased number of errors the children made on the continuous performance test. The researchers suggest if the association between PCBs and response inhibition is indeed causal, then children with suboptimal development of the splenium may be particularly vulnerable to these effects (Stewart et al. 2003b).

In the future, ATSDR's Great Lakes Human Health Effects Research Program plans to continue to provide research findings to public health officials to improve their ability to assess and evaluate chemical exposure in vulnerable populations. ATSDR also plans to focus on research priorities of children's health, endocrine disruptors, mixtures, surveillance, and identification of biomarkers, i.e., exposure, effect, and susceptibility. In addition, the program will use established cohorts to monitor changes in body burdens of persistent toxic substances and specified health outcomes, and develop and evaluate new health promotion strategies and risk communication tools.

### **Pressures**

Emerging contaminants, such as certain brominated flame-retardants, are increasing in the environment and may have negative health impacts. According to a recent study conducted by Environment Canada, worldwide exposure to PBDEs (penta) is highest in North America with lesser amounts in Europe and Asia. Food consumption is a significant vector for PBDE exposure in addition to other sources. The survey analyzed PBDE concentration in human milk by region in Canada in 1992 and in 2002 and showed a ten-fold increase in concentration in Ontario (Ryan, 2004).

The health effects of contaminants such as endocrine disruptors are somewhat understood. However, there is little known about the synergistic or additive effects of bioaccumulating toxic chemicals. Screening of a larger suite of chemicals needs to be completed with special attention paid to how bioaccumulating toxic chemicals work in concert.

### **Management Implications**

There have been many small-scale studies regarding human biomarkers and bioaccumulating toxic chemicals. However, to this date, there have been no large scale or Basin wide studies that can provide a larger picture of the issues facing the citizens of the Basin. It is important that those in management positions in Federal, State, and Tribal governments and Universities to foster cooperation and work together to identify gaps in existing biomonitoring data and work to implement larger, basin wide monitoring efforts. In addition, a Great Lakes environmental health tracking program, similar to the CDC Environmental Health Tracking Program, needs to be established by key Great Lakes Partners; Universities, Federal, State, and Tribal governments, in order to identify the most pressing health issues in the Basin.

### **Further Work Necessary**

A region specific biomonitoring program, similar to the CDC's NHANES project could provide needed biomonitoring information and fill in data gaps.

It is important that additional studies assessing the levels of bioaccumulative toxic chemicals through biomarkers be conducted on a





much larger scale throughout the basin. In order to build up on the WIC study it would be important for a question about fish consumption from restaurants be included in future surveys. Because all states have WIC clinics, or something similar, the WiDPH monitoring tool could be implemented basin wide.

Bring together the key Great Lakes Partners; Universities, Federal, State, and Tribal governments, to identify and prioritized health needs, identify data gaps, and foster cooperation and collaboration to address biomonitoring issues in the basin.

#### **Acknowledgments**

Authors: Elizabeth Murphy, U.S. EPA Great Lakes National Program Office  
Jacqueline Fisher, U.S. EPA Great Lakes National Program Office  
Henry A. Anderson, Wisconsin Department of Health and Family Services  
Dyan Steenport, Wisconsin Division of Public Health  
Kate Cave, Environment Canada  
Heraline E. Hicks, Agency for Toxic Substance and Disease Registry

#### **Sources**

Anderson, Henry A. *SOLEC Health Indicator Refinement and Implementation Progress Report*. Wisconsin Department of Health and Family Services. March, 22, 2004.

Buck GM, Grace PT, Fitzgerald EF, Vena JE, Weiner JM, Swanson M, and Msall, ME. 2003. Maternal fish consumption and infant birth size and gestation: New York state angler cohort study. *Environ Health* 2: 7-15.

Davies K., Phil D. EAGLE Project: Contaminants in Human Tissue. Health Canada, Ottawa, May, 2001.

Ryan, John Jake. Health Products and Food Branch, Health Canada. June 7, 2004. "Polybrominated Diphenyl Ethers (PBDEs) in Human Milk; Occurrence Worldwide". Prepared for the 2004 BFR conference. Toronto, Canada.

Stewart PW, Reihman J, Lonky EI, Daravill TJ and Pango J. 2003a. Cognitive development in preschool children parentally exposed to PCBs and MeHg. *Neurotoxicol Teratol* 25: 11-22.

Stewart PW, Fitzgerald S, Reihman J, Gump B, Lonky E, Darvill, Pagano J, and Hauser P. 2003b. Prenatal PCB exposure, the corpus callosum, and response inhibition. *Environ Health Perspect* 111: 1670-1677.

Tee PG, Sweeney AM, Symanski E, Gardiner JC, Gasior DM, and Schantz, S. 2003. A longitudinal examination of factors related to changes in serum polychlorinated biphenyl levels. *Environ Health Perspect* 111(5): 720-707.



Fish meals/3 months Sport-caught (Y/N)	Min (UG/G)	Ave (UG/G)	Max (UG/G)	N	Ave no. fish meals
0	0.00	0.07	0.24	14	0
1-9 (N)	0.04	0.16	0.59	28	2.3
1-9 (Y)	0.03	0.30	0.99	7	2.4
10+ (N)	0.04	0.33	1.23	7	12.8
10+ (Y)	0.09	0.38	1.53	9	8.11

Table 1: Hair mercury results versus number of fish meals consumed in previous three months.

ID	Fish Meals	PCB	DDE	Mercury
100 Sheb	Commercial = 1/week Sport Caught = none	0.0	0.34	<5 mcg/L
100 Sup	Commercial = 5/month Sport Caught = 30/year	0.0	0.40	<5 mcg/L
100A GB	Commercial = <6/Year Sport Caught = 6-12/Year	0.0	0.25	<5 mcg/L
105 GB	Commercial = 1/week Sport Caught = 1/week	0.4	1.20	<5 mcg/L
101A GB	Commercial = 4/month Sport Caught = 2/month	0.0	0.49	<5 mcg/L

Table 2: Serum PCB, DDE and mercury results versus number of meals consumed.

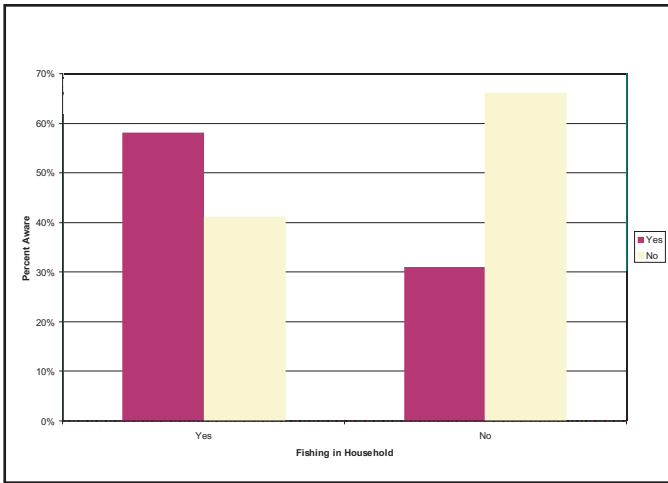
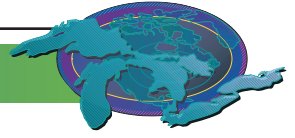


Figure 1. Awareness by Fishing - Second Survey

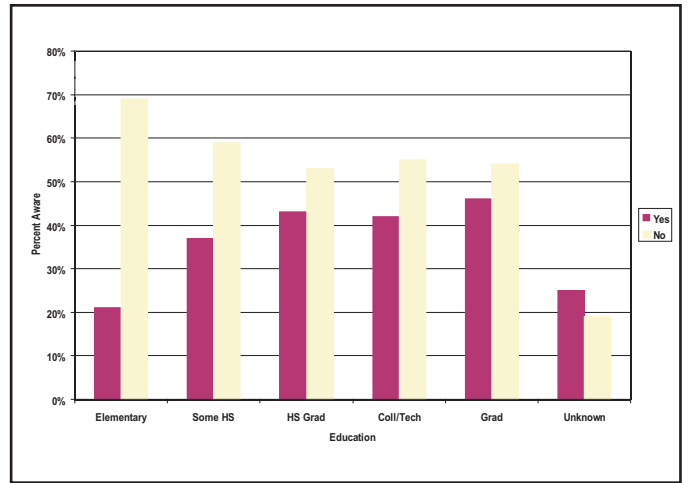


Figure 2. Awareness by Education - Second Survey

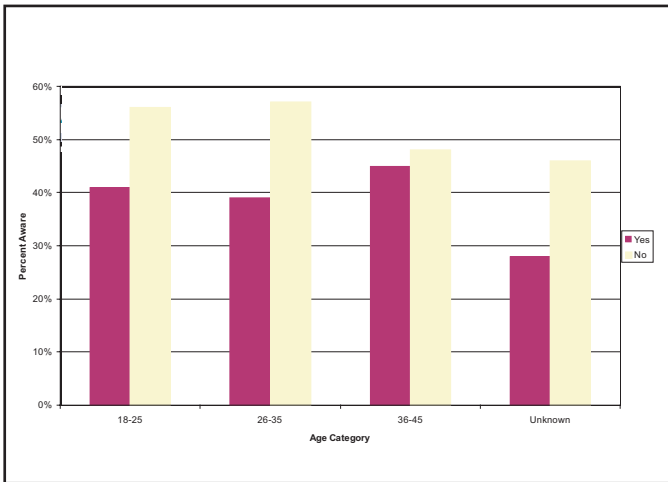


Figure 3. Awareness by Age - Second Survey

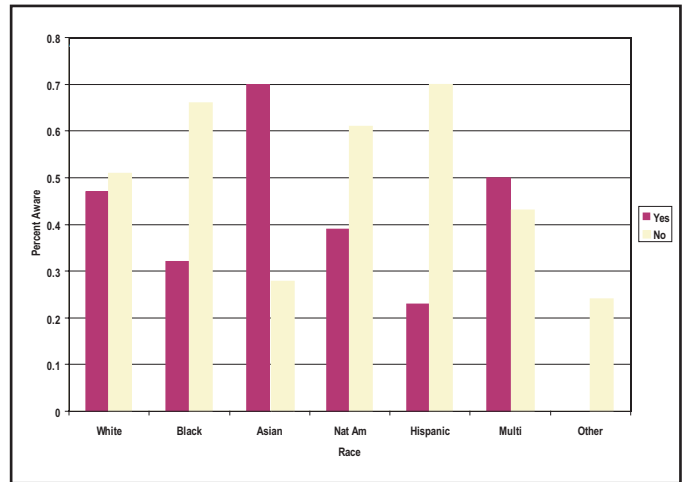
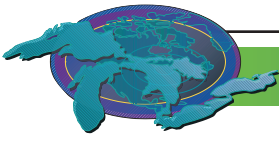


Figure 4 - Awareness by Race - Second Survey



## Beach Advisories, Postings and Closures

SOLEC Indicator # 4200

### Assessment: Mixed Undetermined

Data are not system-wide and multiple data sources are not consistent.

### Purpose

The purpose of this indicator is to assess the number of health-related swimming advisory, beach closures and posting days for freshwater recreational areas (beaches) in the Great Lakes Basin. A health-related advisory, closure day or posting day is one that is based upon elevated levels of *E. coli*, or other indicator organisms, as reported by county or municipal health departments in the Great Lakes Basin. *E. coli*, or other indicator organisms, are measured in order to infer potential harm to human health through body contact with nearshore recreational waters because they act as indicators for potential pathogens.

### Ecosystem Objective

Waters used for recreational activities involving body contact should be substantially free from pathogens, including bacteria, parasites, and viruses, that may harm human health. As the surrogate indicator, *E. coli* levels should not exceed national, state, and/or provincial standards set for recreational waters. The Ontario provincial standard is a maximum count of 100 *E. coli* per 100 mL, based on the geometric mean of a minimum of one sample per week from each sampling site (minimum of 5 sampling sites per beach) (Ministry of Health, 1998). It is recommended by the Ontario Ministry of Health and Long Term Care that beaches of 1000 metres or greater require one sampling site per 200 metres. In some cases local Health Units in Ontario have implemented a more frequent sampling procedure than is outlined by the provincial government. When *E. coli* levels exceed the limit, the beach is posted as unsafe for the health of bathers.

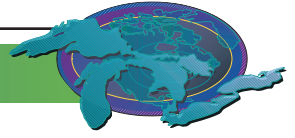
US EPA's bacteria criteria recommendations for *E. coli* are a geometric mean of 126 colony forming units per 100 mL, based on a statistically sufficient number of samples (not less than 5 over 30 days), or a single sample maximum value of 235/100. For enterococci, US EPA's recommendations are a geometric mean of 33/100 ml or a single sample maximum value of 62/100 ml (US EPA, 1986). When levels of these indicator organisms exceed water quality standards, swimming at beaches is closed, advisories are issued, or postings are displayed to inform swimmers. This indicator supports Annexes 1, 2 and 13 of the Great Lakes Water Quality Agreement (GLWQA).

### State of the Ecosystem

One of the most important factors in nearshore recreational water quality is that indicator bacterial counts are at a level that is safe for bathers. Recreational waters may become contaminated with animal and human feces from sources and conditions such as combined sewer overflows (CSOs) and Sanitary Sewer Overflows (SSOs), malfunctioning septic systems, and poor livestock management practices. This pollutant input can become further emphasized in certain areas after heavy rains. The trends provided by this indicator will aid in beach management and in the prediction of episodes of poor water quality. In addition, states, provinces, and municipalities are continuing to identify point and non-point sources of pollution at their beaches, which will determine why beach areas are becoming impaired. As some sources of contamination are identified, improved remediation measures can be taken to reduce the number of closings, postings and advisories at beaches.

Trends: Figure 1 shows that in the U.S. and Canada, as the frequency in monitoring and reporting increases, more advisories, postings and closures are also observed, especially after 1999. In fact, both countries experienced an approximate percentage doubling of beaches that had advisories, closings, or postings for more than 10% of the season in 2000 due to increases in monitoring and reporting. The number of US beaches being included in the monitoring and reporting program in 2003 has expanded significantly (more than double since 2001) due to funding from the BEACH Act of 2000, however, the percentage of US beaches open all season and the percentage of beaches closed more than 10% of the season in 2003 are virtually unchanged when compared to 2000-2002. While the number of beaches reported in 2002 and 2003 in Canada decreased, there was a large increase in the number of beaches that posted advisories due to *E. coli*.

Further analysis of the data may show seasonal and local trends in recreational water quality. It has been observed in the Great Lakes basin that unless contaminant sources are removed or new ones introduced, beach sample results tend to show similar bacteria levels after events with similar meteorological conditions (primarily wind direction and volume and duration of rainfall). If episodes



of poor recreational water quality can be associated with specific events (such as metrological events of a certain threshold), then forecasting for episodes of elevated bacterial counts may become more accurate.

### Pressures

**Future pressures:** There may be new indicators and new detection methods available in the near future through current research efforts occurring binationally in both public and private sectors, and academia. Although currently a concern in recreational waters, viruses and parasites are difficult to isolate and quantify, and feasible measurement techniques have yet to be developed. Comparisons of the frequency of beach closings, advisories, or postings are typically limited due to use of different water quality criteria in different localities. In the U.S., all coastal states will have criteria as protective as EPA's recommended bacteria criteria (use of *E. coli* or enterococci indicators) applied at their coastal waters by 2005. Conditions required to post Ontario beaches as unsafe have become more standardized due to the 1998 Beach Management Protocol, but the conditions required to remove the postings remain variable.

**Current pressures:** Additional point and non-point source pollution at coastal areas due to population growth and increased land use may result in additional beach closings or postings and advisories, particularly during wet weather conditions. In addition, due to the nature of the lab analysis, each set of beach water samples requires an average of 1 to 2 days before the results are communicated to the health unit beach manager. Therefore, a lag time in posting or beach closures exists in addition to the lifting of any restrictions from the beach when safe levels are again reached. The inability to develop a rapid test protocol for *E. coli* is lending support to advanced models to predict when to post beach closures.

### Management Implications

In the United States, the BEACH Act will be up for reauthorization in 2005. Continued BEACH Act funding for beach monitoring and notification programs should be encouraged as well as funding for beach water contaminant source identification and remediation, rapid test methods research, and development of predictive models.

In Canada, a partnership between Environment Canada (Ontario Region) and the Ontario Ministry of Health and Long Term Care have created the Seasonal Water Monitoring and Reporting System (SWMRS). This web-based application will provide local Health Units with a tool to manage beach sampling data, as well as link to Metrological data archives of Environment Canada. The result will be a system that potentially can be evolved to have some predictive modeling capability.

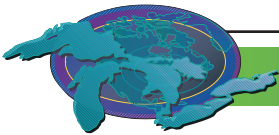
### Future Work Necessary

Wet weather sources of pollution have the potential to carry pathogenic organisms to waters used for recreation and contaminate them beyond the point of safe use. There is a need to begin identifying beach water contamination sources and implement remediation measures to reduce contaminant loading. USEPA intends to provide administrative, technical and financial support to state and local agencies to assist in the identification and remediation of pollution sources at frequently used beaches that are affected by CSOs, SSOs, and storm water runoff.

Many municipalities are in the process of developing long-term control plans that evaluate CSO control alternatives and result in the selection of CSO controls that will provide for the attainment of water quality standards. The City of Toronto has an advanced Wet Weather Flow Master Plan, which could serve as a model to other urban areas. Information on this initiative can be obtained at: <http://www.city.toronto.on.ca/wes/techservices/involved/www/wwfmmp/index.htm>

The Great Lakes Strategy 2002 (<http://www.epa.gov/glnpo/gls/index.html>) envisions that all Great Lakes beaches will be swimmable and sets a goal that by 2010, 90% of monitored, high priority Great Lakes beaches will meet bacteria standards more than 95% of the swimming season. To help meet this goal, USEPA will build local capacity in monitoring, assessment and information dissemination to help beach managers and public health officials comply with U.S. EPA's National Beach Guidance (U.S. EPA July, 2002) at 95% of high priority coastal beaches.

Environment Canada (Ontario Region) in conjunction with the Ontario Ministry of Health and Long Term Care and other potential partners will work to implement the SWMRS reporting system. Future work will include evolving the system with the predictive modeling capability as well as improving the interface for public use. The system, once running, will help identify areas of chronic beach postings and, as a result, will aid in improved targeting of programs to address the sources of bacterial contamination.



Creating wetlands around rivers, or areas of wet weather sources of pollution, may help lower the levels of bacteria that cause beaches to be closed/posted or have advisories issued. The wetland area may reduce high bacterial levels that are typical after storm events by detaining and treating water in surface areas rather than releasing the bacteria rich waters into the local lakes and recreational areas. Studies by the Lake Michigan Ecological Research Station show that wetlands could lower bacterial levels at State Park beaches, but more work is needed (Mitchell 2002).

Variability in the data from year to year may result from changing seasonal weather conditions, the process of monitoring and variations in reporting, and may not be solely attributable to actual increases or decreases in levels of microbial contaminants. At this time, most of the beaches in the Great Lakes basin are monitored and have quality public notification programs in place. In addition, state beach managers are beginning to submit their beach monitoring and advisory/closure data to the USEPA annually. The State of Michigan has an online site (<http://www.glin.net/beachcast>) where beach monitoring data is posted by Michigan beach managers. In Ontario the SWMRS program will increase the efficiency and accuracy of the data collection and reporting.

To ensure accurate and timely posting of Great Lake beaches, methods must be developed to deliver quicker results that focus not just on indicator levels but on water quality in general. This issue may be addressed in the near future, as the BEACH Act requires USEPA to study issues associated with pathogens and human health and to publish new or revised Clean Water Act Section 304(a) criteria. U.S. EPA's Office of Research & Development in Cincinnati, Ohio, is evaluating methods for rapidly detecting recreational water quality, and U.S. EPA's National Health & Environmental Effects Research Laboratory (NHEERL) in Research Triangle Park, North Carolina, and the Centers for Disease Control and Prevention are carrying out epidemiological studies that relate swimming-associated illnesses to water quality. The information developed will be used by U.S. EPA's Office of Water to develop monitoring guidance. NHEERL is implementing studies at various coastal freshwater and marine beaches across the country in 2003, 2004 and 2005. Until new indicators are available, predictive models and/or the experience of knowledgeable environmental or public health officers (who regularly collect the samples) can be used on both sides of the border. Each method takes a variety of factors into account, such as amount of rainfall, cloud coverage, wind, current, point and non-point source pollution inputs, and the presence of wildlife, to predict whether it is likely that *E. coli* levels will be exceeded.

#### **Acknowledgments**

Harold Leadlay, Environment Canada – Ontario Region, Downsview, ON; Susan Arndt, Environment Canada – Ontario Region, Burlington, ON; David Rockwell and Elizabeth Murphy, Environmental Protection Agency - Great Lakes National Program Office, Chicago, IL; Holiday Wirick, Environmental Protection Agency Region 5 - Water Division, Chicago, IL

#### *Special Thanks*

Christina Clark, Environment Canada Intern (2002), Downsview, ON

#### **Sources**

Canadian data obtained from Ontario Health Units along the Great Lakes.

Health Canada. (October 26, 1999). Guidelines for Canadian Recreational Water Quality, 1992, 101 p. [Online]. Available: [http://www.hc-sc.gc.ca/ehp/ehd/catalogue/bch\\_pubs/recreational\\_water.htm](http://www.hc-sc.gc.ca/ehp/ehd/catalogue/bch_pubs/recreational_water.htm) [July 12, 2002].

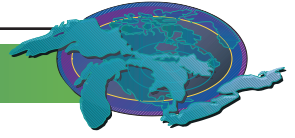
Ministry of Health. January 1, 1998. Beach Management Protocol - Safe Water Program. [Online]. Algoma Health Unit. Available: [http://www.ahu.on.ca/health\\_info/enviro\\_health/enviro\\_water/enviro\\_water\\_BeachManagement%20Protocol.htm](http://www.ahu.on.ca/health_info/enviro_health/enviro_water/enviro_water_BeachManagement%20Protocol.htm) [July 12, 2002].

Mitchell, David. (2002). *E. coli* testing may have outlived usefulness. [Online]. The Times Online. Available: <http://www.thetimesonline.com/index.pl/articlesubpc?id=23927743> [July 17, 2002].

U.S. EPA. (January, 1986). Ambient Water Quality Criteria for Bacteria - 1986. [Online]. Available: [www.epa.gov/OST/beaches](http://www.epa.gov/OST/beaches)

U.S. EPA. ( July, 2002). National Beach Guidance and Required Performance Criteria for Grants. [Online]. Available: [www.epa.gov/OST/beaches](http://www.epa.gov/OST/beaches)

U.S. EPA. (2002). National Health Protection Survey of Beaches for Swimming (1998 to 2001). [online]. Available:



<http://www.epa.gov/waterscience/beaches>.

U.S. EPA. (2002). Great Lakes Strategy 2002. [online]. Available: <http://www.epa.gov/glno/gls/index.html>.

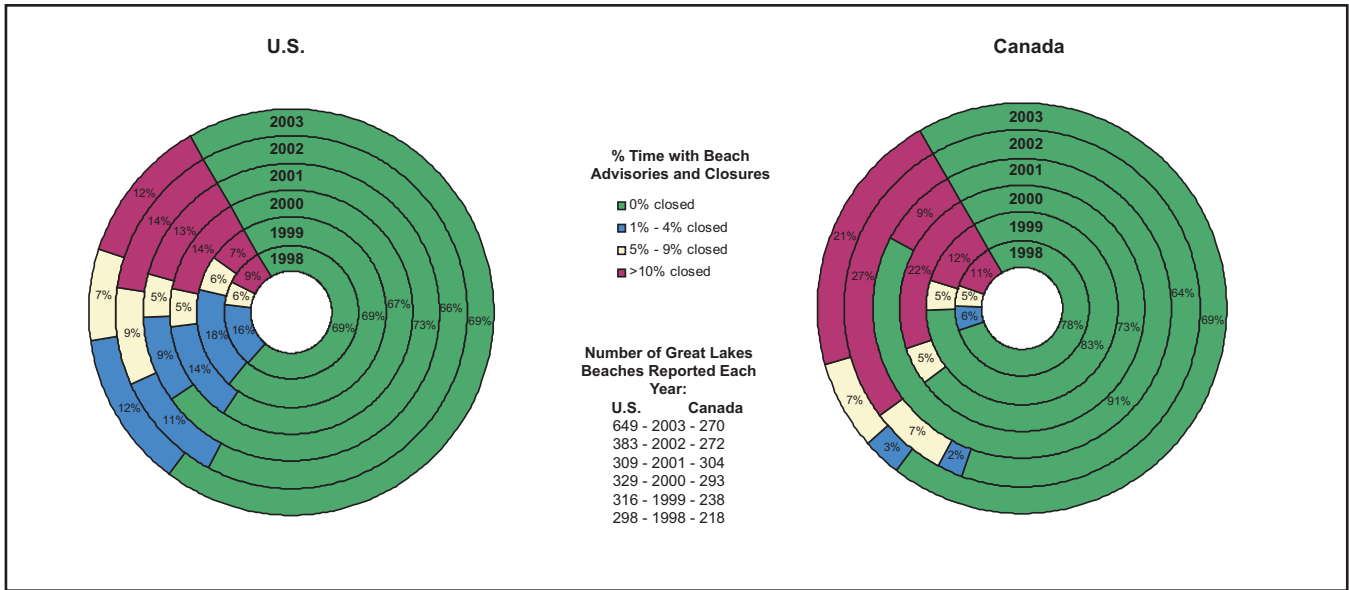
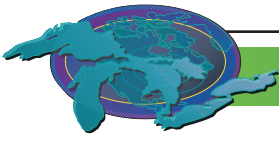


Figure 1: Proportion of Great Lakes Beaches with Beach Advisories in the United States and Canada for the 1998-2003 Bathing Seasons



## Contaminants in Sport Fish

SOLEC Indicator #4201

*This indicator replaces indicator #4083*

### Assessment: Mixed Improving

#### Purpose

To assess potential human exposure to contaminants through consumption of popular sport species (Coho Salmon) in addition to provide general, temporal contaminant (PCB) trend data for top predator species. Historical concentration trends in the edible portion of sport fish in the Great Lakes is determined by using fish contaminant data. The Great Lakes Uniform Sport Fish protocol for PCBs is used as a standardized fish advisory benchmark and is applied to historical data to track trends in fish consumption advice. US EPA GLNPO salmon fillet data (Minnesota DNR salmon fillet data for Lake Superior) are used to demonstrate this indicator. Due to gaps and variability in GLNPO salmon fillet data, statistically significant trends are difficult to discern.

#### Ecosystem Objective

Great Lakes sport fish should be safe to eat. The health of humans in the Great Lakes ecosystem should not be at risk from contaminants of human origin. Unlimited consumption of all Great Lakes sport fish should be available to citizens of the Great Lakes Basin.

Annex 2 of the GLWQA requires LaMPs to define "...the threat to human health posed by critical pollutants... including beneficial use impairments."

#### State of the Ecosystem

Since the 1970's, there have been declines in many persistent bioaccumulative toxic (PBT) chemicals in the Great Lakes basin. However, PBT chemicals, because of their ability to bioaccumulate and persist in the environment, continue to be a significant concern.

Fish Consumption Programs are well established in the Great Lakes. States, tribes, and the province of Ontario have extensive fish contaminant monitoring programs and issue advice to their residents about how much fish and which fish are safe to eat. This advice ranges from recommendations limiting consumption of specific sizes, species, and or water bodies to unlimited consumption of fish from various locations. Advice from these agencies to limit consumption of fish is mainly due to levels of PCBs, mercury, chlordane, dioxin, and toxaphene in the fish and are listed in a summary table below.

#### Lake Contaminants that Fish Advisories are based on in Canada and the United States

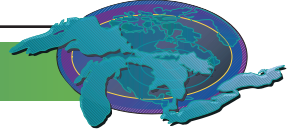
Superior	PCBs, mercury, dioxin, toxaphene, chlordane
Huron	PCBs, mercury, dioxin, toxaphene, chlordane
Michigan	PCBs, mercury, dioxin, chlordane
Erie	PCBs, mercury, dioxin
Ontario	PCBs, mercury, dioxin, toxaphene, mirex

State, tribal and provincial governments provide information to consumers regarding consumption of sport-caught fish. Neither the guidance nor advice of a State, tribal, or provincial government is regulatory. Although some states use the Federal commercial-fish guidelines for the acceptable level of contaminants when giving advice for eating sport caught fish. Consumption advice offered by most agencies is based on human health risk. This approach involves interpretation of studies on health effects from exposure to contaminants. Each state or province is responsible for developing fish advisories for protecting the public from pollutants in fish and tailoring this advice to meet the health needs of its citizens. As a result, the advice from state and provincial programs is sometimes somewhat different for the same lake and species within the lake.

#### Pressures

Organochlorine contaminants in fish in the Great Lakes are generally decreasing. As these contaminants decline, mercury is becoming a more important contaminant of concern regarding the edibility of the fish.





Emerging contaminants, such as certain brominated flame-retardants, are increasing in the environment and may have negative health impacts. There are currently several studies in the Great Lakes investigating the presence of brominated flame retardants.

Screening studies on a larger suite of chemicals is needed. The health effects of multiple contaminants, including endocrine disruptors, need to be addressed.

### **Management Implications**

Health risk communication is also a crucial component to the protection and promotion of human health in the Great Lakes. Enhanced partnerships between those involved in the issuing of fish consumption advise and head quarters will improve commercial and non-commercial fish advisory coordination. Support from the Great Lakes National Program Office and U.S. EPA headquarters to the States to help facilitate a meeting to review risk assessment protocols. At present, PCBs and chlordane are the only PBT chemicals that have uniform fish advisory protocols across the U.S. Great Lakes Basin. There is a need to establish additional uniform PBT advisories in order to limit confusion of the public by issuing varying advisories for the same species of sport fish across the basin.

In order to best protect human health, increased monitoring and reduction of PBT chemicals need to be made a priority. In particular, monitoring of contaminant levels in environmental media and biomonitoring of human tissues need to be addressed through assessments of frequency and type of fish consumption. This is of particular concern in sensitive populations. In addition, improved understanding of the potential negative health effects from the exposure to PBT chemicals is needed.

In March of 2004, the U.S. Food and Drug Administration (FDA) and the U.S. Environmental Protection Agency (EPA) jointly released a consumer advisory on methylmercury in fish. The joint advisory advises women who may become pregnant, pregnant women, nursing mothers, and young children to avoid some types of fish and eat fish and shellfish that are lower in mercury. While this is a step forward in uniform advice regarding safe fish consumption, the national advisory is not consistent with some Great Lake States advisories. Cooperation among National, State, and Tribal governments to develop and distribute the same message regarding safe fish consumption needs to be continued.

### **Further Work Necessary**

1) Evaluation of historical data: the longterm fish contaminant monitoring data sets that have been assembled by several jurisdictions for different purposes need to be more effectively utilized. Relationships need to be developed that allow for comparison and combined use of existing data from the various sampling programs. These data could be used in expanding this indicator to other contaminants and species and for supplementing the data used in this illustration.

2) Coordination of future monitoring

3) Agreement on fish advisory health benchmarks for the contaminants that cause fish advisories in the Great Lakes. Suggested starting points are: The Great Lakes Protocol for PCBs and Chlordane; Health Canada's TDI for toxaphene and U.S. EPA's reference dose for mercury.

### **Acknowledgments**

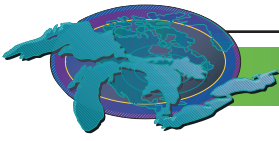
Authors: Elizabeth Murphy, USEPA Great Lakes National Program Office,  
Jackie Fisher, USEPA Great Lakes National Program Office  
Sandra Hellman, USEPA Great Lakes National Program Office  
Patricia McCann, Minnesota Department of Health

### **Sources**

Elizabeth Murphy, U.S. EPA, Great Lakes National Program Office, [murphy.elizabeth@epa.gov](mailto:murphy.elizabeth@epa.gov).

De Vault, D.S. and J.A. Weishaar. 1983. Contaminant analysis of 1981 fall run coho salmon. U.S. Environmental Protection Agency, Great lakes National Program Office. EPA 905/3-83-001.

De Vault, D.S. and J.A. Weishaar. 1984. Contaminant analysis of 1982 fall run coho salmon. U.S. Environmental protection Agency,



Great Lakes National Program Office. EPA 905/3-85-004.

De Vault, D.S., and J.A. Weishaar, J.M. Clark and G. Lavhis. 1988. Contaminants and trends in fall run coho salmon. Journal of Great Lakes Research 14:23-33.

U.S. Environmental Protection Agency. *Consumption Advice, Joint Federal Advisory for Mercury in Fish*. March 2004. <http://www.epa.gov/waterscience/fishadvice/advice.html>. (May 24, 2004).

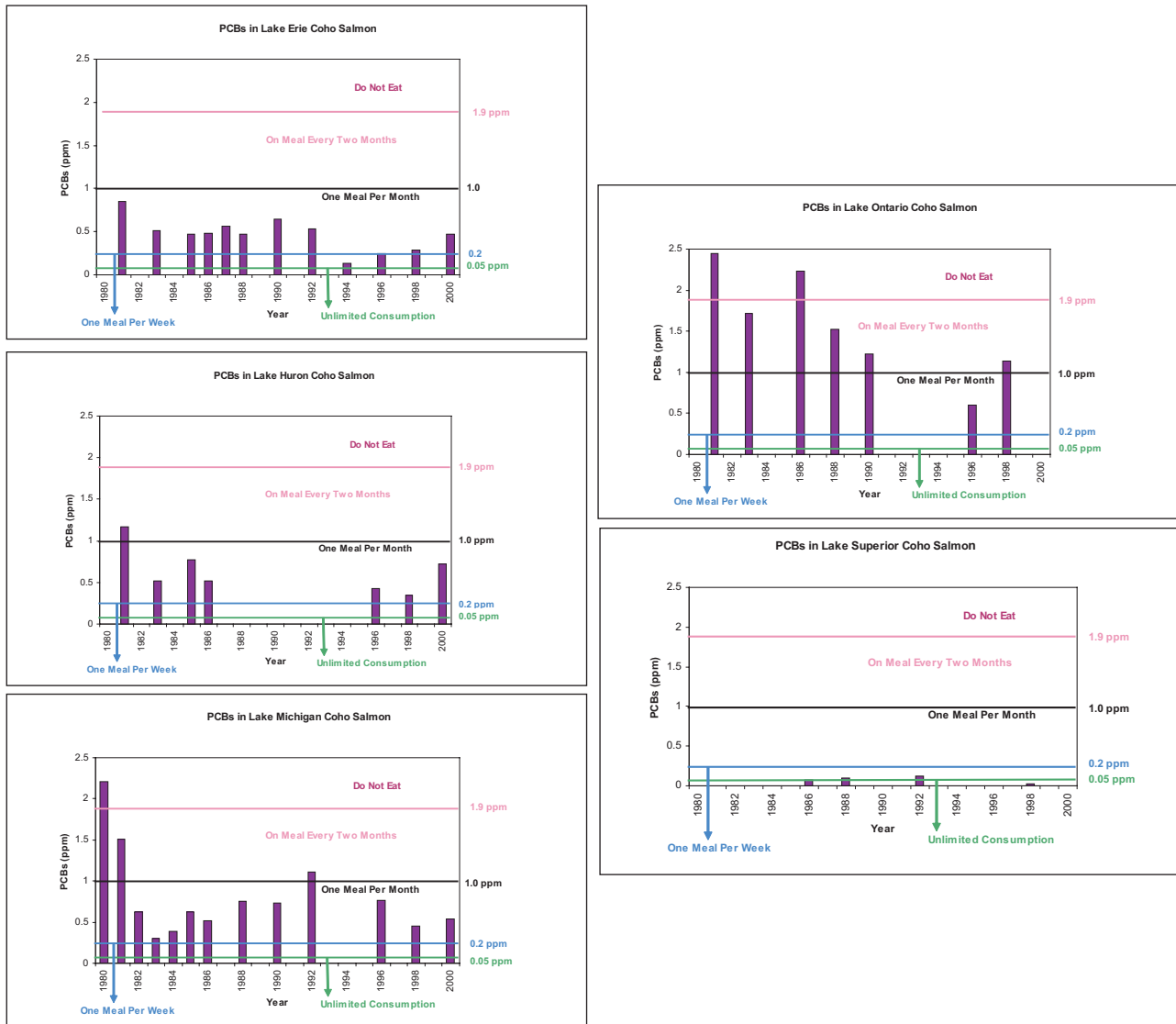
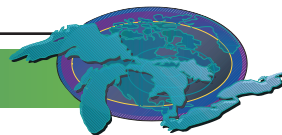


Figure 1. Results of a uniform fish advisory protocol applied to historical data (PCBs, coho salmon) in the Great Lakes. Blank indicates no sampling. Source Sandy Hellman, U.S. Environmental Protection Agency – Great Lakes National Program Office



## Air Quality

SOLEC Indicator #4202

*Note: This indicator replaces the old Air Quality indicator (#4176).*

**Assessment: Mixed, Improving**

### Purpose

To monitor the air quality in the Great Lakes ecosystem, and to infer the potential impact of air quality on human health in the Great Lakes Basin.

### Ecosystem Objective

Air should be safe to breathe. Air quality in the Great Lakes ecosystem should be protected in areas where it is relatively good, and improved in areas where it is degraded. This is consistent with ecosystem objectives being adopted by certain lakewide management plans, including Lake Superior, in fulfillment of Annex 2 of the Great Lakes Water Quality Agreement. This indicator also supports Annexes 1, 13, and 15.

### State of the Ecosystem

Overall, there has been significant progress in improving air quality in the Great Lakes Basin. For several substances of interest, both emissions and ambient concentrations have decreased over the last ten years or more. However, progress has not been uniform and differences in weather from one year to the next complicate analysis of ambient trends. Ozone and fine particulate matter can be particularly elevated during hot summers, and the trends are not consistent with those for related pollutants. Drought conditions result in more fugitive dust emissions from roads and fields, increasing the ambient levels of particulate matter.

In general, there has been significant progress with urban/local pollutants over the past decade or more, though somewhat less in recent years, with a few remaining problem districts. Ground-level ozone and fine particles remain a concern in the Great Lakes region, especially in the Detroit-Windsor-Ottawa corridor, the Lake Michigan basin, and the Buffalo-Niagara area. These pollutants continue to exceed the respective air quality criteria and standards at a number of monitoring locations in Southern Ontario and in the lower Great Lakes region in the U.S.

For the purposes of this discussion, the pollutants can be divided into urban (or local) and regional pollutants. For regional pollutants, transport is a significant issue, from hundreds of kilometers to the scale of the globe; formation from other pollutants, both natural and man-made, can also be important. Unless otherwise stated, references to the U.S. or Canada in this discussion refer to nationwide averages.

### Urban/Local Pollutants

#### Carbon Monoxide (CO)

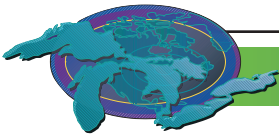
##### *Ambient Concentrations:*

In the U.S., CO levels for 2002 were the lowest recorded in the past 20 years. Ambient concentrations have decreased approximately 65 percent nationally from 1983 to 2002 and 42 percent nationally from 1993 to 2002. There are currently no nonattainment areas in the U.S. for CO. In general, CO levels have decreased more rapidly in the Great Lakes region than the nation as a whole.

In Canada, there has been about a 60 percent reduction nationwide in the average ambient levels of CO from 1980 to 2000. Ontario has not experienced an exceedence of the 1-hour and 8-hour criteria since 1991. The composite average of the 1-hour and the 8-hour CO maximums has decreased 55 percent from 1993 to 2002. The composite annual mean has also decreased 29 percent over this same period.

##### *Emissions:*

In the U.S., nationwide emissions of CO have decreased 41 percent from 1983 to 2002 and 21 percent from 1993 to 2002 despite a 155 percent increase in vehicle miles traveled since 1970. The reductions are much more than reported in the State of the Great Lakes 2003 (SOGL) Report due to improvements made in the emissions inventories.



In Canada, emissions have decreased nationally by 17 percent since 1988 with a 4.1 percent decline in Ontario between 1991 and 2000. These declines are mainly the result of more stringent transportation emission standards.

#### Nitrogen Dioxide (NO<sub>2</sub>)

##### *Ambient Concentrations:*

In Canada, annual average hourly NO<sub>2</sub> concentrations show a slight downward trend from 1991 to 2000. Ontario's annual mean concentrations declined about 23 percent from 1975 to 2002; however, there is no significant trend in the data from 1992 to 2001. The air quality criterion for NO<sub>2</sub> was not exceeded at any of Ontario's monitoring stations in 2001 or 2002.

In the U.S., the annual mean concentrations decreased 21 percent from 1983 to 2002 and decreased 11 percent from 1993 to 2002. The levels in the Great Lakes region have decreased 19 percent from 1982 to 2001, with the majority of the improvement occurring in the 1980s. An analysis of urban versus rural monitoring sites indicates that the declining trend seen nationwide and in the Great Lakes can mostly be attributable to decreasing concentrations in urban areas (similar results can be found in Ontario). There are currently no NO<sub>2</sub> non-attainment areas in the U.S.

##### *Emissions:*

Canadian emissions of the family of nitrogen oxides (NO<sub>x</sub>) have remained relatively constant since 1990, although significant reductions have been accomplished from the transportation sector.

In the U.S., emissions of NO<sub>x</sub> decreased by about 15 percent from 1983 to 2002 and decreased by about 12 percent from 1993 to 2002. This trend is much different from the increase reported in the SOGL 2003 report due to new and improved emission estimates for highway vehicles and nonroad engines. (For more information on oxides of nitrogen, please refer to the SOLEC Indicator Report #9000 Acid Rain.)

#### Sulfur Dioxide (SO<sub>2</sub>)

##### *Ambient Concentrations:*

In the U.S., annual mean concentrations of SO<sub>2</sub> decreased 54 percent from 1983 to 2002. From 1993 to 2002, annual mean concentrations of SO<sub>2</sub> in the U.S. decreased 39 percent. The Great Lakes region has experienced reducing trends on par with the national averages. There are two nonattainment areas in the Great Lakes region for SO<sub>2</sub> (Lake County, Indiana; and Cuyahoga County, Ohio). Since the SOGL 2003 Report, the U.S. EPA approved the redesignation of Lucas County (Toledo), Ohio, to attainment.

Canada has experienced a 50 percent reduction nationwide in the average ambient levels of SO<sub>2</sub> from 1980 to 2000. In Ontario, the average ambient concentrations improved 84 percent from 1971 to 2002, with a 20 percent improvement since 1993. Ontario experienced only two violations of the one-hour criterion of 250 ppb in each 2001 and 2002 (Sarnia and Sudbury).

##### *Emissions:*

In the U.S., national SO<sub>2</sub> emissions were reduced 33 percent from 1983 to 2002 and 31 percent from 1993 to 2002.

Canadian emissions decreased 45 percent nationwide from 1980 to 2000, but have remained relatively constant since 1995. Even with increasing economic activity, emissions remain about 20 percent below the target national emission cap. From 1971 to 2001, the emissions of SO<sub>2</sub> in Ontario decreased 82 percent. (For more information on sulfur dioxide, please refer to the SOLEC Indicator Report #9000 Acid Rain.)

#### Lead

##### *Ambient Concentrations:*

U.S. concentrations decreased 94 percent from 1983 to 2002 and 57 percent from 1993 to 2002. Lead levels in the Great Lakes region decreased at nearly the same rate as the national trend over this time. There are no non-attainment areas for lead in the Great Lakes region.

Lead concentrations at urban monitoring stations in Ontario have decreased over 95 percent from 1984 to 2000.

*Emissions:*

National lead emissions in the U.S. decreased 93 percent from 1982 to 2002, but only five percent from 1993 to 2002, as a result of regulatory efforts to reduce the content of lead in gasoline.

Similar improvements in Canada have followed with the usage of unleaded gasoline.

Total Reduced Sulfur (TRS)*Ambient Concentrations:*

This family of compounds is of concern in Canada due to odor problems in some communities, normally near industrial or pulp mill sources. There is no apparent trend in the annual average concentrations of TRS in Ontario from 1993 to 2002. There are still periods above the ambient criteria near a few centers.

PM<sub>10</sub>*Ambient Concentrations:*

PM<sub>10</sub> is the fraction of particles in the atmosphere with a diameter of 10 microns or smaller. Ambient concentrations in the U.S. have decreased 13 percent from 1993 to 2002. Levels in the Great Lakes region have fallen by about 12 percent from 1992 to 2001. There are currently two nonattainment areas in the Great Lakes region (both in Cook County, Illinois). Since the SOGL 2003 Report, the U.S. EPA approved the redesignation of Lake County, Indiana, to attainment.

Canada does not have an ambient target for PM<sub>10</sub>. However, Ontario has an interim standard of 50 ug/m<sup>3</sup> over a 24-hour sampling period.

*Emissions:*

In the U.S., national direct source man-made emissions decreased 34 percent from 1985-2002 and 22 percent from 1993 to 2002.

Air Toxics

This term captures a large number of pollutants that, based on the toxicity and likelihood for exposure, have potential to harm human health (e.g. cancer) or adverse environmental and ecological effect. Some of these are of local importance, near to sources, while others may be transported over long distances. Monitoring is difficult and expensive, and usually limited in scope: usually such toxics are present only at trace levels. Recent efforts in Canada and the U.S. have focused on better characterizing ambient levels and minimizing emissions. In the U.S. the Clean Air Act targets a 75% reduction in cancer “incidence”, and “substantial” reduction in non-cancer risks. The maximum available control technology (MACT) program sets emissions standards on industrial sources to reduce emissions of air toxics. Once fully implemented, these standards will cut emissions of toxic air pollutants by nearly 1.5 million tons per year from 1990 levels.

In Canada, key toxics such as benzene, mercury, dioxins, and furans are the subject of ratified and proposed new standards, and voluntary reduction efforts.

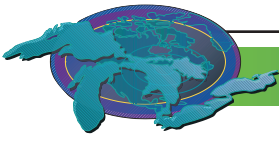
*Ambient Concentrations:*

A National Air Toxics Trend Site (NATTS) network was launched in the U.S. in 2003 to detect trends in high-risk air toxics such as benzene, formaldehyde, 1,3-butadiene, acrolein, and chromium. There are four monitoring sites in the Great Lakes region including Chicago, Detroit, Rochester, and Mayville, WI. Some ambient trends have also been found from existing monitoring networks. Average annual urban concentrations of benzene have decreased 47 percent in the U.S. from 1994 to 2000.

In Ontario, average annual urban concentrations of benzene have decreased 56 percent from 1993 to 2002. The average annual urban concentrations in Ontario of toluene and o-xylene (aromatic hydrocarbons) have decreased 44 and 59 percent, respectively, over the same time period. Ontario data also shows similar decreasing trends in the concentrations of 1,1,1-trichloroethane, carbon tetra chloride and dichloromethane (3 common solvents) over the same period.

*Emissions:*

The Great Lakes Toxics Inventory is an ongoing initiative of the regulatory agencies in the eight Great Lakes States and the Province of Ontario. Emissions inventories have been developed for 1996, 1997, 1998, 1999 and 2001 but different approaches were used to



develop these inventories making trend analysis difficult.

In Canada, emissions are also being tracked through the National Pollutant Release Inventory (NPRI). The NPRI included information on some of the substances listed by the Accelerated Reduction/Elimination of Toxics (ARET) program. Significant voluntary reductions in toxic emissions were reported through the ARET program through 2000.

In the U.S., emissions are also being tracked through the National Emissions Inventory (NEI) and the Toxics Release Inventory (TRI). NEI data indicate that national U.S. toxic emissions have dropped approximately 24 percent between the baseline (1990-1993) and 1996 though emission estimates are subject to modification, and the trends are different for different compounds. Begun in 1988, the TRI contains information on releases of nearly 650 chemicals and chemical categories from industries including manufacturing, metal and coal mining, electric utilities, and commercial hazardous waste treatment, among others. Although the TRI has expanded and changed over the years, it is still possible to ascertain trends over time for core sets of toxics. The total reported air emissions of the TRI 1988 Core Chemicals (299 chemicals) in the 8 Great Lakes States have decreased by about 75 percent from 1988 to 2002.

## Regional Pollutants

### Ground-Level Ozone (O<sub>3</sub>)

Ozone is almost entirely a secondary pollutant, which forms from reactions of precursors (VOCs - volatile organic compounds and NO<sub>x</sub> - oxides of nitrogen) in the presence of heat and sunlight. Ozone is a problem pollutant over broad areas of the Great Lakes region, except for the Lake Superior basin. Local onshore circulations around the Great Lakes can exacerbate the problem, as pollutants can remain trapped for days below the maritime inversion. Consistently high levels are found in provincial parks near Lakes Huron and Erie, and western Michigan is impacted by transport across Lake Michigan from Chicago.

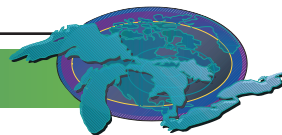
#### *Ambient Concentrations:*

In 2003, ozone levels in the U.S. were the lowest they have been in over 20 years; however, the improved air quality was a result mainly from favorable weather conditions. National assessments find some uneven improvement in peak levels, but with indications that average levels may be increasing on a global scale. Ozone levels are still decreasing nationwide, but the rate of decrease for 8-hour ozone levels has slowed since 1990. The Great Lakes region has experienced smaller decreases than nationwide averages (Figure 1). Many of the improvements in ozone concentrations are a result of local emission reductions in urban areas. On the other hand, ozone concentrations in rural areas have remained relatively stable with some slight increases.

There are six nonattainment areas in the Great Lakes basin for the 1-hour ozone standard (Chicago metropolitan area, Illinois; Lake and Porter Counties, Indiana; Milwaukee-Racine metropolitan area, Wisconsin; Erie County, Pennsylvania; Buffalo-Niagara Falls metropolitan area, New York; and Jefferson County, New York). Since the SOGL 2003 report, Manitowoc and Door Counties in Wisconsin were redesignated to attainment for the 1-hour ozone standard. In addition, the U.S. EPA recently designated 28 areas covering 70 counties as nonattainment for the 8-hour ozone standard in the Great Lakes basin (Chicago-Gary-Lake Co, IL-IN metropolitan area; South Bend/Elkhart, IN; LaPorte County, IN; Fort Wayne, IN; Detroit-Ann Arbor metro area, MI; Flint metro area, MI; Grand Rapids metro area, MI; Muskegon County, MI; Allegan County, MI; Huron County, MI; Kalamazoo-Battle Creek metro area, MI; Lansing-East Lansing metro area, MI; Benton Harbor area, MI; Benzie County, MI; Cass County, MI; Mason County, MI; Toledo metro area, OH; Cleveland-Akron-Lorain metro area, OH; Erie, PA; Jamestown, NY; Buffalo-Niagara Falls metro area, NY; Rochester metro area, NY; and Jefferson County, NY).

In Ontario, ozone concentrations continue to exceed Ontario's Ambient Air Quality Criterion (AAQC). In 2002, 39 out of the 40 monitoring sites in Ontario recorded exceedences of the 1-hour AAQC on at least one occasion. Although the ozone levels continue to exceed Ontario's AAQC, the maximum ozone concentrations recorded in Ontario have on average decreased from 1980 to 2002 (Figure 2). This trend may indicate that efforts to curb emissions and improve the air quality in Ontario are working.

However, Ontario has experienced an overall increasing trend in seasonal mean ozone concentrations over the same 23-year period. The summer and winter seasonal ozone means have increased by approximately 23 percent and 27 percent, respectively (Figure 3). The increase of the summer mean is related to meteorological conditions and the transport of ozone and its precursors into Ontario; whereas, the increase of the winter mean indicates an increase in background concentrations of ozone throughout Ontario. Similar increases in the background concentrations of ozone have been found in other parts of North America.



Although Ontario is not required to report on the new 8-hour Canada-wide Standard (CWS) for ozone until 2006, data in 2002 indicate that all but one monitoring site in Ontario recorded at least one day with levels of the daily maximum 8-hour ozone that exceeded 65 ppb. In Eastern Canada as a whole, the annual 4<sup>th</sup> highest daily maximum 8-hour concentration shows little change from 1991 to 2000.

#### *Emissions:*

In the U.S., VOC emissions have decreased 48 percent from 1980 to 2003 and 32 percent from 1990 to 2003. NO<sub>x</sub> emissions in the U.S. have also decreased 27 percent from 1980 to 2003 and 22 percent from 1990 to 2003.

In Ontario, man-made VOC emissions have decreased about 13 percent from 1992 to 2001. However, VOC emissions in all of Canada have remained relatively constant from 1991 to 2000. Canadian NO<sub>x</sub> emissions have remained fairly constant since 1990, although significant reductions have been accomplished from the transportation sector.

#### PM<sub>2.5</sub>

This fraction of particulate matter (diameter of 2.5 microns or less) is of health concern because it can penetrate deeply into the lung, in contrast to larger particles. PM<sub>2.5</sub> is primarily a secondary pollutant produced from both natural and man-made precursors (SO<sub>2</sub>, NO<sub>x</sub>, and ammonia).

#### *Ambient Concentrations:*

A CWS for PM<sub>2.5</sub> of 30 ug/m<sup>3</sup> was established in June 2000. Achievement of the standard is based on the 3-year average of the annual 98<sup>th</sup> percentiles of the daily, 24-hour (midnight to midnight) average concentrations. As PM<sub>2.5</sub> monitoring has only begun quite recently, there is not enough data to show any national long-term trends. Although Ontario is not required to meet the CWS for fine particulate matter until 2010 and begin reporting on progress towards meeting the new CWS until 2006, data from 2002 indicate that seven out of 14 monitoring sites across Ontario recorded 98<sup>th</sup> percentile daily averages of PM<sub>2.5</sub> above 30 ug/m<sup>3</sup>. Data from 2001 show similar patterns, with nine out of 20 monitoring sites above 30 ug/m<sup>3</sup>.

In a preliminary assessment of data from the U.S. PM<sub>2.5</sub> monitoring network, it appears that concentrations in urban areas are higher than in rural areas. The average annual concentration of PM<sub>2.5</sub> has decreased 8 percent from 1999 to 2002. This decreasing trend is mostly attributable to reductions in SO<sub>2</sub> emissions as a result of Phase II of the Acid Rain Program. The particulate matter of the Great Lakes region generally has larger fractions of nitrates and carbon than national averages. Therefore, the Great Lakes region probably experienced a lesser decrease in PM<sub>2.5</sub> concentrations. On June 29, 2004, the U.S. EPA issued preliminary designations for the PM<sub>2.5</sub> standard. Five areas in the Great Lakes region were preliminarily designated nonattainment including the Chicago-Gary-Kenosha, IL-IN-WI metropolitan area; Elkhart and St. Joseph Counties, IN; Detroit-Ann Arbor, MI metro area; Toledo, OH metro area; and the Cleveland-Akron-Lorain, OH metro area.

#### *Emissions:*

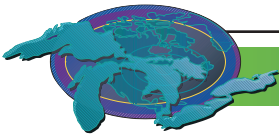
In the U.S., direct emissions of PM<sub>2.5</sub> from anthropogenic sources decreased 17 percent nationally from 1993 to 2002; however, this decreasing trend does not account for the formation of secondary particles.

#### **Future Pressures**

Continued economic growth, population growth, and associated urban sprawl are threatening to offset emission reductions achieved by policies currently in place, through both increased energy consumption and vehicles miles traveled. The changing climate may affect the frequency of weather conditions conducive to high ambient concentrations of many pollutants. There is also increasing evidence of changes to the atmosphere as a whole. Continuing health research is both broadening the number of toxics, and producing evidence that existing standards should be lowered.

#### **Management Implications**

Major pollution reduction efforts continue in both U.S. and Canada. In Canada, new ambient standards for particulate matter and ozone have been endorsed, with a 2010 achievement date. This will involve updates at the Federal level and at the provincial level (Ontario's Industry Emissions Reduction Plan, and Clean Air Action Plan). Toxics are also addressed at both levels. The Canadian



Environmental Protection Act (CEPA) was recently amended.

In the U.S., new, more protective ambient air standards have been promulgated for ozone and particulate matter. MACT (Maximum Available Control Technology) standards continue to be promulgated for sources of toxic air pollution. U.S. EPA has also begun looking at the risk remaining after emissions reductions for industrial sources take effect.

At the international level, Canada and the U.S. signed the Ozone Annex to the Air Quality Agreement in December 2000. The Ozone Annex commits both countries to emission reductions from the major sources of NO<sub>x</sub> and VOCs, thereby helping both countries attain their ozone air quality goals to protect human health and the environment. Canada estimates that total NO<sub>x</sub> reduction in the Canadian transboundary region will be between 35 and 39 percent by 2010 (from 1990 levels). Under the Clean Air Action Plan, Ontario is also committed to reducing provincial emission of NO<sub>x</sub> and VOCs by 45 percent of 1990 levels by 2015, with interim targets of 25 percent by 2005.

The U.S. estimates that the total NO<sub>x</sub> reductions in the U.S. transboundary region will be 36 percent year-round by 2010 and 43 percent during the ozone season. Canada and the U.S. have also undertaken cooperative modeling, monitoring, and data analysis and developed a work plan to address transboundary PM issues. Efforts to reduce toxic pollutants will also continue under NAFTA and through UN-ECE protocols.

PM<sub>2.5</sub> networks will continue to develop in both countries, to determine ambient levels, trends, and consequent reduction measures. Review of standards or objectives will continue to consider new information. The U.S. is continuing its deployment of a national air toxics monitoring network.

## Acknowledgements

Author: Todd Nettesheim, U.S. Environmental Protection Agency, Great Lakes National Program Office, Chicago, IL.

Reviewers: Diane Sullivan, Brenda Koekkoek, Ken Smith, John Ayres, Clarisse Kayisire, Carmen Bigras, Philip Blagden, and Jay Barclay, Environment Canada, Gatineau, Quebec; Hong (Holly) Lin and Fred Conway, Environment Canada, Meteorological Service of Canada, Downsview, Ontario; and David Yap, Ministry of the Environment, Ontario, Canada.

## Sources

Environment Canada. 2004. *2002 National Pollutant Release Inventory Data*.

[http://www.ec.gc.ca/pdb/npri/npri\\_dat\\_rep\\_e.cfm#highlights](http://www.ec.gc.ca/pdb/npri/npri_dat_rep_e.cfm#highlights) (Accessed June 29, 2004).

Environment Canada. 2003. *2001 National Pollutant Release Inventory: National Overview*.

[http://www.ec.gc.ca/pdb/npri/npri\\_dat\\_rep\\_e.cfm#annual2001](http://www.ec.gc.ca/pdb/npri/npri_dat_rep_e.cfm#annual2001) (Accessed June 29, 2004).

Environment Canada. 2003. *Environmental Signals: Canada's National Environmental Indicator Series 2003*.

[http://www.ec.gc.ca/soer-ree/English/Indicator\\_series/default.cfm#pic](http://www.ec.gc.ca/soer-ree/English/Indicator_series/default.cfm#pic) (Accessed June 29, 2004).

Environment Canada. 2003. *Clean Air in Canada: 2003 Progress Report on Particulate Matter and Ozone*. ISBN 0-662-34514-2.

[http://www.ec.gc.ca/air/PM\\_resp\\_03/PM\\_resp\\_03\\_e.pdf](http://www.ec.gc.ca/air/PM_resp_03/PM_resp_03_e.pdf) (Accessed June 17, 2004).

Environment Canada. 2003. *Cleaner Air through Cooperation: Canada – United States Progress under the Air Quality Agreement 2003*. ISBN 0-662-34082-5. <http://www.epa.gov/airmarkets/usca/brochure/brochure.htm> (Accessed June 17, 2004).

Environment Canada. 2003. *Environment Canada Performance Report: For the period ending March 31, 2003*. David Anderson, Minister of the Environment. [http://www.ec.gc.ca/dpr/EC\\_DPR\\_March\\_31\\_2003\\_EN-Oct6.pdf](http://www.ec.gc.ca/dpr/EC_DPR_March_31_2003_EN-Oct6.pdf) (Accessed June 17, 2004).

Environment Canada. *National Air Pollution Surveillance Network*. <http://www.etc-cte.ec.gc.ca/NAPS/> (Accessed June 29, 2004).

Great Lakes Regional Air Toxics Emissions Inventory. <http://www.glc.org/air/air3.html> (Accessed June 25, 2004).

International Joint Commission. *Canada-United States Air Quality Agreement: 2002 Progress Report*. <http://www.epa.gov/airmarkets/usca/airus02.pdf> (Accessed June 17, 2004).





NARSTO. 2000. *An Assessment of Tropospheric Ozone: A North American Perspective*. <http://www.cgenv.com/Narsto/> (Accessed June 30, 2004).

Ontario Ministry of the Environment. Air Quality in Ontario 2002 Report. Queen's Printer for Ontario, 2004. <http://www.ene.gov.on.ca/envision/techdocs/4521e01.pdf> (Accessed June 28, 2004).

Ontario Ministry of the Environment. Air Quality in Ontario 2001 Report. Queen's Printer for Ontario, 2003. <http://www.ene.gov.on.ca/envision/air/AirQuality/2001.htm> (Accessed June 17, 2004).

U.S. EPA. 2004. The Ozone Report: Measuring Progress through 2003. Office of Air Quality Planning and Standards. EPA-454/K-04-001. <http://www.epa.gov/airtrends/ozone.html> (Accessed June 17, 2004).

U.S. EPA. 2004. *Green Book: Non-attainment Areas for Criteria Pollutants*. Office of Air Quality Planning and Standards. <http://www.epa.gov/air/oaqps/greenbk/> (Accessed June 17, 2004).

U.S. EPA. 2004. Fine Particle (PM<sub>2.5</sub>) Designations. <http://www.epa.gov/pmdesignations/> (Accessed July 8, 2004).

U.S. EPA. 2004. 8-Hour Ground-Level Ozone Designations. <http://www.epa.gov/ozonedesignations/> (Accessed July 8, 2004).

U.S. EPA. 2004. Technology Transfer Network: Ambient Monitoring Technology Information Center <http://www.epa.gov/ttn/amtic/airtoxpg.html> (Accessed July 14, 2004).

U.S. EPA. 2004. Toxics Release Inventory Program. <http://www.epa.gov/tri/> (Accessed June 24, 2004).

U.S. EPA. 2003. National Air Quality and Emissions Trends Report: 2003 Special Studies Edition. Office of Air Quality Planning and Standards. EPA-454/R-03-005. <http://www.epa.gov/air/airtrends/aqtrnd03/> (Accessed June 17, 2004).

U.S. EPA. 2003. *Latest Findings on National Air Quality: 2002 Status and Trends*. Office of Air Quality Planning and Standards. EPA-454/K-03-001. [http://www.epa.gov/airtrends/2002\\_airtrends\\_final.pdf](http://www.epa.gov/airtrends/2002_airtrends_final.pdf) (Accessed June 17, 2004).

U.S. EPA. 2003. EPA's Draft Report on the Environment: Technical Document. EPA-600-R-03-050. <http://www.epa.gov/indicators/> (Accessed June 30, 2004).

U.S. EPA. 2003. 1999 National Emissions Inventory Documentation and Data. <http://www.epa.gov/ttn/chief/net/1999inventory.html>

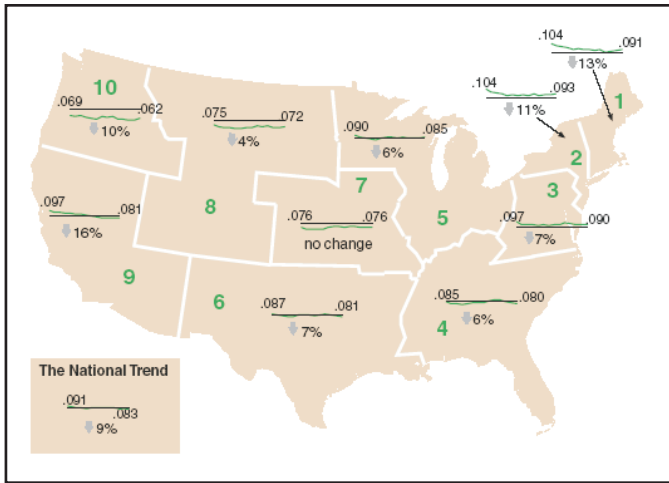
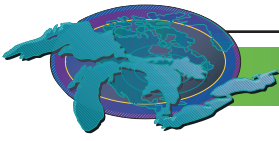


Figure 1. Trend in Fourth Highest Daily Maximum 8-hour Ozone Concentration (ppm) by EPA Region, 1990-2003.

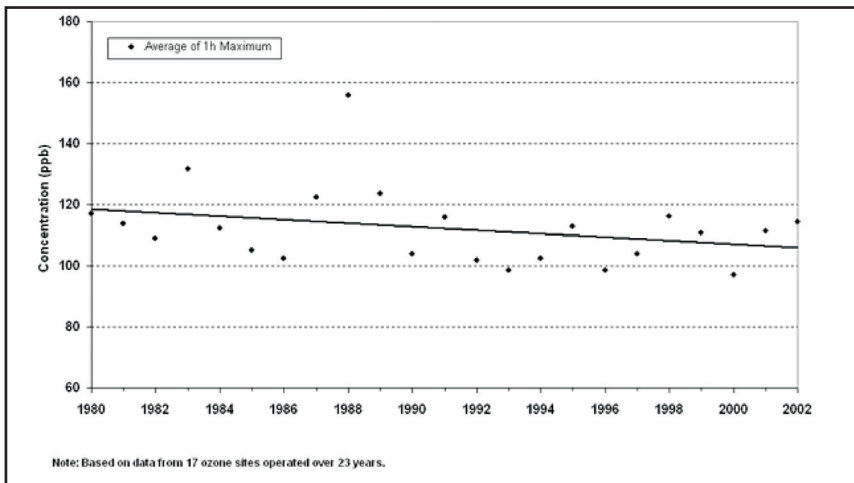


Figure 2. Mean 1-hour maximum ozone concentrations in Ontario from 1980 to 2002

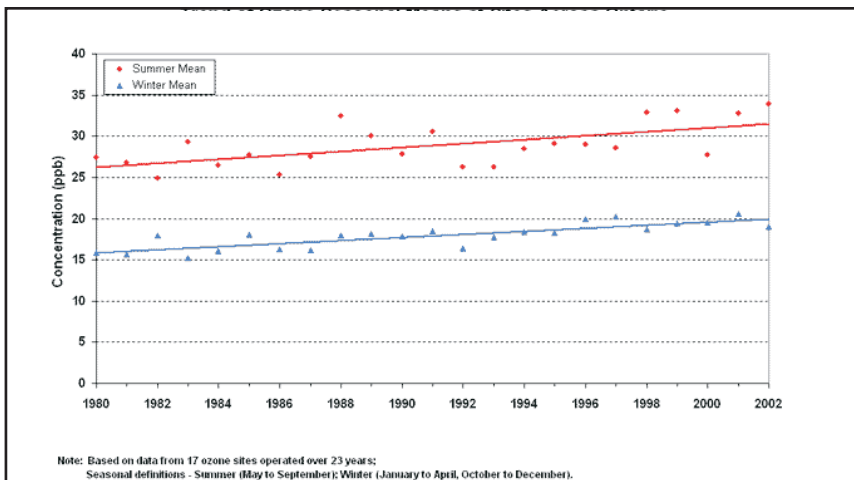
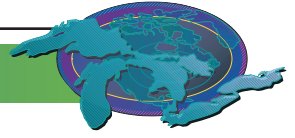


Figure 3. Summer and winter seasonal ozone mean concentrations from 1980 to 2002



## Coastal Wetland Invertebrate Community Health

SOLEC Indicator #4501

Note: This indicator has not yet been put into practice. The following evaluation was constructed using input from investigators collecting invertebrate community composition data from Great Lakes coastal wetlands over the last several years. Neither experimental design nor statistical rigor has been used to specifically address the status and trends of invertebrate communities of coastal wetlands of the five Great Lakes.

**Assessment:** N/A

### Purpose

To directly measure specific components of invertebrate community composition and use these as a surrogate for the chemical, physical and biological integrity and range of degradation of Great Lakes coastal wetlands.

### State of the Ecosystem

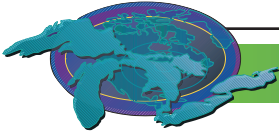
Development of this indicator is still in progress. Thus, the state of the ecosystem could not be determined using the wetland invertebrate community health indicator during the last 2 years. However, progress on indicator development was substantial, and implementation of basin wide sampling to indicate state of the ecosystem should be possible before the next SOLEC. Teams of Canadian and American researchers from several research groups (e.g. the Great Lakes Coastal Wetlands Consortium, the Great Lakes Environmental Indicators project investigators, the U.S. EPA Remap group of researchers led by Tom Simon, and others) sampled large numbers of Great Lakes wetlands during the last two years. They have reported an array of invertebrate communities in Great Lakes wetlands in presentations at international meetings, reports, and peer-reviewed journals.

In 2002 the Great Lakes Coastal Wetlands Consortium conducted extensive invertebrate surveys of wetland invertebrates of the 4 lower Great Lakes. These data are not entirely analyzed to date. However, Ingram et al. used the consortium adopted IBI (Uzarski et al. 2004) in wetlands of northern Lake Ontario. The results of their study can be obtained from Environment Canada (Environment Canada, 2004).

Uzarski et al. (2004) collected invertebrate data from 22 Lakes Michigan and Huron wetlands during 1997 through 2001. They determined that wetland invertebrate communities of Northern Lakes Michigan and Huron generally produced the highest IBI scores. IBI scores were primarily based on Richness and Abundance of Odonata, Crustacea plus Mollusca Taxa Richness, Total Genera Richness, Relative Abundance Gastropoda, Relative Abundance Sphaeriidae, Ephemeroptera plus Trichoptera Taxa Richness, Relative Abundance Crustacea plus Mollusca, Relative Abundance Isopoda, Evenness, Shannon Diversity Index, and Simpson Index. Wetlands near Escanaba and Cedarville Michigan scored lower than most in the area. A single wetland near the mouth of the Pine River in Mackinac County, MI consistently scored low as well. In general, all wetlands of Saginaw Bay scored lower than those of northern Lakes Michigan and Huron. However, impacts are more diluted near the outer bay and IBI scores reflect this. Wetlands near Quanicassee and Almeda Beach, MI consistently scored lower than other Saginaw Bay sites.

Burton and Uzarski (unpublished) also studied drowned river mouth wetlands of eastern Lake Michigan quite extensively since 1998. Invertebrate communities of these systems show linear relationship with latitude. However, this relationship reflects anthropogenic disturbance and metrics (Odonata Richness and Abundance, Crustacea plus Mollusca Richness, Total Genera Richness, Relative Abundance Isopoda, Shannon Index, Simpson Index, Evenness, and Relative Abundance Ephemeroptera) placed the sites studied in increasing community health in the order Kalamazoo, Pigeon, Muskegon, White, Pentwater, Pere Marquette, Manistee, Lincoln, and Betsie. The most impacted systems of eastern Lake Michigan are located along southern edge and impacts decrease to the north.

Wilcox et al. (2002) attempted to develop wetland IBIs for the upper Great Lakes using microinvertebrates. While they found attributes that showed promise during a single year, they concluded that natural water level changes were likely to alter communities and invalidate metrics. They found that Siskiwit Bay, Bark Bay, and Port Wing had the greatest overall taxa richness with large catches of cladocerans. They ranked microinvertebrate communities of Fish Creek and Hog Island lower than the other four western Lake Superior sites. Their work in eastern Lake Michigan testing potential metrics placed the sites studied in decreasing community health in the order Lincoln River, Betsie River, Arcadia Lake/Little Manistee River, Pentwater River, and Pere Marquette River.



This order was primarily based on the Median Number of Taxa, the Median Cladocera Genera Richness, and also a macroinvertebrate metric (Number of Adult Trichoptera Species).

#### **Future Pressures**

Physical alteration and eutrophication of wetland ecosystems continue to be a threat to invertebrates of Great Lakes Coastal wetlands. Both can promote establishment of exotic vegetation and physical alteration can destroy plant communities altogether while changing the natural hydrology to the system. Invertebrate community composition is directly related to vegetation type and densities; changing either of these components will negatively impact the invertebrate communities.

#### **Acknowledgments**

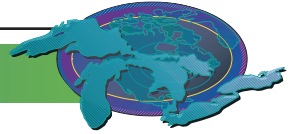
Authors: Donald G. Uzarski, Annis Water Resources Institute, Grand Valley State University, Lake Michigan Center, 740 W. Shoreline Dr., Muskegon, MI 49441. Thomas M. Burton, Departments of Zoology and Fisheries and Wildlife, Michigan State University, East Lansing, MI 48824

#### **Sources**

Environment Canada and Central Lake Ontario Conservation Authority. 2004. Durham Region Coastal Wetland Monitoring Project: Year 2 Technical Report. Downsview, ON: ECB-OR..

Uzarski, D.G., T.M. Burton and J.A. Genet. 2004. Validation and performance of an invertebrate index of biotic integrity for Lakes Huron and Michigan fringing wetlands during a period of lake level decline. *Aquatic Ecosystem Health & Management*. 7(2): 269-288.

Wilcox, D.A., J.E. Meeker, P.L. Hudson, B.J. Armitage, M.G. Black and D.G. Uzarski. 2002. Hydrologic variability and the application of index of biotic integrity metrics to wetlands: a Great Lakes evaluation. *Wetlands* 22(3): 588-615



## Coastal Wetland Fish Community Health

SOLEC Indicator #4502

Note: This indicator has not yet been put into practice. The following evaluation was constructed using input from investigators collecting fish community composition data from Great Lakes coastal wetlands over the last several years. Neither experimental design nor statistical rigor has been used to specifically address the status and trends of fish communities of coastal wetlands of the five Great Lakes.

**Assessment:** N/A

### Purpose

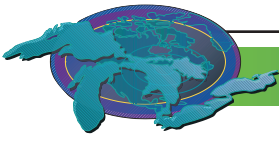
To assess the fish community composition and to infer suitability of habitat and water quality for Great Lakes coastal wetland fish communities.

### State of the Ecosystem

Development of this indicator is still in progress. Thus, the state of the ecosystem could not be determined using the wetland fish community health indicator during the last 2 years. However, progress on indicator development was substantial, and implementation of basin-wide sampling to indicate state of the ecosystem should be possible before the next SOLEC. Teams of Canadian and American researchers from several research groups (e.g. the Wetlands Research Consortium of the Great Lakes Commission, the U.S. EPA Star Grant funded Great Lakes Environmental Indicators Group in Duluth, MN, a group of Great Lakes Fishery Commission researchers led by Patricia Chow-Fraser of McMaster University, the U.S. EPA Remap group of researchers led by Tom Simon, and others) sampled large numbers of Great Lakes wetlands during the last 3 years. They have reported on an array of fish communities in Great Lakes wetlands in presentations at international meetings and in reports, but most of these data have not yet been published in refereed journals. The composition of fish communities was significantly related to plant community type within wetlands and, within plant community type, was related to amount of anthropogenic disturbance (Uzarski et al.). Uzarski et al. found no relationship suggesting that fish communities of any single Great Lake were more impacted than any other. However, of the 61 wetlands sampled in 2002 from all five lakes, Lakes Erie and Ontario tended to have more wetlands containing cattail communities (a plant community type that correlates with nutrient enrichment, Dennis Albert, personal communication), and the fish communities found in cattails tended to have lower richness and diversity than fish communities found in other vegetation types. Wetlands found in northern Lakes Michigan and Huron tended to have relatively high quality coastal wetland fish communities. The seven wetlands sampled in Lake Superior contained relatively unique vegetation types so fish communities of these wetlands were not directly compared with those of wetlands of other lakes.

John Brazner and co-workers from the U.S. EPA Laboratory in Duluth, MN sampled fishes of Green Bay, Lake Michigan, wetlands in 1990, 1991, 1995, 2002, and in 2003. They sampled three lower bay and one middle bay wetland in 2002 and 2003 and their data suggested that these sites were improving in water clarity and plant cover, and supported a greater diversity of both macrophyte and fish species, especially more centrarchid species, than they had in previous years. They also noted that the 2002, and especially 2003, year classes of yellow perch were very large. Brazner's observations suggest that the lower bay wetlands are improving slowly and the middle bay site seems to be remaining relatively stable in moderately good condition (J. Brazner, personal observation). The most turbid wetlands in the lower bay were characterized by mostly warm-water, turbidity-tolerant species such as gizzard shad, *Dorosoma cepedianum*; white bass, *Morone chrysops*; freshwater drum, *Aplodinotus grunniens*; common shiners, *Luxilus cornutus*, and common carp, *Cyprinus carpio*, while the least turbid wetlands in the upper bay were characterized by several centrarchid species, golden shiner, *Notemigonus chrysoleucas*; logperch, *Percina caprodes*; smallmouth bass, *Micropterus dolomieu*, and northern pike, *Esox lucius*. Green sunfish, *Lepomis cyanellus*, was the only important centrarchid in the lower bay in 1991, while in 1995, bluegill and pumpkinseed sunfishes, *L. macrochirus* and *L. gibbosus*, had become much more prevalent and a few largemouth bass, *M. salmoides*, were also present. There were more banded killifish, *Fundulus diaphanus*, in 1995 and 2003 compared with 1991 and white perch were very abundant in 1995, as this exotic species became dominant in the bay. The upper bay wetlands were in relatively good condition based on the fish and macrophyte communities that were observed. Although mean fish species richness was significantly lower in developed wetlands across the whole bay, differences between less developed and more developed wetlands were most pronounced in the upper bay where the highest quality wetlands in Green Bay are found (Brazner 1997).

Round gobies, *Neogobius melanostomus*, were introduced to the St. Clair River in 1990 (Jude et al. 1992), and have since spread to



all of the Great Lakes. Jude studied them in many tributaries of the Lake Huron-St. Clair River-Lake Erie corridor and found that both species (round and tubenose gobies *Proterorhinus marmoratus*) were very abundant at river mouths and colonized far upstream. They were also found at the mouth of Old Woman Creek in Lake Erie, but not within the wetland proper. Jude and Janssen's work in Green Bay wetlands showed that round gobies had not invaded three of the five sites sampled, but few were found in lower Green Bay along the sandy and rocky shoreline west of Little Tail Point.

Uzarski and Burton (unpublished) consistently collected a few round gobies from a fringing wetland near Escanaba, MI where cobbles were present. In the Muskegon River-Muskegon Lake wetland complex on the eastern shoreline, round gobies are abundant in the heavily rip-rapped harbor entrance to Lake Michigan, Muskegon Lake, and have just begun to enter the river/wetland complex on the east side of Muskegon Lake (D. Jude, personal observations; Ruetz, Uzarski, and Burton, personal observations). Based on intensive fish sampling at more than 60 sites spanning all of the Great Lakes, round gobies have not been sampled in large numbers at any wetland or been a dominant member of any wetland fish community (J. Brazner, personal observation; Uzarski et al. unpublished data). It seems likely that wetlands may be a refuge for native fishes, at least with respect to the influence of round gobies (Jude et al.).

Ruffe have never been found in high densities in coastal wetlands anywhere in the Great Lakes. In their investigation of the distribution and potential impact of ruffe on the fish community of a Lake Superior coastal wetland, Brazner et al. (1998) concluded that coastal wetlands in western Lake Superior provide a refuge for native fishes from competition with ruffe. The mudflat-preferring ruffe actually avoids wetland habitats due to foraging inefficiency in dense vegetation that characterizes healthy coastal wetland habitats. This suggests that further degradation of coastal wetlands or heavily vegetated littoral habitats could lead to increased dominance of ruffe in shallow water habitats elsewhere in the Great Lakes.

There are a number of carp introductions (see Wetland Restoration and Rehabilitation or common carp discussion) that have the potential for substantial impact on Great Lakes fish communities, including coastal wetlands. Goldfish, *Carassius auratus*, are common in some shallow habitats, and occurred along with common carp young-of-the-year in many of the wetlands we sampled along Green Bay. In addition, there are several other carp species, e.g., grass carp, *Ctenopharyngodon idella*, bighead carp *Hypophthalmichthys nobilis*, and silver carp, *Hypophthalmichthys molitrix*, that escaped aquaculture operations and are now in the Illinois River and migrating toward the Great Lakes through the Chicago Sanitary Canal. The black carp, *Mylopharyngodon piceus*, has also probably been released, but has not been recorded near the Great Lakes yet. Most of these species attain large sizes; some are planktivorous, and also eat phytoplankton, snails, and mussels, while the grass carp eats vegetation. These species represent yet another substantial threat to food webs in wetlands and nearshore habitats with macrophytes (USFWS 2002).

In 2003, Jude and Janssen (unpublished data) determined that bluntnose minnows, *Pimephales notatus*, and johnny darters, *Etheostoma nigrum*, were almost absent from lower bay wetland sites, but comprised 22% and 6% respectively, of upper bay catches. In addition, other species, usually associated with plants and/or clearer water, such as rock bass, sand shiners *Notropis stramineus*, and golden shiners *Notemigonus crysoleucus*, were also present in upper bay samples, but not in lower bay samples. In 2003, Jude and Janssen found that there were no alewife *Alosa pseudoharengus* or gizzard shad in upper Green Bay site catches when compared with lower bay wetland sites, where they composed 2.7 and 34% respectively of the catches by number.

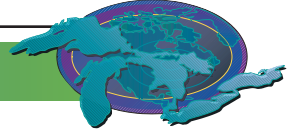
Jude and Pappas (1992) found that fish assemblage structure in Cootes Paradise, a highly degraded wetland area in Lake Ontario, was very different from other less degraded wetlands analyzed. They used ordination analyses to detect fish-community changes associated with degradation.

#### Acknowledgments

Authors: Donald G. Uzarski, Annis Water Resources Institute, Grand Valley State University, Lake Michigan Center, 740 W. Shoreline Dr., Muskegon, MI 49441. Thomas M. Burton, Departments of Zoology and Fisheries and Wildlife, Michigan State University, East Lansing, MI 48824. John Brazner, US Environmental Protection Agency, Mid-Continent Ecology Division, 6201 Congdon Blvd., Duluth, MN 55804. David Jude, School of Natural Resources and the Environment, 430 East University, University of Michigan, Ann Arbor, MI 48109

#### Sources

Brazner, J. C. 1997. Regional, habitat, and human development influences on coastal wetland and beach fish assemblages in Green Bay, Lake Michigan. *J. Great Lakes Res.* 23 (1), 36-51.

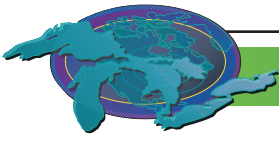


Brazner, J. C., Tanner, D. K., Jensen, D. A., Lemke, A. 1998. Relative abundance and distribution of ruffe (*Gymnocephalus cernuus*) in a Lake Superior coastal wetland fish assemblage. *J. Great Lakes Res.* 24 (2), 293-303.

Jude, D. J., Pappas, J. 1992. Fish utilization of Great Lakes coastal wetlands . *J. Great Lakes Res.* 18 (4), 651-672.

Jude, D. J., R. H. Reider, G. R. Smith. 1992. Establishment of Gobiidae in the Great Lakes basin. *Can. J. Fish. Aquat. Sci.* 49, 416-421.

Uzarski, D.G., T.M. Burton, M.J. Cooper, J. Ingram, and S. Timmermans (submitted invited paper) Fish Habitat Use Within and Across Wetland Classes in Coastal Wetlands of the Five Great Lakes: Development of a Fish Based Index of Biotic Integrity. *Journal of Great Lakes Research*



## Coastal Wetland Amphibian Diversity and Abundance

SOLEC Indicator #4504

**Assessment:** Mixed, Deteriorating

### Purpose

To directly measure species composition and relative occurrence of frogs and toads and to indirectly measure the condition of coastal wetland habitat as it relates to factors that influence the health of this ecologically important component of wetland biotic communities.

Numerous amphibian species in the Great Lakes basin, and many of these are associated with wetlands during part of their life cycle. Because frogs and toads are relatively sedentary and have semi-permeable skin, they are likely to be more sensitive to, and indicative of, local sources of wetland contamination and degradation than are most other vertebrates. Assessing species composition and relative abundance of calling frogs and toads in Great Lakes wetlands can therefore help to infer wetland habitat quality.

Geographically extensive and long-term surveys of calling amphibians are possible through coordination of volunteer naturalists skilled in the application of standardized monitoring protocols. Information about abundance, distribution and diversity of amphibians provides needed measures of their population trends, their habitat associations, and can contribute to more effective, long-term conservation strategies.

### Ecosystem Objective

To restore and maintain diversity and self-sustaining populations of Great Lakes coastal wetland amphibian communities. Breeding populations of amphibian species across their historical range should be sufficient to ensure population maintenance of each species and overall species diversity (GLWQA Annex 13).

### State of the Ecosystem

Since 1995, Marsh Monitoring Program volunteers have collected amphibian data at 469 routes across the Great Lakes basin. Thirteen amphibian species were recorded during the 1995 – 2002 period. Spring Peeper was the most frequently detected species and was commonly recorded in full chorus (Call Level Code 3) when it was encountered (Table 1). Green Frog was detected in more than half of station-years and was most often recorded at Call Level Code 1. Grey Treefrog, American Toad and Northern Leopard Frog were also common, being recorded in more than one-third of all station years. Grey Treefrog was recorded with the second highest average calling code (1.9), indicating that MMP observers usually heard several individuals with some overlapping calls at each station. Bullfrog, Chorus Frog and Wood Frog were detected in approximately one-quarter of station-years, while the remaining five species were detected infrequently by MMP surveyors and were recorded in less than 3% of station-years.

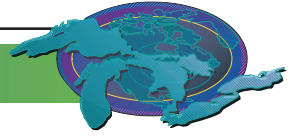
Trends in amphibian occurrence were assessed for eight species commonly detected on MMP routes (Figure 1). For each species, the annual proportion of stations with that species present at each route was calculated to derive annual indices of occurrence. Overall temporal trend in occurrence for each species was assessed by combining route-level trends in station occurrence. Statistically significant declines in occurrence trends were detected for American Toad, Chorus Frog, Green Frog and Northern Leopard Frog.

These data will serve as baseline data with which to compare future survey results. Anecdotal and research evidence suggests that wide variations in occurrence of many amphibian species at a given site is a natural and ongoing phenomenon. Additional years of data will help distinguish whether the patterns observed here (i.e., decline in American Toad, Chorus Frog, Green Frog and Northern Leopard Frog) indicate significant long-term trends or simply natural variation in population size. Further data are thus required to conclude whether Great Lakes wetlands are successfully sustaining amphibian populations. MMP amphibian data are being evaluated to determine how we can gain a better understanding of Great Lakes coastal wetlands condition.

### Future Pressures

Habitat loss and deterioration remain the predominant threat to Great Lakes amphibian populations. Many coastal and inland Great Lakes wetlands are at the lowest elevations in watersheds that support very intensive industrial, agricultural and residential development, and therefore are under pressure through polluted inflow received from their watersheds. Even more subtle impacts such as





water level stabilization, sedimentation, contaminant and nutrient inputs, climate change, and invasion of exotic species continue to degrade wetlands across the Great Lakes region.

#### **Future Activities**

Because of the sensitivity of amphibians to their surrounding environment and the growing international concern about amphibian population status, amphibians in the Great Lakes basin and elsewhere will continue to be monitored. Wherever possible, efforts should be made to maintain wetland habitats as well as associated upland areas adjacent to coastal wetlands. There is also a need to address more subtle impacts that are detrimental to wetland health such as inputs of toxic chemicals, nutrients and sediments. Restoration programs are underway for many degraded wetland areas through the work of local citizens, organizations and governments. Although significant progress has been made in this area, more work remains for many wetland areas that have yet to receive restoration efforts.

#### **Further Work Necessary**

Effective monitoring of Great Lakes amphibians requires accumulation of many years of data, using a standardized protocol, over a large geographic expanse. A reporting frequency for SOLEC of about five years would be appropriate because amphibian populations naturally fluctuate through time, and a five-year timeframe would likely be able to indicate noteworthy changes in populations. More rigorous studies will relate trends in species occurrence or relative abundance to environmental factors. Reporting will be improved with establishment of a network of survey routes that accurately represent the full spectrum of marsh habitat in the Great Lakes basin. Development of such a network is underway and three important tasks are already in progress: 1) developing the SOLEC amphibian indicator as an index for evaluating coastal wetland condition; 2) gaining precise geo-referenced locations for all MMP routes to enable future spatial analyses using remote sensing and; 3) continued recruitment efforts and training for volunteer participants. Further work is required to determine the relationship between calling codes used to record amphibian occurrence and count estimates.

#### **Acknowledgements**

Authors: Steve Timmermans and Tara Crewe, Bird Studies Canada.

The Marsh Monitoring Program is delivered by Bird Studies Canada in partnership with Environment Canada and the U.S. Environmental Protection Agency's Great Lakes National Program Office. The contributions of all Marsh Monitoring Program volunteers are gratefully acknowledged.

#### **Sources**

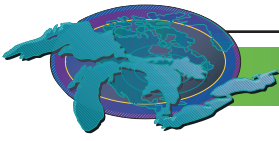
Anonymous. 2003. Marsh Monitoring Program training kit and instructions for surveying marsh birds, amphibians, and their habitats. Revised in 2003 by Bird Studies Canada. 41pp.

Timmermans, S.T.A. 2002. Quality Assurance Project Plan for implementing the Marsh Monitoring Program across the Great Lakes basin. Prepared for United States Environmental Protection Agency – Great Lakes National Program Office Assistance I.D. #GL2002-145. 31pp.

Timmermans, S.T.A., S.S. Badzinski, and K.E. Jones. 2004. The Marsh Monitoring Program annual report, 1995-2002: annual indices and trends in bird abundance and amphibian occurrence in the Great Lakes basin. Unpublished report by Bird Studies Canada. 48pp.

Weeber, R.C. 2000. The Marsh Monitoring Program Quality Assurance Project Plan. Prepared for the United States Environmental Protection Agency – Great Lakes National Program Office Assistance I.D. #GL975139-01-0. 22pp.

Weeber, R.C., and M. Valliantos (editors). 2000. The Marsh Monitoring Program 1995-1999: Monitoring Great Lakes wetlands and their amphibian and bird inhabitants. Published by Bird Studies Canada in cooperation with Environment Canada and the U.S. Environmental Protection Agency. 47pp.



Species	% Station-Years Present <sup>1</sup>	Average Calling Code
Spring Peeper	69.2	2.5
Green Frog	54.4	1.3
Grey Treefrog	39.1	1.9
American Toad	37.7	1.5
Northern Leopard Frog	31.6	1.3
Bullfrog	26.9	1.3
Chorus Frog	25.9	1.7
Wood Frog	18.6	1.5
Pickereel Frog	2.6	1.2
Blanchard's Cricket Frog	0.7	1.4
Cope's Grey Treefrog	1.7	1.4
Mink Frog	1.2	1.2
Fowler's Toad	2.6	1.4

<sup>1</sup> MMP survey stations monitored for multiple years considered as individual samples

Table 1. Frequency of occurrence (% Station-Years Present) and average Call Level Code for amphibian species detected inside Great Lakes basin MMP stations, 1995 through 2002. Average calling codes are based on the three level call code standard for all MMP amphibian surveys; Code 1 = little overlap among calls, numbers of individuals can be determined, Code 2 = some overlap, numbers can be estimated, Code 3 = much overlap, too numerous to be estimated. Source: Marsh Monitoring Program

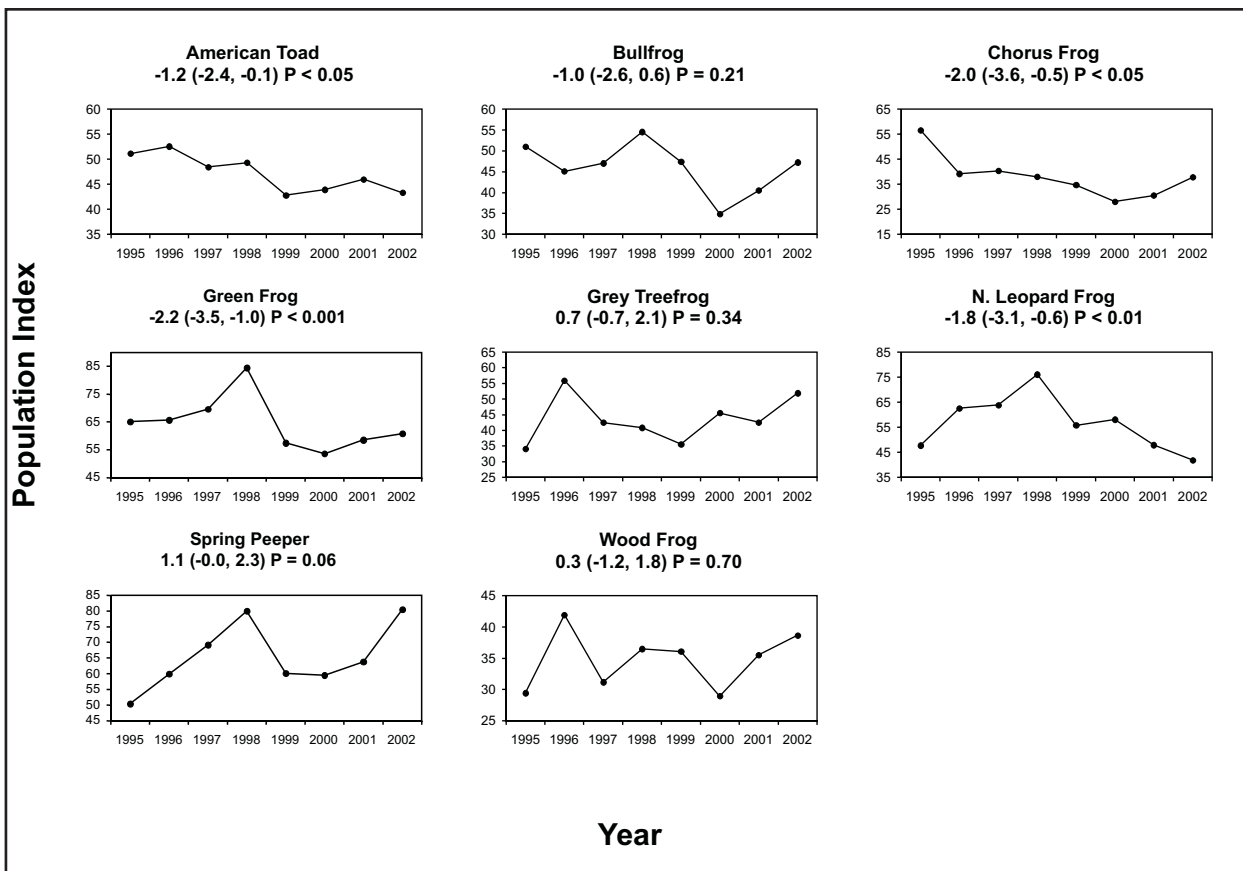
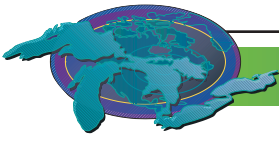


Figure 1. Trends (percent annual change) in station occurrence (population index) of eight amphibian species commonly detected at Marsh Monitoring Program routes, 1995-2002. Values in parentheses are upper and lower 95% confidence limits, respectively, for trend values given. Source: Marsh Monitoring Program



## Contaminants in Snapping Turtle Eggs

SOLEC Indicator #4506

**Assessment:** Mixed.

Data are not basin-wide; indicate improvement (decline in contaminants) and decline (exceed various contaminant level guidelines).

### Purpose

Snapping Turtles inhabit (coastal) wetlands in the Great Lakes basin, particularly the lower Great Lakes. Contaminant trends, and physiological and ecological endpoints, will be assessed in this semi-aquatic reptile. This assessment will provide a better understanding of the impact of contaminants on the physiological and ecological health of the individual turtles and wetland communities.

While other Great Lakes wildlife species may be more sensitive to contaminants than Snapping Turtles, there are few other species that are as long-lived, as common year-round, inhabit such a wide variety of habitats, and yet are limited in their movement among wetlands. Snapping Turtles are also at the top in the aquatic food web and bioaccumulate contaminants. Plasma and egg tissues offer a nondestructive method to monitor recent exposure to chemicals as well as an opportunity for long-term contaminant and health monitoring. Since they inhabit coastal wetlands throughout the lower Great Lakes basin, they allow for multi-site comparisons on a temporal and spatial basis. Consequently, Snapping Turtles are a very useful biological indicator species of local wetland contaminants and the effects of these contaminants on wetland communities throughout the lower Great Lakes basin.

### Ecosystem Objective

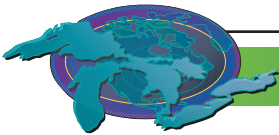
This indicator supports Annexes 1, 2, 11 and 12 of the GLWQA.

### State of the Ecosystem

For more than 20 years, the Canadian Wildlife Service (CWS) has periodically collected Snapping Turtle eggs and examined the species' reproductive success in relation to contaminant levels on a research basis. More recently (2001–2005), CWS is examining the health of Snapping Turtles relative to contaminant exposure in Canadian AOCs of the lower Great Lakes basin. The work by the CWS has shown that contaminants in Snapping Turtle eggs change over time and among sites on the Great Lakes basin, with significant differences between contaminated and reference sites occurring (Bishop *et al.*, 1996, 1998). Snapping Turtle eggs collected at two Lake Ontario sites (Cootes Paradise and Lynde Creek) had the greatest concentrations of polychlorinated dioxins and number of furans (Bishop *et al.* 1996, 1998). Eggs from Cranberry Marsh (Lake Ontario) and two Lake Erie sites (Long Point and Rondeau Provincial Park) had similar levels of PCBs and organochlorines (Bishop *et al.* 1996, 1998). Eggs from Akwesasne (St. Lawrence River) contained the greatest level of PCBs (Bishop *et al.* 1998). From 1984 to 1990/91, levels of PCBs and DDE increased significantly in eggs from Cootes Paradise and Lynde Creek, and levels of dioxins and furans decreased significantly at Cootes Paradise (Struger *et al.* 1993; Bishop *et al.* 1996). Eggs with the greatest contaminant levels also showed the poorest developmental success (Bishop *et al.* 1991, 1998). Rates of abnormal development of Snapping Turtle eggs from 1986–1991 were highest at all four Lake Ontario sites compared to other sites studied (Bishop *et al.* 1998).

From 2001 to 2003, CWS collected Snapping Turtle eggs at or near seven Areas of Concern (AOCs): Detroit River, Hamilton Harbour, Niagara River (Ontario), St. Clair River, St. Lawrence River (Ontario), Toronto, and Wheatley Harbour AOCs, as well as two reference sites. Mean sum PCBs varied considerably throughout the lower Great Lakes, ranging from 0.02 µg/g at Algonquin Park (reference site) to 1.76 µg/g at Hamilton Harbour (Grindstone Creek). Sum PCB levels were highest at Hamilton Harbour (Grindstone Creek), followed by the second site at Hamilton Harbour (Cootes Paradise), then Lyons Creek (Niagara River) and Turkey Creek (Detroit River) (Fig. 1). Dioxin equivalents of sum PCBs in eggs from the Detroit River, Wheatley Harbour, and St. Clair River AOCs, and *p,p'*-DDE levels in eggs from the Wheatley Harbour and the Detroit River AOCs, exceeded the Canadian Environmental Quality Guidelines; sum PCBs in eggs from the Detroit River and Wheatley Harbour AOCs exceeded partial restriction guidelines for consumption (de Solla and Fernie, 2004). However, there is evidence that PCB levels in Snapping Turtle eggs have been declining at the inland reference site of Algonquin Park (1981 – 2003) and the heavily contaminated Hamilton Harbour AOC (1984 to 2003).

Flame retardants, or polybrominated diphenyl ethers (PBDEs), are one of the emerging chemicals of concern as they are bioaccumulative and affect wildlife and human health. Sum PBDE concentrations varied and were an order of magnitude lower than sum PCBs in Snapping Turtle eggs collected from the seven AOCs (2001 – 2003). Sum PBDE levels were lowest at Algonquin Park (6.1 ng/g



sum PDBE), where airborne deposition is likely the main contaminant source, and greatest at the Hamilton Harbour (Cootes Paradise; 67.6 ng/g) and Toronto (Humber River; 107.0 ng/g) AOCs, indicative of urban areas likely being the main source of PBDEs.

### Pressures

Future pressures for this indicator include all sources of toxic contaminants that currently have elevated concentrations (e.g. PCBs, dioxins), as well as contaminants whose concentrations are expected to increase in Great Lakes wetlands (e.g. PAHs, polybrominated diphenyl ethers or flame retardants). Snapping Turtle populations face additional pressures from harvesting of adult turtles, road-side killings during the nesting season in June, and habitat destruction.

### Management Implications

The contaminants measured by CWS are persistent and bioaccumulative, with diet being the primary source of exposure. Thus, the contamination observed in the turtle eggs is present throughout the aquatic food web. Although commercial collection of Snapping Turtles has ceased, collection for private consumption persists, and so requires implementation of consumption restrictions at selected AOCs. Currently, only eggs are routinely sampled for contaminants, but body burdens of females could be estimated using egg burdens, and thus used for determining consumption guidelines. At some AOCs (i.e., Niagara [Lyons Creek], Hamilton Harbour), there are localized sediment sources of contaminants that may be rehabilitated through dredging or capping. Mitigation of contaminant sources should eventually reduce contaminant burdens in Snapping Turtles.

### Acknowledgment:

Authors: Kim Fernie and Shane de Solla, Canadian Wildlife Service, Environment Canada, Burlington, ON. Dr. Fernie can be contacted at [kim.fernie@ec.gc.ca](mailto:kim.fernie@ec.gc.ca). Special thanks to Drs. Robert Letcher, Shugang Chu, and Ken Drouillard for chemical analyses, particularly of the PBDEs. Thanks also go to other past and present CWS staff (Burlington, Downsview, National Wildlife Research Centre), the wildlife biologists not associated with the CWS, and private landowners.

### Sources

Bishop, C.A., R.J. Brooks, J.H. Carey, P. Ng, R.J. Norstrom, D.R.S. Lean. 1991. The case for a cause-effect linkage between environmental contamination and development in eggs of the common Snapping Turtle (*Chelydra s. serpentina*) from Ontario, Canada. *Journal of Toxicology Environmental Health* 33:521-547.

Bishop, C.A., P. Ng, R.J. Norstrom, R.J. Brooks, K.E. Pettit. 1996. Temporal and geographic variation of organochlorine residues in eggs of the common Snapping Turtle (*Chelydra serpentina serpentina*) (1981-1991) and comparisons to trends in the herring gull (*Larus argentatus*) in the Great Lakes basin in Ontario, Canada. *Archives of Environmental Contamination & Toxicology*. 31:512-524.

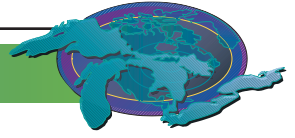
Bishop, C.A. P Ng, K.E. Pettit, S.W. Kennedy, J.J. Stegeman, R.J. Norstrom, R.J. Brooks. 1998. Environmental contamination and developmental abnormalities in eggs and hatchlings of the common Snapping Turtle (*Chelydra serpentina serpentina*) from the Great Lakes-St. Lawrence River basin (1989-1991). *Environmental Pollution*. 101:143-156.

de Solla, S.R., Fernie, K.J. In Press. Characterization of contaminants in Snapping Turtles (*Chelydra serpentina*) from Canadian Lake Erie Areas of Concern: St. Clair, Detroit River, and Wheatley Harbour. *Environmental Pollution*.

Canadian Wildlife Service, Environment Canada. Database of Contaminants. Unpublished data.

Fernie, Kim. Canadian Wildlife Services. Unpublished data.

Struger J., J.E. Elliott, C.A. Bishop, M.E. Obbard, R.J. Norstrom, D.V. (Chip) Weseloh, M. Simon, P. Ng. 1993. Environmental contaminants in eggs of the common Snapping Turtles (*Chelydra serpentina serpentina*) from the Great Lakes- St. Lawrence River Basin of Ontario, Canada (1981, 1984).



### Further Work Necessary

The contaminant status of Snapping Turtles should be monitored on a regular basis across the Great Lakes basin where appropriate. Once the usefulness of the indicator is confirmed, it will be necessary to foster a complementary U.S. program to interpret basin-wide trends. This species offers an excellent opportunity to monitor contaminant concentrations in coastal wetland populations. Newly emerging contaminants also need to be examined in the long-term monitoring program. As with all long-term monitoring programs, and for any indicator species used to monitor persistent bioaccumulative contaminants, standardization of contaminant data is necessary for examining temporal trends or combining data from different sources.

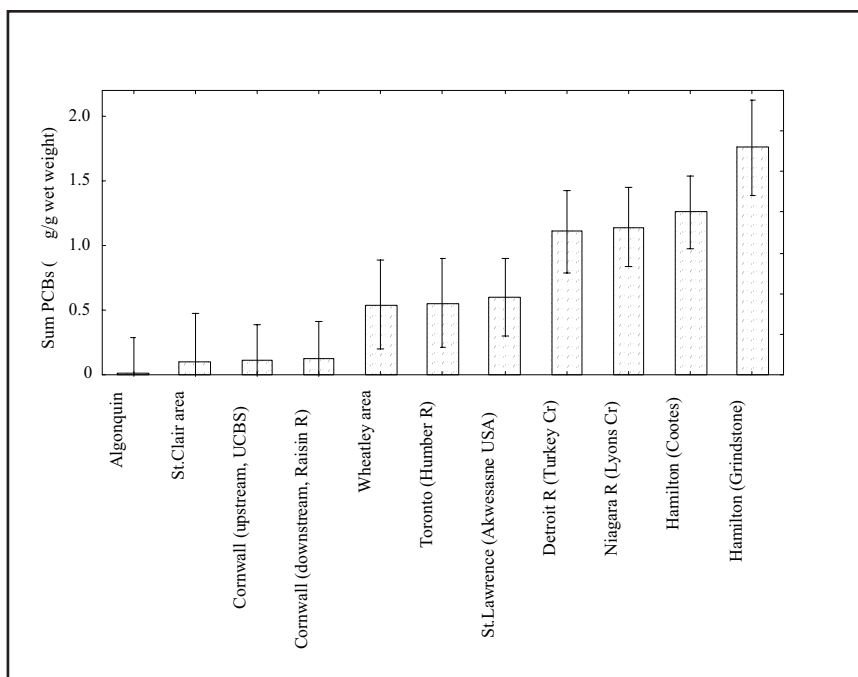
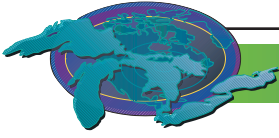


Figure 1. Sum PCB concentrations in Snapping Turtle eggs from various Canadian locations throughout the lower Great Lakes Basin, 2001 through 2003. Means  $\pm$  standard errors are presented.



## Wetland-Dependent Bird Diversity and Abundance

SOLEC Indicator #4507

**Assessment:** Mixed, Deteriorating

### Purpose

To assess wetland bird species composition and relative abundance, and to infer condition of coastal wetland habitat as it relates to factors that influence the biological condition of this ecologically and culturally important component of wetland communities.

Assessments of wetland-dependent bird diversity and abundance in the Great Lakes are used to evaluate health and function of coastal and inland wetlands. Breeding birds are valuable components of Great Lakes wetlands and rely on physical, chemical and biological condition of their habitats, particularly during breeding. Presence and abundance of breeding individuals therefore provides a valuable source of information about wetland status and population trends. Because several wetland-dependent birds are believed to be at risk due to continuing loss and degradation of their habitats, the combination of long-term monitoring data and analysis of habitat characteristics can help to assess how well Great Lakes coastal wetlands are able to support birds and other wetland-dependent wildlife.

Geographically extensive and long-term surveys of wetland-dependent birds are possible through coordination of volunteer participants skilled in the application of standardized monitoring protocols. Information about abundance, distribution and diversity of marsh birds provides needed measures of their population trends, their habitat associations, and can contribute to more effective, long-term conservation strategies.

### Ecosystem Objective

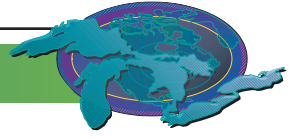
To restore and maintain diversity and self-sustaining populations of Great Lakes coastal wetland bird communities. Breeding populations of bird species across their historical range should be sufficient to ensure population maintenance of each species and overall species diversity. (GLWQA Annex 2).

### State of the Ecosystem

From 1995 through 2002, 53 species of birds that use marshes (wetlands dominated by non-woody emergent plants) for feeding, nesting or both were recorded by Marsh Monitoring Program (MMP) volunteers at 419 routes throughout the Great Lakes basin. Among bird species that typically feed in the air above marshes, Tree Swallow and Barn Swallow were the two most common. Red-winged Blackbird was the most commonly recorded marsh nesting species, followed by Swamp Sparrow, Common Yellowthroat and Yellow Warbler.

With nine years of data collected across the Great Lakes basin, the MMP is still in its infancy as a long-term population monitoring program. Bird species occurrence, abundance, activity and likelihood of being observed vary naturally among years and within seasons. Population indices and trends (i.e., average annual percent change in population index) are presented for several bird species recorded at Great Lakes MMP routes, 1995 through 2002 (Figure 1). Species with significant basin-wide declines were Least Bittern, Black Tern, Marsh Wren, undifferentiated American Coot/Common Moorhen (calls of these two species are difficult to distinguish from one another), Pied-billed Grebe, Red-winged Blackbird, and Virginia Rail (Figure 1). Statistically significant basin-wide population increases were observed for Willow Flycatcher (not shown), Common Yellowthroat, and Mallard. Barn Swallow populations did not show a significant trend (Figure 1). The observed declines in Least Bittern, Black Tern, American Coot/Common Moorhen, Marsh Wren, Pied-billed Grebe, and Virginia Rail, which use wetland habitats almost exclusively, combined with increases in some wetland edge and generalist species (e.g., Common Yellowthroat, Willow Flycatcher) suggest possible links to wetland habitat conditions.

To investigate whether marsh bird trends are linked to habitat conditions, water levels of the Great Lakes (another SOLEC indicator) were used as a proxy for water conditions throughout the basin, and comparisons were made between trends in mean annual May-July water levels of the Great Lakes and trends in wetland bird annual abundance indices. In coastal wetlands of Lakes Erie, and Michigan-Huron, population trends of American Coot, Least Bittern, Marsh Wren, Pied-billed Grebe, Sora, Swamp Sparrow, and Virginia Rail were positively correlated with water levels, and thus seemed to track fluctuations in Great Lake water levels. American Bittern, Black Tern and Common Moorhen population abundance did not correlate well with water levels. Differences in



habitats, regional population densities, timing of survey visits, annual weather variability, and other additional factors likely interplay with water levels to explain variation in species-specific bird populations.

#### **Future Pressure**

Future pressures on wetland-dependent birds will likely include continuing loss and degradation of important breeding habitats through wetland loss, water level stabilization, sedimentation, contaminant and nutrient inputs, and invasion of exotic plants and animals.

#### **Future Activities**

Wherever possible, efforts should be made to maintain high quality wetland habitats and adjacent upland areas. There is also a need to address more subtle impacts that are detrimental to wetland health such as water level stabilization, invasive species and inputs of toxic chemicals, nutrients and sediments. Restoration programs are underway for many degraded wetland areas through the work of local citizens, organizations and governments. Although significant progress has been made, further conservation and restoration work is needed.

#### **Further Work Necessary**

Monitoring will continue across the Great Lakes basin. Continued monitoring of at least 100 routes through 2006 is projected to provide good resolution for most of the wetland-dependent birds recorded by the MMP. Recruitment and retention of program participants will therefore continue to be a high priority. Further work is necessary to establish endpoints and acceptable thresholds for bird diversity and abundance. Work is underway to ascertain marsh bird habitat associations using MMP bird and habitat data. Three additional important tasks are already in progress: 1) developing SOLEC wetland bird indicator as an index for evaluating coastal wetland health; 2) gaining precise geo-referenced locations for all MMP routes to enable future spatial analyses using remote sensing, and; 3) continued recruitment efforts and training for volunteer participants. Assessments of relationships among count indices, bird population parameters, and critical environmental factors are also needed.

Although more frequent updates are possible, reporting trend estimates every five or six years is most appropriate for this indicator. A variety of efforts are underway to enhance reporting breadth and efficiency.

#### **Acknowledgements**

Authors: Steve Timmermans and Tara Crewe, Bird Studies Canada

The Marsh Monitoring Program is delivered by Bird Studies Canada in partnership with Environment Canada and the United States Environmental Protection Agency – Great Lakes National Program Office. The contributions of all Marsh Monitoring Program volunteers are gratefully acknowledged.

#### **Sources**

Anonymous. 2003. Marsh Monitoring Program training kit and instructions for surveying marsh birds, amphibians, and their habitats. Revised in 2003 by Bird Studies Canada. 41pp.

Timmermans, S.T.A. 2002. Quality Assurance Project Plan for implementing the Marsh Monitoring Program across the Great Lakes basin. Prepared for United States Environmental Protection Agency – Great Lakes National Program Office Assistance I.D. #GL2002-145. 31pp.

Timmermans, S.T.A., S.S. Badzinski, and K.E. Jones. 2004. The Marsh Monitoring Program annual report, 1995-2002: annual indices and trends in bird abundance and amphibian occurrence in the Great Lakes basin. Unpublished report by Bird Studies Canada. 48pp.

Weeber, R.C. 2000. The Marsh Monitoring Program Quality Assurance Project Plan. Prepared for the United States Environmental Protection Agency – Great Lakes National Program Office Assistance I.D. #GL975139-01-0. 22pp.

Weeber, R.C., and M. Valliantos (editors). 2000. The Marsh Monitoring Program 1995-1999: Monitoring Great Lakes wetlands and their amphibian and bird inhabitants. Published by Bird Studies Canada in cooperation with Environment Canada and the U.S. Environmental Protection Agency. 47pp.

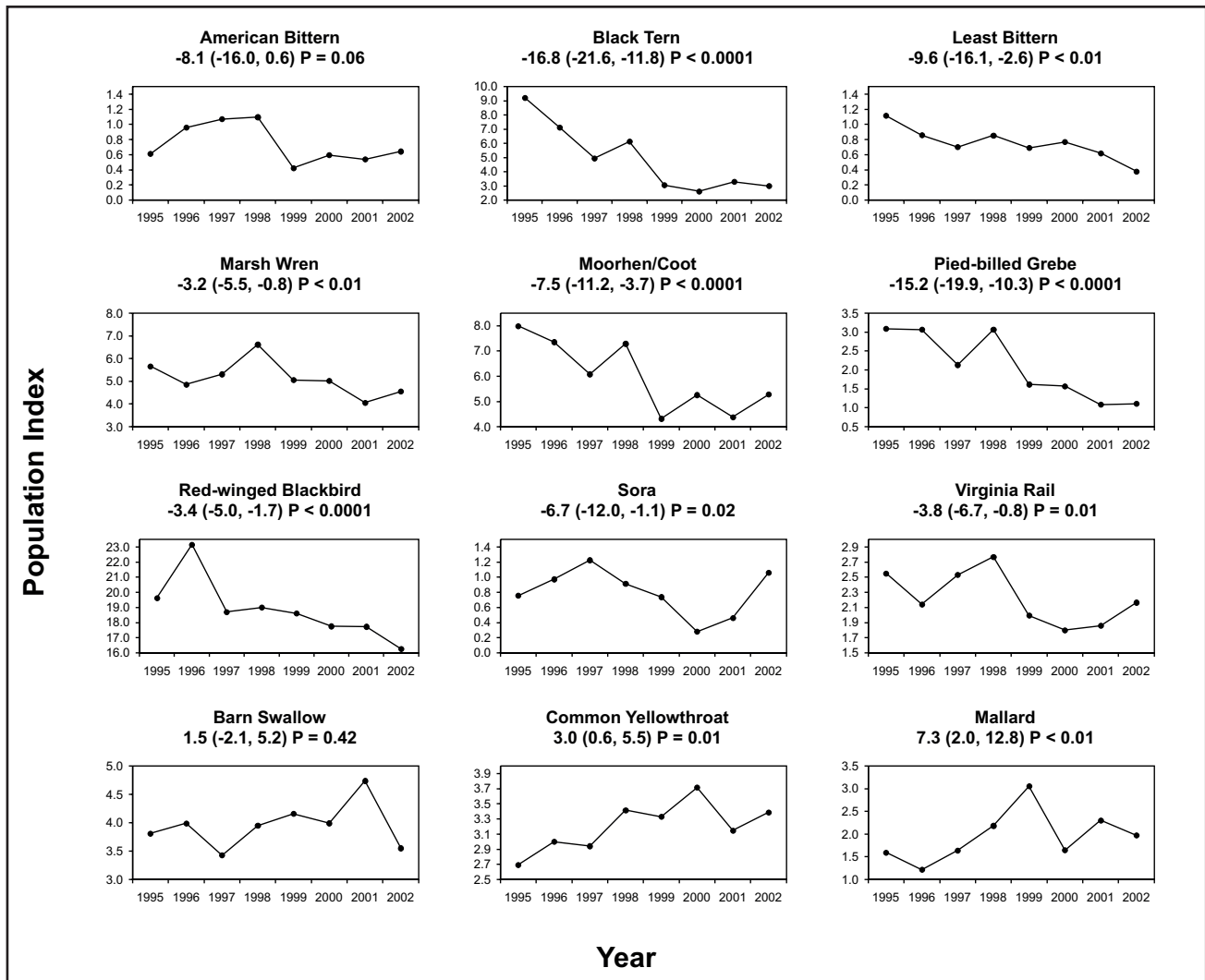
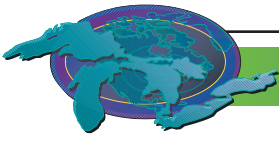
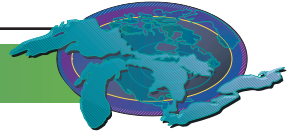


Figure 1. Trends (percent annual change) in relative abundance (population index) of marsh nesting and aerial foraging bird species detected at Marsh Monitoring Program routes, 1995-2002. Values in parentheses are upper and lower 95% confidence limits, respectively, for trend values given. Source: Marsh Monitoring Program





## Coastal Wetland Area by Type

SOLEC Indicator #4510

**Assessment:** Mixed, deteriorating

### Purpose

To assess the periodic changes in area (particularly losses) of coastal wetland types, taking into account natural lake level variations.

### Ecosystem Objective

Maintain total areal extent of Great Lakes coastal wetlands, ensuring adequate representation of coastal wetland types across their historical range. (GLWQA Annexes 2 and 13)

### State of the Ecosystem

Wetlands continue to be lost and degraded, yet the ability to track and determine the extent and rate of this loss in a standardized way is not yet feasible.

In an effort to estimate the current extent of coastal wetlands in the basin, the Great Lakes Coastal Wetland Consortium (GLCWC) recently coordinated completion of a binational coastal wetland database. The project involved building from existing Canadian and U.S. coastal wetland databases (Environment Canada and Ontario Ministry of Natural Resources 2003, Herdendorf et al. 1981a-f), and incorporating additional auxiliary Federal, Provincial and State data to create a more complete, digital Geographic Information System (GIS) vector database. All coastal wetlands in the database were also classified using a Great Lakes hydrogeomorphic coastal wetland classification system (Albert et al. submitted). The GIS database provides the first spatially explicit seamless binational summary of coastal wetland distribution in the Great Lakes system. Coastal wetlands totaling 216,545 ha have been identified within the Great Lakes and connecting rivers up to Cornwall, Ontario (Figure 1).

Despite significant loss of coastal wetland habitat in some regions of the Great Lakes, the lakes and connecting rivers still support a diversity of wetland types. Barrier protected coastal wetlands are a prominent feature in the upper Great Lakes, accounting for over 50,000 ha of the identified coastal wetland area in Superior, Huron and Michigan (Figure 2). Lake Erie, supports 25,127 ha of coastal wetland with protected embayment wetlands accounting for over one third of the total area (Figure 2). In Lake Ontario, barrier protected and drowned rivermouth coastal wetlands account for 14,164 ha, approximately two thirds of the total coastal wetland area.

Connecting rivers within the Great Lakes system also support a diverse and significant quantity of wetlands (Figure 3). The St. Clair River delta, occurs where the St. Clair River outlets into Lake St. Clair and is the most prominent single wetland feature accounting for over 13,000 ha. The Upper St. Lawrence River also supports a large area of wetland habitats that are typically numerous small embayment and drowned rivermouth wetlands associated with the Thousand Island region and St. Lawrence River shoreline.

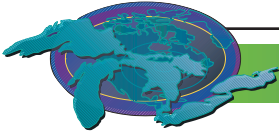
The GLCWC database represents an important step in establishing a baseline for monitoring and reporting on Great Lakes coastal wetlands including extent and other indicators. However, due to existing data limitations, estimates of coastal wetland extent, particularly for the upper Great Lakes are acknowledged to be incomplete. Affordable and accurate remote sensing methodologies are required to complete the baseline and begin monitoring change in wetland area by type in the future. Other GLCWC-guided research efforts are underway to assess the use of various remote sensing technologies in addressing this current limitation.

### Pressures

There are many stressors which have and continue to contribute to the loss and degradation of coastal wetland area. These include: filling, dredging and draining for conversion to other uses such as urban, agricultural, marina, and cottage development; shoreline modification; water level regulation; sediment and nutrient loading from watersheds; adjacent land use; invasive species, particularly exotics; and climate variability and change. The natural dynamics of wetlands must be considered in addressing coastal wetland stressors. Global climate variability and change have the potential to amplify the dynamics by reducing water levels in the system in addition to changing seasonal storm intensity and frequency, water level fluctuations and temperature.

### Management Implications

Many of the pressures result from direct human actions, and thus, with proper consideration of the impacts, can be reduced. Several



organizations and programs have been designed and implemented to help reduce the trend toward wetland loss and degradation.

Because of growing concerns around water quality and supply, which are key Great Lakes conservation issues, and the role of wetlands in flood attenuation, nutrient cycling and sediment trapping, wetland changes will continue to be monitored closely. Providing accurate useable information to decision-makers from government to private landowners is critical to successful stewardship of the wetland resource.

#### Further Work Necessary

Development of improved, accessible, and affordable remote sensing technologies and information, along with concurrent monitoring of other SOLEC indicators will aid in implementation and continued monitoring and reporting of this indicator.

The difficult decisions on how to address human-induced stressors causing wetlands loss have been considered for some time. Several organizations and programs continue to work to reverse the trend, though much work remains. A better understanding of wetland functions, through additional research and implementation of biological monitoring within coastal wetlands, will help ensure that wetland quality is maintained in addition to areal extent. An educated public is critical to ensuring that wise decisions about the stewardship of the Great Lakes basin ecosystem are made.

#### Acknowledgements

Authors: Joel Ingram and Lesley Dunn, Canadian Wildlife Service, Environment Canada; Dennis Albert, Michigan Natural Features Inventory, Michigan State University Extension.

Contributors: Krista Holmes and Nancy Patterson, Canadian Wildlife Service, Environment Canada; Laura Simonson, Water Resources Discipline, United States Geological Survey; Tom Rayburn, Great Lakes Commission.

#### Sources

Albert, D. A., D.A. Wilcox, J.W. Ingram, and T. A. Thompson, and D. A. Wilcox. Submitted. Hydrogeomorphic Classification for Great Lakes Coastal Wetlands. *Journal of Great Lakes Research*.

Environment Canada and Ontario Ministry of Natural Resources. March 2003. *The Ontario Great Lakes Coastal Wetland Atlas: A Summary of Information (1983 - 1997)*, Canadian Wildlife Service, Ontario Region, Environment Canada, Conservation and Planning Section-Lands and Waters Branch; and Natural Heritage Information Center, Ontario Ministry of Natural Resources.

Herdendorf, C. E., Hartley, S. M., and Barnes, M. D. (eds.). 1981a. *Fish and wildlife resources of the Great Lakes coastal wetlands within the United States, Vol. 1: Overview*. U.S. Fish and Wildlife Service, Washington, DC. FWS/OBS-81/02-v1.

\_\_\_\_\_, Hartley, S. M., and Barnes, M. D. (eds.). 1981b. *Fish and wildlife resources of the Great Lakes coastal wetlands within the United States, Vol. 2: Lake Ontario*. U.S. Fish and Wildlife Service, Washington, DC. FWS/OBS-81/02-v2.

\_\_\_\_\_, Hartley, S. M., and Barnes, M. D. (eds.). 1981c. *Fish and wildlife resources of the Great Lakes coastal wetlands within the United States, Vol. 3: Lake Erie*. U.S. Fish and Wildlife Service, Washington, DC. FWS/OBS-81/02-v3.

\_\_\_\_\_, Hartley, S. M., and Barnes, M. D. (eds.). 1981d. *Fish and wildlife resources of the Great Lakes coastal wetlands within the United States, Vol. 4: Lake Huron*. U.S. Fish and Wildlife Service, Washington, DC. FWS/OBS-81/02-v4.

\_\_\_\_\_, Hartley, S. M., and Barnes, M. D. (eds.). 1981e. *Fish and wildlife resources of the Great Lakes coastal wetlands within the United States, Vol. 5: Lake Michigan*. U.S. Fish and Wildlife Service, Washington, DC. FWS/OBS-81/02-v5.

\_\_\_\_\_, Hartley, S. M., and Barnes, M. D. (eds.). 1981f. *Fish and wildlife resources of the Great Lakes coastal wetlands within the United States, Vol. 6: Lake Superior*. U.S. Fish and Wildlife Service, Washington, DC. FWS/OBS-81/02-v6.

Last Revised July 14, 2004

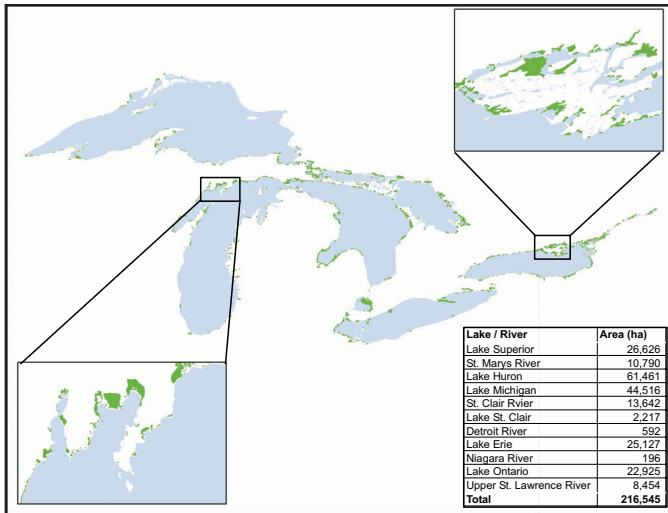
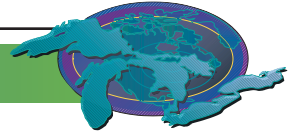


Figure 1. Great Lakes coastal wetland distribution and total area by lake and river.

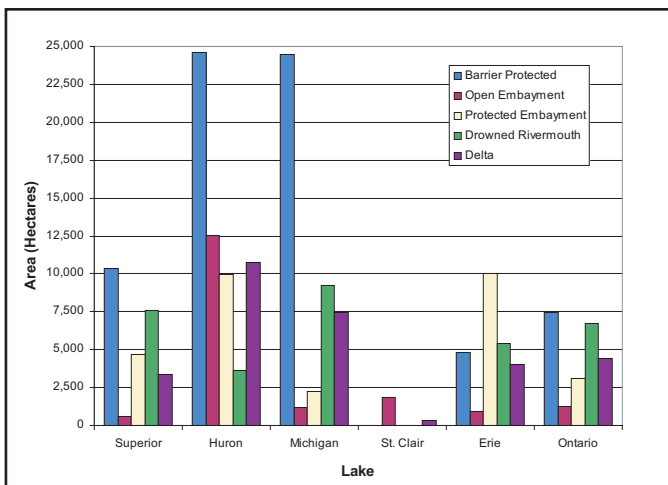


Figure 2. Coastal wetland area by geomorphic type within lakes of the Great Lakes system.

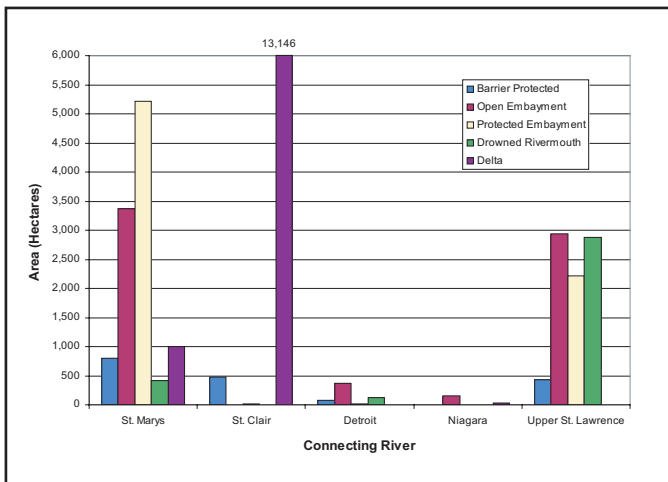
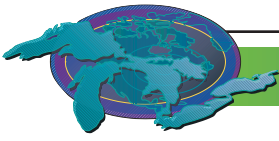


Figure 3. Coastal wetland area by geomorphic type within connecting rivers of the Great Lakes system.



## Ice Duration on the Great Lakes

SOLEC Indicator #4858

*This indicator report is from 2002.*

### Assessment: Mixed Deteriorating (with respect to climate change)

#### Purpose

To assess the ice duration and thereby the temperature and accompanying physical changes to each lake over time, in order to infer the potential impact of climate change.

#### Ecosystem Objective

This indicator is used as a potential assessment of climate change, particularly within the Great Lakes basin. Changes in water and air temperatures will influence ice development on the Lakes and, in turn, affect coastal wetlands, nearshore aquatic environments, and inland environments.

#### State of the Ecosystem

Air temperatures over a lake are one of the few factors that control the formation of ice on that surface. Colder winter temperatures increase the rate of heat released by the lake, thereby increasing the freezing rate of the water. Milder winter temperatures have a similar controlling effect, only the rate of heat released is slowed and the ice forms more slowly. Globally, some inland lakes appear to be freezing up at later dates, and breaking-up earlier, than the historical average, based on a study of 150 years of data (Magnuson *et al.*, 2000). These trends, as the authors put it, add to the evidence that the earth has been in a period of global warming for at least the last 150 years.

The freezing and thawing of lakes is a very important aspect to many aquatic and terrestrial ecosystems. Many fish species rely on the ice to give their eggs protection against predators during the late part of the ice season. Nearshore ice has the ability to change the shoreline as it can encroach upon the land during winter freeze-up times. Even inland systems are affected by the amount of ice that forms, especially within the Great Lakes basin. Less ice on the Great Lakes allows for more water to evaporate and be spread across the basin in the form of snow. This can have an effect on the foraging animals (like deer), who, need to dig through snow during the winter in order to obtain food.

Observations of the Great Lakes data showed no real conclusive trends with respect to the date of freezeup or break-up. A reason for this could be that due to the sheer size of the lakes, it wasn't possible to observe the whole lake during the winter season (at least before satellite imagery), and therefore only regional observations were made (inner bays and ports). However, there was enough data collected from the ice charts to make a statement concerning the overall ice cover during the season. There appears to be a decrease in the maximum ice cover per season over the last thirty years (figure 1).

The trends on each of the five lakes show that during this time span the maximum amount of ice forming each year has been decreasing, which, in-fact, can be correlated to the average ice cover per season observed for the same time duration (figure 2). Between the 1970's and 1990's there was at least a ten percent decline in the maximum ice cover on each lake, and almost as much as 18% in some cases, with the greatest decline occurring during the 1990's. Since a complete freeze-up did not occur on all the Great Lakes, a series of inland lakes (known to freeze every winter) in Ontario were looked at to see if there was any similarity to the results in the previous studies. Data from Lake Nipissing and Lake Ramsey were plotted (Figure 3) based on the ice-on date (complete freeze-over date) and the break-up date (ice-off date). As it turns out, the freeze-up date for Lake Nipissing appears to have the same trend as the other global inland lakes: freezing over later in the year. Lake Ramsey however, seems to be freezing over earlier in the season. The ice-off date for both however, appear to be increasing, or occurring at later dates in the year. These results contradict what is said to be occurring with other such lakes in the Northern Hemisphere (see Magnuson *et al.*, 2000).

#### Future Pressures

Based on the results of figure 1 and table 1, it seems that ice formation of the Great Lakes should continue to decrease in total cover, if the predictions on global atmospheric warming are true. Milder winters will have a drastic effect on how much of the lakes are covered in ice, which in turn, will have an effect on many aquatic and terrestrial ecosystems that rely on lake ice for protection and



food acquisition. However, because only a small number of data sets were collected and analyzed for this study, this is not conclusive. To reach a level of significance that would be considered acceptable, more data on lake ice formation would have to be gathered.

#### Future Activities

Increased winter and summer air temperatures appear to be the greatest influence on ice formation. Currently there are certain protocols, on a global scale, that are being introduced in order to reduce the emission of greenhouse gases. The most substantial of these is the Kyoto Protocol, which looks at decreasing the emissions of greenhouse gases by 2008, with a large amount of attention on decreasing carbon dioxide. Countries that have not agreed to adhere to this protocol are taking other measures to reduce their emissions.

#### Further Work Necessary

While the data for the Great Lakes is easily obtained from 1972-present, smaller inland lakes, which may be affected by climate change at a faster rate, should be looked into. As much historical information that is available should be obtained. The more data that is received will increase the statistical significance of the results, and therefore have greater meaning in the end. It would be convenient for the results to be reported every four to five years (at least for the Great Lakes), and quite possibly a shorter time span for any new inland lake information. It may also be feasible to subdivide the Great Lakes into bays and inlets, etc., in order to get an understanding of what is occurring in nearshore environments.

#### Acknowledgments

Author: Gregg Ferris, Environment Canada Intern, Downsview, ON.  
All data analyzed and charts created by the author.

#### Sources

Magnuson, J.J., D.M. Robertson, B.J. Benson, R.H. Wynne, D.M. Livingston, T. Arai, R.A. Assel, R.G. Barry, V. Carad, E. Kuusisto, N.G. Granin, T.D. Prowse, K.M. Stewart, and V.S. Vuglinski. 2000. Historical Trends in Lake and River Ice Cover in the Northern Hemisphere. *Science* 289(Sept. 8): 1743-1746.

Ice charts obtained from the National Oceanic and Atmospheric Administration (NOAA) and the Canadian Ice Service (CIS).

Data for Lake Nipissing and Lake Ramsey obtained from Walter Skinner, Climate and Atmospheric Research, Environment Canada-Ontario Region.

Lake	1970-1979	1980-1989	1990-1999	Change from 1970s to 1990s
Erie	94.5	90.8	77.3	-17.2
Huron	71.3	71.7	61.3	-10.0
Michigan	50.2	45.6	32.4	-17.8
Ontario	39.8	29.7	28.1	-11.7
Superior	74.5	73.9	62.0	-12.6

Table 1. Mean Ice coverage, in percent, during the corresponding decade.

Source: National Oceanic and Atmospheric Administration

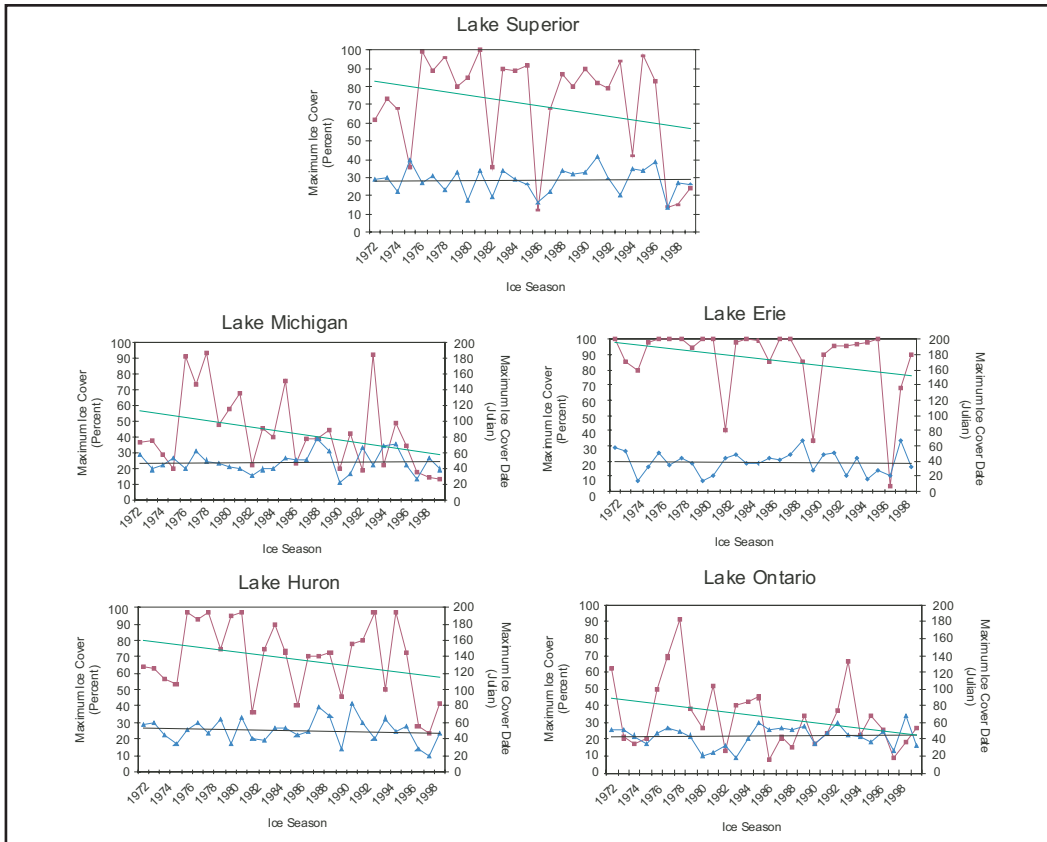
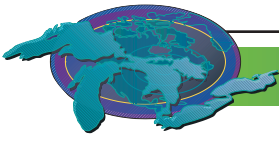


Figure 1. Trends of maximum ice cover and the corresponding date on the Great Lakes, 1972-2000. Source: National Oceanic and Atmospheric Administration

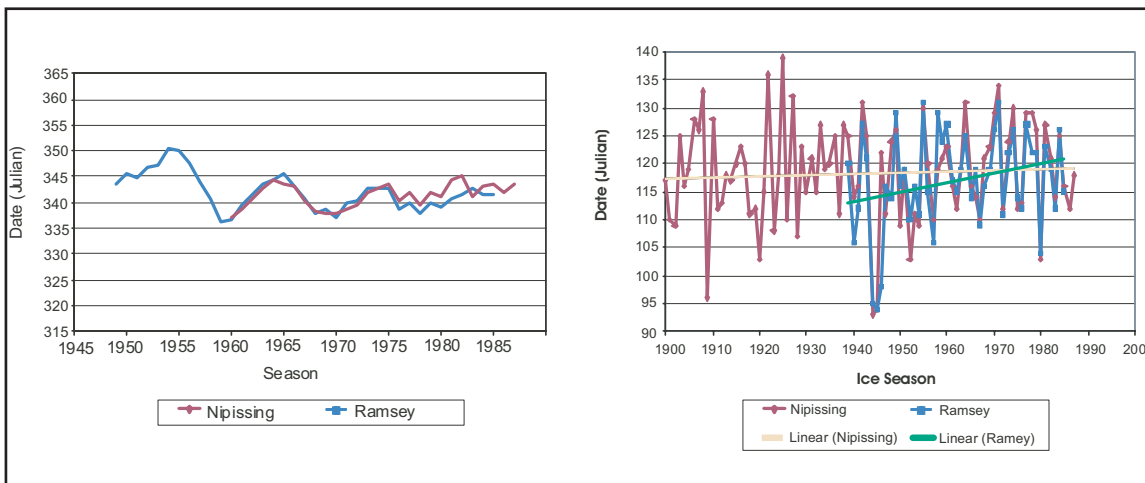
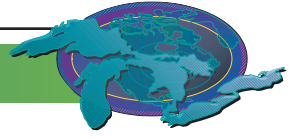


Figure 2. Ice-on and ice-off dates for Lake Nipissing (black dashed line) and Lake Ramsey (pink solid line). Data were smoothed using a 5-year moving average. Source: Climate and Atmospheric Research, Environment Canada



## Effect of Water Level Fluctuations

SOLEC Indicator #4861

*This indicator report is from 2002.*

### Assessment: Mixed

Data are available for water level fluctuations for all lakes. A comparison of wetland vegetation along regulated Lake Ontario to vegetation along unregulated Lakes Michigan and Huron provides insight into the impacts of water level regulation.

### Purpose

The purpose of this indicator is to examine the historic water levels in all the Great Lakes, and compare these levels and their effects on wetlands with post-regulated levels in Lakes Superior and Ontario, where water levels have been regulated since about 1914 and 1959, respectively. Naturally fluctuating water levels are known to be essential for maintaining the ecological health of Great Lakes shoreline ecosystems, especially coastal wetlands. Thus, comparing the hydrology of the Lakes serves as an indicator of degradation caused by the artificial alteration of the naturally fluctuating hydrological cycle. Furthermore, water level fluctuations can be used to examine effects on wetland vegetation communities over time as well as aid in interpreting estimates of coastal wetland area, especially in those Great Lakes for which water levels are not regulated.

### Ecosystem Objective

The ecosystem objective is to maintain the diverse array of Great Lakes coastal wetlands by allowing, as closely as is possible, the natural seasonal and long-term fluctuations of Great Lakes water levels. Great Lakes shoreline ecosystems are dependent upon natural disturbance processes, such as water level fluctuations, if they are to function as dynamic systems. Naturally fluctuating water levels create ever-changing conditions along the Great Lakes shoreline, and the biological communities that populate these coastal wetlands have responded to these dynamic changes with rich and diverse assemblages of species.

### State of the Ecosystem

Water levels in the Great Lakes have been measured since 1860, but 140 years is a relatively short period of time when assessing the hydrological history of the Lakes. Sediment investigations conducted by Thompson and Baedke on the Lake Michigan-Huron system indicate quasi-periodic lake level fluctuations (Fig. 1), both in period and amplitude, on an average of about 160 years, but ranging from 120-200 years. Within this 160-year period, there also appear to be sub-fluctuations of approximately 33 years. Therefore, to assess water level fluctuations, it is necessary to look at long-term data.

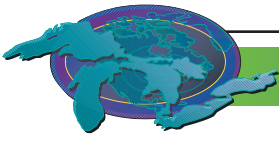
Because Lake Superior is at the upper end of the watershed, the fluctuations have less amplitude than the other Lakes. Lake Ontario (Fig. 2), at the lower end of the watershed, more clearly shows these quasi-periodic fluctuations and the almost complete elimination of the high and low levels since the Lake level began to be regulated in 1959, and more rigorously since 1976. For example, the 1986 high level that was observed in the other Lakes was eliminated from Lake Ontario. The level in Lake Ontario after 1959 contrasts with that of Lake Michigan-Huron (Fig. 3), which shows the more characteristic high and low water levels.

The significance of seasonal and long-term water level fluctuations on coastal wetlands is perhaps best explained in terms of the vegetation, which, in addition to its own diverse composition, provides the substrate, food, cover, and habitat for many other species dependent on coastal wetlands.

Seasonal water level fluctuations result in higher summer water levels and lower winter levels.

Additionally, the often unstable summer water levels ensure a varied hydrology for the diverse plant species inhabiting coastal wetlands. Without the seasonal variation, the wetland zone would be much narrower and less diverse. Even very short-term fluctuations resulting from changes in wind direction and barometric pressure can substantially alter the area inundated, and thus, the coastal wetland community.

Long-term water level fluctuations, of course, have an impact over a longer period of time. During periods of high water, there is a die-off of shrubs, cattails, and other woody or emergent species that cannot tolerate long periods of increased depth of inundation. At the same time, there is an expansion of aquatic communities, notably submergents, into the newly inundated area. As the water levels recede, seeds buried in the sediments germinate and vegetate this newly exposed zone, while the aquatic communities recede out-



ward back into the Lake. During periods of low water, woody plants and emergents expand again to reclaim their former area as aquatic communities establish themselves further outward into the Lake. The long-term high-low fluctuation puts natural stress on coastal wetlands, but is vital in maintaining wetland diversity. It is the mid-zone of coastal wetlands that harbors the greatest biodiversity. Under more stable water levels, coastal wetlands occupy narrower zones along the Lakes and are considerably less diverse, as the more dominant species, such as cattails, take over to the detriment of those less able to compete under a stable water regime. This is characteristic of many of the coastal wetlands of Lake Ontario, where water levels are regulated.

#### **Future Pressures**

Future pressures on the ecosystem include additional withdrawals or diversions of water from the Lakes, or additional regulation of the high and low water levels. These potential future pressures will require direct human intervention to implement, and thus, with proper consideration of the impacts, can be prevented. The more insidious impact could be caused by global climate change. The quasi-periodic fluctuations of water levels are the result of climatic effects, and global warming has the potential to greatly alter the water levels in the Lakes.

#### **Future Actions**

The Lake Ontario-St. Lawrence River Study Board is undertaking a comprehensive 5-year study for the International Joint Commission (IJC) to assess the current criteria used for regulating water levels on Lake Ontario and in the St. Lawrence River.

The overall goals of Environment/Wetlands Working Group (of the IJC study) are (1) to ensure that all types of native habitats (floodplain, forested and shrubby swamps, wet meadows, shallow and deep marshes, submerged vegetation, mud flats, open water, and fast flowing water) and shoreline features (barrier beaches, sand bars/dunes, gravel/cobble shores, and islands) are represented in an abundance that allows for the maintenance of ecosystem resilience and integrity over all seasons, and (2) maintain hydraulic and spatial connectivity of habitats to ensure that fauna have access, temporally and spatially, to a sufficient surface of all the types of habitats they need to complete their life cycles.

The environment/wetlands component of the IJC study provides a major opportunity to improve the understanding of past water-regulation impacts on coastal wetlands. The new knowledge will be used to develop and recommend water level regulation criteria with the specific objective of maintaining coastal wetland diversity and health. Also, continued monitoring of water levels in all of the Great Lakes is vital to understanding coastal wetland dynamics and the ability to assess wetland health on a large scale. Fluctuations in water levels are the driving force behind coastal wetland biodiversity and overall wetland health. Their effects on wetland ecosystems must be recognized and monitored throughout the Great Lakes basin in both regulated and unregulated Lakes.

#### **Further Work Necessary**

Human-induced global climate change could be a major cause of lowered water levels in the Lakes in future years. Further study is needed on the impacts of water level fluctuations on other nearshore terrestrial communities. Also, an educated public is critical to ensuring wise decisions about the stewardship of the Great Lakes basin ecosystem, and better platforms to getting understandable information to the public are needed.

#### **Acknowledgments**

Author: Duane Heaton, USEPA-Great Lakes National Programs Office, Chicago, IL.

Much of the information and discussion presented in this summary is based on work conducted by the following: Douglas A. Wilcox, Ph.D. (US Geological Survey / Biological Resources Division); Todd A. Thompson, Ph.D. (Indiana Geological Survey); Steve J. Baedke, Ph.D. (James Madison University)

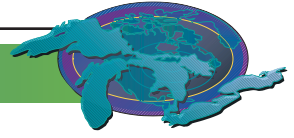
#### **Sources**

Baedke, S.J., and T.A Thompson. 2000. A 4,700-year Record of Lake Level and Isostasy for Lake Michigan. *Journal of Great Lakes Research* 26(4): 416-426.

International Lake Ontario-St. Lawrence River Study Board, Technical Working Group on Environment/Wetlands.  
<http://www.ijc.org>.

International Joint Commission, Great Lakes Regional Office, Windsor, Ontario and Detroit, Michigan.





Maynard, L. And D. Wilcox. 1997. Coastal Wetlands of the Great Lakes. State of the Lakes Ecosystem Conference 1996 Background Paper. Environment Canada and United States Environmental Protection Agency.

National Oceanic and Atmospheric Administration (NOAA). 1992 (and updates). Great Lakes Water Levels, 1860-1990. National Ocean Service, Rockville, Maryland.

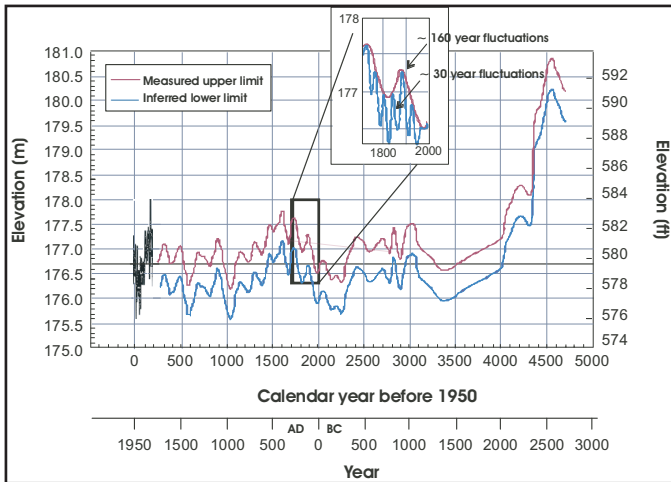


Figure 1. Sediment investigations on the Lake Michigan-Huron system indicates quasi-periodic lake level fluctuations.

Source: National Oceanic and Atmospheric Administration, 1992 (and updates)

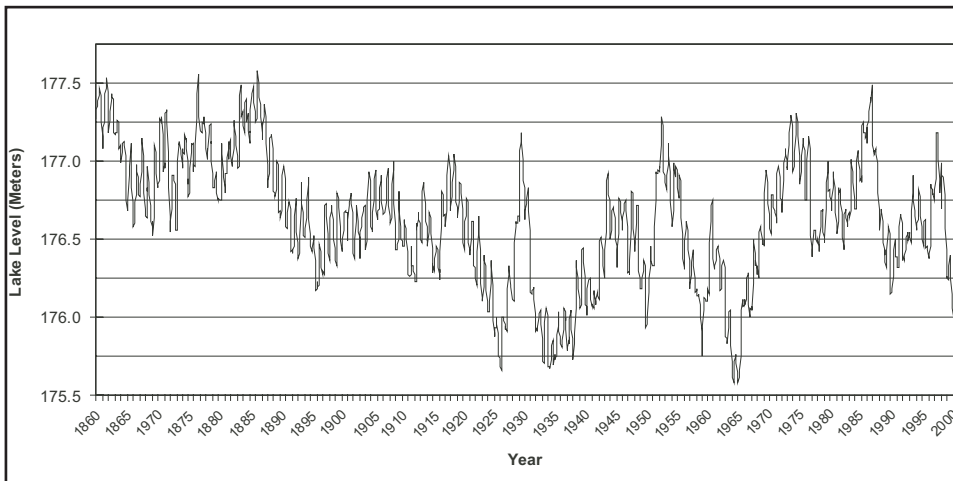


Figure 2. Actual water levels for Lakes Huron and Michigan. IGLD-International Great Lakes Datum. Zero for IGLD is Rimouski, Quebec, at the mouth of the St. Lawrence River. Water level elevations in the Great Lakes/St. Lawrence River system are measured above water level at this site. Source: National Oceanic and Atmospheric Administration

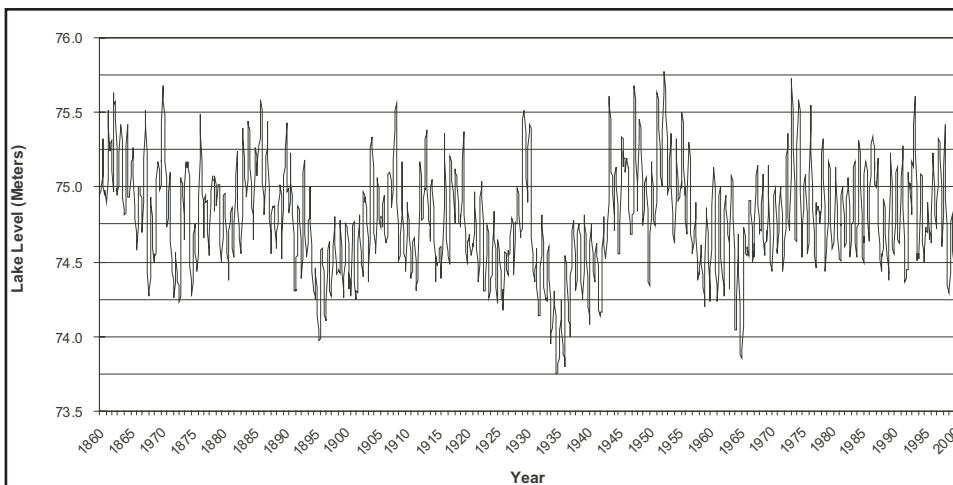
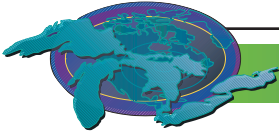


Figure 3. Actual water levels for Lake Ontario. IGLD-International Great Lakes Datum. Zero for IGLD is Rimouski, Quebec, at the mouth of the St. Lawrence River. Water level elevations in the Great Lakes/St. Lawrence River system are measured above water level at this site. Source: National Oceanic and Atmospheric Administration



## Coastal Wetland Plant Community Health

SOLEC Indicator #4862

### Assessment

The state of the wetland plant community is quite variable, ranging from good to poor across the Great Lakes basin. The wetlands in individual lake basins are often similar in their characteristics because of water level controls and lake-wide near-shore management practices. There is evidence that the plant component in some wetlands is deteriorating in response to extremely low water levels in some of the Great Lakes, but this deterioration is not seen in all wetlands within these low lakes. In general, there is slow deterioration in many wetlands as shoreline alterations introduce exotic species. However, the turbidity of the southern Great Lakes has reduced with expansion of zebra mussels, resulting in improved submergent plant diversity in many wetlands.

### Purpose

To assess the level of native vegetative diversity and cover for use as a surrogate measure of quality of coastal wetlands which are impacted by coastal manipulation or input of sediments.

### Ecosystem Objective

Coastal wetlands throughout the Great Lakes basin should be dominated by native vegetation, with low numbers of invasive plant species that have low levels of coverage. (GLWQA Annexes 2 and 13).

### State of the Ecosystem

To understand the condition of the plant community in coastal wetlands it is necessary to understand the natural differences that occur in the plant community across the Great Lakes basin. The characteristic size and plant diversity of coastal wetlands vary by wetland type, lake, and latitude, due to differences in geomorphic and climatic conditions; major factors will be described below.

*Lake:* The water chemistry and shoreline characteristics of each Great Lake differ, with Lake Superior being the most distinct due to its low alkalinity and prevalence of bedrock shoreline. Nutrient levels also increase in the lake basins further to the east, that is, in Lakes Erie, Ontario, and in the upper St. Lawrence River.

*Geomorphic wetland type:* There are several different types of wetland based on the geomorphology of the shoreline where the wetland forms. Each landform has its characteristic sediment, bottom profile, accumulation of organic material, and exposure to wave activity; these differences result in differences in plant zonation and breadth, as well as species composition. All coastal wetlands contain different zones (swamp, meadow, emergent, submergent), some of which may be typically absent in certain geomorphic wetland types. All Great Lakes wetlands have recently been classified and mapped (Great Lakes Commission 2004; Albert et al. *in press*).

*Latitude:* Latitudinal differences in temperature result in floristic differences between the southern and northern Great Lakes. Probably more important is the increased agricultural activity along the shoreline of the southern Great Lakes, resulting in increased sedimentation and exotic species introductions.

There are characteristics of coastal wetlands that make usage of plants as indicators difficult in certain conditions. Among these are:

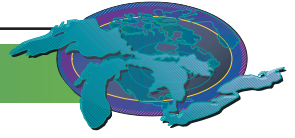
*Water level fluctuations:* Great Lakes water levels fluctuate greatly from year to year. Either an increase or decrease in water level can result in changes in numbers of species or overall species composition in the entire wetland or in specific zones. Such a change makes it difficult to monitor change over time. Changes are great in two zones, the wet meadow where grasses and sedges may disappear in high water or new annuals may appear in low water, and in shallow emergent or submergent zones, where submergent and floating plants may disappear when water levels drop rapidly.

*Lake-wide alterations:* For the southern lakes most wetlands have been dramatically altered by both intensive agriculture and urban development of the shoreline. For Lake Ontario water level control has resulted in major changes to the flora. For both of these cases, it is difficult to identify base-line high quality wetlands for comparison to degraded wetlands.

There are several hundred species of plant that occur within coastal wetlands. To evaluate the status of a wetland using plants as indicators, several different plant *metrics* have been suggested. Several of these are discussed briefly here.

*Native plant diversity:* The number of native plant species in a wetland is considered by many as a useful indicator of wetland health. The overall diversity of a site tends to decrease from south to north. Different hydrogeomorphic wetland types support vastly different levels of native plant diversity, complicating the use of this metric.

*Exotic species:* Exotic species are considered signs of wetland degradation, typically responding to increased sediment,



nutrients, physical disturbance, and seed source. The amount of exotic species coverage appears to be a more effective measure of degradation than number of exotics, except in the most heavily degraded sites.

*Submergent species:* Submergent plants respond to high levels of sediment, nutrient enrichment, and turbidity, and plant species have been identified that respond to each of these changes. Floating species, such as *Lemna* spp., are similarly responsive to nutrient enrichment. While submergents are valuable indicators whose response to changing environmental conditions is well documented, they also respond dramatically to natural fluctuations in the water level, making them less dependable in the Great Lakes than in other wetland settings.

*Nutrient responsive species:* Several species from all plant zones are known to respond to nutrient enrichment. Cat-tails (*Typha* spp.) are the best known responders.

*Salt tolerance:* Many species are not tolerant to salt, which is introduced along major coastal highways. Cat-tails are known to be very tolerant to high salt levels.

*Floristic Quality Index (FQI):* Many of the states and provinces along the Great Lakes have developed indices based on the “conservatism” of all plants growing there. A species is considered conservative if it only grows in a specific, high quality environment. FQI has proved effective for comparing similar wetland sites. However, FQI of a given wetland can change dramatically in response to a water level change, limiting its usefulness in monitoring the condition of a given wetland from year to year without development of careful sampling protocols. Another problem associated with FQIs is that the conservatism values for a given plant vary between states and provinces.

Trends in wetland health based on plants have not been well established. In the southern Great Lakes, Lake Erie, Lake Ontario, and the Upper St. Lawrence, almost all wetlands are degraded by either water level control, nutrient enrichment, sedimentation, or a combination of these factors. Probably the strongest demonstration of this is the prevalence of broad zones of cat-tails, reduced submergent diversity and coverage, and prevalence of exotic plants, including reed (*Phragmites australis*), reed canary grass (*Phalaris arundinacea*), purple loosestrife (*Lythrum salicaria*), curly pondweed (*Potamogeton crispus*), Eurasian milfoil (*Myriophyllum spicatum*), and frog bit (*Hydrocharis morsus-ranae*). In the remaining Great Lakes (St. Clair, Huron, Michigan, Georgian Bay, Lake Superior, and their connecting rivers), intact, diverse wetlands can be found for most geomorphic wetland types. However, low water conditions have resulted in the almost explosive expansion of reed in many wetlands, especially in Lake St. Clair and southern Lake Huron, especially Saginaw Bay. As water levels rise, the response of reed should be monitored.

One of the disturbing trends is the expansion of frog bit, a floating plant that forms dense mats capable of eliminating submergent plants, from the St. Lawrence River and Lake Ontario westward into Lake Erie. This expansion will probably continue into all or many of the remaining Great Lakes.

Studies in the northern Great Lakes have demonstrated that exotic species like reed, reed canary grass, and purple loosestrife have established throughout the Great Lakes, but that the levels of these species is low, often restricted to only local disturbances such as docks and boat channels. It appears that undisturbed marshes are not easily colonized by these species. However, as these species become locally established, seeds or fragments of plant may be able to establish when water level changes create appropriate sediment conditions.

## Pressures

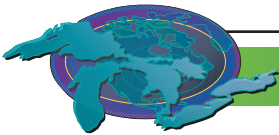
There are several pressures that lead to degradation of coastal wetlands.

*Agriculture:* Agriculture degrades wetlands in several ways, including nutrient enrichment from fertilizers, increased sediments from erosion, increased rapid runoff from drainage ditches, introduction of agricultural exotics (reed canary grass), destruction of inland wet meadow zone by plowing and diking, and addition of herbicides. In the southern lakes, Saginaw Bay, and Green Bay agricultural sediments have resulted in highly turbid waters which support few or no submergent plants.

*Urban development:* Urban development degrades wetlands by hardening shoreline, filling wetland, adding a broad diversity of chemical pollutants, increasing stream runoff, adding sediments, and increased nutrient loading from sewage treatment plants. In most urban settings almost complete wetland loss has occurred along the shoreline.

*Residential shoreline development:* Along many coastal wetlands residential development has altered wetlands by nutrient enrichment from fertilizers and septic systems, shoreline alterations for docks and boat slips, filling, and shoreline hardening. While less intensive than either agriculture or urban development, local physical alteration often results in introduction of exotic species. Shoreline hardening can completely eliminate wetland vegetation.

*Mechanical alteration of shoreline:* Mechanical alteration takes a diversity of forms, including diking, ditching, dredging,



filling, and shoreline hardening. With all of these alterations exotic species are introduced by construction equipment or in introduced sediments. Changes in shoreline gradients and sediment conditions are often adequate to allow exotics to establish.

*Introduction of exotic species:* Exotic species are introduced in many ways. Some were purposefully introduced as agricultural crops or ornamentals, later colonizing in native landscapes. Others came in as weeds in agricultural seed. Increased sediment and nutrient enrichment allows many of our worst aquatic weeds to out-compete native species. Most of our worst exotics are either prolific seed producers or reproduce from fragments of root or rhizome. Exotic animals have also been responsible for increased degradation of coastal wetlands; further degrading conditions are resulting in loss of plant cover and diversity. One of the worst exotics has been Asian carp, whose mating and feeding result in loss of submergent vegetation in shallow marsh waters.

### Management Implications

While plants are currently being evaluated as indicators of specific types of degradation, there are limited examples of the effects of changing management on plant composition. Restoration efforts at Coots Paradise, Oshawa Second, and Metzgers marsh have recently evaluated a number of restoration approaches to restore submergent and emergent marsh vegetation, including carp elimination, hydrologic restoration, sediment control, and plant introduction. The effect of agriculture and urban sediments may be reduced by incorporating buffer strips along streams and drains. Nutrient enrichment could be reduced by more effective fertilizer application, reducing algal blooms. However, even slight levels of nutrient enrichment cause dramatic increases in submergent plant coverage; for most urban areas it may prove impossible to adequately reduce nutrient loads adequately to restore native aquatic vegetation. Mechanical disturbance of coastal sediments appears to be one of the primary vectors for introduction of exotic species. Thorough cleaning of equipment to eliminate seed source and monitoring following disturbances might reduce new introductions of exotic plants.

### Acknowledgements

Authors: Dennis Albert, Michigan Natural Features Inventory, Michigan State University Extension.

Contributors: ....., Great Lakes Commission.

### Sources

Albert, D. A., and Minc, L. D. 2001. Abiotic and floristic characterization of Laurentian Great Lakes' coastal wetlands. Stuttgart, Germany. *Verh. Internat. Verein. Limnol.* 27: 3413-3419.

Albert, D. A., Wilcox, D. A., Ingram, J. W., and Thompson T. A. Submitted. Hydrogeomorphic Classification for Great Lakes Coastal Wetlands. *Journal of Great Lakes Research.*

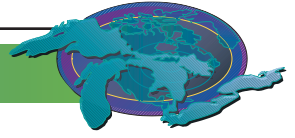
Environment Canada and Central Lake Ontario Conservation Authority. 2004. Durham Region Coastal Wetland Monitoring Project: Year 2 Technical Report. Downsview, ON: ECB-OR.

Herdendorf, C. E. 1988. *Classification of geological features in Great Lakes nearshore and coastal areas. Protecting Great Lakes Nearshore and Coastal Diversity Project.* International Joint Commission/The Nature Conservancy, Windsor, Ontario.

\_\_\_\_\_, Hakanson, L., Jude, D. J., and Sly, P. G. 1992. A review of the physical and chemical components of the Great Lakes: a basis for classification and inventory of aquatic habitats. In *The development of an aquatic habitat classification system for lakes.* Eds. W.-D. N. Busch and P. G. Sly, pp. 109-160. Ann Arbor, MI: CRC Press.

\_\_\_\_\_, Hartley, S. M., and Barnes, M. D. (eds.). 1981a. *Fish and wildlife resources of the Great Lakes coastal wetlands within the United States, Vol. 1: Overview.* U.S. Fish and Wildlife Service, Washington, DC. FWS/OBS-81/02-v1.

Jaworski, E., Raphael, C. N., Mansfield, P. J., and Williamson, B. B. 1979. Impact of Great Lakes Water Level Fluctuations on Coastal Wetlands. U.S.D.I. Office of Water Resources and Technology. Institute of Wetland Research, Michigan State University, East Lansing, MI. Contract Report 14-0001-7163.

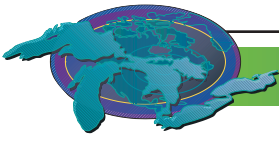


Keough J. R., Thompson, T. A., Guntenspergen, G. R., and Wilcox, D. A. 1999. Hydrogeomorphic factors and ecosystem responses in coastal wetlands of the Great Lakes. *Wetlands* 19:821-834.

Minc, L. D. 1997. *Great Lakes coastal wetlands: An overview of abiotic factors affecting their distribution, form, and species composition*. Michigan Natural Features Inventory, Lansing, MI.

\_\_\_\_\_, and Albert, D. A. 1998. *Great Lakes coastal wetlands: abiotic and floristic characterization*. Michigan Natural Features Inventory, Lansing, MI.

Wilcox, D. A., and Whillans, T. H. 1999. Techniques for restoration of disturbed coastal wetlands of the Great Lakes. *Wetlands* 19:835-857.

**Urban Density**

SOLEC Indicator #7000

**Assessment: Mixed**

Data not system wide

**Purpose**

The purpose of this indicator is to assess the human population density in the Great Lakes basin, and to infer the degree of inefficient land use and urban sprawl for communities in the Great Lakes Ecosystem. Urban density is defined as the number of people who inhabit a city or town in relation to the geographic area of that city or town. Urban sprawl is low-density development beyond the edge of service and employment, which separates residential areas from commercial, educational, and recreational areas - thus requiring automobiles for transportation (1998 Sierra Club Sprawl Report). For this assessment, the data analyzed was based on Metropolitan Statistical Areas (MSAs) from the U.S. Census 2000 and 1990 and Census Metropolitan Areas (CMAs) from the 2001 and 1996 Canadian Census.

**Ecosystem Objective**

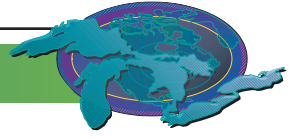
This indicator offers information on the presence, location, and predominance of human-built land cover and may provide information about how such land cover types affect the ecological characteristics and functions of ecosystems, as demonstrated by the use of remote-sensing data and field observations. Socioeconomic viability and sustainable development are the generally acceptable goals for urban growth in the Great Lakes basin. Socioeconomic viability indicates that development should be sufficiently profitable and social benefits are maintained over the long term. Sustainable development requires that we plan our cities to grow in a way so that they will be environmentally sensitive, and not compromise the environment for future generations. Thus, by increasing the densities in urban areas while maintaining low densities in rural and fringe areas, the amount of land consumed by urban sprawl will be reduced.

**State of the Ecosystem**

Within the Great Lakes basin there are 10 CMAs in Ontario and 24 MSAs in the United States. In Canada, a Census Metropolitan Area (CMA) is defined as an area consisting of one or more adjacent municipalities situated around a major urban core with a population of at least 100,000. In the United States, a Metropolitan Statistical Area must have at least one urbanized area of 50,000 or more inhabitants and at least one urban cluster of at least 10,000 but less than 50,000 populations. The urban densities in the Great Lakes basin show consistent patterns in both the United States and Canada. The population in both countries has been increasing over the past five to ten years. According to the 2001 Statistics Canada report, between 1996 and 2001, the population of the Great Lakes basin CMAs grew from 7,041,985 to 7,597,260. The 2000 U.S. census reports that from 1990 to 2000 the population contained in the MSAs of the Great Lakes basin grew from 26,069,654 to 28,048,813.

Urban sprawl has many detrimental effects on the environment. This process consumes large quantities of land, multiplies the required infrastructure, and increases the use of personal vehicles as the feasibility of alternate transportation declines. When there is an increased dependency on personal vehicles, consequentially, there is an increased demand for roads and highways, which in turn, produce segregated land uses, large parking lots, and urban sprawl. These implications result in the increased consumption of many non renewable resources, the creation of impervious surfaces and damaged natural habitats, and the production of many harmful emissions. Segregated land use also lowers the quality of life as the average time spent traveling increases and the sense of community diminishes.

Fortunately, in the Great Lakes basin, as there has been an increase in population, there has also been an increase in the average densities of the CMAs and MSAs. In the United States MSAs the average density increased from 177.47 people/km<sup>2</sup> in 1990 to 190.95 people/km<sup>2</sup> in 2000 and in Canada CMAs the average density increased from 326.38 people/km<sup>2</sup> in 1996 to 352.11 people/km<sup>2</sup> in 2001. Although this increase in density indicates healthier growth patterns for our metropolitan areas, it does not imply that we have achieved our sustainable objectives. Within the CMAs and MSAs the population and density has been increasing. However, within the CMAs and MSAs the amount of land being developed is escalating at a greater rate than the population growth rate. Therefore, the average amount of developed land per person is increasing. For example, "In the GTA [Greater Toronto Area] during the 1960s, the average amount of developed land per person was a modest 0.019 hectares. By 2001 that amount has tripled to 0.058 hectares per person" (Gilbert et.al, 2001).



Population densities illustrate the development patterns of an area. If an urban area has a low population density this indicates that the city has taken on a pattern of urban sprawl and segregated land uses. This conclusion can be made as there is a greater amount of land per person; however, it is important to not only look at the overall urban density of an area, but also the urban dispersion. For example, looking at a CMA or MSA with a relatively low density could have different characteristics than a CMA or MSA with the same density. The CMA or MSA could either have the distribution of people concentrated around an urban center, or it could have a generally consistent sparse dispersion across the entire area and both could have the same average density. Therefore, to properly evaluate the growth pattern of an area, it is necessary to examine not only at the urban density but also at the urban dispersion.

A comparison of the ten CMAs and MSAs with the highest densities to the ten 10 CMAs and MSAs with the lowest densities in the Great Lakes basin shows there is a large range between the higher densities and lower densities. This indicates that a few areas seem to be improving their growth patterns, while many other areas need to advance to a more sustainable development pattern. Three of the lowest ten density areas have experienced a population decline while the others have experienced very little population growth over the time period examined. The population declines and little growth are generally occurring in northern parts of Ontario and Eastern New York. Both of these areas have had relatively high unemployment rates (between 8 and 12 per cent) which could be linked to the slow growth and decreasing populations.

Overall, the growing urban areas in the Great Lakes basin seem to be increasing their geographical area at a faster rate than their population. This trend has many detrimental effects as outlined previously, namely urban sprawl and its implications and these implications will continue to threaten the Great Lakes basin ecosystem unless this pattern is reversed.

### Pressures

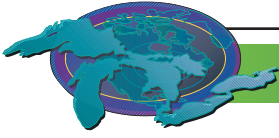
Sprawl is increasingly becoming a problem in rural and fringe areas of the Great Lakes basin, placing a strain on infrastructure and consuming habitat in areas that tend to have healthier environments than those that remain in urban areas. This trend is expected to continue, which will exacerbate other problems, such as increased consumption of fossil fuels, longer commute times from residential to work areas, and fragmentation of habitat. For example, at current rates, residential building projects will consume some 1,000 square kilometres of the province's countryside, an area double the size of Metro Toronto, by 2031. Also, gridlock would add 45 per cent to commuting times, and air quality would suffer with a 40 per cent increase in vehicle emissions (Loten, 2004). The pressure urban sprawl exerts on the ecosystem has not yet been fully understood. It may be years before all of the implications have been realized.

### Management Implications

"Urban Density" may be used to infer "land use" types, but such uses should be considered under "Human Impact Measures". Urban Density affects can be more thoroughly explored and explained if they are linked to the functions of ecosystems (e.g., as it relates to surface water quality). For this reason, interpretation of this indicator is correlated with many other SOLEC indicators and their patterns across the Great Lakes. Urban density affects on ecosystem functions should be linked to the ecological endpoint of interest, and this interpretation may vary as a result of the specificity of land cover type and the contemporaneous nature of the data. Thus, more detailed land cover specificity is required, and is currently under development for the early-2000s (Lopez *et al.*, in preparation). Anticipated completion of these analyses is early-2005.

To conduct such measures at a broad scale, the relationships between land cover and ecosystem functions need to be verified. This measure will need to be validated fully with thorough field-sampling data, and sufficient *a priori* knowledge of such endpoints and the mechanisms of impact (if applicable). The development of indicators (e.g., a regression model) is an important goal, and requires uniform measurement of field parameters across a vast geographic region to determine accurate information to calibrate such models.

The governments of the United States and Canada have both been making efforts to ease the strain caused by pressures of urban sprawl by proposing policies, and creating strategies. Although this is the starting point in implementing a feasible plan to deal with the environmental and social pressures of urban sprawl, it does not suffice. Policies are not effective until they are put into practice and in the meantime, our cities continue to grow at unsustainable rates. In order to mitigate the pressures of urban sprawl, a complete set of policies, zoning bylaws and redevelopment incentives must be developed, reviewed and implemented. As noted in the SOLEC 2000 Urban Density indicator report, policies that encourage infill and brownfield redevelopment within urbanized areas



will reduce sprawl. Compact development could save 20 per cent in infrastructure costs (Loten, 2004). Comprehensive and land-use planning that incorporates “green” features, such as cluster development and greenway areas, will help to alleviate the pressure from development.

#### **Further Work Necessary**

A thorough field-sampling protocol, a properly validated geographic information, and other remote-sensing-based data could lead to successful development of urban density as an indicator of ecosystem function and ecological vulnerability in the Great Lakes basin. This indicator could be applied to select sites, but would be most effective if used at a regional or basin-wide scale. Displaying U.S. and Canadian census population density on a GIS map will allow increasing sprawl to be documented over time in the Great Lakes basin on a variety of scales. For example, the maps included with the 2002 Urban Density report show the entire Lake Superior basin and a closer view of the southwestern part of the basin.

#### **Acknowledgments**

Author: Lindsay Silk, Environment Canada Intern, Downsview, ON.  
Ric Lopez, Environmental Protection Agency, Chicago, Illinois.

#### **Sources**

GEM Center for Science and Environmental Outreach. (2000) Baseline Sustainability Data for the Lake Superior Basin: Final Report to the Developing Sustainability Committee, Lake Superior Binational Program, November 2000. Unpublished report, Michigan Technological University, Houghton, MI (<http://emmap.mtu.edu/gem/community/planning/lstb.html>).

Gilbert, R., L. S. Bourne, M. S. Gertler. 2001. The State of GTA in 2000. A report for the Greater Toronto Services Board. Metropole Consultants. Toronto, Ontario.

Kristine Bradof, GEM Center for Science and Environmental Outreach, Michigan Technological University, MI, and James G. Cantrill, Communication and Performance Studies, Northern Michigan University, MI.

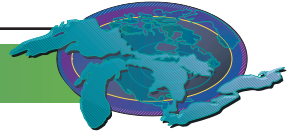
Loten, Angus. 2004. Sprawl plan our ‘last chance:’ Caplan. Toronto Star, July 29, 2004. Toronto ON.

Sierra Club of Canada, 2003. Sprawl Hurts Us All! Toronto, Ontario.

Statistics Canada. 2001. Community Profiles and 1996 census subdivision area profiles. Data retrieved from:  
<http://www12.statcan.ca/english/profil01/PlaceSearchForm1.cfm>

US Census Bureau. American Fact Finder, Census 2000 Summary File 1 (SF 1) 100-Percent Data, Detailed Tables. Retrieved from:  
[http://factfinder.census.gov/servlet/DTGeoSearchByRelationshipServlet?\\_ts=109848346281](http://factfinder.census.gov/servlet/DTGeoSearchByRelationshipServlet?_ts=109848346281)





## Land Cover/Land Conversion

SOLEC indicator #7002

### Purpose

This indicator will document the proportion of land in the Great Lakes basin under major land use classes, and assess the changes in land use over time. These data will infer the potential impact of existing land cover and land conversion patterns on basin ecosystem health.

### Ecosystem Objective

Sustainable development is a generally accepted land use goal. This indicator supports Annex 13 of the GLWQA.

### State of the Ecosystem

Bi-national land use data from the early 1990s was developed by Guindon (Natural Resources Canada). Imagery data from the North American Landscape Characterization and the Canada Centre for Remote Sensing archive were combined and processed into land cover using Composite Land Processing System software. This data set divides the basin into four major land use classes – water, forest, urban, and agriculture and grasses: (data to be announced, currently amount of urban area on map is overestimated)

More recently, finer-resolution satellite imagery is allowing analysis to be conducted in greater detail, with a larger number of land use categories. For instance, the Ontario Ministry of Natural Resources has compiled Landsat TM data, classifying the Canadian Great Lakes basin into 28 land use classes: (data to be announced)

On the U.S. side of the basin, the Natural Resources Research Institute of the University of Minnesota – Duluth has developed a 26-category classification scheme based on 1992 National Land Cover Data from the U.S. Geological Survey supplemented by 1992 WISCLAND, 1992 GAP, 1996 C-CAP and raw Landsat TM data to increase resolution in wetland classes. 1992 Tiger data was also used to add roads on to the map. Within the U.S. basin, the NRRI found the following:

	Area in Hectares	Percentage of Total Land
Open Water	1,222,481 *	4.2%
Low Intensity Residential	412,378	1.4%
High Intensity Residential	136,533	0.5%
Tiger Roads (1992)	1,675,899	5.8%
Commercial/Industrial	232,572	0.8%
Bare Rock/Sand/Clay	13,127	<0.1%
Quarries/Strip Mines/Gravel Pits	42,630	0.2%
Transitional	66,607	0.2%
Deciduous Forest	7,723,316	26.8%
Evergreen Forest	1,533,177	5.3%
Mixed Forest	1,790,038	6.2%
Shrubland	53,328	0.2%
Orchards/Vineyards/Other	216	<0.1%
Grasslands/Herbaceous	408,910	1.4%
Pasture/Hay	3,818,427	13.3%
Row Crops	6,801,486	23.6%
Small Grains	4,321	<0.1%
Urban/Recreational Grasses	102,940	0.4%
Emergent Herbaceous Wetlands	681,884	2.4%
Unconsolidated Shore	5,481	<0.1%
Lowland Grasses	139,226	0.5%
Lowland Scrub/Shrub	516,811	1.8%
Lowland Conifers	743,233	2.6%
Lowland Mixed Forest	678,830	2.4%
TOTAL	28,803,849	

Table 1. Land Cover type, area, and percentage of total land for the U.S. Great Lakes basin, from NRRI analysis.

\*Preliminary estimate, Will be updated in Final Report

The remote-sensing data from satellite imagery needs to be validated with field sampling data. Satellite data can be difficult to interpret; there is often difficulty in distinguishing among various land use classes.

Forest inventories present a key source of field data on land use. The Ontario Ministry of Natural Resources relies on a combination



of aerial photography and field sampling for its Forest Resources Inventory database. The following data for the Canadian Great Lakes basin is a mosaic of data collected between 1978 and 2001:

	Area in Hectares	Percentage of Total Land
Productive Forest	13,045,401	60.2%
Open Muskeg	486,235	2.2%
Treed Muskeg	226,023	1.0%
Brush/Alder	201,954	1.4%
Grass/Meadow	644,473	3.0%
Developed Agricultural Land	3,124,074	14.4%
Rock	274,509	1.3%
Unclassified (mostly urban)	868,054	4.0%
Water	2,713,558	12.5%
TOTAL	21,674,181	

Table 2. Land cover type, area and percentage of total land in the Canadian Great Lakes basin, from OMNR analysis.

The U.S.D.A. Forest Service also has a field sampling protocol, the Forest Inventory and Analysis database. The following data is for the U.S. Great Lakes basin. In six of the eight Great Lakes states, data were collected in 2002; Michigan data is from 2001, while Ohio data is from 1991:

	Area in Hectares	Percentage of Total
Forest	14,746,054	46.6%
Non-forest	14,981,127	47.3%
Non-census Water	206,576	0.7%
Census Water	1,724,577	5.5%
Denied Access	8,467	<0.1%
Hazardous	4,101	<0.1%
TOTAL	31,670,902	

Table 3. Forest and non-forest land cover type, area and percentage of total for U.S. Great Lakes basin, from U.S. D.A. Forest Service analysis.

U.S.D.A. data from the past quarter-century is also available, enabling an analysis of land conversion in the U.S. Great Lakes basin over time. Due to the different reporting cycles in the eight states, a uniform baseline cannot be established for basin-wide analysis. However, a state-by-state analysis reveals that forest cover has generally been increasing across the basin in recent decades, while non-forest areas have correspondingly decreased.

It should be noted that the data sets discussed in this report were developed independently under different protocols. Making direct comparisons among them will require closer coordination of survey methods and data definitions.

**Future Pressures and Management Implications**

As the volume of data on land use and land conversion grows, stakeholder discussions will assist in identifying the associated pressures and management implications.

**Acknowledgements**

Author: Mervyn Han, ECO Federal Government Associate on contract to U.S. EPA-GLNPO.

Data courtesy of: Bert Guindon (Natural Resources Canada), Lawrence Watkins (Ontario Ministry of Natural Resources) and Peter Wolter (Natural Resources Research Institute at the University of Minnesota – Duluth.) Forest Inventory and Analysis statewide data sets downloaded from U.S.D.A. Forest Service website and processed by author to extract data relevant to Great Lakes basin.

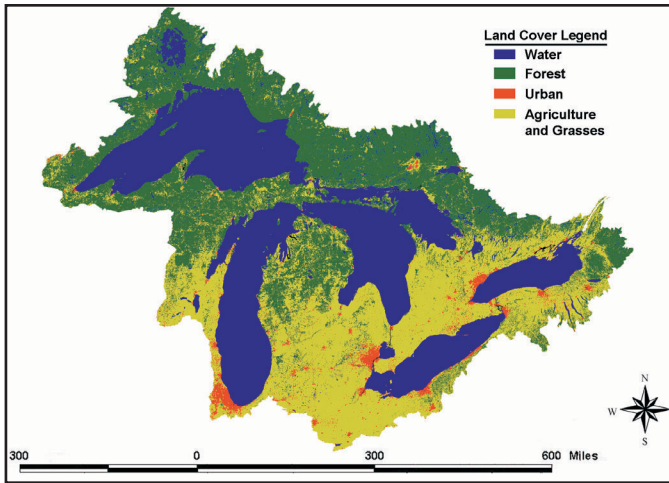
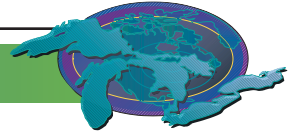


Figure 1: Bi-national land use data. Guindon et al., Natural Resources Canada. Based on North American Landscape Characterization and Canada Centre for Remote Sensing Data.

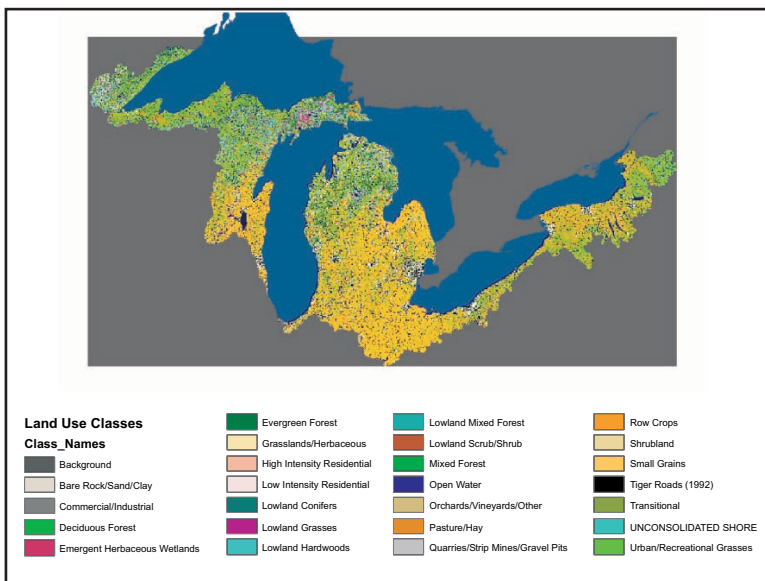


Figure 2: Land Use in the U.S. basin. Natural Resources Research Institute, University of Minnesota - Duluth. Based on NLCD (1992) and other data sets.

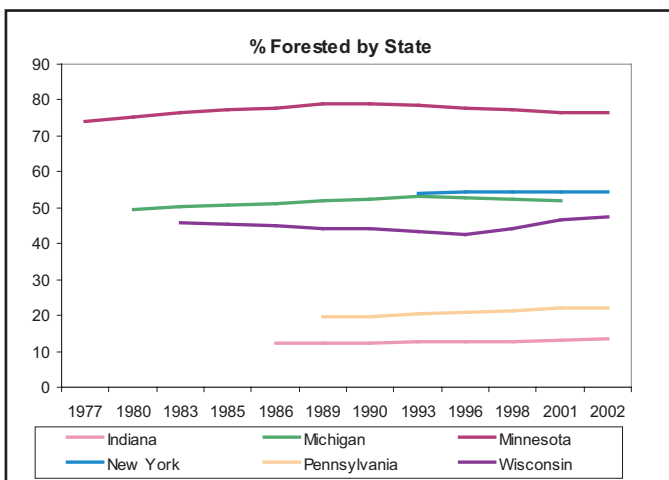
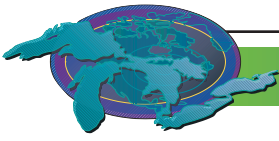


Figure 3: Percentage of land under forest cover in the Great Lakes basin, by state, 1977-2002. Includes only the portion of each state within the watershed. Source: U.S.D.A. Forest Service, Forest Inventory and Analysis database.



## Brownfields Redevelopment

Indicator ID #7006

*This indicator report is from 2002.*

### Assessment: Mixed Improving

Data from multiple sources are not consistent.

### Purpose

To assess the acreage of redeveloped brownfields, and to evaluate over time the rate at which society remediates and reuses former developed sites that have been degraded or abandoned.

### Ecosystem Objective

The goal of brownfields redevelopment is to remove threats of contamination associated with these properties and to bring them back into productive use. Remediation and redevelopment of brownfields results in two types of ecosystem improvements:

1. reduction or elimination of environmental risks from contamination associated with these properties; and
2. reduction in pressure for open space conversion as previously developed properties are reused.

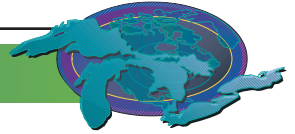
### State of the Ecosystem

All eight Great Lakes states, Ontario and Quebec have programs to promote remediation or “cleanup” and redevelopment of brownfields sites. Several of the brownfields cleanup programs have been in place since the mid to late 1980s, but establishment of more comprehensive brownfields programs that focus on remediation and redevelopment has occurred during the 1990s. Today, each of the Great Lakes states has a voluntary cleanup or environmental response program. These programs offer a range of risk-based, site-specific background and health cleanup standards that are applied based on the specifics of the contaminated property and its intended reuse.

Efforts to track brownfields redevelopment are uneven among Great Lakes states and provinces. Not all jurisdictions track brownfields activities and methods vary where tracking does take place. Most states track the amount of funding assistance provided as well as the number of sites that have been redeveloped. These are indicators of the level of brownfields redevelopment activity in general, but they do not necessarily reflect land renewal efforts (i.e., acres of land redeveloped)-the desired measure for this SOLEC indicator. Adding up state and provincial information to come up with a brownfields figure that represents the collective eight states and two provinces is challenging at best. Several issues are prominent. First, state and provincial cleanup data reflect different types of cleanups, not all of which are “brownfields” (e.g. some include leaking underground storage tanks and others do not). Second, some jurisdictions have more than one program, and not necessarily all relevant programs engage in such tracking. Third, program-part of a state or provincial cleanup program (e.g. local or private cleanups). That said, several states and provinces do track acres of brownfields remediated, although no Great Lakes state or province tracks acres of brownfields redeveloped.

Information on acres of brownfields remediated from Illinois, Minnesota, New York, Ohio, Pennsylvania and Quebec indicate that, as of August, 2002, a total of 32,103 acres have been remediated in these states and provinces alone, and approximately 4,600 acres were remediated between 2000-2002. Available data from eight Great Lakes states and Quebec indicates that more than 24,000 brownfields sites have participated in brownfields cleanup programs since the mid-1990s, although the degree of “remediation” varies considerably.

Remediation is a necessary precursor to redevelopment. Remediation is often used interchangeably with “cleanup,” though brownfields remediation does not always involve removing or treating contaminants. Many remediation strategies utilize either engineering or institutional controls (also known as exposure controls) or adaptive reuse techniques that are designed to limit the spread of, or human exposure to, contaminants left in place. In many cases, the cost of treatment or removal of contaminants would prohibit reuse of land. All Great Lakes states and provinces allow some contaminants to remain on site as long as the risks of being exposed to those contaminants are eliminated or reduced to acceptable levels. Capping a site with clean soil or restricting the use of groundwater are examples of these “exposure controls” and their use has been a major factor in advancing brownfields redevelopment. Several jurisdictions keep track of the number and location of sites with exposure controls, but monitoring the effectiveness of such controls occurs in only three out of the ten jurisdictions.



Redevelopment is a criterion for eligibility under many state brownfields cleanup programs. Though there is inconsistent and inadequate data on acres of brownfields remediated and/or redeveloped, available data indicate that both brownfields cleanup and redevelopment efforts have risen dramatically in the mid 1990s and steadily since 2000. The increase is due to risk-based cleanup standards and the widespread use of state liability relief mechanisms that allow private parties to redevelop, buy or sell properties without being liable for contamination they did not cause. Data also indicates that the majority of cleanups in the Great Lakes states and provinces are occurring in older urbanized areas, many of which are located on the shoreline of the Great Lakes and in the basin. Based on the available information, the state of brownfields redevelopment is *mixed-improving*.

#### **Future Pressures**

Laws and policies that encourage new development to occur on undeveloped land instead of on urban brownfields, are significant and ongoing pressures that can be expected to continue. Programs to monitor, verify and enforce effectiveness of exposure controls are in their infancy, and the potential for human exposure to contaminants may inhibit the redevelopment of brownfields. Several Great Lakes states allow brownfields redevelopment to proceed without cleaning up contaminated groundwater as long as no one is going to use or come into contact with that water. However, where migrating groundwater plumes ultimately interface with surface waters, some surface water quality may continue to be at risk from brownfields contamination even where brownfields have been remediated.

#### **Future Activities**

Programs to monitor and enforce exposure controls need to be fully developed and implemented. More research is needed to determine the relationship between groundwater supplies and Great Lakes surface waters and their tributaries. Because brownfields redevelopment results in both reduction or elimination of environmental risks from past contamination and reduction in pressure for open space conversion, data should be collected that will enable an evaluation of each of these activities.

#### **Further Work Necessary**

Great Lakes states and provinces have begun to track brownfields remediation and or redevelopment, but the data is generally inconsistent or not available in ways that are helpful to assess progress toward meeting the terms of the Great Lakes Water Quality Agreement. Though some jurisdictions have begun to implement web-based searchable applications for users to query the status of brownfields sites, the data gathered are not necessary consistent, which presents challenges for assessing progress in the entire basin. States and provinces should develop common tracking methods and work with local jurisdictions incorporating local data to an online data bases that can be searched by: 1) acres remediated; 2) mass of contamination removed or treated (i.e., not requiring an exposure control); 3) type of treatment; 4) geographic location; 5) level of urbanization; and 6) type of reuse (i.e., commercial, residential, open, none, etc).

#### **Acknowledgments**

Author: Victoria Pebbles, Senior Project Manager, Transportation and Sustainable Development, Great Lakes Commission, Ann Arbor, MI, phone: 734-971-9135, ext. 130  
email: [vpebbles@glc.org](mailto:vpebbles@glc.org), web: [www.glc.org](http://www.glc.org), with assistance from Becky Lameka and Kevin Yam, Great Lakes Commission, Ann Arbor, MI.

#### **Sources**

Selected Annual Reports of state cleanup programs.  
Personal communication with Great Lakes State Brownfield/Voluntary Cleanup Program Managers.

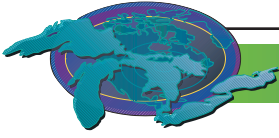
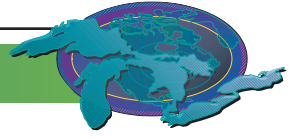


Figure 1. Figure 98. Brownfield site in Detroit, Michigan, 1998.  
Source: Victoria Pebbles, Great Lakes Commission



## Sustainable Agriculture Practices

Indicator ID #7028

Also see indicator #111 – Phosphorus Concentrations and Loadings

### Purpose

To assess the number of Environmental and Conservation farm plans and environmentally friendly practices in place such as: integrated pest management to reduce the potential adverse impacts of pesticides; conservation tillage and other soil preservation practices to reduce energy consumption and sustain natural resources and to prevent ground and surface water contamination.

### Ecosystem Objective

This indicator supports Annex 2, 3, 12 and 13 of the GLWQA. The objective is the sound use and management of soil, water, air, plant, and animal resources to prevent degradation. The process integrates natural resource, economic, and social considerations to meet private and public needs. The goals are to create a healthy and productive land base that sustains food and fiber, functioning watersheds and natural systems, enhances the environment and improves the rural landscape.

### State of the Ecosystem

Agriculture accounts for 35 percent of the land area of the Great Lakes basin and dominates the southern portion of the basin. In the past excessive tillage and intensive crop rotations led to soil erosion and resulting sedimentation of major tributaries. Inadequate land management practices contributed to 63 million tons of soil eroded annually by the 1980's. Ontario estimated its costs of soil erosion and nutrient/pesticide losses at \$68 million annually. In the United States, agriculture is a major user of pesticides with an annual use of 26,000 tons. These practices led to a decline of soil organic matter. Since the late 1980's there has been increasing participation by Great Lakes basin farmers in various soil and water quality management programs. Today's conservation systems have reduced the rates of U.S. soil erosion by 38 percent in the last few decades. The adoption of more environmentally responsible practices has helped to replenish carbon in the soils back to 60 percent of turn-of-the century levels.

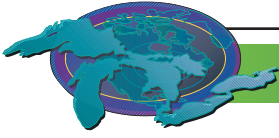
Both the Ontario Ministry of Agriculture and Food (OMAF) and the USDA's Natural Resources Conservation Service (NRCS) provide conservation planning advice, technical assistance and incentives to farm clients and rural landowners. Clients develop and implement conservation plans to protect, conserve, and enhance natural resources that harmonize productivity, business objectives and the environment. Successful implementation of conservation planning depends largely upon the voluntary participation of clients. Figure 1 shows the number of acres of cropland in the U.S. portion of the Great Lakes Basin which are covered under a conservation plan.

The Ontario Environmental Farm Plan (EFP) encourages farmers to develop action plans and adopt environmentally responsible management practices and technologies. Since 1993, The Ontario Farm Environmental Coalition (OFEC) in partnership with OMAF and the Ontario Soil and Crop Improvement Association (OSCIA) have cooperated to deliver EFP workshops. The Canadian Federal Government through various programs over the years has provided funding for EFP. As part of Ontario's Clean Water Strategy, the Nutrient Management Act (June 2002) is setting province-wide standards to address the effects of agricultural practices on the environment, particularly as they relate to land-applied materials containing nutrients.

USDA's voluntary Environmental Quality Incentives Program provides technical, educational, and financial assistance to landowners that install conservation systems. The Conservation Reserve Program allows landowners to convert environmentally sensitive acreage to vegetative cover. States may add funds to target critical areas under the Conservation Reserve Enhancement Program. The Wetlands Reserve Program is a voluntary program to restore wetlands.

### Future Pressure

The trend towards increasing farm size and concentration of livestock will change the face of agriculture in the basin. Development pressure from the urban areas may increase the conflict between rural and urban landowners. This can include pressures of higher taxes, traffic congestion, flooding, nuisance complaints (odours) and pollution. By urbanizing farmland we may limit future options to deal with social, economic, food security and environmental problems.



### **Future Actions**

In June of 2002, the Canadian Government announced a multi-billion dollar Agricultural Policy Framework (APF). Its goal is a national plan to strengthen Canada's agricultural sector, for Canada to be a world leader in food safety and quality, environmentally responsible production and innovation, while improving business risk management and fostering renewal. As part of the APF Framework the Canadian Government is making a \$100 million commitment over a 5-year period to help Canadian farmers increase implementation of Environmental Farm Plans. The estimated commitment to Ontario for the environment is \$67.66 million while the province is committing \$42.72 million. These funds will be available to Ontario's farmers once the federal government signs a contribution agreement with the Ontario Farm Environmental Coalition (OFEC). This is expected in the fall of 2004. Currently Ontario's Environmental Farm Plan workbook is being revised for new APF farm planning initiatives. Ontario Farm Plan workshops are anticipated to be delivered starting in the winter of 2004/05 under the APF initiative.

In the spring of 2004 OMAF released the Best Management Practices (BMP) book Buffer Strips. This book will assist farmers with establishing healthy riparian zones and address livestock grazing systems near water – two important areas for improvements in water quality and fish habitat. Pesticide use surveys, conducted every 5 years since 1983, was conducted in 2003. Results are expected for release in the summer of 2004.

The US Clean Water Action Plan of 1998 calls for USDA and the Environmental Protection Agency to cooperate further on soil erosion control, wetland restoration, and reduction of pollution from farm animal operations. National goals are to install 2 million miles of buffers along riparian corridors by 2002 and increase wetlands by 100,000 acres annually by 2005. Under the 1999 EPA/USDA Unified National Strategy for Animal Feeding Operation (AFO) all AFOs will have comprehensive nutrient management plans implemented by 2009. The Conservation Security Program was launched in 2004, and provides financial incentives and rewards for producers who meet the highest standards of conservation and environmental management on their operations.

### **Acknowledgements**

**Authors:** Peter Roberts Water Management Specialist, OMAF, Guelph, Ontario Canada [peter.roberts@omaf.gov.on.ca](mailto:peter.roberts@omaf.gov.on.ca) and Ruth Shaffer, USDA –Natural Resource Conservation Service, [ruth.shaffer@mi.usda.gov](mailto:ruth.shaffer@mi.usda.gov) and Roger Nanney, Resource Conservationist, USDA, NRCS, [roger.nanney@in.usda.gov](mailto:roger.nanney@in.usda.gov)



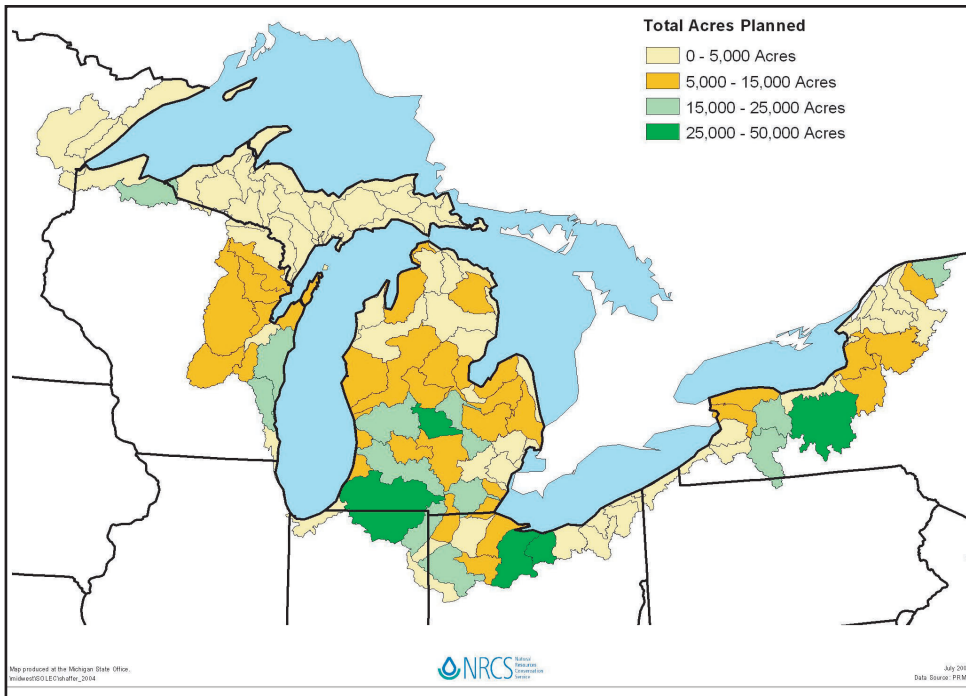
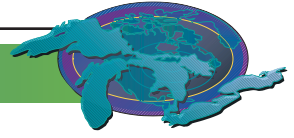


Figure 1. Acres of Cropland in U.S portion of the basin covered under a conservation plan

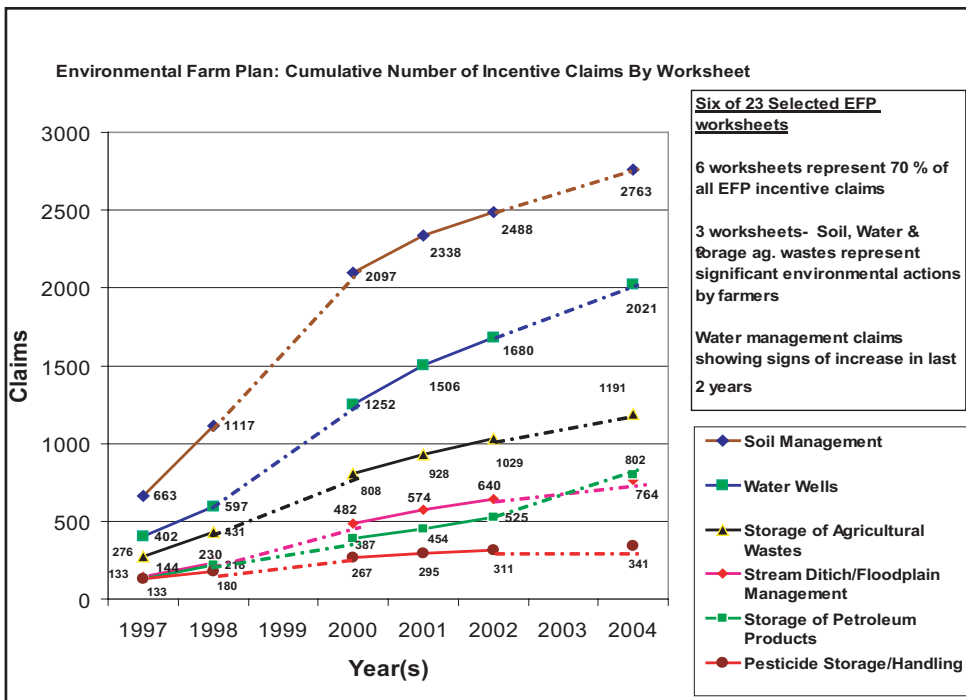


Figure 2.EFP: Cumulative Number of Incentive Claims by Worksheet  
 (Source Data: Ontario Soil & Crop Improvement Association (OSCIA)  
 I:\solec\SOLEC 2004\Indicators 2004\EFP\EFP 7028 Peter Roberts Ruth Schaffer Sept 23 04.doc  
 I:\solec\SOLEC 2004\Indicators 2004\EFP\EFP 7028 Peter Roberts Aug 18 04 .doc



## Economic Prosperity

SOLEC Indicator #7043

*This indicator report is from 2002.*

### Assessment: Mixed (for Lake Superior Basin)

Data are not system-wide.

### Purpose

To assess the unemployment rates within the Great Lakes basin, and, when used in association with other Societal indicators, to infer the capacity for society in the Great Lakes region to make decisions that will benefit the Great Lakes ecosystem.

### Ecosystem Objective

Human economic prosperity is a goal of all governments. Full employment (unemployment below 5% in western societies) is a goal for all economies and humans are part of the ecosystem.

### State of the Ecosystem

This information is presented to supplement the report on Economic Prosperity in SOLEC 2000 Implementing Indicators (Draft for Review, November 2000). In 1975, 1980, 1985, 1990, 1995 and 2000 the civilian unemployment rate in the 16 U.S. Lake Superior basin counties averaged about 2.0 points above the U.S. average, and above the averages for their respective states, except occasionally Michigan (Figure 1). For example, the unemployment rate in the four Lake Superior basin counties in Minnesota was consistently higher than for Minnesota overall, 2.8 points on average but nearly double the Minnesota rate of 6.0 percent in 1985. Unemployment rates in individual counties ranged considerably, from 8.6 to 26.8 percent in 1985, for example.

In the 29 Ontario census subdivisions mostly within the Lake Superior watershed, the 1996 unemployment rate for the population 15 years and over was 11.5 percent. For the population 25 years and older, the unemployment rate was 9.1 percent. By location the rates ranged from 0 to 100 percent; the extremes, which occur in adjacent First Nations communities, appear to be the result of small populations and the 20 percent census sample. The most populated areas, Sault Ste. Marie and Thunder Bay, had unemployment rates for persons 25 years and older of 9.4 and 8.6 percent, respectively. Of areas with population greater than 200 in the labor force, the range was from 2.3 percent in Terrace Bay Township to 31.0 percent in Beardmore Township. Clearly, the goal of full employment (less than 5% unemployment) was not met in either the Canadian or the U.S. portions of the Lake Superior basin during the years examined.

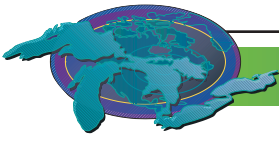
### Further Work Necessary

As noted in the SOLEC 2000 write-up, unemployment may not be sufficient as a sole measure for this indicator. Other information that is readily available from the U.S. Census Bureau and Statistics Canada includes poverty statistics for the overall population, children under age 18, families, and persons age 65 and older. Two examples of trends in those measures are shown in Figures 2 and 3. For persons of all ages within the U.S. Lake Superior basin for whom poverty status was established, 10.4 percent were below the poverty level in 1979. That figure had risen to 14.5 percent in 1989, a rate of increase higher than the states of Michigan, Minnesota, and Wisconsin and the U.S. overall over the same period. Poverty rates in all areas were lower in 1999, but the U.S. Lake Superior basin (and Ontario portion of the basin in 1996) was higher than any of the three states. The 1979 poverty rate for counties within the Lake Superior basin ranged from a low of 4.4 percent in Lake County, Minnesota, to a high of 17.0 percent in Houghton County, Michigan. In 1989 and 1999, those same counties again were the extremes. Similarly, among children under age 18, poverty rates in the Great Lakes basin portions of the three states in 1979, 1989, and 1999 exceeded the rates of Minnesota and Wisconsin as a whole, though they remained below the U.S. rate. In a region where one-tenth to one-sixth of the population lives in poverty, environmental sustainability is likely to be perceived by many as less important than economic development.

### Acknowledgments

Author: Kristine Bradof, GEM Center for Science and Environmental Outreach, Michigan Technological University, MI and James G. Cantrill, Communication and Performance Studies, Northern Michigan University, MI.

### Sources



GEM Center for Science and Environmental Outreach. (2000) Baseline Sustainability Data for the Lake Superior Basin: Final Report to the Developing Sustainability Committee, Lake Superior Binational Program, November 2000. Unpublished report, Michigan Technological University, Houghton, MI (<http://emmap.mtu.edu/gem/community/planning/lsb.html>)

Statistics Canada. Beyond 20/20 Census Subdivision Area Profiles for the Ontario Lake Superior Basin, 1996.

U.S. Census Bureau. State & County QuickFacts 2000. Table DP-3. Profile of Selected Economic Characteristics (<http://censtats.census.gov/data/MI/04026.pdf#page=3>).

U.S. Census Bureau. Population by Poverty Status in 1999 for Counties: 2000 (<http://www.census.gov/hhes/poverty/2000census/poppvstat00.html>).

U.S. Census Bureau. USA Counties 1998 CD-ROM (includes unemployment data from Bureau of Labor Statistics).

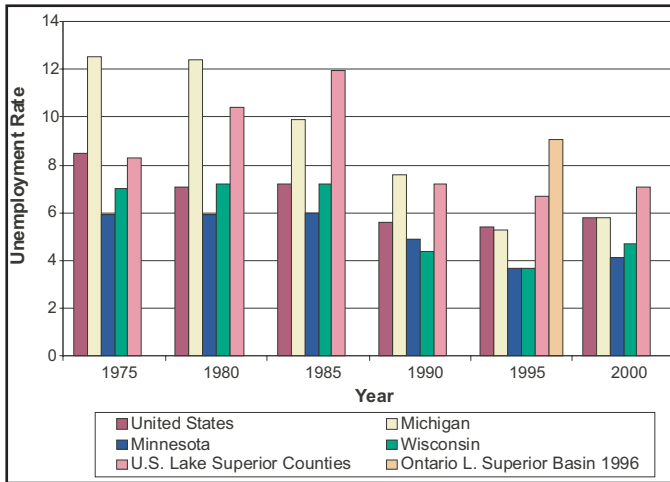


Figure 1. Unemployment rate in Michigan, Wisconsin, and the U.S. and Ontario Lake Superior basin, 1975-2000. Source: U.S. Census Bureau and Statistics Canada

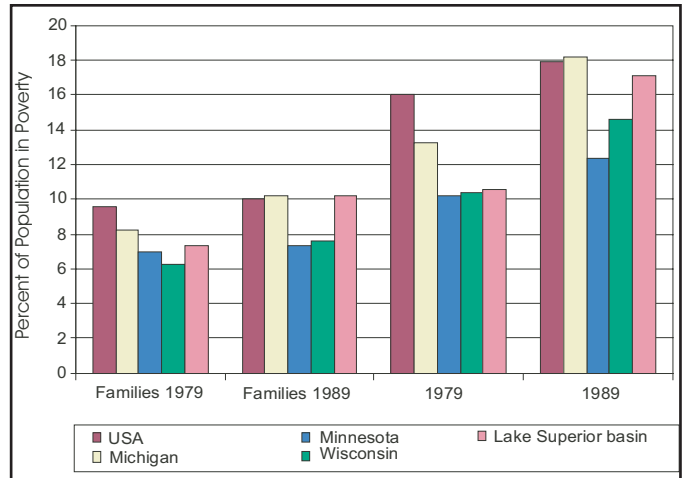


Figure 2. Individuals below poverty level in U.S. Great Lakes basin, 1979-1999, and families below poverty level in Ontario Great Lakes basin, 1999. Source: U.S. Census Bureau

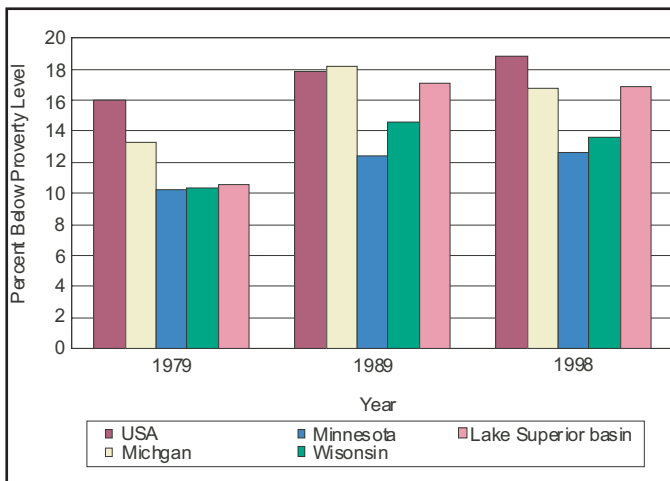
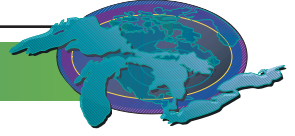


Figure 3. Children ages 18 or younger in poverty, 1979-1998, U.S. Lake Superior basin. Source: U.S. Census Bureau



## Water Withdrawals

SOLEC Indicator #7056

**Assessment: Mixed, Unchanging**

### Purpose

The rate of water withdrawal can be used to evaluate the sustainability of human activity in the Great Lakes basin. This indicator can also provide insight into the conservation of the physical, chemical and biological integrity of the basin ecosystem.

### Ecosystem Objective

The first objective is to protect the basin's water resources from long-term depletion. Although the volume of the Great Lakes is vast, less than one percent of their waters are renewed annually through precipitation, run-off and infiltration. Most water withdrawn is returned to the watershed, but water can be lost due to evapotranspiration, incorporation into manufactured goods, or diversion to other drainage basins. In this sense, the waters of the Great Lakes can be considered a nonrenewable resource.

The second objective is to minimize the ecological impacts stemming from water withdrawals. The act of withdrawing water can shift the flow regime, which in turn can affect the health of aquatic ecosystems. Water that is returned to the basin after human use can also introduce contaminants, thermal pollution or invasive species into the watershed. The process of withdrawing, treating and transporting water also requires energy.

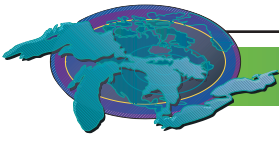
### State of the Ecosystem

Water was withdrawn from the Great Lakes basin at a rate of 46,046 millions of gallons per day (MGD) in 2000, with almost two-thirds withdrawn in the U.S. side (30,977 MGD) and the remaining one-third in Canada (15,070 MGD.) Self-supplying thermoelectric and industrial users withdrew over 80% of the total. Public water systems, which are the municipal systems that supply households, commercial users and other facilities, comprised 13% of withdrawals. The rural sector, which includes both domestic and agricultural users, withdrew 2%, with the remaining 3% used for environmental, recreation, navigation and quality control purposes. Hydroelectric use, which is considered "instream use" because water is not actually removed from its source, accounted for additional withdrawals at a rate of 799,987 MGD.<sup>1</sup>

Withdrawal rates in the late 1990s were below their historical peaks and do not appear to be increasing at present. In the U.S. side, withdrawals have dropped by more than 20% since 1980, following rapid increases from the 1950s onwards.<sup>2</sup> Canadian withdrawals continued rising until the mid-1990s, but have decreased by roughly 30% since then.<sup>3</sup> In both countries, the recent declines have been caused by the shutdown of nuclear power facilities, advances in water efficiency in the industrial sector, and growing public awareness on resource conservation. Part of the decrease, however, may be attributed to improvements in data collection methods over time.<sup>4</sup>

The majority of waters withdrawn are returned to the basin through run-off and discharge. Approximately 5% is made unavailable, however, through evapotranspiration or incorporation into manufactured products. This quantity, referred to as "consumptive use," represents the volume of water that is depleted due to human activity. It is argued that consumptive use, rather than total water withdrawals, provides a more suitable indicator on the sustainability of human water use in the region. Basin-wide consumptive use was estimated at 3,166 MGD in 2000. Although there is no consensus on an optimal rate of consumptive use, a loss of this magnitude does not appear to be placing significant pressure on water resources. The long-term Net Basin Supply of water (sum of precipitation and run-off, minus natural evapotranspiration), which represents the maximum volume that can be consumed without permanently reducing the availability of water, and equals the volume of water discharged from Lake Ontario into the St. Lawrence River, is estimated to be 132,277 MGD.<sup>5</sup> It should be noted, however, that focusing on these basin-wide figures can obscure pressures at the local watershed level.

Moreover, calculating consumptive use is a major challenge because of the difficulty in tracking the movement of water through the hydrologic cycle. Consumptive use is currently inferred by multiplying withdrawals against various coefficients, depending on use type. For instance, it is assumed that thermoelectric users consume as little as 1% of withdrawals, compared to a loss rate of 70-90% for irrigation.<sup>6</sup> There are inconsistencies in the coefficients used by the various states and provinces. Estimating techniques were even more rudimentary in the past, making it problematic to discuss historical consumptive use trends. Due to these data quality



concerns, it may not yet be appropriate to consider consumptive use as a water use indicator.

Water removals from diversions, by contrast, are monitored more closely, a result of the political attention that prompted the region's governors and premiers to sign the Great Lakes Charter in 1985. The Charter and its Annexes require basin-wide notification and consultation for water exports, while advocating that new diversions be offset by a commensurate return of water to the basin. The two outbound diversions approved since 1985 have accommodated this goal by diverting water in from external basins. The outbound diversions already in operation by 1985, most notably the Chicago diversion, were not directly affected by the Charter, but these losses are more than offset by inbound diversions located in northwestern Ontario. Thus, there is currently no net loss of water due to diversions.

There is growing concern over the depletion of groundwater resources, which cannot be replenished following withdrawal with the same ease as surface water bodies. Groundwater was withdrawn at a rate of 1,541 MGD in 2000, making up 3% of total water withdrawals.<sup>7</sup> This rate may not have a major effect on the basin as a whole, but high-volume withdrawals have outstripped natural recharge rates in some locations. Rapid groundwater withdrawals in the Chicago-Milwaukee region during the late 1970s produced cones of depression in that local aquifer.<sup>8</sup> However, the difficulty in mapping the boundaries of groundwater supplies makes unclear whether the current groundwater withdrawal rate is sustainable.

#### **Future Pressures**

The Great Lakes Charter, and its domestic legal corollaries in the U.S. and Canada, was instituted in response to concerns over large-scale water exports to markets such as the arid southwestern U.S. There does not appear to be significant momentum for such long-distance shipments due to legal and regulatory barriers, as well as technical difficulties and prohibitive costs. In the immediate future, the greatest pressure will come from communities bordering the basin, where existing water supplies are scarce or of poor quality. These localities might look to the Great Lakes as a source of water. Two border-basin diversions have been approved under the Charter and have not resulted in net losses of water to the basin. This outcome, however, was achieved through negotiation and was not proscribed by treaty or law.

As for withdrawals within the basin, there is no clear trend in forecasting regional water use. Reducing withdrawals, or at least mitigating further increases, will be the key to lessening consumptive use. Public water systems currently account for the bulk of consumptive use, comprising one-third of the total, and withdrawals in this category have been increasing in recent years despite the decline in total withdrawals. Higher water prices have been widely advocated in order to reduce water demand. Observers have noted that European per-capita water use is only half the North American level, while prices in the former are twice as high. However, economists have found that both residential and industrial water demand in the U.S. and Canada are relatively insensitive to price changes.<sup>9</sup> The over-consumption of water in North America may be more a product of lifestyle and lax attitudes. Higher prices may still be crucial for providing public water systems with capital for repairs; this can prevent water losses by fixing system leaks, for example. But reducing the underlying demand may require other strategies in addition to price increases, such as public education on resource conservation and promotion of water-saving technologies.

Assessing the availability of water in the basin will be complicated by factors outside local or human control. Variations in climate and precipitation have produced long-term fluctuations in surface water levels in the past. Global climate change could cause similar impacts; research suggests that water levels may be permanently lower in the future as a result. Differential movement of the Earth's crust, a phenomenon known as isostatic rebound, may exacerbate these effects at a local level. The crust is rising at a faster rate in the northern and eastern portions of the basin, shifting water to the south and west. These crustal movements will not change the total volume of water in the basin, but may affect the availability of water in certain areas.

#### **Further Work Necessary**

Water withdrawal data is already being compiled on a systemic basis. However, improvements can be made in collecting more accurate numbers. Reporting agencies in many jurisdictions do not have, or do not exercise, the statutory authority to collect data directly from water users, relying instead on voluntary reporting, estimates, and models. Progress is also necessary in establishing uniform and defensible measures of consumptive use, which is the component of water withdrawals that most clearly signals the sustainability of current water demand.

Mapping the point sources of water withdrawals could help identify local watersheds that may be facing significant pressures. In



many jurisdictions, water permit or registration programs can provide suitable geographic data. However, only in a few states (Minnesota, Illinois, Indiana and Ohio) are withdrawal data available per registered facility. Permit or registration data, moreover, has limited utility in locating users that are not required to register or obtain permits, such as the rural sector, or facilities with a withdrawal capacity below the statutory threshold (100,000 gallons per day in most jurisdictions.)

Further research into the ecological impact of water withdrawals should also be a priority. There is evidence that discharge from industrial and thermoelectric plants, while returning water to the basin, alters the thermal and chemical integrity of the lakes. The release of water at a higher than normal temperature has been cited as facilitating the establishment of non-native species.<sup>10</sup> The changes to the flow regime of water, through hydroelectric dams, internal diversions and canals, and other withdrawal mechanisms, may be impairing the health of aquatic ecosystems. Reductions in groundwater discharge, meanwhile, may have negative impacts on Great Lakes surface water quality.<sup>11</sup> Energy is also required for the process of withdrawing, treating and transporting water. These preliminary findings oblige a better understanding of how the very act of withdrawing water, regardless of whether the water is ultimately returned to the basin, can affect the larger ecosystem.

### Acknowledgements

Author: Mervyn Han, ECO Federal Government Associate on contact to U.S. EPA-GLNPO.

Rebecca Lameka (Great Lakes Commission), Thomas Crane (Great Lakes Commission), Wendy Leger (Environment Canada), and Fabien Lengelle (International Joint Commission) assisted in obtaining data for this report. Steven Renzetti (Brock University) and Michel Villeneuve (Environment Canada) assisted in explaining water consumption economics.

Site-specific water withdrawal data courtesy of James Casey (Illinois Department of Natural Resources), Sean Hunt (Minnesota Department of Natural Resources), Paul Spahr (Ohio Department of Natural Resources) and Ralph Spaeth (Indiana Department of Natural Resources). Ontario water permit map courtesy of Danielle Dumoulin (Ontario Ministry of Natural Resources).

### Footnotes and Sources

<sup>1</sup> Great Lakes Commission (GLC) (2004). Great Lakes Commission. Great Lakes Regional Water Use Database. Available online: <http://www.glc.org/wateruse/database/search.html>

<sup>2</sup> Historical U.S. data from Estimated Water Use in the United States circulars published at 5-year intervals by the U.S. Geological Survey since 1950. Available online: <http://water.usgs.gov/watuse/> USGS estimates show water withdrawals in the U.S. Great Lakes watershed increasing from 25,279 MGD in 1955 to a peak in the 36-39,000 MGD range during the 1970-80 period, but dropping to the 31-32,000 MGD range for 1985-1995. GLC reported U.S. water withdrawals in the 32-34,000 range for 1989-1993, and around 30,000 MGD since 1998, with 30,977 MGD in 2000.

<sup>3</sup> Historical Canadian data from Gaia Economic Research Associates (GERA) report, and are based on data from Statistics Canada and Environment Canada. In D. Tate and J. Harris (1999). Water Demands in the Canadian Section of the Great Lakes Basin, 1972-2021. GERA, Ottawa, Ont. GERA reported that Canadian water withdrawals increased from 8,136 MGD in 1972 to 21,316 MGD in 1996. GLC reported Canadian withdrawals of 21-24,000 MGD in 1989-1993, around 17,000 MGD for 1998 and 1999, and 15,070 MGD in 2000.

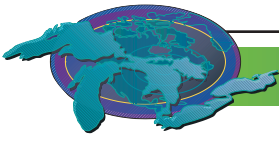
<sup>4</sup> U.S. Geological Survey (1985). Estimated Use of Water in the United States in 1985, p.68.

<sup>5</sup> Estimate is for period 1990-1999. Environment Canada, Great Lakes-St. Lawrence Regulation Office, 2004.

<sup>6</sup> Further details on consumptive use estimation methodology can be found in GLC (2003). Toward a Water Resources Management Decision Support System for the Great Lakes-St. Lawrence River Basin: Status of Data and Information on Water Resources, Water Use, and Related Ecological Impacts. Ch.3, pp.58-62. Available online: <http://www.glc.org/wateruse/wrmdss/finalreport.html>

<sup>7</sup> GLC (2004)

<sup>8</sup> A.P. Visocky (1997). Water-Level Trends and Pumpage in the Deep Bedrock Aquifers in the Chicago Region, 1991-1995. Illinois



State Water Survey Circular 182. Cited in International Joint Commission (2000). Protection of the Waters of the Great Lakes: Final Report to the Governments of Canada and the United States. Ch.6, p.26. Available online: <http://www.ijc.org/php/publications/html/finalreport.html>

<sup>9</sup> Econometric studies of both residential and industrial water demand consistently display relatively small price elasticities. Literature review on water pricing economics can be found in Renzetti, S. (1999). "Municipal Water Supply and Sewage Treatment: Costs, Prices and Distortions." The Canadian Journal of Economics. 32 (3): 688-704. However, the relationship between water demand and price structure is complex. The introduction of volumetric pricing (metering), as opposed to flat block pricing (unlimited use), is indeed associated with lower water use, perhaps because households become more aware of their water withdrawal rate. Discussion in D. Burke, L. Leigh and V. Sexton (2001). Municipal Water Pricing, 1991-1999. Environment Canada, Environmental Economics Branch.

<sup>10</sup> Mills, E. et al (1993). "Exotic Species in the Great Lakes: A History of Biotic Crises and Anthropogenic Introductions." J Great Lakes Res. 19 (1): 1-54.

<sup>11</sup> Observations summarized in IJC (2000), pp.20-22 and 26.

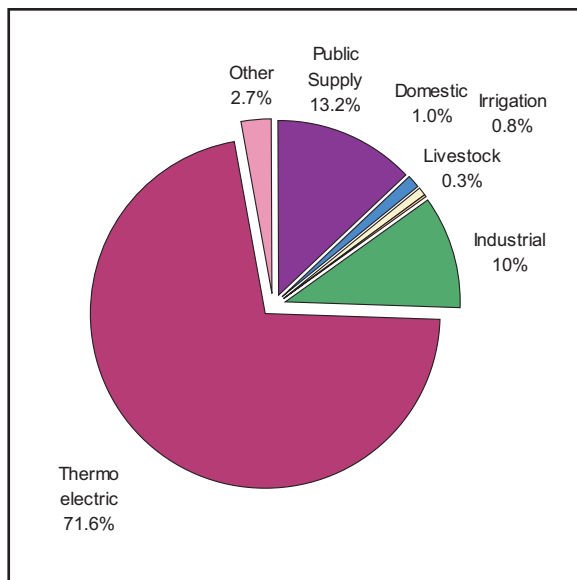
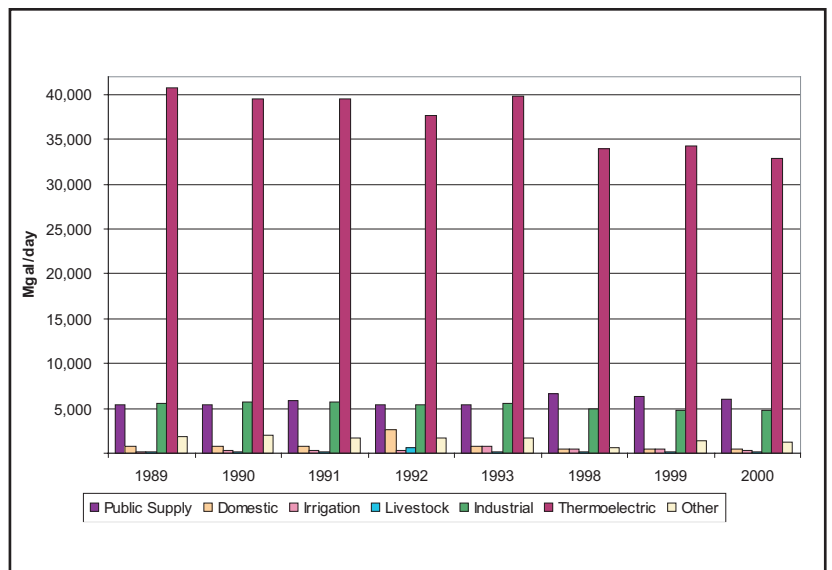


Figure 1. Water Withdrawals in the Great Lakes basin, by category as percentage of total, 2000. Source: Great Lakes Commission, 2004.

Figure 2. Great Lakes basin water withdrawals by category, 1989-1993 and 1998-2000. Source: Great Lakes Commission, 1991-2004.



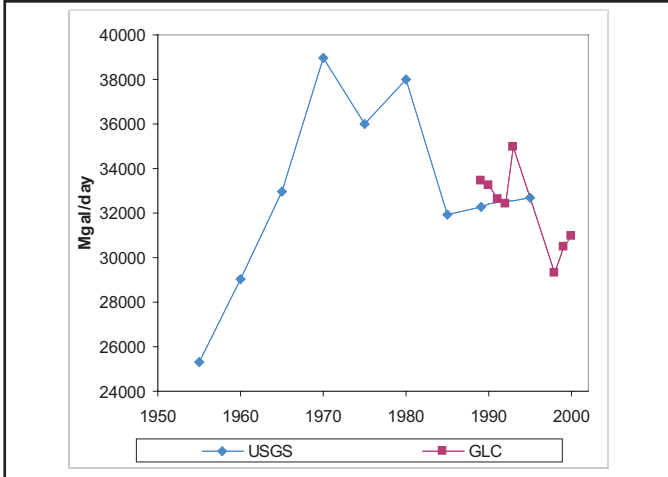
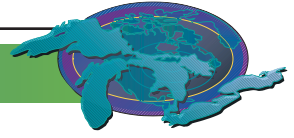


Figure 3. U.S. basin water withdrawals, 1950-2000. Sources: U.S. Geological Survey, Estimated Use of Water in the United States, 1950-1995. Great Lakes Commission.

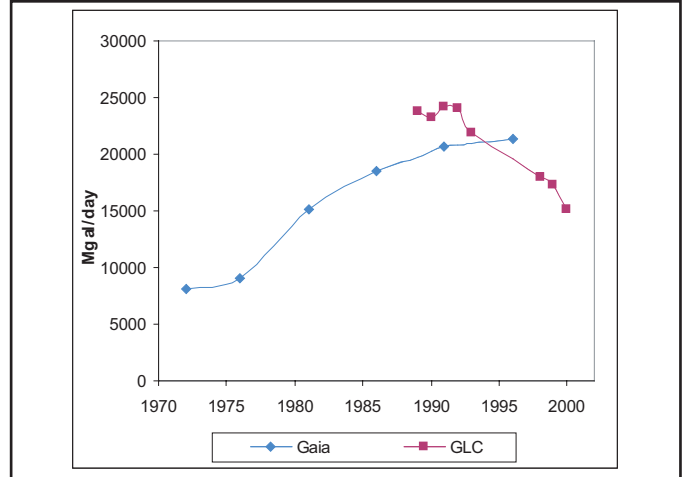


Figure 4. Canadian basin water withdrawals, 1972-2000. Sources: Gaia Economic Research Associates (1999), Water Demands in the Canadian Section of the Great Lakes Basin 1972-2021. Based on data from Environment Canada and Statistics Canada. Great Lakes Commission.

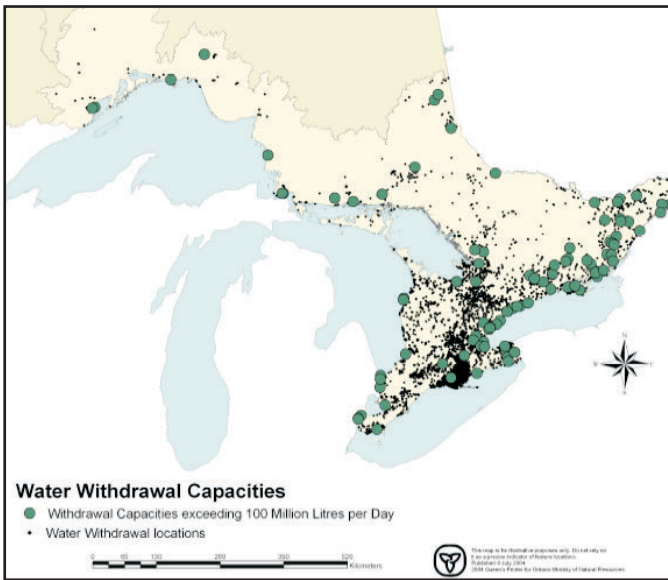
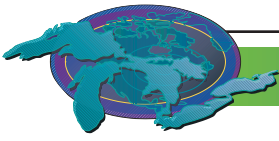


Figure 5. Permitted water withdrawal capacities in the Ontario portion of the Great Lakes basin.



Figure 6. Reported Water Withdrawals at Permitted or Registered Locations in Minnesota, Illinois, Indiana and Ohio. This map will be updated to include a legend and scale.





## Energy Consumption

SOLEC Indicator #7057

**Assessment: Mixed**

### Purpose:

This indicator assesses the energy consumed in the Great Lakes basin per capita. This assessment can be used to infer the demand for resource use, the creation of waste and pollution, and stress on the ecosystem.

### Ecosystem Objective:

Sustainable development is a generally accepted goal in the Great Lakes basin. Resource conservation minimizing the unnecessary use of resources is an endpoint for ecosystem integrity and sustainable development. This indicator supports Annex 15 of the Great Lakes Water Quality Agreement.

### State of the Ecosystem:

Energy use per capita and total consumption by each sector in the Great Lakes basin can be calculated using data extracted from the Comprehensive Energy Use Database, (Natural Resources Canada), and the State Energy Data 2000 Consumption tables (Energy Information Administration, 2000). Table 1 lists populations and total consumption in the Ontario and US basins, with the US broken down by states. For this report, the US side of the basin is defined as the portions of the 8 Great Lakes states within the basin boundary (thus, 214 counties). The Ontario basin is defined by 8 sub-basin watersheds. The most recent data available are from 2002 for Ontario and 2000 for the US. The largest change between 2000 and 2002 energy consumption by sector in Ontario was a 4.4% increase in the commercial sector (all other sectors changed by less than 2% in either direction).

In Ontario, the per capita energy consumption increased by 2% between 1999 and 2000. In the US basin, per capita consumption decreased by an average of 0.875% in 2000. Five states showed decreases in this metric, while three states had increases (Figure 1). Electrical energy consumption per capita was fairly similar on both sides of the basin in 2000 (Figure 2). Over the last four decades, consumption trends in the US basin have been fairly steady, although per capita consumption increased in each state from 1990 to 2000 (Figure 3). Interestingly, New York and Ohio consumed less per capita in 2000 than in 1970. Looking at the trends in Ontario from 1970 to 2000, the per capita energy consumption has stayed relatively consistent, with the exception of an increase seen in 1980. The per capita energy consumption figures for Ontario do not include the electricity generation sector due to an absence of data for this sector up until 1978. It is important to note that the quality of data processing and validation has improved over the last four decades and therefore the data quality may be questionable for the 1970's.

Total secondary energy consumption by the five sectors on the Canadian side of the basin in 2002 was 930,400,000 Megawatts-hours (MWh) (Table 1). Accounting for 33% of the total secondary energy consumed in the Canadian basin, electricity generation was the largest end user of all the sectors. The other four sectors account for the remaining energy consumption as follows: industrial, 22%; transportation 20%; residential, 15%; and commercial, 12%. Note that due to rounding, these figures do not add up to 100. There was a 0.5% increase in total energy consumption by all sectors in Ontario between 2000 and 2002. Note that secondary energy is the energy used to heat and cool homes and workplaces, and to operate appliances, vehicles and factories. It does not include intermediate uses of energy for transporting energy to market or transforming one energy form to another.

Total secondary energy consumption by the five sectors on the US side of the basin in 2000 was 3,364,000,000 MWh (Table 1). As in the Canadian basin, electricity generation was the largest consuming sector in the US basin, using 28% of the total secondary energy in the US side of basin. The US industrial sector consumed only slightly less energy, 27% of the total. The remaining three US sectors account for 44% of the total, as follows: transportation, 21%; residential, 14%; and commercial, 9%. Note that due to rounding, these percentages do not add up to 100. Figure 4 shows the total energy consumption by sector for both the Ontario and US sides of the Great Lakes basin in 2000. Table 2 lists the sector totals numerically.

Fossil fuels (natural gas, petroleum, and coal) are the dominating energy source in the Great Lakes basin. The residential sector includes four major types of dwellings: single detached homes, single attached homes, apartments and mobile homes, and excludes all institutional living facilities. Of the total secondary energy use in the Ontario basin in 2002 (Table 2), 67% of the energy consumed by this sector was fossil fuels (natural gas, 61%; and petroleum, 6%), 30% was electricity and 3% was wood. There was a



0.3% increase in total energy consumption by the Ontario residential sector between 2000 and 2002. On the US side of the basin, fossil fuels are the leading source of energy accounting for 75% of the total residential sector consumption (Table 2). Natural gas and petroleum are both consumed by this sector, but it is important to note that this sector has the highest natural gas consumption of all five sectors. The remaining sources were electricity, 22% and wood, 3%. Figure 5 shows energy consumption by source for the residential sector on both the Canadian and US sides of the basin in 2000.

The commercial sector includes all activities related to trade, finance, real estate services, public administration, education, commercial services (including tourism), government and institutional living and is the smallest energy consumer of all the sectors in both Canada and the US (Table 2). Of the total secondary energy use by this sector in the Ontario basin, 57% of the energy consumed was fossil fuels (natural gas, 50%; and petroleum, 7%) and 43% was electricity. In Ontario, this sector had the largest increase in total energy consumption, 4.4%, between 2000 and 2002. By source, on the US side of the basin, 61% was fossil fuels (natural gas, 53%; and petroleum, 8%) and 39% was electricity. On both sides of the basin, the commercial sector had the highest proportion of electricity use of any sector. Figure 6 shows energy consumption by source for the commercial sector for the Canadian and the US basins in 2000.

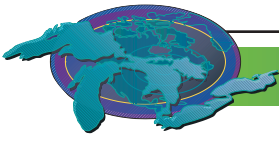
The industrial sector includes all manufacturing industries, metal and non-metal mining, upstream oil and gas, forestry and construction, and on the US side of the basin also accounts for agriculture, fisheries and non-utility power producers. Of the total secondary energy use by this sector on the Canadian side of the basin (Table 2), 71% of the energy consumed by this sector was fossil fuels (natural gas, 35%; petroleum, 20%; and coal, 16%), 19% was electricity, and the remaining 10% was wood. Between 2000 and 2002, consumption by industry in Ontario decreased by 1.8%. In addition to these energy sources, steam was a minor contributor to the total energy consumption.

On the US side of the basin, fossil fuels were the dominant energy source contributing 79% of the total energy (natural gas, 31%; coal, 24 %; and petroleum, 24%). The remaining sources were electricity, at 15%, and wood/ wood waste, at 7%. The trends seen in proportional use of fossil fuels, electricity, and wood sources are similar on both sides of the basin. Figure 7 shows energy consumption by source for the industrial sector on both the Canadian and US sides of the basin in 2000. It is important to note that the numbers given for the Ontario industrial sector are likely to be underestimations of the total energy consumption by the Canadian side of the basin. Numbers were estimated using the population in the Canadian side of the basin as a proportion of the total population in Ontario resulting in 87% of total industrial energy use in Ontario being contained within the basin. However, Stats Canada estimates that as much as 95% of industry in Ontario is contained within the basin. Estimating by population was done to remain consistent with the data provided for the U.S. side of the basin.

The transportation sector includes activities related to the transport of passengers and freight by road, rail, marine and air. Off-road vehicles, such as snowmobiles and lawn mowers, and non-commercial aviation are included in the total transportation numbers. On both sides of the basin, 100% of the total secondary energy consumed by the transportation sector (Table 2) was fossil fuels, specifically petroleum. Motor gasoline was the dominant form of petroleum consumed, making up 67% of the Ontario basin total and 70% of the US basin total. This was followed by diesel fuel, 27% in Ontario and 21% in the US, and aviation fuel, 6% in Canada and 9% in the US. Figure 8 shows energy consumption by source for the Canadian and US transportation sector in 2000, which had a decrease of 1.7% in total energy consumption on the Canadian side between 2000 and 2002.

The last, and the largest consuming sector in both the Canadian and the US basins, is the electricity generation sector. Of the total secondary energy use in the Ontario basin (Table 2), 67% of the energy consumed by this sector was by nuclear energy, 26% was fossil fuels (coal, natural gas and petroleum), and 7% was hydroelectric energy. There was an increase in total energy use of 1.9% between 2000 and 2002 in Ontario. It is important to note that the Great Lakes basin contains the majority of Canada's nuclear capacity. Of the total secondary energy use by this sector in the US basin (Table 2), 70% was in the following types of fossil fuels: coal (66%), natural gas (2%), and petroleum (2%). The other two major sources, nuclear and hydroelectric energy, provided 27% and 3% respectively. This sector consumed 75% of the coal used in the entire US basin. Figure 9 shows energy consumption by source for the electricity generation sector for the Canadian and US sides of the basin in 2000.

The overall trends in energy consumption by sector were quite similar on both sides of the basin. Ranked from highest to lowest energy consumption, the pattern for the sectors was the same for the US and Canadian basins (Table 2). Analyses of the sources of energy within each sector also indicate very similar trends. Based on this analysis, trends in resource consumption and lifestyle



seem quite comparable on both sides of the basin.

**Pressures:**

**Current Pressures:** In 2001, Canada was ranked as the fifth largest energy producer and the eighth largest energy consuming nation in the world. Comparatively, the United States is ranked as “the world’s largest energy producer, consumer, and net importer” (EIA, 2004). The factors responsible for the high energy consumption rates in Canada and the US can also be attributed to the Great Lakes basin. These include a high standard of living, a cold climate, long travel distances, and a large industrial sector. The combustion of fossil fuels, the dominant source of energy for most sectors in the basin, releases greenhouse gases such as carbon dioxide and nitrous oxide into the air contributing to smog, climate change, and acid rain.

**Future Pressures:** *Canada’s Energy Outlook 1996-2020* (<http://nrm1.nrcan.gc.ca:80/es/ceo/toc-96E.html>) notes that “a significant amount of excess generating capacity exists in all regions of Canada” because demand has not reached the level predicted when new power plants were built in the 1970’s and 1980’s. Demand is projected to grow at an average annual rate of 1.3 percent in Ontario and 1.0 percent in Canada overall between 1995 and 2020. From 2010-2020, Ontario will add 3,650 megawatts of new gas-fired and 3,300 megawatts of clean coal-fired capacity. Several hydroelectric plants will be redeveloped. Renewable resources are projected to quadruple between 1995 and 2020, but will contribute only 3 percent of total power generation.

The pressures the US currently faces will continue into the future, as the US works to renew its aging energy infrastructure and develop renewable energy sources. Over the next two decades, US oil consumption is estimated to grow by 33%, and natural gas consumption will increase by greater than 50%. Electricity demand is forecasted to increase by 45% nationwide (National Energy Policy Report, 2001). Natural gas demand currently outstrips domestic production in the US, with imports (largely from Canada) filling the gap. Five states, including three within the Great Lakes Basin (Illinois, Pennsylvania, and New York) generated almost 40% of the total US nuclear output (EIA 2004). Innovation and creative problem solving will be needed to work towards balancing economic growth and energy consumption in the Great Lakes basin in the future.

**Management Implications:**

The Natural Resources Canada, Office of Energy Efficiency has implemented several programs that focus on energy efficiency and conservation within the residential, commercial, industrial, and transportation sectors. Many of these programs work to provide consumers and businesses with useful and practical information regarding energy saving methods for buildings, automobiles, and homes. The Office of Energy Efficiency and Renewable Energy recently launched an educational website (<http://www.eere.energy.gov/consumerinfo/>), which provides homes and businesses with ways to improve efficiency, tap into renewable and green energy supplies, and reduce energy costs. In July 2004, Illinois, Minnesota, Pennsylvania, and Wisconsin were awarded \$46.99 million to weatherize low-income homes, which is expected to save energy and cost (EERE, 2004). The EPA Energy Star program, a government/industry partnership initiated in 1992, also promotes energy efficiency through product certification. In 2002, Americans saved more than \$7 billion in energy costs through Energy Star, while consuming less power and preventing greenhouse gas emissions (EPA 2003).

In addition to these programs, the Climate Change Plan for Canada challenges all Canadians to reduce their greenhouse gas emissions by one tonne, approximately 20 percent of the per capita production on average each year. The One-Tonne Challenge offers a number of ways to reduce the greenhouse gas emissions that contribute to climate change and in doing so will also reduce total energy consumption.

Renewable energy sources such as solar and wind power are available in Canada, but make up only a fraction of the total energy consumed. Research continues to develop these as alternate sources of energy, as well as developing more efficient ways of burning energy. In the United States, according to the US Energy Information Administration, 6% of the total 2002 energy consumption came from renewable energy sources (biomass- 47%, hydroelectric- 45%, geothermal- 5%, wind-2%, and solar- 1%). The US has invested almost a billion dollars, over three years, for renewable energy technologies (Garman, 2004). Wind energy, cited as one of the fastest growing renewable sources worldwide, is a promising source for the Great Lakes region. The US Department of Energy, its laboratories, and state programs are working to advance research and development of renewable energy technologies.

**Future Work Necessary:**

Ontario data are available through Natural Resources Canada, Office of Energy Efficiency. Databases include the total energy con-



sumption for the residential, commercial, industrial, transportation, agriculture and electricity generation sectors by energy source and end use. Population numbers for the Great Lakes basin, provided by Stats Canada, were used to calculate the energy consumption numbers within the Ontario side of the basin. This approach for the residential sector should provide a reasonable measure of household consumption. For the commercial, transportation and especially industrial sectors, it may be a variable estimation of the total consumption in the basin. The data are provided on nation-wide, statewide, or province-wide basis. Therefore it provides a great challenge to disaggregate it by any other methods to provide a more precise representation of the Great Lakes basin total energy consumption.

Energy consumption, price, and expenditure data are available for the United States (1960-2000) through the Energy Information Administration. The EIA is updating the State Energy Data 2000 series to 2001 by August 2004. There may be minor discrepancies in how the sectors were defined in the US and Canada, which may need to be further investigated (such as tourism in the US commercial sector, and upstream oil and gas in the US industrial sector). Actual differences in consumption rates may be difficult to distinguish from minor differences between the US and Canada in how data were collected and aggregated. Hydroelectric energy was not included in the industrial sector analysis, but might be looked at in future analyses (In NY state, almost as much energy came from hydroelectric energy as from wood). Wisconsin and Pennsylvania also had small amounts of hydropower consumption. The current analysis of the total basin consumption is based on statewide per capita energy consumption, multiplied by the basin population. The ideal estimate of this indicator would be to calculate the per capita consumption within the basin, and would require energy consumption data at the county level or by local utility reporting areas. Such data may be quite difficult to obtain, especially when electricity consumption per person is reported by utility service area. The statewide per capita consumption may be different than the actual per capita consumption within the basin, especially for the states with only small areas within the basin (Minnesota and Pennsylvania). The proportion of urban to rural/agricultural land in the basin is likely to influence per capita consumption within the basin. Census data are available at the county and even the block level, and may in the future be combined with the US basin boundary using GIS to refine the basin population estimate.

Additionally, the per capita consumption data for the US in Figures 1, 2, and 3 are based on slightly different energy consumption totals than the data in Tables 1 and 2. Figures 1, 2, and 3 include some minor sources (listed in the footnotes) which were excluded from the sector analyses. This was due to time constraints and differences between the US and Canadian data, and a bit more coordination was needed between the two US authors. The next update of this indicator should examine whether it is worthwhile to include the minor sources in the sector analysis on both sides of the basin or to exclude them from the per capita figures.

#### **Acknowledgments:**

Authors: Susan Arndt, Environment Canada – Ontario Region, Burlington, ON  
Christine McConaghy, ORISE, on assignment to USEPA-GLNPO – Chicago, IL  
Leena Gawri, ORISE, on assignment to USEPA-GLNPO – Chicago, IL

#### **Sources:**

Canada and US Country Analysis Briefs, Energy Information Administration [Online]  
Available: <http://www.eia.doe.gov/emeu/cabs/canada.html>

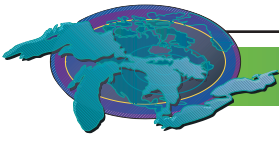
EERE Network News [Online] (July 29, 2004). Available: [http://www.eere.energy.gov/news/news\\_detail.cfm/news\\_id=7438](http://www.eere.energy.gov/news/news_detail.cfm/news_id=7438)

Energy Efficiency Trends in Canada 1990-2000 (June 2002), Natural Resources Canada [Online]  
Available: <http://oee.nrcan.gc.ca/neud/dpa/home.cfm>

Environmental Signals, Canada's National Environmental Indicator Series 2003, Environment Canada; Energy Consumption pp 56-59 [Online]  
Available: <http://www.ec.gc.ca/soer-ree>

Human Activity and the Environment 2000, Statistics Canada [CDRom]

National Energy Policy. May 2001. Report of the National Energy Policy Development Group [Online]  
Available: [http://energy.gov/engine/content.do?BT\\_CODE=AD\\_AP](http://energy.gov/engine/content.do?BT_CODE=AD_AP)



Ontario data obtained from Natural Resources Canada, Comprehensive Energy Use Database [Online]  
 Available: [http://oe.nrcan.gc.ca/neud/dpa/comprehensive\\_tables/](http://oe.nrcan.gc.ca/neud/dpa/comprehensive_tables/)

Testimony before the Committee on Energy and Natural Resources, United States Senate. “Administration’s views on the role that renewable energy technologies can play in sustainable electricity generation.” Garman, David K. April 27, 2004. Available: [http://www.eere.energy.gov/office\\_eere/congressional\\_test\\_042704.html](http://www.eere.energy.gov/office_eere/congressional_test_042704.html)

US 2000 Decennial Census data. US Census Bureau and Texas State Data Center, Department of Rural Sociology, Texas A&M University. Available: <http://www.census.gov/dmd/www/resapport/states/indiana.pdf> (replace Indiana with any state name), and [http://www.txscd.tamu.edu/txdata/apport/hist\\_a.php](http://www.txscd.tamu.edu/txdata/apport/hist_a.php)

US Energy Information Administration (EIA). 2000. State Energy Data 2000 Consumption Tables. Available: <http://www.eia.doe.gov>

US EPA. 2003. ENERGY STAR — The Power to Protect the Environment through Energy Efficiency. [http://www.energystar.gov/ia/partners/downloads/energy\\_star\\_report\\_aug\\_2003.pdf](http://www.energystar.gov/ia/partners/downloads/energy_star_report_aug_2003.pdf)

State/Province	Total Energy Consumption by state/province within the Great Lakes Basin (MWh)	Population within the basin*
Ontario (2002 data)	930,400,000	9,912,707
US Basin Total (2000 data)	3,364,000,000	31,912,867
Illinois (IL)	669,400,000	6,025,752
Indiana (IN)	304,900,000	1,845,344
Michigan (MI)	998,500,000	9,955,795
Minnesota (MN)	36,600,000	334,444
New York (NY)	309,600,000	4,506,223
Ohio (OH)	614,000,000	5,325,696
Pennsylvania (PA)	43,700,000	389,210
Wisconsin (WI)	387,300,000	3,530,403

Table 1: Energy Consumption and Population within the Great Lakes Basin, by state for the year 2000 (US) and 2002 (Ontario). The US basin population was calculated from population estimates by counties from the 2000 US Census (US Census Bureau, 2000). A list of the 214 counties within the basin is available upon request. Ontario Basin populations were determined using sub-basin populations provided by Stats Canada.

Sector	US Basin Total Energy Consumption— 2000 <sup>1</sup>	Canadian Basin Total Energy Consumption – 2002
Residential	478,200,000	127,410,000
Commercial	314,300,000	107,800,000
Industrial	903,900,000	206,410,000
Transportation	714,000,000	184,950,000
Electricity Generation	953,600,000	303,830,000

Table 2: Total Secondary Energy Consumption in the Great Lakes Basin, in Megawatts-hours (MWh)

<sup>1</sup> Note: 2000 is the most recent data available on a consistent basis for the US. More recent data is available for some energy sources from the EIA, but survey and data compilation methods may vary.

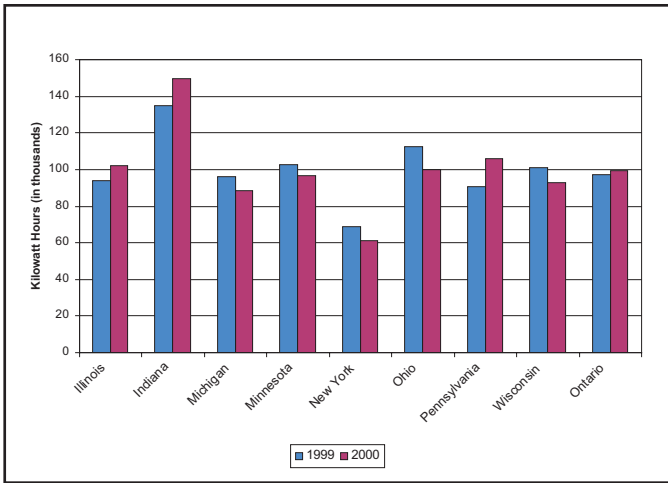
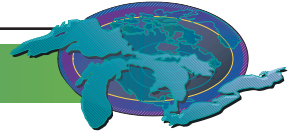


Figure 1: Total energy consumption per capita 1999-2000. 1 MWh = 1000 kWh. Data: Energy Information Administration (2000), Natural Resources Canada

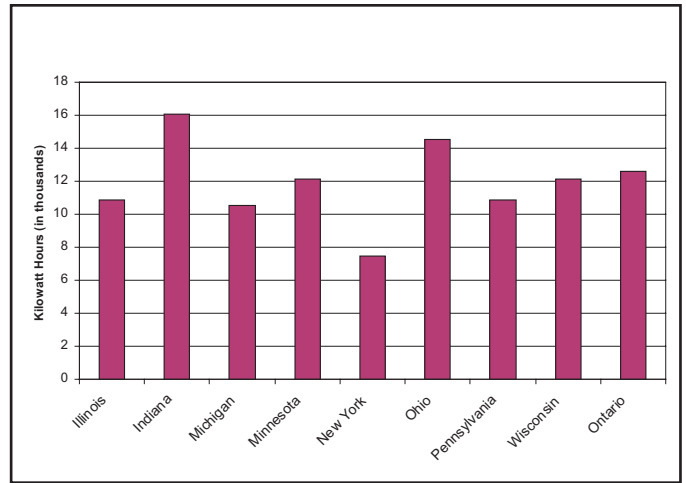


Figure 2: Electric energy consumption per capita 2000. 1 MWh = 1000 kWh. Data: Energy Information Administration (2000), Natural Resources Canada

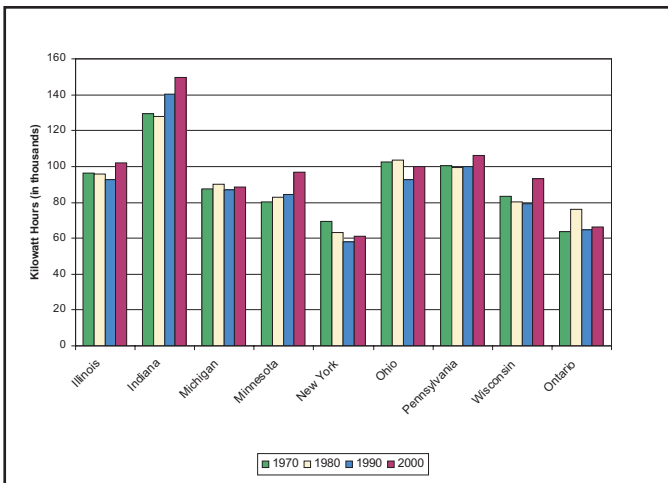


Figure 3: Total per capita energy consumption 1970-2000. 1 MWh = 1000 kWh. The category “Other” includes geothermal, wind, photovoltaic, and solar energy. The Ontario data do not include the electricity generation sector due to an absence of data for this sector until 1978. Data: Energy Information Administration (2000), Natural Resources Canada

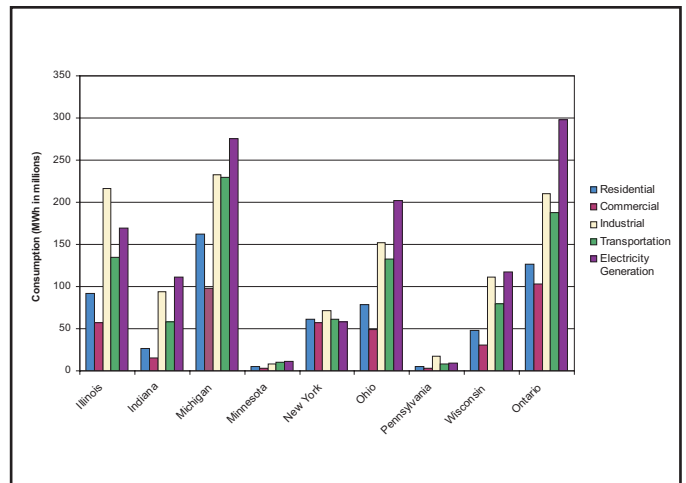


Figure 4: Energy consumption within the Great Lakes basin by sector. Note: All data are from 2000, although 2002 data from Ontario are discussed in the report. Data: Energy Information Administration (2000), Natural Resources Canada

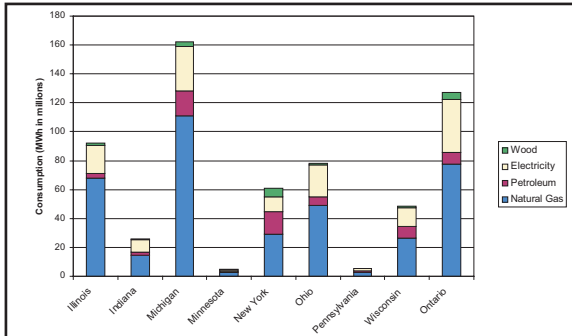
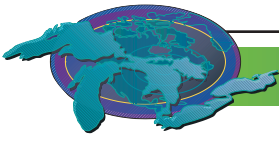


Figure 5: Residential sector energy consumption by source, 2000. Coal, geothermal, and solar energy were minor sources in this sector. Data: Energy Information Administration (2000), Natural Resources Canada

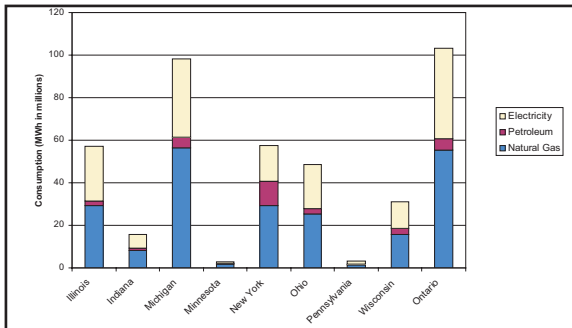


Figure 6: Commercial sector energy consumption by source, 2000. Wood and coal were minor sources in this sector. Data: Energy Information Administration (2000), Natural Resources Canada

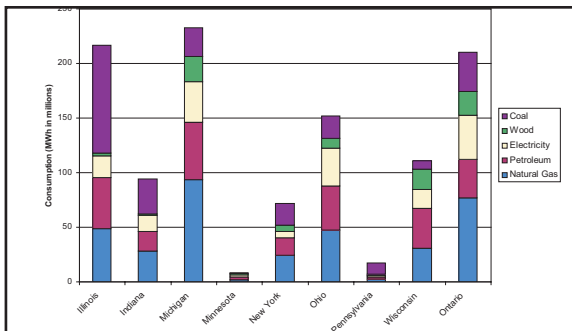


Figure 7: Industrial sector energy consumption by source, 2000. Hydroelectric power was a minor source in this sector. US data are for wood and wood waste. Data: Energy Information Administration (2000), Natural Resources Canada

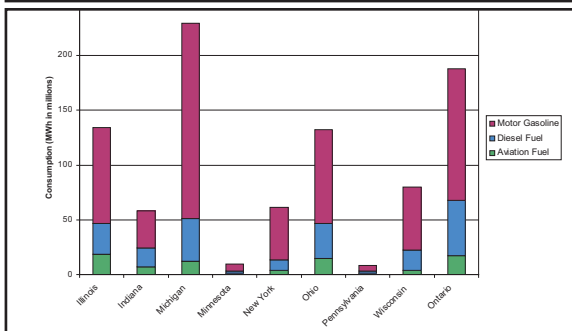


Figure 8: Transportation sector energy consumption by source, 2000. Natural gas and electricity were very minor energy sources in this sector. Data: Energy Information Administration (2000), Natural Resources Canada

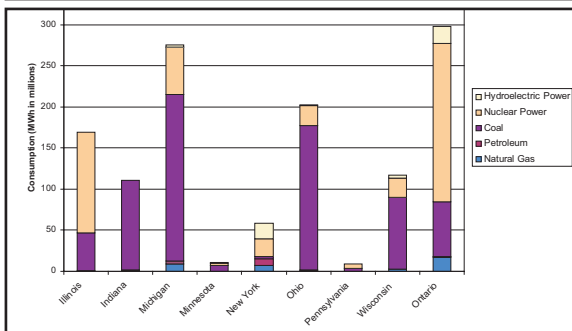
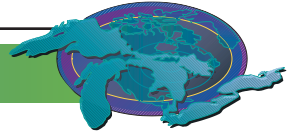


Figure 9: Electricity generation sector energy consumption by source, 2000. Wood and wood waste were very minor energy sources in this sector. Data: Energy Information Administration (2000), Natural Resources Canada



## Solid Waste Generation

Indicator ID #7060

*This indicator report is from 2002.*

### Assessment: Mixed

Data from multiple sources are not consistent.

### Purpose

To assess the amount of solid waste generated per capita in the Great Lakes basin (GLB), and to infer inefficiencies in human economic activity (i.e. wasted resources) and the potential adverse impacts to human and ecosystem health.

### Ecosystem Objective

Solid waste provides a measure of the inefficiency of human land based activities and the degree to which resources are wasted. In order to promote sustainable development, the amount of solid waste generated in the basin needs to be assessed and ultimately reduced. Reducing volumes of solid waste are indicative of a more efficient industrial ecology and a more conserving society. Reduced waste volumes are also indicative of a reduction in contamination of land through landfilling and incineration and thus reduced stress on the ecosystem. This indicator supports Annex 12 of the Great Lake Water Quality Agreement (GLWQA)

### State of the Ecosystem

Canada and the United States are among the highest waste producers on Earth. However, both countries are working towards improvements in waste management by developing efficient strategies to reduce, prevent, reuse and recycle waste generation. Figure 1 displays the average per capita municipal solid waste generation in a selection of some of the most populated municipalities in the Ontario portion of the Great Lakes basin during 1991-2001. From this data, it is evident that there is a continual decline of municipal solid waste generation from 1991 to present. 1991 had the highest per capita generation at a value of 0.681. Per capita solid waste generation declined ~45% in 2001 to a value of 0.373. The rate of per capita municipal solid waste generation appears to have leveled off in the late 1990's. And it must be noted that the apparent increase in per capita generation in 2000 may not be completely accurate since there was less data collected to obtain the average for 2000 as compared to 1999 and 2001. The decline in per capita solid waste generation in the early 1990's can be attributed to the increased access to municipal curbside recycling, backyard and centralized composting programs in most Ontario municipalities.

In addition, Figure 1 displays the average per capita municipal solid waste generation (MSWG) disposed in Minnesota's counties of the Great Lakes basin during 1991-2000. The data shows the amount of MSWG disposed declined slightly from 1991 to 1993, and then increased from 0.386 tones per capita in 1994 to 0.436 tones per capita in 2000. The data suggests that these trends in MSWG are not significant despite growth in population over the same time period. The counties of Cook, Lake and Pine represent the highest increase of per capita SWG during 1993 to 2000. For example, Cook County in 1993 increased 45% of the municipal SWG.

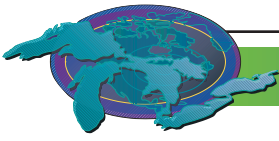
Figure 1, also displays the average trends of the waste disposed per capita (in tons) in Indiana by estimated county of origin in a final disposal facility. The graphic shows a 21% increase in the per capita of non-hazardous waste disposed between 1992 and 1998. From 1998 to 2000 there was a 9% decrease of the amount disposed.

The Illinois Environmental Protection Agency, Bureau of Land, reported the projected disposal capacity of the solid waste in sanitary landfills for 2000. The regional waste disposed and landfill capacity (in tons) for the Great Lake basin counties was 1.7 percent cubic yards. This area has a per capita capacity below of the state average. The municipal wastes generated and recycled was 7.4 cubic yards.

The Michigan Department of Environmental Quality (DEQ) reports on data of total waste disposed in Michigan landfills in per capita cubic yards from 1996 to 2001. In 1996 the solid waste landfilled per capita was 3.76 cubic yards and in 2001 the value increased to 4.84, showing a 32% increase of solid waste disposed in landfills.

New York Department of Environmental Conservation provided the State SWG data from 1990 to 1998. The data reflects that the average of SWG in per capita from 1990 to 1998 increased a 20% and decreased a 3% from 1995 to 1996. The New York statewide





of reusable tons increased approximately 30% of the waste disposed.

The Region 3 of the Environmental Protection Agency in Pennsylvania provided the daily per capita amount of Pennsylvania counties in the GLB of MSW generated. In 1998 the MSW generated for Crawford was 2.4 (pounds/person/day), 3.8 for Erie and 1.4 for Potter. The amount of MSW per capita in 1999 for those counties increased, Crawford had 2.59, Erie 3.73 and Potter 2.64 daily per capita generations. The Department of Environmental Protection (DEP) provided the statewide MSW generation during 1988 to 2000 that increased 30% of the waste disposed.

The calculated average per capita municipal waste landfilled in Wisconsin in 2001 was 1.85 tons, as reported by the Department of Natural Resources. The counties with the larger average values are those located closer to the Lake Michigan. For example, Calumet average value is 4.87 tons per person, Dodge is 4.20, Green Lake is 12.11, Kenosha is 3.80 and Manitowoc 4.35 tons per person.

The Ohio Environmental Protection Agency provided the residential and commercial solid waste management district landfill generated, disposed and recycling data according to the 88 counties, which are grouped into 52 single and multi-county districts. The Northeast District Office (NEDO) and the Northwest District Office (NWDO) are districts that include the counties in the Great Lakes basin. Figure 2 presents the average amount of the NEDO and NWDO residential and commercial solid waste management district (SWMD) generated, disposed and recycled for 1999 and 2000. The disposal value of solid waste for NEDO increased 3%. The amount of GSW increased 6% for NWDO over the same time period. The recycled amount increased 2% for NEDO and 32% for NWDO from 1999 to 2000.

Reuse and recycling are opportunities to reduce solid waste levels. By looking at recycling and waste diversion in Ontario, both the tonnage of municipal solid waste diverted from disposal and the number of households with access to recycling have increased in recent years (WDO, 2001c).

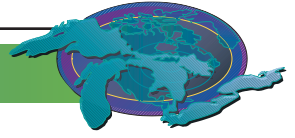
Figure 3 shows the trends in residential recycling tonnages in all of Ontario from 1992-2000 (WDO, 2001). From this figure it is evident that there has been a 41% increase in the amount of residential recycling from 1992-2000, which may be accounting for the reduced per capita solid waste generation displayed in recent years in Ontario municipalities.

#### **Future Pressures**

The generation and management of solid waste raise important environmental, economic and social issues for North Americans. It costs billions of dollars per year and is filling up fast. In addition, the generation of municipal solid waste contributes to soil and water contamination and even air pollution etc. It is estimated that far more residential solid waste is being generated each year, but a greater proportion is being recovered for recycling and reuse. The state of the economy has a strong impact on consumption and waste generation. Waste generation continued to increase through the 1990's as economic growth continued to be strong (US EPA, 2002). Much of this increase in waste generation in the 1990's was due to the booming economy and many people found themselves with a large disposable income (US EPA, 2002). An economic growth results in more products and materials being generated. This growth should send a message for a larger investment in source reduction activities. Source reduction activities will help to save natural resources, it will reduce the toxicity of wastes and it will also reduce costs in waste handling and will make businesses more efficient.

#### **Future Activities**

There is a need to assess and determine which material makes up the majority of the municipal solid waste that is generated each year. This will help managers target waste reduction efforts towards limiting the amount of these products that make it through the waste stream. It would also be interesting to research how different waste reduction techniques can produce differing trends in solid waste reduction. For example, user pay, "PAYT" (pay as you throw away) unit-based pricing, is becoming a more acceptable method for financing residential waste management services and making households more directly responsible for their waste generation and disposal habits (WDO, 2001a). Bag limits on waste are usually a first step many municipalities take in order to make the transition to user pay systems easier. User pay programs have gained momentum across most of Canada with most growth occurring in the mid to late 1990's. Imposing these limits encourages homeowners to be more conscious of the amount and type of waste generated as they now associate a financial cost with their consumptive behavior. It makes a homeowner personally responsible and encourages alternative waste diversion activities. Other examples are an ambitious statewide education campaign dedicated to educate the residents on the benefits of waste reduction and to show them how solid waste can affect their own health and the health of



their environment. A local government waste prevention program consisting of a network of counties and cities was organized to discuss and create methods to help in waste reduction activities that would better protect the state's environment and public health. Developing methods for standardizing information and for tracking waste will aid in improving the sharing of information and data statewide.

#### **Further Work Necessary**

The province of Ontario has set a challenging task for the WDO to reach a 50% waste diversion. Ontario residents diverted at total of 29% of 1.23 million tones of their residential waste from disposal in 1998. In order to achieve a 50% reduction in waste the following practices need to be encouraged: increased financial support, expand provincial 3R regulations, need to change societal habits and behavior towards waste generation, need to invest more into infrastructure and lastly, the adoption of waste management user fees (WDO, 2001b).

To report on this indicator in the future, data on waste diversion should be incorporated as well as waste generation. Looking at the changes in the amount of waste that is removed from the waste stream can be used to infer how the behavior of society is changing with regards to wasting resources and sustainable development.

During the process of collecting data from this indicator, it was found that most U.S. states and Ontario municipalities compile and report on solid waste information in different formats. Future work to organize a standardized method of collecting, reporting and accessing data for both the Canadian and U.S. portions of the Great Lakes basin will aid in the future reporting of this indicator.

#### **Acknowledgments:**

Authors: Martha I. Avilés-Quintero, USEPA–GLNPO, Chicago, IL and Melissa Greenwood, Environment Canada, Downsview ON.

Ontario data for the disposal of waste by province was obtained from Statistics Canada, Environmental Account and Statistics Division, and Demography Division (<http://www.statcan.ca/start.html>).

Data collected are based on the values obtained by contacting the waste management departments of Ontario municipalities around the Great Lakes Basin. For any further details regarding specific municipalities, please contact Melissa Greenwood.

The recycling data collected from the province of Ontario, were adapted from the Municipal 3Rs in Ontario: 2000 Fact Sheet, published by the WDO – Ontario Waste Diversion Organization (<http://www.wdo.on.ca>).

The United States data of municipal waste generated per capita, average, landfill capacity, disposed and recycled waste were collected by contacting the different State and Federal Agencies managements departments and searching their websites. The U.S. Environmental Protection Agency, Region 5, Pollution Prevention & Program Initiatives Section provided the contact list for the searching values. Some data were adapted using the counties on the Great Lakes basin and using the census-estimate populations to calculate the per capita generation, disposed and recycled.

Illinois data of the Waste Disposed and Landfill Capacity per capita in cubic yards by Region for 2000, was provided by the Illinois Environmental Protection Agency (IEPA), Bureau of Land. The Region 2 is the Chicago Metropolitan basin that included counties on the Great Lakes Basin. (<http://www.epa.state.il.us>)

Indiana data of the Municipal solid waste per capita for 2001, was offered from Indiana Department of Environmental Management (IDEM). Also, we used the 2000 Summary of Indiana Solid Waste Facility Data Report to calculate the waste disposed per capita. We used the census-estimate population for 1992-2000 by counties on the Great Lakes Basin to obtain those values. (<http://www.in.gov.idem/land/sw/index.html>)

Michigan data of the total solid waste disposed in Michigan Landfills per capita in cubic yards for 1996-2001, was provided by Michigan Department of Environmental Quality, Waste Management Division. The report was used and adapted to calculate the per capita amount using the census-estimated population 1996-2001. (<http://www.deq.state.mi.us>)



Minnesota data of the Municipal solid waste generation per capita for 1991- 2000, was provided by Minnesota Office of Environmental Assistance (MOEA). The SCORE report is a full report to the Legislature that the main components is to identify and targeting source reduction, recycling, waste management and waste generation collected from all 87 counties in Minnesota. (<http://www.moea.state.mn.us>)

New York data of the Solid waste generated and recycled in tones for 1990-1998, was provided by New York State Department of Environmental Conservation, Division of Solid and Hazardous Materials. The data was adapted to obtain the per capita generation with the census-estimate population per year. (<http://www.dec.state.ny.us>)

Ohio data of Disposed and recycled generated solid waste per capita in landfills for each solid waste management district for 1999-2000, was provided by Ohio Environmental Protection Agency, Division of Solid Waste and Infectious Waste Management. The data of Northeast and Northwest district office was adapted by counties on the Great Lakes basins and census-estimate data population per year. (<http://www.epa.state.oh.us>)

Pennsylvania data of the Average per capita recycled generation rates was provided by Pennsylvania Department of Environmental Protection, Bureau of Land Recycling and Waste Management. (<http://www.dep.state.pa.us>)

Wisconsin data of municipal waste landfill tones capacity for 2001, was provided by Wisconsin Department of Natural Resources (DNR), Bureau of Waste Management. (<http://www.dnr.state.wi.us>)

**Sources:**

Statistics Canada (2001). Environmental Account and Statistics Division, and Demography Division. Disposal of Waste by Province and Territory, 2000 Preliminary Estimates, [online] Available: <http://www.statcan.ca/start.html>  
Accessed [2002-06-24]

WDO-Ontario Waste Diversion Organization. (2001a). The Waste Diversion Impacts of Bag Limits and PAYT Systems in North America. [online] Available <http://www.wdo.on.ca> Accessed [2002-08-02]

WDO-Ontario Waste Diversion Organization (2001b). Waste Diversion and Concept Testing, Qualitative and Quantitative Findings. [online] Available at: <http://www.wdo.on.ca>. Accessed [2002-08-02]

WDO-Ontario Waste Diversion Organization (2001c). Municipal 3Rs in Ontario: 2000 Fact Sheet. [online] Available at: <http://www.wdo.on.ca>.  
Accessed [2002-07-22]

U.S. Census Bureau. 1990's, 2000's Population Estimates, [online] Available [online] [www.census.gov/popest/estimates.php](http://www.census.gov/popest/estimates.php)

US EPA. (June 2002). Municipal Solid Waste in the United States: 2000 Facts and Figures. Office of Solid Waste and Emergency Response (5305N) EPA530-R-02- 001, [online] Available <http://www.epa.gov> Accessed [2002, 08-02]

Illinois Environmental Protection Agency, Bureau of Land, Annual Landfill Capacity Report (January 2002). Non-hazardous Solid Waste Management and Landfill Capacity in Illinois. [IEPA/BOL/01-014]  
(<http://www.epa.state.il.us/land/landfill-capacity/index.html>)

Indiana Department of Environmental Management, Office of Land Quality, 2000 Summary of Indiana Solid Waste Facility Data Report. (<http://www.state.in.us/idem/land/sw/qtrlyrpts/fars/far00.pdf>)

Michigan Department Environmental Quality, Waste Management Division, Report of Solid Waste Landfilled in Michigan (February 2002).  
([http://www.michigan.gov/deq/1,1607,7-135-3312\\_4123-47581--,00.html](http://www.michigan.gov/deq/1,1607,7-135-3312_4123-47581--,00.html))

Minnesota Office of Environmental Assistance, Report on 2000 SCORE Programs, A Summary of Waste Management in Minnesota 2000 (April 2002). (<http://www.moea.state.mn.us/lc/score00.cfm>)

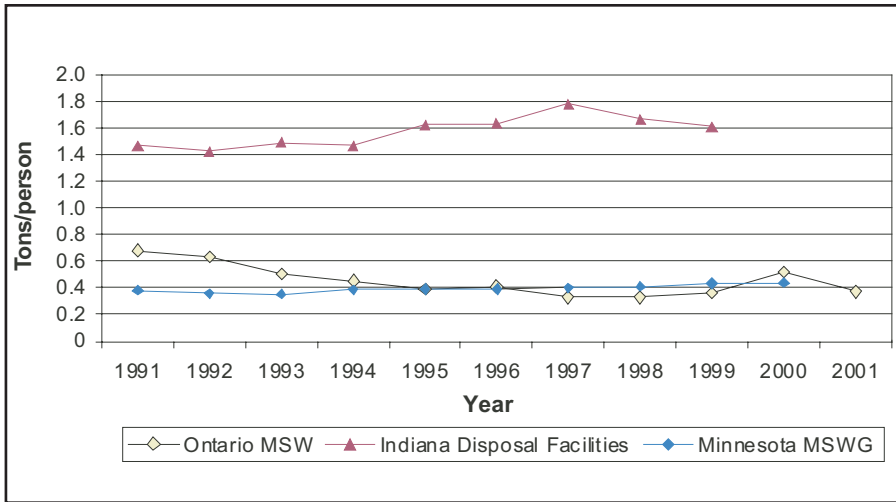
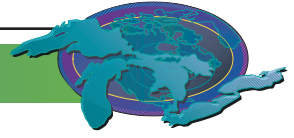


Figure 1. Average per capita solid waste generation and disposal (tons/person) from selected municipalities in Ontario, Indiana and Minnesota, 1991-2001. MSW = Municipal Solid Waste; MSWG = Municipal Solid Waste Generation. Sources: IDEM-Indiana Department of Environmental Management, 2000; MOEA-Minnesota Office of Environmental Assistance, 2000, Ontario data obtained from Statistics Canada, Environmental Account and Statistics Division, and Demography Division

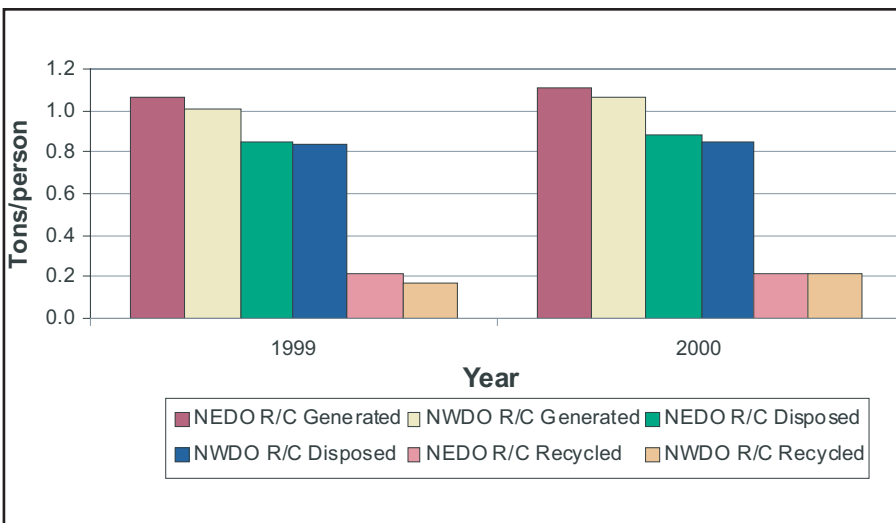


Figure 2. Ohio counties average per capita solid waste landfill facilities generated, disposed and recycled in the Great Lakes basin, 1999-2000. Source: Ohio Environmental Protection Agency, Division of Solid and Infectious Waste Management

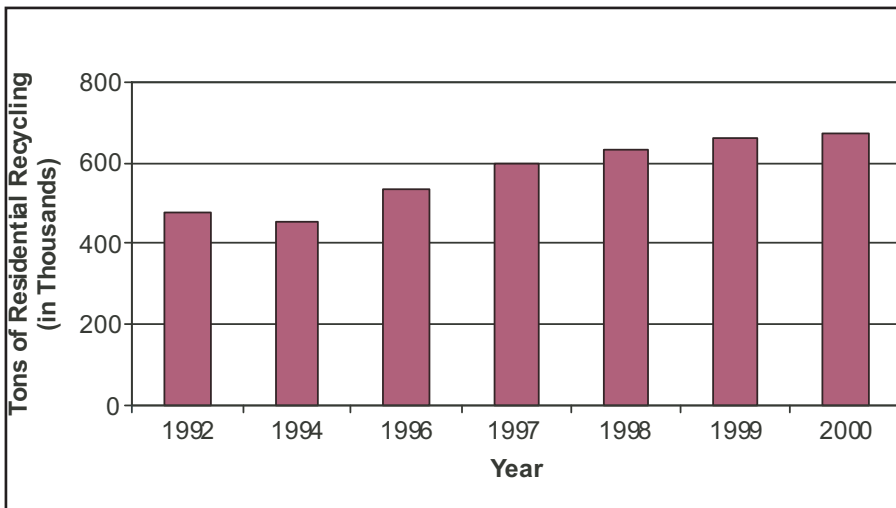
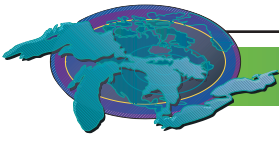


Figure 3. Residential recycling tonnage in Ontario, 1992-2000. Source: WDO-Ontario Waste Diversion Organization, 2000



## Nutrient Management Plans

Indicator ID # 7061

Also see indicator # 111 (Phosphorus Concentration and Loadings and # 4860 Phosphorus and Nitrogen Levels)

### Purpose

To determine the number of Nutrient Management plans and to infer environmentally friendly practices that help to prevent ground and surface water contamination.

### Ecosystem Objective

This indicator supports Annexes 2, 3, 11,12 and 13 of the GLWQA. The objective is sound use and management of soil, water, air, plants and animal resources to prevent degradation of the environment. The objective of Nutrient Management Planning is to manage the amount, form, placement and timing of applications of nutrients for uptake by crops as part of an environmental farm plan. It is expected that more farmers will embrace environmental planning over time. This results in sustainable agriculture through non-polluting, energy efficient technology and best management practices for efficient and high quality food production.

### State of the Ecosystem

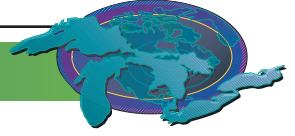
Given the key role of agriculture in the Great Lakes ecosystem, it is important to track changes in agricultural practices that can lead to protection of water quality as well as the sustainable future of agriculture and rural development and better ecological integrity in the basin. The indicator identifies the degree to which agriculture is becoming more sustainable and has less potential to adversely impact the Great Lakes ecosystem. The Ontario Environmental Farm Plans (EFP) identifies the need for best nutrient management practices. Over the past 5 years farmers, municipalities and governments and their agencies have made significant progress. Ontario Nutrient Management Planning (NMP) software (NMAN) is available to farmers and consultants wishing to develop/assist with the development of nutrient management plans.

In June 2002 Ontario introduced legislation for (Nutrient Management Act (NM Act) to establish province-wide standards (currently under development) to ensure that all land-applied materials will be managed in a sustainable manner resulting in environmental and water quality protection. It will supercede existing regulatory provisions (municipal by-laws), guidelines and voluntary best management practices. It is anticipated that the NM Act will require standardization, reporting and updating of nutrient management plans through a nutrient management plan registry. To promote a greater degree of consistency in by-law development Ontario developed a model nutrient management by-law for municipalities. Prior to the NM Act, municipalities enforced each nutrient management by-law by inspections performed by employees of the municipality or others under authority of the municipality.

In the United States the two types of plans dealing with agriculture nutrient management are the Comprehensive Nutrient Management Plans (CNMPs) and the proposed Permit Nutrient Plans (PNP) under the Environmental Protection Agency's (EPA) National Pollution Discharge Elimination System permit requirements. Individual States also have additional nutrient management programs. An agreement between the US EPA and USDA under the Clean Water Action plan called for a Unified National Strategy for Animal Feeding Operations. Under this strategy, USDA-Natural Resources Conservation Service has leadership in development of technical standards for CNMPs. Funds from the Environmental Quality Incentives Program can be used to develop CNMPs. Figure 1 shows the total number of nutrient management plans developed annually for the U.S. portion of the Basin. This includes nutrient management plans for both livestock and non-livestock producing farms.

**Figure 2** shows the number of Nutrient Management Plans by Ontario County for the years 1998 – 2000 while **Figure 3** shows Cumulative acreage's of Nutrient Management Plans for the Ontario part of the basin. Until Nutrient Management regulations are put into place in Ontario Nutrient Management Plans (NMP) continue to be done on a voluntary basis except where municipal by-laws require them to be completed. Nutrient Management Plans are not currently tracked except where required by the municipality. There are similarities and differences between municipal nutrient management by-laws that reflect local concerns yet highlight the need for standardisation. Such standardisation will be a part of the regulation development process in Ontario's Nutrient Management Act.

In the United States basin the CNMP's are tracked on an annual basis due to the rapid changes in farming operations. This does not allow for an estimate of the total number of CNMP's. EPA will be tracking PNP as part of the Status's NPDES program.



Having a completed a NMP provides assurance farmers are considering the environmental implications of their management decisions. The more plans in place the better. In the future there may be a way to grade plans by impacts on the ecosystem. The first year in which this information is collected will serve as the base line year.

### Future Pressures

As livestock operations consolidate in number and increase in size in the basin planning efforts will need to keep pace with the planning workload and changes in water and air quality standards and technology. Consultations regarding the provincial and U.S. standards and regulations will continue into the near future.

### Future Actions

The new Nutrient Management Act authorizes the establishment and phasing in of province-wide standards for the management of materials containing nutrients and sets out requirements and responsibilities for farmers, municipalities and others in the business of managing nutrients. It is anticipated that the regulations under this act will establish a computerized NMP registry; a tool that will track nutrient management plans put into place. This tool could form a part of the future “evaluation tool box” for nutrient management plans in place in Ontario. The phasing in requirements of province-wide standards for nutrient management planing in Ontario and the eventual adoption over time of more sustainable farm practices should allow for ecosystem recovery with time.

The U.S. USDA’s Natural Resources Conservation Service has formed a team to revise its Nutrient Management Policy. The final policy was issued in the Federal Register in 1999. In December 2000, USDA published its Comprehensive Nutrient Management Planning Technical Guidance (CNMP Guidance) to identify management activities and conservation practices that will minimise the adverse impacts of animal feeding operations on water quality. The CNMP Guidance is a technical guidance document and does not establish regulatory requirements for local, tribal, State, or Federal programs. PNPs are complementary to and leverage the technical expertise of USDA with its CNMP Guidance. EPA is proposing that CAFOs, covered by the effluent guideline, develop and implement a PNP. There is an increased availability of technical assistance for U. S. farmers via Technical Service Providers, who can provide assistance directly to producers and receive payment from them with funds from the Environmental Quality Incentives Program.

### Acknowledgments

**Authors:** Peter Roberts Water Management Specialist, OMAF, Guelph, Ontario Canada [peter.roberts@omaf.gov.on.ca](mailto:peter.roberts@omaf.gov.on.ca) and Ruth Shaffer, USDA –Natural Resource Conservation Service, [ruth.shaffer@mi.usda.gov](mailto:ruth.shaffer@mi.usda.gov) and Roger Nanney, Resource Conservationist, USDA, NRCS, [roger.nanney@in.usda.gov](mailto:roger.nanney@in.usda.gov)

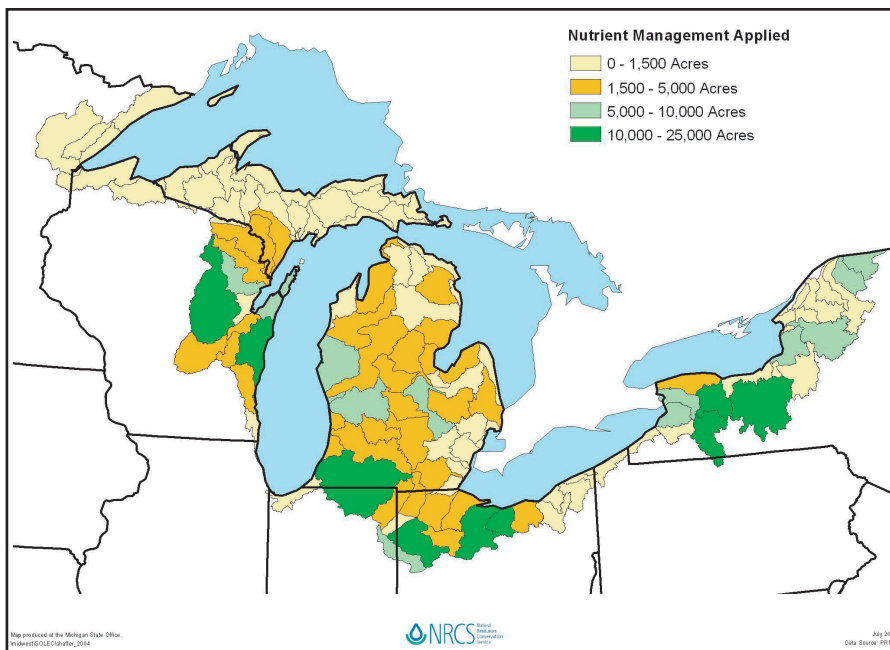


Figure 1. Annual U.S. Nutrient Management Systems total number of nutrient management plans developed annually for the U.S. portion of the Basin (Source: USDA, NRCA, Performance and Results Measurement System)

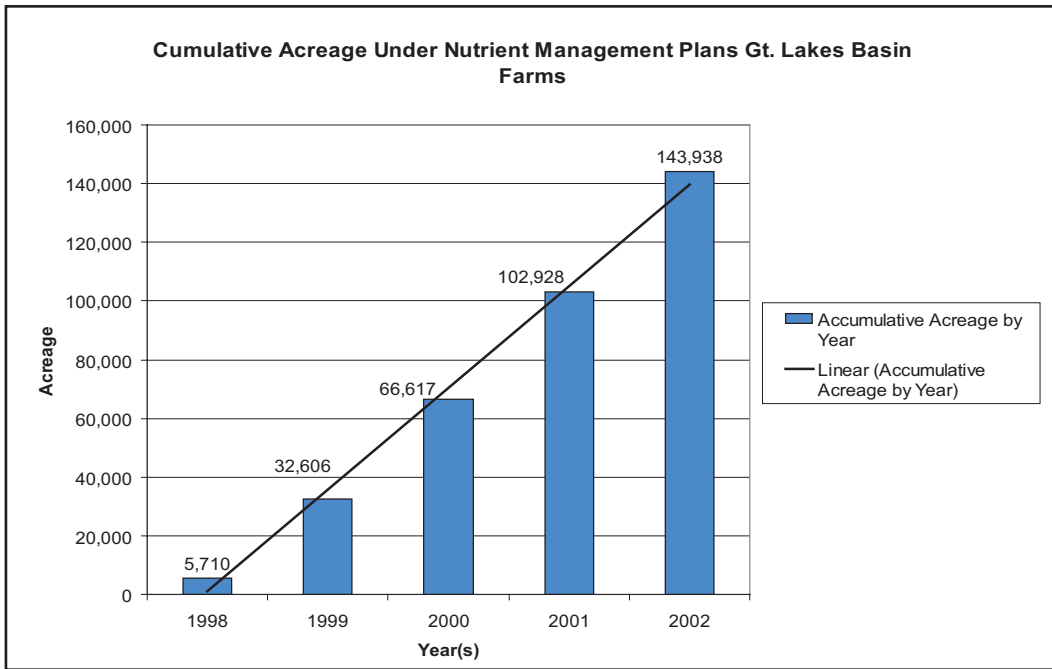
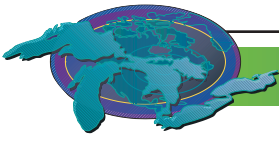


Figure 2. Nutrient Management Plans by Ontario County, 1998 – 2000

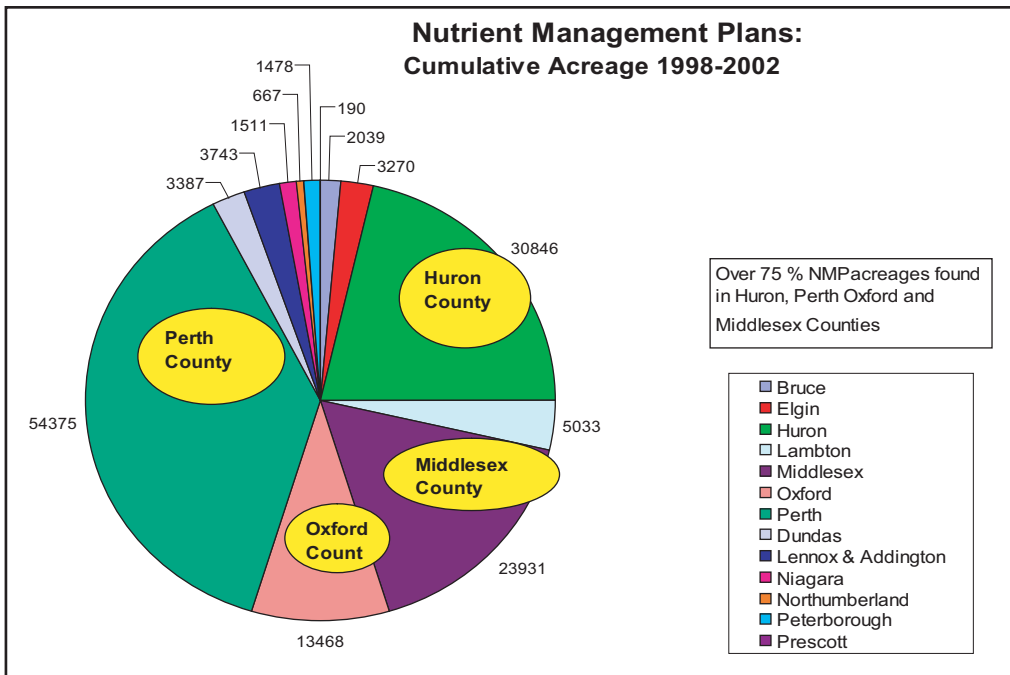
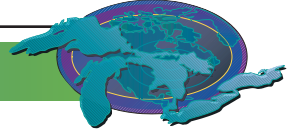


Figure 3. Cumulative acreage's of Nutrient Management Plans for Selected Ontario Counties in the Basin  
 I:\solec\SOLEC 2004\Indicators 2004\Nutrient Management\NMP 7061 Peter Roberts Ruth Schaffer Sept 23 04.doc  
 I:\solec\SOLEC 2004\Indicators 2004\Nutrient Management\NMP 7061 Peter Roberts Aug 18 04.doc



## Integrated Pest Management

Indicator ID # 7062 (Watershed Category)

### Purpose

A goal for agriculture is to become more sustainable through the adoption of more non-polluting, energy efficient technologies and best management practices for efficient and high quality food production. This indicator reports the adoption of Integrated Pest Management (IPM) practices and the effects IPM has toward preventing surface and groundwater contamination in the Great Lakes Basin. This indicator reports at least 2 basic things:

Measurement of the acres of agricultural pest management applied to agricultural crops in 2003, to reduce adverse impacts on plant growth, crop production and environmental resources.

Reporting the results of a questionnaire/course evaluation administered to farmers who have attended Ontario Pesticide Training and Education Program Grower Pesticide Safety Course in 2002, 2003 and 2004 (to date) by the University of Guelph (Ridgetown Campus)/Ministry's of the Environment and Agriculture and Food.

### Ecosystem Objective

This indicator supports Article V1 (e (1,viii) Programs and other Measures (Pollution from Agriculture) Annex 1, 2, 3, 11, 12 and 13 of the GLWQA. The objective is the sound use and management of soil, water air, plants and animal resources to prevent degradation. Pest Management is controlling organisms that cause damage or annoyance. Integrated pest management is utilizing environmentally sensitive prevention, avoidance, monitoring and suppression strategies to manage weeds, insects, diseases, animals and other organisms (including invasive and non-invasive species) that directly or indirectly cause damage or annoyance. Environmental risks of pest management must be evaluated for all resource concerns identified in the conservation planning process, including the negative impacts of pesticides in ground and surface water, on humans, and non-target plants and animals.

The pest management component of an environmental conservation farm plan must be designed to minimize negative impacts of pest control on all identified resource concerns.

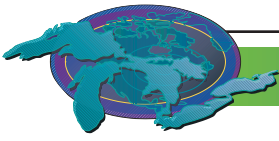
### State of the Ecosystem

Agriculture accounts for approximately 35% of the land area of the Great Lakes Basin and dominates the southern portion of the basin. Although field crops such as corn and soybeans comprise the most crop acreage, the basin also supports a wide diversity of specialty crops. The mild climate created by the Great Lakes also allows for production of a variety of vegetable and fruit crops. These include tomatoes (for both the fresh and canning markets), cucumbers, onions and pumpkins. Orchard and tender fruit crops such as cherries, peaches and apples are economically important commodities in the region, along with grape production for juice or wine. These agricultural commodities are major users of pesticides.

Research has found that reliance on pesticides in agriculture is significant and that it would be impossible to abandon their use in the short term. Most consumers want to be able to purchase inexpensive yet wholesome food. Currently, other than organic production, there is no replacement system readily available at a reasonable price for consumers, and at a lesser cost to farmers that can be brought to market without pesticides. Other research has shown that pesticide use continues to decline as measured by total active ingredient (a.i.), with broad-spectrum pest control products being replaced by more target specific technology, with lowered amounts of active ingredient used per acre. Reasons for these declines are cited as changing acreage's of crops, adoption of integrated pest management (IPM) and alternative pest control strategies such as border sprays for migratory pests, mating disruption, alternative row spraying and pest monitoring.

With continued application of pesticides in the Great Lakes basin, non-point source pollution of nearshore wetlands and the effects on fish and wildlife still remains a concern. Unlike point sources of contamination such as at the outlet of an effluent pipe, nonpoint sources are more difficult to define. An estimated 21 million kg of pesticides are used annually on agricultural crops in the Canadian and American Great Lakes Watershed (GAO 1993). Herbicides account for about 75% of this. These pesticides are frequently transported via sediment, ground or surface water flow from agricultural land into the aquatic ecosystem. With mounting concerns and evidence of the effects of certain pesticides on wildlife and human health it is crucial that we determine the occurrence and fate of agricultural pesticides in sediments, aquatic and terrestrial life found in the Great Lakes. Atrazine and metolachlor were measured in precipitation at nine sites in the Canadian Great Lakes Basin in 1995. Both were detected regularly at all nine sites. The detection of





some pesticides at sites where they were not used provides evidence of atmospheric transport of pesticides in this region.

Cultural controls (such as crop rotation and sanitation of infested crop residues), biological controls, and plant selection and breeding for resistant crop cultivars have always been an integral part of agricultural IPM. Such practices were very important and widely used prior to the advent of synthetic organic pesticides; indeed, many of these practices are still used today as components of pest management programs. However, the great success of modern pesticides has resulted in their use as the dominant pest control practice for the past several decades, especially since the 1950s. Newer pesticides are generally more water soluble, less strongly adsorbed to particulate matter, and less persistent in both the terrestrial and aquatic environments than the older contaminants but have still been found in precipitation at many sites.

The Ontario Pesticides Education Program (OPEP) provides farmers with training and certification through a pesticide safety course (**Figure 1**). **Figure 2** shows the acres of pest management practice applied to cropland in the U.S. Great Lakes basin for fiscal year 2003.

### Future Pressures

Pest management practices may be compromised by changing land use and development pressures (including higher taxes); flooding or seasonal drought; and lack of long-term financial incentives for adoption of environmentally friendly practices. In order for pest management to be successful, pest managers must shift from practices focusing on purchased inputs and broad-spectrum pesticides to those using knowledge about ecological processes. Future pest management will be more knowledge intensive and focus on more than the use of pesticides. The public sector, university Cooperative Extension programs and partnerships with grower organizations are an important source for pest management information, and dissemination, especially considering that the public sector is more likely to do the underlying research. However, there is significant need for private independent pest management consultants to provide technical assistance to the farmer.

### Future Actions

All phases of agricultural pest management, from research to field implementation, are evolving from its current product-based orientation to one that is based on ecological principles and processes. Such pest management practices will rely more on an understanding of the biological interactions that occur within every crop environment, and the knowledge of how to manage the cropping systems to the detriment of pests. The optimum results would include fewer purchased inputs (and therefore a more sustainable agriculture), as well as fewer of the human and environmental hazards posed by the broad spectrum pesticides so widely used today. Although pesticides will continue to be a component of pest management, the following are significant obstacles to the continued use of broad-spectrum pesticides: pest resistance to pesticides; fewer new pesticides; pesticide-induced pest problems; lack of effective pesticides; and human and environmental health concerns.

Based upon these issues facing pesticide use, it is necessary to start planning now in order to be less reliant on broad-spectrum pesticides in the future. Society is requiring that agriculture become more environmentally responsible through such things as the adoption of Integrated Pest Management. This will require effective evaluations of existing policies and implementing programs for areas such as Integrated Pest Management. To reflect these demands there is a need to further develop this indicator. These types of future activities could assist with this process.

Indicate and track future adoption trends of IPM best management practices

Further evaluate the success of the Ontario Pesticide Training Course such as adding/evaluating survey questions regarding IPM principles/practices to course evaluation materials.

Evaluate the number of farmers/vendors certified, attending and failing the Ontario Pest Education Program.

Analyze rural water quality data for levels of pesticide residues.

Note: Grower pesticide certification is mandatory in Ontario and in all Great Lakes States and applies to individual farms as well as custom applicators.

### Acknowledgments

**Authors:** Peter Roberts, Water Quality Management Specialist, Resources Management, OMAF, Guelph, [peter.roberts@omaf.gov.on.ca](mailto:peter.roberts@omaf.gov.on.ca) Ruth Shaffer USDA-Natural Resources Conservation Service, [ruth.shaffer@mi.usda.gov](mailto:ruth.shaffer@mi.usda.gov) and Roger Nanney, Resource Conservationist, USDA, NRCS, [roger.nanney@in.usda.gov](mailto:roger.nanney@in.usda.gov)

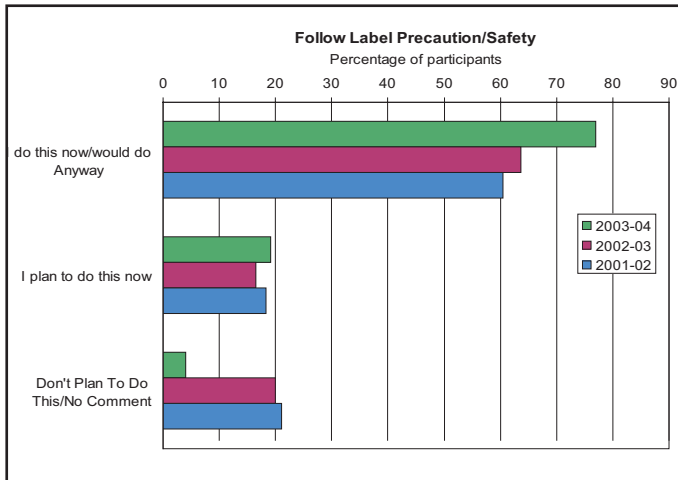
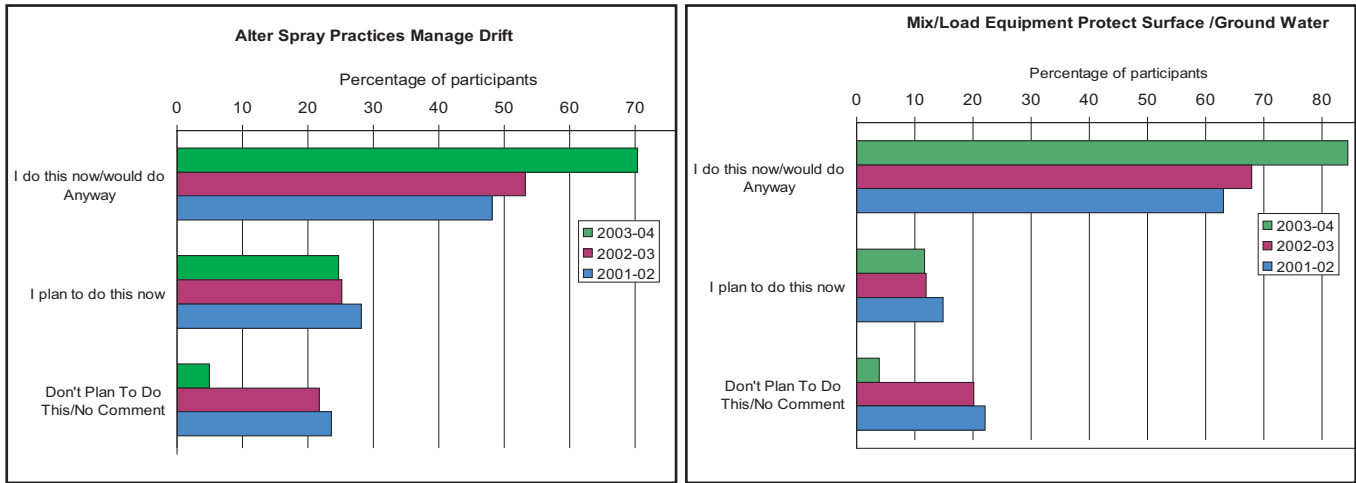
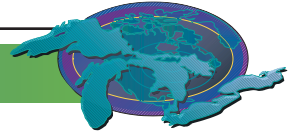


Figure 1. Ontario Selected Grower Pesticide Safety Training Course Evaluation results from 2001-2004  
 Source: OMAF, MOE and the University of Guelph

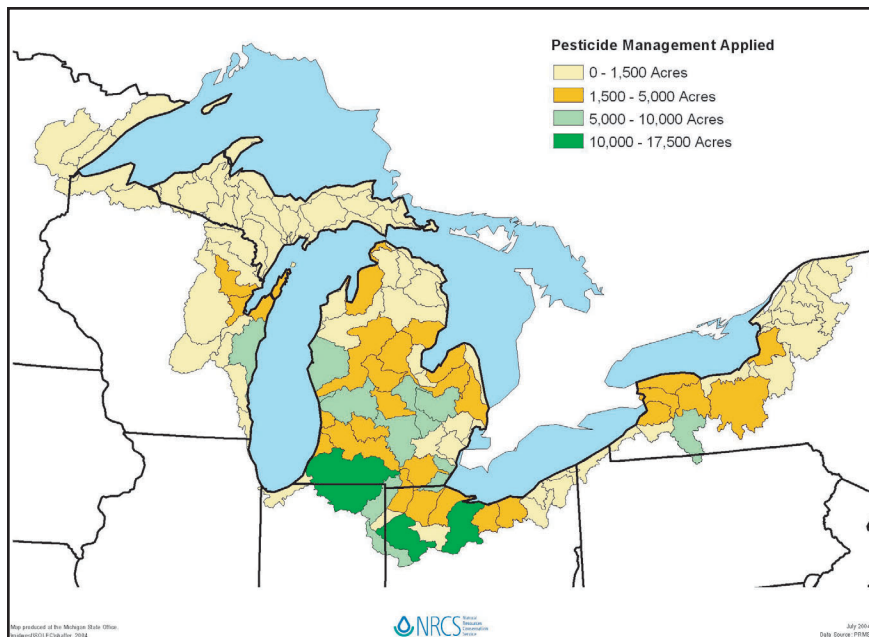
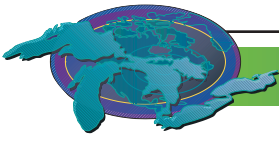


Figure 2. Annual U.S. Pesticide Management Systems Planned for FY 2001.  
 (Source: USDA, NRCS, Performance and Results Measurement System)  
 I:\solec\SOLEC 2004\Indicators 2004\Pesticides\Descriptor Ag SOLEC 04 IPM PRoberts and Schaffer Sept 23 04.doc



## Natural and Human-Induced Groundwater Quality

SOLEC Indicator #7100 (DRAFT)

**Note:** This indicator report uses data from the Grand River Watershed only and may not be representative of groundwater conditions throughout the Great Lakes Basin.

### Assessment:

#### Purpose

This indicator measures groundwater quality as determined by the natural chemistry of the bedrock and overburden deposits, as well as any changes in quality due to anthropogenic activities. The purpose of this indicator is to address groundwater quality impairments, whether they are natural or human induced, to ensure a safe and clean supply of groundwater for human consumption and ecosystem functioning.

#### Ecosystem Objective

Natural groundwater quality issues and human induced changes in groundwater quality both have the potential to affect our ability to use groundwater safely. Some constituents found naturally in groundwater leaves some groundwater reserves inappropriate for certain uses. Growing urban populations, along with historical and present industrial and agricultural activity have caused significant harm to groundwater quality, thereby obstructing the use of the resource and damaging the environment. Understanding natural groundwater quality provides a baseline from which to compare, while monitoring anthropogenic changes can allow identification of temporal trends and assess any improvements or further degradation in quality. The ecosystem objective for this indicator is to ensure that groundwater quality remains at, or approaches natural conditions.

#### State of the Ecosystem

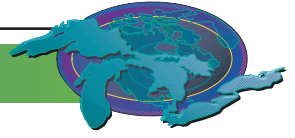
##### *Natural Groundwater Quality*

The Grand River watershed can generally be divided into three distinct geological areas; the northern till plain, the central region of moraines with complex sequences of glacial, glaciofluvial and glaciolacustrine deposits, and the southern clay plain. These surficial overburden deposits are underlain by fractured carbonate rock (predominantly dolostone). The groundwater resources of the watershed include regional-scale unconfined and confined overburden and bedrock aquifers as well as discontinuous local-scale deposits which contain sufficient groundwater to meet smaller users needs. In some areas of the watershed (e.g. Whitemans Creek basin) the presence of high permeability sands at ground surface and or a high water table leads to unconfined aquifers which are highly susceptible to degradation from surface contaminant sources.

The natural quality of groundwater in the watershed for the most part is very good. The groundwater chemistry in both the overburden and bedrock aquifers is generally high in dissolved inorganic constituents (predominantly calcium, magnesium, sodium, chloride and sulphate). Measurements of total dissolved solids (TDS) suggest relatively “hard” water throughout the watershed. For example, City of Guelph production wells yield water with hardness measured from 249 mg/L to 579 mg/L, which far exceeds the aesthetic Ontario Drinking Water Objective of 80 mg/L to 100 mg/L. Elevated concentrations of trace metals (iron and manganese) have also been identified as ambient quality issues with the groundwater resource.

Figures 1 and 2 illustrate water quality problems observed in bedrock and overburden wells respectively. These figures are based on a qualitative assessment of well water at the time of drilling as noted on the Ontario Ministry of Environment’s water well record form. The majority of these wells were installed for domestic or livestock uses. Overall, between 1940 and 2000, less than 1 percent (~ 1131 wells) of all the wells drilled in the watershed reported having a water quality problem. Of the wells exhibiting a natural groundwater problem about 90 percent were bedrock wells while the other 10 percent were completed in the overburden. The most frequently noted quality problem associated with bedrock wells was high sulphur content (76 percent of bedrock wells with quality problems). This is not surprising, as sulphur is easy to detect due to its distinctive objectionable odour. Generally, three bedrock formations commonly intersected within the watershed contain most of the sulphur wells: the Guelph Formation, the Salina Formation, and the Onondaga-Amherstburg Formation. The Salina Formation forms the shallow bedrock under the west side of the watershed while the Guelph underlies the east side of the watershed.

Additional quality concerns noted in the water well records include high mineral content and salt. About 20 percent of the reported quality concerns in bedrock wells were high mineral content while 4 percent reported salty water. Similar concerns were noted in



overburden wells where reported problems were sulphur (42 percent), mineral (34 percent), and salt (23 percent).

#### Human Induced Changes to Groundwater Quality

Changes to the quality of groundwater from anthropogenic activities associated with urban sprawl, agriculture and industrial operations have been noted throughout the watershed. Urban areas within the Grand River watershed have been experiencing considerable growth over the past few decades. The groundwater quality issues associated with human activity in the watershed include: (1) chloride, (2) industrial chemicals (e.g. Trichloroethylene (TCE)), (3) agricultural impacts (nitrate, bacteria, and pesticides). These contaminants vary in their extent from very local impact (e.g. bacteria) to widespread impact (e.g. chloride). Industrial contaminants tend to be point sources, which generally require very little concentration to impact significant groundwater resources.

#### *Chloride*

Increasing chloride concentrations in groundwater have been observed in most municipal wells in the urban portions of the watershed. This increase has been attributed to winter deicing of roads with sodium chloride (salt). Detailed studies carried out by the Regional Municipality of Waterloo have illustrated the impact of road salting associated with increased urban development to groundwater being captured by two municipal well fields. Figure 3 shows the temporal changes in chloride concentration for the two well fields investigated in this study. Wells A, B, and C, are from the first well field while wells D and E are from the second well field. In 1967 land use within the capture zone of the first field was 51 percent rural and 49 percent urban, while in the second well field capture zone the land use was 94 percent rural and 6 percent urban. By 1998, the area within the first well field capture zone had been completely converted to urban land while in the second well field capture zone 60 percent of the land remained rural.

Although wells from both well fields show increased chloride levels, wells A, B, and C in the heavily urbanized capture zone show a greater increase in chloride concentrations than do wells D and E in the predominantly rural capture zone. For example, well B showed a change in chloride concentration from 16.8 mg/L in 1960, to 260 mg/L in 1996, whereas Well D showed a change from 3 mg/L in 1966, to 60 mg/L in 1996. This indicates that chloride levels in groundwater can be linked to urban growth and its associated land uses (i.e. denser road network). The Ontario Drinking Water Objective for chloride had been established at 250 mg/L, although this guideline is predominantly for aesthetic reasons, the issue of increasing chloride levels should be addressed.

#### *Industrial Contaminants*

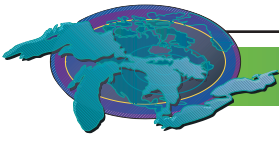
Groundwater resources in both the overburden and bedrock deposits within the Grand River watershed have been impacted by contamination of aqueous and non-aqueous contaminants which have entered the groundwater as a result of industrial spills or discharges, landfill leachates, leaky storage containers, and poor disposal practices. A significant class of these chemicals is volatile organic compounds (VOCs). Contamination by VOCs such as TCE, have impacted municipal groundwater supplies in several communities in the watershed. For example by the year 1998, five of the City of Guelph's 24 wells were taken out of service due to low-level VOC contamination. These wells have a combined capacity of 10,000 to 12,000 m<sup>3</sup>/day and represent about 15% of the City's permitted water-taking capacity. As a second example, contamination of both a shallow aquifer and a deeper municipal aquifer with a variety of industrial chemicals (including toluene, chlorobenzene, 2,4-D, 2,4,5-T) emanating from a chemical plant in the Region of Waterloo led to the removal of municipal wells in the town of Elmira from the water system.

#### *Agricultural and Rural Impacts*

Groundwater quality in agricultural areas is affected by activities such as: pesticide application, fertilizer and manure applications on fields, storage and disposal of animal wastes and the improper disposal and spills of chemicals. The groundwater contaminants from these activities can be divided into three main groups: nitrate, bacteria and pesticides. For example, the application of excessive quantities of nutrients to agricultural land may impact the quality of the groundwater. Excess nitrogen applied to the soil to sustain crop production is converted to nitrate with infiltrating water and hence transported to the water table. Seventy-six percent of the total land area in the Grand River watershed is used for agricultural purposes and thus potential and historical contamination of the groundwater due to these activities is a concern.

Land use and nitrate levels measured in surface water from two sub-watersheds, the Eramosa River and Whitemans Creek, are used to illustrate the effects of agricultural activities on groundwater quality and the quality of surface water.

In the Whitemans Creek sub-watershed, approximately 78 percent of the land classified as groundwater recharge area is covered with agricultural uses, and only 20 percent is forested. In the Eramosa sub-watershed about 60 percent of the significant recharge



land is used for agricultural purposes with approximately 34 percent of the land being covered with forest (Figure 4). Both of these tributary streams are considered predominantly groundwater-fed streams, meaning that the majority of flow within them is received directly from groundwater discharge.

Average annual concentrations of nitrate measured in the Eramosa River and Whitemans Creek from 1997 to 2003 are shown in Figure 5. Average annual concentration of nitrate measured in Whitemans Creek between 1997 and 2003 were 2.5 to 8 times higher than those measured in the Eramosa River. The higher nitrate levels measured in Whitemans Creek illustrate the linkage between increased agricultural activity and groundwater contamination and its impact on surface water quality. In addition to the agricultural practices in the Whitemans Creek sub-watershed, the observed nitrate concentrations may also be linked to rural communities with a high density of septic systems that leach nutrients to the subsurface.

Manure spreading on fields, runoff from waste disposal sites and septic systems may all provide a source of bacteria to groundwater. Bacterial contamination in wells in agricultural areas is common, however, this is often due to poor well construction allowing surface water to enter the well and not indicative of widespread aquifer contamination. Shallow wells are particularly vulnerable to bacterial contamination.

### **Future Pressures**

The population within the Grand River watershed is expected to increase by over 300,000 people in the next 20 years. The urban sprawl and industrial development associated with this population growth if not managed appropriately will increase the chance for contamination of groundwater resources. Intensification of agriculture will lead to increased potential for pollution caused by nutrients, pathogens and pesticides to enter the groundwater supply and eventually surface water resources. While largely unknown at this time, the effects of climate change may lead to decreased groundwater resources, which may concentrate existing contaminant sources.

### **Future Action**

Protecting groundwater resources generally requires multi-faceted strategies including regulation, voluntary adoption of best management practices and public education. Programs to reduce the amount of road salt used for deicing will lead to reductions in chloride contamination in groundwater. For example, the Regional of Waterloo (the largest urban community in the watershed) in cooperation with road maintenance departments has been able to decrease the amount of road salt applied to Regional roads by 27 percent in just one winter season.

### **Further Work Necessary**

While there is a large quantity of groundwater quality data available for the various aquifers in the watershed, this data has not been consolidated and evaluated in a comprehensive or systematic way. Work is needed to bring together this data and incorporate ongoing groundwater monitoring programs. An assessment of the groundwater quality across Ontario is currently being undertaken through sampling and analysis of groundwater from the provincial groundwater-monitoring network (PGMN) wells (includes monitoring stations in the Grand River watershed). Numerous watershed municipalities also have had ongoing monitoring programs, which examine the quality of groundwater as a source of drinking water in place for a number of years. Integrating this data along with data contained in various site investigations will allow for a more comprehensive picture of groundwater quality in the watershed to be determined.

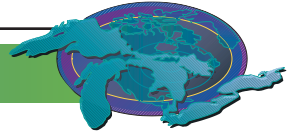
### **Acknowledgements**

Alan Sawyer, Sandra Cooke, Jeff Pitcher and Pat Lapcevic of the Grand River Conservation Authority prepared this report. Alan Sawyer's position was partially funded through a grant from Environment Canada's Science Horizons internship program. The assistance of Samuel Bellamy of the Grand River Conservation Authority, as well as Harvey Shear, Nancy Stadler-Salt and Andrew Piggott of Environment Canada is gratefully acknowledged.

### **Sources**

Braun Consulting Engineers, Gartner Lee Limited, and Jagger Hims Limited Consulting Engineers. 1999. City of Guelph Water System Study Resource Evaluation Summary. Report prepared for the City of Guelph.

Crowe A.S., K.A. Schaefer, A. Kohut, S.G. Shikaze and C.J. Ptacek. 2003. Groundwater Quality. Canadian Council of Ministers of the Environment, Winnipeg, Manitoba. CCME Linking Water Science to Policy Workshop Series. Report No. 2, 52p.



Holysh, S., Pitcher, J., and D. Boyd. 2001. Grand River Regional Groundwater Study. Grand River Conservation Authority, Cambridge, Ontario, 78pp+ appendices.

Ontario Provincial Water Quality Monitoring Network. 2003. Grand River Conservation Authority Water Quality Stations.

Region of Waterloo. Official Municipal Website. www.region.waterloo.on.ca

Stanley Consulting. 1998. Chloride Impact Assessment Parkway and Strasburg Creek Well Fields Final Report. Prepared for the Regional Municipality of Waterloo.

Whiffin R.B. and R.J. Rush. 1989. Development and demonstration of an integrated approach to aquifer remediation at an organic chemical plant in Proceedings of the FOCUS Conference on Eastern Regional Ground Water Issues, October 17-19, 1989, Kitchener, ON, Canada, p273-288.

Date Prepared: July 29, 2004.

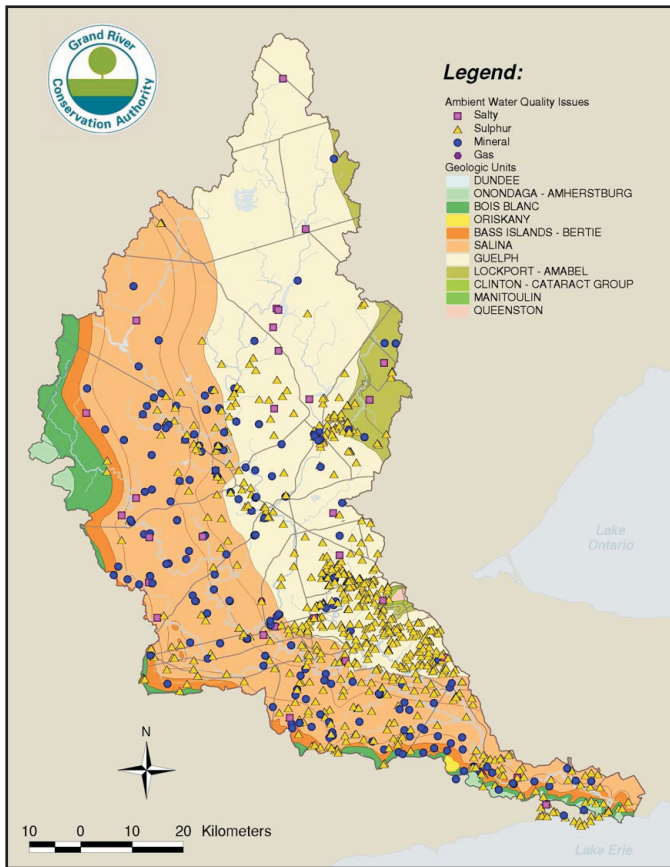


Figure 1. Bedrock wells with natural quality issues in the Grand River watershed

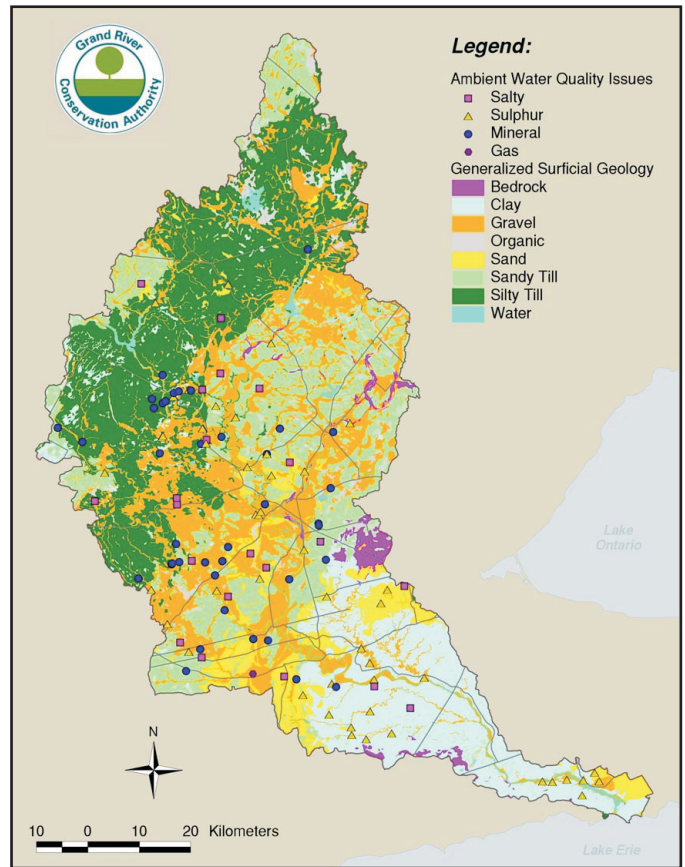


Figure 2. Overburden wells with natural quality issues in the Grand River watershed.

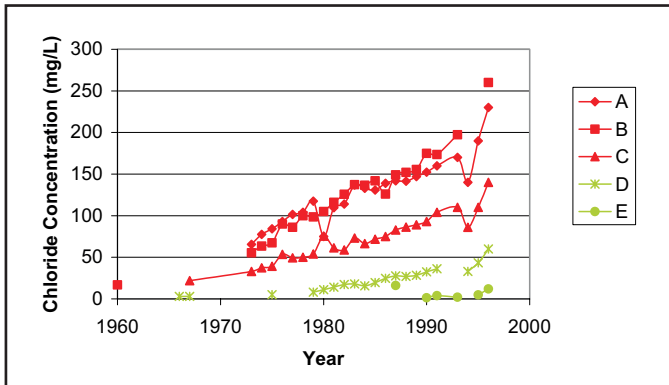
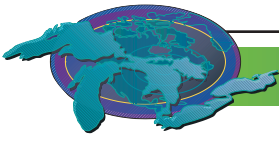


Figure 3. Chloride levels in selected groundwater wells in the Regional Municipality of Waterloo. Source: Stanley Consulting, 1998.

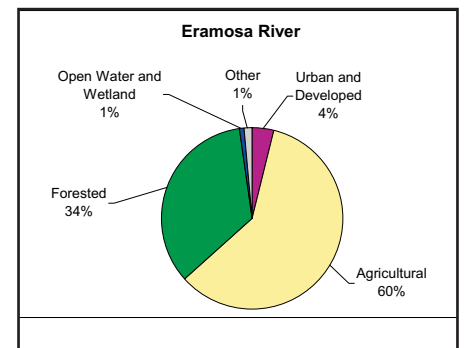
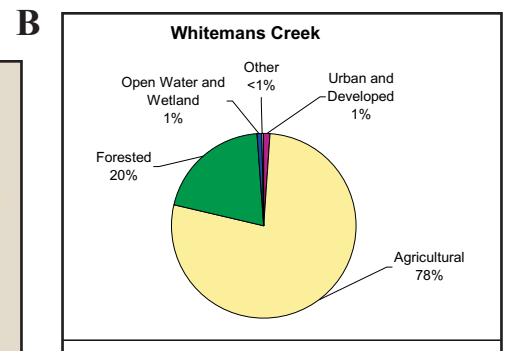
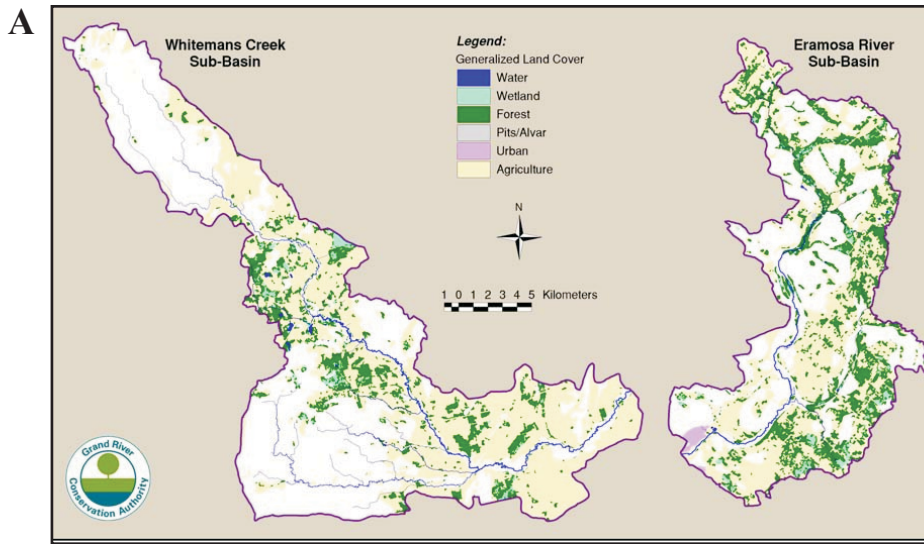


Figure 4. Land cover on moraine systems and areas that facilitate high to very high groundwater recharge of the Whitemans Creek and Eramosa Sub- water sheds: (a) Spatial distribution and (b) Percent distribution of classified land use.

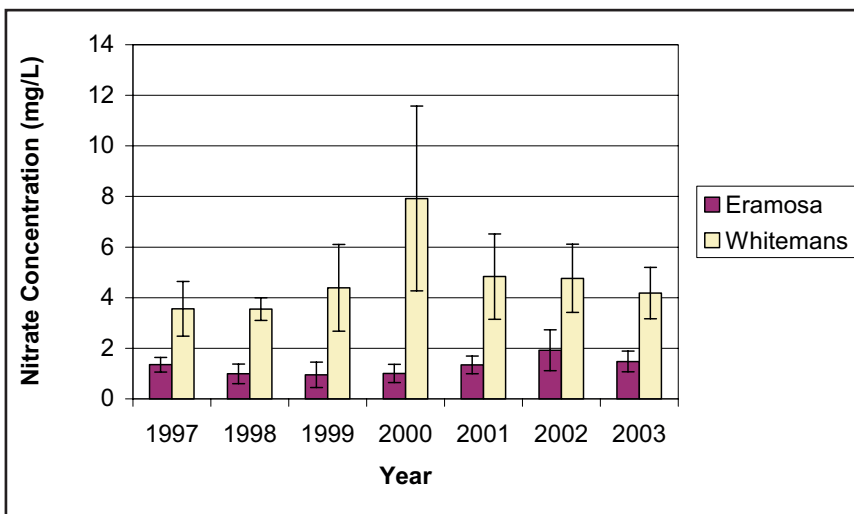
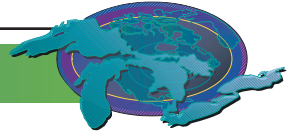


Figure 5. Average annual concentrations of nitrate measured in the Eramosa River and Whitemans Creek from 1997 to 2003. (Also shown on the bar graphs is the standard error of measurement) Source: Ontario Provincial Water Quality Monitoring Network, 2003.



## ***Groundwater and Land Use and Intensity***

SOLEC Indicator #7101 (DRAFT)

**Note:** This indicator report uses data from the Grand River Watershed only and may not be representative of groundwater conditions throughout the Great Lakes Basin.

### **Assessment:**

#### **Purpose**

This indicator measures water use and intensity and land use and intensity within the Grand River watershed. The indicator is used to infer the potential impact of land and water use on the quantity and quality of groundwater resources as well as evaluate groundwater supply and demand. The purpose of this indicator is to track the main influences on groundwater quantity and quality such as land and water use to ensure sustainable high quality groundwater supplies.

#### **Ecosystem Objective**

Land use and intensity has the potential to affect both groundwater quality and quantity. Similarly, water use and intensity (i.e. demand) can impact the sustainability of groundwater supplies. In addition, groundwater use and intensity can impact streams and creeks, which depend on groundwater for base flows to sustain aquatic plant and animal communities. The ecosystem objective for this indicator is to ensure that land and water use does not negatively impact groundwater supplies/resources.

#### **State of the Ecosystem**

##### *Land use and intensity*

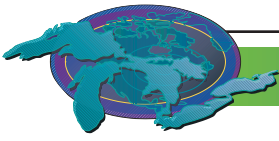
The Grand River watershed can generally be divided into three distinct geological areas; the northern till plain, central moraines with complex sequences of glacial, glaciofluvial and glaciolacustrine deposits, and the southern clay plain. These surficial overburden deposits are underlain by fractured carbonate rock (predominantly dolostone). The groundwater resources of the watershed include regional-scale unconfined and confined overburden and bedrock aquifers as well as discontinuous local-scale deposits which contain sufficient groundwater to meet smaller users needs. In some areas of the watershed (e.g. Whiteman's Creek basin) the presence of high permeability sands at ground surface and or a high water table leads to unconfined aquifers which are highly susceptible to contamination from surface contaminant sources.

Agricultural and rural land uses predominate in the Grand River watershed. Approximately 76 percent of the watershed land area is used for agriculture (Figure 1). Urban development covers about 5 percent of the watershed area while forests cover about 17 percent. The largest urban centres, including Kitchener, Waterloo, Cambridge and Guelph, are located in the central portion of the watershed and are situated on or in close proximity to many of the complex moraine systems that stretch across the watershed (Figure 1). The moraines and associated glacial outwash units in the watershed form a complex system of sand and gravel layers separated by less permeable till units. Together with the sand plain in the southwest portion of the watershed these units provide significant groundwater resources. The majority of the groundwater recharge in the watershed is concentrated in a land area that covers approximately 38 percent of the watershed (Figure 2).

Land use on these moraines and significant recharge areas can have major influence on both groundwater quantity and quality (Figure 2). Intensive cropping practices with repeated manure and fertilizer applications have the potential to impact groundwater quality while urban development can interrupt groundwater recharge and impact groundwater quantity. About 67 percent of the significant recharge areas are in agricultural production while 23 and 8 percent of the recharge areas are covered with forests and urban development. Since the moraine systems and recharge areas in the Grand River watershed provide important ecological, sociological and economical services to the watershed, they are important watershed features that must be maintained to ensure sustainable groundwater supplies.

Land use directly influences the ability of precipitation to recharge shallow aquifers. Urban development such as the paving of roads and building of structures intercepts precipitation and facilitates the movement of water off the land in surface runoff, which subsequently reduces groundwater recharge of shallow aquifers. A significant portion (62 percent) of the urban area in the Grand River watershed tends to be concentrated in the highly sensitive groundwater recharge areas (Figure 3). Development is continuing in these sensitive areas. For example, of the total kilometres of new roads built between 2000 and 2004 in the Region of Waterloo, about half of them were situated in the more sensitive areas.





Land uses that protect groundwater recharge such as some agricultural land use and forested areas need to be protected to ensure groundwater recharge. About 34 and 51 percent of the watershed's agricultural and forested land cover is located in the significant recharge areas. Strategic development is needed to protect these recharge areas to protect groundwater recharging function in the watershed.

#### Groundwater use and intensity

Groundwater in the Grand River watershed is used for a range of activities including domestic, municipal, public, agricultural, industrial/commercial supplies. It is estimated that approximately 80 percent of the 875,000 watershed residents use groundwater as their primary source of potable water.

Between 1940 and 2003, over 37,000 wells were constructed in the Grand River watershed. Most (~79 percent or 29,683 wells) of these wells are or were used for domestic water supplies (Figure 4). However, this represents only 3 percent of the total annual groundwater takings in the watershed (Figure 5). The largest users of groundwater in the watershed are municipalities who use the water to provide potable water to their residents. Industries, commercial developments, aggregate washing, dewatering and remediation also withdraw significant amounts of groundwater (43 percent, combined). Aquaculture, is a significant user of groundwater at approximately 13 percent of the total annual groundwater takings in the watershed.

Even though total annual groundwater withdrawals identify municipal takings as the most significant use of groundwater, seasonal demands in selected areas can be significant. Irrigation becomes the second largest use of water in July in the Grand River watershed. Approximately 60 percent of all irrigation is done with groundwater. Therefore, this seasonal demand can have a significant impact on local groundwater fed streams and the aquatic life that inhabits them. Although the irrigated land in the Grand River watershed is less than one percent of the total land area, increasing trends in irrigation (Figure 6) places added stress on these local groundwater dependant ecosystems.

Climatic factors, and population growth can also impact the demand for groundwater resources. The number of new wells drilled since 1980 grew steadily until 1989 (Figure 7). The number of new wells drilled peaked between 1987 and 1989, which coincides with a period of lower flow in the river. The average annual river flow illustrated in Figure 7 represents conditions where average, below average and above average streamflow was measured. The 1987-1989 period had below average streamflow suggesting it was dryer than normal and that watershed residents were searching for new groundwater supplies. The same occurrence is illustrated again in 1998-99. The cumulative impact of both climate effects and increased population growth (Figure 8) likely contributes to greater demand for groundwater supplies.

#### **Pressures**

Urbanization and associated development on sensitive watershed landscapes that facilitate groundwater recharge is a significant threat to groundwater resources in the Grand River watershed. Eliminating this important watershed function will directly impact the quantity of groundwater supplies for watershed residents. Therefore, it is essential that municipalities and watershed residents protect the moraine systems and significant recharge areas to ensure future groundwater supplies.

Population growth with continued urban development and agricultural intensification are the biggest threats to groundwater supplies in the Grand River watershed. It is estimated that the population of the watershed will increase by approximately 300,000 people in the next 20 years (Figure 8). The biggest single users of groundwater are municipalities for municipal drinking water supplies although industrial users, including aggregate and dewatering operations use a significant amount of groundwater in the watershed. Municipalities, watershed residents and industries will need to increase their efforts in water conservation as well as continue to seek out new or alternate supplies.

Climate influence on groundwater resources in the Grand River watershed cannot be underestimated. It is evident that during times with below average precipitation, there is increased demand for groundwater resources for both the natural environment and human uses. In addition, climate change will likely redistribute precipitation patterns throughout the year, which will likely impact groundwater resources in the watershed.

#### **Management Implications**

Land use and development has a direct effect on groundwater quantity and quality. Therefore, land use planning must consider



watershed functions such as groundwater recharge when directing future growth. Municipal growth strategies should direct growth and development away from sensitive watershed landscapes such as those areas that facilitate groundwater recharge. Efforts in the last number of years have focussed on delineating wellhead protection zones, assessing the threats and understanding the regional hydrogeology. Through the planning process, municipalities such as the Region of Waterloo, City of Guelph and the County of Wellington have recognized the importance of maintaining recharge in maintaining groundwater resources and have been taking steps to protect this watershed function. These initiatives include limiting the amount of impervious cover in sensitive areas and capturing precipitation with rooftop collection systems. By permitting development that facilitates groundwater recharge or redirecting development to landscapes that are not as sensitive, important watershed functions can be protected to ensure future groundwater supplies.

Water conservation measures should be actively promoted and adopted in all sectors of society. Urban communities must actively reduce consumption while rural communities require management plans to strategically irrigate using high efficiency methods and appropriate timing.

#### **Further Work**

Understanding the impact of water use on the groundwater resources in the watershed will require understanding the availability of water to allow sustainable human use while still maintaining healthy ecosystems. Assessing groundwater availability and use at appropriate scales is an important aspect of water balance calculations in the watershed. In other words, assessing water and land use at the larger watershed scale masks more local issues such as the impact of extensive irrigation.

Consistent and improved monitoring and data collection are required to accurately estimate groundwater demand as well as determine long-term trends in land use. For example, linking groundwater permits to actual well log identification numbers will assist with understanding the spatial distribution of groundwater takings. Furthermore, groundwater permit holders should be required to report actual water use as opposed to permitted use. This will help estimate actual water use and therefore the true impact on the groundwater system.

#### **Acknowledgements**

Alan Sawyer, Sandra Cooke, Jeff Pitcher and Pat Lapcevic of the Grand River Conservation Authority prepared this report. Alan Sawyer's position was partially funded through a grant from Environment Canada's Science Horizons internship program. The assistance of Samuel Bellamy of the Grand River Conservation Authority, as well as Harvey Shear, Nancy Stadler-Salt and Andrew Piggott of Environment Canada is gratefully acknowledged.

#### **Sources**

Bellamy, S., and D. Boyd. 2004. Water use in the Grand River watershed. Grand River Conservation Authority, Cambridge, Ontario, 20p.

Grand River Conservation Authority. 2003. Watershed Report, 16p.

Holysh, S., Pitcher, J. and D. Boyd. 2001. Grand River Regional Groundwater Study. Grand River Conservation Authority, Cambridge, Ontario, 78p. + figures and appendices.

Mark L. Dorfman, Planner Inc. 1997. Grand River Watershed Profile. Prepared for the Grand River Conservation Authority.

Ontario Ministry of the Environment Water Well Information System Database. 2003.

Region of Waterloo. Official Municipal Website. [www.region.waterloo.on.ca](http://www.region.waterloo.on.ca)

Statistics Canada. Census of Agriculture data for 1986, 1991, 1996.

Date Prepared: July, 29, 2004.

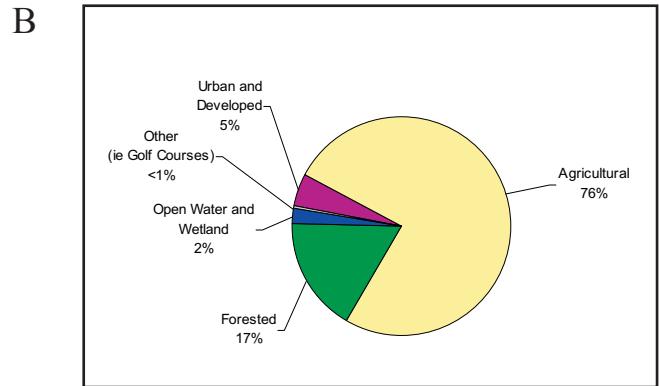
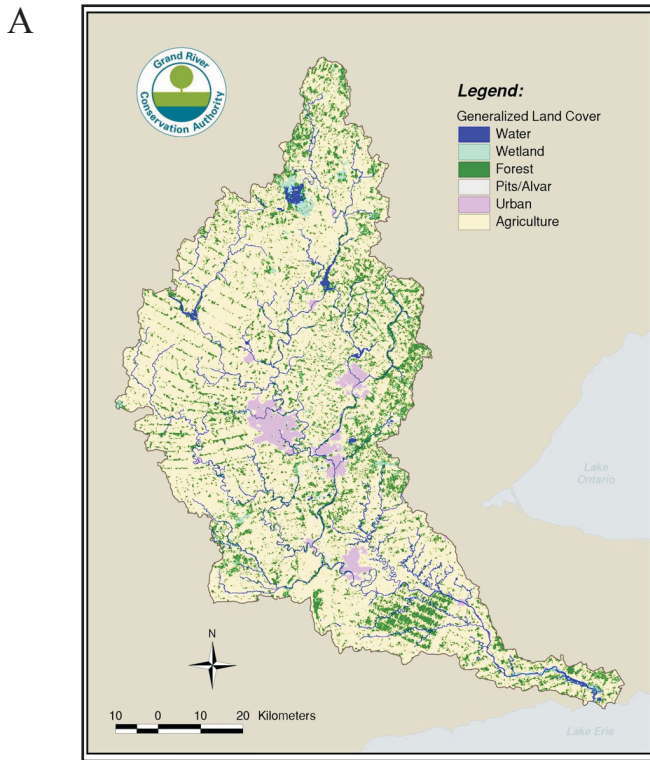
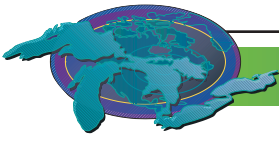


Figure 1. Land cover in the Grand River watershed: (a) Spatial distribution and (b) Percent distribution of classified land use.

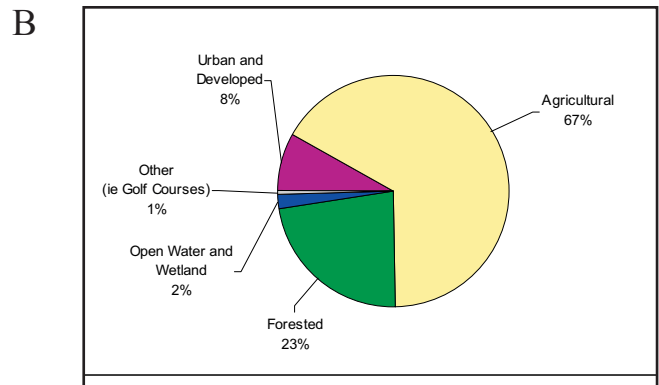
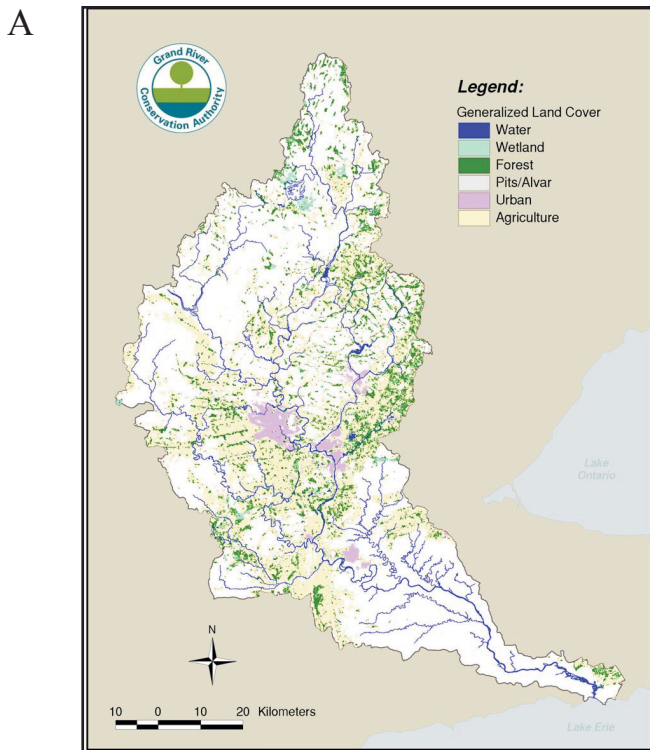


Figure 2. Land cover on moraine systems and areas that facilitate high or very high groundwater recharge of the Grand River watershed: (a) Spatial distribution and (b) Percent distribution of classified land use.

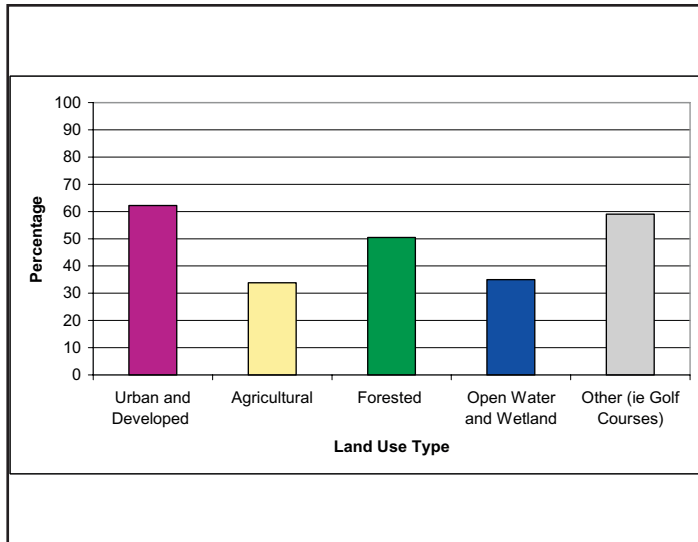
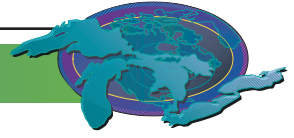


Figure 3. Percentage of land use type in significant recharge areas in the Grand River watershed.

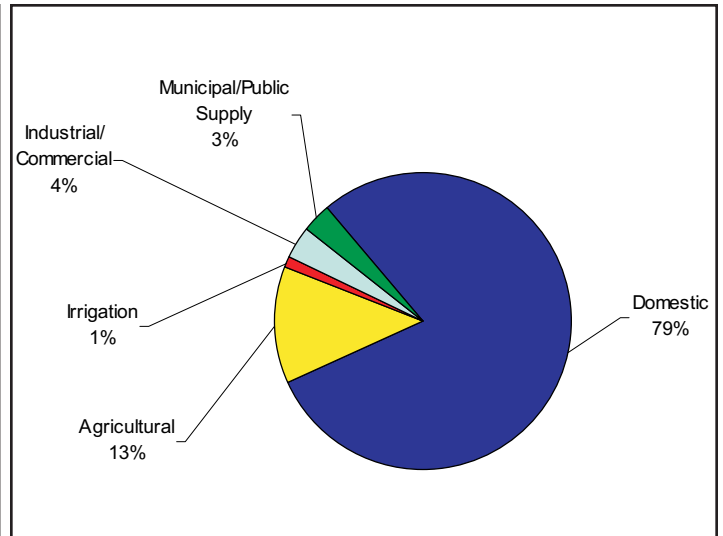


Figure 4. Distribution of groundwater wells by primary use in the Grand River watershed. *Source: Ontario Ministry of the Environment Water Well Database, 2003.*

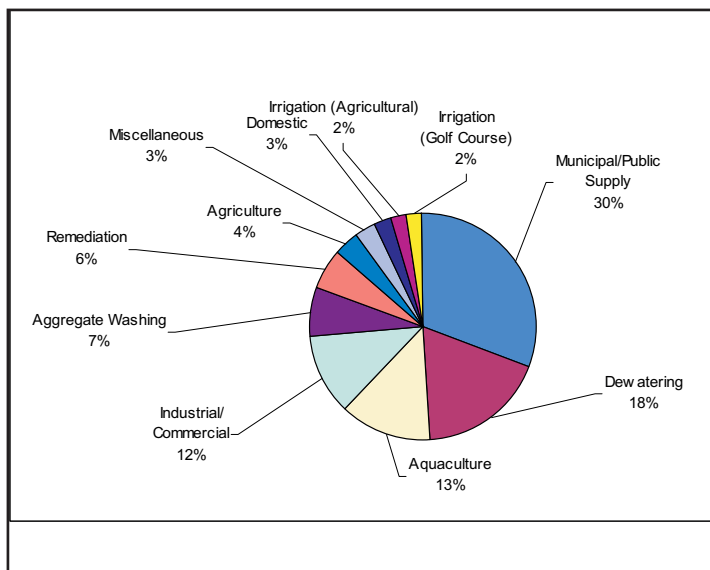


Figure 5. Percentage of total annual groundwater takings in the Grand River watershed from designated uses. *Source: Modified from Bellamy and Boyd, 2004.*

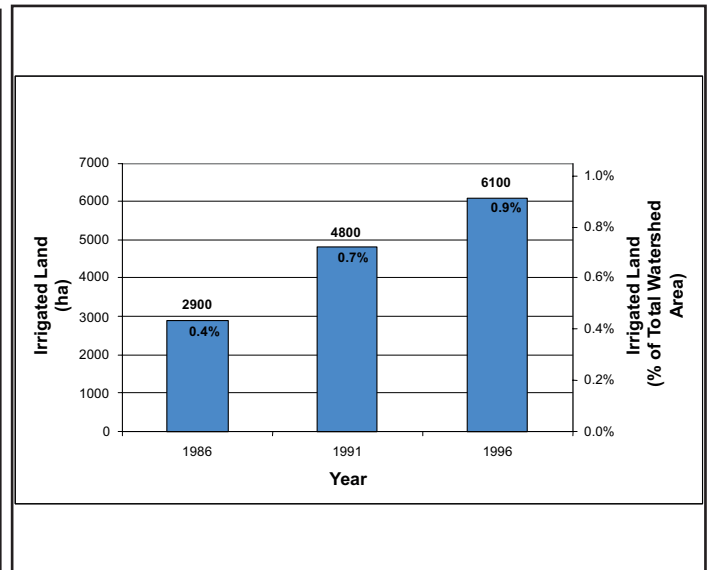


Figure 6. Changes in amount of irrigated land in the Grand River watershed (percentage of total watershed area irrigated). *Source: Statistics Canada data for 1986, 1991, and 1996.*

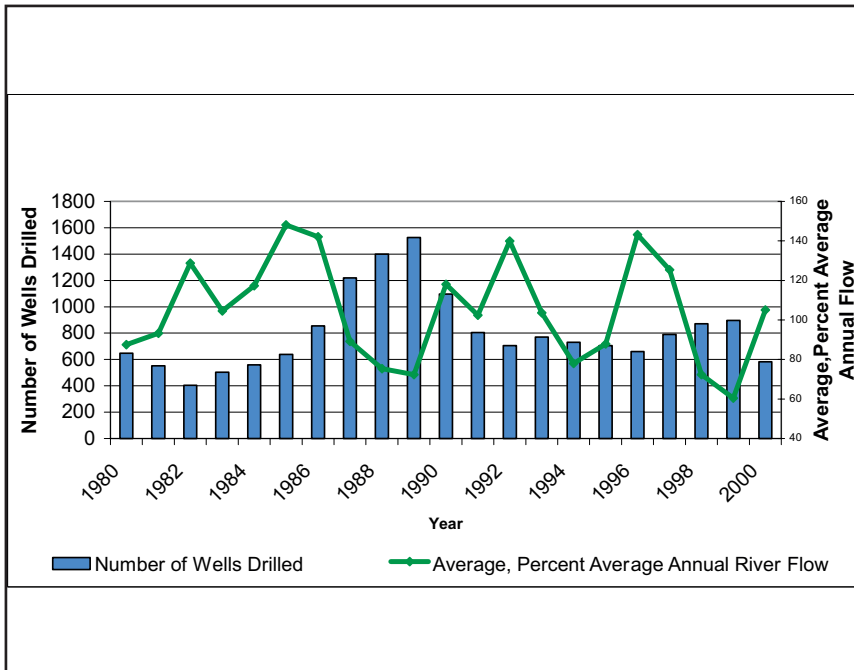
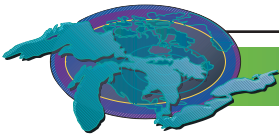


Figure 7. Number of new wells drilled each year (bar graph). Average, percent average annual stream flow in the Grand River watershed illustrating, below average, and average climatic conditions (line graph).  
 Source: Ontario Ministry of the Environment Water Well Database, 2003.

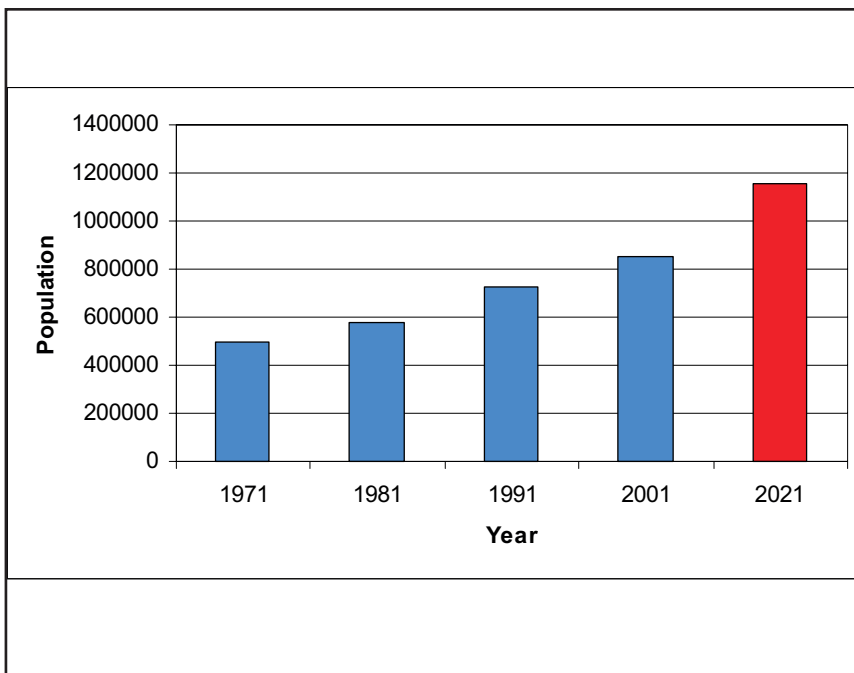
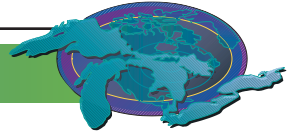


Figure 8. Estimated population in the Grand River watershed including future projections.  
 Source: Dorfman, 1997 & Grand River Conservation Authority, 2003.



## Base Flow Due to Groundwater Discharge

SOLEC Indicator #7102

### Assessment: Mixed, Deteriorating

*Note: Additional analyses and interpretation are required to validate this tentative assessment. This assessment is based the examples of analysis and interpretation that are described in this report and the perception of water resource specialists that, in at least some settings, base flow due to groundwater discharge has been impacted by factors such as urban development and water use.*

### Purpose

This indicator measures the contribution of base flow due to groundwater discharge to total stream flow and is used to detect the impacts of anthropogenic factors on the quantity of the groundwater resource.

### Ecosystem Objective

Base flow due to the discharge of groundwater to the rivers and inland lakes and wetlands of the Great Lakes basin is a significant and often majority component of stream flow, particularly during low flow periods. Base flow frequently satisfies flow, level, and temperature requirements for aquatic species and habitat. Water supplies and the capacity of surface water to assimilate wastewater discharge are also dependent on base flow. Base flow due to groundwater discharge is, therefore, critical to the maintenance of water quantity and quality and the integrity of aquatic species and habitat.

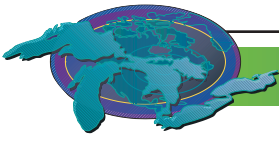
### State of the Ecosystem

Information that is required to assess base flow due to groundwater discharge at the scale of the Great Lakes basin in terms of present conditions and trends is currently being assembled. This report summarizes the importance of base flow due to groundwater discharge in the context of the Great Lakes ecosystem and provides examples of the analysis and interpretation of base flow information. More detailed presentation of these and additional results will be feasible during the next reporting period.

A significant portion of precipitation over the inland portion of the Great Lakes basin returns to the atmosphere by evapo-transpiration. Water that does not return to the atmosphere either flows across the ground surface or infiltrates into the subsurface and recharges groundwater. Some of this water is subsequently removed by consumptive uses such as irrigation and water bottling. Water that flows across the ground surface discharges into surface water features (rivers, lakes, and wetlands) and then flows toward and eventually into the Great Lakes. The component of stream flow due to runoff from the ground surface is rapidly varying and transient and results in the peak discharges of a stream.

Water that infiltrates into the subsurface and recharges groundwater also results in flow toward the Great Lakes. Most recharged groundwater flows at relatively shallow depths at local scales and discharges into adjacent surface water features. However, groundwater also flows at greater depths at regional scales and discharges either directly into the Great Lakes or into distant surface water features. The quantities of groundwater flowing at these greater depths can be significant locally but are generally believed to be modest relative to the quantities flowing at shallower depths. Groundwater discharge to surface water features in response to precipitation is greatly delayed relative to surface runoff. The stream flow resulting from groundwater discharge is, therefore, more uniform.

Base flow is the less variable and more persistent component of total stream flow. In the Great Lakes region, groundwater discharge is often the dominant component of base flow; however, various human and natural factors also contribute to base flow. Flow regulation, the storage and delayed release of water using dams and reservoirs, creates a stream flow signature that is similar to that of groundwater discharge. Lakes and wetlands also moderate stream flow, transforming rapidly varying surface runoff into more slowly varying flow that approximates the dynamics of groundwater discharge. All groundwater discharge contributes to base flow but not all base flow is the result of groundwater discharge.



Base flow is frequently determined using a mathematical process known as base flow separation. This process uses stream flow monitoring information as input and partitions the observed flow into rapidly and slowly varying components, surface runoff and base flow, respectively. The stream flow data that are used in these analyses are collected across the Great Lakes basin using networks of stream flow gauges that are operated by the United States Geological Survey and Environment Canada. Figure 1 illustrates daily stream flow monitoring information and the results of base flow separation for the Nith River near Canning, Ontario for January 1 to December 31, 1999. The rapidly varying response of stream flow to precipitation and snow melt during the winter, early spring, and late fall are in contrast to the more slowly varying base flow, which is the shaded portion of the hydrograph shown in Figure 1.

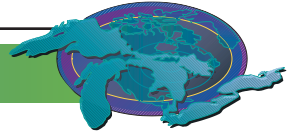
Application of base flow separation to daily stream flow monitoring information results in lengthy time series of output. Various measures are used to summarize this output; for example, base flow index is a simple and physical metric of the contribution of base flow to stream flow that is appropriate for use in regional scale studies. Base flow index is defined as the average rate of base flow relative to the average rate of total stream flow and varies from zero to one where increasing values indicate an increasing contribution of base flow to stream flow. The value of base flow index for the data shown in Figure 1 is 0.62, which implies that 62 percent of the observed flow is estimated to be base flow.

The United States Geological Survey and Environment Canada's National Water Research Institute are calculating base flow using stream flow monitoring information for all gauges in Ontario and the eight Great Lakes states. Early results, summarized in terms of base flow index and plotted relative to the locations of the gauges, are shown in Figure 2. Results have also been calculated for Quebec and are plotted in Figure 2. These results are unfiltered and are known to reflect factors such as flow regulation and extensive areas of lakes and wetlands that modify the observed stream flow regimes. The results are, therefore, not yet a certain indicator of groundwater conditions, particularly in the regions of Ontario and Quebec where lakes and wetlands are most abundant. Figure 2 also illustrates the results of averaging the values of base flow index calculated for the gauges over the United States and Canadian sub-sub-basins and sub-basins of the Great Lakes (GLIN 2000).

The diversity of groundwater conditions within the Great Lakes basin is apparent in Figure 2. For example, lower values of base flow index that occur in southwestern Ontario are similar to those in eastern Michigan and to even lower values that occur along the southern shore of Lake Erie. A region of lower values also occurs in eastern Ontario where the geology is similar to that of southwestern Ontario. Water management practices that are successful in southwestern Ontario may, therefore, be more relevant in eastern Ontario than in central Ontario where intermediate values of base flow index are typical. Further analysis is required to determine if the lower values of base flow index that occur along the western and southern shore of Lake Michigan are the result of geologic factors, urban development, or the intensive use of groundwater. The higher values of base flow index that occur in northern Michigan appear to be unique as the comparable values that occur within the Ottawa River drainage basin may be a reflection of the abundance of lakes and wetlands. The glacial deposits in the northern part of Michigan's Lower Peninsula are dominantly composed of sand and gravel with high rates of infiltration.

Base flow information can also be used to detect changes in stream flow regimes and, therefore, to assess the impacts of various human and climatic factors. This is demonstrated through the interpretation of information for stream flow gauge 02GA003 on the Grand River at Galt, Ontario; gauge 02GA010 on the Nith River near Canning, Ontario; and gauge 04166100 on the River Rouge at Southfield, Michigan. The locations, watersheds, and surface water features of these gauges are shown in Figure 3. The most lightly shaded areas in Figure 3 denote relatively intense nighttime lighting due to human settlements (NOAA DMSP 2002), which is an indicator of urban development. The extent of nighttime lighting ranges from very limited within the watershed of the Nith River to modest within the watershed of the Grand River and intense throughout the watershed of the River Rouge.

Stream flow in the Grand River at Galt is regulated by eight dams and reservoirs. These structures are used to retain a portion of stream flow during periods of high flow and release water from storage during periods of low flow. The structures are, therefore, multi-purpose in that they reduce the potential for flooding and maintain water quantity and quality during periods of low flow. The dams were constructed from 1942 to 1978 and control reservoirs with a combined storage capacity of 187 million cubic metres, which is equivalent to the average stream flow in the Grand River at Galt for 60 days. There are no major flow regulation structures upstream of the Nith River near Canning, and very limited urban development, and the observed stream flow regime is, therefore, believed to be near-natural.



Annual values of base flow index calculated for the Grand River at Galt and Nith River near Canning are illustrated in Figure 4. The dates of construction and cumulative capacities of the flow regulation structures are plotted relative to the results for the Grand River at Galt. The largest of the structures – the Shand, Luther, Conestogo, and Guelph dams – were constructed in 1942, 1952, 1958, and 1976, respectively. The impact of the construction of the dams, particularly of the Conestogo dam, on the stream flow regime is significant. The average of the annual values of base flow index for years prior to the construction of the first of the dams in 1942 is 0.44 and the average for years following the construction of the final dam in 1978 is 0.59. Flow regulation has, therefore, resulted in an increase in base flow index of 0.15. Annual values of base flow index calculated for the Nith River near Canning do not follow the same trend. The averages of the values prior to 1942 and following 1978 are both equal to 0.49. In addition, while only roughly 10 percent of the values of base flow index calculated for the Grand River at Galt following the construction of the Conestogo dam are less than average, roughly 60 percent of the values calculated for the Nith River near Canning during the same period are below average.

Interpretation of base flow information for the River Rouge at Southfield is more complex. Significant population growth in Oakland County, which includes the watershed for the River Rouge, began between 1910 and 1920 and was greatest between roughly 1940 and 1970. Annual values of base flow index for the River Rouge at Southfield from 1959 to 2000 are illustrated in Figure 5 and compared to annual precipitation and statistics of the observed stream flow. These statistics are the minimum and maximum of the daily values for each year and the average of the daily values. Precipitation and base flow index alternate between below and above average and do not indicate a clear trend. Roughly 50 percent of the values of base flow index are below average and roughly 50 percent of the values are above average. Base flow index is below average most frequently when precipitation is above average and is above average most frequently when precipitation is below average. Year-to-year variations in base flow index are, therefore, at least partly controlled by climate with the expected outcome of higher rates of base flow relative to total stream flow in drier years.

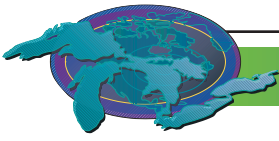
The maximum values of flow in the River Rouge alternate between below and above average over the duration of the data. In contrast, the average and minimum values of flow appear to indicate a change in the flow regime that may be related to the urbanization of the watershed. A reduction in the year-to-year variation of both statistics is apparent beginning in approximately 1972. During the 12 years of 1989 to 2000, precipitation was below average during 8 years while average stream flow was below average during only one year and minimum stream flow was never below average. Episodes of very low flow, minimum values approaching zero, were common during the period of 1961 to 1971 and did not re-occur after 1971. It is likely that these changes in the stream flow regime are due to conveyance losses and other discharges of municipally supplied water taken from sources outside of the watershed.

The annual values of base flow index calculated for the River Rouge at Southfield do not appear to indicate the urbanization of the watershed. It is generally assumed that urbanization results in increased extents of impervious surfaces such as pavement and roofing, more rapid drainage, and a corresponding decrease in the base flow component of stream flow. It is possible that, in this case, the anticipated reduction in base flow index is offset by an increase resulting from discharges of municipally supplied water. Additional analyses of near-natural and urbanized watersheds are required to determine if these findings are typical or anomalous. It is important to note that, while base flow index does not appear to respond to the urbanization of the watershed, the apparent increase in average flow multiplied by the nearly constant value of base flow index does imply an increase in annual volumes of base flow.

### Pressures

The discharge of groundwater to surface water features is the end-point of the process of groundwater recharge, flow, and discharge. Human activities impact groundwater discharge by modifying the components of this process. Increasing the extent of impervious surfaces during residential and commercial development and installation of drainage to increase agricultural productivity are examples of activities that may reduce recharge and ultimately discharge. Withdrawals of groundwater as a water supply and during dewatering remove groundwater from the flow regime and may also reduce groundwater discharge. Groundwater discharge may be impacted by activities such as the channelization of water courses that restrict the motion of groundwater across the groundwater and surface water interface. Human activities also have the capacity to intentionally, or unintentionally, increase groundwater discharge. Induced storm water infiltration, conveyance losses within municipal water and wastewater systems, and closure of local water supplies derived from groundwater are examples of factors that may increase groundwater discharge. Climate variability and change





may compound the implications of human activities relative to groundwater recharge, flow, and discharge.

### **Management Implications**

Groundwater has important societal and ecological functions across the Great Lakes basin. Groundwater is typically a high quality water supply that is used by a significant portion of the population, particularly in rural areas where it is often the only available source of water. Groundwater is also critical to aquatic species and habitat and to in-stream water quantity and quality. These functions are concurrent and occasionally conflicting. Pressures such as urban development and water use, in combination with the potential for climate impacts and further contamination of the resource, may increase the frequency and severity of these conflicts. In the absence of systematic accounting of groundwater supplies, use, and dependencies; it is the ecological function of groundwater that is most likely to be compromised.

Managing the water quality of the Great Lakes requires an understanding of water quantity and quality within the inland portion of the basin, and this understanding requires recognition of the relative contributions of surface runoff and groundwater discharge to stream flow. Results, such as those shown in Figure 2 of this report, indicate the significant contribution of groundwater discharge to flow within the tributaries of the Great Lakes. The extent of this contribution has tangible management implications. There is considerable diversity in groundwater recharge, flow, and discharge that must be reflected in the land and water management practices that are applied across the basin. The dynamics of groundwater flow and transport are different than those of surface water flow. Groundwater discharge responds more slowly to climate and maintains stream flow during periods of reduced water availability; however, this capacity is known to be both variable and finite. Contaminants that are transported by groundwater may be in contact with geologic materials for years, decades, and perhaps even centuries or millennia. As a result, there may be considerable opportunity for attenuation of contamination prior to discharge. However, the lengthy residence times of groundwater flow also limit opportunities for the remediation of contamination, in general, and non-point source contamination, in particular.

### **Acknowledgements**

This report was prepared by Andrew Piggott and Sarah Day of Environment Canada's National Water Research Institute and Brian Neff and Jim Nicholas of the United States Geological Survey. Base flow information cited in the report is a product of *Groundwater and the Great Lakes: A Co-ordinated Bi-national Basin-wide Assessment in Support of Annex 2001 Decision Making*, which is supported by the Great Lakes Protection Fund. Norman Grannemann of the United States Geological Survey reviewed a draft version of this report.

### **Sources**

GLIN 2000, Great Lakes Information Network, Basinwide Reference Layers, Great Lakes Region Watersheds, <http://www.glin.net/gis/data/refdata/glwsheds.zip>

NOAA DMSP 2002, National Oceanic and Atmospheric Administration Defense Meteorological Satellite Program, Nighttime Lights of the World: 1994-1995, Human Settlements, [http://dmsp.ngdc.noaa.gov/data/stable\\_lights/cities.tar](http://dmsp.ngdc.noaa.gov/data/stable_lights/cities.tar)

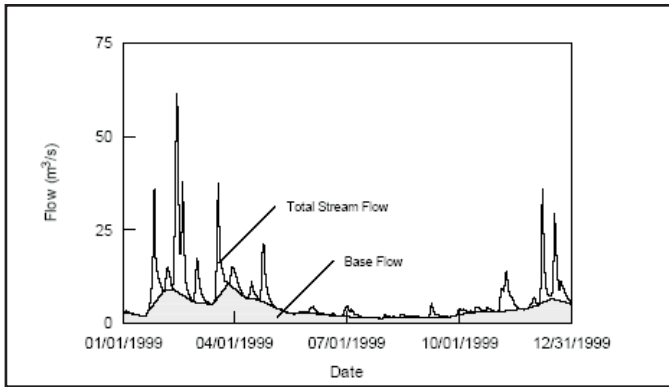
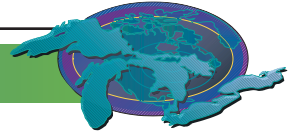


Figure 1. Hydrograph of observed total stream flow and calculated base flow for the Grand River at Galt during 1999.

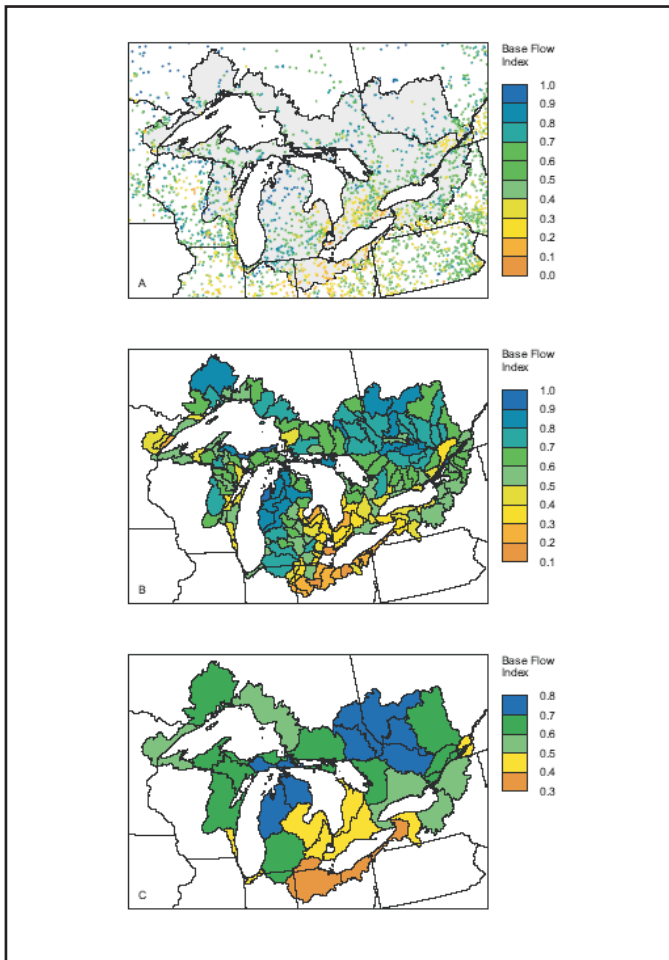


Figure 2. Values of base flow index calculated for stream flow gauges in Ontario, Quebec, and the eight Great Lakes states (A) and these values averaged over the corresponding sub-sub-basins (B) and sub-basins (C) of the Great Lakes. Different legends are used for each set of results in order to most clearly depict the range of values of base flow index.

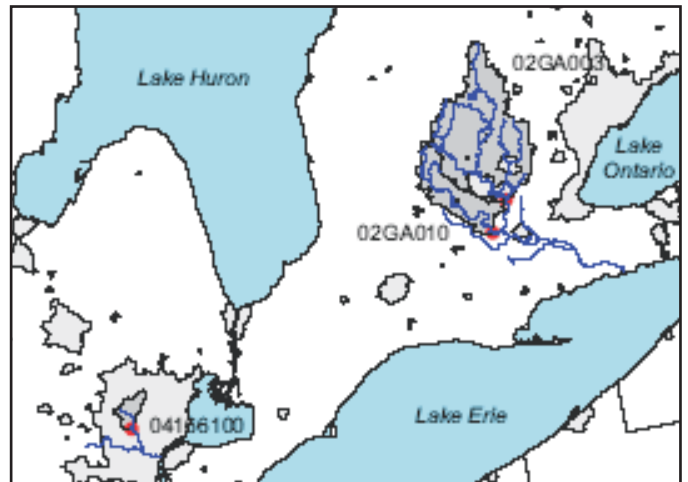


Figure 3. Locations of the Grand River at Galt (02GA003), Nith River near Canning (02GA010), and River Rouge at Southfield (04166100). The locations of the three stream flow gauges are indicated by red points and the corresponding watersheds are most darkly shaded. Areas of nighttime lighting are more lightly shaded.

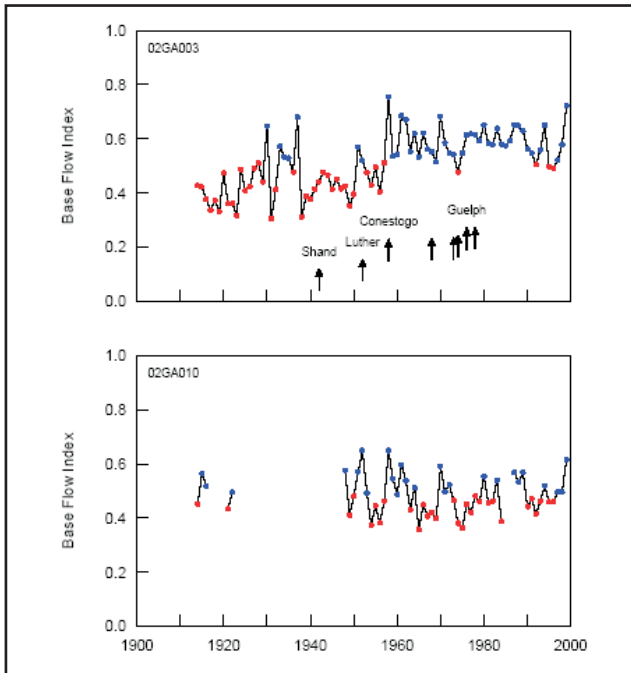
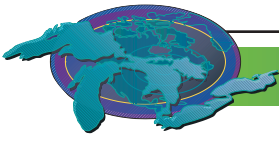
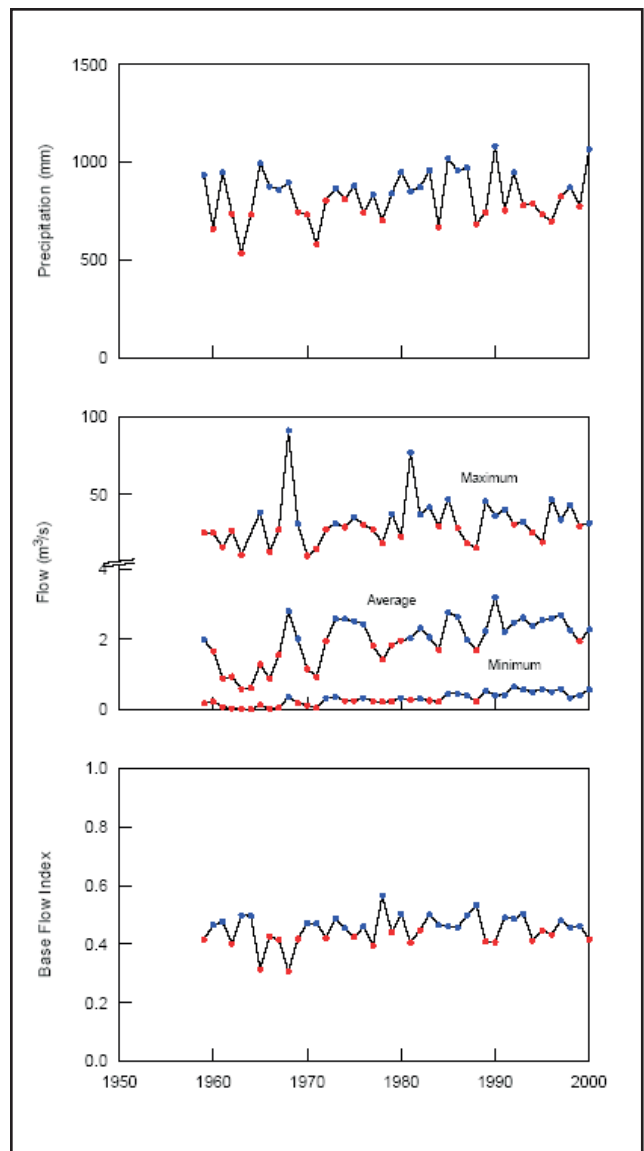


Figure 4. Annual values of base flow index for the Grand River at Galt (02GA003) and Nith River near Canning (02GA010). The red and blue points indicate annual values that are below and above, respectively, the average of all of the values for each gauge.

Figure 5. Annual values of total precipitation; annual values of the minimum, maximum, and average of daily stream flow; and annual values of base flow index for the River Rouge at Southfield. The red and blue points indicate annual values that are below and above, respectively, the average of all of the values of each parameter.





## Groundwater Dependant Plant and Animal Communities

SOLEC Indicator #7103

### Assessment: N/A

Note: This indicator report uses data from the Grand River Watershed only and may not be representative of groundwater conditions throughout the Great Lakes Basin. Additionally, there is insufficient biological and physical hydrological data for most of the streams in the Grand River watershed to report on many of the selected species reliant on groundwater discharge, hence this discussion focuses on brook trout (*Salvelinus fontinalis*) as an indicator of groundwater discharge.

### Purpose

This indicator measures the abundance and diversity as well as presence or absence of native invertebrates, fish, plant and wildlife communities that are dependent on groundwater discharges to aquatic habitat. An additional focus of this indicator could be the presence of cool water adapted frogs and salamanders. This indicator will use biological communities to assess locations of groundwater intrusions. By inference, this indicator will also describe certain chemical and physical properties of groundwater, including changes in patterns of seasonal flow. The purpose of this indicator is to identify and understand any deterioration of water quality for animals and humans, as well as changes in the productive capacity of flora and fauna dependant on groundwater resources.

### Ecosystem Objective

The integrity of larger water bodies can be linked to biological, chemical and physical integrity of the smaller watercourses that feed them. Many of these small watercourses are fed by groundwater. As a result, groundwater discharge to surface waters becomes cumulatively important when considering the quality of water entering the Great Lakes. The identification of groundwater fed streams and rivers will provide useful information for the development of watershed management plans that seek to protect these sensitive watercourses.

Human activities can change the hydrological processes in a watershed resulting in changes to recharge rates of aquifers and discharges rates to streams and wetlands. This indicator should serve to identify organisms at risk because of human activities and can be used to quantify trends in communities over time. The goal for this indicator is to ensure that plant and animal communities function at or near potential and that populations are not significantly compromised due to anthropogenic factors.

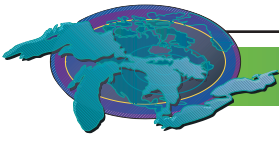
### State of the Ecosystem

The surficial geology of the Grand River watershed is generally divided into three distinct regions; the northern till plain, central moraines with large sand and gravel deposits, and the southern clay plain (Figure 1). These surficial overburden deposits are underlain by thick sequences of fractured carbonate rock (predominantly dolostone).

The Grand River and its tributaries form a stream network housing approximately 11,329 km of stream habitat. The Ontario Ministry of Natural Resources (MNR) has classified many of Ontario's streams based on habitat type. While many streams and rivers in the Grand River watershed remain unclassified, the MNR database currently available through the natural resources and values information system (NRVIS) has documented and classified about 22 percent of the watershed's streams (Figure 2). Approximately 19 percent of the classified streams are cold-water habitat and therefore dependent on groundwater discharge. An additional 16 percent of the classified streams are considered potential coldwater habitat. The remaining 65 percent of classified streams are warm-water habitat.

A map of potential groundwater discharge areas was created for the Grand River watershed by examining the relationship between the water table and ground-surface (Figure 3). This map indicates areas in the watershed where water well records indicate that the water table could potentially be higher than the ground surface. In areas where this is the case, there is a strong tendency toward discharge of groundwater to land, creating cold -water habitats. Groundwater discharge appears to be geologically controlled with most potential discharge areas noted associated with the sands and gravels in the central moraine areas and little discharge in the northern till plain and southern clay plain. The map suggests that some of the unclassified streams in Figure 2 may be potential cold-water streams, particularly in the central portion of the watershed where geological conditions are favourable to groundwater discharge.

Brook trout is a freshwater fish species native to eastern Canada. The survival and success of brook trout is closely tied to cold groundwater discharges in streams used for spawning. Specifically, brook trout require inputs of cold clean water to successfully



reproduce. As a result, nests or redds are usually located in substrate where groundwater is upwelling into surface water. A significant spawning population of adult brook trout generally indicates a constant source of cool good quality groundwater.

Locations of observed brook trout redds are shown on Figure 3. The data shown are a compilation of several surveys carried out on selected streams in 1988 and 1989. Additional data from several sporadic surveys carried out in the 1990s are also included. These redds may represent single or multiple nests from brook trout spawning activity. The results of these surveys illustrate that there are significant high quality habitats in several of the subwatersheds in the basin.

Cedar Creek is a tributary of the Nith River in the central portion of the watershed. It has been described as containing some of the best brook trout habitat in the watershed. Salmonoid spawning surveys for brook trout were carried out over similar stretches of the creek in 1989 and 2003 (Figure 4). In 1989 a total redd count of 53 (over 4.2 km) was surveyed while in 2003 the total redd count was 59 (over 5.4 km). In both surveys, many of the redds counted were multiple redds meaning several fish had spawned at the same locations. Redd densities in 1989 and 2003 were 12.6 redds/km and 10.9 redds/km respectively. From Figure 4 it appears that in 2003 brook trout were actively spawning in Cedar Creek in mainly the same locations as in 1989. While redd density in Cedar Creek has decreased slightly, the similar survey results suggest that groundwater discharge has remained fairly constant and reductions in discharge have not significantly affected aquatic habitat.

#### **Pressures**

The removal of groundwater from the subsurface through pumping at wells reduces the amount of groundwater discharging into surface water bodies. Increasing impervious surfaces reduces the amount of water that can infiltrate into the ground and also ultimately reduces groundwater discharge into surface water bodies. Additionally, reducing the depth to the water table from ground surface will decrease the geological protection afforded groundwater supplies and may increase the temperature of groundwater. Higher temperatures can reduce the moderating effect groundwater provides to aquatic stream habitat. At local scales the creation of surface water bodies through mining or excavation of aggregate or rock may change groundwater flow patterns, which in turn might decrease groundwater discharge to sensitive habitats.

In the Grand River Watershed, groundwater is used by about 80 percent of the watershed's residents as their primary water supply. Additionally, numerous industrial and agricultural users also use groundwater for their operations. Growing urban communities will put pressure on the resource and if not managed properly will lead to decreases in groundwater discharge to streams. Development in some areas can also lead to decreased areas available for precipitation to percolate through the ground and recharge groundwater supplies.

#### **Management Implications**

Ensuring that an adequate supply of cold groundwater continues to discharge into streams requires protecting groundwater recharge areas and ensuring that groundwater withdrawals are undertaken at sustainable rates. Additionally, an adequate supply of groundwater for habitat purposes does not only refer to the quantity of discharge but also to the chemical quality, temperature and spatial location of that discharge. As a result, protecting groundwater resources is complicated and generally requires multi-faceted strategies including regulation, voluntary adoption of best management practices and public education.

#### **Further Work Necessary**

This report has focused on only one species dependent on groundwater discharge for their habitat. The presence or absence of other species should be investigated through systematic field studies.

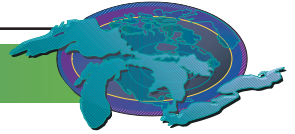
#### **Acknowledgements**

Alan Sawyer, Sandra Cooke, Jeff Pitcher, and Pat Lapcevic of the Grand River Conservation Authority prepared this report. Alan Sawyer's position was partially funded through a grant from Environment Canada's Science Horizons internship program. The assistance of Samuel Bellamy and Warren Yerex of the Grand River Conservation Authority, as well as Harvey Shear, Nancy Stadler-Salt and Andrew Piggott of Environment Canada is gratefully acknowledged.

#### **Sources**

Grand River Conservation Authority. 2003. Brook Trout (*Salvelinus fontinalis*) Spawning Survey – Cedar Creek.

Grillmayer, R.A. and R.J. Baldwin. 1990. Salmonid Spawning Surveys of Selected Streams in the Grand River Watershed 1988-



1989. Environmental Services Group, Grand River Conservation Authority.

Holysh, S., Pitcher, J. and D. Boyd. 2001. Grand River Regional Groundwater Study. Grand River Conservation Authority, Cambridge, Ontario, 78pp + figures and appendices.

Scott, W.B. and E.J. Crossman. 1973. Freshwater Fishes of Canada. Bulletin 184; Fisheries Research Board of Canada, Ottawa. p 208-213.

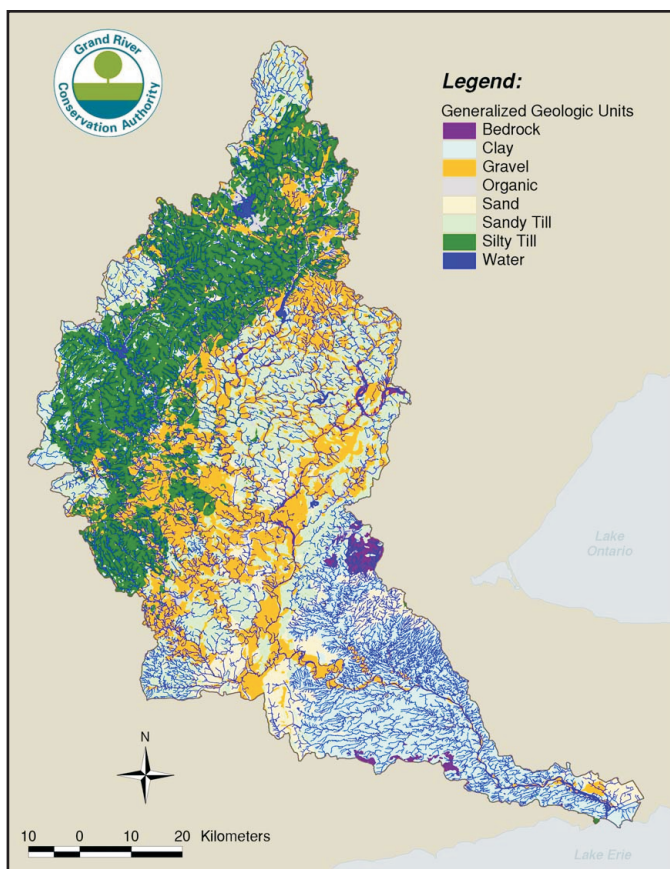


Figure 1. Surficial geology of the Grand River watershed.

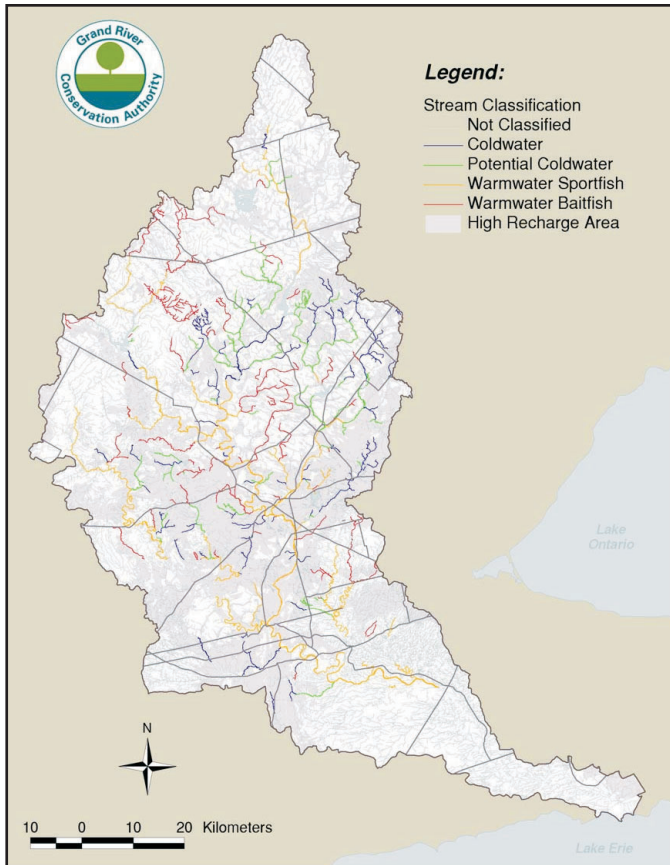
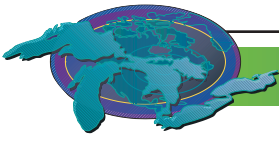


Figure 2. Streams of the Grand River watershed.

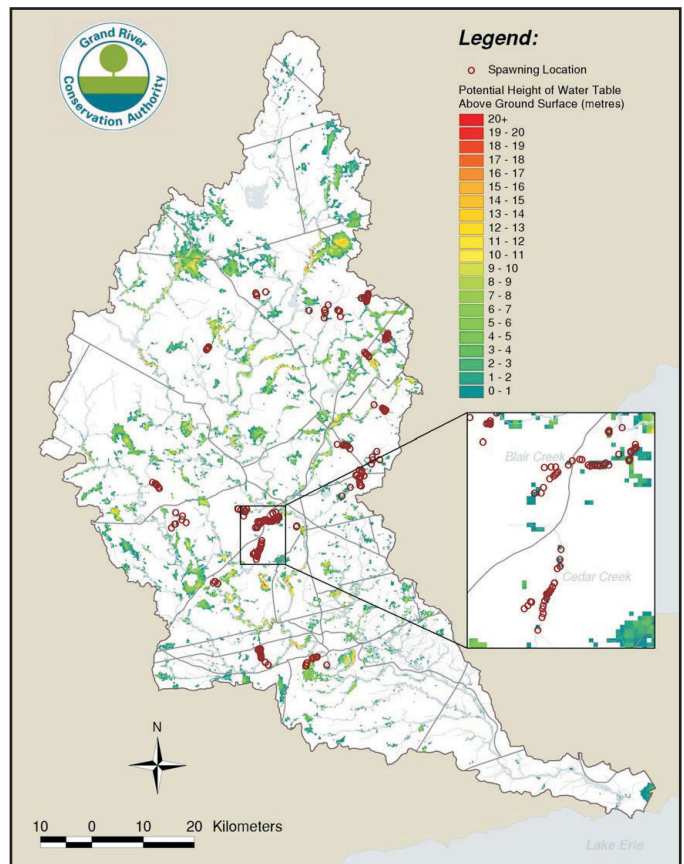


Figure 3. Map of potential discharge areas in the Grand River watershed.

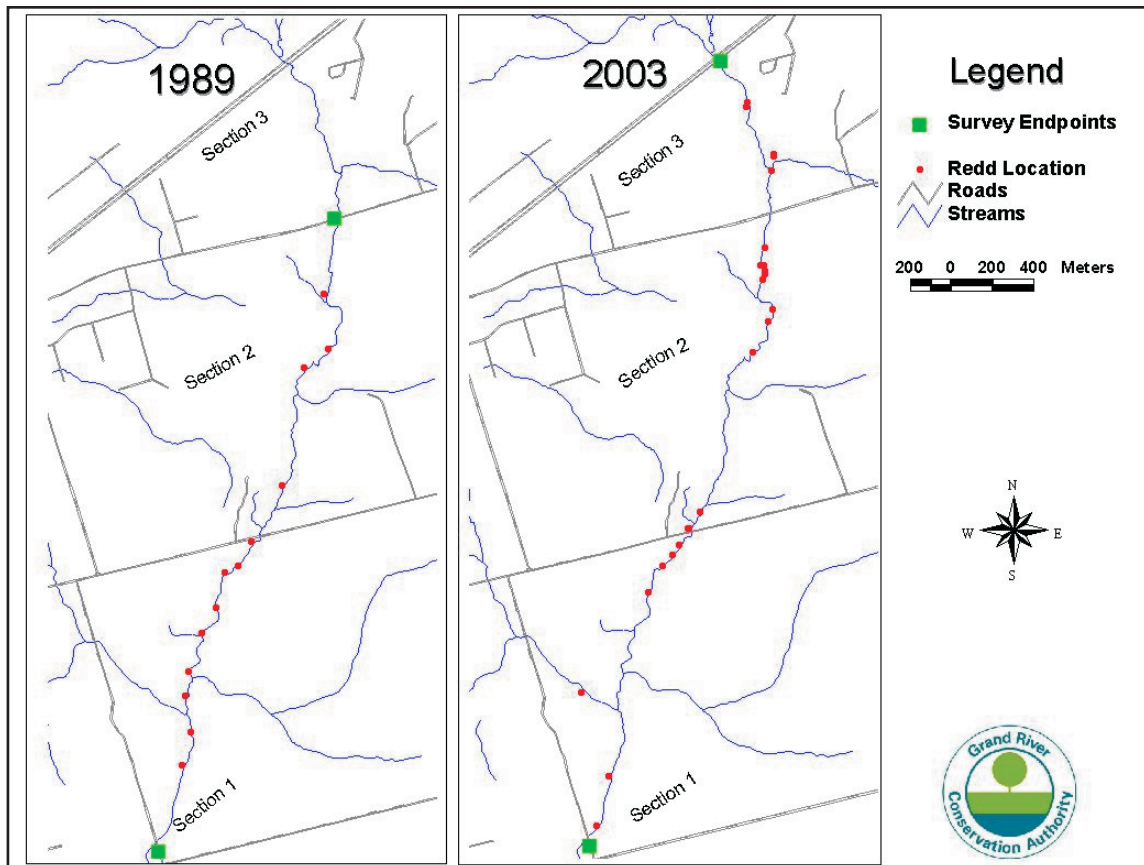
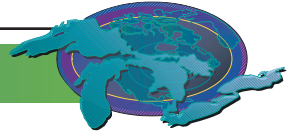


Figure 4. Results of brook trout spawning surveys carried out in the Cedar Creek subwatershed in 1989 and 2003.





## Area, Quality and Protection of Alvar Communities

SOLEC Indicator #8129 (alvar)

*This indicator report is from 2000*

### Assessment: Mixed

#### Purpose

This indicator assesses the status of one of the 12 special lakeshore communities identified within the nearshore terrestrial area. Alvar communities are naturally open habitats occurring on flat limestone bedrock. They have a distinctive set of plant species and vegetative associations, and include many species of plants, mollusks, and invertebrates that are rare elsewhere in the basin. All 15 types of alvars and associated habitats are globally imperiled or rare. Over 2/3 of known alvar occurrences within the Great Lakes Basin are close to the shoreline.

#### Ecosystem Objective

Conservation of alvar communities relates to IJC Desired Outcome 6: Biological Community integrity and Diversity. A four-year study of Great Lakes alvars completed in 1998 (the International Alvar Conservation Initiative-IACI) evaluated conservation targets for alvar communities, and concluded that essentially all of the existing viable occurrences should be maintained, since all types are below the minimum threshold of 30-60 viable examples. As well as conserving these ecologically distinct communities, this target would protect populations of dozens of globally significant and disjunct species. A few species, such as Lakeside Daisy (*Hymenoxis herbacea*) and the beetle *Chlaenius p. purpuricollis*, have nearly all of their global occurrences within Great Lakes alvar sites.

#### State of the Ecosystem

Alvar habitats have likely always been sparsely distributed, but more than 90% of their original extent has been destroyed or substantially degraded by agriculture and other human uses. Approximately 64% of the remaining alvar area occurs within Ontario, with about 16% in New York State, 15% in Michigan, 4% in Ohio, and smaller areas in Wisconsin and Quebec.

Data from the IACI and state/provincial alvar studies was screened and updated to identify viable community occurrences. Just over 2/3 of known Great Lakes alvars occur close to the shoreline, with all or a substantial portion of their area within 1 km of the shore.

Note that typically several different community types occur within each alvar site.

Among the 15 community types documented, six types show a strong association (over 80% of their acreage) with nearshore settings. Four types have less than half of their occurrences in nearshore settings.

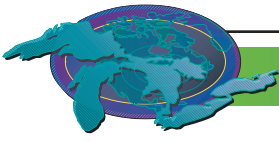
The current status of all nearshore alvar communities was evaluated by considering current land ownership and the type and severity of threats to their integrity. As shown in the figure, less than 1/5th of the nearshore alvar acreage is currently fully protected, while over 3/5th is at high risk.

The degree of protection for nearshore alvar communities varies considerably among jurisdictions. For example, Michigan has 66% of its nearshore alvar acreage in the Fully Protected category, while Ontario has only 7%. In part, this is a reflection of the much larger total shoreline acreage in Ontario, as shown in the following figure. (Other states have too few nearshore sites to allow comparison).

Each alvar community occurrence has been assigned an "EO rank" to reflect its relative quality and condition. A and B-ranks are considered viable, while C-ranks are marginal. As shown in the following figure, protection efforts to secure alvars have clearly focused on the best quality sites.

#### Pressure on the Ecosystem

Nearshore alvar communities are most frequently threatened by habitat fragmentation and loss, trails and off-road vehicles, resource extraction uses such as quarrying or logging, and adjacent land uses such as residential subdivisions. Less frequent threats include grazing or deer browsing, plant collecting for bonsai or other hobbies, and invasion by non-native plants such as European



Buckthorn and Dog-strangling Vine.

#### Recent Progress

Documentation of the extent and quality of alvars through the IACI has been a major step forward, and has stimulated much greater public awareness and conservation activity for these habitats. Over the past two years, a total of 10 securement projects has resulted in protection of at least 5289.5 acres of alvars across the Great Lakes basin, with 3344.5 acres of that within the nearshore area. Most of the secured nearshore area is through land acquisition, but 56 acres on Pelee Island (ON) are through a conservation easement, and 1.5 acres on Kelleys Island (OH) are through State dedication of a nature reserve. These projects have increased the area of protected alvar dramatically in a short time.

#### Future Actions

Because of the large number of significant alvar communities at risk, particularly in Ontario, their status should be closely watched to ensure that they are not lost. Major binational projects hold great promise for further progress, since alvars are a Great Lakes resource, but most of the unprotected area is within Ontario. Projects could be usefully modeled after the 1999 Manitoulin Island (ON) acquisition of 17,000 acres through a cooperative project of The Nature Conservancy of Canada, The Nature Conservancy, Federation of Ontario Naturalists, and Ontario Ministry of Natural Resources.

#### Acknowledgments

Authors: Ron Reid, Bobolink Enterprises, Washago, ON, and Heather Potter, The Nature Conservancy, Chicago, IL.

#### Sources

Brownell, Vivian R. and John L. Riley 2000. The Alvars of Ontario: Significant Alvar Natural Areas in the Ontario Great Lakes Region. Federation of Ontario Naturalists, Toronto, ON.

Cusick, Allison W. 1998. Alvar Landforms and Plant Communities in Ohio. Ohio Dept. of Natural Resources, Columbus OH.

Gilman, Bruce 1998. Alvars of New York: A Site Summary Report. Finger Lakes Community College, Canandaigua, NY.

Lee, Yu Man, Lyn J. Scrimger, Dennis A. Albert, Michael R. Penskar, Patrick J. Comer and David L. Cuthrell 1998. Alvars of Michigan. Michigan Natural Features Inventory, Lansing MI.

Reid, Ron 2000. Great Lakes Alvar Update, July 2000. Prepared for distribution to the International Alvar Conservation Initiative Working Group. Bobolink Enterprises, Washago, Ontario.

Reschke, Carol, Ron Reid, Judith Jones, Tom Feeney and Heather Potter 1999. Conserving Great Lakes Alvars: Final Technical Report of the International Alvar Conservation Initiative. The Nature Conservancy, Chicago, Illinois.

	Total in Basin	Nearshore
No. of alvar sites	82	52
No. of community occurrences	204	138
Alvar acreage	28 475	20 009

Table 1. Number of Alvar sites/communities found near-shore and total in the basin  
Source: Ron Reid, Bobolink Enterprises

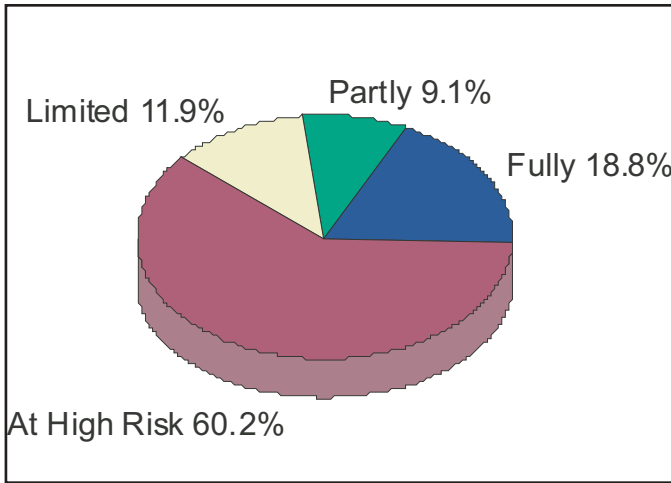
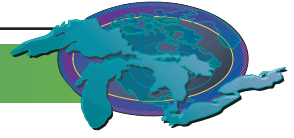


Figure 1. Protection Status 2000. Nearshore alvar acreage.

Source: Ron Reid, Bobolink Enterprises.

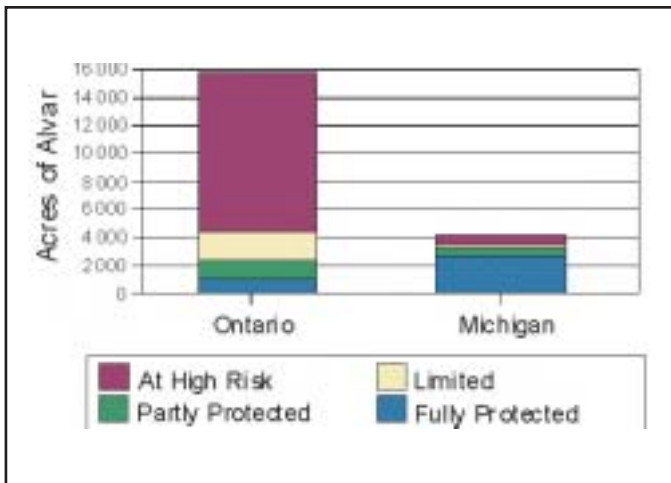


Figure 2. Comparison of acreage protected. Nearshore alvars: Ontario and Michigan.

Source: Ron Reid, Bobolink Enterprises.

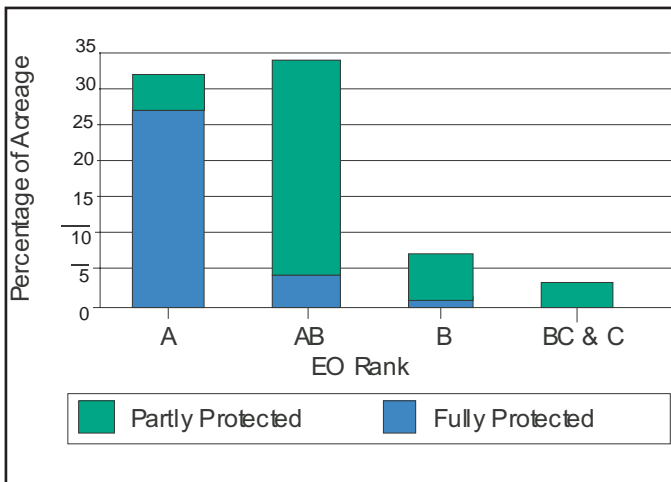
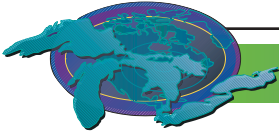


Figure 3. Protection of high quality alvars.

Source: Ron Reid, Bobolink Enterprises.



## Cobble Beaches

SOLEC Indicator #8129 (Cobble Beaches)

**Assessment: Mixed, Deteriorating**

### Purpose

This indicator assesses the status of cobble beaches, one of the twelve special shoreline communities identified within the nearshore terrestrial area. Cobble beaches are shaped by wave and ice erosion. They are home to a variety of plant species, several of which are threatened or endangered statewide, globally, or both making them one of the most biodiverse terrestrial communities along the Great Lakes shoreline. Cobble beaches serve as seasonal spawning and migration areas for fish as well as nesting areas for the federally endangered piping plover.

### Ecosystem Objective

Ultimately, analysis of this indicator should provide information on the location and status of cobble beaches from existing studies (where available) as well as identify the rare terrestrial species found at each location.

### State of the Ecosystem

Cobble beaches have always been a part of the Great Lakes shoreline. The number and area of these beaches, however, is decreasing due to shoreline development. In fact, cobble shorelines are becoming so scarce along shorelines that they are considered globally rare.

Lake Superior has the largest cobble shoreline of all the Great Lakes with 595 miles of cobble beaches (Figure 1); 336 miles on the Canadian side and 259 miles on the United States side. This constitutes for 20% of the whole Lake Superior shoreline (11.3% on the Canadian side and 8.7% on the United States side).

Lake Huron follows behind Lake Superior with approximately 300 miles of cobble shoreline; 205 miles on the Canadian side and 95 miles on the United States side. Most of the cobble beaches here are found along the shoreline of the Georgian Bay (Figure 2). This constitutes for approximately 9% of the whole Lake Huron shoreline (6.1% on the Canadian side and 2.8% on the United States side)

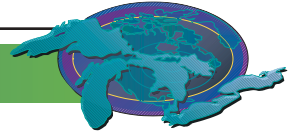
Approximately 102 miles of the Lake Michigan shoreline is cobble, representing 6.1% of its shoreline. Most of these beaches are located at the northern end of the lake along the Michigan shoreline (Figure 3).

Lake Ontario has a very small cobble shoreline of about 21.78 miles representing only 3% of its shoreline (Figure 4).

Lake Erie has the smallest cobble shoreline of all the Great Lakes with only 16.28 miles of cobble shore. This small area represents approximately 1.9% of the lake's shoreline (Figure 5).

While the beaches themselves are scarce, they have a wide variety of vegetation surrounding them. They also serve as home to plants that are endemic to the Great Lakes Shoreline.

Lake Superior's large cobble shoreline provides for several rare plant species (Table 1) some of which include the Lake Huron Tansy and Redroot. It is also home to the endangered Heart-leaved plantain, which is protected under the Ontario Endangered Species Act.



<b>Lake Superior</b>	
<b>Common Name</b>	<b>Scientific Name</b>
Bulrush sedge	Carex scirpoidea
Great northern aster	Aster modestus
Northern reedgrass	Calamagrostis lacustris
Purple clematis	Clematis occidentalis
Northern grass of Parnassus	Parnassia palustris
Mountain Goldenrod	Solidago decumbens
Narrow-leaved reedgrass	Calamagrostis stricta
Downy oat-grass	Trisetum spicatum
Pale Indian paintbrush	Castilleja septentrionalis
Butterwort	Pinguicula vulgaris
Pearlwort	Sagina nodosa
calypso orchid	Calypsa bulbosa
Lake Huron Tansy	Tanacetum huronense
Redroot	Lachnanthes caroliana
Heart-leaved Plantain	Plantago cordata

Table 1: Rare Plant Species on Lake Superior’s cobble shoreline

Lake Michigan and Lake Huron’s cobble shorelines are home to Houghton’s Goldenrod and the Dwarf Lake Iris, both of which are endemic to the Great Lakes shoreline (Table 2, Table 3). Some other rare species on the Lake Michigan shoreline include the Lake Huron Tansy and Beauty Sedge (Table 2).

<b>Lake Michigan</b>	
<b>Common Name</b>	<b>Scientific Name</b>
Dwarf Lake Iris	Iris lacustris
Houghton's Goldenrod	Solidago houghtonii
Slender Cliff-brake	Cryptogramma stelleri
Lake Huron Tansy	Tanacetum huronense
Beauty Sedge	Carex concinna
Richardson's Sedge	Carex richardsonii

Table 2: Rare Plant Species along Lake Michigan’s cobble shoreline

<b>Lake Huron</b>	
<b>Common Name</b>	<b>Scientific Name</b>
Dwarf Lake Iris	Iris lacustris
Houghton's Goldenrod	Solidago houghtonii

Table 3: Rare Plant Species along Lake Huron’s cobble shoreline

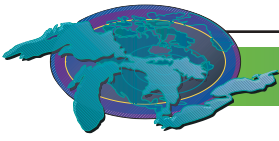
Not many studies have been done on the cobble shorelines of Lake Ontario and Lake Erie because these areas are so small. Therefore, no information was found on the vegetation that grows there.

**Pressure on the Ecosystem**

Cobble beaches are most frequently threatened and lost by shoreline development. Homes built along the shorelines of the Great Lakes cause the number of cobble beaches to become limited. Also, along with the development of homes comes increased human activity along the shoreline resulting in damage to the rare plants in the surrounding area and ultimately, a loss of terrestrial biodiversity on the beaches.

**Future Work Necessary**

Not much research has been done on cobble beach communities; therefore, no baseline data has been set. A closer look into the percentage of cobble beaches that already have homes on them or are plotted for development would yield a more accurate direction in which the beaches are headed. Also, a look at the percentage of these beaches that are in protected areas would help. Projects similar to Dennis Albert’s *Bedrock Shoreline Surveys of the Keweenaw Peninsula and Drummond Island in Michigan’s Upper Peninsula* (1994) for the Michigan Natural Features Inventory as well as the International Joint Commission’s, *Classification of Shore Units Coastal Working Group. Lake Ontario and Upper St. Lawrence River* (2002) would be very useful in determining where exactly the



remaining cobble beaches are located as well as what is growing and living within them.

### Acknowledgments

Author: Jacqueline Adams, Environmental Careers Organization, on appointment to U.S. Environmental Protection Agency, Great Lakes National Program Office.

### Sources

Albert, Dennis, Patrick Comer, David Cuthrell, Michael Penskar, Mary Rabe and Carol Reschke 1994. Bedrock Shoreline Surveys of the Keweenaw Peninsula and Drummond Island in Michigan's Upper Peninsula. Michigan Natural Features Inventory, Lansing, MI.

Albert, Dennis A., Patrick J. Comer, Richard A. Corner, David Cuthrell, Michael Penskar, and Mary Rabe 1995. Bedrock Shoreline Survey of the Niagaran Escarpment in Michigan's Upper Peninsula: Mackinac County to Delta County. Michigan Natural Features Inventory, Lansing, MI.

Albert, Dennis 1994. Regional Landscape Ecosystems of Michigan, Minnesota, and Wisconsin: A Working Map and Classification. Michigan Natural Features Inventory, Lansing, MI.

Environment Canada 1994. Environmental Sensitivity Atlas for Lake Erie (including the Welland Canal) and the Niagara River Shorelines. Environment Canada, Ontario, Canada and United States Coast Guard, United States National Oceanic and Atmospheric Administration.

Environment Canada 1994. Environmental Sensitivity Atlas for Lake Huron's Canadian Shoreline (including Georgian Bay). Environment Canada, Ontario, Canada.

Humphrys, C. R., R. N. Horner and J.H. Rogers 1958. Shoretype Bulletin Nos. 1-29. Michigan State University Department of Resource Development, East Lansing, MI.

Lake Superior Binational Program 2000. Lake Superior Lakewide Management Plan (LaMP) 2000.

Stewart, Christian J. 2003. A Revised Geomorphic, Shore Protection and Nearshore Classification of the Canadian and United States Shorelines of Lake Ontario and the St. Lawrence River. Christian J. Stewart Consulting, British Columbia, Canada.

International Joint Commission 2002. Classification of Shore Units. Coastal Working Group. Lake Ontario and Upper St. Lawrence River.

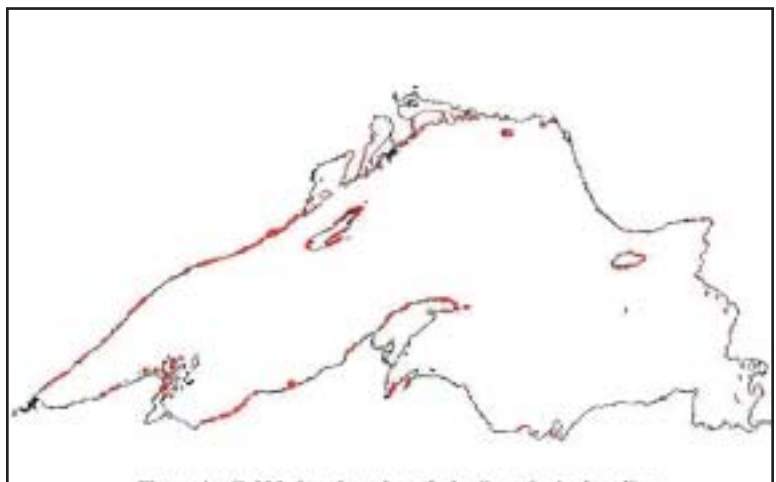


Figure 1. Cobble beaches along Lake Superior's shoreline

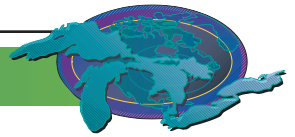


Figure 2. Cobble beaches along Lake Huron's shoreline

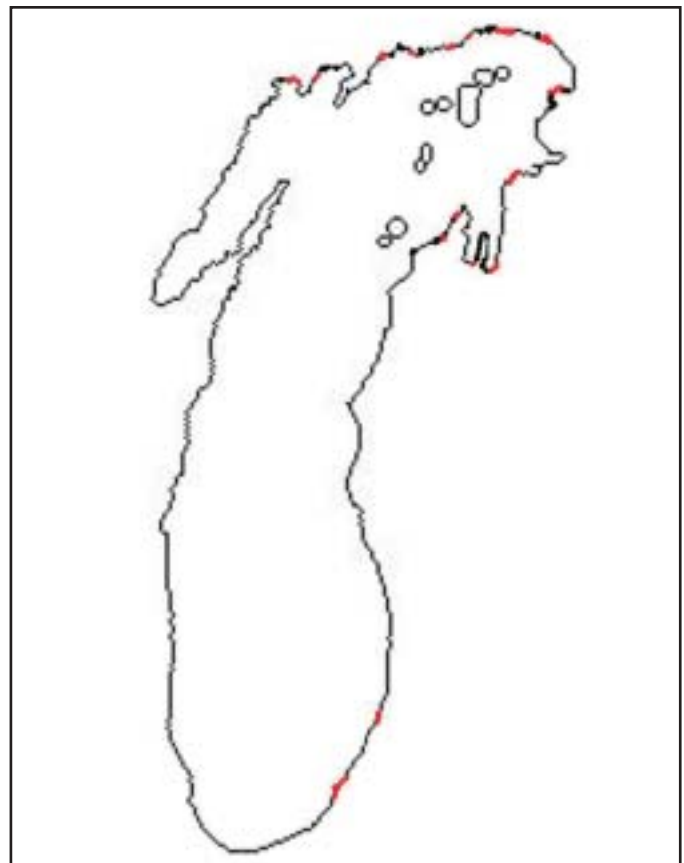


Figure 3. Cobble beaches along Lake Michigan's shoreline

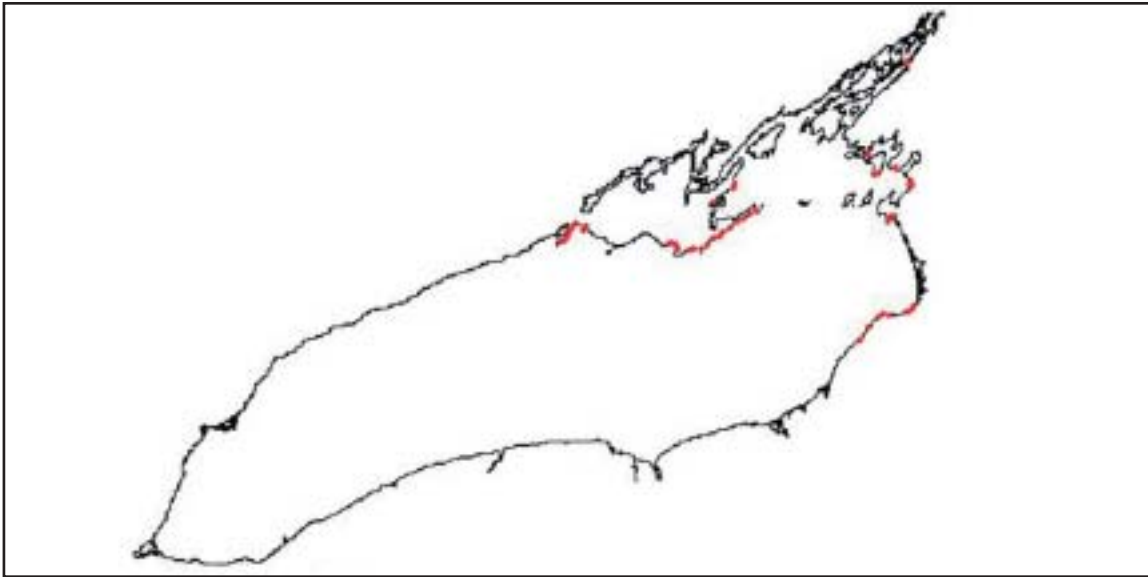
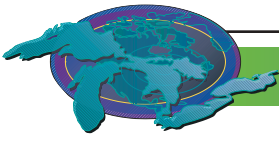


Figure 4. Cobble beaches along Lake Ontario's shoreline

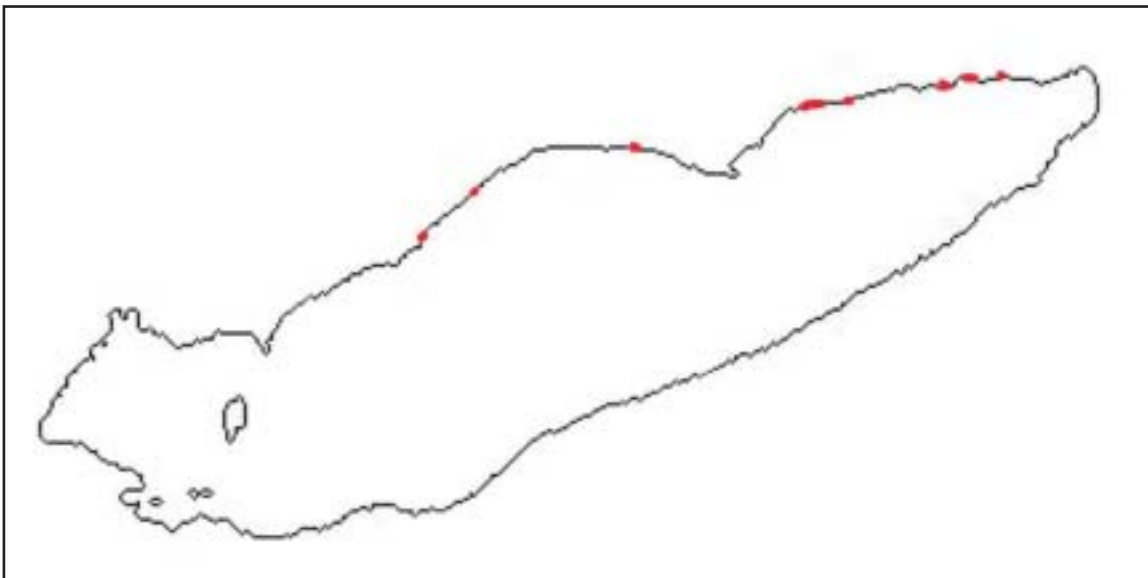
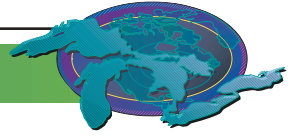


Figure 5. Cobble beaches along Lake Erie's shoreline





## Extent of Hardened Shoreline

SOLEC Indicator #8131

*This indicator report is from 2000.*

### Assessment: Mixed Deteriorating

#### Purpose

This indicator assesses the extent of hardened shoreline through construction of sheet piling, rip rap, or other erosion control structures.

#### Ecosystem Objective

Shoreline conditions should be healthy to support aquatic and terrestrial plant and animal life, including the rarest species. Anthropogenic hardening of the shorelines not only directly destroys natural features and biological communities, it also has a more subtle but still devastating impact. Many of the biological communities along the Great Lakes are dependent upon the transport of shoreline sediment by lake currents. Altering the transport of sediment disrupts the balance of accretion and erosion of materials carried along the shoreline by wave action and lake currents. The resulting loss of sediment replenishment can intensify the effects of erosion, causing ecological and economic impacts. Erosion of sand spits and other barriers allows increased exposure and loss of coastal wetlands. Dune formations can be lost or reduced due to lack of adequate nourishment of new sand to replace sand that is carried away. Increased erosion also causes property damage to shoreline properties.

#### State of the Ecosystem

The National Oceanic and Atmospheric Administration (NOAA) Medium Resolution digital Shorelines dataset was compiled between 1988 and 1992. It contains data on both the Canadian and U.S. shorelines, using aerial photography from 1979 for the state of Michigan and from 1987-1989 for the rest of the basin.

From this dataset, shoreline hardening has been categorized for each Lake and connecting channel. Figure 1 indicates the percentages of shorelines in each of these categories. The St. Clair, Detroit, and Niagara Rivers have a higher percentage of their shorelines hardened than anywhere else in the basin.

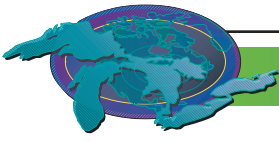
Of the Lakes themselves, Lake Erie has the highest percentage of its shoreline hardened, and lakes Huron and Superior have the lowest. In 1999, Environment Canada assessed change in the extent of shoreline hardening along about 22 kilometers of the Canadian side of the St. Clair River from 1991-1992 to 1999. Over the 8-year period, an additional 5.5 kilometers (32 percent) of the shoreline had been hardened. This is clearly not representative of the overall basin, as the St. Clair River is a narrow shipping channel with high volumes of Great Lakes traffic. This area also has experienced significant development along its shorelines, and many property owners are hardening the shoreline to reduce the impacts of erosion.

#### Future Pressures on the Ecosystem

Shoreline hardening is not generally reversible, so once a section of shoreline has been hardened, it can be considered a permanent feature. As such, the current state of shoreline hardening likely represents the best condition that can be expected in the future. Pressure will continue to harden additional stretches of shoreline, especially during periods of high lake levels. This additional hardening in turn will starve the downcurrent areas of sediment to replenish that which eroded away, causing further erosion and further incentive for additional hardening. Thus, a cycle of shoreline hardening can progress along the shoreline. The future pressures on the ecosystem resulting from existing hardening will almost certainly continue, and additional hardening is likely in the future. The uncertainty is whether the rate can be reduced and ultimately halted. In addition to the economic costs, the ecological costs are of concern, particularly the % further lost or degradation of coastal wetlands and sand dunes.

#### Future Actions

Shoreline hardening can be controversial, even litigious, when one property owner hardens a stretch of shoreline that may increase erosion of an adjacent property. The ecological impacts are not only difficult to quantify as a monetary equivalent, but difficult to perceive without an understanding of sediment transport along the lakeshores. The importance of the ecological process of sediment transport needs to be better understood as an incentive to reduce new shoreline hardening. An educated public is critical to ensuring



wise decisions about the stewardship of the Great Lakes basin ecosystem, and better platforms for getting understandable information to the public is needed.

**Further Work Necessary**

It is possible that more recent aerial photography of the shoreline will be interpreted to show more recently hardened shorelines. Once more recent data provides information on hardened areas, updates may only be necessary basinwide every 10 years, with monitoring of high-risk areas every 5 years.

**Acknowledgments**

Authors: John Schneider, USEPA Great Lakes National Program Office, Chicago, IL, Duane Heaton, USEPA Great Lakes National Program Office, Chicago, IL, and Harold Leadlay, Environment Canada, Environmental Emergencies Section, Downsview, ON.

**Sources**

Great Lakes Electronic Environmental Sensitivity Atlas, Environment Canada-Environmental Protection Branch, Ontario Region. National Oceanic and Atmospheric Administration. Medium Resolution Digital Shoreline. 1988-1992. The National Geophysical Data Center.

Lake/ Connecting Channel	70-100% Hardened	40-70% Hardened	15-40% Hardened	0-15% Hardened	Non-structural Modifications	Unclassified	Total Shoreline (km)
Lake Superior	3.1	1.1	3.0	89.4	0.03	3.4	5,080
St. Marys River	2.9	1.6	7.5	81.3	1.6	5.1	707
Lake Huron	1.5	1.0	4.5	91.6	1.1	0.3	6,366
Lake Michigan	8.6	2.9	30.3	57.5	0.1	0.5	2,713
St. Clair River	69.3	24.9	2.1	3.6	0.0	0.0	100
Lake St. Clair	11.3	25.8	11.8	50.7	0.2	0.1	629
Detroit River	47.2	22.6	8.0	22.2	0.0	0.0	244
Lake Erie	20.4	11.3	16.9	49.1	1.9	0.4	1,608
Niagara River	44.3	8.8	16.7	29.3	0.0	0.9	184
Lake Ontario	10.2	6.3	18.6	57.2	0.0	7.7	1,772
St. Lawrence Seaway	12.6	9.3	17.2	54.7	0.0	6.2	2,571
All 5 Lakes	5.7	2.8	10.6	78.3	0.6	2.0	17,539
All Connecting Channels	15.4	11.5	14.0	54.4	0.3	4.4	4,436
Entire Basin	7.6	4.6	11.3	73.5	0.5	2.5	21,974

Table 1. Percentages of shorelines in each category of hardened shoreline. The St. Clair, Detroit and Niagara Rivers have a higher percentage of their shorelines hardened than anywhere else in the basin. Lake Erie has the highest percentage of its shoreline hardened, and Lakes Huron and Superior have the lowest. Source: National Oceanic and Atmospheric Administration

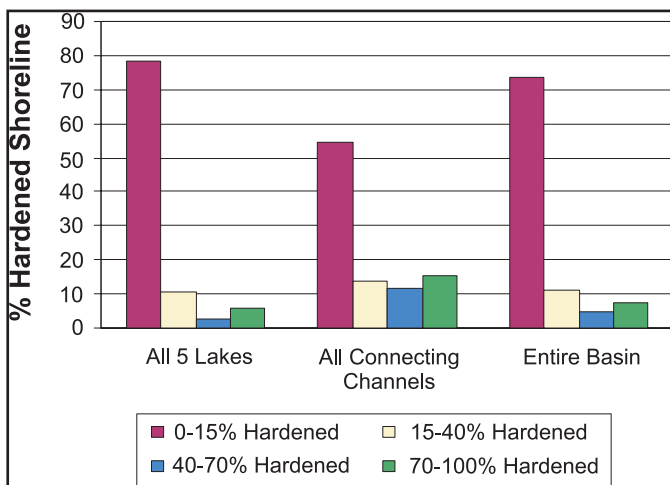


Figure 1. Shoreline hardening in the Great Lakes compiled from 1979 data for the state of Michigan and 1987-1989 data for the rest of the basin. Source: Environment Canada and National Oceanic Atmospheric Administration

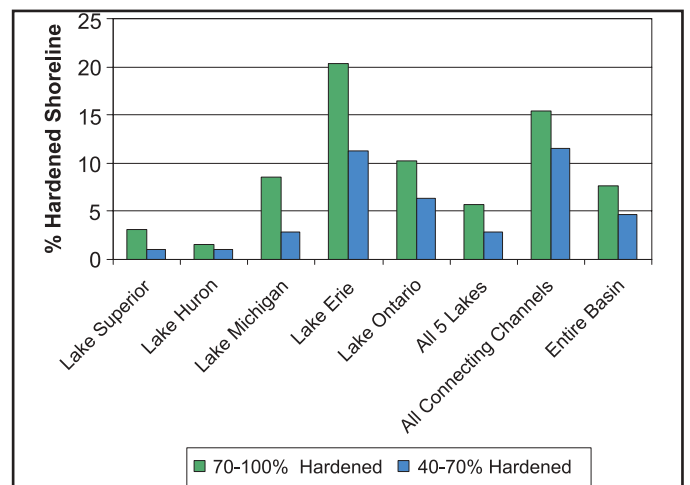
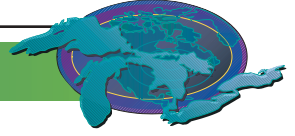


Figure 2. Shoreline hardening by lake compiled from 1979 data for the state of Michigan and 1987-1989 data for the rest of the basin. Source: Environment Canada and National Oceanic Atmospheric Administration



## Contaminants Affecting Productivity of Bald Eagles

SOLEC Indicator #8135

**Assessment:** Mixed, Improving

### Purpose

This indicator assesses the number of territorial pairs, success rate of nesting attempts, and number of fledged young per territorial pair as well as the number of developmental deformities in young. The concentrations of persistent organic pollutants and selected heavy metals are also determined in unhatched bald eagle eggs, and in nestling blood and feathers. Data will be used to infer the potential for harm to other wildlife caused by eating contaminated prey items. As the top avian predator in the nearshore and tributary areas of the Great Lakes, the Bald Eagle integrates contaminant stresses, food availability, and the availability of relatively undeveloped habitat areas over most portions of the Great Lakes shoreline. It serves as an indicator of both habitat quantity and quality.

### Ecosystem Objectives

This indicator supports annexes 2, 12, and 17 of the Great Lakes Water Quality Agreement.

### State of the Ecosystem

Concentrations of organochlorine chemicals are decreasing or stable but still above No Observable Adverse Effect Concentrations (NOAECs) for the primary organic contaminants, DDE and PCBs. Bald eagles are now distributed extensively along the shoreline of the Great Lakes (Figure 1). The number of active bald eagle territories has increased markedly from the depths of the population decline caused by DDE (Figure 2). Similarly, the percentage of nests producing one or more fledglings (Figure 3) and the number of young produced per territory (Figure 4) have risen. The recovery of reproductive output at the population level has followed similar patterns in each of the Lakes, but the timing has differed between the various Lakes. Lake Superior recovered first, followed by Erie and Huron, and most recently, Lake Michigan. An active territory has been reported from Lake Ontario. Established territories in most areas are now producing one or more young per territory indicating that the population is healthy and capable of growing. Eleven developmental deformities have been reported in bald eagles within the Great Lakes watershed; five of these were from territories potentially influenced by the Great Lakes.

### Future Pressures

High levels of persistent contaminants in bald eagles continue to be a concern for two reasons. Eagles are relatively rare and contaminant effects on individuals can be important to the well-being of local populations. In addition, relatively large habitat units are necessary to support eagles and continued development pressures along the shorelines of the Great Lakes constitute a concern. The interactions of contaminant pressures and habitat limitations are unknown at present. There are still several large portions of the Great Lakes shoreline, particularly around Lake Ontario, where the bald eagle has not recovered to its pre-DDE status despite what appears to be adequate habitat in many areas.

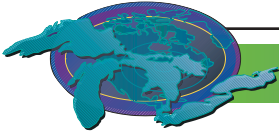
### Management Implications

The data on reproductive rates in the shoreline populations of Great Lakes Bald Eagles implies that widespread effects of persistent organic pollutants have decreased. However, there are still gaps in this pattern of reproductive recovery that should be explored and appropriate corrective actions taken. In addition, information on the genetic structure of these shoreline populations is still lacking; it is possible that further monitoring will reveal that these populations are being maintained from surplus production from inland sources rather than from the productivity of the shoreline birds themselves. Continued expansion of these populations into previously unoccupied areas is encouraging and might indicate several things; there is still suitably undeveloped habitat available, or, Bald Eagles are adapting to increasing alteration of the available habitat.

### Acknowledgements

Authors: Ken Stromborg and David Best, U.S. Fish & Wildlife Service, Pamela Martin, Canadian Wildlife Service, and William Bowerman, Clemson University.

Additional Data were contributed by: Ted Armstrong, Ontario Ministry of Natural Resources; Lowell Tesky, Wisconsin Department of Natural Resources; Cheryl Dykstra, Cleves, OH; Peter Nye, New York Department of Environmental Conservation; Michael Hoff,



U.S. Fish and Wildlife Service. John Netto, U.S. Fish & Wildlife Service assisted with computer support.

**Future Work Necessary**

Monitoring the health and contaminant status of Great Lakes bald eagles should continue across the Great Lakes basin. Even though the worst effects of persistent bioaccumulative pollutants seem to have passed, the Bald Eagle is a prominent indicator species that integrates effects that operate at a variety of levels within the ecosystem. Symbols such as the Bald Eagle are valuable for communicating with the public. Many agencies continue to accomplish the work of reproductive monitoring that results in compatible data for basinwide assessment. However, the Wisconsin DNR Ohio DNR and Ontario MNR programs are diminished as the result of budgetary constraints, while Michigan DEQ and New York DEC programs will continue for the near future. In the very near future, when the Bald Eagle is removed from the list of threatened species in the United States, existing monitoring efforts may be severely curtailed. Without the required field monitoring data, overall assessments of indicators like the Bald Eagle will be impossible. Part of the problem with a lessened emphasis on wildlife monitoring by governmental agencies is the failure of initiatives such as SOLEC to identify and designate programs that are essential in order to ensure that data continuity is maintained Two particular needs for additional data also exist. There is no basinwide effort directed toward assessing habitat suitability of shoreline areas for bald eagles. Further, it is not known to what degree the shoreline populations depend on recruiting surplus young from healthy inland populations to maintain the current rate of expansion or whether shoreline populations are self-sustaining.

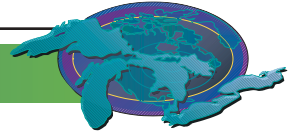


Figure 1. Approximate nesting locations of bald eagles along the Great Lakes shorelines, 2000. Source: W. Bowerman, Clemson University, Lake Superior LaMsP, and for Lake Ontario, Peter Nye, and N.Y. Department of Environmental Conservation

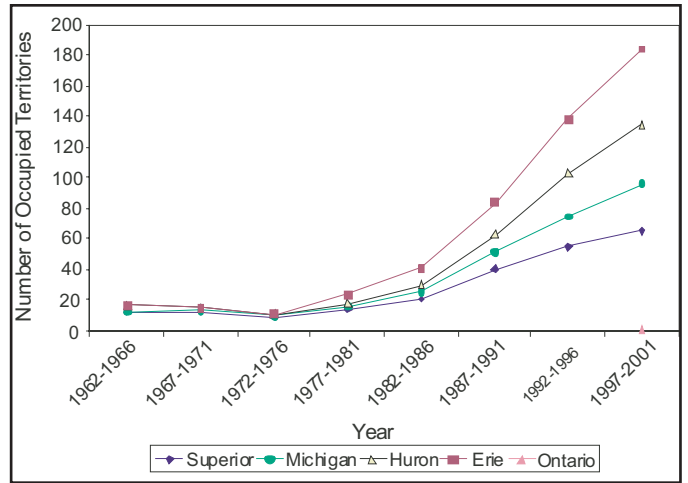


Figure 2. Average number of occupied territories per year by lake. Source: David Best, U.S. Fish and Wildlife Service; Pamela Martin, Canadian Wildlife Service; and Michael Meyer, Wisconsin Department of Natural Resources

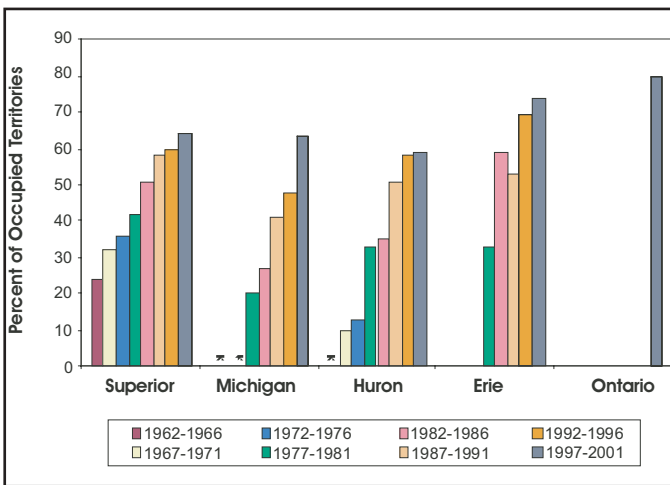


Figure 3. Average percentage of occupied territories fledging at least one young. Source: David Best, U.S. Fish and Wildlife Service; Pamela Martin, Canadian Wildlife Service; and Michael Meyer, Wisconsin Department of Natural Resources

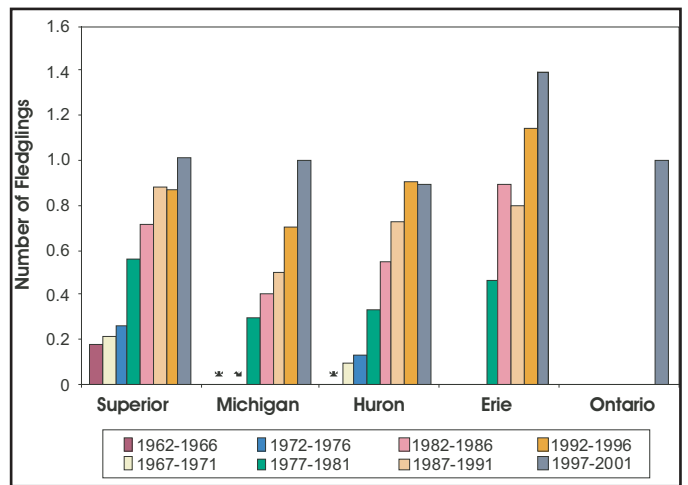
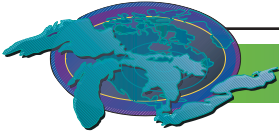


Figure 4. Average number of young fledged per occupied territory per year. Source: David Best, U.S. Fish and Wildlife Service; Pamela Martin, Canadian Wildlife Service; and Michael Meyer, Wisconsin Department of Natural Resources



## Population Monitoring and Contaminants Affecting the American Otter

SOLEC Indicator #8147

*This indicator report is from 2002.*

### Assessment: Mixed

Data are not system-wide. Data are from multiple sources.

### Purpose

To directly measure the contaminant concentrations found in American otter populations within the Great Lakes basin and to indirectly measure the health of Great Lakes habitat, progress in Great Lakes ecosystem management, and/or concentrations of contaminants present in the Great Lakes. Importantly, as a society we have a moral responsibility to sustain healthy populations of American otter in the Great Lakes/St. Lawrence basin.

### Ecosystem Objective

The importance of the American otter as a biosentinel is related to IJC Desired Outcomes 6: Biological Community Integrity and Diversity, and 7: Virtual Elimination of Inputs of Persistent Toxic Chemicals. Secondly, American otter populations in the upper Great Lakes should be maintained, and restored as sustainable populations in all Great Lakes coastal zones, lower Lake Michigan, western Lake Ontario, and Lake Erie watersheds and shorelines. Lastly, Great Lakes shoreline and watershed populations of American otter should have an annual mean production of  $>2$  young/adult female; and concentrations of heavy metal and organic contaminants should be less than the NOAEL found in tissue sample from mink as compared to otter tissue samples.

### State of the Ecosystem

In a review of State and Provincial otter population data indicates primary areas of population suppression still exist in southern Lake Huron watersheds, lower Lake Michigan and most Lake Erie watersheds. Data provided from New York Department of Environmental Conservation and Ontario Ministry of Natural Resources suggests that otter are almost absent in western Lake Ontario (Figure 1). Most coastal shoreline areas have more suppressed populations than interior zones.

Areas of otter population suppression are directly related with human population centers and subsequent habitat loss, and elevated contaminant concentrations associated with human activity. Little statistically viable population data exists for the Great Lakes populations, and all suggested population levels illustrated were determined from coarse population assessment methods.

### Future Pressures

American otters are a direct link to organic and heavy metal concentrations in the food chain. It is a more sedentary species and subsequently synthesizes contaminants from smaller areas. Contaminants are a potential and existing problem for many otter populations throughout the Great Lakes. Globally, indications of contaminant problems in otter have been noted by decreased population levels, morphological abnormalities (i.e. decreased baculum length) and decline in fecundity. Changes in the species population and range are also representative of anthropogenic riverine and lacustrine habitat alterations.

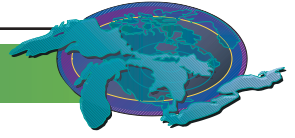
### Future Actions

Michigan and Wisconsin have indicated a need for an independent survey using aerial survey methods to index otter populations in their respective jurisdictions. Minnesota has already started aerial population surveys for otter. Subsequently, some presence absence data may be available for Great Lakes watersheds and coastal populations in the near future. In addition, if the surveys are conducted frequently the trend data may become useful.

There was agreement among resource managers on the merits of aerial survey methods to index otter populations. Although, these methods are only appropriate in areas with adequate snow cover.

New York Department of Environmental Conservation, Ohio Department of Natural Resources, Federal jurisdictions and Tribes on Great Lakes coasts indicated strong needs for future contaminant work on American otter.

Funding, other than from sportsmen is needed by all jurisdictions to do habitat, contaminant and aerial survey work.



### Further Work Necessary

All State and Provincial jurisdictions use different population assessment methods making comparisons difficult. Most jurisdictions use survey methods to determine populations on state or provincial wide scales. Most coarse population assessment methods were developed to assure that trapping was not limiting populations and that otter were simply surviving and reproducing in their jurisdiction. There was little work done on finer spatial scales using otter as an indicator of ecosystem health.

In summary, all State and Provincial jurisdictions only marginally index Great Lakes watershed populations by presence absence surveys, track surveys, observations, trapper surveys, population models, aerial surveys, and trapper registration data.

Michigan has the most useful spatial data that could index the largest extent of Great Lakes coastal populations due to their registration requirements. Michigan registers trapped otter to an accuracy of 1 square mile. However, other population measures of otter health such as reproductive rates, age and morphological measures are not tied to spatial data in any jurisdiction, but are pooled together for entire jurisdictions. If carcasses are collected for necropsy, the samples are usually too small to accurately define health of Great Lakes coastal otter verses interior populations. Subsequently, there is a large need to encourage and fund resource management agencies to streamline data for targeted population and contaminant research on Great Lakes otter populations, especially in coastal zones.

### Acknowledgments

Thomas C.J. Doolittle, Bad River Band of Lake Superior Tribe of Chippewa Indians, Odanah, WI.

### Sources

Bishop, P., R. Gotie, B. Penrod, and L. Wedge. 1999. Current status of river otter management in New York. New York State Department of Environmental Conservation, Otter management team, Delmar, New York. 9pp.

Bluett, R.D., E. A. Anderson, G.F. Hubert, G.W. Kruse and S.E. Lauzon. 1999. Reintroduction and status of the river otter (*Lutra canadensis*) in Illinois. Transactions of the Illinois State Academy of Science. Vol. 92 1 and 2. pp. 69-78.

Bluett, R.D. 2000. Personal Communication. Illinois Department of Natural Resources. Springfield, IL

Brunström, B., B. Lund, A. Bergman, L. Asplund, I. Athanassiadis, M. Athanasiadou, S. Jensen, and J. Örberg. 2001. Reproductive toxicity in mink (*Mustela vison*) chronically exposed to environmentally relevant polychlorinated biphenyl concentrations. *Environmental Toxicology & Chemistry* 20: 2318-2327.

Dawson, N. 2000. Personal Communication. Ontario Ministry of Natural Resources, Northwest Region. Thunder Bay, ON

Doolittle, T.C.J. 1998. Tribal Ecological Assessment of the County A Sludge Site-Phase 1 (unpublished). Bad River Reservation, Odanah, Wisconsin. 35 pp.

Dwyer, C.P. 2000. Population assessment and distribution of river otters following their reintroduction into Ohio. Crane Creek Wildlife Experiment Station, Ohio Division of Wildlife, Oak Harbor, OH. 5pp.

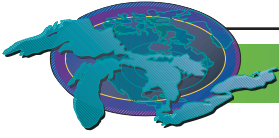
Dwyer, C.P. 2000. Personal Communication. Ohio Division of Wildlife, Oak Harbor, OH

Foley, F.E., S.J. Jackling, R.J. Sloan and M.K. Brown. 1988. Organochlorine and mercury residues in wild mink and otter: comparison with fish. *Environmental Toxicology and Chemistry*, Vol. 7. 363-374.

Friedrich, P.D. 2000. Personal Communication. Michigan Department of Natural Resources. East Lansing, MI

Halbrook, R.S., J.H. Jenkins, P.B. Bush and N.D. Seabolt. 1981. Selected environmental contaminants in rivers otters (*Lutra canadensis*) of Georgia and their relationship to the possible decline of otters in North America. In J.A.

Chapman and D. Pursley, eds. Worldwide furbearers Conference Proceedings, Worldwide Furbearer Conference, Inc. Frostburg, MD,



pp.1752-1762.

Hammill, J. 2000. Personal Communication. Michigan Department of Natural Resources. Crystal Falls, MI

Henny, C.J., L.J. Blus, S.V. Gregory and C.J. Stafford. 1981. PCBs and organochlorine pesticides in wild mink and river otters from Oregon. In J.A.

Chapman and D. Pursley, eds. Worldwide furbearers Conference Proceedings, Worldwide Furbearer Conference, Inc. Frostburg, MD, pp. 1763-1780.

Hochstein, J., S. Bursian and R. Aulerich. 1998. Effects of dietary exposure to 2,3,7,8-tetrachlorodibenzo-p-dioxin in adult female mink (*Mustela vison*). *Archives of Environmental Contamination & Toxicology* 35: 348-353.

Johnson, S. 2000. Personal Communication. Indiana Department of Natural Resources. Bloomington, Indiana

Johnson, S.A. and R.F. Madej. 1994. Reintroduction of the river otter in Indiana – a feasibility study. Indiana Department of Natural Resources. Bloomington, Indiana. 30 pp.

Johnson, S.A. and K.A. Berkley. 1999. Restoring river otters in Indiana. *Wildlife Society Bull.* 27(2): 419-427.

Kannan, K., A. Blankenship, P. Jones, and J. Giesy. 2000. Toxicity reference values for the toxic effects of polychlorinated biphenyls to aquatic mammals. *Human Ecological Risk Assessment* 6: 181-201.

Kautz, M. 2000. Personal Communication. New York Department of Environmental Conservation, Delmar, New York

Leonards, P., T. de Vries, W. Minnaard, S. Stuijzand, P. de Voogt, W. Cofino, N. van Straalen and B. van Hattum. 1995. Assessment of experimental data on PCB induced reproduction inhibition in mink, based on an isomer- and congenerspecific approach using 2,3,7,8-tetrachlorodibenzo-p-dioxin toxic equivalency. *Environmental Toxicology & Chemistry* 14: 639-652.

Mason, C. and S. Macdonald. 1993. Impact of organochlorine pesticide residues and PCBs on otters (*Lutra lutra*): a study from western Britain. *Science of the Total Environment* 138: 127-145.

Mason, C. 1989. Water pollution and otter distribution: a review. *Lutra* 32: 97-131.

Mayack, D.T. 2000. Personal Communication. New York Department of Environmental Conservation, Gloversville, New York

Michigan Department of Natural Resources. 2000. River otter reproductive and harvest data 1995-1999. East Lansing, MI

Michigan Department of Natural Resources. 2000. Distribution of otter harvest by section 1998-99. East Lansing, MI

New York State Department of Environmental Conservation. 1998-99. Furbearer harvest by county and region. Albany, New York

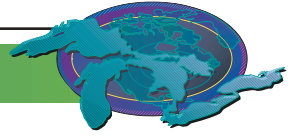
Ohio Division of Wildlife. 1999-2000. Watersheds with river otter observations. Oak harbor, OH

Olson, J. 2000. Personal Communication. Furbearer Specialist, Wisconsin Department of Natural Resources, Park Falls, WI

Ontario Ministry of Natural Resources. 2000. Ontario furbearer population ranks through trapper questionnaires by Wildlife Assessment Unit. Thunder Bay, ON

Roos, A., E. Greyerz, M. Olsson, and F. Sandegren. 2001. The otter (*Lutra lutra*) in Sweden? Population trends in relation to 3DDT and total PCB concentrations during 1968-99. *Environmental Pollution* 111: 457-469.





Route, W.T. and R.O. Peterson. 1988. Distribution and abundance of river otter in Voyageurs National Park, Minnesota. National Park Service, Resource Management Report MWR-10, Omaha, NE. 62pp.

Sheffy, T.B. and J.R. St. Amant. 1982. Mercury burdens in furbearers in Wisconsin. *J. Wildlife Manage.* 46:1117-1120.

Wisconsin Department of Natural Resources. 1979-1998. Summary of otter reproductive information. Madison, WI

Wisconsin Department of Natural Resources. 2000. Otter population model statewide 1982-2005. Madison, WI

Wisconsin Department of Natural Resources. 2000. Distribution of otter harvest by management unit 1998-99. Madison, WI

Wren, C. 1991. Cause-effect linkages between chemicals and populations of mink (*Mustela vison*) and otter (*Lutra canadensis*) in the Great Lakes basin. *J Toxicol Environ Health* 33: 549-585.

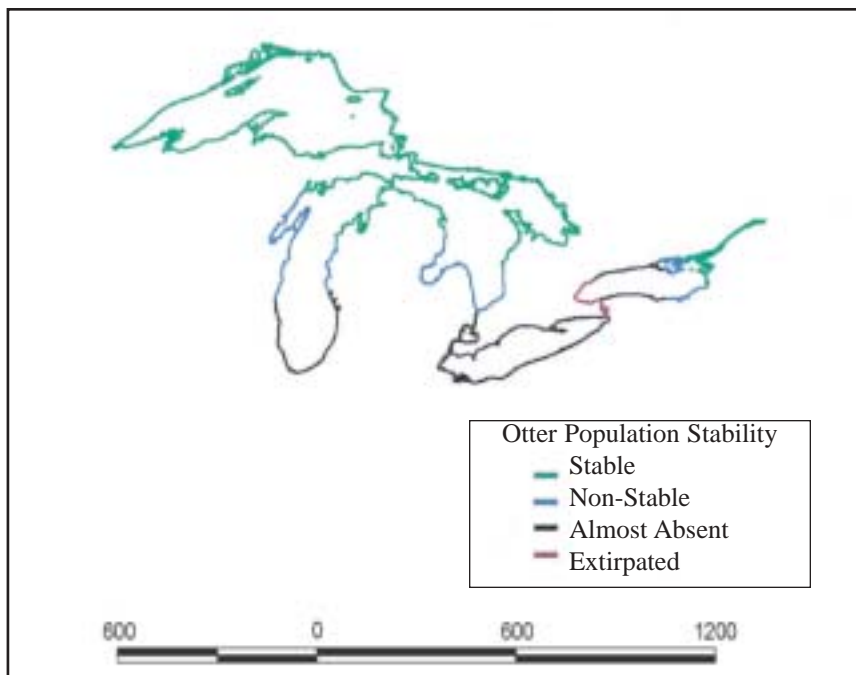
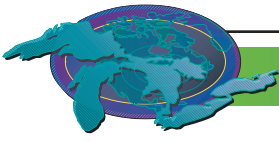


Figure 1. Great Lakes shoreline population stability estimates for the American Otter. Source: Thomas C.J. Doolittle, Bad River Band of Lake Superior Tribe of Chippewa Indians



## Forest Lands - Conservation of Biological Diversity

SOLEC Indicator #8500

Forest Criterion No. 1: Related Indicators:

Extent of area by forest type relative to total forest area

Extent of area by forest type and by age-class or successional stage

Extent of area by forest type in protected area categories as defined by IUCN or other classification systems

**Assessment: Mixed, Improving**

### Purpose

Criterion 1 indicators describe the extent, composition and structure of Great Lakes basin forests. They address the capacity of forests to perform the hydrologic functions, and host the organisms and essential processes, that are essential to supplying high quality water and protecting the physical integrity of the watershed.

### Ecosystem Objective

Indicator (1) summarizes total forest area and area by forest type. The extent and diversity of forest cover are positive indicators of basin health. Water draining forested watersheds is of high quality, as measured by sediment yields, nutrient loadings, contaminant concentrations and temperatures. Forests also control soil erosion, increase groundwater infiltration, stabilize shorelines and regulate storm run-off. Leaf litter and woody debris provide critical food and habitat for fish and other aquatic wildlife.

Indicator (2) summarizes the structure of forest based on age class. Many ecological processes and wildlife species are associated with vegetative structures (age, diameter and height of vegetation) and successional stages (variable species of vegetation).

Indicator (3) summarizes the extent of forest by type in a protected area category. Protected status ensures that specified tracts of land remain under forest cover, and is indicative of the value a society and its policymakers place on forest conservation.

### State of the Ecosystem

Indicator (1): Forests cover 27.8 million hectares, or about half (51%), of the land in the Great Lakes basin. The U.S. side of the basin contains 14.8 million hectares of forests (47% of the U.S. basin), while the Canadian side contains 13.0 million hectares (57% of the Canadian basin).

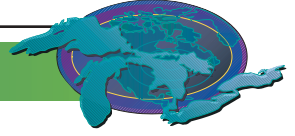
Maple-beech-birch is the most extensive forest type, representing 7.6 million hectares, or 27% of total forest area in the basin. Aspen-birch forests constitute the second-largest forest type, covering 6.5 million hectares, or 23% of the total. Other major types include spruce-fir forests (5.0 million hectares, or 18% of total forest area) and white-red-jack pine forests (2.7 million hectares, or 10% of total forest area.) Complete data are available in Table 1.1

Implications for the health of Great Lakes forests and the basin ecosystem are difficult to establish. On a positive note, total forest area appears to have increased across the Great Lakes basin in recent decades (see Table 1.2). Expanding forest area is associated with positive impacts on water quality and quantity. Due to changes in data definitions, however, it is difficult to determine whether the growth in forest area is occurring in riparian zones, where the impact on water quality is the greatest.

Moreover, there is no consensus on how much land in the basin should be forested, much less on how much land should be covered by each forest type. Comparisons to historical forest cover, although of limited utility in developing landscape goals, can illustrate the range of variation experienced within the basin since the time of European settlement (see insert).

Indicator (2): Basin-wide, the 41-60 and 61-80 year age-classes are dominant and together represent 53% of total forest area. Forests under 40 years of age make up a further 23%, while those in the 100+ year age-classes constitute 9% of total forest area. Table 2.1 contains complete data on age-class distribution by area within each forest type.

Because forests are dynamic and different tree species have different growth patterns, age distribution varies by forest type. Aspen-



birch and white-red-jack pine forests tend to be younger, being more concentrated in the 21-40 and 41-60 year age classes, while maple-beech-birch forests are heavily concentrated in the 61-80 year age class. Spruce-fir forests contain significant old growth, with 21% by area in the 100+ year age classes, more than twice the overall level (9%) within those age classes.

The age-class distribution of U.S. basin forests mirrors the overall trend, but with a higher concentration in the 41-60 and 61-80 year age classes, which contain 58% of total forest area on the U.S. side. Canadian Great Lakes forests have a distribution balanced towards older age classes, with 17% by area in the 100+ year age classes, compared to 3% in the U.S. basin. Also, a wider range of forest types is represented in Canadian old growth forests. At the same time, Canadian basin forests contain a substantially higher area of non-stocked forests (timber land less than 10% stocked with live trees) that by definition lies almost exclusively in the 0-20 year age class. Canadian basin forests also have a relatively small area in the 21-40 year age class.

What this means for forest and basin health is not clear. Age-class data can serve as a coarse surrogate for the vegetative structure (height and diameter) of a forest, and can be combined with data from other indicators to provide insight on forest sustainability.

Data on the extent of forest area by successional stage are not available. Although certain tree species are associated with the various successional stages, a standard and quantifiable protocol for identifying successional stage has not yet been developed. It is expected, however, that in the absence of disturbance, the area covered by early-successional forest types, such as aspen-birch, is likely to decline as forests convert to late-successional types, such as maple-beech-birch.

Indicator (3): In the U.S. basin, 3.5% of forested land, comprising 517,000 hectares, is in a protected area category. Among major forest types, 5.4% of maple-beech-birch (308,000 hectares), 2.7% of aspen-birch (73,000 hectares), 4.4% of spruce-fir (79,000 hectares) and 0.6% of white-red-jack pine forests (7,000 hectares) are considered to have protected status. The “other softwoods” category has the highest protection rate, with 7.7%, or 12,000 of its 157,000 hectares, protected from harvest.

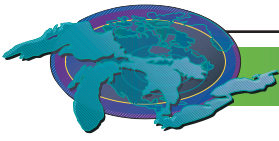
On the Canadian side, 10.8% of forest area, or 1.4 million hectares, are protected. Protection rates range from 9.2% for maple-beech-birch (172,000 hectares) and 10.7% for spruce-fir forests (340,000 hectares), to 12.7% for white-red-jack pine (191,000 hectares) and 13.0% for aspen-birch forests (490,000 hectares). The oak-pine category has the highest protection rate, with 22.5%, or 20,000 of its 90,000 hectares, under protected status. See complete data in Table 3.1.

Implications for forest and basin health are again difficult to establish. On one hand, the extent of forest area with protected status appears to have increased in recent decades (see Table 3.2). Particularly large increases in protected forest area in Ontario, New York and Minnesota more than offset reported declines in Michigan and Wisconsin. However, due to changes in data definitions, it is difficult to determine whether the expansion or contraction of protected forests is occurring in riparian zones, where the impact on water quality is the greatest.

There is also no consensus on what proportion of forest land should be protected. Nationally, forest protection rates are estimated to be 8.4% in Canada<sup>1</sup> and 14% in the U.S.<sup>2</sup> As for the range of variation in protection rates by forest types, protected areas should be representative of the diversity in forest composition within a larger area. However, defining what constitutes this “larger area” is problematic. Policymakers often have had a different jurisdiction than the Great Lakes basin in mind when deciding where to locate protected areas. Since forests are dynamic, the tree species and forest types found on an individual plot of protected land can change over time due to successional processes.

Differences among the U.S., Canadian, and IUCN (International Union for the Conservation of Nature) definitions of protected areas should also be noted. The IUCN standard contains six categories of protected areas – strict nature reserves/wilderness areas, national parks, natural monuments, habitat/species management areas, protected landscapes/seascapes, and managed resource protection areas. The U.S. defines protected areas as forests “reserved from harvest by law or administrative regulation,” including designated Federal Wilderness areas, National Parks and Lakeshores, and state designated areas.<sup>3</sup> Ontario defines protected areas as national parks, conservation reserves, and its six classes of provincial parks – wilderness, natural environment, waterway, nature reserve, historical and recreational.<sup>4</sup> There is substantial overlap among the U.S., Ontario and IUCN definitions, but a more consistent classification system would ensure proper accounting of protected areas.

Common to the U.S., Ontario and IUCN definitions is that they only include forests in the public domain. However, there are private-



ly-owned forests similarly reserved from harvest by land trusts, conservation easements and other initiatives. Inclusion of these forests under this indicator would provide a more complete definition of protected forest areas.

Moreover, there is debate on how protected status relates to forest sustainability, water quality, and ecosystem health. In many cases, protected status was conferred onto forests for their scenic or recreational value, which may not contribute significantly to conservation or watershed management goals. On the other hand, forests available for harvest, whether controlled by the national forest system, state or local governments, tribal governments, industry or private landowners, can be managed with the stated purpose of conserving forest and basin health.

**Pressures and Management Implications**

Urbanization, seasonal home construction and increased recreational use – driven in part by the desire of an aging and more affluent population to spend time near natural settings – are among the general demands being placed on forest resources nationwide. Stakeholder discussion will be critical in identifying pressures and management implications, particularly those on a localized basis, that are specific to Great Lakes basin forests. These discussions will certainly add to longstanding debates on strategies for sustainable forest management.

- 1 World Wildlife Fund, 1999. Canada’s commitment to forest protected areas: Forests for life. WWF Status Report. World Wildlife Fund Canada. Toronto, ON. 17 p. Cited in Canadian Council of Forest Ministers. 2000. Criteria and Indicators of Sustainable Forest Management in Canada: National Status 2000. p.7
- 2 Guldin, R. W. and Kaiser, H. F. 2004. National Report on Sustainable Forests –2003. U.S.D.A. Forest Service. FS-766. p.88
- 3 Smith, W. B. 2004. United States 2003 Report on Sustainable Forests, Data Report: Criterion 1, Indicators 1, 2, 3, 4, Conservation of Biological Diversity. U.S.D.A. Forest Service. FS-766A. p.24
- 4 Ontario Ministry of Natural Resources. 2002. State of the Forest Report, 2001. Queen’s Printer for Ontario. pp.3-23

**Historical Range of Variation in the Great Lakes Forests of  
Minnesota, Wisconsin and Michigan**

Data on the historic range of variation in extent of total forest area and area by forest type since the time of European settlement are available for Minnesota, Wisconsin and Michigan in a U.S. Geological Survey study.<sup>6</sup> Pre-settlement data were adapted from the General Land Office (GLO) surveys conducted between 1815 and 1866, while modern data were compiled from the USDA Forest Service’s Forest Inventory and Analysis (FIA) database for the period 1977-1983.

Vegetation units in the GLO survey were simplified to allow comparison to the FIA forest type groups. The re-classification was conducted based on dominant tree species, as follows:

<i>GLO Vegetation Unit Group</i>	<i>Major Tree Species</i>	<i>FIA Forest Type</i>
Boreal Forest-Conifer Swamp	White spruce, balsam fir, northern white cedar, swamp conifer forest of black spruce and tamarack	Spruce-fir
Pine Forest-Barrens	White pine, red pine, jack pine	White-red-jack pine
Northern Mesic Forest	Sugar maple, basswood, yellow birch, beech, hemlock, some oaks	Maple-beech-birch
Aspen-Birch	Aspen, paper birch	Aspen-birch
Oak Forest-Savanna	Forest and savanna areas of red oak, black oak, white oak and bur oak	Oak-hickory
Wet Mesic Forest	Lowland forests of American elm, green and black ash, silver maple	Elm-ash-cottonwood

The data presented in the USGS study are statewide for Minnesota, Wisconsin and



Michigan, so the U.S. EPA-GLNPO clipped the data using GIS software to extract information relevant to the portions of each state that lie within the Great Lakes watershed. This exercise revealed that extent of area covered by forest declined by 37% between the mid-19<sup>th</sup> century and 1977-1983, due primarily to the conversion of northern mesic forest (maple-beech-birch) and oak forest (oak-hickory) in southern Wisconsin and Michigan to urban and agricultural use.

By forest type, area covered by pine forests (white-red-jack pine) declined by 81%, northern mesic forests (maple-beech-birch) by 64%, and boreal forests (spruce-fir) by 63% over the same period, although the area covered by aspen-birch forests increased by 212%. The late-19<sup>th</sup> century was marked by extensive logging of pine forests and subsequent conversion to early successional aspen-birch forests. Maps depicting the changes in forest cover can be found on the following page.

However, comparing FIA data from 1977-1983 to the most recent data collected in 2001-2002 indicates that further changes have occurred over the past quarter-century. Total forest area has expanded by 5% over the period, while area covered by white-red-jack pine forests has increased by 18%, and maple-beech-birch forests (northern mesic) by 13%. At the same time, aspen-birch forests have retreated by 3%, and spruce-fir (boreal) forests have declined by 12%. Meanwhile, the area of non-stocked forest land (timber land less than 10% stocked with live trees) has dropped by 9%. These data suggest a maturation and steady recovery over recent decades in the Great Lakes forests of Minnesota, Wisconsin and Michigan, as reflected by the progression of natural successional patterns, replanting of non-forest areas, and regeneration of non-stocked forest lands.

<sup>6</sup> Cole, K., Stearns, F., Guntenspergen, G., Davis, M. and Walker, K. 1998. Historical Landcover Changes in the Great Lakes Region. In Perspectives on the land-use history of North America: a context for understanding our changing environment, ed. Sisk, T.D., Ch. 6. U.S. Geological Survey, Biological Resources Division, Biological Science Report USGS/BRD/BSR 1998-0003.

### Forest Indicator #1. Extent of Forest Type Relative to Total Forest Area

Table 1.1 Forest Area by Forest Type

<i>in hectares</i>	Area of Forest Type	% of Total Forest Area
Maple-Beech-Birch	7,574,099	27.3%
Aspen-Birch	6,460,568	23.3%
Spruce-Fir	4,964,154	17.9%
White-Red-Jack Pine	2,699,360	9.7%
Oak-Hickory	1,838,136	6.6%
Elm-Ash-Cottonwood	1,632,339	5.9%
Spruce-Jack Pine-Aspen	480,402	1.7%
Other Softwoods	182,219	0.7%
Oak-Pine	178,744	0.6%
Other	519,266	1.9%
Non-stocked	1,262,441	4.5%
<b>TOTAL FOREST AREA</b>	<b>27,791,728</b>	
<b>TOTAL LAND AREA IN BASIN</b>	<b>54,757,612</b>	

Area, by State/Province

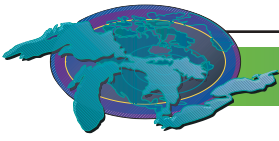
Table 1.2 Expansion in Forest

<i>in hectares</i>	Earliest Available	Most Recent Available	Change	% Change
Illinois	nil (1985)	5,726 (2002)	***	***
Indiana	118,414 (1986)	121,852 (2002)	+3,438	+2.9%
Michigan	7,433,913 (1980)	7,848,153 (2001)	+414,240	+5.6%
Minnesota	1,128,086 (1977)	1,208,050 (2002)	+79,964	+7.1%
New York	2,616,380 (1993)	2,909,938 (2002)	+293,558	+11.2%
Ohio *	N/A	453,741 (1991)	N/A	N/A
Pennsylvania	64,331 (1989)	76,885 (2002)	***	***
Wisconsin	2,053,865 (1983)	2,122,031 (2002)	+68,166	+3.3%
Ontario **	N/A	13,045,401 **	N/A	N/A

\* Ohio data only available for 1991

\*\* Ontario data a mosaic of 1978-2001 data

\*\*\* Illinois and Pennsylvania excluded from calculations due to small sample area



**Forest Indicator #2. Extent of Area by Forest Type and by Age-Class or Successional Stage**

**Combined**

	<b>0-20</b>	<b>21-40</b>	<b>41-60</b>	<b>61-80</b>	<b>81-100</b>	<b>101-120</b>	<b>121-140</b>	<b>141-160</b>	<b>161-200</b>	<b>200+</b>
Maple-Beech-Birch	4.9%	10.2%	25.9%	33.3%	14.6%	4.4%	2.5%	1.7%	0.8%	0.1%
Aspen-Birch	10.5%	14.9%	28.8%	27.8%	13.5%	3.5%	0.8%	0.1%	< 0.1%	0.1%
Spruce-Fir	4.1%	7.2%	21.5%	26.9%	19.4%	9.8%	7.2%	3.3%	0.5%	0.1%
White-Red-Jack Pine	9.9%	16.3%	26.4%	22.6%	15.1%	5.7%	2.4%	0.9%	0.5%	0.2%
Oak-Hickory	7.8%	15.9%	26.6%	27.0%	11.8%	3.3%	0.6%	0.1%	< 0.1%	< 0.1%
Elm-Ash-Cottonwood	6.8%	21.1%	39.0%	20.4%	6.1%	2.1%	0.7%	0.3%	< 0.1%	.
Spruce-Jack Pine-Aspen	4.5%	8.5%	19.9%	28.4%	22.4%	8.8%	4.4%	1.9%	1.1%	0.1%
Other Softwoods	6.5%	42.0%	38.4%	4.6%	3.7%	2.1%	1.4%	0.8%	0.2%	.
Oak-Pine	4.4%	12.5%	21.3%	34.9%	18.5%	5.5%	2.0%	0.6%	0.2%	< 0.1%
Other	2.1%	7.3%	30.2%	38.8%	15.5%	3.9%	1.5%	0.4%	0.1%	0.1%
Non-stocked	99.5%	0.2%	0.1%	0.1%	0.1%	< 0.1%	-	-	-	< 0.1%
<b>TOTAL</b>	<b>11.1%</b>	<b>12.1%</b>	<b>25.5%</b>	<b>27.0%</b>	<b>14.0%</b>	<b>4.9%</b>	<b>2.6%</b>	<b>1.2%</b>	<b>0.4%</b>	<b>&lt; 0.1%</b>

**U.S. Great Lakes Basin**

	<b>0-20</b>	<b>21-40</b>	<b>41-60</b>	<b>61-80</b>	<b>81-100</b>	<b>101-120</b>	<b>121-140</b>	<b>141-160</b>	<b>161-200</b>	<b>200+</b>
Maple-Beech-Birch	6.3%	12.5%	30.5%	35.5%	10.9%	1.6%	0.3%	0.2%	< 0.1%	.
Aspen-Birch	21.4%	24.8%	30.9%	19.1%	3.3%	0.4%	0.1%	< 0.1%	-	0.1%
Spruce-Fir	5.9%	12.2%	30.4%	28.5%	15.5%	4.2%	1.6%	1.3%	0.3%	0.2%
White-Red-Jack Pine	12.5%	26.8%	36.1%	16.8%	5.8%	1.6%	0.4%	-	-	0.1%
Oak-Hickory	8.3%	16.6%	27.2%	26.4%	10.4%	3.2%	0.5%	0.1%	-	.
Elm-Ash-Cottonwood	7.8%	21.4%	38.6%	18.7%	6.0%	2.2%	0.8%	0.3%	-	.
Spruce-Jack Pine-Aspen										
Other Softwoods	7.2%	47.9%	42.9%	1.5%	-	-	-	-	-	.
Oak-Pine	7.9%	22.2%	27.0%	35.4%	7.4%	-	-	-	-	.
Other										
Non-stocked	100.0%	-	-	-	-	-	-	-	-	.
<b>TOTAL</b>	<b>10.5%</b>	<b>17.5%</b>	<b>31.3%</b>	<b>26.9%</b>	<b>8.9%</b>	<b>1.9%</b>	<b>0.5%</b>	<b>0.3%</b>	<b>&lt; 0.1%</b>	<b>&lt; 0.1%</b>

**Canadian Great Lakes Basin**

	<b>0-20</b>	<b>21-40</b>	<b>41-60</b>	<b>61-80</b>	<b>81-100</b>	<b>101-120</b>	<b>121-140</b>	<b>141-160</b>	<b>161-200</b>	<b>200+</b>
Maple-Beech-Birch	0.7%	3.4%	11.8%	26.6%	25.7%	13.1%	8.8%	6.2%	3.2%	0.5%
Aspen-Birch	2.8%	7.9%	27.2%	33.9%	20.7%	5.8%	1.3%	0.2%	0.1%	< 0.1%
Spruce-Fir	3.1%	4.3%	16.6%	26.0%	21.6%	13.0%	10.4%	4.5%	0.7%	0.1%
White-Red-Jack Pine	7.9%	8.0%	18.6%	27.3%	22.5%	9.0%	4.1%	1.5%	0.9%	0.2%
Oak-Hickory	1.3%	5.1%	18.9%	36.2%	31.9%	4.9%	1.1%	0.3%	0.3%	0.1%
Elm-Ash-Cottonwood	2.3%	19.9%	40.6%	28.0%	7.0%	1.7%	0.5%	0.1%	0.1%	< 0.1%
Spruce-Jack Pine-Aspen	4.5%	8.5%	19.9%	28.4%	22.4%	8.8%	4.4%	2/0%	1.1%	0.1%
Other Softwoods	2.2%	5.0%	10.5%	23.8%	26.3%	14.7%	10.4%	6.0%	1.1%	.
Oak-Pine	0.9%	2.0%	15.6%	34.3%	29.5%	11.0%	4.1%	1.3%	0.4%	< 0.1%
Other	2.1%	7.3%	30.2%	38.8%	15.5%	3.9%	1.5%	0.4%	0.1%	0.1%
Non-stocked	99.5%	0.3%	0.1%	0.1%	0.1%	< 0.1%	-	-	-	< 0.1%
<b>TOTAL</b>	<b>11.8%</b>	<b>5.9%</b>	<b>19.0%</b>	<b>27.0%</b>	<b>19.7%</b>	<b>8.4%</b>	<b>4.9%</b>	<b>2.3%</b>	<b>0.8%</b>	<b>0.1%</b>

Table 2.1 Age-class Distribution within Forest Type



### Forest Indicator #3. Extent of Area by Forest Type in Protected Area Categories as Defined by IUCN or Other Classification Systems

#### U.S. Great Lakes Basin

<i>in hectares</i>	Area	Protected Area	Protected as % of Area
Maple-Beech-Birch	5,693,178	308,332	5.4%
Aspen-Birch	2,684,602	73,402	2.7%
Spruce-Fir	1,784,559	79,060	4.4%
White-Red-Jack Pine	1,195,641	6,639	0.6%
Oak-Hickory	1,716,488	21,823	1.3%
Elm-Ash-Cottonwood	1,331,321	15,863	1.2%
Spruce-Jack Pine-Aspen	-	-	-
Other Softwoods	156,901	12,139	7.7%
Oak-Pine	89,200	-	-
Other	-	-	-
Non-stocked	94,485	-	-
<b>TOTAL</b>	<b>14,746,328</b>	<b>517,260</b>	<b>3.5%</b>

Table 3.1 Protected Area by Forest Type

#### Canadian Great Lakes Basin

<i>in hectares</i>	Area	Protected Area	Protected as % of Area
Maple-Beech-Birch	1,880,921	172,045	9.2%
Aspen-Birch	3,775,966	490,108	13.0%
Spruce-Fir	3,179,595	339,953	10.7%
White-Red-Jack Pine	1,503,720	191,345	12.7%
Oak-Hickory	121,648	18,819	15.5%
Elm-Ash-Cottonwood	301,019	8,096	2.7%
Spruce-Jack Pine-Aspen	480,402	53,180	11.1%
Other Softwoods	25,318	2,099	8.3%
Oak-Pine	89,544	20,138	22.5%
Other	519,266	55,991	10.8%
Non-stocked	1,168,003	50,754	4.4%
<b>TOTAL</b>	<b>13,045,401</b>	<b>1,402,527</b>	<b>10.8%</b>

Table 3.2 Changes in Protected Forest Area by State/Province

<i>in hectares</i>	Earliest Available	Most Recent Available	Change
Illinois	nil (1985)	1,538 (2002)	**
Indiana	5,828 (1986)	10,938 (2002)	+ 5,110
Michigan	275,936 (1980)	124,034 (2001)	- 151,902
Minnesota	567 (1977)	57,620 (2002)	+ 57,053
New York	53,765 (1993)	278,157 (2002)	+ 224,392
Ohio *	N/A	21,215 (1991)	N/A
Pennsylvania	1,013 (1989)	nil (2002)	**
Wisconsin	51,194 (1983)	23,758 (2002)	- 27,436
Ontario	585,072 (1998)	1,402,528 (2001)	+ 817,456

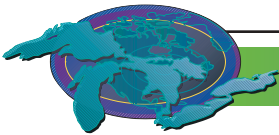
\* Ohio data only available for 1991

\*\* Illinois and Pennsylvania excluded from calculations due to small sample area

#### Acknowledgements

Author: Mervyn Han, ECO Federal Government Associate on contract to U.S. EPA-GLNPO. Julie Sims (U.S. EPA-GLNPO), Robert Miller (Ontario Ministry of Natural Resources), Connie Carpenter (U.S.D.A. Forest Service) and Earl Leatherberry (U.S.D.A. Forest Service) assisted in the preparation of this report.

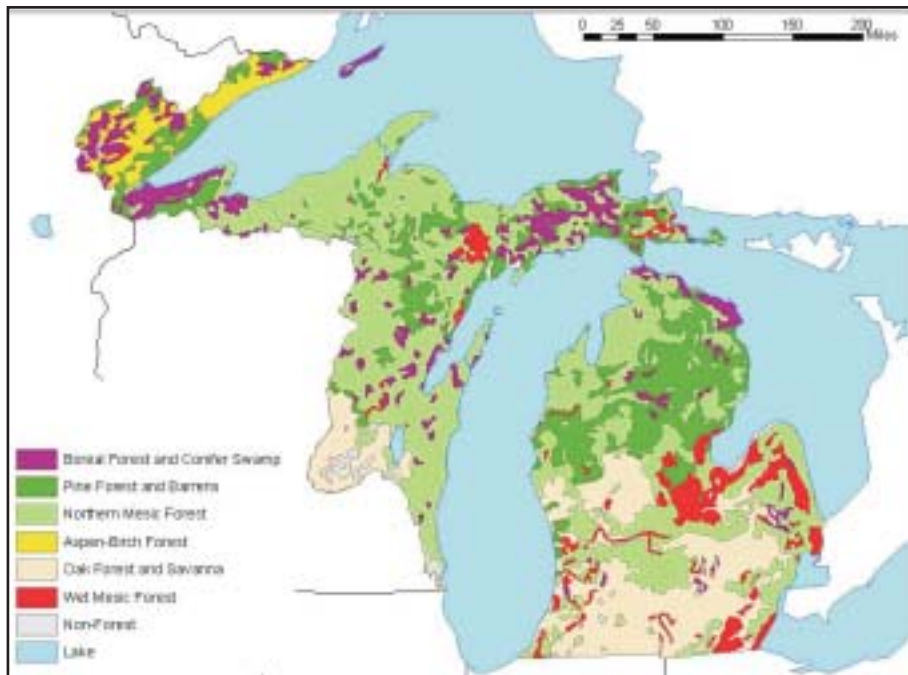
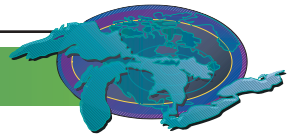
Advice on the development and selection of forest indicators was received from: Rich Greenwood (Ontario Ministry of Natural Resources), Bill Meades (Natural Resources Canada), Dave Kreutzweiser (Natural Resources Canada), Bill Route (National Park Service), Stephen Schlobohm (U.S.D.A. Forest Service), Dain Maddox (U.S.D.A. Forest Service), Joe Miller (U.S.D.A. Forest Service), Greg Nowacki (U.S.D.A. Forest Service), Connie Carpenter (U.S.D.A. Forest Service), Earl Leatherberry (U.S.D.A. Forest Service), Teague Prichard (Wisconsin Department of Natural Resources), Ann McCammon Soltis (Great Lakes Indian Fish and Wildlife Commission), Dale Phenicie (Council of Great Lakes Industry), Ben Wigley (National Council for Air and Stream Improvement, Inc.), Brad Williams (American Forests and Paper Association), Randy Swaty (The Nature Conservancy), and Wendy Hinrichs-Sanders (Great Lakes Forest Alliance).



## Sources

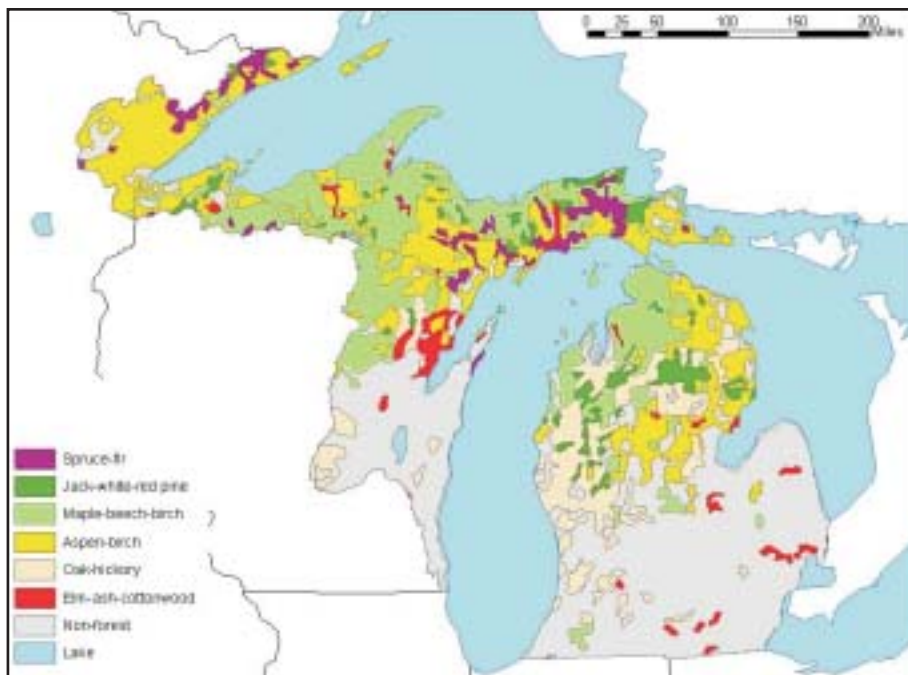
- Alerich, C. L., Klevgard, L., Liff, C., and Miles, P. D. 2004. The Forest Inventory and Analysis Database: Database Description and Users Guide Version 1.7. U.S.D.A. Forest Service, North Central Research Station. NC-218.  
Available online: [http://ncrs2.fs.fed.us/4801/fiadb/fiadb\\_documentation/FIADB\\_DOCUMENTATION.htm](http://ncrs2.fs.fed.us/4801/fiadb/fiadb_documentation/FIADB_DOCUMENTATION.htm)
- Canadian Council of Forest Ministers. 2000. Criteria and Indicators of Sustainable Forest Management in Canada: National Status 2000.  
Available online: [http://www.ccfm.org/ci/2000\\_e.html](http://www.ccfm.org/ci/2000_e.html)
- Carpenter, C., Giffen, C., and Miller-Weeks, M. 2003. Sustainability Assessment Highlights for the Northern United States. U.S.D.A. Forest Service, Northeastern Area State and Private Forestry. NA-TP-05-03.  
Available online: [http://www.na.fs.fed.us/sustainability/pdf/front\\_cover.pdf](http://www.na.fs.fed.us/sustainability/pdf/front_cover.pdf)
- Cole, K., Stearns, F., Guntenspergen, G., Davis, M. and Walker, K. 1998. Historical Landcover Changes in the Great Lakes Region. In Perspectives on the land-use history of North America: a context for understanding our changing environment, ed. Sisk, T.D., Ch. 6. U.S. Geological Survey, Biological Resources Division, Biological Science Report USGS/BRD/BSR 1998-0003.  
Available online: <http://biology.usgs.gov/luhna/chap6.html>
- Eubanks, C. E. and Meadows, D. 2002. A Soil Bioengineering Guide for Streambank and Lakeshore Stabilization. U.S.D.A. Forest Service, Technology and Development Program. FS-683.  
Available online: <http://www.fs.fed.us/publications/soil-bio-guide/>
- Guldin, R. W. and Kaiser, H. F. 2004. National Report on Sustainable Forests – 2003. U.S.D.A. Forest Service. FS-766.  
Available online: <http://www.fs.fed.us/research/sustain/documents/SustainableForests.pdf>
- Ontario Ministry of Natural Resources. 2002. State of the Forest Report, 2001. Queen's Printer for Ontario.  
Available online: [http://ontariosforests.mnr.gov.on.ca/spectrasites/Viewers/showArticle.cfm?id=20661E52-EE91-453D-9BD475CE675F7D1A&method=DISPLAYFULLNOBARNOTITLE\\_R&ObjectID=20661E52-EE91-453D-9BD475CE675F7D1A](http://ontariosforests.mnr.gov.on.ca/spectrasites/Viewers/showArticle.cfm?id=20661E52-EE91-453D-9BD475CE675F7D1A&method=DISPLAYFULLNOBARNOTITLE_R&ObjectID=20661E52-EE91-453D-9BD475CE675F7D1A)
- Sedell, J., Sharpe, M., Dravnieks Apple, D., Copenhagen, M. and Furniss, M. 2000. Water and the Forest Service. U.S.D.A. Forest Service, Policy Analysis. FS-660.  
Available online: <http://www.fs.fed.us/ftproot/pub/water/water.pdf>
- Smith, W. B. 2004. United States 2003 Report on Sustainable Forests, Data Report: Criterion 1, Indicators 1, 2, 3, 4, Conservation of Biological Diversity. U.S.D.A. Forest Service. FS-766A.  
Available online: <http://www.fs.fed.us/research/sustain/contents.htm>
- U.S.D.A. Forest Service. 2000 RPA Assessment of Forest and Range Lands. FS-687.  
Available online: [http://svinet2.fs.fed.us/pl/rpa/publications\\_in\\_support\\_of\\_the\\_2.htm](http://svinet2.fs.fed.us/pl/rpa/publications_in_support_of_the_2.htm)
- Canadian Great Lakes basin forest data are courtesy of Larry Watkins (Ontario Ministry of Natural Resources).
- U.S. Great Lakes basin forest data were compiled and analyzed on GIS software by the author using the U.S.D.A. Forest Service, Forest Inventory and Analysis database, with assistance from Geoffrey Holden (U.S.D.A. Forest Service). Raw data files available for download at:  
[http://ncrs2.fs.fed.us/4801/fiadb/fiadb17\\_dump/fiadb17\\_dump.htm](http://ncrs2.fs.fed.us/4801/fiadb/fiadb17_dump/fiadb17_dump.htm)
- Historical statewide forest data for Minnesota, Wisconsin and Michigan are courtesy of Kenneth Cole (U.S. Geological Survey) and were clipped to Great Lakes basin boundary using GIS software by the author.





**Pre-settlement Forest**

Source: USGS, based on General Land Office survey (1815-1866)



**Modern Forest**

Source: USGS, based on USDA Forest Service, Forest Inventory and Analysis Database (1977-1983)



## Acid Rain

SOLEC Indicator #9000

**Assessment: Mixed, Improving**

### Purpose

To assess the pH levels in precipitation and the critical loads of sulfate to the Great Lakes basin, and to infer the efficacy of policies to reduce sulfur and nitrogen acidic compounds released into the atmosphere.

### Ecosystem Objective

The 1991 Canada - U.S. Air Quality Agreement (Air Quality Agreement) pledges the two nations to reduce the emissions of acidifying compounds by approximately 40% relative to 1980 levels. The 1998 Canada-Wide Acid Rain Strategy for Post-2000 intends to further reduce emissions to the point where deposition containing these compounds does not adversely impact aquatic and terrestrial biotic systems.

### State of the Ecosystem

Acid rain, more properly called “acidic deposition”, is caused when two common air pollutants (sulfur dioxide –  $\text{SO}_2$  and nitrogen oxides –  $\text{NO}_x$ ) are released into the atmosphere, react and mix with high altitude water droplets and return to the earth as acidic rain, snow, fog or particulate matter. These pollutants can be carried over long distances by prevailing winds, creating acidic precipitation far from the original source of the emissions. Environmental damage typically occurs where local soils and/or bedrock do not effectively neutralize the acid.

Lakes and rivers have been acidified by acid rain directly or indirectly causing the disappearance of invertebrates, many fish species, waterbirds and plants. Not all lakes exposed to acid rain become acidified however. Lakes located in terrain that is rich in calcium carbonate (e.g. on limestone bedrock) are able to neutralize acidic deposition. Much of the acidic precipitation in North America falls in areas around and including the Great Lakes basin. Northern Lakes Huron, Superior and Michigan, their tributaries and associated small inland lakes are located on the geological feature known as the Canadian Shield. The Shield is primarily composed of granitic bedrock and glacially derived soils that cannot easily neutralize acid, thereby resulting in the acidification of many small lakes (particularly in northern Ontario and the northeastern United States). The five Great Lakes are so large that acidic deposition has little effect on them directly. Impacts are mainly felt on vegetation and inland lakes in acid-sensitive areas.

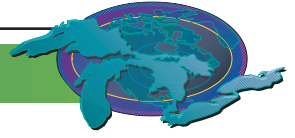
A recent report published by the Hubbard Brook Research Foundation has demonstrated that acid deposition is still a significant problem and has had a greater environmental impact than previously thought. For example, acid deposition has altered soils in the northeastern U.S. through the accelerated leaching of base cations, the accumulation of nitrogen and sulfur, and an increase in concentrations of aluminum in soil waters. Acid deposition has also contributed to the decline of red spruce trees and sugar maple trees in the eastern U.S.

### Sulfur Dioxide and Nitrous Oxides Emissions Reductions

$\text{SO}_2$  emissions come from a variety of sources. The most common releases of  $\text{SO}_2$  in Canada are industrial processes such as non-ferrous mining and metal smelting. In the United States, electrical utilities constitute the largest emissions source (Figure 1). The primary source of  $\text{NO}_x$  emissions in both countries is the combustion of fuels in motor vehicles, with electric utilities and industrial sources also contributing (Figure 2).

Canada is committed to reducing acid rain in its south-eastern region to levels below those that cause harm to ecosystems – a level commonly called the “critical load” - while keeping other areas of the country (where acid rain effects have not been observed) clean. In 2000, total  $\text{SO}_2$  emissions in Canada were 2.4 million tonnes, which is about 23 percent below the national cap of 3.2 million tonnes reiterated under Annex 1 (the Acid Rain Annex) of the Air Quality Agreement. Emissions in 2000 also represent a 50 percent reduction from 1980 emission levels. The seven easternmost provinces’ 1.6 million tonnes of emissions in 2000 were 29 percent below the eastern Canada cap of 2.3 million tonnes reiterated under the Acid Rain Annex.

In 2002, all participating sources of the U.S. EPA’s Acid Rain Program (Phase I & II) achieved a total reduction in  $\text{SO}_2$  emissions of



about 35 percent from 1990 levels, and 41 percent from 1980 levels. The Acid Rain Program now affects approximately 3,000 units. These units reduced their SO<sub>2</sub> emissions to 10.19 million tons in 2002, about 4 percent lower than 2001 emissions. Full implementation of the program in 2010 will result in a permanent national emissions cap of 8.95 million tons, representing about a 50 percent reduction from 1980 levels. (For additional information on SO<sub>2</sub> emission reductions, including sources outside the Acid Rain Program, please refer to the SOLEC Indicator Report #4176 Air Quality).

By 2000, Canadian NO<sub>x</sub> emissions were reduced by more than 100,000 tonnes below the forecast level of 970,000 tonnes (established by Acid Rain Annex) at power plants, major combustion sources, and smelting operations. Canada is also developing other programs to further reduce NO<sub>x</sub> emissions (For additional details, please refer to the SOLEC Indicator Report # 4176 Air Quality).

In the U.S., reductions in NO<sub>x</sub> emissions have significantly surpassed the 2 million ton reduction for stationary and mobile sources mandated by the Clean Air Act Amendments of 1990. Under the Acid Rain Program alone, NO<sub>x</sub> emissions for all the affected sources in 2002 were 4.5 million tons, about 33 percent lower than emissions in 1990. (For additional information on NO<sub>x</sub> emission reductions, including sources outside the Acid Rain Program, please refer to the SOLEC Indicator Report # 4176 Air Quality).

### Future pressures

Figure 3 illustrates the trends in SO<sub>2</sub> emission levels in Canada and the United States measured from 1980 to 2000 and predicted through 2010. U.S. levels dropped by 34 percent from 1980 to 2000. Canadian SO<sub>2</sub> emission levels decreased 50 percent from 1980 to 2000. Overall, a 38 percent reduction in SO<sub>2</sub> emissions is projected in Canada and the United States from 1980 to 2010, mainly due to controls on electric utilities under the Acid Rain Program and the desulphurization of diesel fuel under Section 214 of the 1990 Clean Air Act Amendments in the U.S. In Canada, reductions of SO<sub>2</sub> are mainly attributed to reductions from the non-ferrous mining and smelting sector, and electric utilities as part of the 1985 Eastern Canada Acid Rain Program that was completed in 1994. Further SO<sub>2</sub> reductions will be achieved through the implementation of the Canada-Wide Acid Rain Strategy. NO<sub>x</sub> emissions decreased by about 12 percent in the U.S. from 1993 to 2002, and remained relatively constant in Canada since 1990. NO<sub>x</sub> emissions are projected to decrease considerably in both countries by 2010. Despite these efforts, rain is still too acidic throughout most of the Great Lakes region.

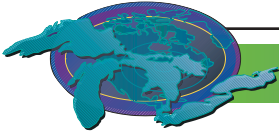
Figure 4 compares wet sulfate deposition (kilograms sulfate per hectare per year) over eastern North America before and after the 1995 Acid Rain Program Phase I emission reductions to assess whether the emission decreases have had an impact on large-scale wet deposition. The five-year average sulfate wet deposition pattern for the years 1996-2000 is considerably reduced from that for the five-year period prior to the Phase I emission reductions (1990-1994). For example, the large area that received 25 to 30 kg/ha/yr of sulfate wet deposition in the 1990-1994 period almost disappeared in 1996-2000 period. The shrinkage of the wet deposition pattern between the two periods strongly suggests that the Phase I emission reduction were successful at reducing the sulfate wet deposition over a large section of eastern North America. Monitoring data from 2000 through 2002 indicate that wet sulfate deposition continued to decrease probably as a result of Phase II of the Acid Rain Program. However, if SO<sub>2</sub> emissions remain relatively constant after the year 2000, as predicted (Figure 3), it is unlikely that sulfate deposition will change considerably in the coming decade. Sulfate deposition models predict that in 2010, following implementation of the Phase II acid rain program, critical loads for aquatic ecosystems in eastern Canada will still be exceeded over an area of approximately 800,000 km<sup>2</sup>.

A somewhat different story occurs for nitrate wet deposition in that the spatial patterns shown in Figure 4 are approximately the same before and after the Phase I emission reductions. This suggests that the minimal reductions in NO<sub>x</sub> emissions after Phase I resulted in minimal changes to nitrate wet deposition over eastern North America.

Pressures will continue to grow as the population within and outside the basin increases, causing increased demands on electrical utility companies, resources and an increased number of motor vehicles. Considering this, reducing nitrogen deposition is becoming more and more important, as its contribution to acidification may soon outweigh the benefits gained from reductions in sulfur dioxide emissions.

### Management Implications

The effects of acid rain can be seen far from the source, so the governments of Canada and the United States are working together to reduce acid emissions. The 1991 Canada - United States Air Quality Agreement addresses transboundary pollution. To date, this



agreement has focused on acidifying pollutants and significant steps have been made in the reduction of SO<sub>2</sub> emissions. However, further progress in the reduction of acidifying pollutants, including NO<sub>x</sub>, is required.

In December 2000, Canada and the United States signed Annex III (the Ozone Annex) to the Air Quality Agreement. The Ozone Annex committed Canada and the U.S. to aggressive emission reduction measures to reduce emissions of NO<sub>x</sub> and volatile organic compounds. (For more information on the Ozone Annex, please refer to the SOLEC Indicator Report # 4176 Air Quality).

The 1998 Canada-Wide Acid Rain Strategy for Post-2000 provides a framework for further actions, such as establishing new sulfur dioxide emission reduction targets in Ontario, Quebec, New Brunswick and Nova Scotia. In fulfillment of the Strategy, each of these provinces has announced a 50% reduction from its existing emissions cap. Quebec, New Brunswick and Nova Scotia are committed to achieving their caps by 2010, while Ontario committed to meet its new cap by 2015.

Since the last SOLEC Report, there has been increasing interest in both the public and private sector in a multi-pollutant approach to reducing air pollution. In February 2002, U.S. President George W. Bush proposed the Clear Skies Initiative, which would significantly reduce power plant emissions of SO<sub>2</sub>, NO<sub>x</sub>, and mercury. This initiative would establish national, enforceable emission caps for the three pollutants and would provide cuts in SO<sub>2</sub> emissions of 73 percent from 2000 emissions of 11.2 million tons by 2018 and NO<sub>x</sub> emissions by 67 percent from 2000 emissions of 5.1 million tons by 2018.

### Further Work Necessary

While North American SO<sub>2</sub> emissions and sulfate deposition levels in the Great Lakes basin have declined over the past 10 to 15 years, many acidified lakes do not show recovery (increase in water pH or alkalinity). Empirical evidence suggests that there are a number of factors acting to delay or limit the recovery response, e.g. increasing importance of nitrogen-based acidification, soil depletion of base cations, mobilization of stored sulfur, climatic influences, etc. Further work is needed to quantify the additional reduction in deposition needed to overcome these limitations and to accurately predict the recovery rate.

### Acknowledgements

Authors: Dean S. Jeffries, National Water Research Institute, Environment Canada, Burlington, ON; Robert Vet and Silvina Carou, Meteorological Service of Canada, Environment Canada, Downsview, ON; Kerri Timoffee, Manager, Acid Rain Program, Environment Canada, Gatineau, QC; and Todd Nettesheim, Great Lakes National Program Office, United States Environmental Protection Agency, Chicago, IL.

### Sources

Canadian Council of Ministers of the Environment. 2004. 2002 Annual progress Report on the Canada-Wide Acid Rain Strategy for Post-2000. ISBN 0-622-67819-2. [http://dev.sites1.miupdate.com/1/assets/pdf/2002\\_ar\\_annual\\_rpt\\_e.pdf](http://dev.sites1.miupdate.com/1/assets/pdf/2002_ar_annual_rpt_e.pdf) (Accessed July 21, 2004)

Canadian Council of Ministers of the Environment. 2002. 2001 Annual Progress Report on the Canada-Wide Acid Rain Strategy for Post-2000. ISBN 0-662-66963-0. [http://www.ccme.ca/assets/pdf/acid\\_rain\\_e.pdf](http://www.ccme.ca/assets/pdf/acid_rain_e.pdf) (Accessed July 16, 2004).

Driscoll, C.T., G.B. Lawrence, A.J. Bulger, T.J. Butler, C.S. Cronan, C. Eagar, K.F. Lambert, G.E. Likens, J.L. Stoddard, K.C. Weathers. 2001. Acid Rain Revisited: advances in scientific understanding since the passage of the 1970 and 1990 Clean Air Act Amendments. Hubbard Brook Research Foundation. Science Links™ Publication. Vol. 1, no.1.

Environment Canada. 2004. *2002 National Pollutant Release Inventory Data*. [http://www.ec.gc.ca/pdb/npri/npri\\_dat\\_rep\\_e.cfm#highlights](http://www.ec.gc.ca/pdb/npri/npri_dat_rep_e.cfm#highlights) (Accessed June 29, 2004).

Environment Canada. 2003. *2001 National Pollutant Release Inventory: National Overview*. [http://www.ec.gc.ca/pdb/npri/npri\\_dat\\_rep\\_e.cfm#annual2001](http://www.ec.gc.ca/pdb/npri/npri_dat_rep_e.cfm#annual2001) (Accessed June 29, 2004).

Environment Canada. 2003. Environmental Signals: Canada's National Environmental Indicator Series 2003. [http://www.ec.gc.ca/soer-ree/English/Indicator\\_series/default.cfm#pic](http://www.ec.gc.ca/soer-ree/English/Indicator_series/default.cfm#pic) (Accessed June 29, 2004).

Environment Canada. 2003. Cleaner Air through Cooperation: Canada – United States Progress under the Air Quality Agreement 2003. ISBN 0-662-34082-5. <http://www.epa.gov/airmarkets/usca/brochure/brochure.htm> (Accessed June 17, 2004).



Environment Canada. National Atmospheric Chemistry Database and Analysis Facility. Meteorological Service of Canada.

International Joint Commission. Canada-United States Air Quality Agreement: 2002 Progress Report. <http://www.epa.gov/airmarkets/usca/airus02.pdf> (Accessed June 17, 2004).

Jeffries, D.S., T.A. Clair, S. Couture, P.J. Dillon, J. Dupont, W. Keller, D.K. McNicol, M.A. Turner, R. Vet, and R. Weeber. 2003. Assessing the recovery of lakes in southeastern Canada from the effects of acidic deposition. *Ambio* 32(3): 176-182.

National Atmospheric Deposition Program: A Cooperative Research Support Program of the State Agricultural Experiment Stations (NRSP-3) Federal and State Agencies and Non-Governmental Research Organizations. <http://nadp.sws.uiuc.edu/>

Ontario Ministry of the Environment. Air Quality in Ontario 2002 Report. Queen's Printer for Ontario, 2004. <http://www.ene.gov.on.ca/envision/techdocs/4521e01.pdf> (Accessed June 28, 2004).

Ontario Ministry of the Environment. Air Quality in Ontario 2001 Report. Queen's Printer for Ontario, 2003. <http://www.ene.gov.on.ca/envision/air/AirQuality/2001.htm> (Accessed June 17, 2004).

U.S. EPA. 2003. Clean Air Markets Programs. *Acid Rain Program: 2002 Progress Report*. EPA-430-R-03-011. <http://www.epa.gov/airmarkets/cmprpt/arp02/2002report.pdf> (Accessed July 16, 2004).

U.S. EPA. 2003. National Air Quality and Emissions Trends Report: 2003 Special Studies Edition. Office of Air Quality Planning and Standards. EPA-454/R-03-005. <http://www.epa.gov/air/airtrends/aqtrnd03/> (Accessed June 17, 2004).

U.S. EPA. 2003. *Latest Findings on National Air Quality: 2002 Status and Trends*. Office of Air Quality Planning and Standards. EPA-454/K-03-001. [http://www.epa.gov/airtrends/2002\\_airtrends\\_final.pdf](http://www.epa.gov/airtrends/2002_airtrends_final.pdf) (Accessed June 17, 2004).

U.S. EPA. 2003. EPA's Draft Report on the Environment: Technical Document. EPA-600-R-03-050. <http://www.epa.gov/indicators/> (Accessed June 30, 2004).

U.S. EPA. 2003. 1999 National Emissions Inventory Documentation and Data. <http://www.epa.gov/ttn/chief/net/1999inventory.html>

U.S. EPA. Projection year emissions data. <http://www.epa.gov/otaq/models/hd2007/r00020.pdf>

U.S. EPA. The Clear Skies Initiative. <http://www.epa.gov/clearskies/>

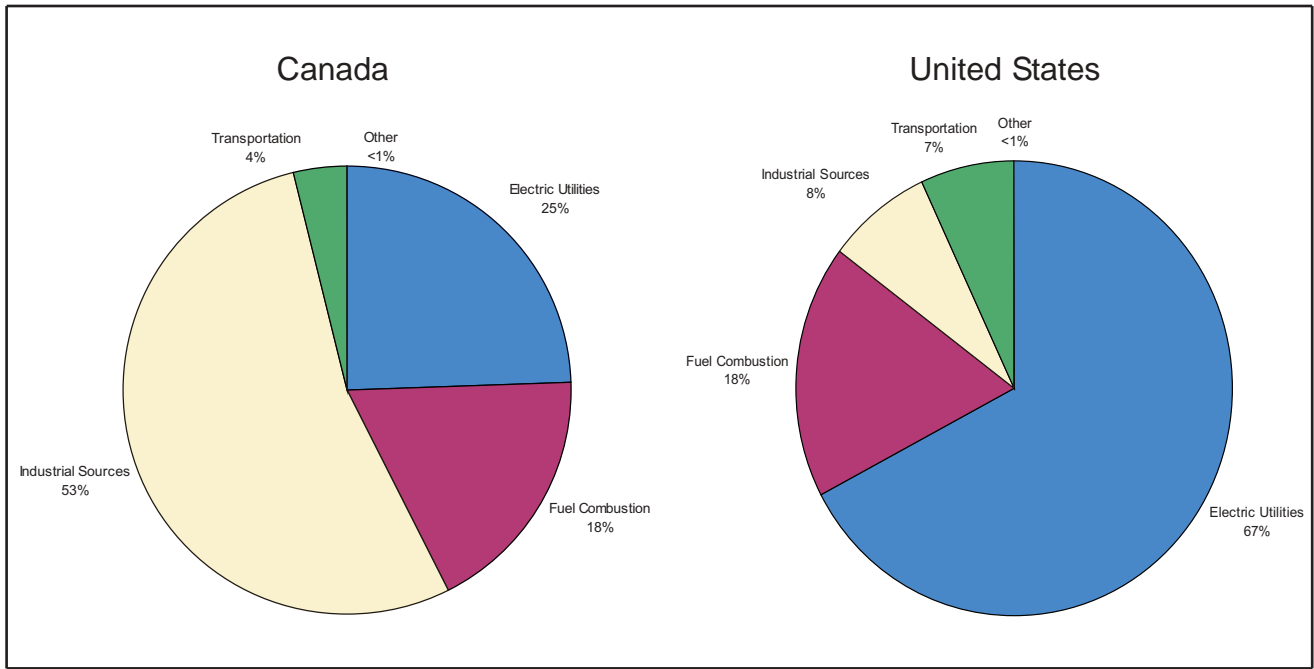
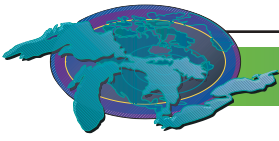


Figure 1. Sources of Sulfur Dioxide Emissions in Canada (1999) and the U.S. (1999)

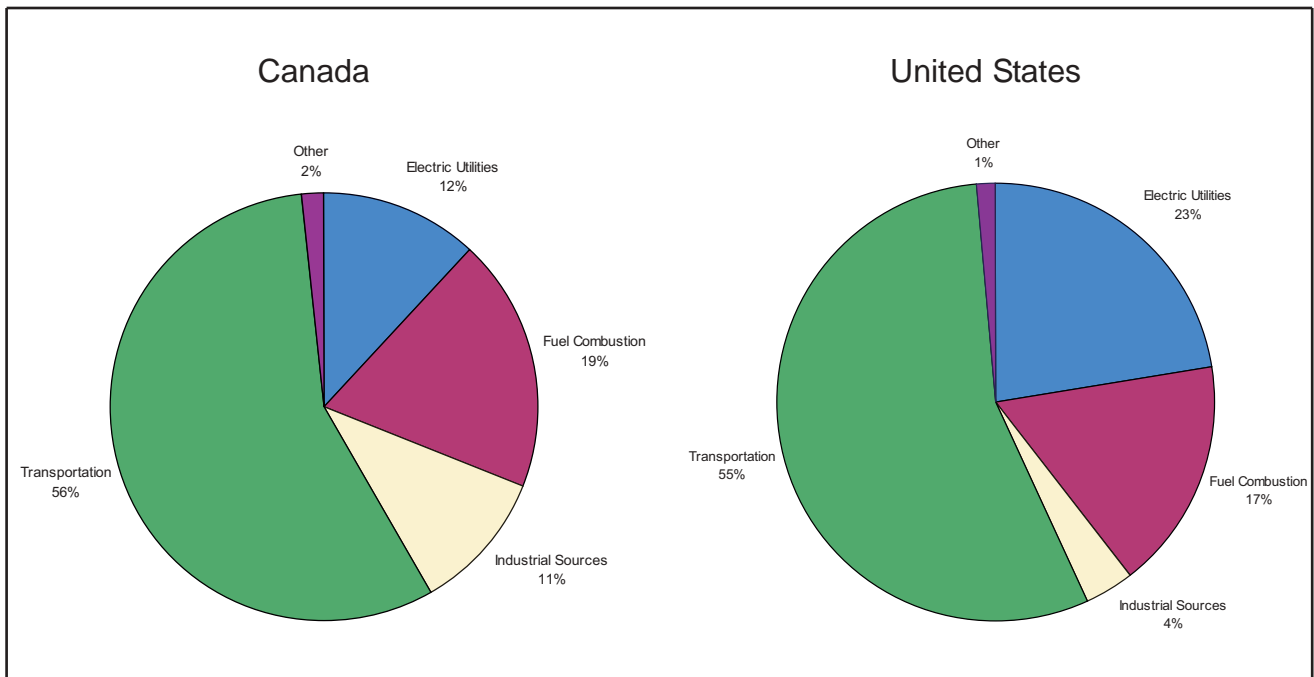


Figure 2. Sources of Nitrogen Oxides Emissions in Canada (1999) and the U.S. (1999)

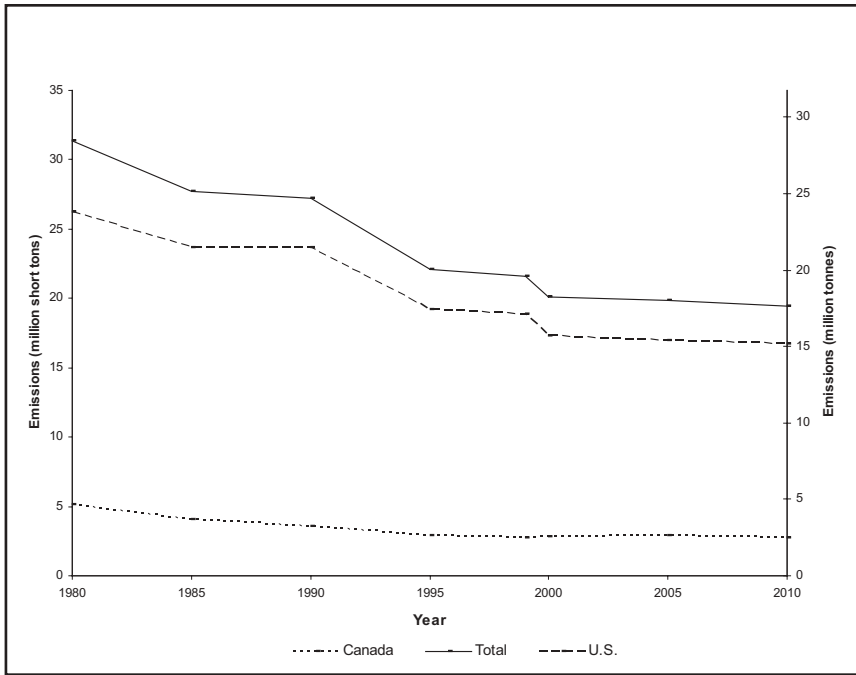
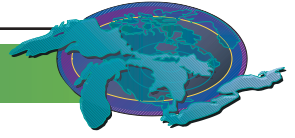


Figure 3. Canada – U.S. SO<sub>2</sub> Emissions, 1980-2010

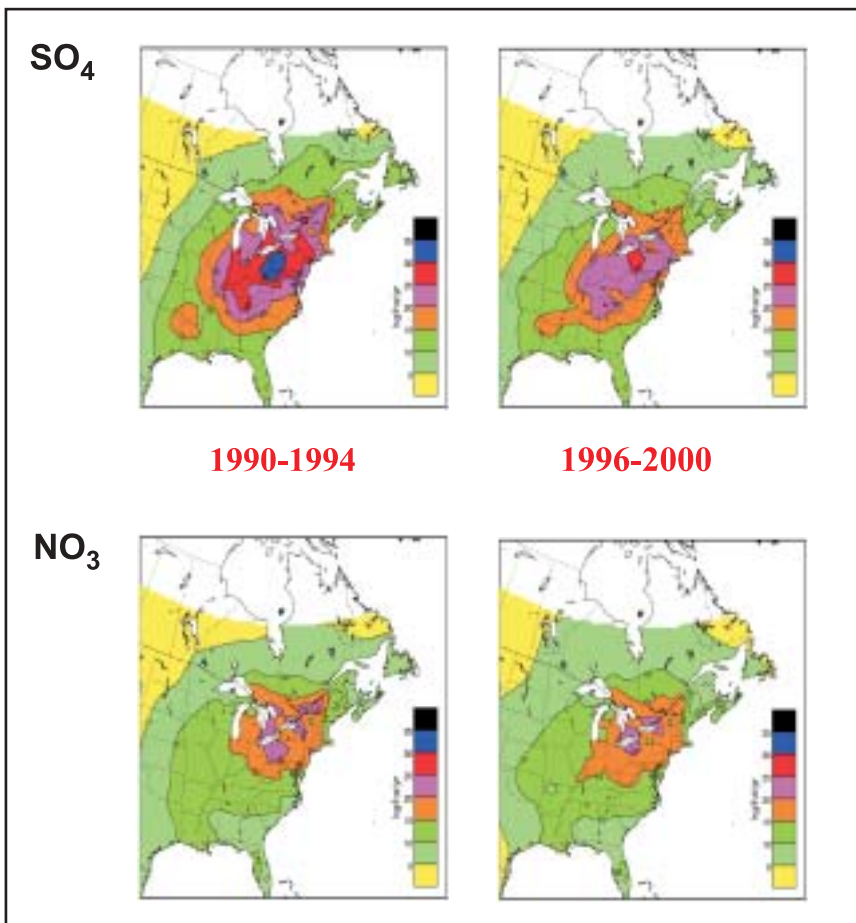
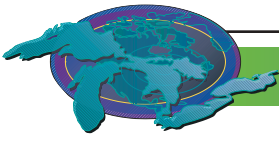


Figure 4. Five-year mean patterns of wet non-sea-salt-sulfate and wet nitrate deposition for the periods 1990-1994 and 1996-2000.



## Non-Native Species

SOLEC Indicator #9002

**Assessment: Poor, Deteriorating (long term)**

### Purpose

This indicator reports introductions of aquatic organisms not naturally occurring in the Laurentian Great Lakes. It aids in the assessment of the status of biotic communities because nonindigenous species (NIS) can alter both the structure and function of ecosystems. Reporting new species will highlight the need for more effective safeguards to prevent the introduction and establishment of new NIS.

### Ecosystem Objective

The purpose of the U.S. and Canada Water Quality Agreement is, in part, to restore and maintain the biological integrity of the waters of the Great Lakes ecosystem. Minimally, extinctions and unauthorized introductions must be prevented to maintain biological integrity. Nearly 10% of the nonindigenous species (NIS) introduced to the Great Lakes have had significant impacts on ecosystem health, a percentage consistent with findings in the United Kingdom (Williamson and Brown 1986) and the Hudson River of North America (Mills et al. 1997). In the Great Lakes, oceangoing ships remain the most-used invasion vector; however, other vectors such as canals and private sector activities are also utilized by NIS with potential to harm biological integrity.

### State of the Ecosystem

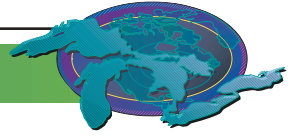
Human activities associated with shipping are responsible for over half of NIS introductions to the Great Lakes (Figure 1). Total numbers of NIS introduced and established in the Great Lakes have increased steadily since the 1830s (Figure 2a); however, numbers of ship-introduced NIS have increased exponentially during the same time period (Figure 2b). Release of contaminated ballast water by transoceanic ships has been implicated in over 70% of faunal nonindigenous species (NIS) introductions to the Great Lakes since the opening of the St. Lawrence Seaway in 1959 (Grigorovich et al. 2003).

During the 1980s, the importance of ship ballast water was increasingly appreciated, finally prompting ballast management measures in the Great Lakes. In the wake of Eurasian ruffe and zebra mussel introductions, Canada introduced voluntary guidelines ballast exchange for ships declaring "ballast on board" (BOB) following transoceanic voyages (1989), as recommended by the Great Lakes Fishery Commission and the International Joint Commission. In 1990, the United States Congress passed the Nonindigenous Aquatic Nuisance Prevention and Control Act (followed by the National Invasive Species Act in 1996), producing the Great Lakes' first ballast exchange and management regulations in May of 1993.

Contrary to expectations, the reported invasion rate has increased following initiation of voluntary guidelines in 1989 and mandated regulations in 1993 (Grigorovich et al. 2003, Holeck et al. in press). However, >90% of transoceanic ships that entered the Great Lakes during the 1990s declared "no ballast on board" (NOBOB) (Colautti et al. 2003) (Figure 3) and were not required to exchange ballast although their tanks contained residual sediments and water that would be discharged in the Great Lakes. Recent studies suggest that the Great Lakes may vary in vulnerability to invasion in space and time. Lake Superior receives a disproportionate number of discharges by both BOB and NOBOB ships, yet it has sustained surprisingly few initial invasions; conversely, the waters connecting lakes Huron and Erie are an invasion 'hotspot' despite receiving disproportionately few ballast discharges (Grigorovich et al. 2003). Ricciardi and Rasmussen (2001) suggest that some invaders (such as *Dreissena sp.*) may facilitate the introduction of co-evolved species such as round goby and the amphipod *Echinogammarus*.

Other vectors, including canals and the private sector, continue to deliver NIS to the Great Lakes and may increase in relative importance in the future. Silver and bighead carp escapees from southern U.S. fish farms have been sighted 20 miles below an electric barrier in the Chicago Sanitary and Ship Canal, which connects the Mississippi River and the Great Lakes; the electrical dispersal barrier was activated in April, 2002 in the Chicago Sanitary and Ship Canal to block the transmigration of species between the Mississippi River system and the Great Lakes basin. The Corps of Engineers (partnered by the State of Illinois) plans to begin construction of a second dispersal barrier in 2004. A rotenone treatment plan is being reviewed by Illinois officials for possible deployment should carp threaten to breach the barrier. Barriers and rotenone treatments would not be necessary had there been better screening of species prior to importation. The feasibility of restoring hydrological separation of the Great Lakes and Mississippi River Basins is being discussed.





Second only to shipping, unauthorized release, transfer, and escape have introduced NIS into the Great Lakes. Of particular concern are private sector activities related to aquaria, garden ponds, baitfish, and live foodfish markets. For example, nearly a million Asian carp, including bighead and black carp, are sold annually at fish markets within the Great Lakes basin. Until recently, most of these fish were sold live. All eight Great Lakes states and the province of Ontario now have some restriction on the sale of live Asian carp; however, enforcement of many private transactions remains a challenge. Also, live carp may still be purchased in Montreal. The U.S. Fish and Wildlife Service is considering listing several Asian carp as nuisance species under the Lacey Act, which would prohibit interstate transport. Finally, there are currently numerous shortcomings in legal safeguards relating to commerce in exotic live fish as identified by Alexander (2003) in Great Lakes and Mississippi River states, Quebec, and Ontario. These include: Express and *de facto* exemptions for the aquarium pet trade; *De facto* exemptions for the live foodfish trade; Inability to proactively enforce import bans; Lack of inspections at aquaculture facilities; Allowing aquaculture in public waters; Inadequate triploidy (sterilization) requirements; Failure to regulate species of concern, e.g., Asian carp; Regulation through “dirty lists” only, e.g., banning known nuisance species); and Failure to regulate transportation.

### Pressures

NIS have invaded the Great Lakes basin from regions around the globe (Figure 4), and increasing world trade and travel will elevate the risk that new species (Table 1) will continue to gain access to these ecosystems. Existing diversions of water into the Great Lakes such as the Chicago Sanitary and Ship Canal, and growth of industries such as aquaculture, live food markets, and aquarium retail stores will also increase the risk that NIS will be introduced. Changes in water quality, global climate change, and previous NIS introductions may make the Great Lakes more hospitable for the establishment of new invaders.

### Management Implications

Researchers are seeking to better understand links between vectors and donor regions, the receptivity of the Great Lakes ecosystem, and the biology of new invaders in order to make recommendations to reduce the risk of future invasion. To protect the biological integrity of the Great Lakes, it is essential to closely monitor routes of entry for NIS, to introduce effective safeguards, and to quickly adjust safeguards as needed. The present trajectory of NIS reported in the Great Lakes exceeds that observed in earlier years, which, together with an increasing frequency of facilitations, suggests that the system may have already entered an ‘invasional melt-down’ phase (Ricciardi 2001). To be effective in preventing new invasions, management strategies must focus on linkages between NIS, vectors, and donor and receiving regions. Without measures that effectively eliminate or minimize the role of ship-borne and other, emerging vectors, we can expect the number of NIS in the Great Lakes to continue to rise, with an associated loss of native biodiversity and an increase in unpredicted ecological disruptions.

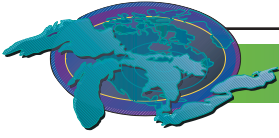
### Acknowledgments

Authors: Edward L. Mills and Kristen T. Holeck, Department of Natural Resources, Cornell University, Bridgeport, NY. Margaret Dochoda, Great Lakes Fishery Commission, Ann Arbor, MI.

### Sources

- Alexander, A. 2003. Legal tools and gaps relating to commerce in exotic live fish: phase 1 report to the Great Lakes Fishery Commission by the Environmental Law and Policy Center. Environmental Law and Policy Center, Chicago, Illinois.
- Colautti, R.I., A.J. Niimi, C.D.A. van Overdijk, E.L. Mills EL, K.T. Holeck, and H.J. MacIsaac. 2003. Spatial and temporal analysis of transoceanic shipping vectors to the Great Lakes. Pages 227-246 in Ruiz GM, Carlton JT, eds. *Invasion Species: Vectors and Management Strategies*. Island Press, Washington, DC.
- Grigorovich, I.A., R.I. Colautti, E.L. Mills, K.T. Holeck, A.G. Ballert, and H.J. MacIsaac. 2003. Ballast-mediated animal introductions in the Laurentian Great Lakes: retrospective and prospective analyses. *Canadian Journal of Fisheries and Aquatic Sciences* 60: 740-756.
- Holeck, K.T., E.L. Mills, H.J. MacIsaac, M.R. Dochoda, R.I. Colautti, and A. Ricciardi. Bridging troubled waters: understanding links between biological invasions, transoceanic shipping, and other entry vectors in the Laurentian Great Lakes. *Bioscience* (in press).

Kolar, C.S., and D.M. Lodge. 2002. Ecological predictions and risk assessment for alien fishes in North America. *Science* 298:



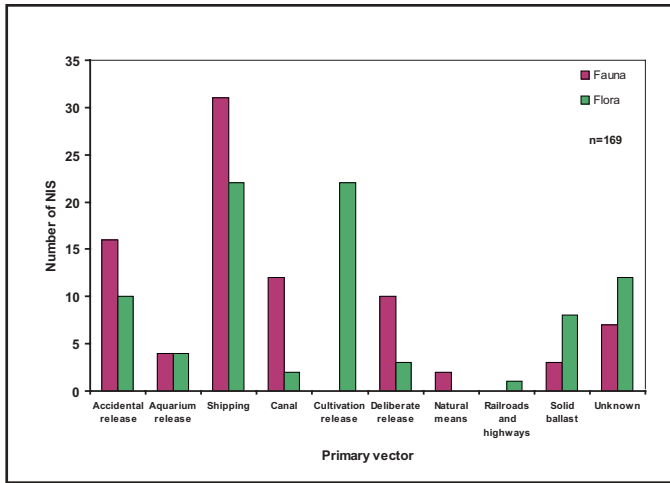
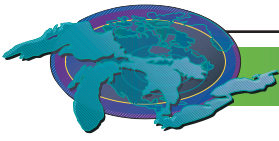
1233-1236.

- Mills, E.L., J.H. Leach, J.T. Carlton, and C.L. Secor. 1993. Exotic species in the Great Lakes: A history of biotic crises and anthropogenic introductions. *Journal of Great Lakes Research*. 19(1): 1-54.
- Mills, E.L., M.D. Scheuerell, J.T. Carlton, and D.L. Strayer. 1997. Biological invasions in the Hudson River. *NYS Museum Circular No. 57*. Albany, NY.
- Ricciardi, A. 2001. Facilitative interactions among aquatic invaders: is an “invasional meltdown” occurring in the Great Lakes? *Canadian Journal of Fisheries and Aquatic Sciences*. 58: 2513-2525.
- Ricciardi, A. and J.B Rasmussen. 1998. Predicting the identity and impact of future biological invaders: a priority for aquatic resource management. *Canadian Journal of Fisheries and Aquatic Sciences* 55: 1759-1765.
- Rixon, C.A.M, I.C. Duggan., N.M.N. Bergeron, A. Ricciardi, and H.J. MacIsaac. 2004. Invasion risks posed by the aquarium trade and live fish markets on the Laurentian Great Lakes. *Biodiversity and Conservation* (in press).
- Stokstad E. 2003. Can well-timed jolts keep out unwanted exotic fish? *Science* 301: 157-158.
- Williamson, M.H. and K.C. Brown. 1986. The analysis and modeling of British invasions. *Philosophical Transactions of the Royal Society of London, Series B*. 314: 505-522.

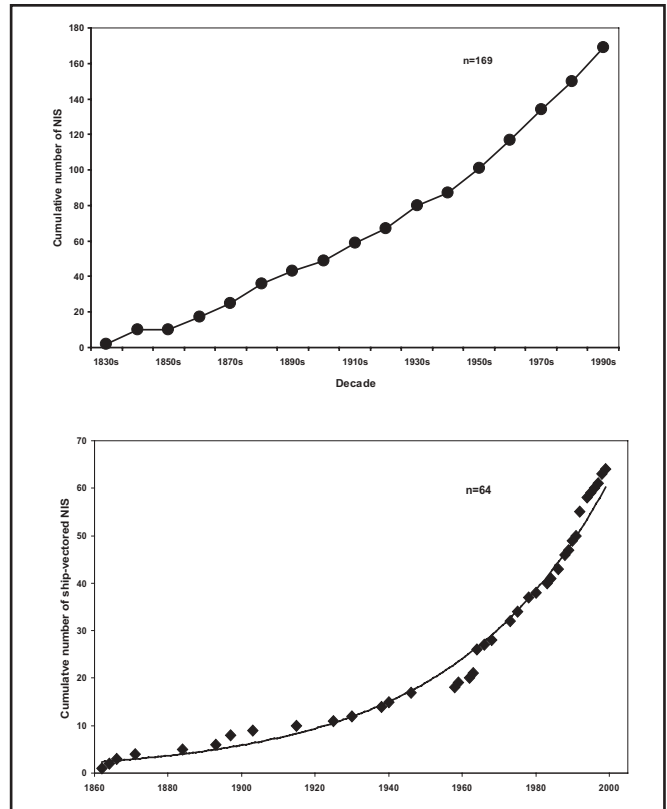


Species	Reference
<b>Fishes</b>	
<i>Aphanius boyeri</i>	Kolar and Lodge 2002
<i>Benthophilus stellatus</i>	Ricciardi and Rasmussen 1998
<i>Clupeonella caspia (cultriventris)</i>	Ricciardi and Rasmussen 1998; Kolar and Lodge 2002
<i>Hypophthalmichthys (Aristichthys) nobilis</i>	Stokstad 2003; Rixon et al. 2004
<i>Hypophthalmichthys molitrix</i>	Stokstad 2003
<i>Misgurnus anguillicaudatus</i>	Rixon et al. 2004
<i>Neogobius fluviatilis</i>	Ricciardi and Rasmussen 1998; Kolar and Lodge 2002
<i>Perca fluviatilis</i>	Kolar and Lodge 2002
<i>Phoxinus phoxinus</i>	Kolar and Lodge 2002
<i>Tanichthys albonubes</i>	Rixon et al. 2004
<b>Cladocerans</b>	
<i>Daphnia cristata</i>	Grigorovich et al. 2003
<i>Bosmina obtusirostris</i>	Grigorovich et al. 2003
<i>Cornigerius maeoticus maeoticus</i>	Grigorovich et al. 2003
<i>Podonevadne trigona ovum</i>	Grigorovich et al. 2003
<b>Copepods</b>	
<i>Heterocope appendiculata</i>	Grigorovich et al. 2003
<i>Heterocope caspia</i>	Grigorovich et al. 2003
<i>Calanipeda aquae-dulcis</i>	Grigorovich et al. 2003
<i>Cyclops kolensis</i>	Grigorovich et al. 2003
<i>Ectinosoma abrau</i>	Grigorovich et al. 2003
<i>Paraleptastacus spinicaudata trisetata</i>	Grigorovich et al. 2003
<b>Amphipods</b>	
<i>Corophium curvispinum</i>	Ricciardi and Rasmussen 1998
<i>Corophium sowinskyi</i>	Ricciardi and Rasmussen 1998
<i>Dikerogammarus haemobaphes</i>	Ricciardi and Rasmussen 1998; Grigorovich et al. 2003
<i>Dikerogammarus villosus</i>	Ricciardi and Rasmussen 1998; Grigorovich et al. 2003
<i>Echinogammarus warpachowskyi</i>	Grigorovich et al. 2003
<i>Obesogammarus crassus</i>	Ricciardi and Rasmussen 1998
<i>Pontogammarus aralensis</i>	Grigorovich et al. 2003
<i>Pontogammarus obesus</i>	Ricciardi and Rasmussen 1998
<i>Pontogammarus robustoides</i>	Ricciardi and Rasmussen 1998; Grigorovich et al. 2003
<b>Mysids</b>	
<i>Hemimysis anomala</i>	Ricciardi and Rasmussen 1998; Grigorovich et al. 2003
<i>Limnomysis benedeni</i>	Ricciardi and Rasmussen 1998
<i>Paramysis intermedia</i>	Ricciardi and Rasmussen 1998
<i>Paramysis lacustris</i>	Ricciardi and Rasmussen 1998
<i>Paramysis ullskyi</i>	Ricciardi and Rasmussen 1998
<b>Bivalves</b>	
<i>Hypanys (Monodacna) colorata</i>	Ricciardi and Rasmussen 1998
<b>Polychaetes</b>	
<i>Hypania invalida</i>	Ricciardi and Rasmussen 1998
<b>Plants</b>	
<i>Egeria densa</i>	Rixon et al. 2004
<i>Hygrophila polysperma</i>	Rixon et al. 2004
<i>Myriophyllum aquaticum</i>	Rixon et al. 2004

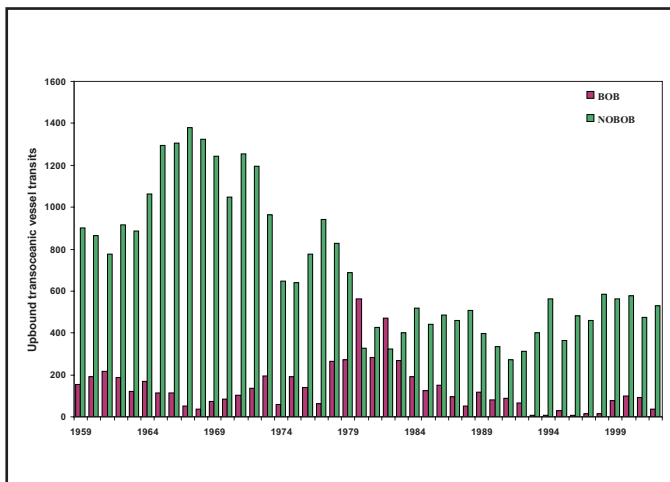
**Table 1.** Nonindigenous species predicted to have a high-risk of introduction to the Great Lakes.  
Source: Ricciardi and Rasmussen 1998; Kolar and Lodge 2002; Grigorovich et al. 2003; Rixon et al. 2004.



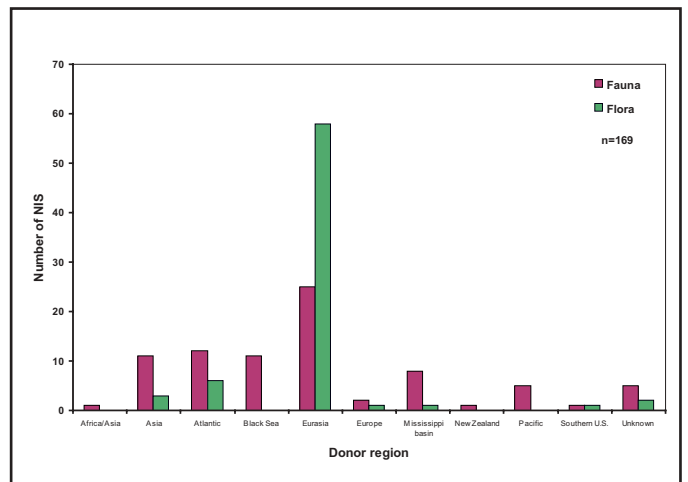
**Figure 1.** Release mechanisms for aquatic NIS established in the Great Lakes basin since the 1830s. Source: Mill et al. 1993; Ricciardi 2001; Grigorovich et al. 2003



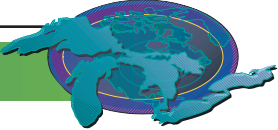
**Figure 3.** Numbers of upbound transoceanic vessels entering the Great Lakes from 1959 to 2002.

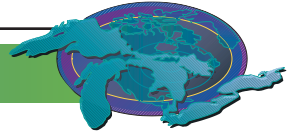


**Figure 2.** Cumulative number of aquatic NIS established in the Great Lakes basin since the 1830s attributed to (a) all vectors and (b) only the ship vector.



**Figure 4.** Regions of origin for aquatic NIS established in the Great Lakes basin since the 1830s. Source: Mill et al. 1993; Ricciardi 2001; Grigorovich et al. 2003





## State of the Great Lakes 2005 – Draft for Discussion

### Progress Towards Indicator Reporting

This section contains reports of four indicators:

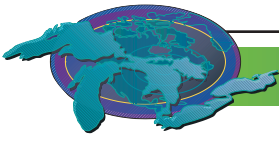
#7054 Ground Surface Hardening,

#8129 Area, Quality and Protection of Special Lakeshore Communities - Islands,

#8129 Area, Quality and Protection of Special Lakeshore Communities - Sand Dunes, and

#9002 Non-native Species - Terrestrial Component.

The above four reports have been placed in this section because the authors have prepared reports that are generally progress reports. The reports are state of information reports or they discuss anticipated plans and work being done in the near future to make progress towards state of ecosystem reporting.



## Ground Surface Hardening

SOLEC Indicator #7054

**Assessment:** Not assessed - the available information are incomplete, or outdated.

### Purpose

The purpose of this indicator is to indicate the degree to which development is affecting natural water drainage and percolation processes and thus causing erosion, and other effects through high water levels during storm events and reducing natural ground water regeneration processes. Ground surface hardening or imperviousness (the sum of area of roads, parking lots, sidewalks, roof tops and other impermeable surfaces of the urban landscape) is a useful indicator with which to measure the impacts of land development on aquatic systems (Center for Watershed Protection, 1994).

### Ecosystem Objectives

A goal for the ecosystem is sustainable development. This would entail minimizing the quantities of impervious surface by using alternatives for replacement and future development.

### State of the Ecosystem

Information on ground surface hardening in the Great Lakes basin is currently in the development stage. Different organizations are working towards developing effective systems of analyzing the status of this indicator. The use of technology such as Landsat imagery and Geographic Information Systems (GIS) applications are being utilized in efforts to evaluate the current state. The instruments on the Landsat satellites have acquired millions of images. These images form a unique resource for applications in agriculture, geology, forestry, regional planning, education, mapping, and global change research. This type of information will help illustrate the land use qualities of the Great Lakes basin.

In attempts to obtain information for this indicator many avenues were explored. Within Ontario, the Ontario Ministry of the Environment, conservation authorities and municipalities of different sizes were contacted for a random survey to see what information was available. Each organization had very little available information on impervious surfaces.

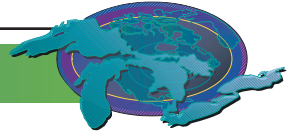
In the Great Lakes basin, data on ground surface hardening are rare. The Ministry of Natural Resources is in the process of implementing a project called Southern Ontario Land Resource Information System (SOLRIS). SOLRIS is a mapping program designed accurately measure the nature and extent of Southern Ontario's natural resources and will be used to track changes to the natural, rural and urban landscape (Mussakowski, 2004). SOLRIS integrates existing base resource information and advanced GIS and remote sensing techniques to derive a comprehensive land cover database. SOLRIS is attempting to complete the assembly of all layers into comprehensive land cover/use mapping by 2006 and will continue to upgrade on 5 or 10 year intervals.

Recently, Christopher Elvidge of the National Oceanic and Atmospheric Administration's National Geophysical Data Center in Boulder, Colorado, along with colleagues from several universities and agencies produced the first national map and inventory of impervious surface areas (ISA) in the United States. The new map is important, because impervious surface areas affect the environment. The qualities of impervious materials that make them ideal for construction also create urban heat islands, by reducing heat transfer from Earth's surface to the atmosphere. The replacement of heavily vegetated areas by ISA reduces the sequestration of carbon from the atmosphere (Elvidge, 2004).

### Pressures

Growth patterns in North America can be generalized, with few exceptions, as urban sprawl. As our cities continue to grow outwards there is a growing dependency on personal transportation. This creates a demand for more roads, parking lots and driveways. Impervious surfaces collect and accumulate pollutants deposited from the atmosphere, leaked from vehicles or derived from other sources. Imperviousness represents the imprint of land development on the landscape (Center for Watershed Protection, 1994).

A long-term, adverse impact to water quality could occur as a result of the continued and likely increase of nonpoint-source pollution discharge to stormwater runoff from roads, parking lots, and other impervious surfaces introduced into the area to accommodate visitor use. If parking lots, roads, and other impervious surfaces were established where none currently exist, then vehicle-related pollutants and refuse may accumulate. This impact could be mitigated to a negligible level through the use of permeable surfaces and



vegetated or natural filters or traps for filtering stormwater runoff (National Park Service, 2001).

#### **Management Implications**

Ground surface hardening is an important indicator in the Great Lakes basin that needs to be explored further. The information available for this indicator is incomplete, or outdated. With current technological advancements there are emerging methods of monitoring impervious surfaces, and hopefully within 5 years the data required for this report will be complete. Ground surface hardening has many detrimental effects on the environment; thus, it is essential to monitor and seek alternatives.

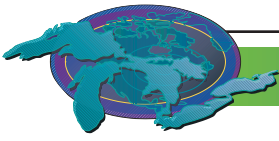
#### **Acknowledgements**

Lindsay Silk, Environment Canada, Downsview, Ontario

#### **Sources**

National Park Service, 2001. Merced Wild and Scenic River: Comprehensive Management Plan. <http://www.cwp.org/SPSP/TOC.htm>  
Center for Watershed Protection, 1994. *The Importance of Imperviousness*  
Chris Elvidge, 2004. National Oceanic and Atmospheric Administration.  
Mussakowski, R. 2004. Ontario Ministry of Natural Resources.





## Area, Quality, and Protection of Great Lakes Islands

SOLEC Indicator #8129 (Islands)

**Assessment:** Not Assessed

Indicator is under development. Data are not available.

### Purpose

This indicator assesses the status of islands, one of the 12 special lakeshore communities identified within the nearshore terrestrial area. There are over thirty thousand islands in the Great Lakes. The islands range in size from no bigger than a large boulder to the world's largest freshwater island, Manitoulin, and often form chains of islands known as archipelagos. Though not well known, the Great Lakes contain the world's largest freshwater island system, and are globally significant in terms of their biological diversity. Despite this, the state of our knowledge about them as a collection is quite poor.

### Ecosystem Objective

To assess the changes in area and quality of Great Lakes islands individually, and as an ecologically important system; to infer the success of management activities; and to focus future conservation efforts toward the most ecologically significant island habitats in the Great Lakes.

### State of the Ecosystem

By their very nature, islands are vulnerable and sensitive to change. As water levels rise and fall, islands are exposed to the forces of erosion and accretion. Islands are exposed to weather events due to their 360-degree exposure to the elements across the open water. Isolated for perhaps tens of thousands of years from the mainland, islands in the past rarely gained new species, and some of their resident species evolved into endemics that differed from mainland varieties. This means that islands are especially vulnerable to the introduction of non-native species, and can only support a fraction of the number of species of a comparable mainland area.

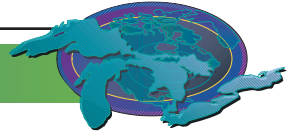
Some of the Great Lakes islands are among the last remaining wildlands on Earth. Islands must be considered as a single irreplaceable resource and protected as a whole if the high value of this natural heritage is to be maintained. Islands play a particularly important role in the "storehouse" of Great Lakes coastal biodiversity. For example, Michigan's 600 Great Lakes islands contain one-tenth of the state's threatened, endangered, or rare species while representing only one-hundredth of the land area. All of Michigan's threatened, endangered, or rare coastal species occur at least in part on its islands. The natural features of particular importance on Great Lakes islands are colonial waterbirds, nearctic-neotropical migrant songbirds, endemic plants, arctic disjuncts, endangered species, fish spawning and nursery use of associated shoals and reefs and other aquatic habitat, marshes, alvar, coastal barrier systems, sheltered embayments, nearshore bedrock mosaic, and sand dunes. New research indicates that nearshore island areas in the Ontario waters of Lake Huron account for 58 percent of the fish spawning and nursery habitat and thus are critically important to the Great Lakes fishery.

### Pressures

By their very nature, islands are more sensitive to human influence than the mainland and need special protection to conserve their natural values. Proposals to develop islands are increasing. This is occurring before we have the scientific information about sustainable use to evaluate, prioritize, and make appropriate natural resource decisions on islands. Island stressors include development, invasive species, shoreline modification, marina and air strip development, agriculture and forestry practices, recreational use, navigation/shipping practices, wastewater discharge, mining practices, drainage or diversion systems, overpopulation of certain species such as deer, industrial discharge, development of roads or utilities, abandoned landfills, and disruption of natural disturbance regimes.

### Management Implications

Based on the results of assessments of island values, biological significance, categorization, and ranking, the Great Lakes Islands Collaborative will soon recommend management strategies on Great Lakes Islands to preserve the unique ecological features that make islands so important. In addition, based on a proposed threat assessment to be completed in 2005, the Collaborative will recommend management strategies to reduce the pressures on a set of priority island areas.



### Further Work Necessary

The Great Lakes islands provide a unique opportunity to protect a resource of global importance because many islands still remain intact. The U.S. Fish and Wildlife Service's Great Lakes Basin Ecosystem Team (GLBET) has taken on the charge of providing leadership to coordinate and improve the protection and management of the islands of the Great Lakes. The GLBET island initiative includes the coordination and compilation of island geospatial data and information, developing standardized survey/monitoring protocols, holding an island workshop in the fall of 2002 to incorporate input from partners for addressing the SOLEC Island Indicator needs, and completion of a Great Lakes Island Conservation Strategic Plan.

A subset of the GLBET formed the Binational Collaborative for the Conservation of Great Lakes Islands, lead by Dr. Karen Vigmostad of the Northeast-Midwest Institute. Recently, the Collaborative received a habitat grant from the Environmental Protection Agency's Great Lakes National Program Office (GLNPO) to develop a framework for the binational conservation of Great Lakes islands. With this funding, the Team is developing:

- 1) An island biodiversity assessment and ranking system (based on a subset of biodiversity parameters) that will provide a foundation to prioritize island conservation
- 2) A freshwater island classification system
- 3) A suite of indicators that can be monitored to assess change, threats, and progress towards conservation of Great Lakes islands biodiversity

To date, the Collaborative has tentatively proposed ten condition, five pressure, and two response indicators. We anticipate developing additional response indicators and may be able to incorporate existing SOLEC response indicators. The island indicators are still being evaluated and are not final. Final selection of indicators will take place after peer review and discussions at SOLEC 2004, and will be based on relevance, feasibility, response variability, and interpretation and utility.

A proposed second year of GLNPO funding would allow the Collaborative to complete a threats assessment, identify island biodiversity investment areas, publish an atlas of the biodiversity of Great Lakes Islands, complete an island policy assessment, distribute a draft Great Lakes Islands Conservation Action plan, and develop an e-resource library on islands.

The information conveyed by a science-based suite of island indicators will help to focus attention and management efforts to best conserve these unique and globally significant Great Lakes resources.

### Acknowledgments

Richard H. Greenwood, U.S. Fish and Wildlife Service, Great Lakes Basin Ecosystem Team Leader and Liaison to U.S. Environmental Protection Agency-Great Lakes National Program Office, Chicago, IL

Dr. Karen E. Vigmostad, Great Lakes Policy Analyst Ecosystem Team, Northeast-Midwest Institute, Washington, DC

Megan M. Seymour, Wildlife Biologist, U.S. Fish and Wildlife Service, Great Lakes Basin Ecosystem Team Island Committee Chair, Ecological Services Field Office, Reynoldsburg, OH

Dr. Francesca Cuthbert, Dept. of Fisheries, Wildlife, and Conservation Biology, University of Minnesota, St. Paul, MN

Dr. David Ewert, Director of Conservation Science, Great Lakes Program, Nature Conservancy, Lansing, MI.

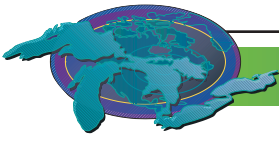
Dan Kraus, Coordinator of Conservation Science, Ontario Region of Nature Conservancy of Canada, Guelph, ON

Linda R. Wires, Research Associate, Dept. of Fisheries, Wildlife, and Conservation Biology, University of Minnesota, St. Paul, MN

### Sources

Dr. Karen E. Vigmostad, Great Lakes Policy Analyst, Northeast-Midwest Institute, Washington, DC. 20003 Ph: 202-464-4016, Email: [kvigmostad@nemw.org](mailto:kvigmostad@nemw.org)

Dr. Judy Soulé, Director, U.S. Network Partnerships, Nature Serve, East Lansing, MI, Ph: 517-381-5310, Email: [judy\\_soule@nature-](mailto:judy_soule@nature-)



[serve.org](http://serve.org)

Susan Crispin, Director, Montana Natural Heritage Program, Helena, MT, Ph: 406-444-5434, Email: [scrispin@state.mt.us](mailto:scrispin@state.mt.us)

Bruce Manny and Greg Kennedy, U.S. Geological Survey, Great Lakes Science Center, 1451 Green Road Ann Arbor, MI 48105-2807 Ph: 734-214-7213, Email: [bruce\\_manny@usgs.gov](mailto:bruce_manny@usgs.gov) or [gregory\\_kennedy@usgs.gov](mailto:gregory_kennedy@usgs.gov)

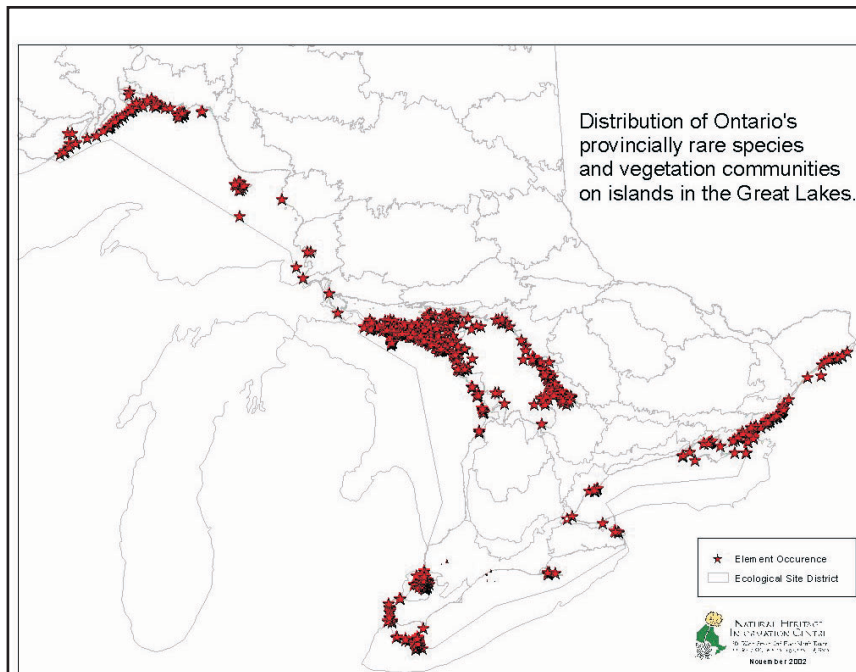


Figure 1: Distribution of Ontario's provincially rare species and vegetation communities on islands in the Great Lakes. Source: Ontario Natural Heritage Information Centre, March 2003



## Area, Quality and Protection of Great Lakes Sand Dunes

SOLEC Indicator #8129

**Assessment:** Mixed Deteriorating

### Purpose

To assess the extent and quality of Great Lakes sand dunes.

### Ecosystem Objective

Maintain total areal extent and quality of Great Lakes sand dunes, ensuring adequate representation of sand dune types across their historical range.

### State of the Ecosystem

Sand dunes continue to be lost and degraded, yet the ability to track and determine the extent and rate of this loss in terms of both area and quality in a standardized way is not yet feasible.

Great Lakes sand dunes comprise the world's largest collection of freshwater dunes. They are home to endemic, rare, endangered, and threatened species. Sand dunes can be found along the coasts of all the Great Lakes. Lake Michigan, however, has the greatest number of sand dunes with a total of 111,291 hectares, followed by Ontario with 8,910 hectares, Indiana with 6,070 hectares, New York with 4,850 hectares, and Wisconsin with 425 hectares. This information is not complete. No comprehensive map of Great Lakes sand dunes exists.

Degree of protection varies considerably among jurisdictions so it is difficult to assess the overall loss or status of sand dunes because although information about the quality of individual sand dunes is locally available, this information has not been collected across the entire basin. Nevertheless, conversations with local managers and environmentalists indicate a continued loss of sand dunes to development, sand mining, recreational trampling, and non-indigenous invasive species. The Lake Ontario Dunes Coalition, Michigan Dunes Alliance, and the Save the Dunes Council in Indiana are making some progress in both protecting and restoring sand dunes in their respective regions.

### Pressures on the Ecosystem

Threats to sand dunes are numerous. Non-indigenous invasive species such as baby's breath (*Gypsophila paniculata*) and spotted knapweed (*Centaurea maculosa*) tend to spread rapidly if not controlled. Habitat destruction, however, is the greatest threat. In addition to sand mining, shoreline condominium and second home development level dunes. And recreational use by pedestrians and off road vehicle use destroys vegetation, thereby causing dune erosion.

### Management Implications

Many actions have been taken to protect Great Lakes sand dunes. For example, in Eastern Lake Ontario boardwalks and dune walkovers have been constructed to provide public access to beaches without compromising dune ecology. Native beach grasses have been planted to retard erosion. On the eastern shores of Lake Michigan, invasive plants have been systematically removed by dune stewards. Michigan has legislation in place to control or reduce sand mining impacts.

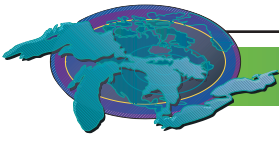
In order to protect sand dunes there is a need for improved communication between government agencies and stakeholders with regard to sand dune management. Public education would help alleviate stress to dunes cause by recreational trampling. Stronger legislation could limit some damaging activities. Local government creativity in managing dune areas through creative zoning would improve the protection of sensitive and irreplaceable areas.

### Acknowledgments

Author: Lindsay Silk, Environment Canada, Downsview, Ontario

### Sources

Bonanno, S. (1998). The Nature Conservancy.  
Byrne, M.-L. (2004). Personal communication.  
Cabala, T. (2004). Personal communication.



Environment Canada and the U.S. Environmental Protection Agency (1997). *State of the Great Lakes 1997*.

Lewis, J. (1975). Michigan Geological Survey Division Circular (#11). Retrieved on April 6, 2004. From:

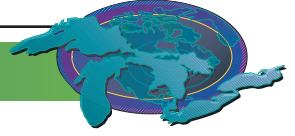
Michigan Department of Environmental Quality (2004). Retrieved on April 6, 2004. From: 1607,7-135-3311\_4114\_4235—,00.html

U.S. Environmental Protection Agency (2002). Protecting and Restoring Great Lakes Sand Dunes. Retrieved on March 29, 2004.

From: html

#### **Further Work Necessary**

A group of sand dune managers and scientists is organizing to convene a conference for all persons involved in Great Lakes sand dune ecosystem ecology, management, research and education efforts. The purposes of the conference will be to compile information about sand dunes and sand dune research and management and to form the Great Lakes Sand Dunes Coalition. This group could work actively to collect available data about Great Lakes sand dunes and begin collaborative actions to protect them.



## Terrestrial Non-Native Species

SOLEC Indicator #9002

### Assessment: Unknown

Data from multiple sources not consistent

### Purpose

This indicator reports the extent of cover by terrestrial non-native species (including plants, animals and other organisms, such as insects and microbes) in the Great Lakes watershed, and assesses the biological integrity of the basin ecosystem.

### Ecosystem Objective

Only a small percentage of non-native species introduced into the ecosystem, primarily through human activity, pose a hazard to the economy, environment or human health. However, the lack of naturally-occurring predators allows some non-native species to become invasive by colonizing and proliferating unchecked. This destroys wildlife habitats, crowds out competitors and depletes prey, thereby threatening biodiversity.

Once established, terrestrial non-native species can also impact water quality, by changing water tables, runoff dynamics, fire frequency, and other watershed attributes that in turn can alter watershed conditions. Attempts to eradicate terrestrial non-native species could lead to greater use of pesticides and herbicides, in turn potentially increasing the amount of chemicals entering surface water through runoff.

### State of the Ecosystem

The negative impact of a wide range of non-native species, such as reed canary grass, garlic mustard, common buckthorn and purple loosestrife, has been documented throughout the Great Lakes basin. However, the extent of invasion by terrestrial non-native species is not known. It is not clear what metric should be used to report on this indicator.

Federal and state agencies, tribal governments, nongovernmental organizations, and universities are actively collecting data on terrestrial non-native species. At this point, most projects focus on a single species on a local basis. Projects range from mapping where non-native species have been detected in a given jurisdiction, to measuring the actual population or extent of area covered by that species. This large body of research presents an opportunity to increase our understanding of the problem posed by terrestrial non-native species. Coordination of these data collection efforts may produce the comprehensive data necessary for assessment, not to mention monitoring, control and eradication.

### Future Pressures

Growth in international trade and travel increases the risk that a larger number of terrestrial non-native species will become established in the Great Lakes region. The spread of microbes such as the West Nile virus and the SARS virus demonstrates the speed and ease in which non-native species can migrate on a global basis. Response efforts vary by species. It is believed that terrestrial non-native species that do not pose an immediate threat to agriculture, industry or human health may not prompt sufficient response to mitigate their impacts to the ecosystem.

### Acknowledgments

Author: Mervyn Han, ECO Federal Government Associate on contact to U.S. EPA-GLNPO.





## State of the Great Lakes 2005 – Draft for Discussion

### Acknowledgments

The *State of the Great Lakes 2005* preparation team included:

#### **Environment Canada**

Nancy Stadler-Salt, lead  
Stacey Cherwaty  
Susan Arndt  
Harvey Shear

#### **United States Environmental Protection Agency**

Paul Bertram, lead  
Jackie Adams  
Karen Rodriguez  
Leena Gawri  
Yamille Cirino  
Paul Horvatin

This report contains contributions from dozens of authors and contributors to the indicator reports and the Lake and River assessments, and their work is sincerely appreciated. Their voluntary time and effort to collect, assess and report on conditions of the Great Lakes ecosystem components reflects their dedication and professional cooperation. Individual authors and contributors are recognized at the end of their respective report component.

Many governmental and non-governmental sectors were represented by authors and contributors. We recognize the participation of the following organizations. While we have tried to be thorough, any misrepresentation or oversight is entirely unintentional, and we sincerely regret any omissions. [Details under each heading to be determined]

#### **Federal**

#### **Provincial and State**

#### **Municipal**

#### **Aboriginal**

#### **Academic**

#### **Coalitions**

#### **Commissions**

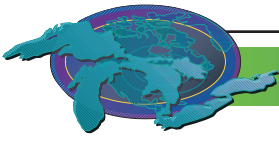
#### **Environmental Non-Government Organizations**

#### **Industry**

#### **Private Organizations**

#### **Private Citizens**

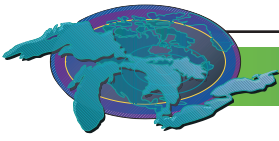






## Appendix 1. Complete Table of Indicators in Suite, Organized by Bundles.

ID #	Indicator Name	2005 Assessment (Status, Direction)	2003 Assessment	2001 Assessment
<b>CONTAMINATION</b>				
<b>Nutrients</b>				
111	Phosphorus Concentrations and Loadings	Mixed, Undetermined	Mixed	Mixed
4860	<i>Phosphorus and Nitrogen Levels (Coastal Wetlands)</i>			
7061	Nutrient Management Plans	(2002 report)	No Assessment	
<b>Toxics in Biota</b>				
114	Contaminants in Young-of-the-Year Spottail Shiners	Mixed, Improving	Mixed Improving	
115	Contaminants in Colonial Nesting Waterbirds	Mixed, Improving	Mixed Improving	Good
121	Contaminants in Whole Fish	Mixed, Improving	No Assessment	
124	External Anomaly Prevalence Index for Nearshore Fish	Mixed, Undetermined	No Assessment	
4177	Biologic Markers of Human Exposure to Persistent Chemicals	Mixed, Undetermined		
4201	Contaminants in Sport Fish	Mixed, Improving	Mixed Improving (#4083)	Mixed Improving (#4083)
4506	Contaminants in Snapping Turtle Eggs	Mixed, N/A	Mixed	Mixed
8135	Contaminants Affecting Productivity of Bald Eagles	Mixed, Improving	Mixed Improving	Mixed Improving
8147	Contaminants Affecting the American Otter	(2002 report)	Mixed	No Assessment
<b>Toxics in Media</b>				
117	Atmospheric Deposition of Toxic Chemicals	Mixed, Improving & Mixed, Unchanging	Mixed	Mixed Improving
118	Toxic Chemical Concentrations in Offshore Waters	Mixed, Improving	Mixed Improving	Mixed
119	Concentrations of Contaminants in Sediment Cores	Mixed, Improving	Mixed Improving	
4175	Drinking Water Quality	Good, Unchanging	Good	Good
4202	Air Quality	Mixed, Improving	Mixed	Mixed
9000	Acid Rain	Mixed, Improving	Mixed Improving	Mixed
<b>Sources and Loadings</b>				
117	Atmospheric Deposition of Toxic Chemicals	Mixed, Improving & Mixed, Unchanging	Mixed	Mixed Improving
4202	Air Quality	Mixed, Improving	Mixed	Mixed
9000	Acid Rain	Mixed, Improving	Mixed Improving	Mixed
<b>BIOTIC COMMUNITIES</b>				
<b>Fish</b>				
8	Salmon and Trout	Mixed, Improving	Mixed	
9	Walleye	Good, Unchanging	Mixed	Good
17	Preyfish Populations	Mixed, Deteriorating Mixed, Improving	Mixed Deteriorating	Mixed Improving
93	Lake Trout	Mixed, Improving & Mixed, Unchanging	Mixed	Mixed
125	Status of Lake Sturgeon in the Great Lakes	Mixed, Undetermined	No Assessment	
4502	Coastal Wetland Fish Community Health	No Assessment		
<b>Birds</b>				
115	Contaminants in Colonial Nesting Waterbirds	Mixed, Improving	Mixed Improving	Good
4507	Wetland-Dependent Bird Diversity and Abundance	Mixed, Deteriorating	Mixed Deteriorating	Mixed Deteriorating
8135	Contaminants Affecting Productivity of Bald Eagles	Mixed, Improving	Mixed Improving	Mixed Improving
8150	<i>Breeding Bird Diversity and Abundance</i>			

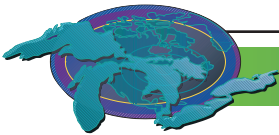


# STATE OF THE GREAT LAKES 2005-DRAFT

<b>Mammals</b>				
8147	Contaminants Affecting the American Otter	(2002 report)	Mixed	No Assessment
<b>Amphibians</b>				
4504	Coastal Wetland Amphibian Diversity and Abundance	Mixed, Deteriorating	Mixed Deteriorating	Mixed Deteriorating
7103	Groundwater Dependant Plant and Animal Communities	No Assessment		
<b>Invertebrates</b>				
68	Native Freshwater Mussels	No Assessment	No Assessment	Mixed Deteriorating
104	Benthos Diversity and Abundance	(2002 report)	Mixed	
116	Zooplankton Populations	(2002 report)	No Assessment	Mixed
122	Hexagenia	Mixed, Improving	Mixed Improving	Mixed Improving
123	Abundances of the Benthic Amphipod <i>Diporeia</i>	Mixed, Deteriorating	Mixed Deteriorating	Mixed
4501	Coastal Wetland Invertebrate Community Health	No Assessment		
<b>Plants</b>				
109	Phytoplankton Populations	(2002 report)	No Assessment	Mixed
4862	Coastal Wetland Plant Community Health	Mixed, Deteriorating Mixed, Improving		
8162	<i>Health of Terrestrial Plant Communities</i>			
8500	Forest Lands - Conservation of Biological Diversity	Mixed, Improving		
<b>General</b>				
8114	<i>Habitat Fragmentation</i>			
8137	<i>Nearshore Species Diversity and Stability</i>			
8161	<i>Threatened Species</i>			
8163	<i>Status and Protection of Special Places and Species</i>			
<b>INVASIVE SPECIES</b>				
<b>Aquatic</b>				
18	Sea Lamprey	Good-Fair, Improving	Mixed Improving	Mixed
9002	Non-Native Species (Aquatic)	Poor, Deteriorating	Poor	Poor
<b>Terrestrial</b>				
9002	<i>Non-Native Species (Terrestrial)</i>			
<b>COASTAL ZONES</b>				
<b>Nearshore Aquatic</b>				
6	<i>Fish Habitat</i>			
4860	<i>Phosphorus and Nitrogen Levels (Coastal Wetlands)</i>			
4861	Effect of Water Levels Fluctuations	(2002 report)	Mixed	Mixed Deteriorating
4864	<i>Human Impact Measures (Coastal Wetlands)</i>			
8131	Extent of Hardened Shoreline	(2000 report)	(2000 report)	Mixed Deteriorating
8142	<i>Sediment Available for Coastal Nourishment</i>			
8146	<i>Artificial Coastal Structures</i>			
<b>Coastal Wetlands</b>				
4501	Coastal Wetland Invertebrate Community Health	No Assessment		
4502	Coastal Wetland Fish Community Health	No Assessment		
4504	Coastal Wetland Amphibian Diversity and Abundance	Mixed, Deteriorating	Mixed Deteriorating	Mixed Deteriorating
4506	Contaminants in Snapping Turtle Eggs	Mixed, N/A	Mixed	Mixed
4507	Wetland-Dependent Bird Diversity and Abundance	Mixed, Deteriorating	Mixed Deteriorating	Mixed Deteriorating
4510	Coastal Wetland Area by Type	Mixed, Deteriorating		Mixed Deteriorating
4511	<i>Coastal Wetland Restored Area by Type</i>			



4516	<i>Sediment Flowing into Coastal Wetlands</i>			
4860	<i>Phosphorus and Nitrogen Levels</i>			
4861	Effects of Water Levels Fluctuations	(2002 report)	Mixed	Mixed Deteriorating
4862	Coastal Wetland Plant Community Health	Mixed, Deteriorating Mixed, Improving		
4863	<i>Land Use Adjacent to Wetlands</i>			
4864	<i>Human Impact Measures</i>			
8142	<i>Sediment Available for Coastal Nourishment</i>			
<b>Terrestrial</b>				
4861	Effects of Water Levels Fluctuations	(2002 report)	Mixed	Mixed Deteriorating
4864	<i>Human Impact Measures (Coastal Wetlands)</i>			
8129	Area, Quality, and Protection of Special Lakeshore Communities - Alvars	(2000 report)	(2000 report)	Mixed
8129	<i>Area, Quality, and Protection of Special Lakeshore Communities - Islands</i>			
8129	Area, Quality, and Protection of Special Lakeshore Communities - Cobble Beaches	Mixed, Deteriorating		
8129	<i>Area, Quality, and Protection of Special Lakeshore Communities - Sand Dunes</i>			
8131	Extent of Hardened Shoreline	(2000 report)	(2000 report)	Mixed Deteriorating
8132	<i>Nearshore Land Use</i>			
8136	<i>Extent and Quality of Nearshore Natural Land Cover</i>			
8137	<i>Nearshore Species Diversity and Stability</i>			
8142	<i>Sediment Available for Coastal Nourishment</i>			
8149	<i>Protected Nearshore Areas</i>			
<b>AQUATIC HABITATS</b>				
<b>Open Lake</b>				
6	<i>Fish Habitat</i>			
111	Phosphorus Concentrations and Loadings	Mixed	Mixed	Mixed
118	Toxic Chemical Concentrations in Offshore Waters	Mixed, Improving	Mixed Improving	Mixed
119	Concentrations of Contaminants in Sediment Cores	Mixed, Improving	Mixed Improving	
8131	Extent of Hardened Shoreline	(2000 report)	(2000 report)	Mixed Deteriorating
8142	<i>Sediment Available for Coastal Nourishment</i>			
8146	<i>Artificial Coastal Structures</i>			
<b>Groundwater</b>				
7100	Natural Groundwater Quality and Human-Induced Changes	No Assessment	No Assessment	
7101	Groundwater and Land: Use and Intensity	No Assessment	No Assessment	
7102	Base Flow Due to Groundwater Discharge	Mixed, Deteriorating	No Assessment	
7103	Groundwater Dependant Animal and Plant Communities	No Assessment		
<b>HUMAN HEALTH</b>				
4175	Drinking Water Quality	Good, Unchanging	Good	Good
4177	Biologic Markers of Human Exposure to Persistent Chemicals	Mixed, Undetermined		
4179	<i>Geographic Patterns and Trends in Disease Incidence</i>			
4200	Beach Advisories, Postings and Closures	Mixed, Undetermined	Mixed (#4081)	Mixed (#4081)



STATE OF THE GREAT LAKES 2005-DRAFT

4201	Contaminants in Sport Fish	Mixed, Improving	Mixed Improving (#4083)	Mixed Improving (#4083)
4202	Air Quality	Mixed, Improving	Mixed (#4176)	Mixed (#4176)
<b>LAND USE - LAND COVER</b>				
<b>General</b>				
4863	<i>Land Use Adjacent to Wetlands (Coastal Wetlands)</i>			
7002	Land Cover - Land Conversion	No Assessment		
7101	Groundwater and Land: Use and Intensity	No Assessment		
8114	<i>Habitat Fragmentation</i>			
8132	<i>Nearshore Land Use</i>			
8136	<i>Extent and Quality of Nearshore Natural Land Cover</i>			
<b>Forest Lands</b>				
8500	Forest Lands-Conservation of Biological Diversity	Mixed, Improving		
8501	<i>Maintenance and Productive Capacity of Forest Ecosystems</i>			
8502	<i>Maintenance of Forest Ecosystem Health and Vitality</i>			
8503	<i>Forest Lands-Conservation &amp; Maintenance of Soil &amp; Water Resources</i>			
<b>Agricultural Lands</b>				
7028	Sustainable Agriculture Practices	(2002 report)	No Assessment	Mixed
7061	Nutrient Management	(2002 report)		
7062	Integrated Pest Management	(2002 report)		
<b>Urban/Suburban Lands</b>				
7000	Urban Density	Mixed, N/A	Mixed Deteriorating	Unable to Assess
7006	Brownfield Redevelopment	(2002 report)	Mixed Improving	Mixed Improving
7054	<i>Ground Surface Hardening</i>			
<b>Protected Areas</b>				
8129	Area, Quality, and Protection of Special Lakeshore Communities - Cobble Beaches	Mixed, Deteriorating		
8129	Area, Quality, and Protection of Special Lakeshore Communities - Alvars	(2000 report)	(2000 report)	Mixed
8129	<i>Area, Quality, and Protection of Special Lakeshore Communities - Islands</i>			
8129	<i>Area, Quality, and Protection of Special Lakeshore Communities - Sand dunes</i>			
8149	<i>Protected Nearshore Areas</i>			
8163	<i>Status and Protection of Special Places and Species</i>			
<b>RESOURCE UTILIZATION</b>				
3514	Commercial/Industrial Eco-Efficiency	(2002 report)	No Assessment	
3516	<i>Household Stormwater Recycling</i>			
7043	Economic Prosperity	(2002 report)	Mixed	Mixed
7056	Water Withdrawal	Mixed, Unchanging		
7057	Energy Consumption	Mixed, N/A	Mixed Deteriorating	
7060	Solid Waste Generation	(2002 report)	Mixed	
7064	<i>Vehicle Use</i>			
<b>CLIMATE CHANGE</b>				
4858	Climate Change: Ice Duration on the Great Lakes	(2002 report)	Mixed Deteriorating	
9003	<i>Climate Change: Effect on Crop Heat Units</i>			