



**The Calumet Area  
Hazardous Substance  
Data Base: A User's Guide  
With Documentation**

**Ted B. Samsel  
Craig E. Colten**

**Illinois State Museum**

## **About WMRC's Electronic Publications:**

This document was originally published in a traditional format.

It has been transferred to an electronic format to allow faster and broader access to important information and data.

While the Center makes every effort to maintain a level of quality during the transfer from print to digital format, it is possible that minor formatting and typographical inconsistencies will still exist in this document.

Additionally, due to the constraints of the electronic format chosen, page numbering will vary slightly from the original document.

The original, printed version of this document may still be available.

Please contact WMRC for more information:

**WMRC**  
**One E. Hazelwood Drive**  
**Champaign, IL 61820**  
**217-333-8940 (phone)**

**[www.wmrc.uiuc.edu](http://www.wmrc.uiuc.edu)**

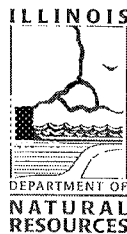

WMRC is a division of the  
Illinois Department of Natural  
Resources

THE CALUMET AREA HAZARDOUS  
SUBSTANCE DATA BASE:  
A USER'S GUIDE WITH DOCUMENTATION

by

Ted B. Samsel  
Research Assistant

Craig E. Colten, Principal Investigator

Illinois State Museum  
Springfield, Illinois 62706

Prepared for  
The Illinois Hazardous Waste Research and Information Center  
HWRIC Project HWR88/89-055

Reprinted February 1992

Printed by Authority of the State of Illinois 90/200

This report is part of HWRIC's Research Report Series and as such has been subject to the Center's external scientific peer review. Mention of trade names or commercial products does not constitute endorsement or recommendation for use.

## ACKNOWLEDGEMENTS

The researchers wish to extend their thanks to the agencies and individuals who contributed to the completion of this report. At the United States Environmental Protection Agency (USEPA) Washington Headquarters, Tony Jover supplied the SARA/Title III List of Lists, at USEPA Region 6 in Dallas, Texas, Bob Clark provided proprietary information concerning the List of Lists, and in Chicago at USEPA Region 5, Alan Altur supplied the CERCLA site files. Another federal agency that deserves our thanks is the National Oceanic and Atmospheric Administration's Hazardous Materials Response Branch in Seattle for assistance in locating information on commercial hazardous material data bases.

Illinois agencies which assisted in this project include the Office of the State Fire Marshal, the Illinois Environmental Protection Agency (IEPA), the Illinois State Water Survey (ISWS), the Illinois Natural History Survey (INHS), the Illinois Department of Conservation (IDOC), the Illinois State Library, and the Illinois State Archives. Special gratitude is extended to Joe Goodner, Rachel Carlson, and Jeff Lampe of the IEPA's Office of Chemical Safety for providing data from the Community Right-to-Know data base; to Jack Moore and Jane Squires of the Office of the State Fire Marshal for giving us Underground Storage Tank Registry data for the study area; to Marvin Hubble of IDOC for providing documentation on the Illinois portion of the National Wetlands Inventory; to Lance Perry previously with Hazardous Waste Research and Information Center and now with the Wisconsin Department of Natural Resources for providing basic coverage data at the beginning of the project; to Tim Johnson at the Illinois Department of Energy and Natural Resources; to Dawn McWha of the Illinois Natural History Survey for providing technical expertise in ARC/INFO; to Arlyn Sherwood at the Illinois State Library; and to Chuck Cali at the Illinois State Archives.

Other individuals who made contributions include Nancy Tofte of the Teale Data Center in Sacramento, California, and John Laumer of the National Safety Council in Chicago. Timothy J. Osburn crafted several illustrations and shared his desktop publishing expertise, Nick Klobuchar served as a critical advisor in computing matters, and Ray Druhot guided our efforts with the geographic information system.



# CONTENTS

ACKNOWLEDGEMENTS . . . . .	iii
FIGURES . . . . .	vi
ABSTRACT . . . . .	vii
EXECUTIVE SUMMARY . . . . .	ix
CHAPTER 1. INTRODUCTION . . . . .	1
1.1 Rationale for a Lake Calumet Area Data Base . . . . .	1
1.2 Data Acquisition and Refinement . . . . .	3
1.2.1 Data Acquisition . . . . .	3
1.2.2 Data Refinement . . . . .	7
1.2.3 Data Base Limitations . . . . .	8
1.3 Data Base Introduction . . . . .	10
CHAPTER 2. DATA BASE DESCRIPTION . . . . .	11
2.1 Introduction . . . . .	11
2.2 Data Base Accessibility . . . . .	11
2.3 Data Base Structure . . . . .	11
2.3.1 SYSCOVDE.DBF . . . . .	16
2.3.2 SYSCOVDE.DBF Fields . . . . .	16
2.4 Coverages . . . . .	17
2.4.1 Information Coverages . . . . .	17
2.4.2 Utility Coverages . . . . .	28
2.4.3 Utility Files . . . . .	28
2.4.4 RELATE Files . . . . .	29
CHAPTER 3. USE OF COVERAGES IN SEARCHES . . . . .	31
3.1 Search Examples . . . . .	31
3.1.1 Cadmium and Lead in CERCLA Sites . . . . .	31
3.1.2 Underground Storage Tanks Containing Diesel Fuel . . . . .	34
3.2 Search Limitations . . . . .	34
3.3 Other Search Strategies . . . . .	37
3.3.1 Searching a Geographic Subset . . . . .	37
3.3.2 Extracting Text File Information . . . . .	37
GLOSSARY . . . . .	41
APPENDIX A . . . . .	43
REFERENCES CITED . . . . .	47



## FIGURES

Figure 1.1. Study Area . . . . .	2
Figure 1.2. Acquisition, Refinement, and Computer Entry of Project Data . . . . .	4
Figure 1.3. Calumet Database Coverages . . . . .	5
Figure 2.1. Workspace Path Names . . . . .	12
Figure 2.2. Calumet Workspace Elements . . . . .	13
Figure 2.3. Relate Process . . . . .	14
Figure 2.4. Structure of DBASEIII file SYSCOVDE.dbf . . . . .	15
Figure 2.5. Site Types . . . . .	21
Figure 3.1. Cadmium and Lead Search Procedure . . . . .	32
Figure 3.2. Plot of Results of Search for CERCLA sites containing Cadmium and Lead . . . . .	33
Figure 3.3. Underground Storage Tanks Containing Diesel Fuel Search Procedure . . . . .	35
Figure 3.4. Plot of Underground Storage Tanks Containing Diesel Fuel Search . . . . .	36
Figure 3.5. Interactive MAPEXTENT (*) Search Procedure . . . . .	38
Figure 3.6. Plot of Interactive MAPEXTENT (*) Search . . . . .	39

## ABSTRACT

The Lake Calumet area of southeast Chicago has a lengthy history of hazardous materials-handling activity. Illinois State Museum staff consulted numerous sources and reviewed their contents to compile and produce an electronic data base which will enable researchers to determine where and when particular types of hazardous materials and related activity occurred at specific sites.

Archival records, regulatory files, and other sources collected by Museum staff contributed information to the data base. Once collected, the information was formatted for entry into the Illinois Geographic Information System (IGIS)--a computer system that enables the geographic and tabular data to be combined, recombined, and analyzed. Through commands on a terminal, users may conduct searches of the computerized data base to obtain information for various chemical contaminants, industrial waste disposal activity, or information related to selected parcels of real estate.

This report provides instructions for the use of this system by the experienced ARC/INFO user, a summary of the data acquisition and entry procedures, and synopses of each data set.



## EXECUTIVE SUMMARY

Over the past 150 years, the Lake Calumet area of southeast Chicago has experienced large-scale industrial growth and decline. During the ascendancy of manufacturing activity these enterprises and their accompanying factory towns greatly modified the marshes and ridges paralleling Lake Michigan. Throughout its industrial history, the Lake Calumet area wetlands served as repositories for a variety of industrial and municipal wastes, and some of these wastes are considered hazardous by current standards. A considerable historical record for the area exists, providing sources that document hazardous material-handling activity.

The historical record provided information to develop an electronic data base that would assist in research efforts to assess the extent of environmental contamination around Lake Calumet caused by hazardous material-handling activities. This data base is contained in the Illinois Geographic Information System and consists of electronically stored spatial information (ARC coverages) and tabular data (INFO files). The computer program or software (ARC/INFO) allows the researcher to execute various search strategies by selecting portions of individual data sets and displaying graphic or text information on either a computer terminal or in printed form.

The acquisition of individual data sets, their refinement and entry into the GIS as coverages made up the largest portion of this project. The diversity of original information sources and the disparity among the various purposes for which they were collected created challenges in assembling a data base that contains compatible components. Users are advised to consult the sources for discussions of the original data and any inherent limitations.



# CHAPTER 1. INTRODUCTION

## 1.1 Rationale for a Lake Calumet Area Data Base

The extensive modification of the Lake Calumet area by industrial activity since the 1860s has resulted in one of Illinois' most concentrated zones of hazardous material handling and disposal. Historical documentation of a portion of these activities and current environmental analyses conducted by government agencies and independent researchers assist in comprehending the extent of contamination in the Lake Calumet area. The accessibility and structures of these data sets vary greatly, posing problems for individuals and agencies that must work with them. Ineffective archival policies, incompatible measurements and definitions, and distinct computer formats hinder efficient use of these important records. The Illinois Hazardous Waste Research and Information Center (HWRIC) sought to inventory and collect all material that chronicled hazardous material handling in the study area and to assemble it as a computerized data base for use by a wide spectrum of users.

The Lake Calumet area of southeast Chicago provides an excellent case study for developing a summary data base. Located about 12 miles south of Chicago's central business district (Fig. 1.1), it covers approximately 50 square miles. For more than a century, this area contained many large-scale manufacturers that handled hazardous materials (Colten, 1985). Industrial activity altered the natural setting by "reclaiming" wetlands. In the last two decades there has been a tremendous expansion of waste disposal activity in the area. The study area contains numerous hazardous waste sites and many other areas associated with the handling of hazardous materials. The identification of these sites has prompted several investigations by local, state, and federal agencies. These agencies have collected samples, reviewed internal files, conducted site inspections, and analyzed hundreds of samples taken from the area. This has produced an enormous collection of hazardous material-related data that is unusually rich, yet somewhat disjointed (Illinois Department of Conservation, 1988; Mehnert and Keefer, 1988; Ross, et al., 1988; Northeastern Illinois Planning Commission, 1987; Metropolitan Sanitary District of Greater Chicago, 1986; Illinois Environmental Protection Agency, 1984; Chicago Department of Public Works, 1981; Northeastern Illinois Planning Commission, 1977 and 1963; United States Department of the Interior, 1966; United States Department of Health, Education, and Welfare, 1965; Ferguson, et al., 1933; Crouhurst, 1926).

To make these disparate sources of information more accessible and to permit electronic searches for particular environmental contaminants, hazardous material handling activity, or relationships between them, Museum staff identified appropriate data sets, acquired them from the source agencies, refined their contents, and entered them in a compatible format into the Illinois Geographic Information System (IGIS). Museum personnel then formatted the data to allow various searches to be conducted and to aid in data management.

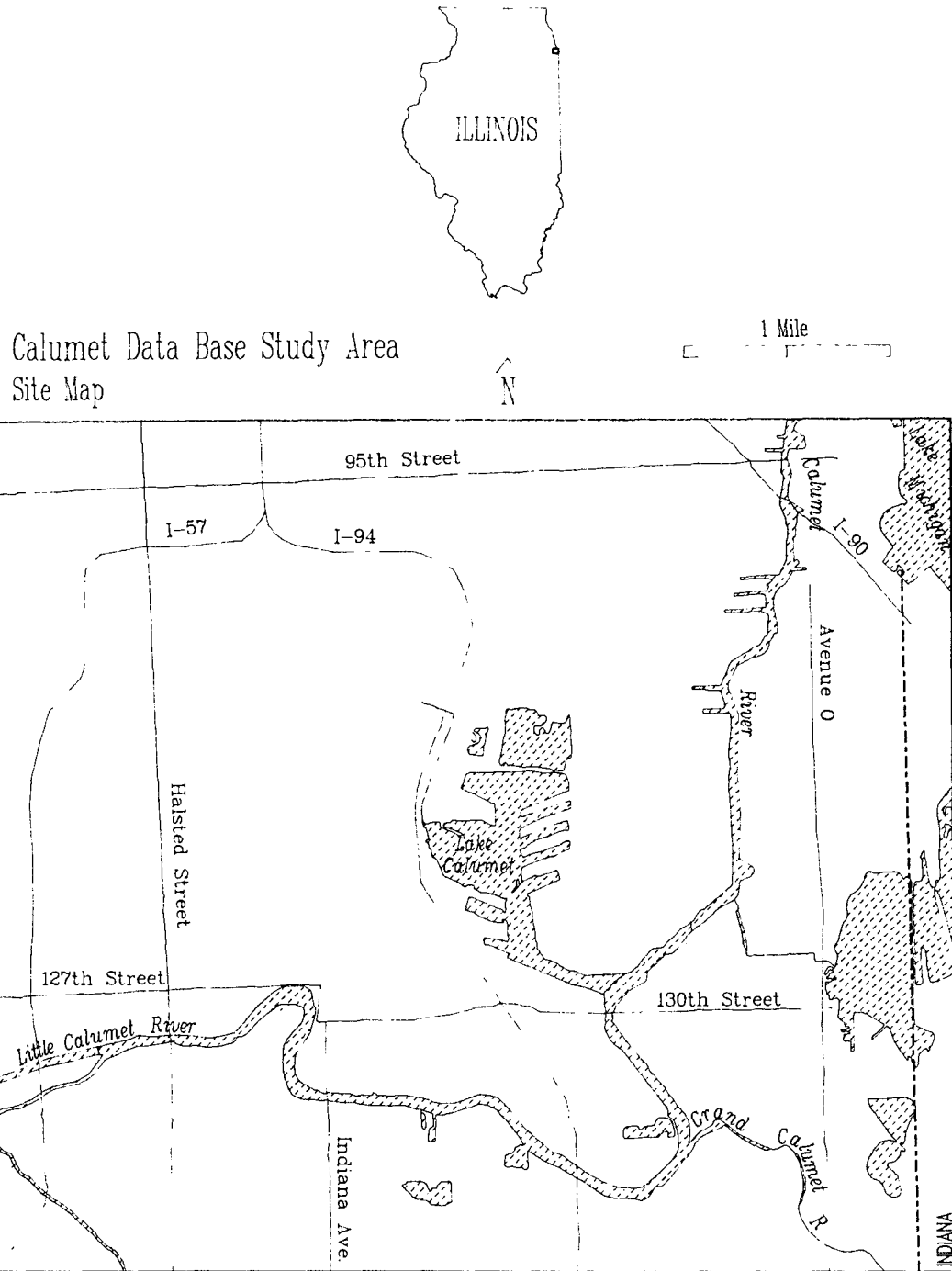

Figure 1.1. STUDY AREA. The diagonal shading denotes open water features.

With the data base on-line, it is possible to conduct searches of differing scope and direction. Such searches include, but are not limited to, location information on underground storage tanks (USTs), presence of specific waste stream components at CERCLA (Comprehensive Environmental Response, Compensation and Liability Act) sites, and the approximate extent of reclaimed wetlands within the study area. By incorporating information from previous reports with unpublished data from agency files, we provide the user with a means of comprehending the magnitude of past hazardous material handling activity within the Lake Calumet study area.

This report is designed to serve those familiar with ARC/INFO and who have access to the IGIS.

## 1.2 Data Acquisition and Refinement

The following section describes the data acquisition and refinement procedures. These procedures are critical to understanding both the possibilities and limitations of the data sets.

### 1.2.1 Data Acquisition

The production of an electronic data base with multiple data sets containing an unknown number of variables presented many challenges. At the outset, Museum staff discussed the set of information to be collected with HWRIC personnel and then investigated the availability of each (Fig. 1.2). From this point, data were either collected or deleted from the universe of sources to be consulted. Some sources were unavailable for a number of reasons and had to be dropped from the list of potential contributions. The data was organized and refined to fit the computerized format used in this project (Fig. 1.3).

The data sets were generally divided into two types: historical sets that derive from pre-1970 public health records or other archival sources and those of a more recent nature, particularly those developed by regulatory agencies or research centers such as HWRIC. Historical information sources provided spatial reference and location for sites within the study area. Data sets from regulatory agencies were primarily quantitative and technical in nature, providing the bulk of the coded analytic information.

Among the historical records, we traced the Illinois General Land Office's original survey plats for the study area to develop an 1830s baseline for the documentation of historical land surface alteration (Illinois State Archives, 1839, 1834). We consulted the Illinois State Water Survey (ISWS), Ground Water Section files in Champaign to gather reports on pollution incidents from the early twentieth century. We also reviewed microform records housed at the Land Pollution Control and Water Pollution Control Divisions of the Illinois Environmental Protection Agency (IEPA). These records contain files inherited by the IEPA when it was formed in 1970. They include



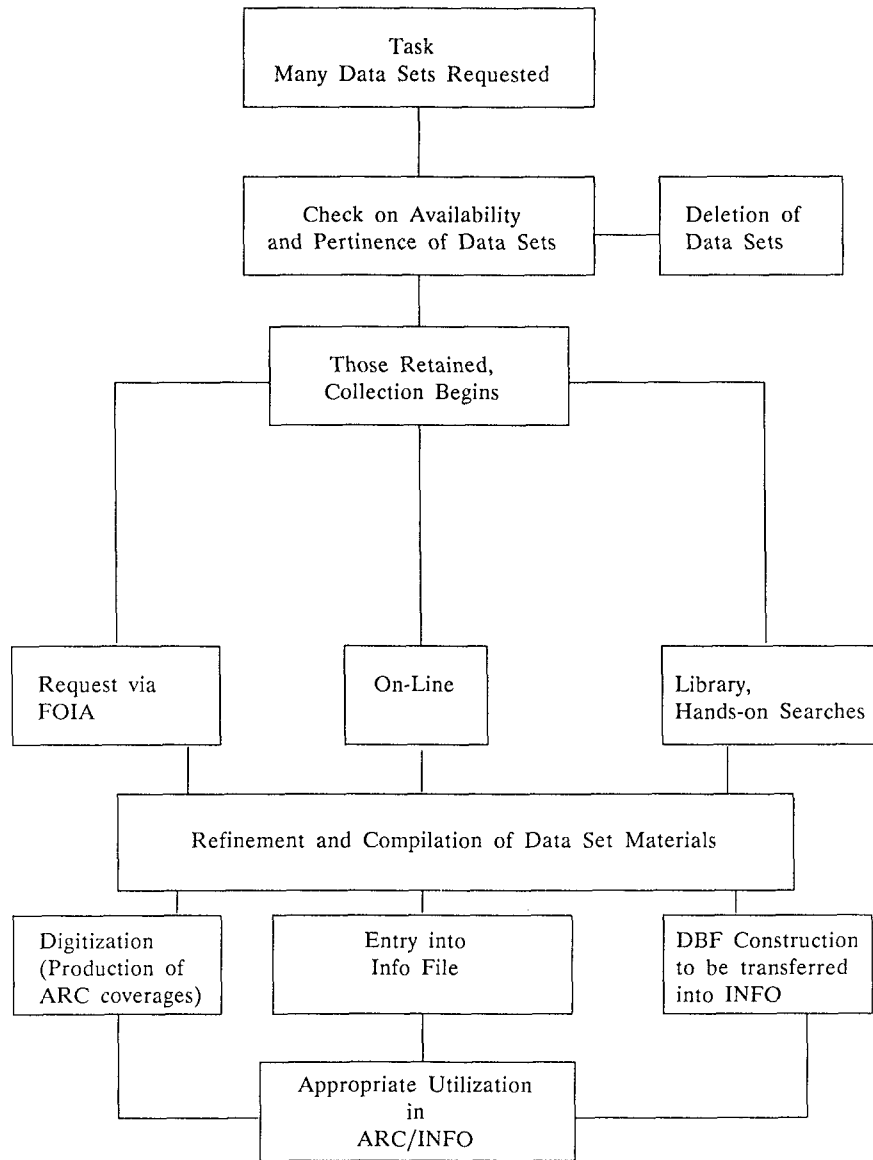

Figure 1.2. ACQUISITION, REFINEMENT, AND COMPUTER ENTRY OF PROJECT DATA.

Filename	Description	Date of Information
CAL01	Water Features	1901
CAL29	Water Features	1929
CAL39	Water Features	1939
CAL53	Water Features	1953
CAL60	Water Features	1960
CALCERC	CERCLA sites	1988
CALSED.PT	Lake Calumet sampling sites	1988
CALROADS	1980 Transportation network	1980
CALWET	Wetlands	1974
CALTWETLN	Calwet supplementary information	
CERADD	CERCLA site points	ca. 1987
CERADD2	CERADD backup	
DIRTCAL	Soil analyses, 22 sites	1984
DIRTCAL2	DIRTCAL backup	
DSPOIL	Dredge spoil sites	1968
EPAPOLYS	Clean backup copy, use EPAPOLYS2	
EPAPOLYS2	CERCLA site boundaries	1980-1987
FM2	Registered underground storage tanks	1986
IEPAMICRO	Historical pollution incidents	1928-1970
LANDFILLS	Landfills	1986
LU01	Landuse	1901
LU29	Landuse	1929
LU53	Landuse	1953
LU60	Landuse	1960
MDMANOR	Private well sites, Maryland Manor	1986
NIPCLNFLS	Northeastern Illinois Planning Commission landfills	1987
OLC1940	Property boundaries	1940
OLC1960	Property boundaries	1960
OLC1970	Property boundaries	1970
OLDRIVERS	Pre-settlement surface hydrology	1834, 1839
RR01	Railroads	1901
RR29	Railroads	1929
RRCONTEM	Railroads	1988
RTK	Community Right-to-Know data	1988
SANBORN	Historical underground storage tanks and other hazardous material-handling businesses	1947, 1938, 1911, 1913, 1897
SIACOV	Surface impoundment locations	1980
SITES01	Industries	1901
SITES13	Industries	1913
SITES29	Industries	1929
SITES60	Industries	1960
SITES60ALL	SITES60 backup	1960
WDS29	Documented industrial waste disposal sites	1929
WDS29A	Industrial waste storage and treatment facilities	1929
WDS60	Documented industrial waste disposal sites.	1960
WDS60A	Industrial waste storage and treatment facilities	1960

Figure 1.3. CALUMET DATA BASE COVERAGES.

documentation collected by the Department of Public Health on landfills and dumps through the 1960s and Sanitary Water Board investigations dating back to the 1930s. These documents contain a somewhat erratic record and reflect public agencies' responses to perceived problems during the first two thirds of the century. However, they are only suggestive of the full extent of environmental contamination during the time period they cover.

Attempts to trace industrial activity and land ownership as surrogate indicators of historical hazardous material accumulation sites and also establish more precise boundaries for industrial activity, relied on several sources. Real estate directories (Olcott's Land Values and Bluebook of Chicago, 1970, 1960, 1940, 1930, 1910) and fire insurance maps (Sanborn Map Company, 1947, 1938, 1913, 1911, 1897) provided land ownership information and identified underground storage tanks and businesses that handled hazardous materials prior to the formation of the IEPA. The Illinois Manufacturers Association Directories (1960 and 1928) provided information on the particular set of industries and the manufacturing process found in the region historically (Colten, 1985). In addition, the corporation records of the Illinois Secretary of State were reviewed as a possible means of tracking changing corporate identities. However, the corporation files contained only sketchy records of the specific operations of large companies with numerous plants and yielded only limited connections between modern corporate entities and their nineteenth-century predecessors. Consequently, this source was omitted from consideration.

To correlate systematically historical hazardous substances used in the workplace, and therefore potential accumulations of hazardous materials before 1970, a data base named SICRCRA was developed. It is based on a review of occupational health literature that identifies chemicals known as health hazards to workers between 1914 and 1948 (Teleky, 1948; Brandt, 1947; Hamilton, 1943; Collier, 1941; McCord, 1931; Hamilton, 1925; Kober and Hayhurst, 1924; Hamilton, 1917; Price, 1914). Particular manufacturing processes using chemicals currently defined as hazardous were assigned SIC numbers to identify the various industries and the chemicals were identified by the RCRA (Resource Conservation and Recovery Act) codes. In addition, CAS (Chemical Abstracts Service Registry) numbers for the chemical were added. This will permit cross referencing with corresponding entries in the SARA/Title III List-of-Lists (see glossary; USEPA Region 6, 1988; IEPA Division of Land Pollution Control, 1986). By matching the modern chemical codes with SIC numbers, the data base will enable users to search for potential sources of hazardous materials among defunct businesses which never reported to the IEPA.

Several historical records proved unusable due to an assortment of reasons. U.S. Supreme Court records of the Illinois vs. Indiana case (1943) were unobtainable; City of Chicago water quality reports contained information on Lake Michigan rather than the Calumet drainage basin, and a 1933 investigation of the Little Calumet River reported on few water quality measurements within the study area (Ferguson, 1933).

Published literature supplied some indications of historical activity. Colten (1985) reported on industrial waste disposal activity during the period 1870-1970. The U.S. Department of Health, Education, and Welfare (1965 and 1966) produced several reports on water quality in the region and the Northeastern Illinois Regional Planning Commission (1987) recently summarized land disposal activity in a series of maps.

Other published and electronic data sources that were evaluated included the Illinois State Geological Survey (ISGS) Land-Based Disposal Site Inventory (Mehnert and Keefer, 1988), investigations conducted by the IEPA on ground-water contamination in the region (IEPA, 1984), and studies of Lake Calumet sediments (Ross, et al., 1988). The ISGS inventory includes all known land disposal sites and has detailed information stored electronically about each (where this information is documented). When precise locations were not identified, the computer automatically assigns a location in the middle of the section or portion of a section where the site occurs. The IEPA study includes 22 ground-water samples taken throughout their study area and numerous measurements of surface and air quality. Ross et al. (1988) examined lake bed sediments for metals and aromatic hydrocarbons and found much of the lake bed sediments to be "highly toxic." These investigations add to the range of sites and chemical measurements taken in the area.

Three additional sources that were extremely important to this data base were the Illinois State Fire Marshal underground storage tank inventory and the U.S. Environmental Protection Agency (USEPA) CERCLA (or Superfund) sites in the region, and the Community Right-to-Know records. The Fire Marshal (1986) maintains a listing of all reported underground storage tanks that contain flammable materials. The CERCLA sites include some 44 sites that are being considered as potential Superfund sites or are already so designated (USEPA, Region 5, 1987). The CERCLA files contain Preliminary Assessment reports that include general information based on cursory investigations and literature reviews. If more detailed information is desired, a Site Inspection form is completed. This form contains more detailed information including analyses of ground and surface water. The information from these files was transferred to a computerized format for incorporation in the data base. In general this information exists in a standardized format that is suitable for computer entry, but there are many deviations from the guidelines. Chemicals may be listed by CAS code numbers or generic names; quantities of chemicals may be expressed in volume, weight, or concentration. A third important data set derived from IEPA data was the Community Right-to-Know data (IEPA, Office of Chemical Safety, 1988). This inventory includes industry-reported chemical releases.

### 1.2.2 Data Refinement

After acquisition of raw data, the refinement of the data sets required extensive effort. A major portion of this task consisted of identifying the inconsistencies specific to the individual data sets. As we scanned the files, this diversity came into focus.

It was hoped that a template usable for all data sets could be constructed. We attempted to produce prototypes of such a template to facilitate data collection and entry, but none proved viable. The diversity and incompleteness of the data sets made the development of a universal template impossible.

The most problematic of the coverages, EPAPOLYS2 (study area CERCLA sites), contained the largest data set, 2,470 entries in all. Not all of the sites were alike, nor were the waste streams described in the same manner. Some waste stream descriptions were verbal accounts of their contents, while others consisted of widely ranging units of measure. To provide a consistent structure for the entry of pertinent attributes into the work space, we developed a dBASEIII file called CASPOLYS, which was modified into several RELATE files. The dBASEIII file allows searches for the presence of CAS-numbered substances in the SARA/Title III List-of-Lists (USEPA Region 6, 1988) to be made.

Upon obtaining this List-of-Lists in 5 1/4-inch diskette format from USEPA headquarters, we found this document to be invaluable for it contains cross-referenced information including CAS numbers, chemical formulae, synonyms, RCRA numbers, and special coding conventions for hazardous materials used by such agencies as the U.S. Coast Guard and the U.S. Department of Transportation.

The IEPA's Office of Chemical Safety for the Community Right-to-Know dBASEIII files contained inconsistencies similar to those encountered in the USEPA Region 5 CERCLA files (i.e., incomplete data, data in non-standard units, missing data, and possible noncompliance). The sites were located, digitized, and associated with the appropriate facility identification number. IEPA files contained only minimal site and chemical identification data. When IEPA staff discover an incomplete and/or erroneous form, they request that the forms be completed by the generator. However, compliance is far from complete.

### 1.2.3 Data Base Limitations

The data sets utilized in this project were not originally designed to be compatible. Since there was a great deal of diversity in the data collected, screening of the data prior to entry was a major undertaking, especially in the case of the CERCLA sites. The unevenness of data arises from several factors, among them being (1) the collection of data by different regulatory agencies, (2) the lack of uniformity in the units of measure and in waste stream description, and (3) the use of different coding conventions.

For the first factor, each regulatory agency has its own legislated agenda and, in the main, adheres to its role. An agency may monitor waste generators, disposal sites, or transporters; its interest may be water, land, or air pollution. Consequently, an agency may measure chemical contaminants by weight, volume, or concentration. As a matter of course, the data base user should consider these idiosyncrasies. The mission of a regulatory agency should be recognized to avoid misinterpreting the function of its data.

There are also several agencies or programs that have compiled similar inventories. For example, the Illinois Environmental Protection Agency (1984), the State Geological Survey (Mehnert and Keefer, 1988), the Northeastern Illinois Planning Commission (NIPC, 1988), and for a limited area the Illinois State Museum (Colten, 1985) have all tallied landfills. The Geological Survey and NIPC have utilized sites identified by Colten (1985), but each includes additional sites beyond the geographical and temporal boundaries of Colten (1985). Each file is maintained separately and users should use the latest update or the file most closely suiting their needs.

Researchers also have slightly different missions and their data tend to reflect those agendas. Museum research has focused on identification of historical hazards within limited geographic areas, while the Scientific Surveys have attempted to build a series of data bases that contain information on conditions across the entire state. Such differences complicate the merger of data, regardless of the thoroughness of the researchers. Regulatory agencies face another problem, namely the acquisition of information from sometimes unwilling reporters. Thus, the information tallied by a historical researcher looking at a small area will be vastly different from that collected by a regulatory agency compiling information for the entire state.

The lack of uniformity in units of measure poses serious problems if the user attempts to convert units of one type (i.e. concentration) into units of another (volume and/or weight). The unit "DRUMS" is ambiguous because the volume of the container is not specified. This typifies some of the difficulties encountered when inconsistent units of measure are encountered. As for differences in agency documentation practices, it should be noted that a field investigation usually does not have the resources available that a sophisticated analytical laboratory may have at its disposal.

The utilization of different coding conventions seems to be a synthesis of the first two factors. The various agencies, with their singular mandates, utilize such codes as CAS numbers or RCRA waste stream descriptors. CAS numbers identify a more-or-less specific chemical substance, whereas the RCRA numbers identify some specific substances, as well as wastes from specific industrial processes. A gap between the intent of the two codes exists, which may cause a perceptual void between the specificity of chemical analysis and the specificity of the industrial process. In the SARA/Title III List of Lists, there is cross-referencing between the two systems, but this is helpful only when a CAS number has a parallel RCRA number.

Another limitation to be considered is that of misinterpretation of the chemical data itself. The quantities given are likely to be misconstrued by the individual with minimal expertise in chemistry; in such situations, the layperson would likely give an erroneous assessment of the readings. Original data sources are also important in the appropriate interpretation of both the chemical and historical information. Early twentieth-century analytical techniques were incapable of the same level of detection, nor were the same substances analyzed. It is imperative for users to consult the original sources and examine the methods used to compile the material and consider the authors' purpose.

In cases of industrial self-reporting to regulatory agencies, it is apparent that in many instances the industries neglect to complete the supplied data forms. This can be attributed to a number of reasons, including an attitude of resistance, unfamiliarity with technical terminology or the forms, or lack of knowledge about the industry itself in regards to the intent of the data-gathering process. When regulatory agencies receive an incomplete or misleading data form, they request that the industry complete it properly. Corrective actions may be slow forthcoming.

A final point of caution refers to the boundaries of the study area itself. Colten (1985) and IEPA (1984) report on investigations of an area that is approximately 36 miles square. Thus, the historical and analytical information supplied by these studies only covers a portion of the larger study area. Ross (1988) only investigated Lake Calumet and similar studies for other water bodies were not available. Regulatory information has been gleaned from much larger areas and should represent even coverage for the entire study area.

### 1.3 Data Base Introduction

The following two sections provide a more detailed introduction to the particular components of the data base. Chapter 2 provides a description of the structure of each component and listings of each individual data set included in the data base. Chapter 3 provides instructions on how to use the data base and gives examples of its utility.

Since the data base is housed on the IGIS, its access is limited to those users who have computer terminals connected to this system. Furthermore, familiarity with the ARC/INFO GIS package is essential. The following sections are written for those conversant in the particular language of the ARC/INFO software.

## CHAPTER 2. DATA BASE DESCRIPTION

### 2.1 Introduction

The Lake Calumet area hazardous substance data base (HSDB) is contained in dBASEIII files (a commercial data base management program used to organize and analyze electronic files), ARC/INFO coverages, and RELATE files (intermediate data files which have been entered into a PRIME minicomputer and "DEFINED" in INFO to allow them to be identified by mutual fields or INFO items) (Environmental Systems Research Institute, 1987a and 1987b). This chapter provides information that will permit ARC/INFO users to conduct on-line searches of the Lake Calumet area HSDB. It discusses the structure of the data base, annotates the data sets contained in the principal workspace (CALUMET; See Fig. 2.1), and identifies sources of each data set. The simple flowchart indicates that those with access to the IGIS can enter the CALUMET workspace and gain access to the numerous coverages and relate files attached to it. A second workspace (CALDB) houses backup and intermediate coverages used to construct recombined versions of basic coverages in CALUMET.

### 2.2 Data Base Accessibility

The data base is housed on the Illinois Department of Energy and Natural Resources IGIS and can be used from terminals in any of the divisions of the department. Since the data and the machinery require a knowledge of ARC/INFO, it will be essential for users to either have a working knowledge of the software or access to employees versed in the system.

The entire data base is maintained in a workspace, within the HWRIC's segment of the IGIS, that is named CALUMET (Fig. 2.1). When users gain access to the CALUMET workspace, they can inspect individual coverages or select additional textfile items related to specific coverages via the relate process (Fig. 2.2 and 2.3; and see ARC/INFO manual).

### 2.3 Data Base Structure

There are several key components to this data base. The first is the Systematic Coverage Description (SYSCOVDE.DBF) (Fig. 2.4). Its primary function is to provide a structure for the classifying and annotating all other usable coverages in a single format. This provides standardized fields for the description of data items such as coverage name, sources of the coverages and INFO files, coding conventions (if any), key names for



# Workspace Path Names

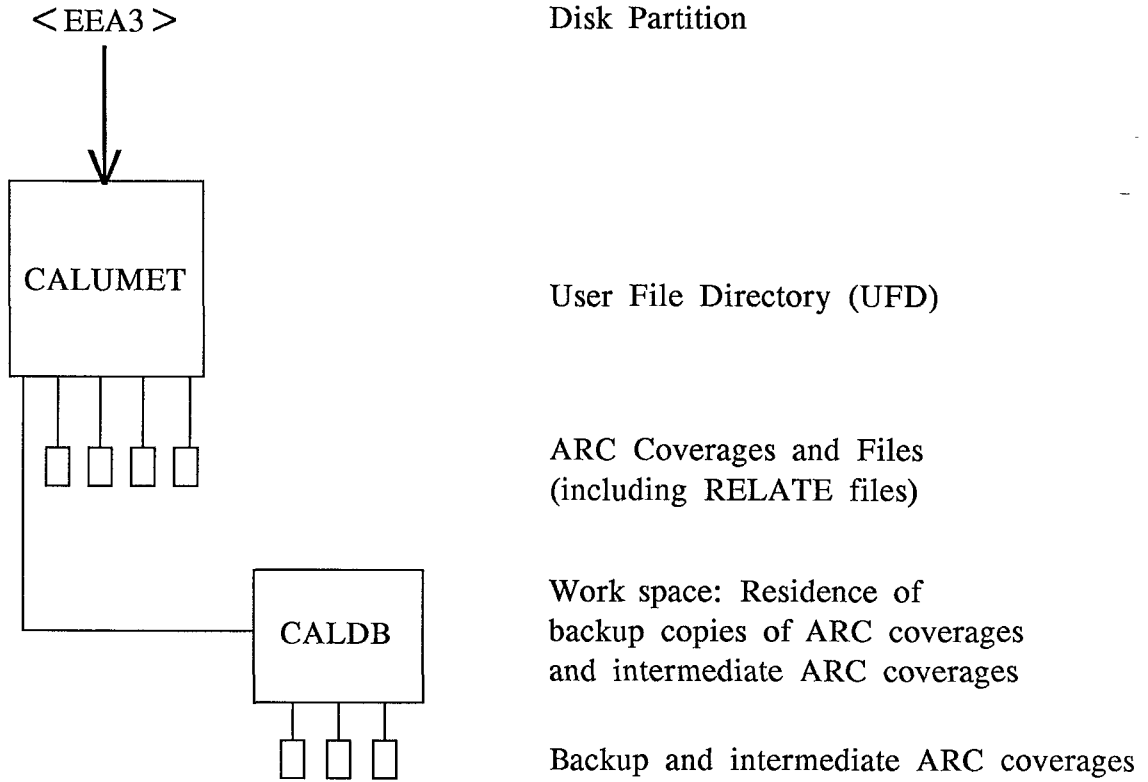

Figure 2.1. WORKSPACE PATH NAMES

## CALUMET WORKSPACE ELEMENTS

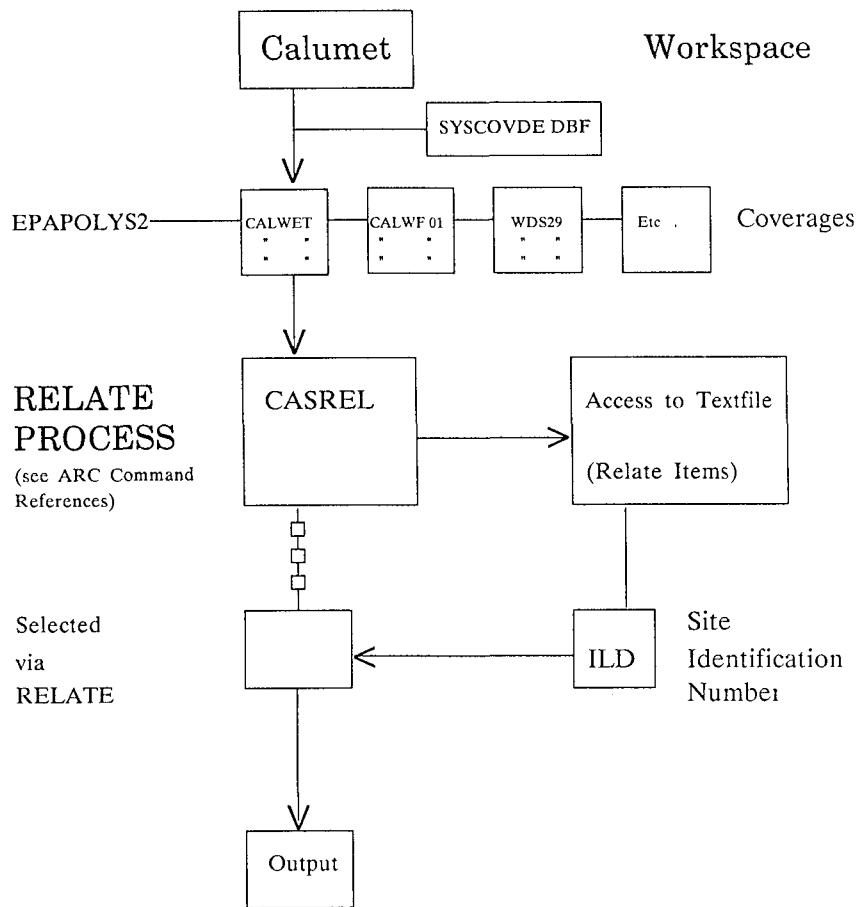

Figure 2.2 CALUMET WORKSPACE ELEMENTS.

# RELATE PROCESS

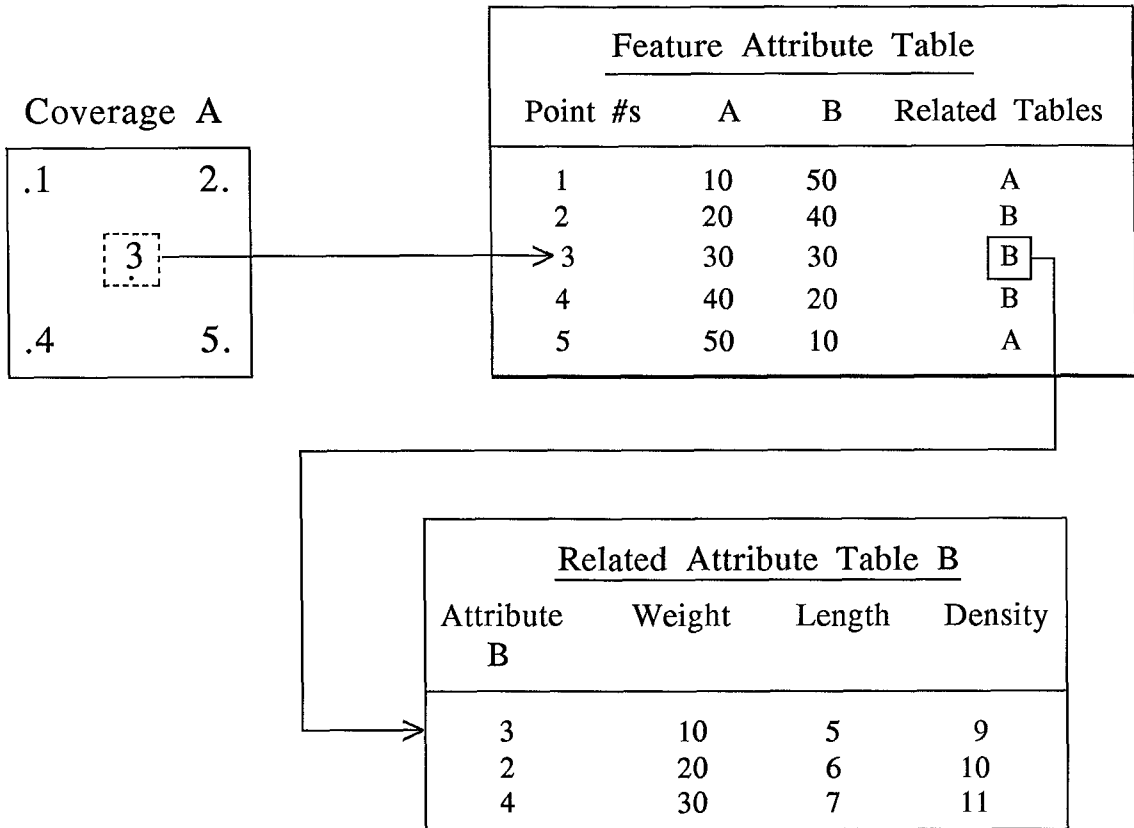

Figure 2.3 RELATE PROCESS.

Structure for database: B:SYSCOVDE.dbf

Number of Records: 49

Date of last update: 04/26/89

Field	Field Name	Type	Width	Dec
1	COVERAGE	Character	15	
2	TYPE	Character	10	
3	COVSOURCE	Character	30	
4	COVSOURCE2	Character	30	
5	INFOFILE	Character	50	
6	INFOFILE2	Character	50	
7	INFOSOURCE	Character	50	
8	CODE	Character	30	
9	RELATE	Character	100	
10	RELATEKEY	Character	10	
11	UTILITY	Character	60	
12	COMMENTARY	Character	254	
**Total**			690	

Figure 2.4. STRUCTURE OF DBASEIII FILE SYSCOVDE.DBF.

using the RELATE command (see glossary), and ARC/INFO commands appropriate to the specific coverage. Not only does this integrate the entire system, but it provides critical documentation about the sources of information. SYSCOVDE.DBF can be used to produce hard copy of any portion of the data base with available output devices.

The bulk of the data base is composed of coverages created for this or other HWRIC data bases. A coverage is a set of spatial information that has been entered on the IGIS which can be related to data files stored on the same system. ARC coverages contain geographic information; INFO files contain numerical or descriptive information. These coverages derive from the various historical and regulatory information described in the previous chapter and were entered on the IGIS by Museum staff.

In addition there are several utility and RELATE files that were constructed to make various searches possible (see Section 2.4.2 and 2.4.3).

### 2.3.1 SYSCOVDE.DBF

The SYSCOVDE.DBF (**SY**Stematic **CO**verage **DE**scription **DA**ta **BA**se **F**ile) is a dBASE III file, stored on a 5 1/4-inch diskette (Fig. 2.4) that provides a template so that the user can assess files with different structures and use them in an efficient manner. It helps explain the functions of coverages and ancillary files. With this Systematic Coverage Description, the user of this data base can conduct searches of the study area on the IGIS.

The Systematic Coverage Description also can provide uniform information on each coverage so that users can address aspects of these data sets and the idiosyncracies, if any, of the individual coverages. The following section contains a thumbnail sketch of each field of SYSCOVDE.DBF.

### 2.3.2 SYSCOVDE.DBF Fields

**COVERAGE** - Gives the name of the coverage.

**TYPE** - Tells whether the coverage is composed of points (discrete locations identified as points), arcs or lines (linear elements recorded in ARC), or polygons (enclosed, multisided areas).

**COVSOURCE** - Refers to the source of the graphic data component of the coverage. This refers to a bibliographic citation that corresponds to items in the References Cited.

**COVSOURCE2** - Extra space for COVSOURCE.

INFOFILE - Describes and identifies the number of INFO items

INFOFILE2 - Extra space for INFOFILE.

INFOSOURCE - Gives additional source information when the data from INFO items have a different source than the coverage source.

CODE - Tells which coding conventions are utilized with files in the particular coverage. (Example: Chemical Abstracts Service (CAS) number; please consult glossary for further information).

RELATE - Names and describes RELATE file items.

RELATEKEY - Supplies the password to call on the appropriate RELATE file if one is associated with the specific coverage.

UTILITY - Describes appropriate uses for the coverage.

COMMENTARY - Discussion of coverage which may have idiosyncrasies.

## 2.4 Coverages

The following section contains descriptions of each of the ARC coverages contained in the workspace "CALUMET." The coverages expressly created for information purposes are described first and those coverages used in utility capacities will then be described.

### 2.4.1 Information Coverages

CAL01 - Water features, 1901.

Type - Arcs

Source - From United States Geological Survey (U.S.G.S.), 15' Calumet topographic map 1901, digitized for Colten (1985).

Uses - Provides spatial and temporal reference for water feature alteration.

CAL29 - Water features, 1929.

Type - Arcs

Source - From U.S.G.S. 7.5' Calumet Lake topographic map 1929, digitized for Colten (1985).

Uses - Provides spatial and temporal reference for water feature alteration.

CAL39 - Water features, 1939.

Type - Arcs

Source - U.S. Department of Agriculture, Soil Conservation Service, Aerial

- Photographs, 1:20,000, 1939, digitized for Colten (1985).  
 Uses - Provides spatial and temporal reference for water feature alteration.
- CAL53 - Water features, 1953.  
 Type - Arcs  
 Source - From U.S.G.S. 7.5' Calumet Lake topographic map 1953, digitized for Colten (1985).  
 Uses - Provides spatial and temporal reference for water feature alteration.
- CAL60 - Water features, 1960.  
 Type - Arcs  
 Source - From U.S.G.S. 7.5' Lake Calumet topographic map 1960, digitized for Colten (1985).  
 Uses - Provides spatial and temporal reference for water feature alteration.
- CALCERC.UD - Point locations of CERCLA sites within the study area providing generalized chemical, spatial, and CERCLA proprietary data.  
 Type - Points  
 Source - United States Environmental Protection Agency Region 5, (1987); CERCLA files.  
 INFO items - A total of 44; extensive, updatable and subject to change.  
 INFO sources- USEPA Region 5 (1987); CERCLA files.  
 Uses- Provides point locations for CERCLA sites within the study area. With appropriate updating, quick searches are possible without invoking RELATE for the RESELECT command.
- CALSED.PT - Point locations of Lake Calumet sampling sites. Ross, et al. (1988) analysis for metallic organic contaminants and sediment toxicity.  
 Type - Points  
 Source - Ross, et al. (1988).  
 INFO items - Twelve items assessing the ecological hazards associated with the contamination of Lake Calumet (See source). Includes data on metallic and organic contaminants in lake sediments, surface and ground water transport of contaminants, microbial degradation rates of toxic substances, bioaccumulation rates of metals in macrophytes, and overall sediment toxicity by bioassay.  
 INFO source- Same as source.  
 Uses - Provides environmental analyses of sediments from Lake Calumet.
- CALROADS - 1980 street and highway network.  
 Type - Arcs  
 Source - U.S. Department of Commerce, Bureau of the Census (1980); GBF/DIME (Geographic Base File/Dual Independent Map Encoding) file.  
 Uses - Provides the contemporary street and highway network in the study area.

CALWET - Wetlands in study area as defined by the National Wetlands Inventory criteria (1988).

Type - Polygons

Source - Illinois portion of the National Wetlands Inventory prepared by the U.S. Fish and Wildlife Service with contributions by the the Illinois Department of Conservation (IDOC) (1988). Maintained by the Illinois Natural History Survey.

INFO items - CODE: refers to the coding system developed for the National Wetlands Inventory, which classifies the areas inventoried into three main groups: palustrine, lacustrine, and riverine. These three groupings are further subdivided by characteristics representative of the physical and biotic nature of the individual area. SH: refers to shading used in maps produced by file "CLIPped" to produce this subfile.

INFO sources - Same as source.

Uses - This coverage is a "CLIPped" portion of the state-wide coverage developed for the National Wetlands Inventory started nationally in 1974 and in Illinois in 1984. This program has as its long range objectives the description of homogenous ecological units, the use of these units in a systematic classification for resource management decision-making processes, the inventory and mapping of these units, and the development of conceptual and terminological uniformity for the United States.

CALWETLN - A coverage composed of lines representing linear wetlands that supplements and completes polygon data held in CALWET. See CALWET.

Type - Arcs

Source - See CALWET.

INFO items - CODE (see CALWET), ACRES (estimated acreage), SH (see CALWET).

INFO sources - See CALWET.

Uses - See CALWET.

CERADD - Identifies additional point locations for potential hazardous material sites within the study area. See CALCERUPDT.

Type - Points

Source - USEPA Region 5, (1987); CERCLIS.

INFO items - A total of 43; similar to those of CALCERUPDT, if not nearly identical.

INFO sources - See Source.

Uses - See CALCERUPDT.

CERADD2 - see CERADD; backup copy.



**DIRTCAL** - Provides analyses of soil borings for metallic elements at 22 locations throughout the study area.

Type - Points

Source - Illinois Environmental Protection Agency, Environmental Programs (1984).

INFO items - DIRTCAL-ID (associated with RELATE item SITEID), SITETYPE (type of site, see Figure 2.5).

INFO source - See Source.

RELATE items - SITEID (sampling site identification), GRIDNO (grid square identification), CASNO (CAS number of measured metallic element), DEPTH (level of sample taken from ground surface), AMTPPB (concentration expressed in parts per billion).

RELATE key - GRIDSAM

Uses - Provides results of soil analyses for metals at three levels.

**DIRTCAL2** - see DIRTCAL; backup copy.

**DSPOIL** - Locates designated Corps of Engineers dredge spoil sites, 1968.

Type - Polygons

Source - U.S. Army Corps of Engineers, Chicago District (1968) and U.S. Army Corps of Engineers (1935).

Uses - Shows location of designated dredge spoil sites.

**EPAPOLYS** - clean backup copy, use EPAPOLYS2.

**EPAPOLYS2** - Locates and shows extent of CERCLA sites within the study area.

Type - Polygons

Source- USEPA Region 5, CERCLA Site Files (1980-1987).

INFO items - ILD# (identification number derived from Dun and Bradstreet number; linked with RELATE item ILD to provide continuity within the RELATE function), SITETYPE (type of site, see Figure 2.5), CAS# (when used).

INFO source - See Source.

RELATE items - ILD (identification number derived from Dun and Bradstreet number), SAMPLE (number given to sample if multiple readings are entered), CASNUM (CAS number for waste stream component detected), RCRANUM (RCRA number for waste stream component detected), AMTPPB (amount expressed in parts per billion), AMTGAL (amount expressed in gallons), AMTCY (amount expressed in cubic yards), AMTLBS (amount expressed in pounds), AMTDRUMS (amount expressed in drums, the size of drum not being specified), AMTTONS (amount expressed in tons), HZWDESCVRB (verbal description of waste stream, utilized for commentary and when no coded description is present).

---

## SITE TYPES

---

- 01) Landfill (Unknown)
  - 02) Landfill (Sanitary)
  - 03) Landfill (Unpermitted)
  - 04-09) Open categories)
  - 10) Manufacturing (General)
  - 11) Manufacturing (Chemicals)
  - 12) Manufacturing (Primary Metals)
  - 13) Manufacturing (Fabrication)
  - 14) Manufacturing (Agricultural Products)
  - 15-19) Open categories
  - 20) Incinerator
  - 21) Salvage/Reclamation/Recycling Site
  - 22) Sewage Farm/Outlet
  - 23-29) Open categories
  - 30) Lagoon (Lined)
  - 31) Lagoon (Unlined)
  - 32) Lagoon (Unknown)
  - 33-39) Open categories
  - 40) Drum Site (Permitted)
  - 41) Drum Site (Unpermitted)
  - 42) Drum Site (Unknown)
  - 43-99) Open categories
- 

Figure 2.5. SITE TYPES

RELATE key - CASREL//

Uses - To indicate presence of CAS numbered waste stream substances in study area CERCLA sites. A total of 2,470 readings of the waste streams have been entered, in both numeric and verbal form; units of measurement vary widely, from concentration to volume to weight. RELATE file is invoked with CASREL// in RESELECT to search for presence of CAS numbered substances. The user must access text file to view verbal accounts and quantitative data. See CASTOTAL (Section 2.4.4 Relate Files)

FM2 - State Fire Marshal (SFM) registered underground storage tanks.

Type - Points

Source - Illinois State Fire Marshal (1986).

INFO items - FAC\_ID (refers to facility identification number), TANK# (refers to number of tanks present at site), CAPACITY (refers to total capacity of tanks at site), MATERIAL (refers to construction material of tank), SUBSTANCE (refers to substance held in tank), HAZMAT (indicates presence or absence of hazardous material at tank location determined by owner of the tank or the agent of the owner of the tank), CAS# (indicates presence of a CAS numbered substance in tank, determined by owner or agent of the owner of the tank)

INFO source - See Source.

Uses - Provides location of SFM registered underground storage tanks, with data on facility identification number, number of tanks, construction material of tank, substance in tank, presence of hazardous materials and CAS-numbered substances. The Illinois State Fire Marshal's Office has the same information on a PRIME system. Further updates may be imported from ENR with tape drive using PRIME/ASCII format.

IEPAMICRO - Locations of isolated, historical pollution events gathered from the microform files at the Illinois Environmental Protection Agency.

Type - Points

Source - Microform records at Illinois Environmental Protection Agency, Division of Land Pollution Control and Division of Water Pollution Control (1928-1970).

Uses - Identification of historical pollution events.

LANDFILLS - Landfills documented in the Illinois Statewide Inventory of Land-Based Disposal Sites.

Type - Points

Source - Mehnert and Keefer (1988) and Dixon et al. (1986).

INFO items - A total of 84 INFO items, of a wide range. Updatable by State Geological Survey if data is available.

- INFO source - See Source.  
 Uses - Locates and provides information for landfills included in Illinois Statewide Land-Based Disposal Sites Inventory. Note: If Geological Survey personnel were unable to determine exact location of landfill, they allowed the computer to assign a default location in the center of the smallest reported geographic area where the landfill existed.
- LU01 - Residential, industrial, waste/spoil, and marsh land uses, 1901.  
 Type - Polygons  
 Source - U.S.G.S., Calumet Quadrangle (1901).  
 INFO items - LU (land use)  
 INFO source - See source.  
 Uses - Depicts land use circa 1901.
- LU29 - Residential, industrial, waste/spoil, and marsh land uses, 1929.  
 Type - Polygons  
 Source - U.S.G.S., Calumet Lake Quadrangle (1929).  
 INFO items - LU (land use), SHADE (assigns a shading pattern for map production).  
 INFO source- See source.  
 Uses - Depicts land use circa 1929.
- LU53 - Residential, industrial, waste/spoil, and marsh land uses, 1953.  
 Type - Polygons  
 Source- U.S.G.S., Calumet Lake Quadrangle (1953).  
 INFO items - LU (land use).  
 INFO source - See Source.  
 Uses - Depicts land use circa 1953.
- LU60 - Residential, industrial, waste/spoil, and marsh land use, 1960.  
 Type - Polygons  
 Source - U.S.G.S., Lake Calumet Quadrangle (1960).  
 INFO items - LU (land use), COLOR (assigns shading pattern for map production).  
 INFO source - See Source.  
 uses - Depicts land use circa 1960.
- MDMANOR - Locates area (Maryland Manor) where private wells were tested.  
 Type - Polygons  
 Source - IEPA, Division of Land Pollution Control, Chemical analysis forms - (private well project) (1986).  
 INFO items - Machine-generated items only.  
 RELATE items - MONPT (monitoring point), SITENAME (name of site), CASNO (CAS number), AMTPPB (amount expressed in parts per billion), SAMPLENO (number of sample if more than one reading was taken).

RELATE key - MD\_MAN

Uses - Contains data from chemical analyses (concentrations in parts per billion) taken from private wells within this specific polygon. Note that there are no specific locations for the wells sampled other than the name of the business or property owner where the sampled well is located.

NIPCLNFLS - Landfills cataloged by the Northeastern Illinois Planning Commission (NIPC).

Type - Points

Source - Northeastern Illinois Planning Commission (1987).

INFO items - NAME/LOCATION, SECTION (gives section and quarter section where landfill is located), and SOURCE (source of information identifying landfill).

INFO source - See source.

Uses - Provides locational information for many land-based disposal sites.

OLC1940 - Land ownership boundaries, circa 1940.

Type - Polygons

Source - **Olcott's Land Values and Bluebook of Chicago**, 1940.

Uses - Provides partial identification of property boundaries and owners, circa 1940. Due to inconsistent updating, this series does not supply substantial land ownership information. See OLC1960 and OLC1970.

OLC1960 - Land ownership boundaries, circa 1960.

Type - Polygons

Source - **Olcott's Land Values and Bluebook of Chicago**, 1960.

Uses - Provides partial identification of property boundaries and owners, circa 1960. Due to inconsistent updating, this series does not supply substantial land ownership information.

OLC1970 - Land ownership boundaries, circa 1970.

Type - Polygons

Source - **Olcott's Land Values and Bluebook of Chicago**, 1970.

Uses - Provides partial identification of property boundaries and owners, circa 1970. Due to inconsistent updating, this series does not supply substantial land ownership information.

OLDRIVERS - Pre-settlement surface hydrology.

Type - Arcs

Source - Illinois State Archives, Surveyor General (1839, 1834).

Uses - Provides approximation of pre-European settlement surface hydrology.

RR01 - Railroads, 1901.

Type - Arcs

Source - U.S.G.S. Calumet Quadrangle, 1901; digitized for Colten (1985).

Uses - Provides rail network circa 1901 for spatial reference.

- RR29 - Railroads, 1929.  
 Type - Arcs  
 Source - U.S.G.S. Calumet Lake Quadrangle, 1929; digitized for Colten (1985).  
 Uses - Provides rail network circa 1929 for spatial reference.
- RRCONTEM - Railroads, 1988.  
 Type - Arcs  
 Source - IGIS statewide transportation coverage, 1988 (a "CLIPed" coverage).  
 Uses - Provides contemporary rail network for spatial reference
- RTK - (Right-to-Know; contains data from Community Right-to-Know files.)  
 Type - Points  
 Source - IEPA, Office of Chemical Safety (1988); Community Right-to-Know Data Files.  
 INFO items - ILD# (ILD number used for site identification), FACILNUMB (facility number used for site identification when no ILD number has been assigned), SIC (Standard Industrial Classification).  
 INFO source - See Source.  
 Uses - Locates establishments registered under the Community Right-to-Know program and, when these Right-to-Know files are completed by IEPA, will contain specific information on chemicals and processes used at these sites.  
 Associated files/commentary - Thirteen dBASE III files are available, organized by such items as site identification, chemical identification, Standard Industrial Classification (SIC), proximity to water bodies, and disposal of chemical substances.
- SANBORN - Identifies locations (street address) of historical underground storage tanks and other hazardous material-handling businesses.  
 Type - Points  
 Source - Sanborn Map Company (1947, 1938, 1911 and 1913, and 1897).  
 INFO items - SANBORN-ID (Site identification number, "RELATES" to POINTID).  
 INFO source - See Source.  
 RELATE items - POINTID (site identification number), SANBRNVOL (refers to Sanborn volume), SANBRNFRM (refers to frame of microfilm), NUMBER (indicates number of tanks per site), SUBSTANCE (indicates substance stored in tanks or handled by business), AMTGALS (capacity of tank expressed in gallons), BUSINESS (describes type of business).  
 RELATE key - SANBCAL  
 Uses - Gives location and other data on historical underground storage tanks and other hazardous material handling sites found in the Sanborn Fire Insurance Maps for the study area.

- SIACOV - (Surface Impoundment Assessment Coverage). Digitization of surface impoundment locations from IEPA inventory of surface impoundments. Includes information on impoundment location, ownership, age, size, volume, effluent, and monitoring results.  
 Type - Points  
 Source - Piskin et. al. (1980).  
 INFO items- A total of 78, very extensive.  
 INFO source - See Source.  
 Uses - Provides location and other data on surface impoundments.
- SITES01 - Locates industries involved in primary metals, chemicals/petroleum, food processing, and building materials, circa 1901.  
 Type - Points  
 Source - Sanborn Map Company (1897); digitized for Colten (1985).  
 INFO items - SIC (Standard Industrial Classification), NAME, SYM (symbol used for plotting map).  
 INFO source - See Source.  
 Uses - Locates and provides information related to area industries circa 1901.
- SITES13 - Locates industries involved in primary metals, chemicals/petroleum, food processing, and building materials, circa 1913.  
 Type - Points  
 Source - Sanborn Map Company (1911 and 1913); digitized for Colten (1985).  
 INFO items - SIC, NAME, SYM (see SITES01).  
 INFO source - See Source.  
 Uses - Locates and provides information related to area industries circa 1913.
- SITES29 - Locates industries involved in primary metals, chemicals/petroleum, food processing, and building materials, circa 1929.  
 Type - Points  
 Source - Illinois Manufacturers Association (1928); digitized for Colten (1985).  
 INFO items - SYM, #EMP (Number of employees), SIC1 (Standard Industrial Classification code number), complete listing in Colten (1985).  
 INFO source - See Source.  
 Uses - Locates and provides information related to area industries circa 1929.
- SITES60 - Locates industries involved in primary metals, chemicals/petroleum, food processing, and building materials, circa 1960.  
 Type - Points Source - Chicago and Cook County Industrial Directory (1959).  
 INFO items - SYM, SIC1 (see SITES29).  
 INFO source - See Source.  
 Uses - Locates and provides information related to area industries circa 1960.
- SITES60ALL - See SITES60.

Type - Points  
Source - Same as SITES60.  
INFO items - Only those specifically generated by ARC/INFO.  
INFO source - See Source.  
Uses - Backup copy of coverage SITES60.

WDS29 - Locates documented **industrial** waste disposal sites that were active up to 1929.

Type - Polygons  
Source - USGS Calumet Lake Quadrangle (1929), Chicago City Waste Commission (1914), Chicago Refuse Disposal (1914), Colten (1985).  
INFO items - SHD (assigns a shading pattern for map making), VERBAL (verbal description), SIC (Standard Industrial Classification)1, SIC2, SIC3, DATE (first known date of use).  
INFO source - See Source.  
Uses - Locates and provides information on waste disposal sites in the area circa 1929.

WDS29A - These sites identify **industrial** waste storage and treatment facilities.

Type - Points  
Source - See WDS29.  
INFO items - SYM, VERBAL, SIC1, SIC2, SIC3, DATE (see WDS29).  
INFO source - See Source.  
Uses - Locates and provides information on industrial waste storage or treatment sites, circa 1929.

WDS60 - Locates documented **industrial** waste disposal sites, circa 1960.

Type - Polygons  
Source - IEPA (1984); U.S. Department of Health, Education, and Welfare (1965); Northeastern Illinois Metropolitan Area Planning Commission (1963); U.S. Health Service (1949), U.S. Department of Agriculture, Soil Conservation Service (1939), Gorman (1933), Colten (1985).  
INFO items - SHD, VERBAL, SIC1, SIC2, SIC3, DATE (see WDS29).  
INFO source - See Source.  
Uses - Locates and provides information on waste disposal sites in the area circa 1960.

WDS60A - See WDS29A.

Type - Points  
Source - See WDS60.  
INFO items - SYM, VERBAL, SIC1, SIC2, SIC3, DATE (see WDS29).  
INFO source - See Source.  
Uses - Locates and provides information on industrial waste treatment or storage sites, 1960.



2.4.2 Utility Coverages (These coverages and workspaces were created to provide storage, graphic frameworks, and spatial reference for the project's graphic output.)

CALCLIP - Frame/border for study area plots (see KALKLIP).

Type - Arcs

Source - Hazardous Waste Research and Information Center, GIS manager.

CALDB - Workspace for storage of back up copies of coverages used in CALUMET work space and intermediate coverages that were used in the preparation of finished coverages in Calumet. The pathname is <USERS2>ISM>=CALUMET>CALDB. Produced by ISM staff.

KALKLIP - Frame/border for study area plots with legend/explanation box in the Northwest corner. Produced by Museum staff.

STATELINE - Indiana/Illinois state boundary. Produced by ISM staff.

### 2.4.3 Utility Files (look-up files)

CASPOLY - This file was developed to enter chemical and waste stream description data (USEPA Region 5, 1980-1987; CERCLA files). A total of 2,470 readings were entered. Due to the wide-ranging formats of the waste stream description, quantitative units, and multiple readings at most sites, we utilized intermediate RELATE files to gain access to search capabilities.

SICRCRA - A file developed to correlate historical industrial activity with SIC, RCRA, and CAS. This file was constructed by reviewing the occupational health literature to identify industries that historically handled hazardous materials. SIC codes were assigned to specific manufacturing activities and matched with RCRA numbers for hazardous materials commonly used at that type of industry. Museum staff then cross-referenced the listing with CAS numbers, when such correspondences occurred, adding dates to designate when hazardous materials first appeared in the literature (Teleky, 1948; Brandt, 1947; Hamilton, 1943; Collier, 1941; McCord, 1931; Hamilton, 1925, 1923, 1917; Kober and Hayhurst, 1924; Price, 1914).

#### 2.4.4 RELATE Files

CASTOTAL - Intermediate RELATE file; contains 244 waste stream substances that have been detected in the study area CERCLA sites that are also listed in the SARA/Title III List of Lists. Invoke RELATE with the key CASREL//. The ten-digit CAS numbers have been condensed to fit the parameters of the RELATE file function, an example of which is Arsenic (7440-38-2). It has been changed to A7440382. Note the addition of the initial "A" and deletion of the hyphens; also, CAS numbers have ten digits or fewer, ten is the maximum for the CAS coding convention.



## CHAPTER 3. USE OF COVERAGES IN SEARCHES

### 3.1 Search Examples

To search coverages in the study area for specific data items, the user should be familiar with the probable contents of the INFO and RELATE files belonging to the coverages being searched. Inappropriate or nonexistent data items will not be found. The user must recognize the limitations of the specific coverages and of the data base as a whole (see sections 1.2.3 Data Base Limitations and 2.4 Coverages).

The following sections illustrate several of the possible search routines. Some of the more extensive coverages are utilized to demonstrate the utility of the particular data sets in an ARC/INFO environment. This is by no means an exhaustive listing of possible searches, but provides examples of viable searches. The examples indicate ARC/INFO commands in capital letters. Shaded blocks indicate coverages or files used to construct plots.

#### 3.1.1 Cadmium and Lead in CERCLA sites

Conducting this search, the user starts by logging in to the IGIS, entering ARC, and invoking ARCPLOT with appropriate DISPLAY and MAPEXTENT parameters. This search will involve the CERCLA site coverage, along with the utility file containing the CAS and RCRA codes (Fig. 3.1). The CERCLA site boundaries are called up with the command ARCS EPAPOLYS2. Since the RELATE file CASREL indicates the presence or absence of CAS-numbered waste stream substances, it must be activated by the ARCPLOT command RELATE RESTORE CASREL. Then the user "RESELECTs" for cadmium by using the following: RESELECT EPAPOLYS2 POLYS CASREL//A7440439 = 1. The command POLYGONSHADES fills in the appropriate polygons with horizontal shading, and the coverage EPAPOLYS2 returns to its original condition with the command ASELECT EPAPOLYS2. The search for lead will be conducted in the same manner, substituting the modified CAS number A7439921 for A7440439, the modified CAS number for cadmium. POLYGONSHADES fills the "RESELECTed" polygons with diagonal shading and ASELECT EPAPOLYS2 resets the searched coverage, EPAPOLYS2 (Fig. 3.2).

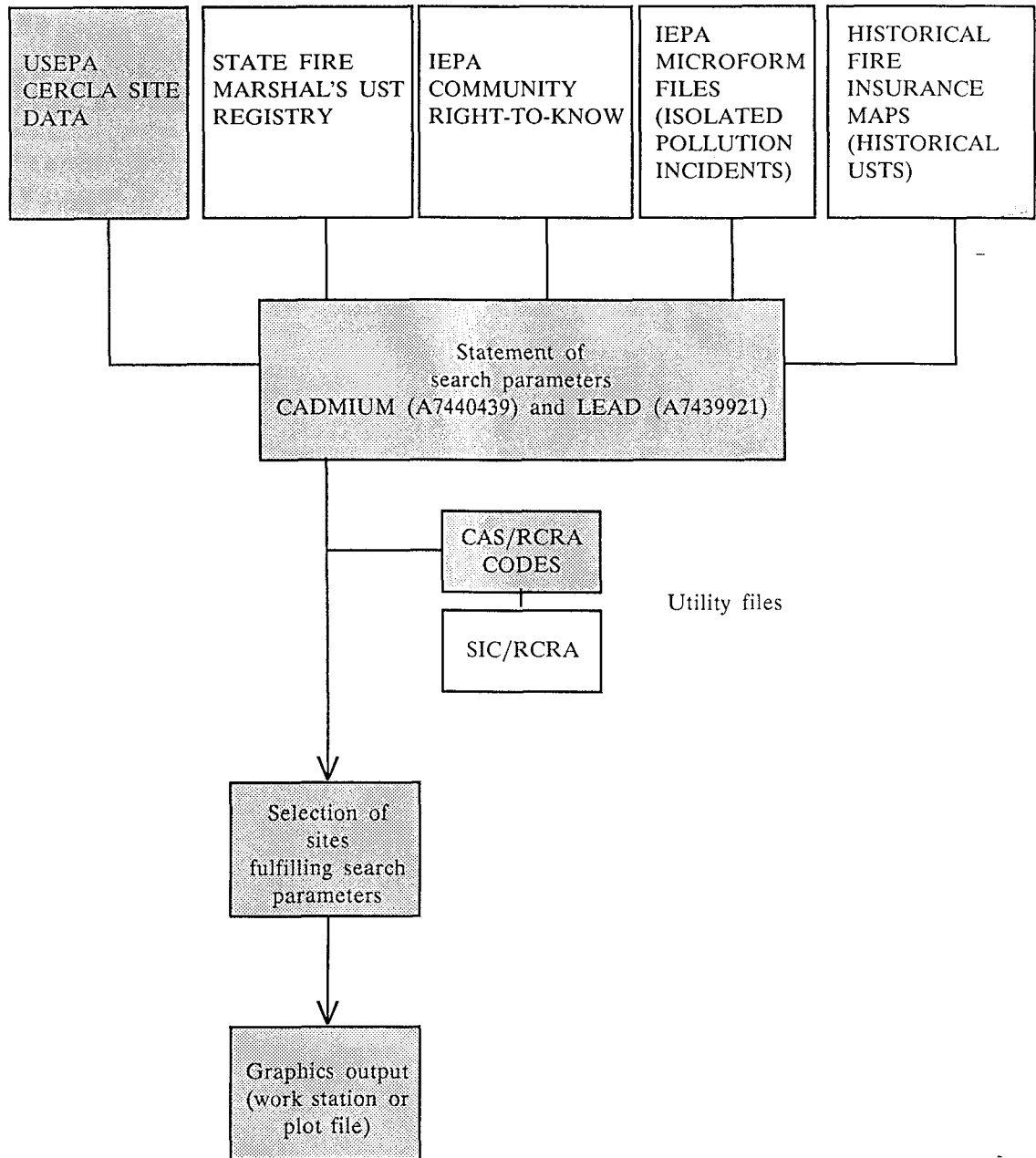

Figure 3.1. CADMIUM AND LEAD SEARCH PROCEDURE.

Calumet Data Base Study Area  
Search for Cadmium and Lead

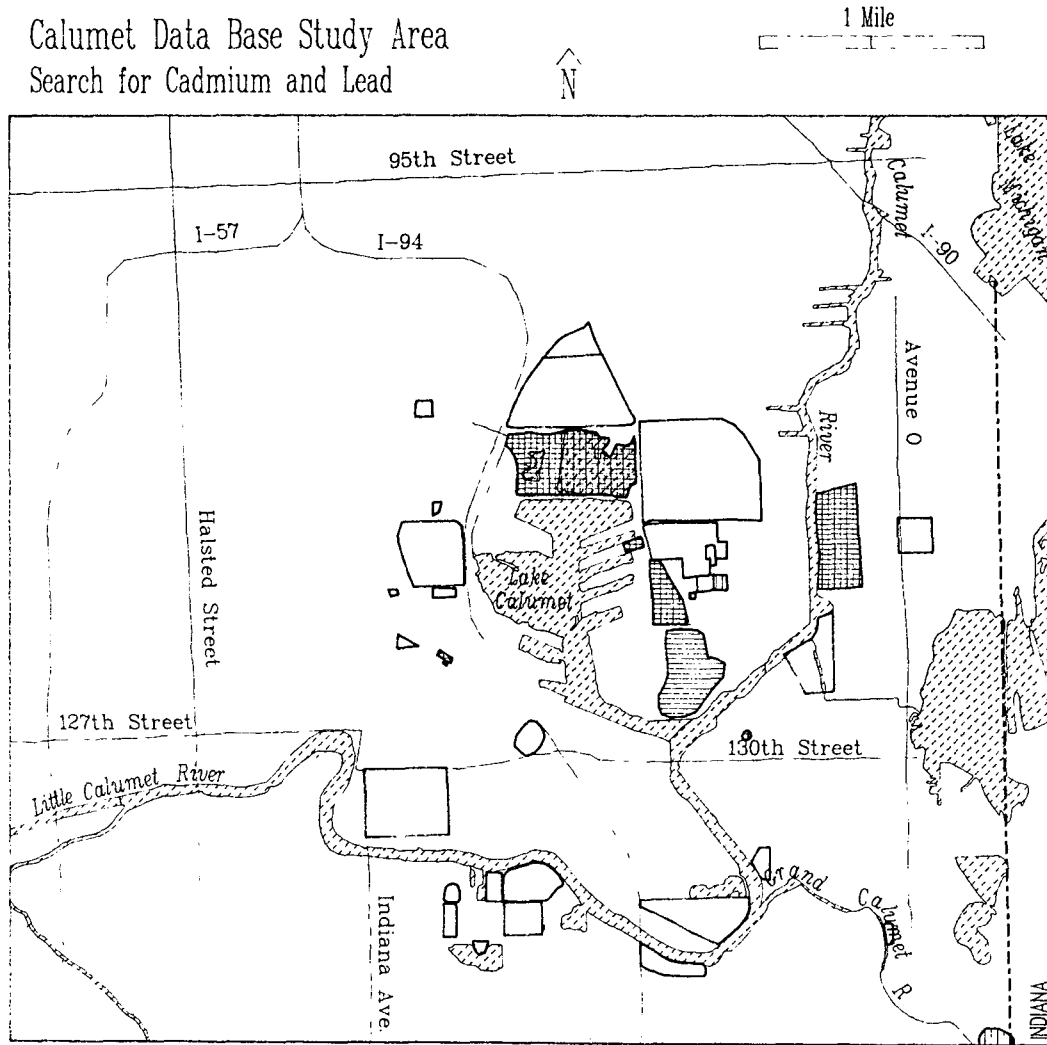

Figure 3.2. PLOT OF RESULTS OF SEARCH FOR CERCLA SITES CONTAINING CADMIUM AND LEAD. The horizontal shading denotes cadmium while the vertical shading denotes lead. The diagonal shading denotes open water features.

One could also search the IEPA Community Right-to-Know coverage (RTK), the IEPA groundwater sampling file (DIRTCAL), and the data collected by Ross, et al. (CALPOINTS) for specific chemical contaminants.

### 3.1.2 Underground Storage Tanks Containing Diesel Fuel

This search differs from the previous one in several ways. First, the coverage FM2 (Fire Marshal) is one of points, rather than polygons; second, the INFO files contain the data, rather than RELATE files; and third, the INFO items are "RESELECTed" with the logical operator "CN," meaning "contains." Since the data are in a character rather than a numeric field, the searched-for keyword must have single quotation marks on each end. When using RESELECT, the command string should read RESELECT FM2 POINTS SUBSTANCE CN 'DIESEL.' The command POINTS FM2 then plots those underground storage tanks that contain diesel fuel with ASELECT resetting the coverage to its original configuration (Figs. 3.3 and 3.4).

By adding additional coverages such as roads or residential areas, the user could create buffers around underground storage tank sites and areas that may be affected should there be a leak.

## 3.2 Search Limitations

When the data items are accessible, as in the first two examples, there should be no problem conducting searches. However, the complexities peculiar to some of the data sets require differing strategies to execute a successful search. A complex file, such as EPAPOLYS2/CASPOLYS, cannot be searched for quantitative data directly. If this is desired, a RELATE file (or a series of RELATE files) must be constructed for each item that will be searched for. This condition arises from limitations within ARC/INFO; if there is a one-to-one (a specific factory : a specific chemical) correspondence or if there is a many-to-one (SIC : diesel fuel) correspondence, no problem exists because only one reading of that particular value or attribute is in the file. However, if there is a one-to-many correspondence (cadmium : 44 CERCLA sites) or a many-to-many correspondence (landfills : addresses), the only record found will be the first record of that particular attribute or value encountered. ARC/INFO does not warn of or test for these situations, so the users must proceed with caution (Environmental Systems Research Institute, 1987a & 1987b).

Due to the amount of data associated with some of the coverages (i.e. CERCLA site data, EPAPOLYS2) only the presence of a SARA List of Lists (USEPA Region 6, 1988) substance can be directly searched for. This is done when using the coverage EPAPOLYS2 by "RESTOREing" the ARC/INFO command RELATE, allowing the

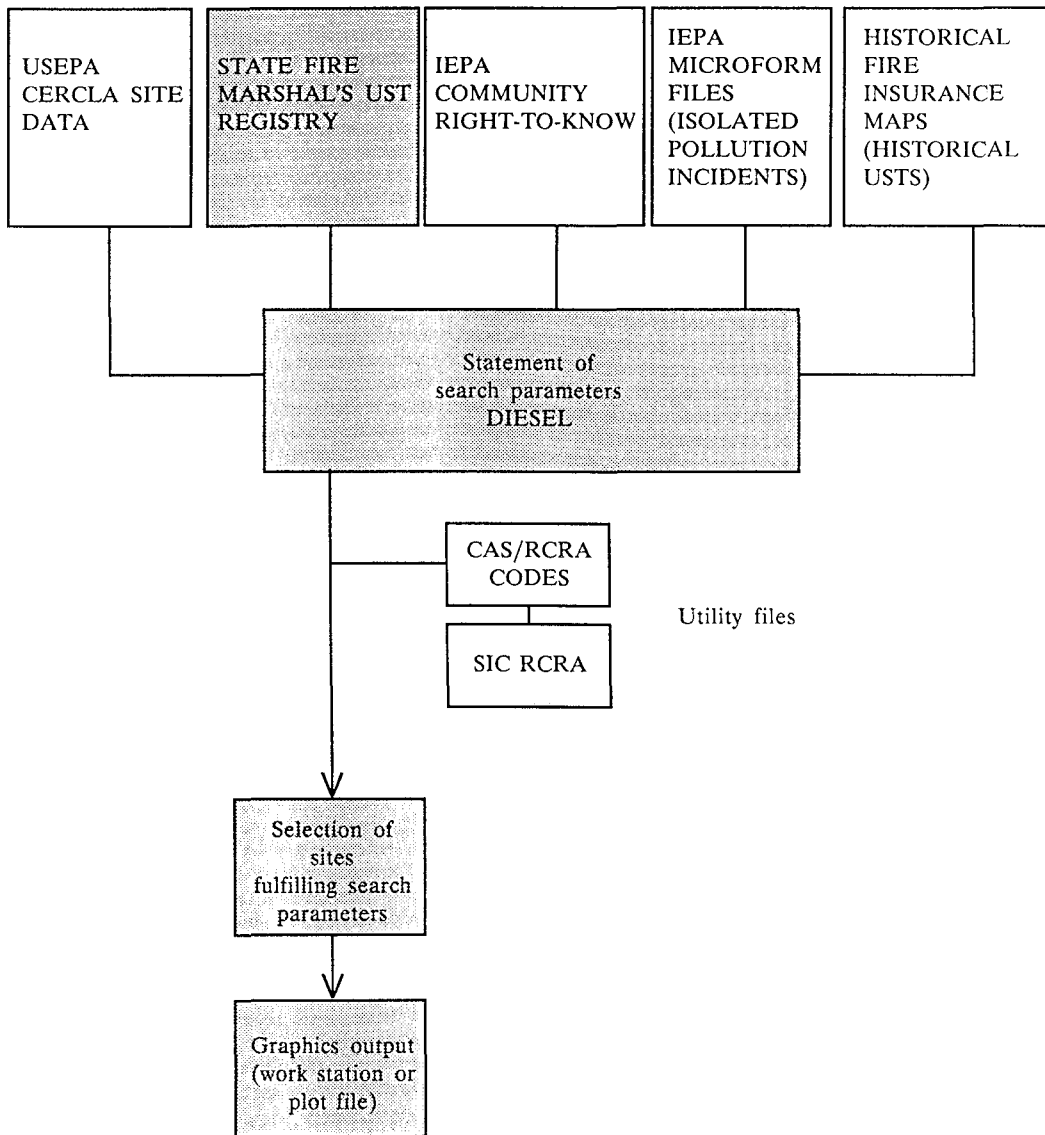

Figure 3.3. UNDERGROUND STORAGE TANKS CONTAINING DIESEL FUEL SEARCH PROCEDURE.



Calumet Data Base Study Area  
Search for USTs with Diesel Fuel

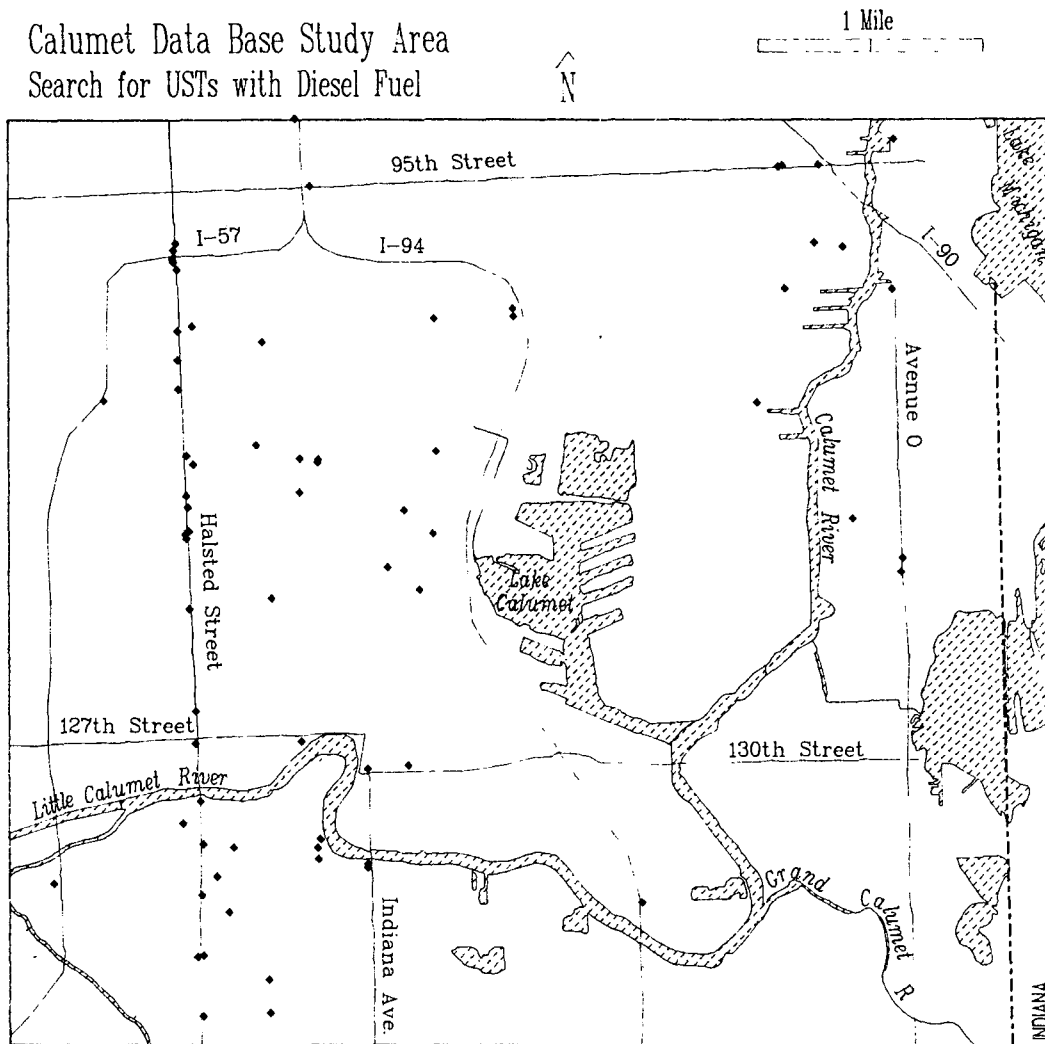

Figure 3.4. PLOT OF UNDERGROUND STORAGE TANKS CONTAINING DIESEL FUEL SEARCH. Diamonds indicate sites contained in data base. Diagonal shading denotes open water.

RELATE key (CASREL//) to function in the RESELECT command. This is thoroughly described in the Systematic Coverage Description for each case in which the RELATE situation must be invoked.

If the data base were to be truly interactive, each field in the text file would require a RELATE file for each possible entry. Users may identify a particular coded substance and then scan the site data for the presence of the desired substance. With this quantitative data in hand, the user may then determine the concentrations and/or quantities on a site-specific basis. This is also the most appropriate way to access non-coded verbal descriptions of the waste streams.

### 3.3 Other Search Strategies

#### 3.3.1 Searching a Geographic Subset

Besides the two searches previously described, other information is retrievable from the coverages and data files. One example of this could be in the case of making an inventory of all sites within a subset of the study area (Fig. 3.5). The interactive option for the ARC/INFO command MAPEXTENT would be invoked by utilizing the asterisk (\*) after the command to define the subset. The user would then define a quadrilateral with cursor lines from the keyboard. Also, if a specific irregular polygon constituted the area where the search takes place, a new polygon coverage could be constructed in ARCEDIT or be digitized in ARC. This could then serve as the appropriate MAPEXTENT for a particular search strategy, the user selecting any or all data items pertinent to the specific search (Fig. 3.6). The example shown combines a number of different sources of environmental contamination within a subset of the Lake Calumet study area.

Similar searches could be conducted for particular pieces of property or along proposed right-of-ways.

#### 3.3.2 Extracting Text File Information

In certain coverages, verbal descriptions of waste streams and quantitative data exist. These exist for sites where chemical data was prepared before standardized codes were prepared or where the site owner completed forms and used descriptive terms rather than the standardized codes. To avoid assigning incorrect chemical codes, the Museum staff used the descriptive terms as found in the various sources. Consequently, much of the chemical data must be accessed through coverage-specific text files. The user can retrieve these by means of a specific identification number and seeking the appropriate field where the amount is expressed. In the case of EPAPOLYS2, the specific identifier

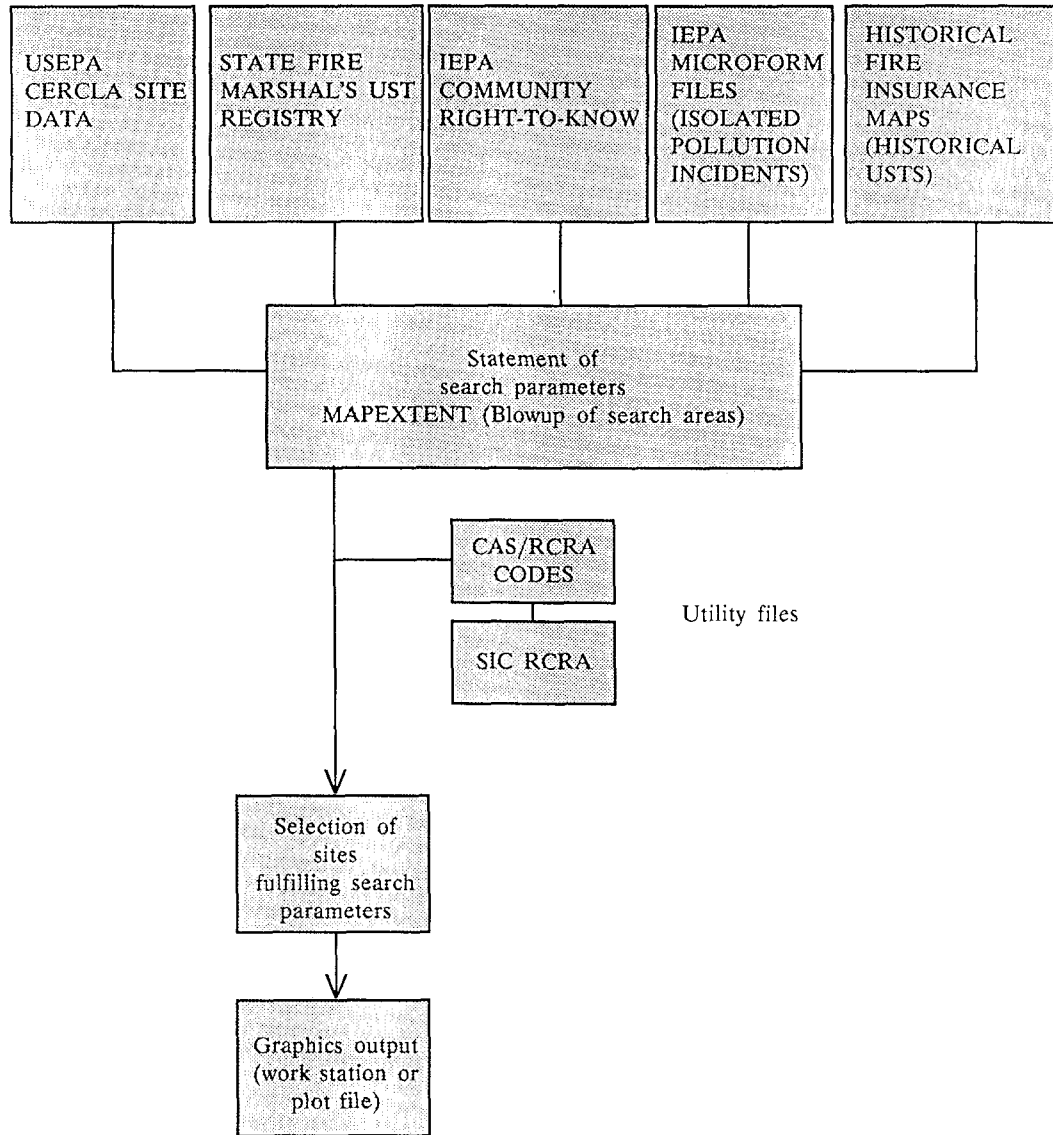

Figure 3.5. INTERACTIVE MAPEXTENT (\*) SEARCH PROCEDURE.

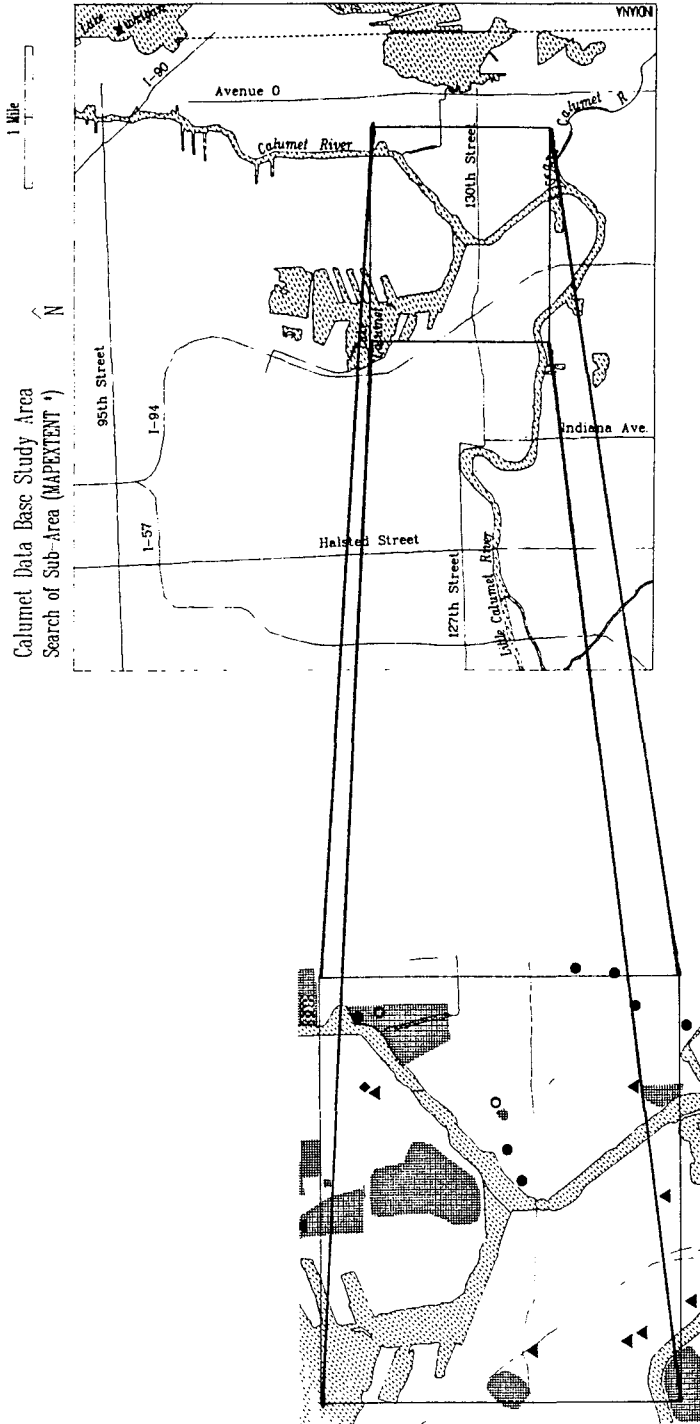

Figure 3.6. PLOT OF INTERACTIVE MAPEXTENT(\*) SEARCH. The cross hatched areas in the blow-up map are CERCLA sites, the hollow circles are Community Right-to-Know sites, the solid circles are Sanborn map sites, the triangles are sites from IEPA microform files, and the diamonds are sites from the State Fire Marshal's UST registry. The diagonal shading denotes open water features.

would be the ILD (site identification number based on the Dun and Bradstreet numbering system, and available from USEPA and IEPA). If the user desires quantitative information and/or verbal description of the waste stream, one may look at the appropriate RELATE items (see EPAPOLY2 annotation in the Systematic Coverage Description) and find an amount expressed in varying units of measure and/or a description of the waste stream. The units of measure reflect concentration, volume, weight, or container size (without indicating if a container is full). Concentration, expressed in parts per billion, differs from units expressing volume or weight. Volumetric units include cubic yards, gallons, and drums, while the weight-oriented units include pounds and tons. The order of the entries by specific unit corresponds to the order of the RELATE items unique to the coverage EPAPOLYS2. Usually, only one quantitative unit is present in an entry, and differing units may be present within the total entries for a single site. Verbal descriptions of waste streams exist under the final RELATE item in CASPOLYS, which is HZWDESCVRB.

## GLOSSARY

- ARC/INFO- Software for running geographic information system. Combines mapping (ARC) and data base management (INFO) capabilities.
- ASCII- American Standard Code for Information Interchange
- CAS- Chemical Abstracts Service Registry
- CERCLA- Comprehensive Environmental Response Compensation and Liability Act (1980)
- Coverage- An ARC/INFO map data set of spatial and tabular information
- DIME file- Dual Independent Map Encoding
- Field- A column representing an attribute's value in a data file structure
- FOIA- Freedom of Information Act
- GBF - Geographic Base File
- HWRIC- Hazardous Waste Research and Information Center
- IEPA- Illinois Environmental Protection Agency
- List of Lists- Computerized listing of chemicals subject to reporting under Title III of the Superfund Amendments and Reauthorization Act of 1986 (SARA) and CERCLA. Includes various codes and numbers assigned by government agencies.
- RCRA- Resource Conservation and Recovery Act (RCRA)
- RELATE- a process whereby additional attribute tables can be temporarily "connected" to a coverage's feature attribute table.
- Report- Displayed information from a data base generated by software
- RESELECT- copies selected features from an existing coverage into a new coverage.
- RTK- Right-to-Know (From Community Right-to-Know legislation)
- SARA- Superfund Amendments and Reauthorization Act (1986)
- USEPA- United States Environmental Protection Agency
- UST- Underground storage tank



## APPENDIX A

### Standard Industrial Classification Numbers in Calumet Data Base

---

Number	Industry
1751	Carpentry work
2041	Flour and other grain mill products
2051	Bread and other bakery Products, except cookies and crackers.
2075	Soybean oil mills
2076	Vegetable oil mills, except corn, cottenseed, and soybean
2082	Malt beverages
2083	Malt
2085	Distilled and blended liquors
2097	Manufactured ice
2099	Food preparations, not elsewhere classified
2251	Women's full length and knee length hosiery, except socks
2431	Millwork
2434	Wood kitchen cabinets
2436	Softwood veneer and plywood
2499	Wood products not elsewhere classified
2511	Wood household furniture, except upholstered
2515	Mattresses, foundations, convertible beds
2531	Public building and related furniture
2711	Newspaper publishing, or publishing and printing
2731	Books: publishing, or publishing and printing
2752	Commercial printing, lithographic
2754	Commercial printing, gravure
2759	Commercial printing, not elsewhere classified
2800	Chemicals and allied products
2821	Plastic materials, synthetic resins, and nonvulcanizable elastomers
2851	Paints, varnishes, lacquers, enamels and allied products
2861	Gum and wood chemicals
2869	Industrial organic chemcials, not elsewhere classified
2879	Pesticides and agricultural chemicals, not elsewhere classified
2891	Adhesives and sealants
2911	Petroleum refining
2951	Asphalt paving mixture and blocks
2952	Asphalt felts and coatings
2992	Lubricating oils and greases
3069	Fabricated rubber products, not elsewhere classified
3231	Glass products, made of purchased glass



3255 Clay refractories  
 3259 Structural clay products, not elsewhere classified  
 3271 Concrete block and brick  
 3292 Asbestos products  
 3295 Minerals and earths, ground, or otherwise treated  
 3312 Steel works, blast furnaces (including coke ovens) and rolling mills  
 3313 Electrometallurgical products, except steel  
 3315 Steel wiredrawing and steel nails and spikes  
 3316 Cold-rolled steel sheet, strip, and bars  
 3321 Gray and ductile iron foundries  
 3325 Steel foundries, not elsewhere classified  
 3331 Primary smelting and refining of nonferrous metals, copper  
 3332 Primary smelting and refining of nonferrous metals, lead  
 3333 Primary smelting and refining of nonferrous metals, zinc  
 3339 Primary smelting and refining of nonferrous metals, except copper and aluminum  
 3341 Secondary smelting and refining of nonferrous metals  
 3369 Nonferrous foundries, except aluminum and copper  
 3412 Metal shipping barrels, drums, kegs, and pails  
 3423 Hand and edge tools, except machine tools and handsaws  
 3433 Heating equipment, except electric and warm air furnaces  
 3441 Fabricated structural metal  
 3443 Fabricated plate work (boiler shops)  
 3444 Sheet metal work  
 3446 Architectural and ornamental metal work  
 3452 Bolts, nuts, screws, rivets, and washers  
 3462 Iron and steel forgings  
 3471 Electroplating, plating, polishing, anodizing, and coloring  
 3494 Valves and pipefittings, not elsewhere classified  
 3496 Miscellaneous fabricated wire products  
 3537 Industrial trucks, tractors, trailers, and stackers  
 3541 Machine tools, metal cutting types  
 3544 Special dies and tools, die sets, jigs and fixtures, and industrial molds  
 3565 Packaging machinery  
 3567 Industrial process furnaces and ovens  
 3651 Household audio and video equipment  
 3661 Communications equipment  
 3677 Electronic coils, transformers, and other inductors  
 3711 Motor vehicles and passenger car bodies  
 3714 Motor vehicle parts and accessories  
 3731 Ship building and repairing  
 3743 Railroad equipment  
 3792 Travel trailers and campers  
 4013 Railroad switching and terminal establishments

4221 Farm product warehousing and storage  
4222 Refrigerated warehousing and storage  
4911 Electric services  
5014 Tires and tubes  
5051 Metal service centers and offices  
5052 Coal and other minerals and ores  
5074 Plumbing and heating equipment and supplies  
5085 Industrial supplies  
5088 Transportation equipment and supplies, except motor vehicles  
5093 Scrap and waste materials  
5149 Groceries and related products, not otherwise classified  
5153 Grain and field beans  
5159 Farm-product raw materials, not elsewhere classified  
5211 Lumber and other building materials dealers  
5231 Paint, glass, and wallpaper stores  
5541 Gasoline service stations  
7211 Power laundries, family and commercial  
7216 Dry cleaning plants, except rug cleaning  
7699 Repair shops and related services, not elsewhere classified

---



## REFERENCES CITED

- Alden, William C. 1902. **Chicago Folio, Riverside, Chicago, Des Plaines and Calumet Quadrangles, Illinois-Indiana.** Washington, D.C.: United States Geological Survey.
- Brandt, Allen. 1947. **Industrial Health Engineering.** New York: John Wiley and Sons, Incorporated.
- Carlson, Rachel L.; Lampe, Jeffrey A.; and Goodner, Joe F. 1989. **Toxic Chemical Report, First Annual: A Summary of Information Contained in the Toxic Chemical Report Forms for Calendar Year 1987.** Springfield, Illinois: Illinois Environmental Protection Agency, Environmental Programs.
- Chicago and Cook County Industrial Directory, Inc. 1959. **Chicago and Cook County Industrial Directory: 1959-1960.** Chicago.
- Chicago City Waste Commission. 1914. **Report on the City Waste Commission.** Chicago.
- Chicago Department of Public Works. 1981, July. **Final Report: Habitat Evaluation of Lake Calumet Harbor Area Road and Site Development.**
- "Chicago Refuse Disposal." 1914. **Municipal Journal**, 36: 701-703.
- Collier, Howard E. 1941. **Outlines of Industrial Medical Practice.** Baltimore: The Williams and Wilkins Company.
- Colten, Craig E. 1985. **Industrial Wastes in the Calumet Area, 1869-1970: An Historical Geography.** HWRIC Research Report 001. Savoy, Illinois.
- Cowardin, L. M.; Carter, V.; Golet, F. C.; and LaRoe, E. T. 1979. **Classification of Wetlands and Deepwater Habitats of the United States.** Washington, D.C.: United States Department of the Interior, Fish and Wildlife Service.
- Crouhurst, H.R. 1926. **Report on an Investigation of the Pollution of Lake Michigan in the Vicinity of South Chicago and the Calumet and Indiana Harbors, 1924-1925.** Chicago: Metropolitan Sanitary District.
- Dixon, W.G., Jr.; Hensel, B.R.; Mehnert, E.; Brutcher, D.F.; and Keefer, D.A. 1986. **The Development of the Illinois Statewide Inventory of Land-based Disposal Sites.** HWRIC Research Report 010. Savoy, Illinois.

- Environmental Systems Research Institute, Inc. 1987a. **Users Guide ARC/INFO Volume 1**. Redlands, California: ESRI.
- Environmental Systems Research Institute, Inc. 1987b. **Users Guide ARC/INFO Volume 2: Command References**. Redlands, California: ESRI.
- Ferguson, Harry F.; Schwob, Carl E.; Gross, Carl D.; and Downer, William J. 1933. **Inventory of the Pollution of Little Calumet River and Tributaries and Recommendations for the Abatement and Prevention of Pollution**. Springfield: Illinois Sanitary Water Board.
- Fowler, Gary L.; Langum, Remi B.; and Tiedemann, Clifford E. **Final Report: Review and Evaluation of Hazardous Substances Data for Illinois**. Chicago, Illinois: Department of Public Health, Division of Epidemiological Studies.
- Gorman, Arthur. 1933. "Pollution of Lake Michigan: Survey of Sources of Pollution." **Civil Engineering**, 3: 519-522.
- Hamilton, Alice. 1943. **Exploring the Dangerous Trades**. Boston: Little, Brown and Company.
- Hamilton, Alice. 1925. **Industrial Poisons in the United States**. New York: McMillan.
- Hamilton, Alice. 1923. "Industrial Toxicology." In **Legal Medicine and Toxicology**. Edited by Frederick Peterson. Philadelphia: Saunders Co.
- Hamilton, Alice. 1921. **Industrial Poisoning in Making Coal Tar Dyes and Dye Intermediates**. Washington, D.C.: Bureau of Labor Statistics, Bulletin 280.
- Hamilton, Alice. 1917, February. **Poisons Used in the Making of Explosives**. Washington, D.C.: Bureau of Labor Statistics, Monthly Review.
- Henco Software, Inc. 1985. **INFO/PRIME Reference Manual**. Waltham, Massachusetts: Henco Software, Inc.
- Illinois Department of Conservation. 1988. **National Wetlands Inventory, Illinois Portion**. ARC/INFO coverage produced jointly between the United State Fish and Wildlife Service and the Illinois Department of Conservation. Maintained by Illinois Department of Conservation and Illinois Natural History Survey. Springfield and Champaign-Urbana, Illinois.
- Illinois Environmental Protection Agency. 1986. **Hazardous Waste Treatment, Storage, and Disposal Facility Annual Report for 1985**. Appendix. Springfield.

- Illinois Environmental Protection Agency, Division of Land Pollution Control. 1986. Chemical analysis forms for private well study; Maryland Manor. Springfield.
- Illinois Environmental Protection Agency, Division of Land Pollution Control. 1985. **1984 Annual Hazardous Waste Report: Computer Printouts and Example Reporting Forms.** Springfield.
- Illinois Environmental Protection Agency, Division of Land Pollution Control. 1966, 1969, 1970. Microform Files. Springfield.
- Illinois Environmental Protection Agency, Division of Public Water Supplies. 1988. **A Primer Regarding Certain Provisions of the Illinois Groundwater Protection Act.** Springfield.
- Illinois Environmental Protection Agency, Environmental Programs. 1984. **The Southeast Chicago Study: An Assessment of Environmental Pollution and The Public Health Impacts.** Springfield.
- Illinois Environmental Protection Agency, Office of Chemical Safety. 1988. **Community Right-to-Know** data files. Springfield.
- Illinois Geographic Information System, Illinois Department of Energy and Natural Resources. 1984. Statewide coverages. Maintained by Illinois Natural History Survey. Champaign-Urbana.
- Illinois Legislative Investigating Commission. 1981. **Landfilling of Special and Hazardous Waste in Illinois: A Report to the Illinois General Assembly.** Chicago.
- Illinois Manufacturers Association. 1960 and 1928. **Directory of Illinois Manufacturers.** Chicago.
- Illinois Sanitary Water Board. Records on file with the Illinois Environmental Protection Agency, Division of Water Pollution Control. 1952, 1951, 1945, 1942, 1939, 1938, 1928. Microform Files. Springfield.
- Illinois State Archives, Surveyor General. 1839, 1834. Plat Book 30. "Federal Township Plats," Record Series 953:12. Springfield.
- Illinois State Fire Marshall. 1986. Underground Storage Tank Registry Files. Springfield.
- Illinois State Water Survey. 1910-1980. Ground Water Section Files. Champaign, Illinois.

- Kober, George M. and Hayhurst, Emery R. 1924. **Industrial Health**. Philadelphia: Blakiston's Son and Company.
- McCord, Casey. 1931. **Industrial Hygiene for Engineers and Managers**. New York: Harper and Brothers.
- Mehnert, E. and Keefer, D.A. 1988. **Statewide Inventory of Land-Based Disposal Sites: An Update**. HWRIC Research Report 020. Savoy, Illinois.
- Metropolitan Sanitary District of Greater Chicago, Department of Research and Development. 1986. **Oxygen Demanding and Toxic Substances Discharged to the Calumet Sewage Treatment Works: A Selected Survey of Contributing Industries**. Chicago.
- Noll, Kenneth E. and De Paul, F. Thomas. 1987. **Emissions of Volatile Organic Compounds from the Sewage Treatment Facilities of the Metropolitan Sanitary District of Greater Chicago**. Vol. 1. Chicago: Metropolitan Sanitary District of Greater Chicago.
- Northeastern Illinois Metropolitan Area Planning Commission. 1963, June. **Refuse Disposal Needs and Practices in Northeast Illinois**. Technical Report No. 3. Chicago.
- Northeastern Illinois Planning Commission. 1977. **Historical Water Quality Data: Chicago River, Sanitary and Ship Canal and Calumet River Systems**. Staff Paper Number 18. Chicago.
- Northeastern Illinois Planning Commission. 1987. **Historical Inventory of Solid Waste Disposal Sites in Northeastern Illinois**. Chicago.
- Olcott's Land Values and Bluebook of Chicago**. 1970, 1960, 1940, 1930, 1910. Chicago: George C. Olcott.
- Piskin, R.; Kissinger, L.; Ford, M.; Colantino, S.; and Williams, T.L. 1980. **Inventory and Assessment of Surface Impoundments in Illinois**. Springfield: Illinois Environmental Protection Agency.
- Price, George M. 1914. **The Modern Factory: Safety, Sanitation and Welfare**. New York: John Wiley and Sons.
- Ross, P.E.; Henebry, M.S.; Risatti, J.B.; Murphy, T.J.; and Demissie, M. Project Manager, Burnett, L.C. 1988. **A Preliminary Environmental Assessment of the Contamination Associated with Lake Calumet Cook County, Illinois**. HWRIC Research Report 019. Savoy, Illinois.

- Sanborn Map Company. 1947. **Sanborn Insurance Maps: Chicago**. V. 48. Chicago.
- Sanborn Map Company. 1938. **Sanborn Insurance Maps: Chicago**. V. 41. Chicago.
- Sanborn Map Company. 1911 and 1913. **Sanborn Insurance Maps: Chicago**. V. G, H, and I. Chicago.
- Sanborn Map Company. 1897. **Sanborn Insurance Maps: Chicago**. V. E and F. Chicago.
- "Sewage Purification in America: Pullman, Illinois." 1893. **Engineering News-Record**, 29: 26-30.
- Steadman, R. 1930. **Public Health Organization in the Chicago Region**. Chicago: University of Chicago Press.
- Teleky, Ludwig. 1948. **History of Factory and Mine Hygiene**. New York: Columbia University Press.
- United States Army Corps of Engineers. 1935. "Little Calumet River Dredging: Mile 320.5 - 322.5." Washington, D.C.
- United States Army Corps of Engineers, Chicago District. 1968. **Dredging and Water Quality Problems**. Chicago.
- United States Department of Agriculture, Soil Conservation Service. 1938-1939. Cook County Aerial Photographs.
- United States Department of Commerce, Bureau of the Census. 1980. GBF/DIME File (Geographic Base File/Dual Independent Map Encoding) of Illinois Transportation Network. Lyme, New Hampshire: Geographic Data Technology.
- United States Department of Commerce, National Oceanic and Atmospheric Administration, National Ocean Service, Office of Oceanography and Marine Assessment, Ocean Assessments Division. 1988. **MSDOS CAMEO**. Seattle, Washington.
- United States Department of Health, Education and Welfare. 1964. **Solid Waste Handling in Metropolitan Areas**. Washington, D.C.
- United States Department of Health, Education, and Welfare, Public Health Service, Division of Water Supply and Pollution Control, Region V. 1965. **Report on Pollution of the Waters of the Grand Calumet River, Little Calumet River, Calumet River, Lake Michigan, Wolf Lake and Their Tributaries Illinois-Indiana**. Chicago.



- United States Department of the Interior, Federal Water Pollution Control Administration, Great Lakes Region. 1966. **Report on the Water Quality of Lower Lake Michigan, Calumet River, Little Calumet River and Wolf Lake By Department of the Interior for the Period January 1966 thru June 1966 Illinois-Indiana.** Chicago.
- United States Environmental Protection Agency. 1988. **EPA Form R and Instructions: Toxics Release Inventory Reporting Form, January 1988.** Washington, D.C.
- United States Environmental Protection Agency. 1984a. **Hazardous Waste Sites: Descriptions of Sites on Current National Priorities List, October 1984.** Washington, D.C.
- United States Environmental Protection Agency. 1984b. **Hazardous Waste Sites: Descriptions of 244 Sites on Proposed Update #2 to National Priorities List, October 1984.** Washington, D.C.
- United States Environmental Protection Agency. 1984c. **Uncontrolled Hazardous Waste Site Ranking System: A Users Manual (HW-10).** Washington, D.C.
- United States Environmental Protection Agency, Region 5 CERCLIS. 1987. Chicago.
- United States Environmental Protection Agency, Region 5 CERCLA Site Files. 1980-1987. Chicago.
- United States Environmental Protection Agency, Region 6. 1988. **Title III/CERCLA Consolidated List of Chemicals: Chemicals subject to reporting under Title III of the Superfund Amendments and Reauthorization Act (SARA) of 1986 and CERCLA.** Dallas, Texas.
- United States Geological Survey. 1965. **Lake Calumet Quadrangle, Illinois-Indiana, 7.5 Minute Series.** Photorevised 1973, Photoinspected 1977. Reston, Virginia.
- United States Geological Survey. 1965. **Lake Calumet Quadrangle, Illinois-Indiana, 7.5 Minute Series.** Washington, D.C.
- United States Geological Survey. 1960. **Lake Calumet Quadrangle, Illinois-Indiana, 7.5 Minute Series.** Washington, D.C.
- United States Geological Survey. 1953. **Calumet Lake Quadrangle, Illinois-Indiana, 7.5 Minute Series.** Washington, D.C.
- United States Geological Survey. 1929. **Calumet Lake Quadrangle, Illinois-Indiana, 7.5 Minute Series.** Washington, D.C.

United States Geological Survey. 1901. **Calumet Quadrangle, Illinois-Indiana**, 15 Minute Series. Washington, D.C.

United States Geological Survey. 1892. **Calumet Sheet, Illinois-Indiana**, 15 Minute Series. Washington, D.C.

United States Health Service. 1949. **The Chicago-Cook County Health Survey**. New York: Columbia University Press.

"Waste Disposal in Chicago." 1918. **Municipal Journal**, 45. 167-168.



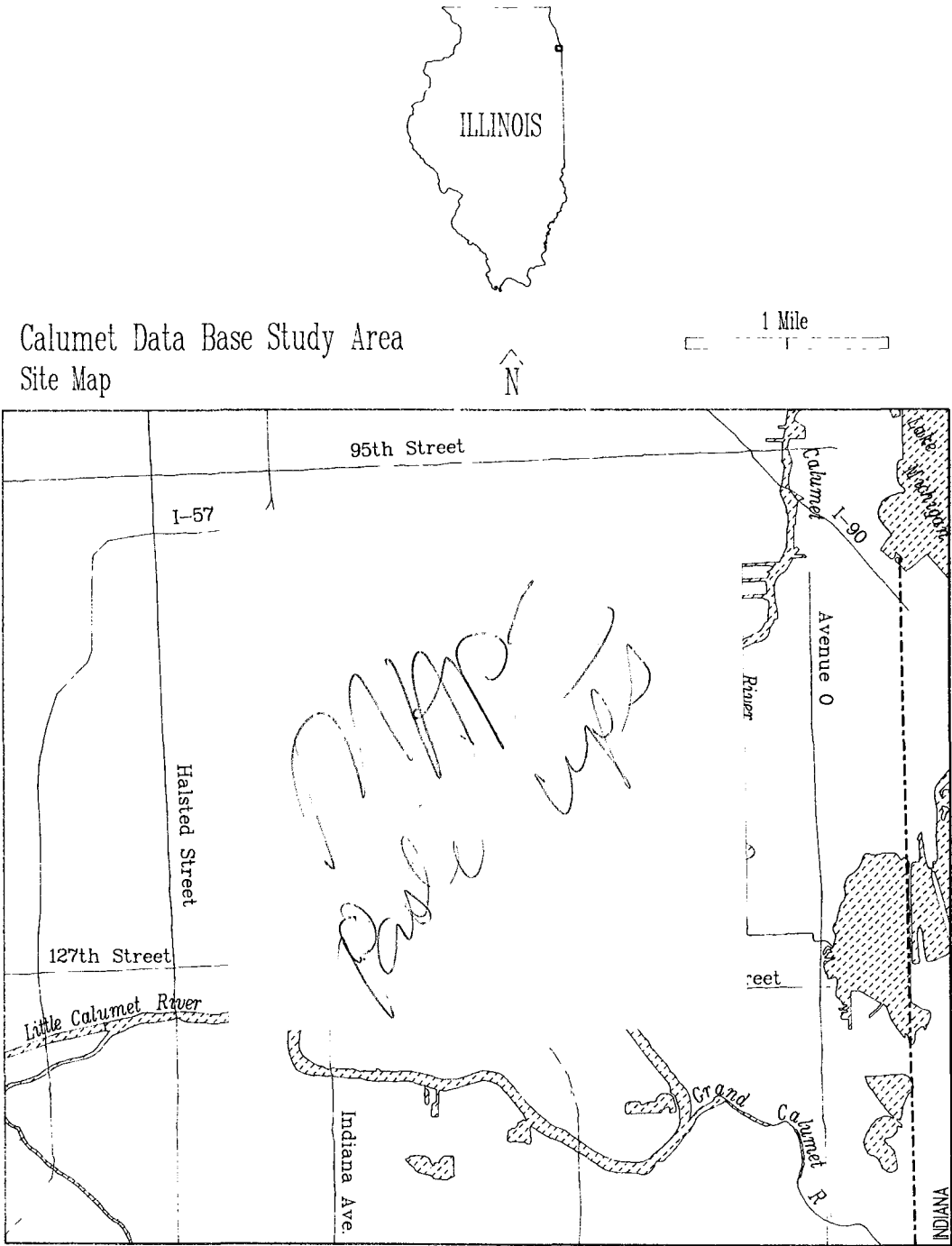

Figure 1.1. STUDY AREA. The diagonal shading denotes open water features.

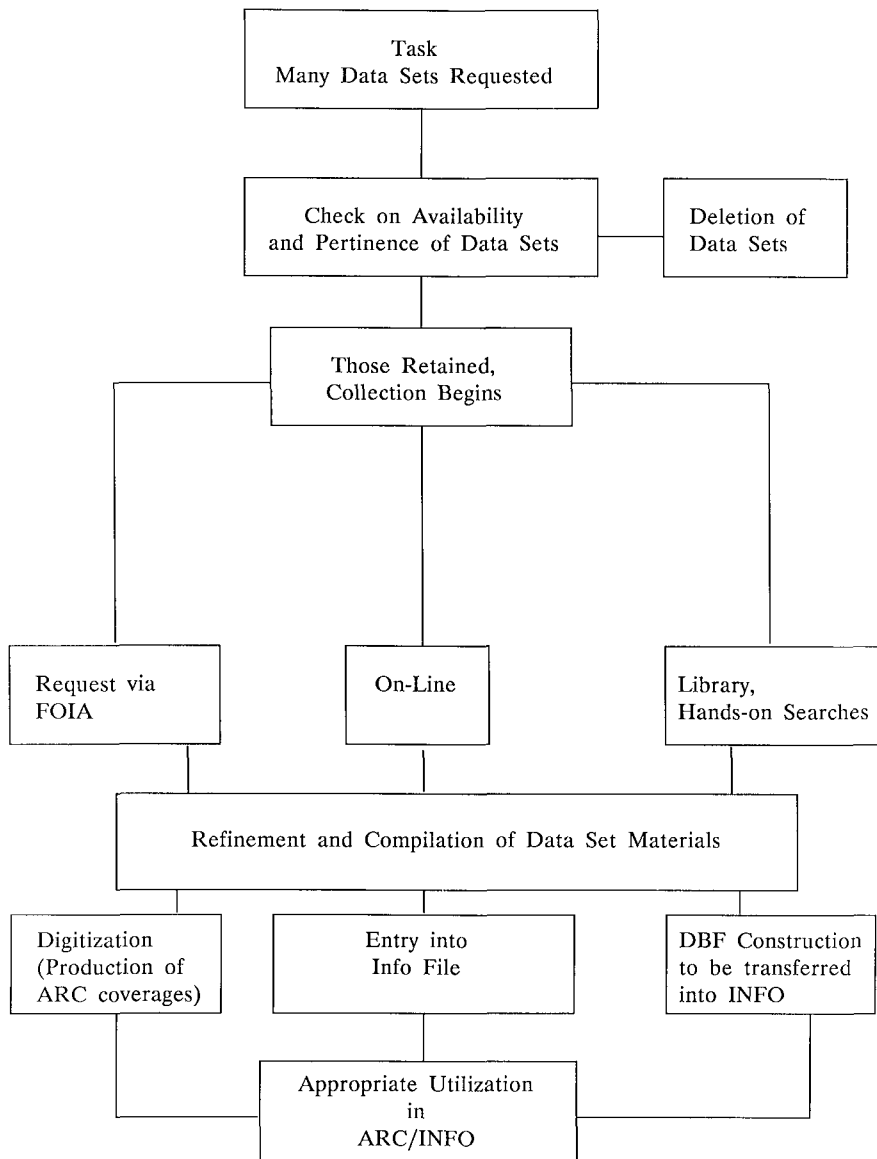

Figure 1.2. ACQUISITION, REFINEMENT, AND COMPUTER ENTRY OF PROJECT DATA.

## CALUMET WORKSPACE ELEMENTS

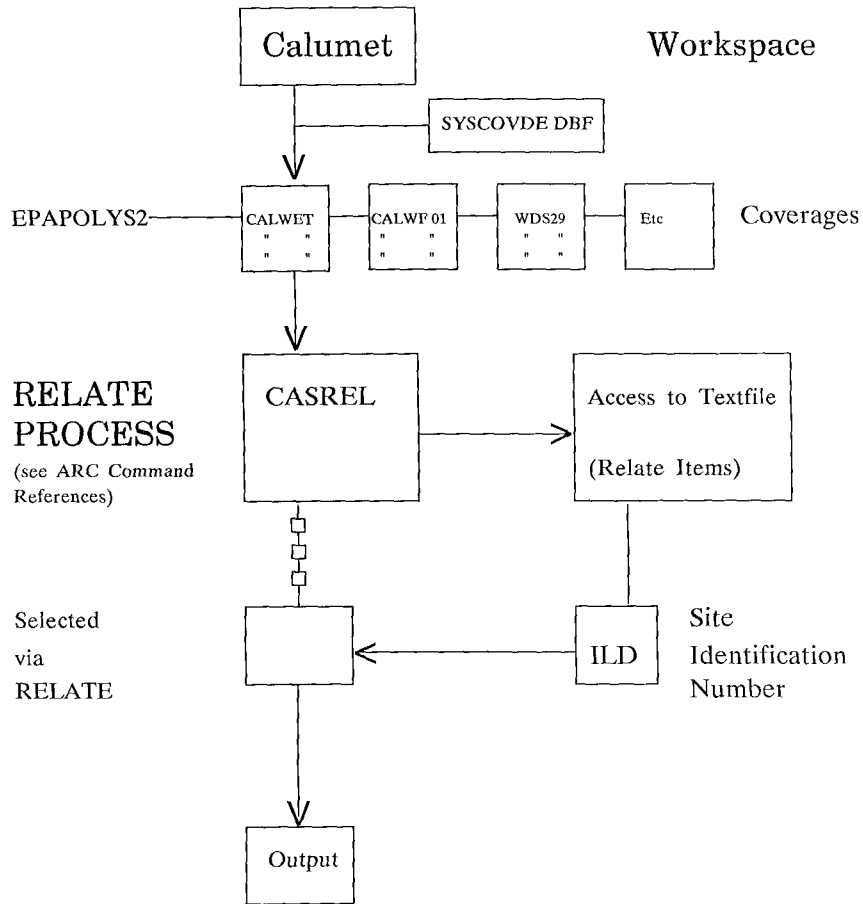

Figure 2.2 CALUMET WORKSPACE ELEMENTS.

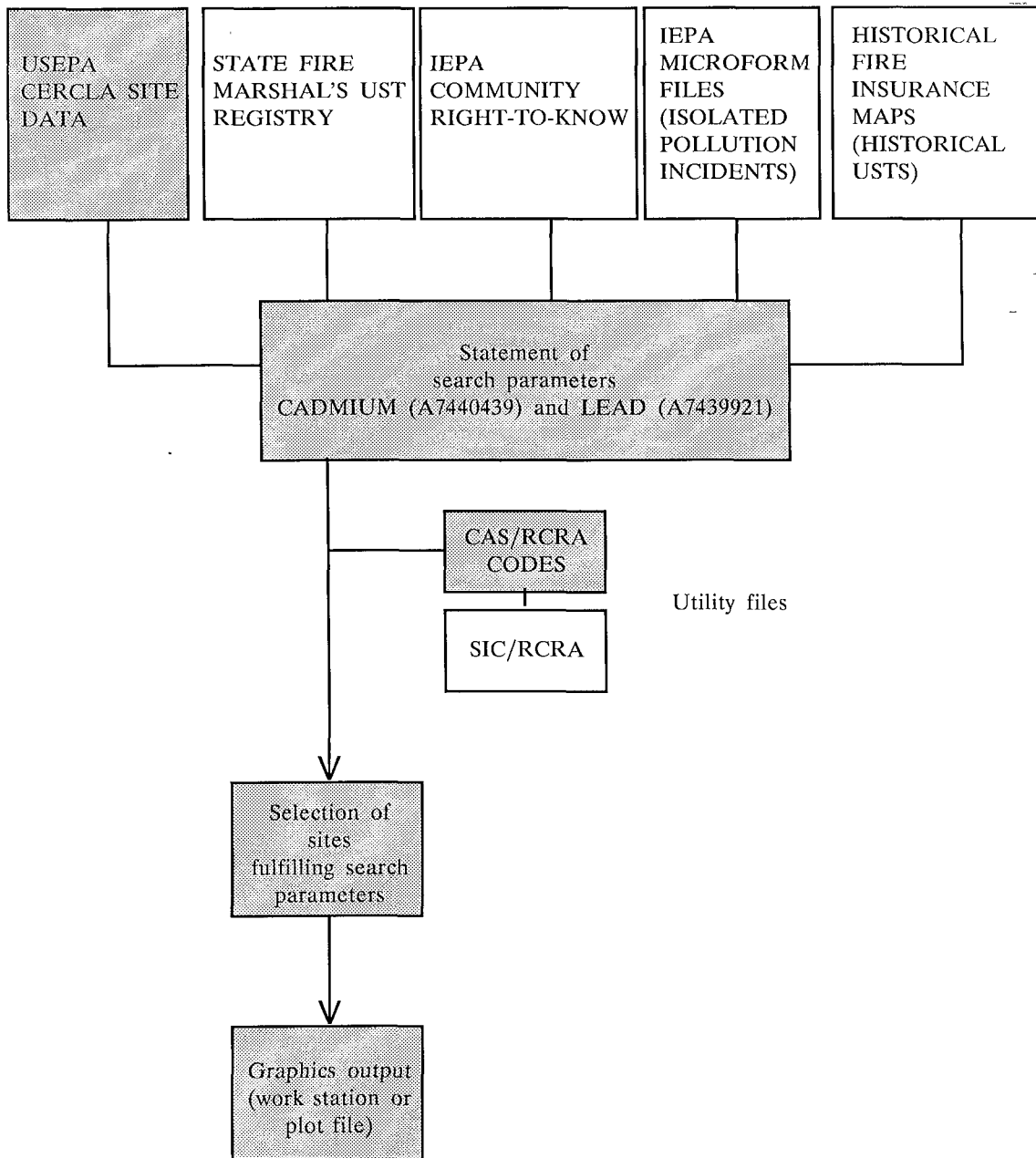

Figure 3.1. CADMIUM AND LEAD SEARCH PROCEDURE.

Calumet Data Base Study Area  
Search for Cadmium and Lead

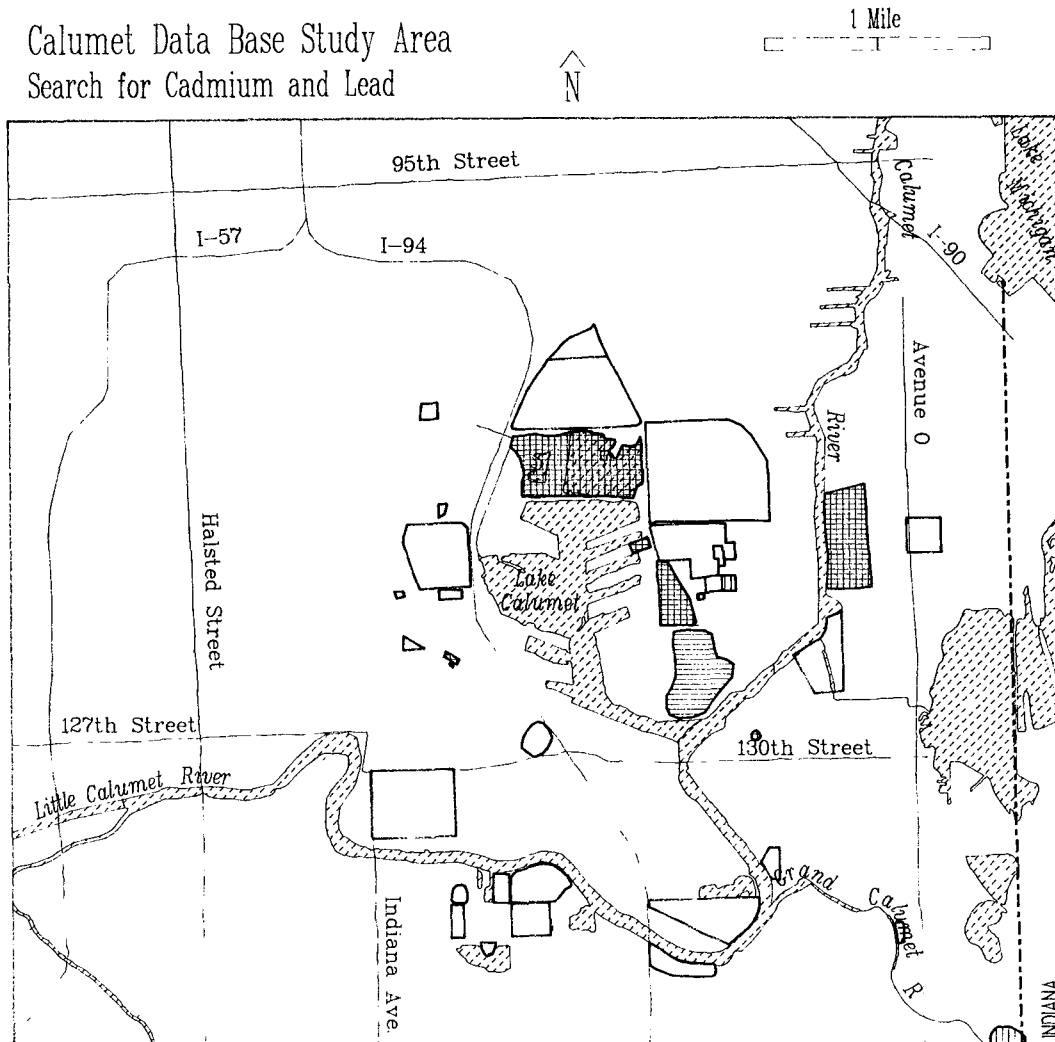

Figure 3.2. PLOT OF RESULTS OF SEARCH FOR CERCLA SITES CONTAINING CADMIUM AND LEAD. The horizontal shading denotes cadmium while the vertical shading denotes lead. The diagonal shading denotes open water features.



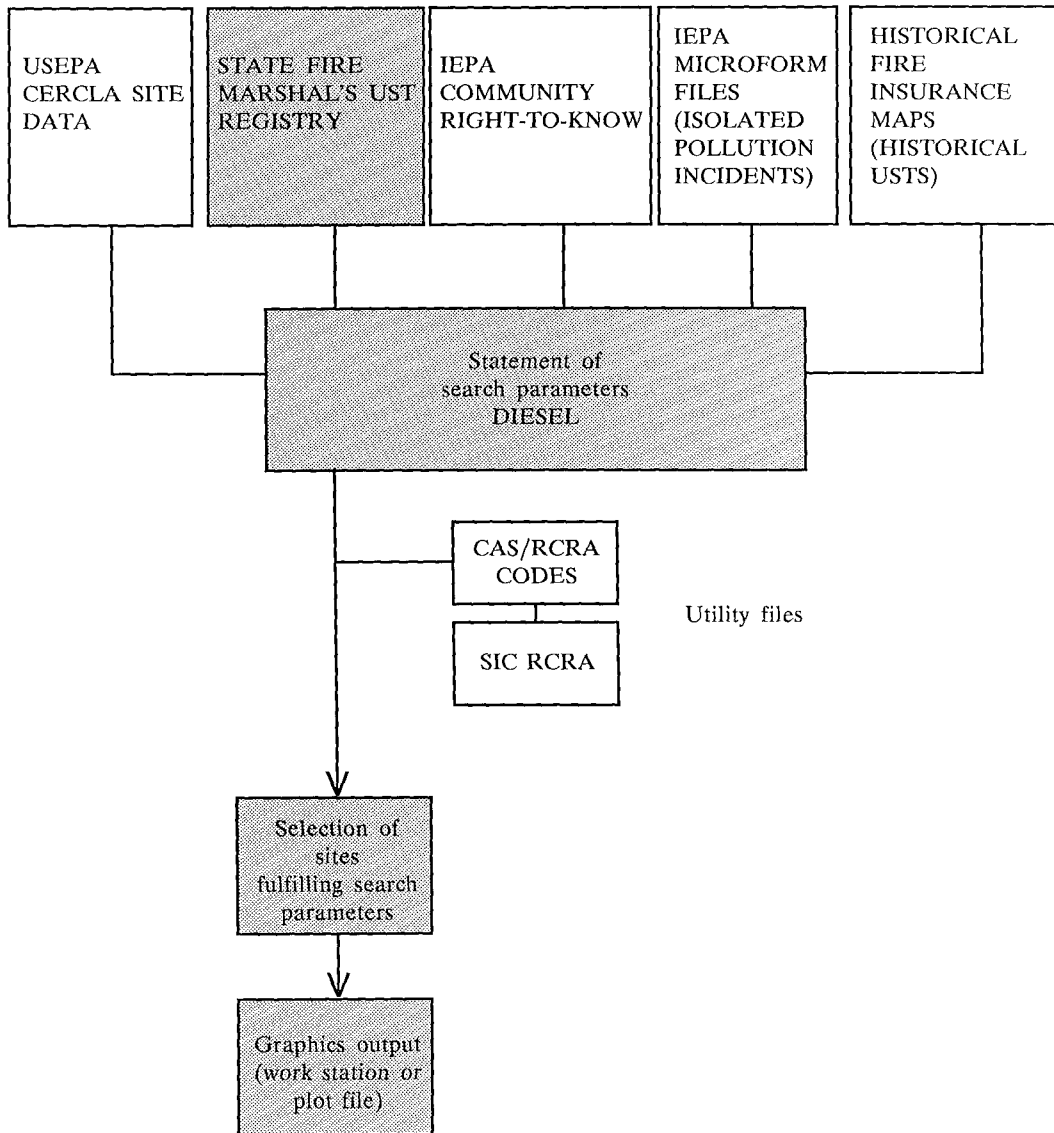

Figure 3.3. UNDERGROUND STORAGE TANKS CONTAINING DIESEL FUEL SEARCH PROCEDURE.

Calumet Data Base Study Area  
Search for USTs with Diesel Fuel

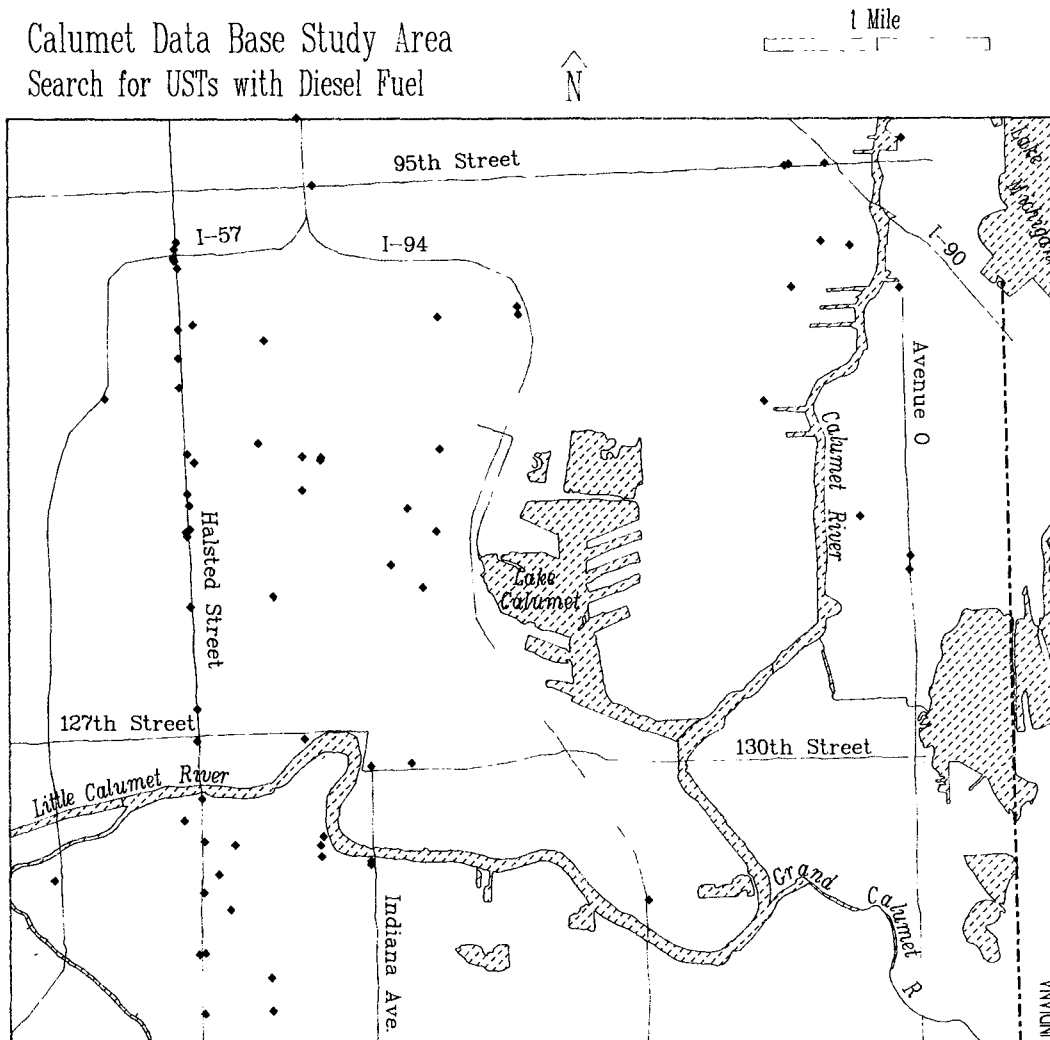

Figure 3.4. PLOT OF UNDERGROUND STORAGE TANKS CONTAINING DIESEL FUEL SEARCH. Diamonds indicate sites contained in data base. Diagonal shading denotes open water.

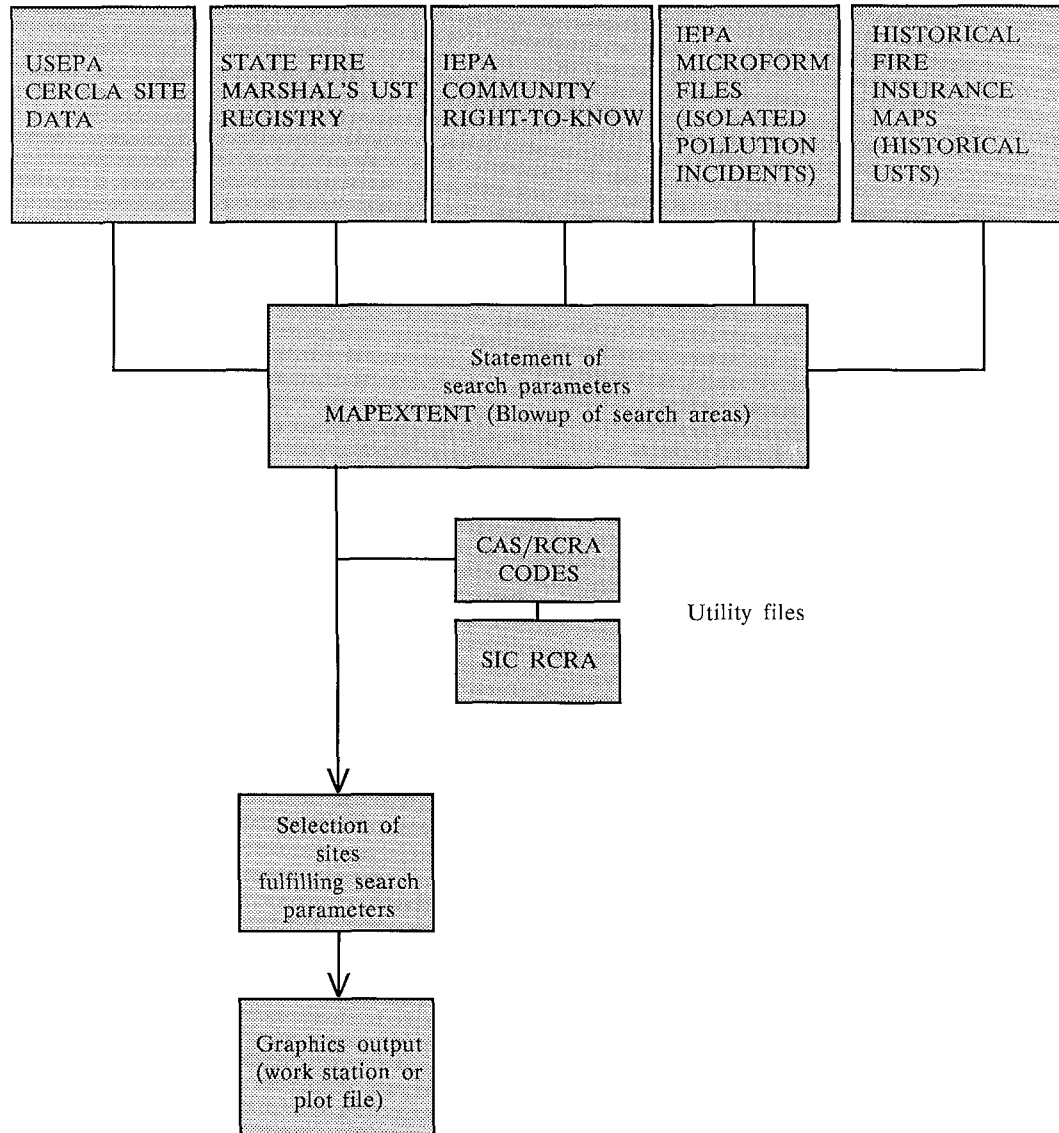

Figure 3.5. INTERACTIVE MAPEXTENT (\*) SEARCH PROCEDURE.

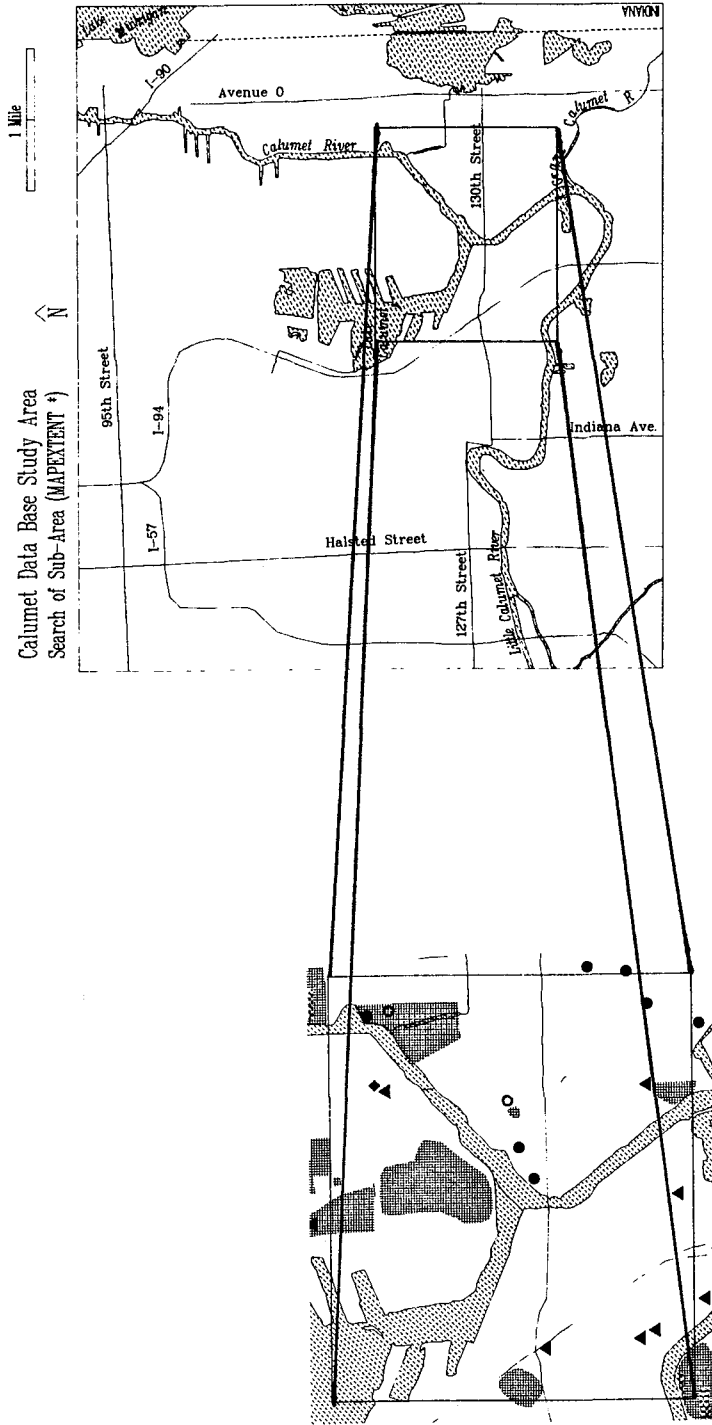

Figure 3.6. PLOT OF INTERACTIVE MAPEXENT(\*) SEARCH. The cross hatched areas in the blow-up map are CERCLA sites, the hollow circles are Community Right-to-Know sites, the solid circles are Sanborn map sites, the triangles are sites from IEPA microform files, and the diamonds are sites from the State Fire Marshal's UST registry. The diagonal shading denotes open water features.

**HAZARDOUS WASTE RESEARCH & INFORMATION CENTER**  
One East Hazelwood Drive  
Champaign, Illinois 61820  
(217)333-8940



---

**HWRIC RR-047**

# **The Calumet Area Hazardous Substance Data Base: A User's Guide with Documentation**

by

**Ted B. Samsel, Research Assistant**

**Craig E. Colten, Principal Investigator**

**Illinois State Museum  
Springfield, Illinois**

Reprinted February 1992



*Illinois Department of Energy and Natural Resources*

---